

myprojectorlamps.com

**The most trusted, dependable name
in projector lamp sales.**



<http://www.myprojectorlamps.com>



<http://www.myprojectorlamps.ca>



<http://www.myprojectorlamps.eu>

The following projector manual has not been modified or altered in any way.



OWNER'S OPERATING MANUAL



CL-510 / CL-510LT



THE WORLD'S FINEST HOME THEATER PRODUCTS™

Limited Warranty

Congratulations on your purchase of a Runco video product and welcome to the Runco family! We believe Runco produces “The World’s Finest Home Theater Products”. With proper installation, setup and care, you should enjoy many years of unparalleled video performance. Please read this consumer protection plan carefully and retain it with your other important documents.

This is a LIMITED WARRANTY as defined by the U.S. Consumer Product Warranty and Federal Trade Commission Improvement Act.

WHAT IS COVERED UNDER THE TERMS OF THIS WARRANTY:

SERVICE LABOR: Runco will pay for service labor by an approved Runco service center when needed as a result of manufacturing defect for a period of two (2) years from the effective date of delivery to the end user.

PARTS (Not including projector lamp): Runco will provide new or rebuilt replacement parts for the parts that fail due to defects in materials or workmanship for a period of two (2) years from the effective date of delivery to the end user. Such replacement parts are then subsequently warranted for the remaining portion (if any) of the original warranty period.

LAMP: Six months from the effective date of delivery to the end user.

WHAT IS NOT COVERED UNDER THE TERMS OF THIS WARRANTY:

This warranty only covers failure due to defects in materials and workmanship that occur during normal use and does not cover normal maintenance. This warranty does not cover cabinets or any appearance item; failure resulting from accident, misuse, abuse, neglect, mishandling, misapplication, faulty or improper installation or setup adjustments; improper maintenance, alteration, improper use of any input signal; damage due to lightning or power line surges, spikes and brownouts; damage that occurs during shipping or transit; or damage that is attributed to acts of God. In the case of remote control units, damage resulting from leaking, old, damaged or improper batteries is also excluded from coverage under this warranty.

CAUTION: DAMAGE RESULTING DIRECTLY OR INDIRECTLY FROM IMPROPER INSTALLATION OR SETUP IS SPECIFICALLY EXCLUDED FROM COVERAGE UNDER THIS WARRANTY. IT IS IMPERATIVE THAT INSTALLATION AND SETUP WORK BE PERFORMED ONLY BY AN AUTHORIZED RUNCO DEALER TO PROTECT YOUR RIGHTS UNDER THIS WARRANTY. THIS WILL ALSO ENSURE THAT YOU ENJOY THE FINE PERFORMANCE YOUR RUNCO PRODUCT IS CAPABLE OF PROVIDING WHEN INSTALLED AND CALIBRATED BY RUNCO AUTHORIZED PERSONNEL.

RIGHTS, LIMITS AND EXCLUSIONS:

Runco limits its obligations under any implied warranties under state laws to a period not to exceed the warranty period. There are no express warranties. Runco also excludes any obligation on its part for incidental or consequential damages related to the failure of this product to function properly. Some states do not allow limitations on how long an implied warranty lasts, and some states do not allow the exclusion or limitation of incidental or consequential damages. So the above limitations or exclusions may not apply to you. This warranty gives you specific legal rights, and you may also have other rights that vary from state to state.

EFFECTIVE WARRANTY DATE:

This warranty begins on the effective date of delivery to the end user.

For your convenience, keep the original bill of sale as evidence of the purchase date.

IMPORTANT: WARRANTY REGISTRATION:

Please fill out and mail your warranty registration card. It is imperative that Runco knows how to reach you promptly if we should discover a safety problem or product update for which you must be notified.

TO OBTAIN SERVICE, CONTACT YOUR RUNCO DEALER:

Repairs made under the terms of the Limited Warranty covering your Runco International video product will be performed at the location of the product, during usual working hours, providing location of product is within normal operating distance from a Runco Authorized Service Center. If, solely in Runco's judgement, location of product to be repaired is beyond normal operating distance of the closest Runco Authorized Service Center, it is the owner's responsibility to arrange for shipment of the product for repair. These arrangements must be made through the selling Runco dealer. If this is not possible, contact Runco directly for a return authorization number and shipping instructions. Runco will return product transportation prepaid in the United States, unless no product defect is discovered. In that instance, shipping costs will be the responsibility of the owner.

ADDITIONAL INFORMATION:

To locate the name and address of the nearest Runco Authorized Service location, or for additional information about this warranty, please call, write or visit our website:

CUSTOMER SERVICE DEPARTMENT
RUNCO INTERNATIONAL
2900 Faber Street
Union City, CA 94587
Ph: (510) 324-7777 / Fax: (510) 324-9300
www.runco.com

Runco CL-510/ CL-510LT Video Projector

User's Manual

Thank you for your purchase of this quality Runco video projector! It has been designed to provide you with the quality of video that is expected in a home theater. For the best performance, please read this manual carefully as it is your guide through the menus and operation.

WARNING

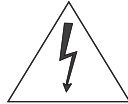
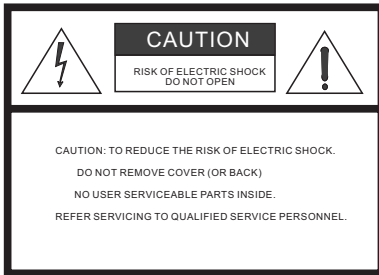

This symbol is intended to alert the user to the presence of uninsulated " dangerous voltage " within the product's enclosure that may be of sufficient magnitude to constitute a risk of electric shock.



This symbol is intended to alert the user to the presence of important operating and maintenance (servicing) instructions in the literature accompanying the appliance.

This equipment has been tested and found to comply with the limits for a Class B digital device, pursuant to Part 15 of the FCC Rules. These limits are designed to provide reasonable protection against harmful interference in a residential installation.

1. Read these instructions.
2. Keep these instructions.
3. Heed all warnings.
4. Do not use this projector near water, outdoors or otherwise exposed to the elements.
5. Clean only with a dry cloth.
6. Do not block any ventilation openings.
7. Do not install near any heat sources such as radiators, heat registers, stoves, or other apparatus (including amplifiers) that produce heat.
8. Do not defeat the safety feature of the polarized or grounding type plug. A polarized type plug has two blades with one wider than the other. A grounding type plug has two blades and a third grounding prong. The third prong is provided for your safety. If the provided plug does not fit into your outlet, consult an electrician for the replacement of the obsolete outlet.
9. Do not connect the RJ-11 RS-232 jack to a telephone line connection.
10. The 12V trigger outputs 12V DC for triggering. Do not connect to any other power input or output. This could cause damage to this unit.
11. Only use accessories specified by RUNCO International.
12. Keep the packing material in case the projector should ever need to be shipped.
13. Unplug this projector during lightning storms or when it will not be used for an extended period of time.
14. The lamp becomes extremely hot during operation. Allow the projector to cool down for approximately 45 minutes prior to removing the lamp assembly for replacement. Do not operate lamps beyond the rated lamp life. Excessive operation of lamps beyond rated life could cause them to explode in rare occasions.
15. Refer all servicing to qualified service personnel. Servicing is required when the projector has been damaged in any way, objects have fallen or spilled into the projector, the projector has been exposed to rain or moisture, does not operate normally, or has been dropped.

Table of Contents

- WARNING** 1
- 1. Overview** 3
 - Features 3
 - Projector Exterior View 4
 - Front / Upper Side 4
 - Rear / Bottom Side 4
 - Controls and Functions 5
 - Control Panel 5
 - Connector Panel 6
 - Remote Control 7
- 2. Installation** 9
 - Remote Control 9
 - Projector 9
 - Connect the Power Cord 9
 - Adjust the Lens Zoom/Focus ring 10
 - Adjust the height 10
 - Installation For CL-510 (With 1.75 - 2.00 Lens) 11
 - Throw Distance Chart For CL-510 (With 1.75 - 2.00 Lens) 12
 - Installation For CL-510LT (With 2.30 - 3.00 Lens) 13
 - Throw Distance Chart For CL-510LT (With 2.30 - 3.00 Lens) 14
- 3. Connecting** 15
 - Connecting Video Inputs 15
 - Video / S-Video / Component (Interlaced Video) 15
 - Progressive Component (DTV Y/PB/PR) 16
 - RGBHV (DTV RGB) 16
 - Connecting a Computer (DVI/ HDCP) 17
- 4. Basic Operation** 18
 - Turning on the Power 18
 - Zoom/ Focusing 18
 - Selecting Video Memory 18
 - Selecting "ASPECT RATIO" 19
 - Direct Picture Adjust (Menu Bypass) 19
 - Setting Menu 19
 - Selecting Input Source 20
 - PIP/ PBP function 20
 - Turning off the Power 21
- 5. Menu** 22
 - Using the Menu 22
 - Main Menu 22
 - Picture Quality Adjustments 23
 - Aspect Ratio 23
 - Options 24
 - Setup 25
- 6. Additional Information** 27
 - Warning Message 27
 - Replace the Lamp (Contact your Runco Dealer) 27
 - Troubleshooting 28
 - Specifications 29
 - Dimensions 31
 - RS-232 Setup 32

I. Overview

Features

- **Runco Engineered, Gen 3 Technology.**

- **Native 16x9 Aspect Ratio DMD™**

12 degree mirrors with dark metal process

- **High Contrast and Picture Quality**

9 point white balancing system

- **Dynamic Performance and Rich Gray-scale**

6-segment 5x color wheel and precision gray scale tracking

- **TIR (Total Internal Reflection) Prism**

Light engine with custom optics featuring an elliptical aperture for highest performance.

- **Wide Variety of Inputs**

This unit can support various video formats, including Composite, S-Video, Component, DTV Y/P_B/P_R, DTV RGB and Computer signals. The HDTV input (DTV Y/P_B/P_R and DTV RGB) is input through RGB BNC connectors, providing the least amount of signal degradation caused by longer cable runs.

- **HDTV Ready**

480P, 1080i and 720P (576P PAL Version) formats are all compatible with this unit (via an external DTV decoder, not provided).

- **De-interlacing with 3:2 Pull-down**

Using Runco's proprietary De-interlacing technology, this projector provides exceptional scaling and film to video (3:2 pulldown) conversion for the most artifact-free images possible.

- **PIP/ PBP function**

Picture in picture/ Picture by picture functions allow you to display two inputs on the screen at the same time.

- **Video Memory**

This projector allows the user to store up to three different settings per input.

Projector Exterior View

■ Front / Upper Side

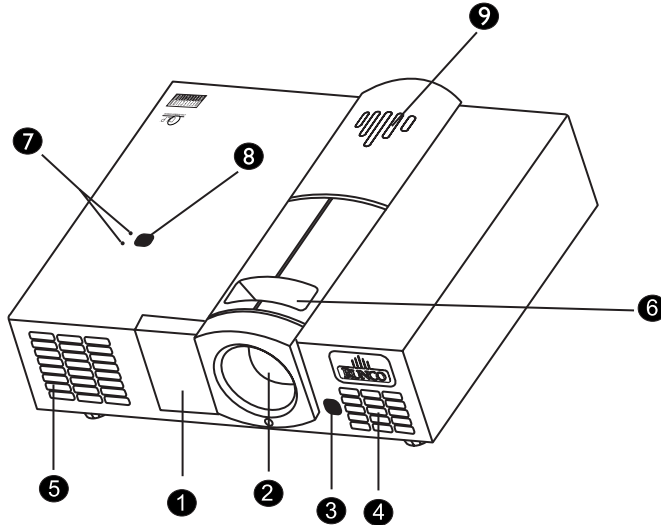

- | | |
|--|---|
| <p>1. Front Lamp Cover
Remove this cover when replacing the lamp. (See page 27.)</p> <p>2. Projection Lens</p> <p>3. Front IR Sensor</p> <p>4. Ventilation Holes (intake)</p> <p>5. Ventilation Holes (exhaust)</p> | <p>6. Focus Ring and Zoom Ring Access
Adjusts the focus and zoom of image.</p> <p>7. Power LED and Lamp LED
Show the status of power and lamp.
For more details, see "Control Panel" on page 5.</p> <p>8. Top IR Sensor</p> <p>9. Runco Logo (Can be turned off, see "Options" on page 24.)</p> |
|--|---|

■ Rear / Bottom Side

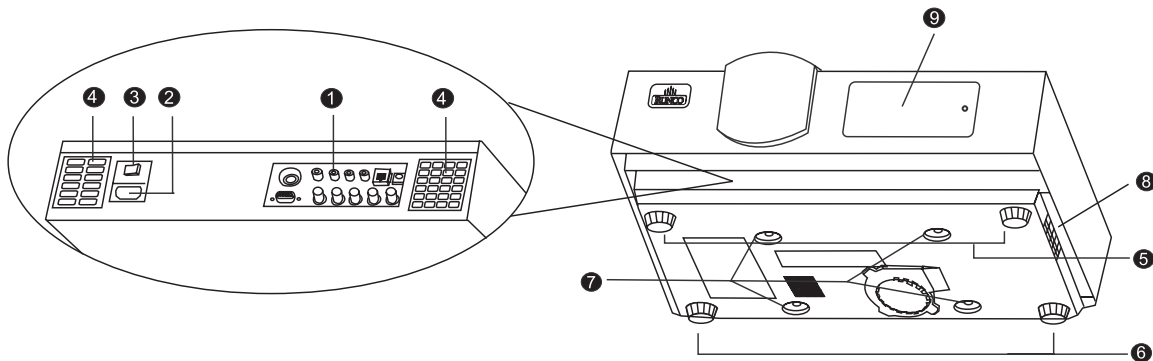

- | | |
|---|--|
| <p>1. Connector Panel
For more details, see "Connector Panel" on page 6.</p> <p>2. AC Power IN Socket</p> <p>3. AC Power Switch
AC main power switch</p> <p>4. Ventilation Holes (intake)</p> <p>5. Rear Adjusters
Adjust the height or projection angle</p> | <p>6. Front Adjusters
Adjust the height or projection angle</p> <p>7. Ceiling Mount Holes
The connecting holes for ceiling mounting device.</p> <p>8. Ventilation Holes (exhaust)</p> <p>9. Cable Access Cover</p> |
|---|--|

Controls and Functions

I Control Panel

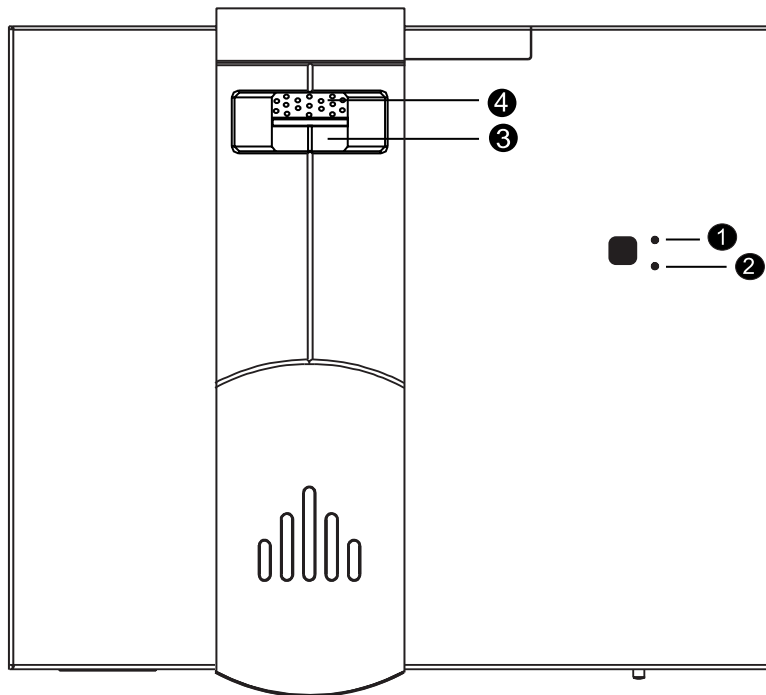

1. POWER LED

Indicate power status

- Orange when the AC power cord is plugged into the wall outlet (standby mode). Once in the standby mode, you can turn on the projector by pressing the ON key on the remote control for ONE second.
- Green when the power is turned on (operational mode).
- Flashing Orange for the first 45 seconds after power-up indicating that the lamp is warming up.
- Flashing Green for 90 seconds after the projector is powered off indicating that the lamp is cooling down.

2. LAMP LED

Indicates the status of lamp

- Red when the lamp has developed a problem. Please contact your Runco Dealer for assistance.

3. ZOOM RING

Adjust the size of the image

- Rotate right to enlarge the image, and rotate left to make the image smaller.

4. FOCUS RING

Adjust the focus of the image

- Rotate the focus ring right or left to focus the image.

■ Connector Panel

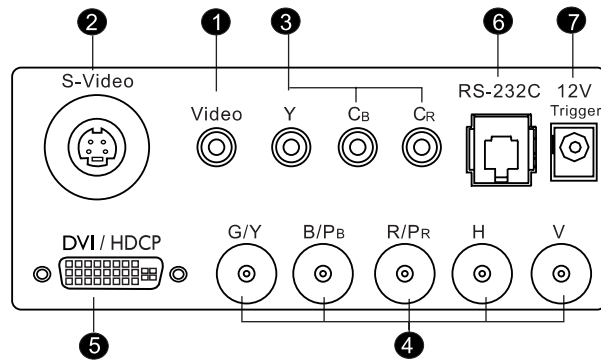

- 1. Video (RCA Jack)**
Composite video signal input.
- 2. S-Video (mini DIN 4-pin)**
Y/C (S-video) signal input
- 3. Component (RCA Jacks)**
480i Component (Y/Cb/CR) video signal input
- 4. RGB/ HDTV (BNC) or Progressive Scan DVD players**
DTV Y/Pb/Pr or DTV RGB video signal input.
- 5. DVI/ HDCP**
Digital/ Analog signal input.
- 6. RS-232C (RJ-11 Jack)**
RS-232C control signal input.
- 7. 12v Trigger (mini jack with the diameter of 5.5 mm outside and 2.5 mm inside)**
+12V output, active when the projector is turned on.

Remote Control

Anamorphic
For 16:9 DVDs.

4 X 3

The input signal will be scaled to fit 4:3 display mode in the center of screen.

LPos+, LPos-
Letterbox position

Letterbox

Letterbox mode. Image in letterbox format is enlarged to fit 16:9 full screen display and the upper/lower portion are "blanked off".

VirtualWide

4:3 image is enlarged nonlinearly in horizontal direction to fit 16:9 full screen display.

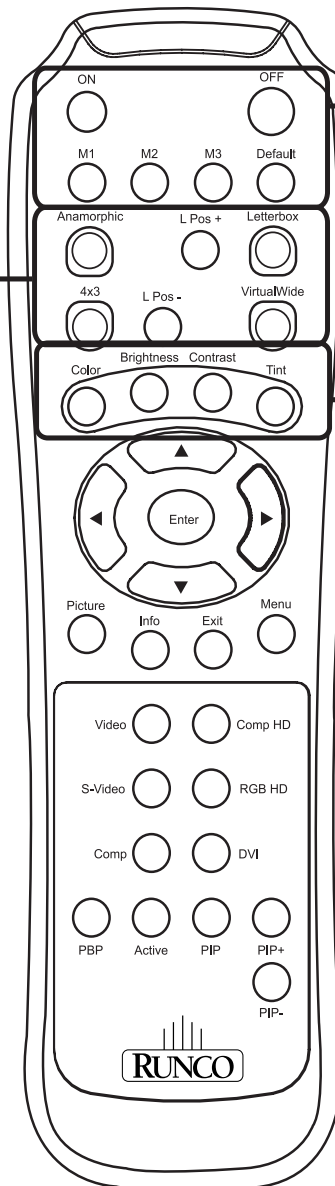

ON
Hold down this button for ONE second to turn on the unit.

OFF
Press this button to turn off the unit.

M1, M2, M3, Default
Recall video memory sequentially (see "Selecting Video Memory" or page 18)

Color
Adjust color intensity

Brightness
Adjust picture brightness

Contrast
Adjust picture contrast

Tint
Adjust color tones

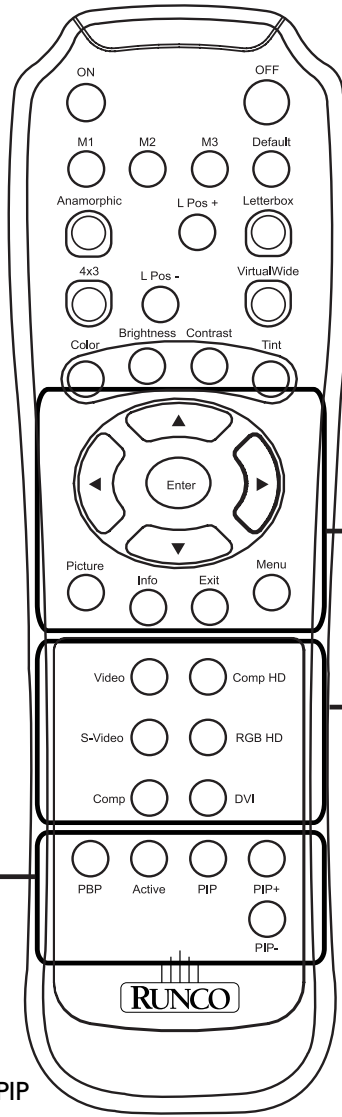

Arrow (▲,◀,▼,▶)
Use to select the menu or to make various adjustments.

Enter
Enter the setting of items in the menu.

Picture
Access the Picture Setting menu (see "Picture Quality Adjustments" on page 23)

Info
Access the projector information

Exit
Exit and save the setting(s) of items in the menu.

Menu
Turns on/off the on-screen display menu.

PBP (Picture by Picture)
Enable the PIP function.

ACTIVE
Switch to the active window in PIP display mode.

PIP (Picture in Picture)
Enable the PIP function. Use ARROW keys to adjust the position of the PIP window (see "PIP/ PBP function" on page 20)

PIP+
Enlarge the size of PIP window.

PIP-
Shrink the size of PIP window.

Video
Composite video signal input

S-Video
S-Video signal input

Comp
Component Y/Cb/Cr input

Comp HD
DTV Y/Pb/Pr signal input

RGB HD
DTV RGBHV signal input

DVI
Digital/ Analog signal input

2. Installation

Remote Control

Push forward on the tap and lift to open the cover. Install the two AAA batteries with the correct polarity, then close the cover.

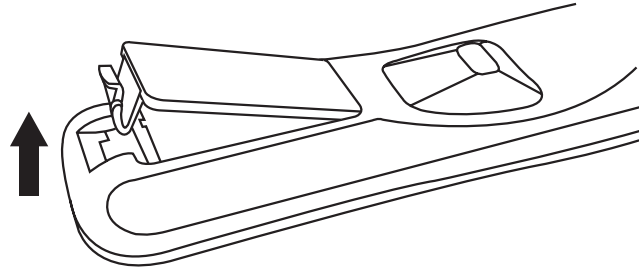

Notes on Batteries

- Make sure that the battery polarities are correct when installing the batteries.
- Do not mix an old battery with a new one or different types of batteries.
- If you will not use the remote control for a long time, remove the batteries to avoid damage from battery leakage.

Notes on Remote Control Operation

- Make sure that there is nothing obstructing the infrared beam between the remote control and the IR receiver on the projector.
- The useable range is between 3m/ 9.8 feet (from the front of the projector) and 4m/ 13.1 feet (from the top of the projector) within a 30 degree horizontal angle and 15 degree vertical angle.

Projector

■ Connect the Power Cord

Plug the supplied power cord into the AC inlet in the rear of this unit. (AC 100V ~ 240V)

Turn on the main power switch on the rear of this unit (next to the AC inlet). The POWER LED will light up in orange. Press ON key on the remote control for ONE second to turn on the unit.

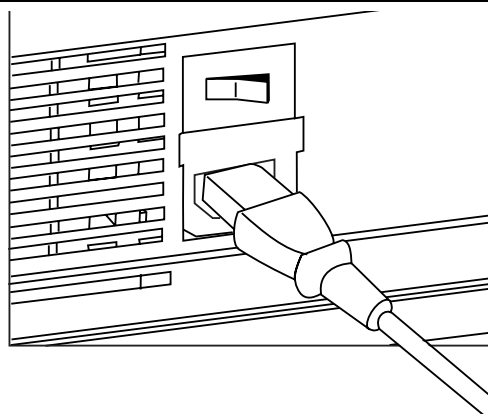

■ Adjust the Lens Zoom/Focus ring

Adjust the projected image size you need with the zoom ring on the lens. To focus the image, rotate the focus ring on the lens.

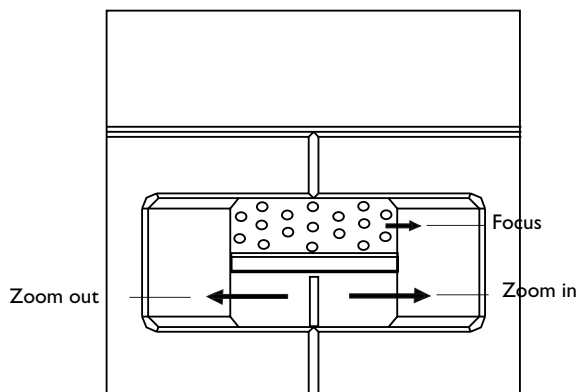

■ Adjust the height

There are 4 screw adjusters on the bottom of this unit. You can adjust the height or projection angle of this unit by using these adjusters.

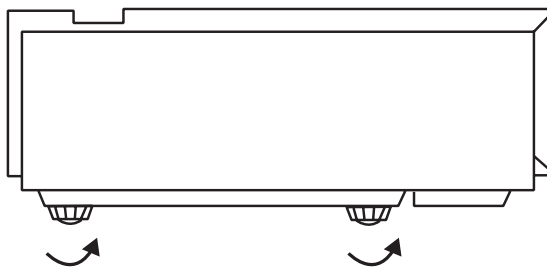

Installation For CL-510 (With 1.75 - 2.00 Lens)

Ceiling

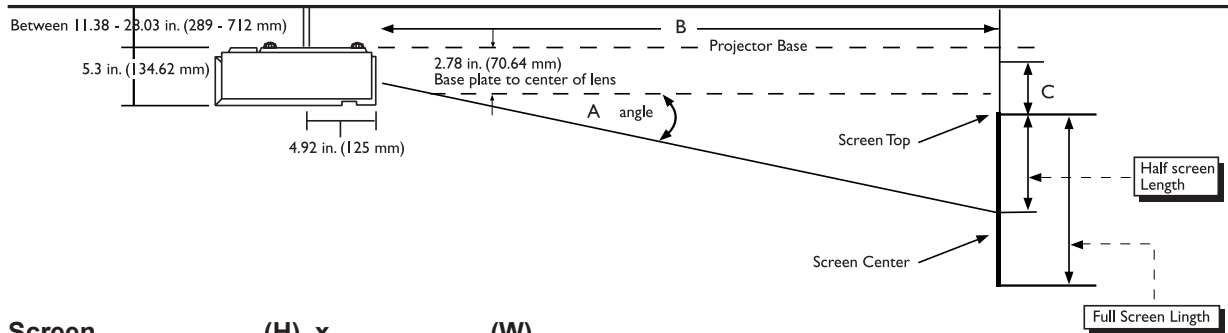

Screen _____ (H) x _____ (W)

B) THROW DISTANCE:

CL-510 16 x 9 Screens:

Minimum: (screen width x 1.75) = _____ inches

Maximum: (screen width x 2.00) = _____ inches

C) VERTICAL OFFSET:

Screen width x 0.12 = _____ inches from the center of the lens.

Floor

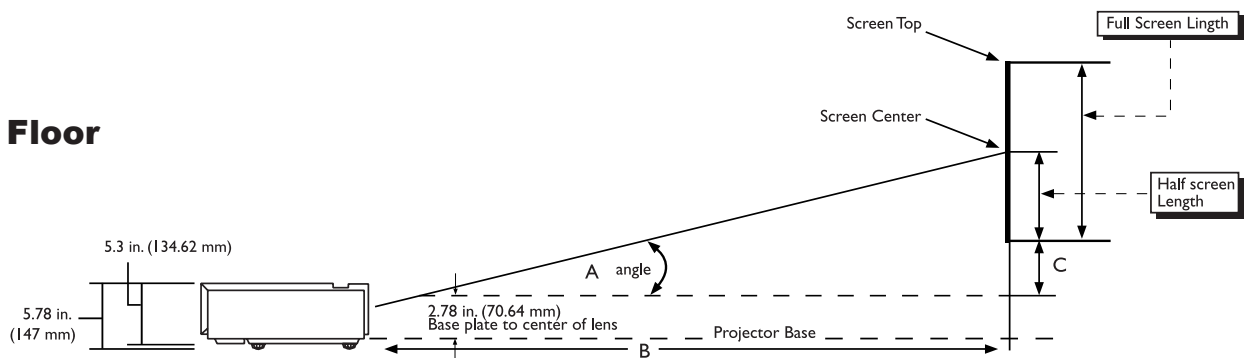

Throw Distance Chart For CL-510 (With 1.75 - 2.00 Lens)

CL-510 @ 1024 x 576

Screen Height	Screen Width	Min Throw Distance	Max Throw Distance	Vertical Offset Position
40.5	72	126.00	144.00	8.64
43	77	134.75	154.00	9.24
45	80	140.00	160.00	9.60
47	84	146.41	167.32	10.04
49	87	152.25	174.00	10.44
50	89	155.75	178.00	10.68
51.5	92	161.00	184.00	11.04
52	93	162.75	186.00	11.16
54	96	168.00	192.00	11.52
56	100	175.00	200.00	12.00
58	103	180.25	206.00	12.36
58.5	104	182.00	208.00	12.48
60	107	187.25	214.00	12.84
61	109	190.75	218.00	13.08
63	112	196.00	224.00	13.44
65	116	203.00	232.00	13.92
67.5	120	210.00	240.00	14.40
72	128	224.00	256.00	15.36
80	142	248.50	284.00	17.04
82	146	255.50	292.00	17.52
90	160	280.00	320.00	19.20
Screen Hight	Screen Width	Min TD	Max TD	Vertical Offset
		(SWx1.75)	(SWx2.00)	Screen Width x 0.12

Installation For CL-510LT (With 2.30 - 3.00 Lens)

Ceiling

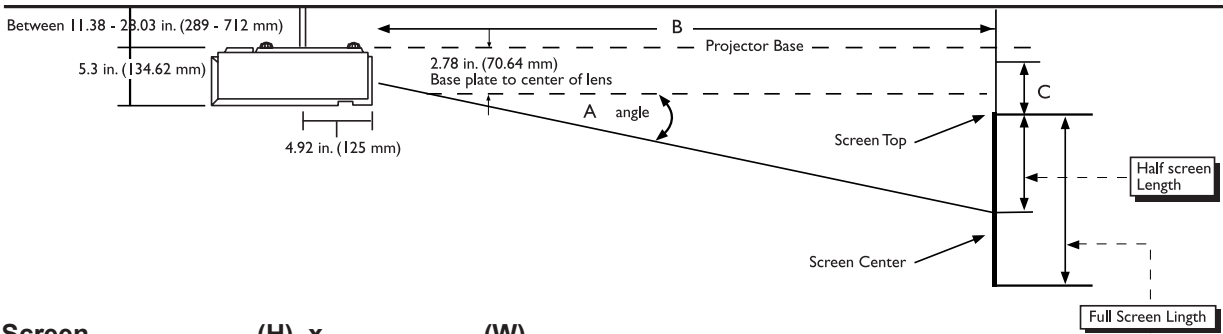

Screen _____ (H) x _____ (W)

B) THROW DISTANCE:

CL-510LT 16 x 9 Screens:

Minimum: (screen width x 2.30) = _____ inches

Maximum: (screen width x 3.00) = _____ inches

C) VERTICAL OFFSET:

Screen width x 0.10 = _____ inches from the center of the lens.

Floor

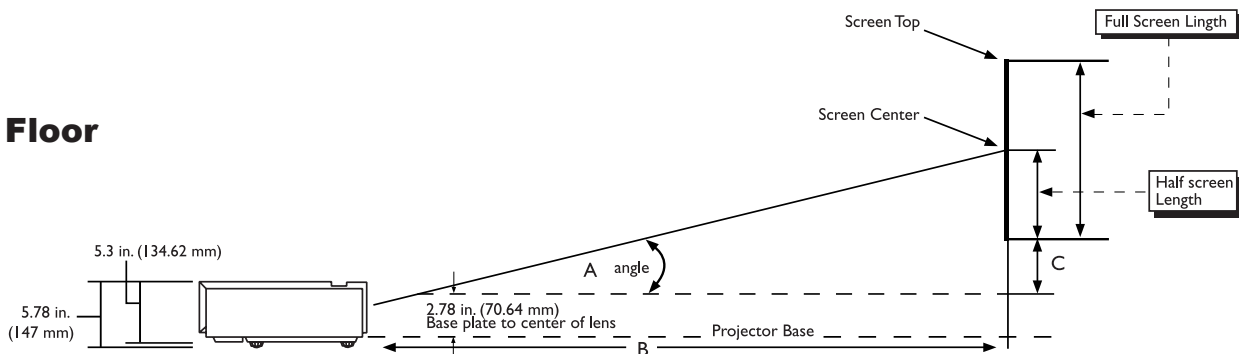

Throw Distance Chart For CL-510LT (With 2.30 - 3.00 Lens)

CL-510LT @ 1280 x 720

Screen Height	Screen Width	Min Throw Distance	Max Throw Distance	Vertical Offset Position
40.5	72	165.60	216.00	7.20
43	77	177.10	231.00	7.70
45	80	184.00	240.00	8.00
47	84	192.24	250.98	8.37
49	87	200.10	261.00	8.70
50	89	204.70	267.00	8.90
51.5	92	211.60	276.00	9.20
52	93	213.90	279.00	9.30
54	96	220.80	288.00	9.60
56	100	230.00	300.00	10.00
58	103	236.90	309.00	10.30
58.5	104	239.20	312.00	10.40
60	107	246.10	321.00	10.70
61	109	250.70	327.00	10.90
63	112	257.60	336.00	11.20
65	116	266.80	348.00	11.60
67.5	120	276.00	360.00	12.00
72	128	294.40	384.00	12.80
80	142	326.60	426.00	14.20
82	146	335.80	438.00	14.60
90	160	368.00	480.00	16.00
Screen Hight	Screen Width	Min TD	Max TD	Vertical Offset
		(SWx2.30)	(SWx3.00)	SWx0.10

3. Connecting

When connecting, make sure to:

1. Turn off all equipment before making any connections.
2. Use the correct signal cables for each source.
3. Ensure the cables are firmly connected.
4. Connect all audio signals to external speakers. This projector is not equipped with speakers.

Connecting Video Inputs

■ Video / S-Video / Component (Interlaced Video)

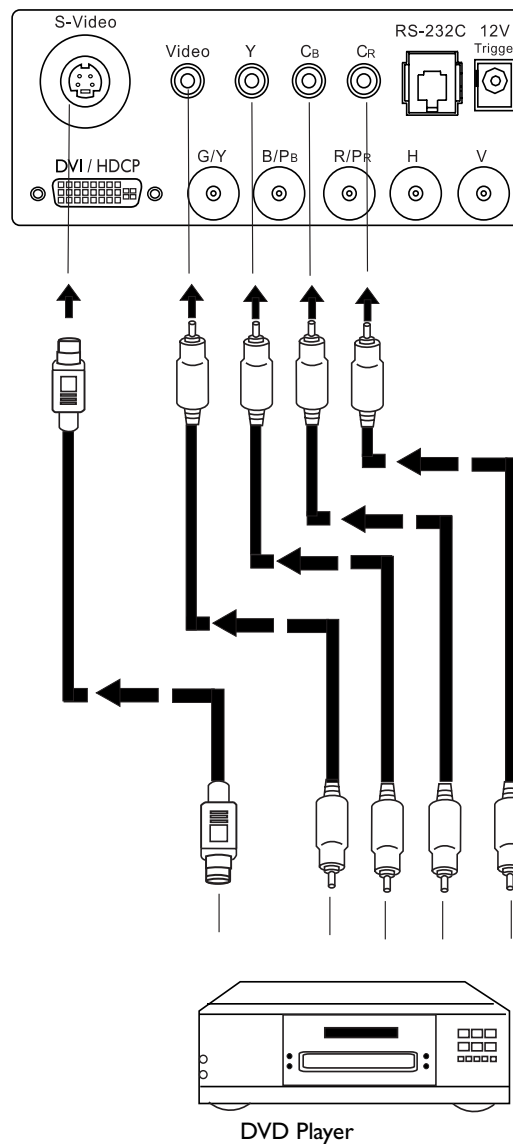

■ Progressive Component (DTV Y/Pb/Pr)

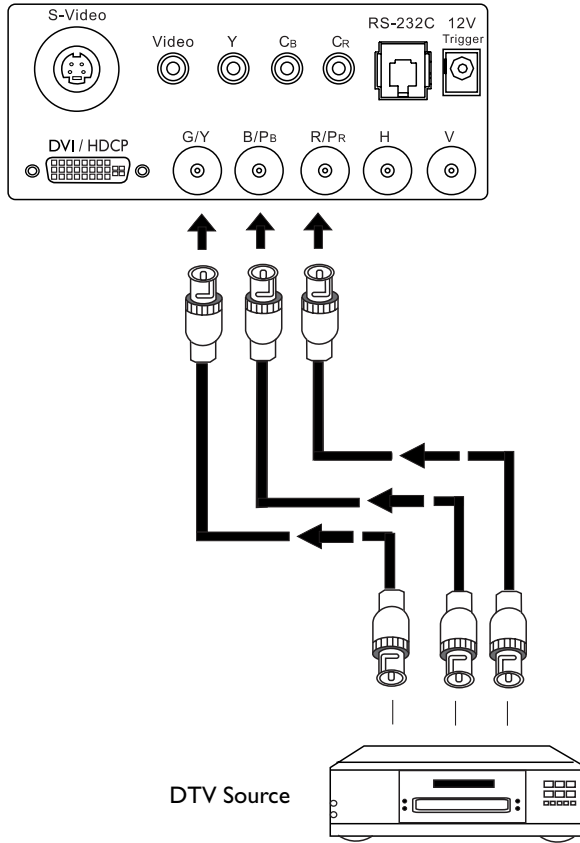

■ RGBHV (DTV RGB)

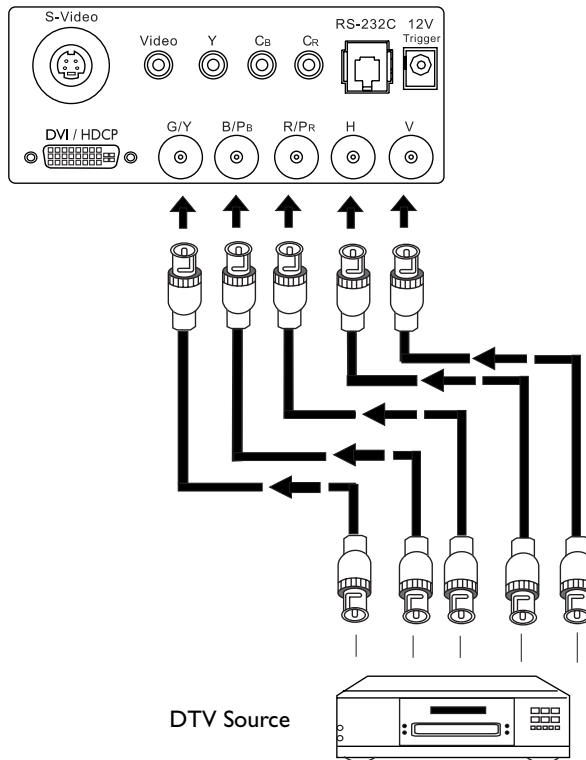

The RGB BNC input supports two kinds of HDTV formats: Progressive component (DTV Y/Pb/Pr) and DTV RGB. The unit will detect the resolution automatically.

Connecting a Computer (DVI/ HDCP)

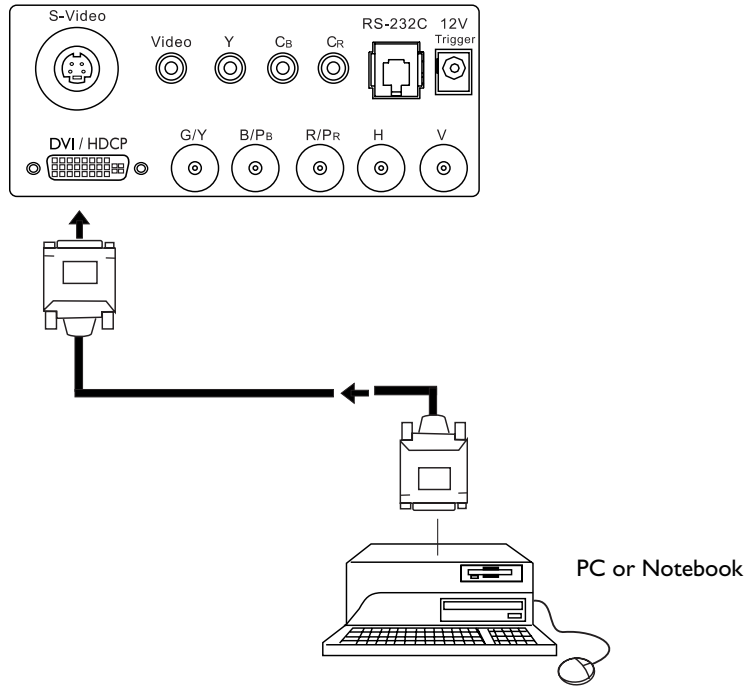

This unit is compatible with the following computer resolutions: 1280x720, 1024x768, 800x600, 640x480.

4. Basic Operation

Turning on the Power

- The Power LED lights orange when power is applied and the power switch is turned on.
- Press and hold the **ON** key on the remote control for ONE second to turn on the unit. The POWER LED will blink orange during warm up period, then light solid green.
- " Searching..." will be displayed on the screen before the projector identifies the input signal. This message will remain on the screen until a valid signal is detected.
- If an incompatible input signal exceeds the range of the projector a "Not supportive timing" message will be displayed on the screen. This message will remain on the screen until you change the input signal.

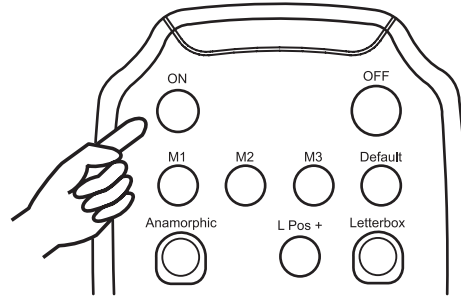

Zoom/ Focusing

- Adjust the projection image size you need with the zoom ring on the lens. To focus the image, rotate the focus ring on the lens.

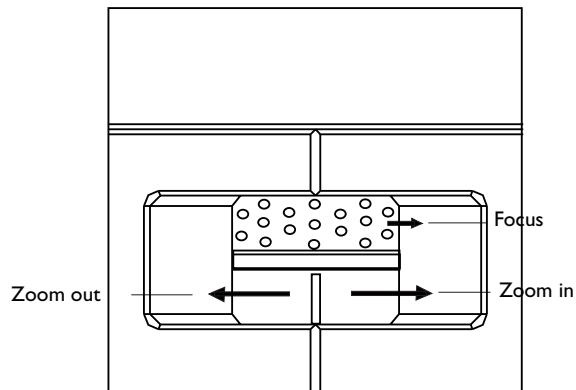

Selecting Video Memory

- Press **M1**, **M2**, **M3** buttons to recall settings in the memory.
- Press **Default** to select the default setting.

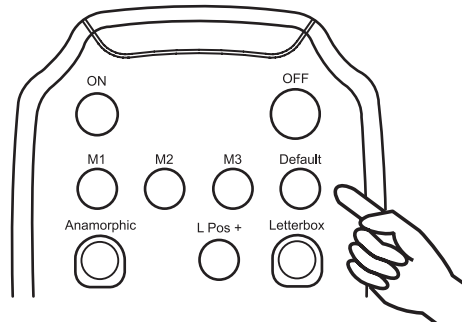

Selecting "ASPECT RATIO"

- Select the proper aspect ratio according to the content being used. There are four aspect ratios:
 - **Anamorphic**: 4:3 image is stretched horizontally to fit a 16:9 screen. This is for 16:9 DVDs.
 - **4 X 3**: The input signal will be scaled to fit 4 : 3 display mode in the center screen.
 - **Letterbox**: Image in letterbox format is enlarged to fit 16:9 full screen display and the upper/lower portion are cropped.
 - **VirtualWide**: This transforms a 4x3 image to a 16x9 image.
- **LPos+**, **LPos-**: Adjust Letterbox image vertical position.

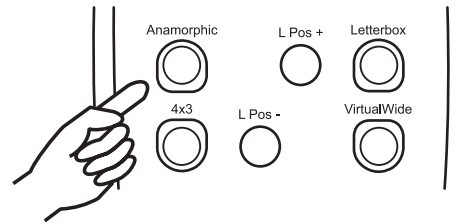

Direct Picture Adjust (Menu Bypass)

- Press **Color** to adjust color intensity.
- Press **Brightness** to adjust picture brightness.
- Press **Contrast** to adjust picture contrast.
- Press **Tint** to adjust color tones.

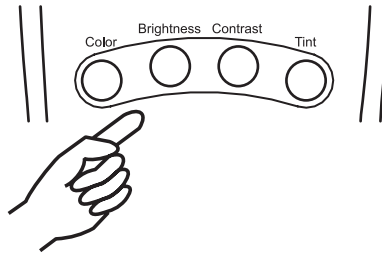

Setting Menu

- Press the **Menu** button to turn on /off the on-screen menu.
- Use the **ARROW** buttons (▲,◀,▼,▶) to select the menu or to make various adjustments.
- Press the **Enter** or ▶ button to enter the setting of items in the menu, or press the **Exit** button to leave and save the setting of items in the menu.
- For more detailed settings, see Chapter 5 Menu on page 22.
- Press **Picture** to access the picture setting menu.
- Press **Info** to access projector information.

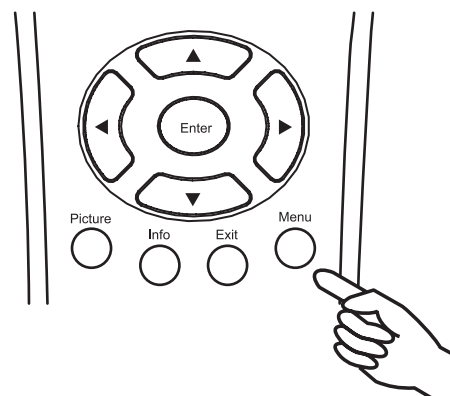

Selecting Input Source

- When this unit is turned on, it will search for the input source you last selected.
- You may select the input source directly on the remote control.

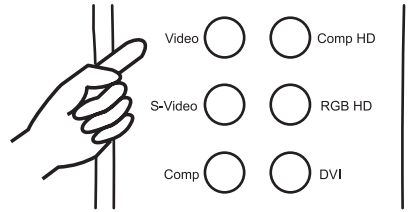

PIP/ PBP function

- Press the **PIP** button to enable the PIP function
- For PIP purposes, there are two groups of inputs separated by their display modes:
Video Group: Video, S-Video and Component Y/CB/Cr inputs
Graphic Group: HDTV input and Computer input.
- The PIP can show one input from the Graphic Group within one input from the Video Group, or show one input from Video Group within one input from the Graphic Group.
- Press the **PIP** button to switch to the main window or turn off PIP function.
- Select the input source of the main window by pressing the INPUT button.
- Press the **ACTIVE** button to switch to the active window. You can change the input signal setting in the active window.
- Press **PIP+** or **PIP-** to adjust the size of PIP window.
- Adjust the position of the PIP window with the ARROW keys (▲, ◀, ▼, ▶).
- Press **PBP** to enable the PBP function.

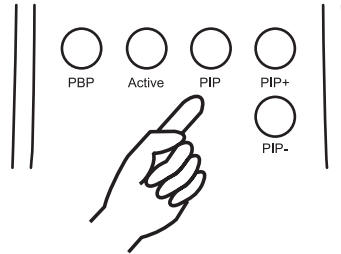

Turning off the Power

- Press the **OFF** key on the remote control to turn off the unit.
- The POWER LED will blink green and the fans will speed up for a quick cool down. The projector will not respond to any command for 90 seconds.
- The POWER LED will light solid orange once the cooling down cycle has completed.
- Fans will run for three minutes to cool.
- You may turn the projector back on after the first 90 seconds.

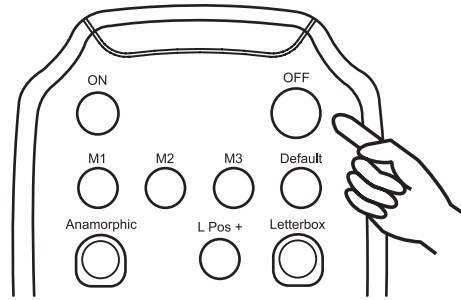

5. Menu

Using the Menu

This unit is equipped with an on-screen display (OSD) menu for making various adjustments and settings.

There are four different menu languages; see page 24 Language setting for more details.

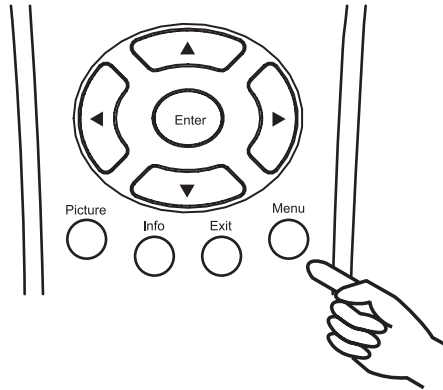

- Press the **Menu** button to turn on /off the on-screen display menu.
- Use the ARROW buttons (▲, ◀, ▼, ▶) to select the menu or to make various adjustments.
- Press the **Enter** or ▶ button to enter the setting of items in the menu, or press the **Exit** button to leave and save the setting of items in the menu.

Main Menu

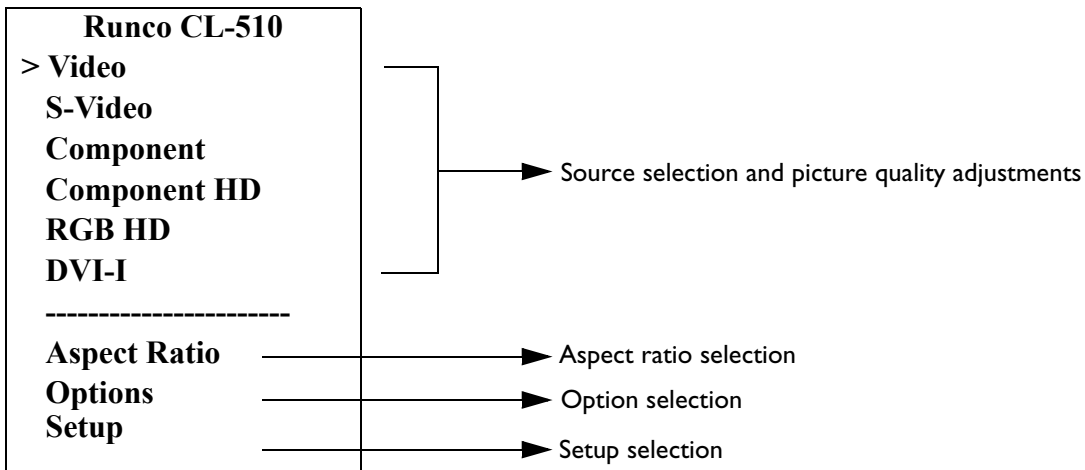

When the **Menu** button is pressed on the remote control, the main menu will appear on-screen. An example of the main menu is shown above. Use ▲ or ▼ button to move the item you want to choose and then press the **Enter** or ▶ button.

The active source is indicated by an arrow (>) to the left of the source; note that in the example above, Video is the current source.

Picture Quality Adjustments

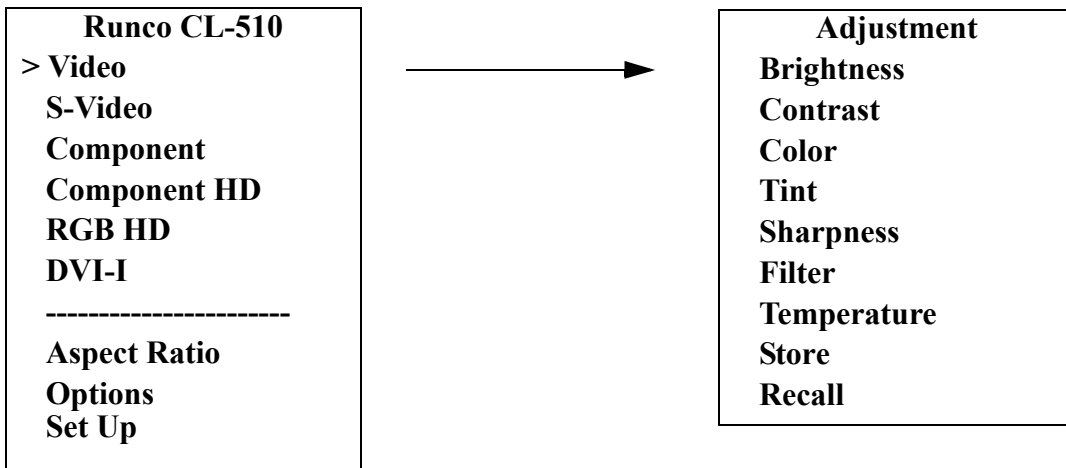

To access the picture quality adjustments, press **Menu**, highlight the active source (indicated by the arrow) and press **Enter** or **▶**. The picture quality sub-menu will then appear (see above).

To make an adjustment to a particular function, highlight the function with the **▲** or **▼** arrow button and press **Enter** or **▶** to activate a scroll bar for that adjustment.

To enter into the memory selection menus, use **Store** and **Recall** menus to save and load up to three different memories. There are three memories: Memory 1, Memory 2 and Memory 3.

Aspect Ratio

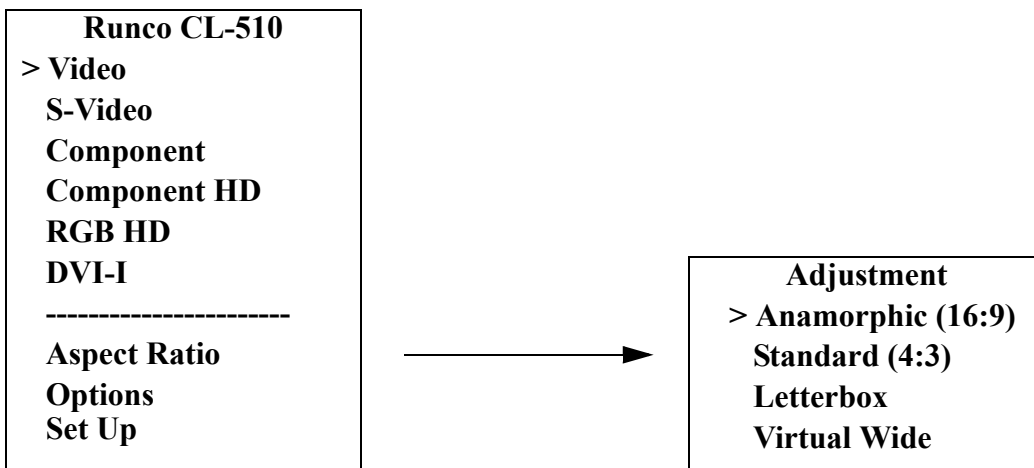

There are four aspect ratios available that can be selected for video signal inputs.

16:9 Screens:

- **ANAMORPHIC:** The image is compressed vertically, but anamorphic software will appear properly proportioned. This is best suited for use with 16:9 DVD's.



- 4 x 3: The input signal will be scaled to fit in the center of the 16:9 screen.

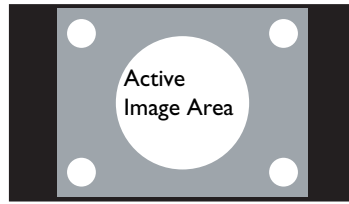

- LETTERBOX: The image in the Letterbox mode will be stretched vertically, and the top and bottom portion 'blanked off'. This ratio is best suited for LaserDisc movies or non-anamorphic DVD's.



- VIRTUAL WIDE: A 4:3 image is transformed into a 16x9 image.

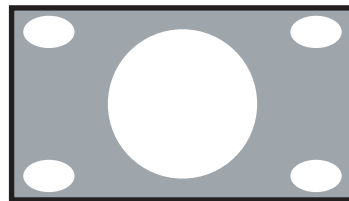

Options

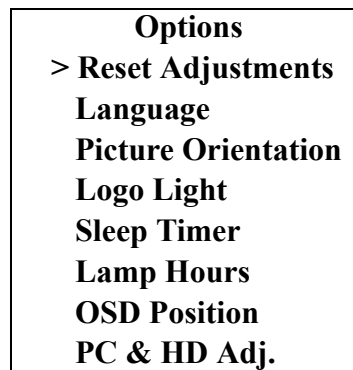
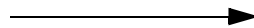
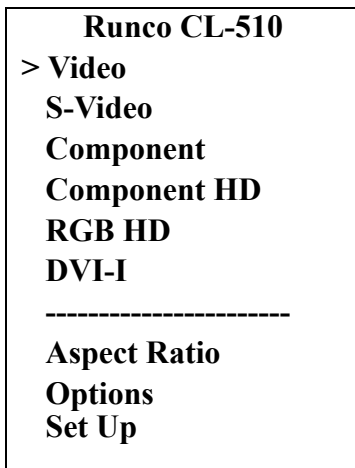

Press **Enter** on selected feature to open the adjustment menu.

Reset Adjustments: Use this function to reset all values of the current source back to factory default.

Language: There are 4 different menu languages available: English, Spanish, French and German.

Picture Orientation: The projector can be installed on a ceiling or in a rear screen configuration with one or more mirrors. There are four settings: FLOOR FRONT, CEILING FRONT, FLOOR REAR, and CEILING REAR.

Logo Light: To turn on or off projector logo light.

Sleep Timer: To setup auto off timer. The setting timer is from 10 minutes to 3 hours.

Lamp Hours: To check for total time of lamp usage.

OSD Position: To adjust horizontal and vertical positions of OSD.

PC & HD Adj.: The following settings are only available with a PC or DTV RGB signal. There is no position adjustment when using DVI-D signal.

- **AUTO:** Adjusts the phase, frequency and position automatically.
- **FREQ.:** Adjusts the frequency of the signal.
- **PHASE:** Adjusts the phase of the input signal.
- **H. POS.:** Adjusts the horizontal position of the image.
- **V. POS.:** Adjusts the vertical position of the image.

Setup

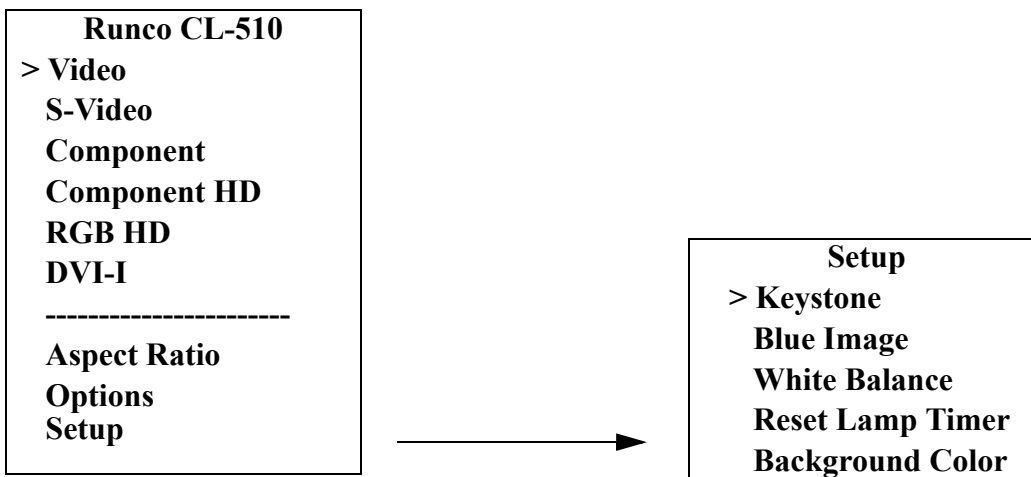

The Setup menu is passcode protected and for use by Runco personnel only. Many of the adjustments available in this section are intended for use by trained service personnel only. If you are having difficulty with one of these items, please contact your Runco Dealer for service.

All items below which are printed in *italic* are intended for service personnel only. Non-italic items can be modified by the projector owner.

The CL-510 has four memory settings for color temperature. Three of these settings are factory set to default as follows:

- Temp 1** -- 5400 kelvin
- Temp 2** -- 6500 kelvin
- Temp 3** -- 7500 kelvin

The Temp 4 memory is installer adjustable and can be used to create custom settings. A passcode must be entered in order to change this setting. There are nine adjustable "white balance" parameters available for the Temp 4 setting. Once the desired adjustments have been entered, selecting "store" will save these custom settings into the "Temp 4" memory position.

Keystone: *Corrects the trapezoidal distortion as a result of the angle of projection (-12° ~ +12°). This can correct for up to +/- 12 degrees of offset.*

Blue Image: *This mutes the red and green.*

White Balance: To adjust grey scale.

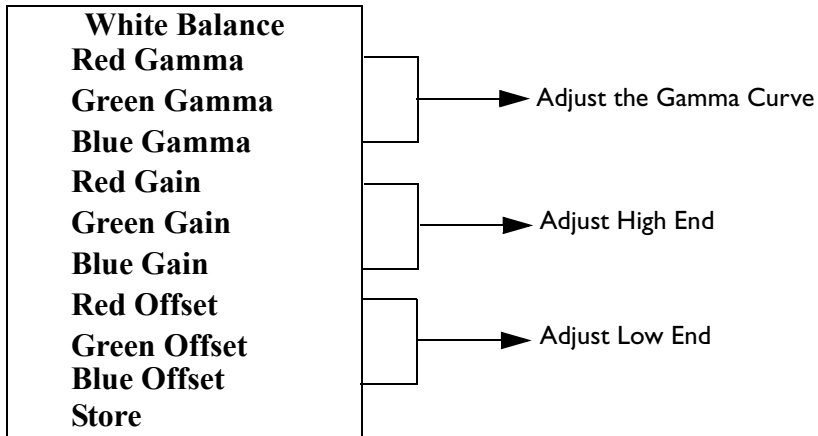

Reset Lamp Timer: Use this function to reset lamp usage counter. Reset only if you replace the lamp.

Background Color: To adjust background color to blue or white.

6. Additional Information

Warning Message

<ul style="list-style-type: none"> ■ It is normal for lamp to be darker when this unit has been used for a period of time. ■ " Lamp life is expired ! Please install new lamp. And reset the lamp timer" message will be displayed for 30 seconds on the screen if the lamp has operated for 950 hours. 	<p>Lamp life is expired ! Please install new lamp And reset the lamp timer</p>
<ul style="list-style-type: none"> ■ " Please change the lamp, Lamp will exceed its lifetime after (hours):" message will be displayed on the screen for 30 seconds for each time turning on, if the lamp has operated for 980 hours. And the number will count down continuously. 	<p>Please change the lamp ! Lamp will exceed its lifetime after (hours):</p>
<ul style="list-style-type: none"> ■ "Please change the lamp !" message will display on the screen all the time and the POWER LED will blink in orange and green sequentially if the lamp has operated for more than (1,000) hours. ■ The power will turn off automatically after 10 minutes. 	<p>Please change the lamp !</p>

Replace the Lamp (Contact your Runco Dealer)

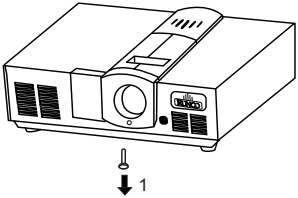
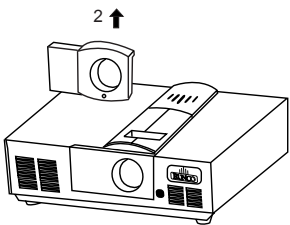
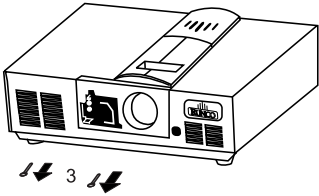
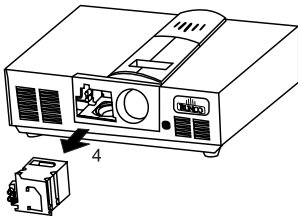
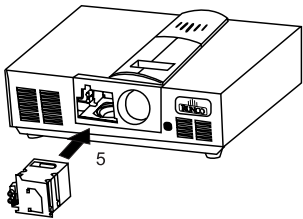
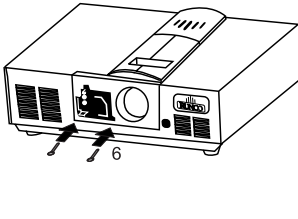
<p>1. Loosen the screw of front lamp cover</p> 	<p>2. Take off the front lamp cover.</p> 
<p>3. Loosen the two screws of lamp module.</p> 	<p>4. Pull out the lamp module horizontally.</p> 
<p>5. Insert the new lamp module into this projector horizontally until it is securely in place.</p> 	<p>6. Tighten the two screws of lamp module.</p> 

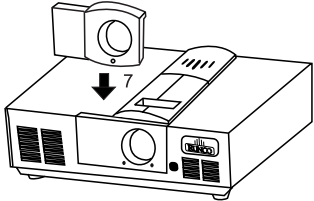
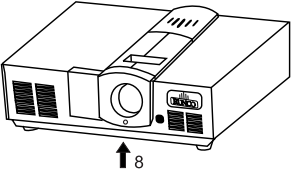
<p>7. Put on the front lamp cover.</p>		<p>8. Tighten the screw of front lamp cover.</p> <p>9. Turn on the power and go into the Set Up menu to reset the "Lamp Timer" item.</p>	
--	---	--	---

Troubleshooting

Problem	Possible Cause	Remedy
This unit does not turn on.	There is no power from power cable.	Plug the power cord into the AC inlet on the rear of this unit, and plug the power cord into to the power inlet.
	The power switch is not turned on.	Turn on the power switch.
	Turn on this unit again within the cooling down procedure.	Wait until this unit completes the cooling down procedure.
	Front lamp cover is not attached well.	Correctly attach the front lamp cover.
No picture	The front lamp cover is not correctly attached.	Correctly attach the front lamp cover.
	This unit is not correctly connected to the input source device.	Check the connection.
	The input signal has not been correctly selected.	Select the correct input signal with the input keys: Video, S-Video, Component, Component HD, RGB HD and DVI-I on the remote control.
	POWER LED or LAMP LED blinking.	Please contact your Runco dealer for assistance.
Image is unstable	The connection cables are not connected to this unit.	Correctly connect the cables to the appropriate terminals.
Picture is blurred	The projection lens is not correctly focused.	Adjust the focus of projection lens with the focus ring.
	This unit and the screen are not aligned squarely.	Adjust the projection angle and direction, and the height of this unit.
Remote control does not work correctly	The batteries are exhausted.	Replace both batteries with new ones.
LAMP LED blinks in red	The front lamp cover is not correctly attached.	Correctly attach the front lamp cover.
	The cooling fan does not work well.	Please contact your Runco dealer for assistance.
	The temperature inside this unit is extremely high.	Check that the ventilation holes are not blocked.
POWER LED blinks in orange and green sequentially	The lamp has exceed its specified usage hours.	Replace the lamp with a new one.
	The lamp has burned out.	Replace the lamp with a new one.

Specifications

CL-510/ CL-510LT Specifications

Projector Type:	Digital Light Processing™ (DLP™), Single Matterhorn DMD™ Chip
Native Resolution:	1024 x 576, (16:9)
Aspect Ratios:	4:3, Letterbox, 16:9, Anamorphic, Virtual Wide
Video Standards:	NTSC, PAL
DTV Compatibility:	480p, 720p, 1080i
Scan Frequency:	Horizontal: 15-80 kHz Vertical: 50-100 Hz
Picture Size (16:9 Screen):	Recommended Width: 72-96 in. Maximum Width: 200 in.
Throw Distance (Factor x Screen Width):	CL-510: 1.75 to 2.00/ CL-510LT: 2.30 to 3.00 Please refer to page 11 to page 14.
Light Output:	900 ANSI Lumens* CSMS** Specifications: Home Theater Calibration: 471 ANSI Lumens 17.8 Foot-Lamberts (fL)
Contrast Ratio:	1700:1 CSMS** Contrast Ratio: 149:1
Lamp:	210W
Lamp Life:	1000 hours @ 6500° Kelvin
Inputs:	(1) Composite Video, (1) S-Video, (1) RGB/Component (via BNC), (1) RCA Component Video, (1) DVI w/ HDCP, (1) RS-232
Memories:	21 memories
12V Output:	Max .250 Amp, active when the projector is on
Power Requirements:	100-240V AC, 50/60 Hz, 310 watts
Operating Environment:	41° - 95° F, (5° - 35° C), 20%-80% Humidity (non-condensing)
Dimensions (w/out feet):	Width: 16.15 in. (410.16 mm), Depth: 14.56 in. (369.71 mm), Height: Without feet 5.3 in. (134.62mm) with feet 5.8 in. (148.62 mm) Weight: 22 lbs. (10 kg) (includes lens)
Regulatory Approvals:	UL, CSA, GS-TUV, CCIB, CB, FCC, CE, VCCI and C-Tick
Limited Warranty:	<u>Projector:</u> (2) Two year parts and labor from the date of delivery to the end user <u>Lamp Warranty:</u> 6 months

***ANSI Lumen specification:**

This is the typical projector luminosity (brightness) specification found in most sales literature. This measurement is included in RUNCO literature to allow for direct comparison with other manufacturer's projectors. These measurements can be taken at 9,000 to 13,000 degree Kelvin to get expected performance data when the projector is used in professional, commercial, and industrial displays.

****CSMS Home Theater Calibration ANSI Lumen Specification:**

These measurements are taken from the projector as setup in a home theater environment. The projector is calibrated to ISF specifications including setting the color temperature to 6500 degree Kelvin, the standard for reproducing video.

****CSMS Home Theater Calibration foot-Lambert (fL) Specification:**

This is the unit of measurement used in commercial movie theaters to express image brightness. The Society of Motion Picture and Television Engineers (SMPTE) specifies 16 fL as the target image brightness for film-based projectors using an open gate (without film in the projector). More importantly, today SMPTE specifies 12 fL as the target image brightness in Digital Cinema theaters using DLP™ technology. The foot-Lambert is dependant on screen size, screen gain, and projector light output.

All measurements are made at RUNCO to ANSI/NAPM IT7.228-1997 specifications using the Photo Research PR-650 SpectraColorimeter and Minolta LS-100 Light Meter, *Video Essentials* test DVD, and a Stewart Filmscreen StudioTech 130, 1.3 gain, 72-inch wide screen. The projector is calibrated to a color temperature of 6500 ° Kelvin and has a minimum of 150 hours of usage.

Dimensions

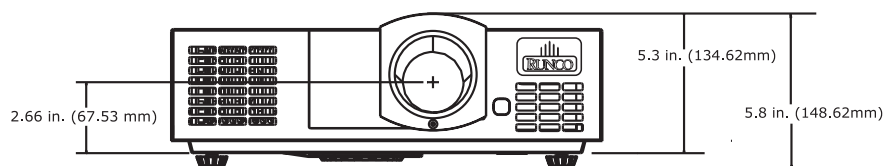
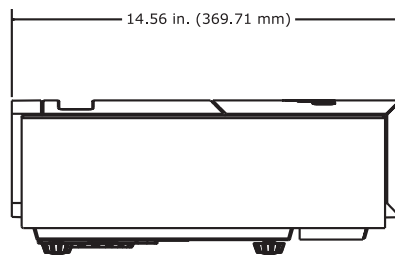
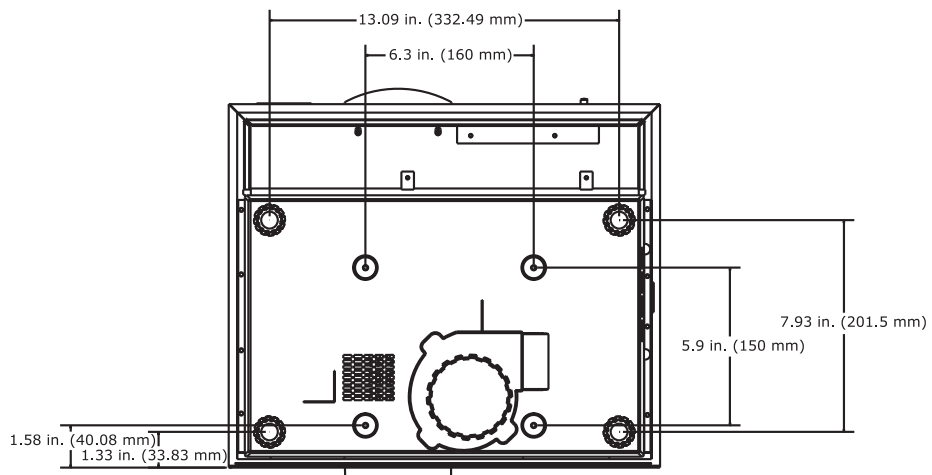
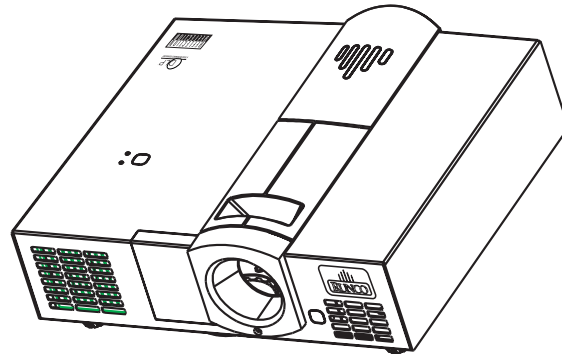
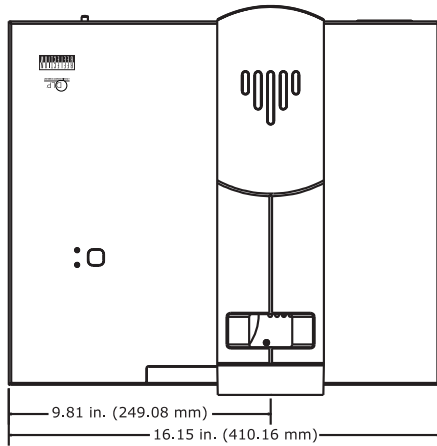

Unit: in. (mm)

RS-232 Setup

Baud Rate: 115200 or 9600

Parity: None

Data Bits: 8 Bits

Stop Bits: 1 Bit

Flow Control: None

RS-232C Control Codes

Code	Function
X01	Power On
X02	Power Off
X03	Message On
X04	Message Off
X10	Menu (arrow key)
X11	Enter (arrow key)
X12	Exit (arrow key)
X13	Up (arrow key)
X14	Down (arrow key)
X15	Left (arrow key)
X16	Right (arrow key)
X20	Switch to Composite input
X21	Switch to S-Video input
X22	Switch to Component input
X23	Switch to D-Sub _PC input
X24	Switch to YPBPR input
X25	Switch to BNC_PC input
X35	Anamorphic
X36	Standard
X37	Letter box
X38	Virtual Wide
X40	Load memory 1 settings
X41	Load memory 2 settings
X42	Load memory 3 settings
X46	Load default of current source
X47	Save memory 1 settings
X48	Save memory 2 settings
X49	Save memory 3 settings
X55	Switch active source
X56	Picture in picture display
X57	Picture in picture display
X60	Switch language - English
X61	Switch language - French
X62	Switch language - Spanish
X85	PC Input - auto
X90	Image orientation - floor front
X91	Image orientation - ceiling front
X92	Image orientation - floor rear
X93	Image orientation - ceiling rear
X94	Back light on
X95	Back light off

PC Out Adapter

1. Connect D-Sub 9-pin female to RJ-11 adapter (not included) to Com port on PC.
2. Connect RJ-11 to Projector.

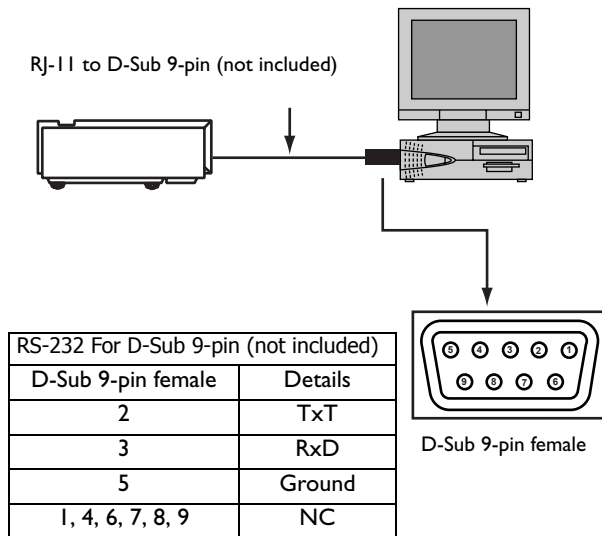

Warning: During initial turn on and turn off of the projector, this unit will not accept RS-232 codes for 20 seconds.

RS-232 For RJ-11 (not included)	
4-pin RJ-11	Details
2	TxT
3	RxD
1, 4	Ground

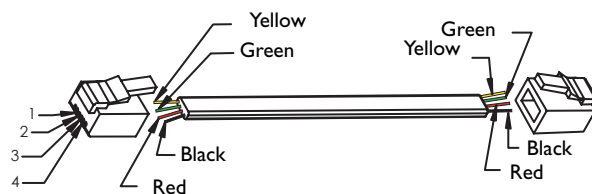

NOTE:

1. All codes are in the ASCII format.
2. A carriage return is required after each command.

RUMA-010300 rev 7-03



THE WORLD'S FINEST HOME THEATER PRODUCTS™

Runco International • 2900 Faber Street • Union City, CA 94587 • ph (510) 324-7777 • fax (510) 324-9300 • www.runco.com