

myprojectorlamps.com

**The most trusted, dependable name
in projector lamp sales.**



<http://www.myprojectorlamps.com>



<http://www.myprojectorlamps.ca>



<http://www.myprojectorlamps.eu>

The following projector manual has not been modified or altered in any way.

PROXIMA®

ULTRALIGHT LX2

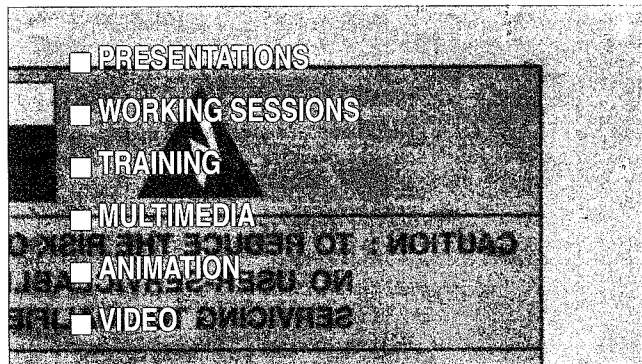
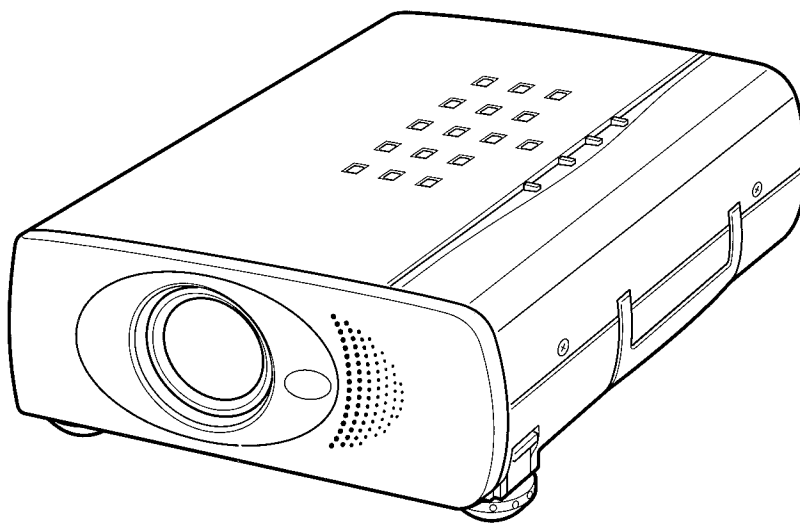

INFORMATION TO THE USER

NOTE : This equipment has been tested and found to comply with the limits for a Class A digital device, pursuant to Part 15 of FCC Rules. These limits are designed to provide reasonable protection against harmful interference when the equipment is operated in a commercial environment. This equipment generates, uses, and can radiate radio frequency energy and, if not installed and used in accordance with the instruction manual, may cause harmful interference to radio communications. Operation of this equipment in a residential area is likely to cause harmful interference in which case the user will be required to correct the interference at his own expense.

TO THE OWNER

As the owner of a new ULTRALIGHT LX2, you are probably eager to try out your new projector. Before you do, we suggest that you spend a little time reading this manual to familiarize yourself with the operating procedures, so that you will receive maximum satisfaction from the many features included in your new projector. This user's guide will acquaint you with your projector's features. Reading it will help us too. Through the years, we have found that many service requests were not caused by problems with our projectors. They were caused by problems that could have been prevented, if the owner had followed the instructions in the manual. You can often correct operating problems yourself. If your projector fails to work properly, see "TROUBLESHOOTING" section on pages 35 ~ 36 and try the solution marked for each problem.

SAFETY PRECAUTIONS

WARNING:

TO REDUCE THE RISK OF FIRE OR ELECTRIC SHOCK, DO NOT EXPOSE THIS APPLIANCE TO RAIN OR MOISTURE.

This Projector has a grounding-type AC line plug. This is a safety feature to be sure that the plug will fit into the power outlet. Do not try to defeat this safety feature.

This projector produces intense light from the projection lens. Do not stare directly into the lens as possible eye damage could result. Be especially careful that children do not stare directly into the beam.

The Remote Control Unit, supplied to this projector, emits the laser beam as the Laser Pointer function from the Laser Light Window while pressing the LASER button (for 1 minute). Do not look into the Laser Light Window or shine the laser beam on yourself or other people. Eye damage may result.

This projector should be set in the way indicated. If not, it may result in fire hazard.

If the projector will not be used for an extended time, unplug the projector from the power outlet.

READ AND KEEP THIS user's guide FOR LATER USE.



CAUTION
RISK OF ELECTRIC SHOCK
DO NOT OPEN



CAUTION : TO REDUCE THE RISK OF ELECTRIC SHOCK, DO NOT REMOVE COVER (OR BACK). NO USER-SERVICEABLE PARTS INSIDE EXCEPT LAMP REPLACEMENT. REFER SERVICING TO QUALIFIED SERVICE PERSONNEL.



THIS SYMBOL INDICATES THAT DANGEROUS VOLTAGE CONSTITUTING A RISK OF ELECTRIC SHOCK IS PRESENT WITHIN THIS UNIT.



THIS SYMBOL INDICATES THAT THERE ARE IMPORTANT OPERATING AND MAINTENANCE INSTRUCTIONS IN THE user's guide WITH THIS UNIT.

IMPORTANT SAFETY INSTRUCTIONS

All the safety and operating instructions should be read before the product is operated.

Read all of the instructions given here and retain them for later use. Unplug this projector from AC power supply before cleaning. Do not use liquid or aerosol cleaners. Use a damp cloth for cleaning.

Do not use attachments not recommended by the manufacturer as they may cause hazards.

Do not place this projector on an unstable cart, stand, or table. The projector may fall, causing serious injury to a child or adult, and serious damage to the projector. Use only with a cart or stand recommended by the manufacturer, or sold with the projector. Wall or shelf mounting should follow the manufacturer's instructions, and should use a mounting kit approved by the manufacturers.

Do not expose this unit to rain or use near water... for example, in a wet basement, near a swimming pool, etc...

Slots and openings in the back and bottom of the cabinet are provided for ventilation, to insure reliable operation of the equipment and to protect it from overheating.

The openings should never be covered with cloth or other materials, and the bottom opening should not be blocked by placing the projector on a bed, sofa, rug, or other similar surface. This projector should never be placed near or over a radiator or heat register.

This projector should not be placed in a built-in installation such as a book case unless proper ventilation is provided.

This projector should be operated only from the type of power source indicated on the marking label. If you are not sure of the type of power supplied, consult your authorized dealer or local power company.

Do not overload wall outlets and extension cords as this can result in fire or electric shock. Do not allow anything to rest on the power cord. Do not locate this projector where the cord may be damaged by persons walking on it.

Never push objects of any kind into this projector through cabinet slots as they may touch dangerous voltage points or short out parts that could result in a fire or electric shock. Never spill liquid of any kind on the projector.

Do not attempt to service this projector yourself as opening or removing covers may expose you to dangerous voltage or other hazards. Refer all servicing to qualified service personnel.

Unplug this projector from wall outlet and refer servicing to qualified service personnel under the following conditions:

- When the power cord or plug is damaged or frayed.
- If liquid has been spilled into the projector.
- If the projector has been exposed to rain or water.

- If the projector does not operate normally by following the operating instructions. Adjust only those controls that are covered by the operating instructions as improper adjustment of other controls may result in damage and will often require extensive work by a qualified technician to restore the projector to normal operation.
- If the projector has been dropped or the cabinet has been damaged.
- When the projector exhibits a distinct change in performance-this indicates a need for service.

When replacement parts are required, be sure the service technician has used replacement parts specified by the manufacturer that have the same characteristics as the original part. Unauthorized substitutions may result in fire, electric shock, or injury to persons.

Upon completion of any service or repairs to this projector, ask the service technician to perform routine safety checks to determine that the projector is in safe operating condition.

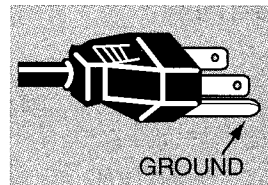

This projector is equipped with a grounding type AC line plug. Should you be unable to insert the plug into the outlet, contact your electrician. Do not defeat the safety purpose of this grounding type plug.

Follow all warnings and instructions marked on the projectors.

For added protection to the projector during a lightning storm, or when it is left unattended and unused for long periods of time, unplug it from the wall outlet. This will prevent damage due to lightning and power line surges.



An appliance and cart combination should be moved with care. Quick stops, excessive force, and uneven surfaces may cause the appliance and cart combination to overturn.

If the projector is to be built into a compartment or similarly enclosed, the minimum distances must be maintained.

Do not cover the ventilation slot on the projector.

Heat build-up can reduce the service life of your projector, and can also be dangerous.

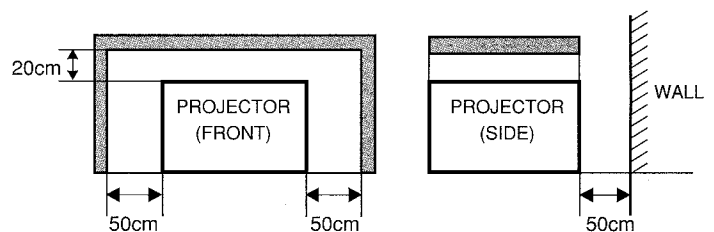

TABLE OF CONTENTS

FEATURES AND DESIGN	5	COMPUTER MODE	22
PREPARATION	6	SELECTING COMPUTER MODE	22
NAME OF EACH PART OF THE PROJECTOR	6	SELECTING COMPUTER SYSTEM	22
SETTING-UP THE PROJECTOR	7	AUTOMATIC MULTISCANNING SYSTEM	22
POSITIONING THE PROJECTOR	7	COMPATIBLE COMPUTER SPECIFICATIONS	23
ADJUSTABLE FEET	7	PC ADJUSTMENT	24
CONNECTING THE AC POWER CORD	8	PICTURE IMAGE ADJUSTMENT	26
VENTILATION	8	ADJUST PICTURE IMAGE MANUALLY	26
MOVING THE PROJECTOR	9	NORMAL FUNCTION	26
		AUTO IMAGE FUNCTION	27
		PICTURE POSITION ADJUSTMENT	27
		PICTURE SCREEN ADJUSTMENT	28
CONNECTING THE PROJECTOR	10	VIDEO MODE	29
TERMINALS OF THE PROJECTOR	10	SELECTING VIDEO MODE	29
CONNECTING TO THE VIDEO EQUIPMENT	11	SELECTING COLOR SYSTEM	29
CONNECTING TO THE COMPUTER	12	PICTURE SCREEN ADJUSTMENT	29
		PICTURE IMAGE ADJUSTMENT	30
BEFORE OPERATION	14	ADJUSTING THE PICTURE IMAGE MANUALLY	30
OPERATION OF THE REMOTE CONTROL	14	NORMAL FUNCTION	30
LASER POINTER FUNCTION	14	SETTING	31
REMOTE CONTROL BATTERIES INSTALLATION	15	SETTING MENU	31
TOP CONTROLS AND INDICATORS	16	SETTING LANGUAGE	31
OPERATING ON-SCREEN MENU	17		
HOW TO OPERATE THE ON-SCREEN MENU	17	APPENDIX	32
FLOW OF ON-SCREEN MENU	17	OPERATING WIRELESS MOUSE	32
MENU BAR	18	MAINTENANCE	33
BASIC OPERATION	19	TEMPERATURE WARNING INDICATOR	33
TURNING ON / OFF THE PROJECTOR	19	AIR FILTER CARE AND CLEANING	33
ADJUSTING THE IMAGE	20	CLEANING THE PROJECTION LENS	33
ZOOM ADJUSTMENT	20	LAMP REPLACEMENT	34
FOCUS ADJUSTMENT	20	LAMP REPLACEMENT MONITOR TIMER	34
KEYSTONE ADJUSTMENT	20	TROUBLESHOOTING	35
BLANK FUNCTION	21	TECHNICAL SPECIFICATIONS	37
PICTURE FREEZE FUNCTION	21		
SOUND ADJUSTMENT	21		
SOUND VOLUME ADJUSTMENT	21		
SOUND MUTE ADJUSTMENT	21		

TRADEMARKS

- Apple, Macintosh, and PowerBook are trademarks or registered trademarks of Apple Computer, Inc.
- IBM and PS/2 are trademarks or registered trademarks of International Business Machines, Inc.
- Windows and PowerPoint are registered trademarks of Microsoft Corporation.
- Each name of corporations or products in the user's guide is a trademark or a registered trademark of its respective corporation.

FEATURES AND DESIGN

This Multimedia Projector is designed with the most advanced technology for portability, durability, and ease of use. The projector utilizes built-in multimedia features, a palette of 16.77 million colors, and matrix liquid crystal display (LCD) technology.

◆ **Compatibility**

This projector is compatible with many different types of personal computers and video devices, including;

- IBM-compatible computers, including laptops, up to 1280 x 1024 resolution.
- Apple Macintosh and PowerBook computers up to 1280 x 1024 resolution.
- Various video equipment using any of the world wide video standards, including NTSC, NTSC4.43, SECAM, PAL, PAL-M and PAL-N.

◆ **Image Resolution**

Picture Image of the computer is projected in the resolution of 1024 x 768 and it is provided just as appearing on your computer's monitor.

Screen resolutions between 1024 x 768 and 1280 x 1024 are compressed to 1024 x 768, and this projector cannot display screen resolutions above 1280 x 1024. If your computer's screen resolution is higher than 1280 x 1024, reset it to a lower resolution before you connect the projector.

◆ **Portability**

This projector is quite compact in size and weight. Having a sophisticated shape like an attaché case with a retractable carrying handle, the projector will help you make powerful presentation wherever you go.

◆ **Automatic Multiscanning System**

This projector automatically tunes to most personal computers currently distributed by simply connecting. It is free from complicated adjustments to project picture images from most Personal Computers.

◆ **Multilanguage Menu Display**

Operation menu is displayed in; English, Deutsch, Français, Italiano, Español, or Japanese.

◆ **Laser Pointer Function**

The Remote Control Unit of this projector has the Laser Pointer function providing convenience and smartness for your presentations.

◆ **Other Features**

This projector has Motor Zoom/Focus, Blank, Picture Freeze, Keystone and Mute functions. And the Air Pad Remote Control is equipped.

◆ **Accessories**

This projector comes with the parts listed below. Check to make sure all are included. If any parts are missing, contact to a sales dealer.

- USER'S GUIDE.
- AC Power Cord.
- Wireless Remote Control Unit.
- Batteries for Remote Control Unit.
- VGA Cable.
- MAC Adapter.
- Control Cable for PS/2 Port.
- Control Cable for Serial Port.
- Control Cable for ADB Port.
- PC Audio Cable (Stereo mini jack).
- AV Cable (RCA type x 3).
- S-VIDEO cable (Mini DIN-4 type).
- Lens Cover.
- Dust Cover.

PREPARATION

NAME OF EACH PART OF THE PROJECTOR

FRONT OF THE CABINET

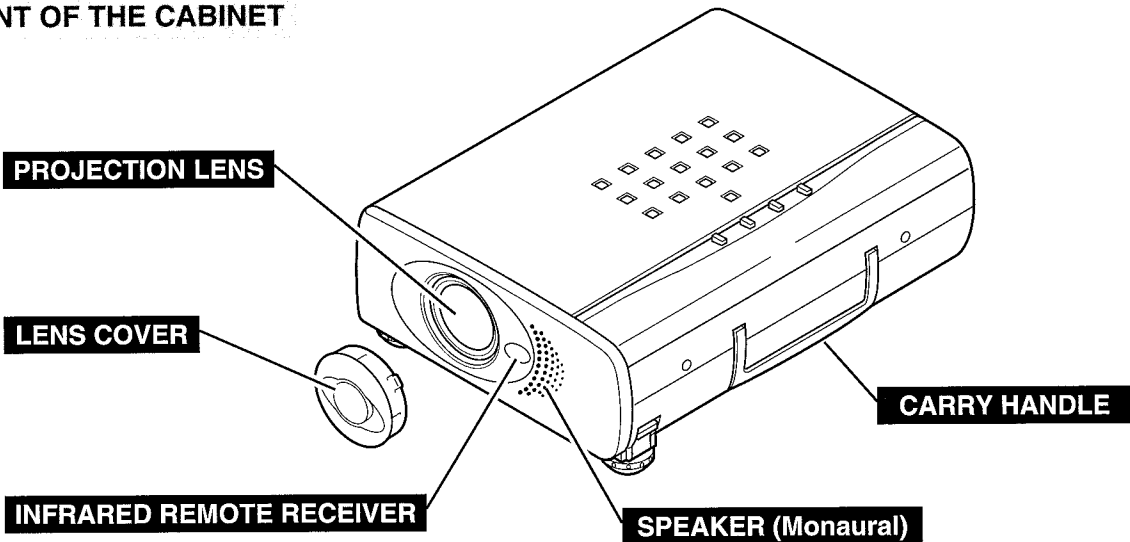

BACK OF THE CABINET

EXHAUST VENT



HOT AIR EXHAUSTED !

Air blown from the exhaust vent is hot. When using or installing the projector, following attention should be taken.

- Do not put a flammable object near this part. Keep heat-sensitive objects away from the exhaust vent.
- Do not touch this part especially screws and metallic parts. This part will become hot while the projector is used.

POWER CORD CONNECTOR

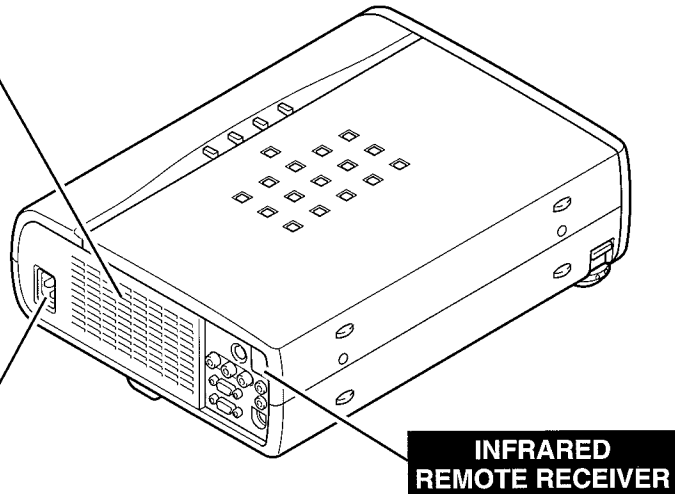

BOTTOM OF THE CABINET

AIR INTAKE VENTS

These Air Intake Vents should not be blocked.

LAMP COVER

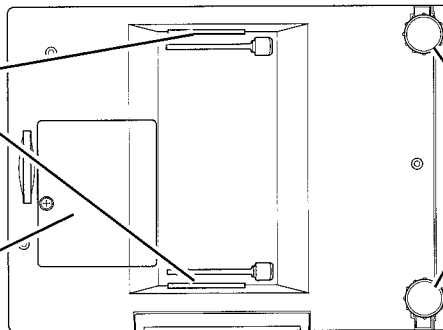

ADJUSTABLE FEET AND FEET LOCK LATCHES

SETTING-UP THE PROJECTOR

POSITIONING THE PROJECTOR

- This projector is basically designed to project on a flat projection surface.
- The projector can be focused from 4.6'(1.4m) ~ 35.4'(10.8m).
- Refer to the figure below to adjust the screen size.

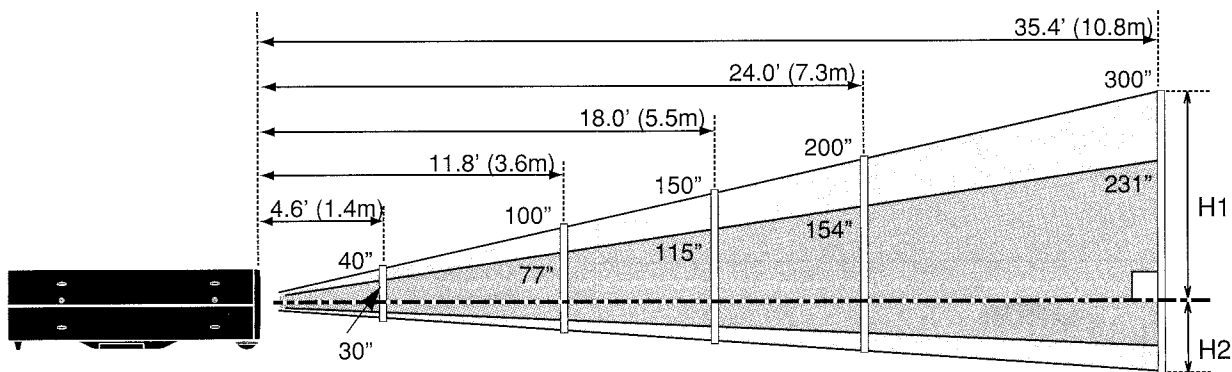

Screen Size (W x H) mm	30"	60"	100"	150"	200"	300"
Height (H1)	17.1"(435mm)	34.3"(870mm)	57.1"(1451mm)	85.7"(2177mm)	114.3"(2903mm)	171.4"(4354mm)
Height (H2)	0.9"(22mm)	1.7"(44mm)	2.9"(73mm)	4.3"(109mm)	5.7"(145mm)	8.6"(218mm)

ROOM LIGHT

The brightness in the room has a great influence on the picture quality. It is recommended to limit ambient lighting in order to provide the best image.

ADJUSTABLE FEET

Picture tilt and projection angle can be adjusted by rotating the ADJUSTABLE FEET. Projection angle can be adjusted to 10 degrees.

- 1** Lift the front of the projector and pull the FEET LOCK LATCHES on both sides of the projector.
- 2** Release the FEET LOCK LATCHES to lock the ADJUSTABLE FEET and rotate the ADJUSTABLE FEET for fine tune of the position and the tilt.
- 3** To shorten the ADJUSTABLE FEET, lift the front of the projector and pull and undo the FEET LOCK LATCHES.

The position and the keystone distortion of the image can be also adjusted with the Menu Operation. (Refer to P 20, 28 and 29.)

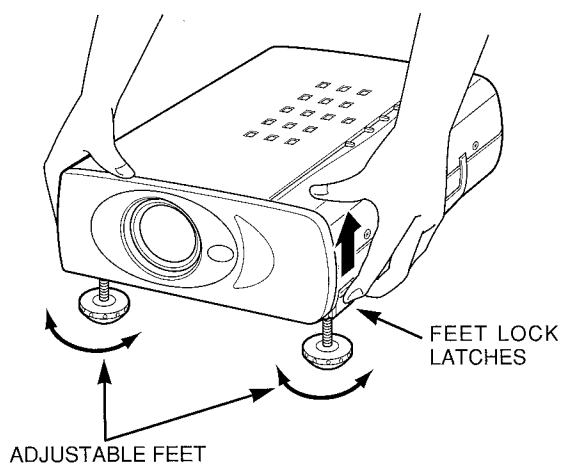

CONNECTING THE AC POWER CORD

This projector uses nominal input voltages of 100-120 V or 200-240 V AC. The projector automatically selects the correct input voltage. It is designed to work with single-phase power systems having a grounded neutral conductor. To reduce the risk of electrical shock, do not plug into any other type of power system.

Consult your authorized dealer or service station if you are not sure of the type of power supply being in use.

Connect the projector with the peripheral equipment before turning the projector on. (Refer to pages 10 ~ 13 for connection.)



CAUTION

For the safety, unplug the AC Power Cord when the appliance is not used.

When this projector is connected to the outlet with the AC Power Cord, the appliance is in Stand-by Mode and consumes a little electric power.

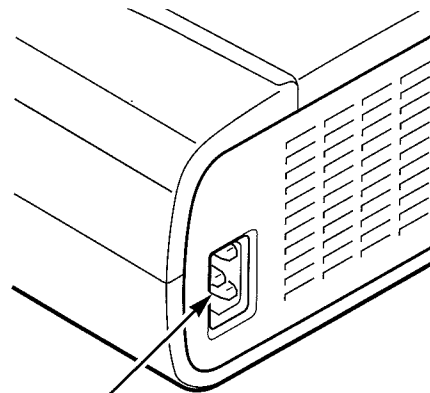

Connect the AC power supply cord (supplied) to the projector.

The socket-outlet must be near this equipment and must be easily accessible.

Projector side (Female)

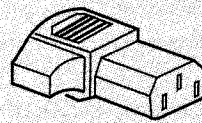

AC outlet side (Male)

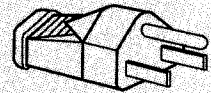

VENTILATION

This projector is equipped cooling fans for protection from overheating. Pay attention to the following to ensure the ventilation and avoid a possible risk of fire and malfunction.

- Do not cover the vent slot.
- Keep the rear grill at least one meter away from any object.
- Make sure that there is no object on both sides of the projector. Those obstacles may prevent the projector from taking the cooling air through the side Air Intake Vent Slots.

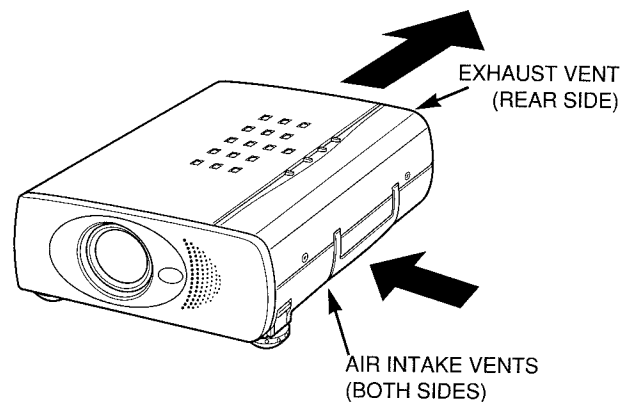

MOVING THE PROJECTOR

Use the Carry Handle when moving the Projector.
When moving the projector, replace the lens cover and rotate the feet fully clockwise (to shorten the feet) to prevent from damage to the lens and the cabinet.

When this projector is not used for the extended period, replace the lens cover, tuck the Adjustable Feet and apply the dust cover supplied to this projector.

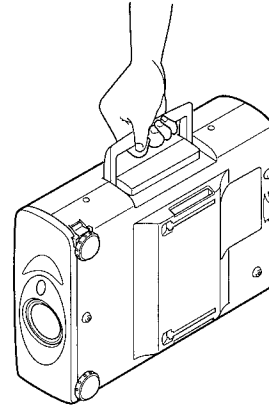

CAUTION IN CARRYING OR TRANSPORTING THE PROJECTOR

- Do not drop or give a shock to the projector, otherwise damages or malfunctions may result.
- When carrying the projector, use a carrying case recommended by Proxima.
- Do not transport the projector by using a courier or transport service in an unsuitable transport case. This may cause damage to the projector. To transport the projector through a courier or transport service, use a case recommended by Proxima.
- For carrying or transportation cases, contact a Proxima authorized dealer.

CONNECTING THE PROJECTOR

TERMINALS OF THE PROJECTOR

S-VIDEO INPUT JACK

Connect the S-VIDEO output from the video equipment to this terminal.
(Refer to P11.)

AUDIO INPUT JACKS

Connect the audio outputs from the video equipment to these terminals.
(Refer to P11.)

- When the audio output is monaural, connect it to the Left jack.

COMPUTER INPUT TERMINAL

Connect the computer output to this terminal.
(Refer to P12, 13.)

MONITOR OUTPUT TERMINAL

This terminal outputs the signal from the COMPUTER IN terminal. Connect to the monitor to this terminal.
(Refer to P12, 13.)

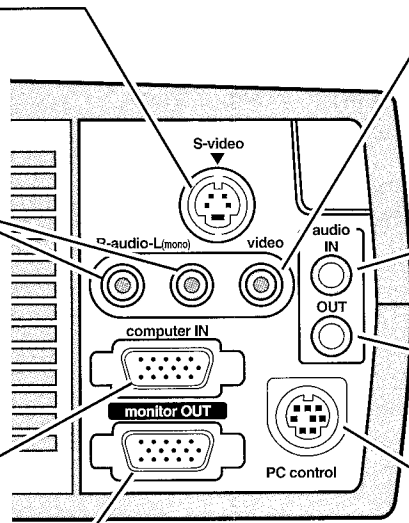

VIDEO INPUT JACK

Connect the video output from the video equipment to this terminal.
(Refer to P11.)

COMPUTER AUDIO INPUT JACK

Connect the audio output from the computer to this terminal.
(Refer to P12, 13.)

AUDIO OUTPUT JACK (STEREO)

Connect the audio amplifier to this terminal.
(Refer to P11, 12, 13.)

CONTROL PORT CONNECTOR

When controlling the computer with the Remote Control of this projector, connect the mouse port of your personal computer to this terminal.
(Refer to P12, 13.)

COMPUTER INPUT / MONITOR OUTPUT TERMINAL

Terminal : HDB15-PIN

Connect the display output terminal of the computer to COMPUTER INPUT terminal of this projector with the VGA Cable (supplied). And connect to the monitor to MONITOR OUTPUT with the monitor cable (not supplied). When connecting the Macintosh computer, the MAC/VGA Adapter (supplied) is required.

Pin Configuration

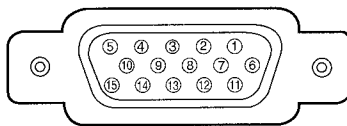

1	Red Input	9	Non Connect
2	Green Input	10	Ground (Vert.sync.)
3	Blue Input	11	Sense 0
4	Sense 2	12	Sense 1
5	Ground (Horiz.sync.)	13	Horiz. sync.
6	Ground (Red)	14	Vert. sync.
7	Ground (Green)	15	Reserved
8	Ground (Blue)		

CONTROL PORT CONNECTOR

Terminal : DIN 8-PIN

Connect control port (PS/2, Serial or ADB port) on your computer to this terminal with the Control Cable (supplied).

Pin Configuration

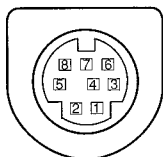

	PS/2	Serial	ADB
1	----	R X D	----
2	CLK	----	ADB
3	DATA	----	----
4	GND	GND	GND
5	----	RTS	----
6	----	T X D	----
7	GND	GND	----
8	----	GND	GND

CONNECTING TO THE VIDEO EQUIPMENT

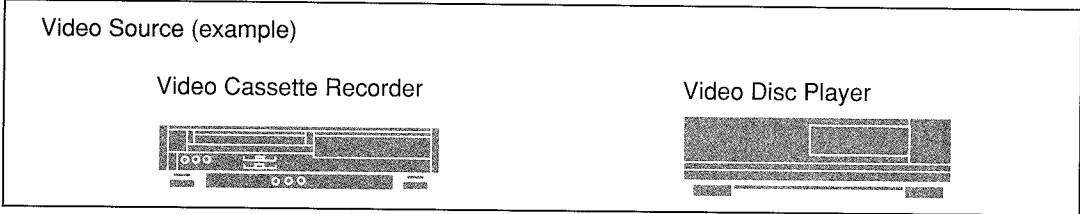

Used cables for connection

- VIDEO CABLE
- S-VIDEO CABLE
- AUDIO CABLE (stereo)

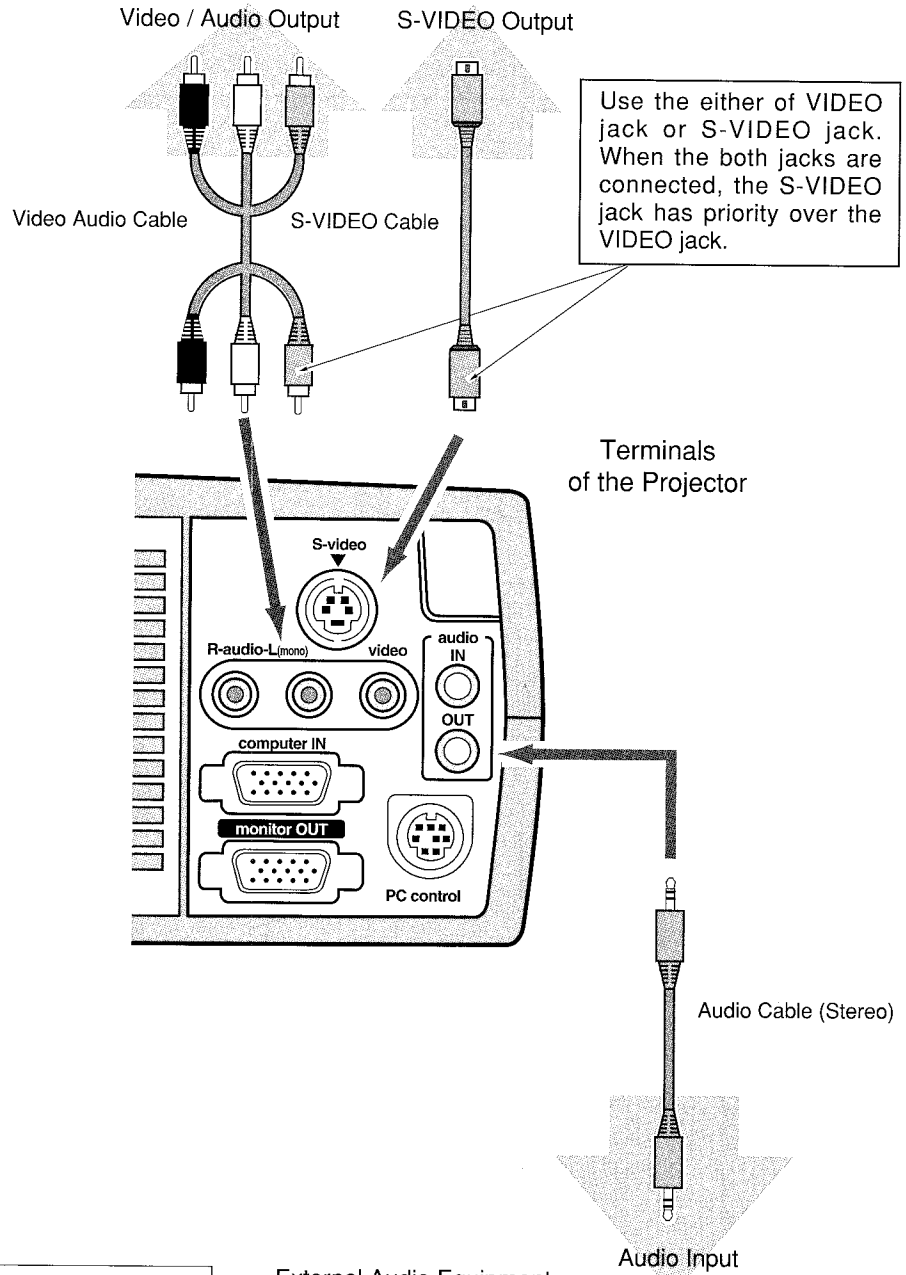

NOTE :
 When connecting the cable, the power cords of both the projector and the external equipment should be disconnected from AC outlet. Turn the projector and peripheral equipment on before the computer is switched on.

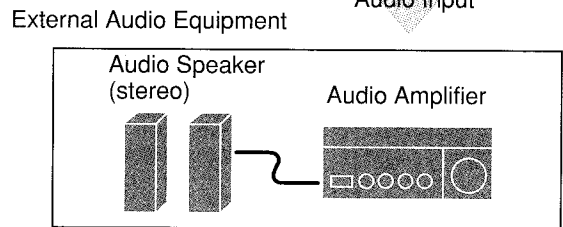

CONNECTING THE PROJECTOR

CONNECTING TO THE COMPUTER

To connect with the computer, refer to the figure below.

Used cables for connection

- VGA CABLE
- CONTROL CABLE FOR PS/2 PORT, SERIAL PORT, or ADB PORT
- MAC ADAPTER
- PC AUDIO CABLE (stereo)
- MONITOR CABLE *

* This cable is not supplied with this projector.

IBM-compatible computers or Macintosh computers (VGA / SVGA / XGA / SXGA)

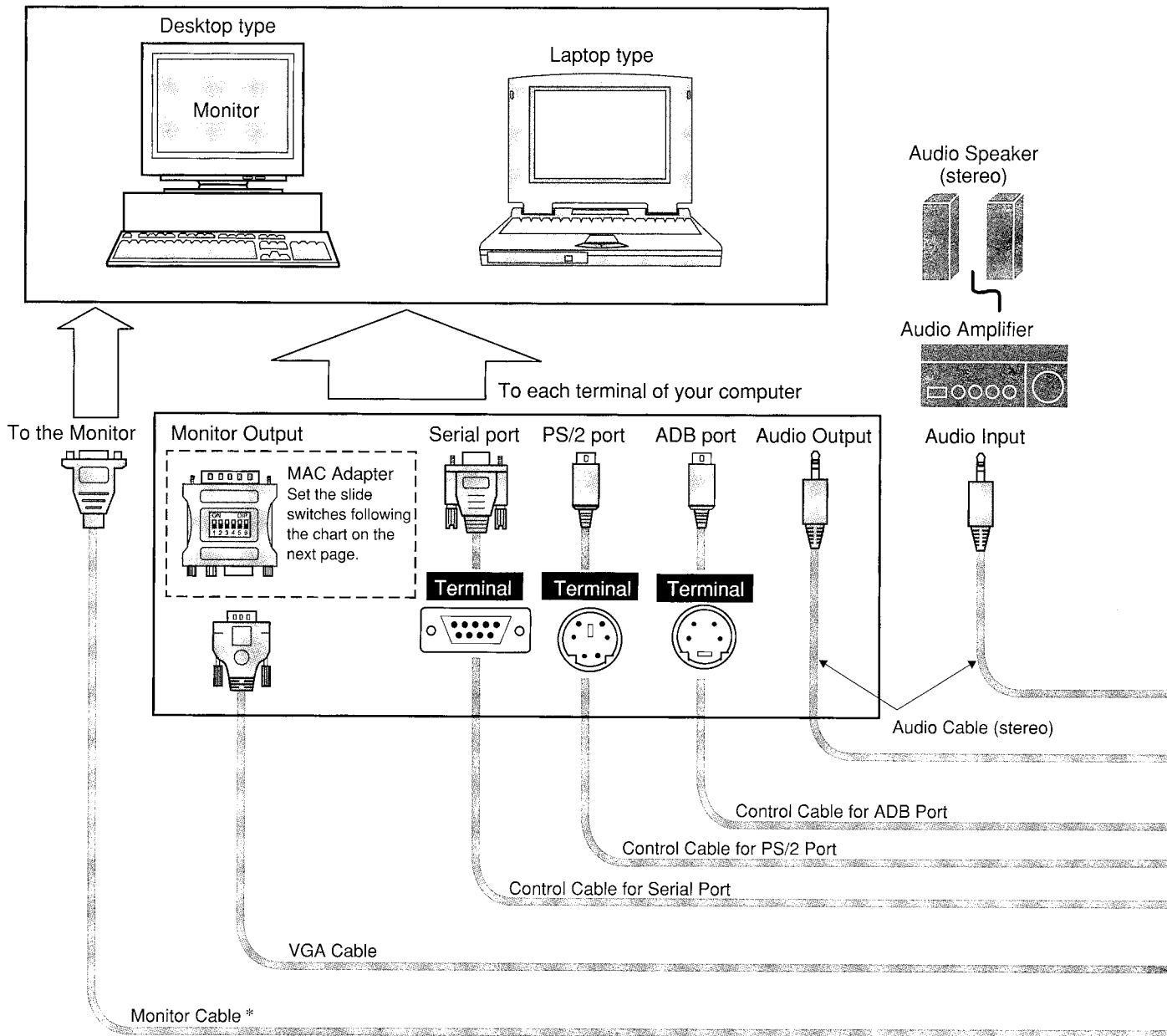

NOTE :

When connecting the cable, the power cords of both the projector and the external equipment should be disconnected from AC outlet. Turn the projector and peripheral equipment on before the computer is switched on.

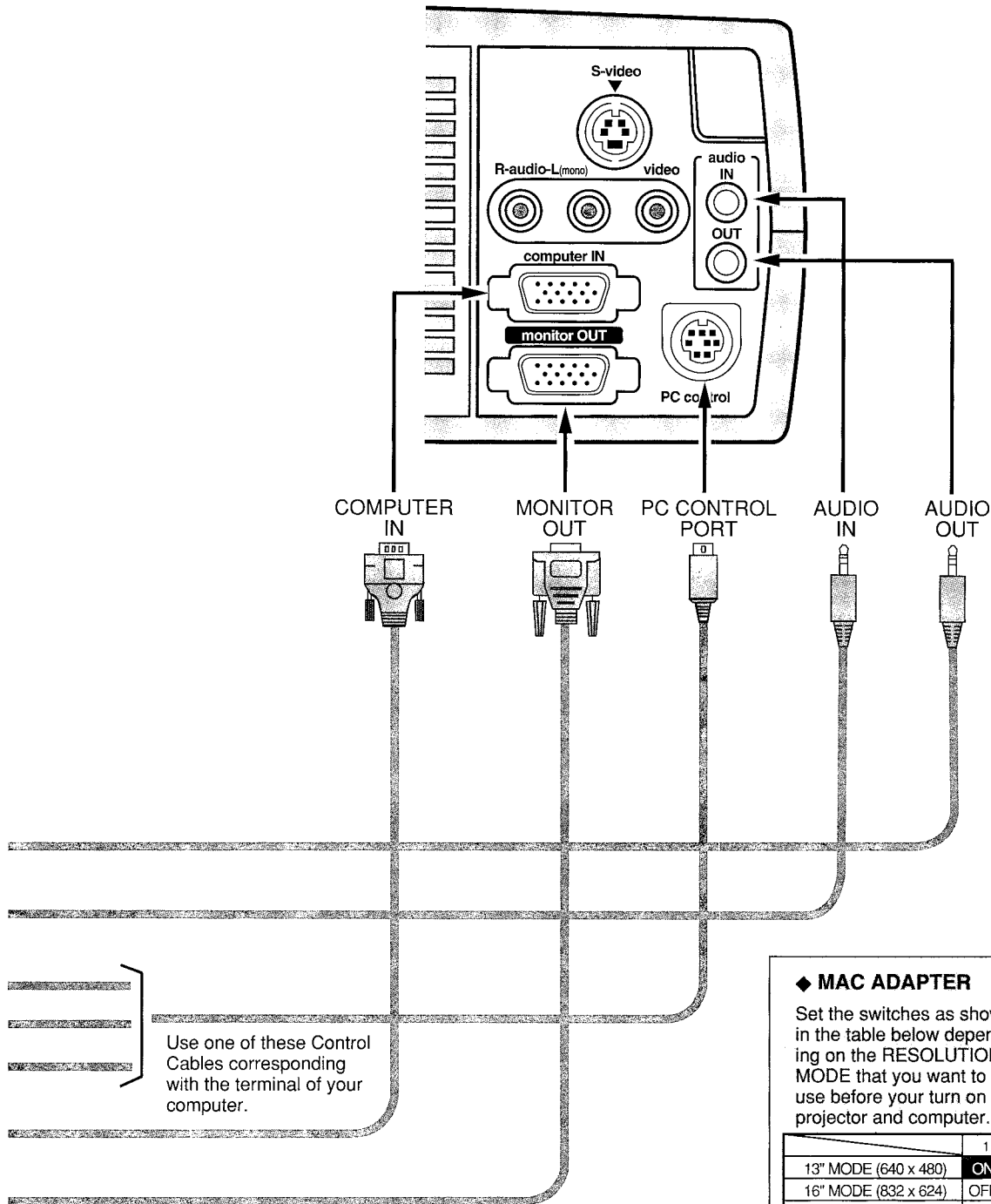

◆ MAC ADAPTER

Set the switches as shown in the table below depending on the RESOLUTION MODE that you want to use before your turn on the projector and computer.

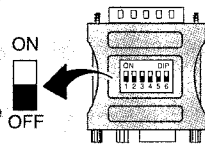

	1	2	3	4	5	6
13" MODE (640 x 480)	ON	ON	OFF	OFF	OFF	OFF
16" MODE (832 x 624)	OFF	ON	OFF	ON	OFF	OFF
19" MODE (1024 x 768)	OFF	ON	ON	OFF	OFF	OFF
21" MODE (1152 x 870)	ON	ON	ON	ON	OFF	OFF

BEFORE OPERATION

OPERATION OF THE REMOTE CONTROL

Left Side

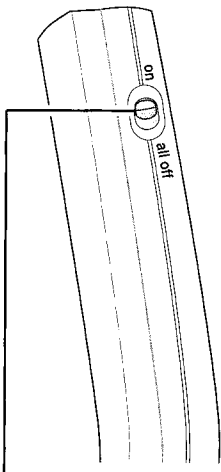

ALL-OFF SWITCH

When using the Remote Control Unit, turn this switch to "ON" and turn it "ALL OFF" when it is not used.

POWER ON-OFF BUTTON

Used to turn the projector on or off. (P19)

MENU BUTTON

Used to call MENU operation. (P17, 18)

SELECT BUTTON

Used to execute the item selected or to expand the image in DIGITAL ZOOM mode. (P28)
It is also used as a PC mouse in Wireless Mouse Operation. (P32)

LASER BUTTON

Used to operate the laser pointer function. The laser beam is emitted while pressing this button within 1 minute. When using the laser pointer for more than 1 minute, release the button and press it again.

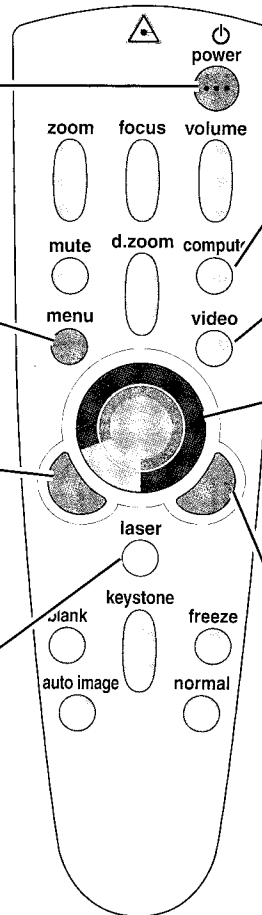

COMPUTER BUTTON

Used to select COMPUTER output source. (P22)

VIDEO BUTTON

Used to select VIDEO source. (P29)

POINT BUTTON

Used to move the pointer on the MENU, to adjust the item, or to pan the image in DIGITAL ZOOM mode. (P28)
It is also used as a PC mouse in Wireless Mouse Operation. (P32)

* When pressing the center of this button, it works as the SELECT button.

RIGHT CLICK BUTTON

Used to compress the image in DIGITAL ZOOM mode. (P28)
It is also used as a PC mouse in Wireless Mouse Operation. (P32)

Laser Pointer Function

This remote control emits a laser beam as the Laser Pointer from the Laser Light Window. When the LASER button is pressed, the laser light goes on. And when the button is pressed more than 1 minute or the button is released, light goes off. Laser light is emitted with the RED light which tells the laser beam being emitted. The laser emitted is a class II laser; therefore, do not look into the Laser Light Window or shine the laser beam on yourself or other people. The three marks bellow are the caution labels for the laser beam.

CAUTION : Use of controls or adjustments or performance of procedures other than those specified herein may result hazardous radiation exposure.

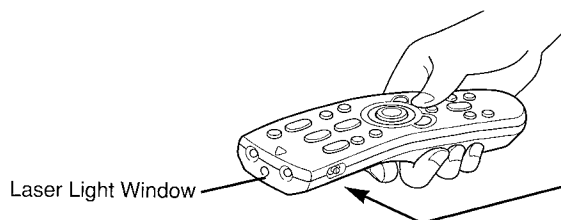

These caution labels are put on the remote control.

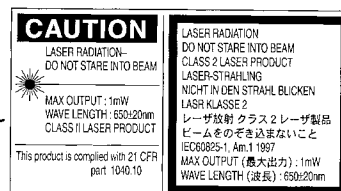

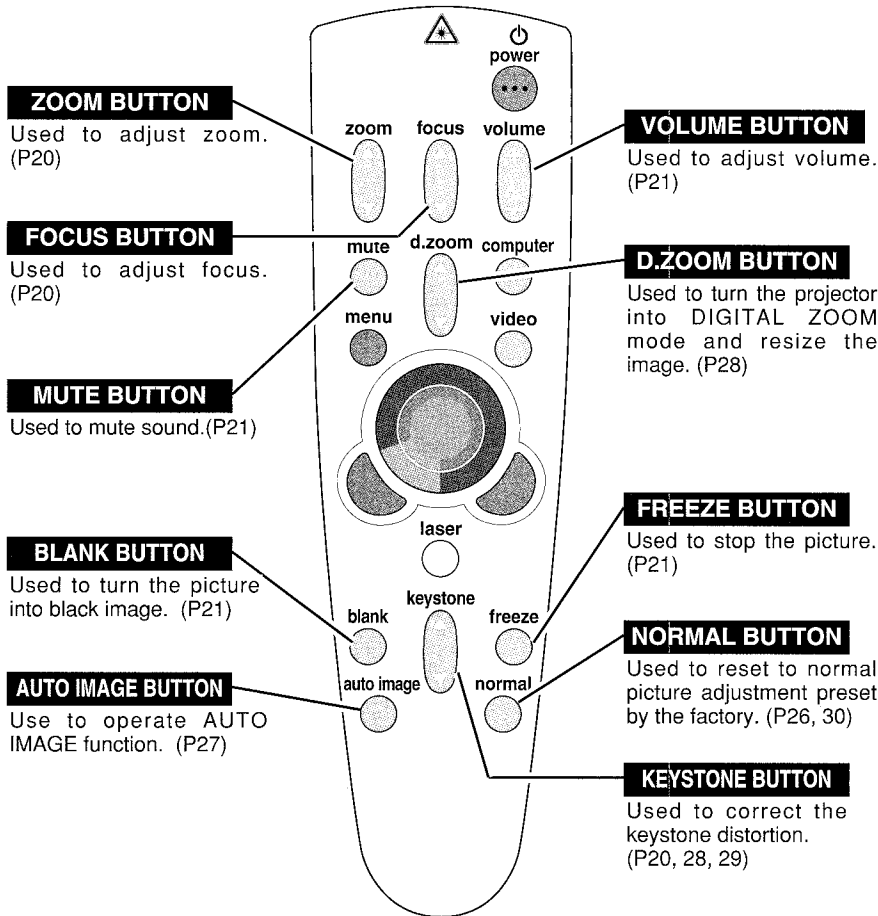

Operating Range

Point the remote control toward the projector (the Remote Receiver) whenever pressing the buttons. Maximum operating range for the remote control is about 16.4' (5m) and 60° front and rear of the projector

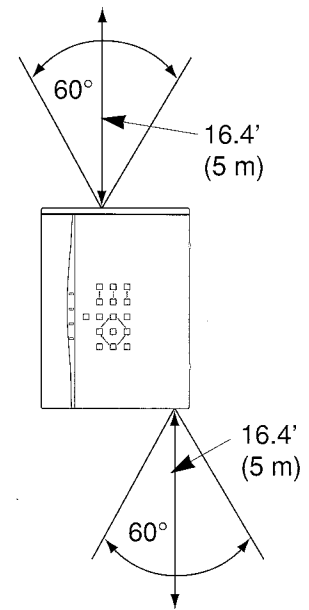

Remote Control Batteries Installation

1 Remove the battery compartment lid.

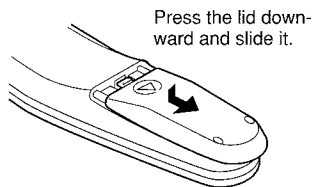

2 Slide the batteries into the compartment.

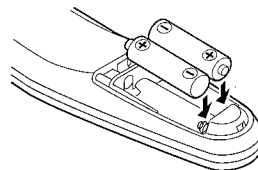

Two AA size batteries
For correct polarity (+ and -), be sure the battery terminals are in contact with the pins in the compartment.

3 Replace the compartment lid.

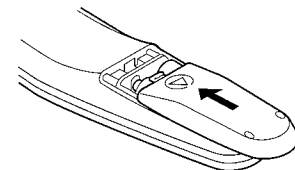

To insure safe operation, please observe the following precautions :

- Use (2) AA type alkaline batteries.
- Replace two batteries at the same time.
- Do not use a new battery with a used battery.
- Avoid contact with water or liquid.
- Do not expose the Remote Control Units to moisture, or heat.
- Do not drop the remote control unit.
- If batteries have leaked on the remote control, carefully wipe the case clean and load new batteries.

TOP CONTROLS AND INDICATORS

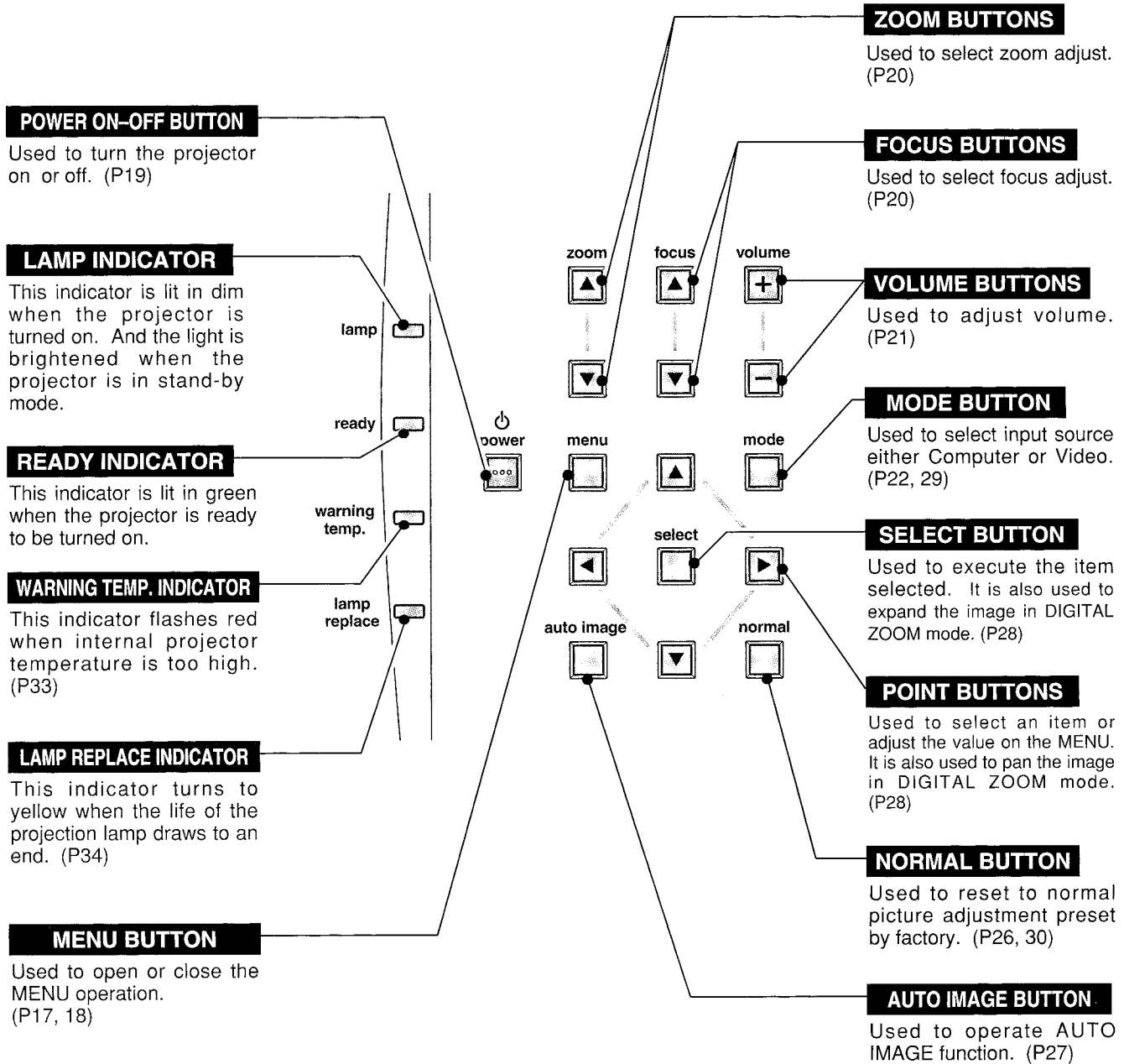

POWER ON-OFF BUTTON
Used to turn the projector on or off. (P19)

LAMP INDICATOR
This indicator is lit in dim when the projector is turned on. And the light is brightened when the projector is in stand-by mode.

READY INDICATOR
This indicator is lit in green when the projector is ready to be turned on.

WARNING TEMP. INDICATOR
This indicator flashes red when internal projector temperature is too high. (P33)

LAMP REPLACE INDICATOR
This indicator turns to yellow when the life of the projection lamp draws to an end. (P34)

MENU BUTTON
Used to open or close the MENU operation. (P17, 18)

ZOOM BUTTONS
Used to select zoom adjust. (P20)

FOCUS BUTTONS
Used to select focus adjust. (P20)

VOLUME BUTTONS
Used to adjust volume. (P21)

MODE BUTTON
Used to select input source either Computer or Video. (P22, 29)

SELECT BUTTON
Used to execute the item selected. It is also used to expand the image in DIGITAL ZOOM mode. (P28)

POINT BUTTONS
Used to select an item or adjust the value on the MENU. It is also used to pan the image in DIGITAL ZOOM mode. (P28)

NORMAL BUTTON
Used to reset to normal picture adjustment preset by factory. (P26, 30)

AUTO IMAGE BUTTON
Used to operate AUTO IMAGE function. (P27)

OPERATING ON-SCREEN MENU

HOW TO OPERATE ON-SCREEN MENU

You can control and adjust this projector through ON-SCREEN MENU. Refer to the following pages to operate the each adjustment on the ON-SCREEN MENU.

1 MOVING THE POINTER

Move the pointer (see the NOTE below) by pressing POINT button(S) on the TOP CONTROL or the REMOTE CONTROL.

2 SELECT THE ITEM

Select the item by pressing SELECT button.

NOTE : Pointer is the icon on the ON-SCREEN Menu to select the item. See the figures on the section "FLOW OF ON-SCREEN MENU" below.

WIRELESS REMOTE CONTROL

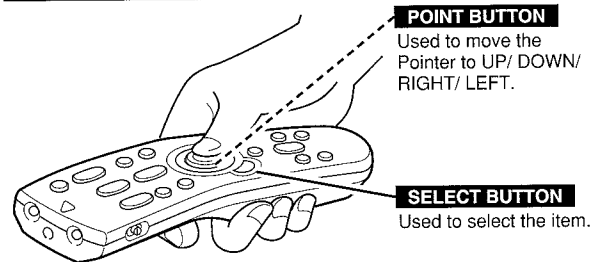

TOP CONTROL

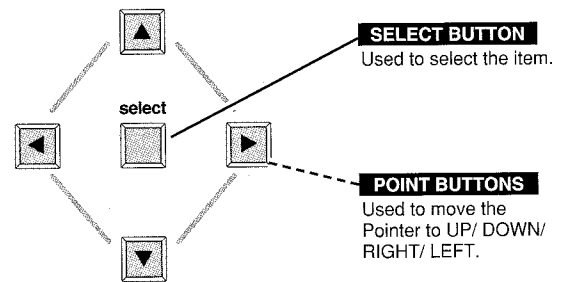

FLOW OF ON-SCREEN MENU

Display ON-SCREEN MENU

1 Press MENU button to display the ON-SCREEN MENU (MENU BAR). The red frame is the POINTER.

Select the Item

2 Move the POINTER (red frame) to the ITEM ICON that you want to select by pressing POINT RIGHT/ LEFT buttons.

3 Select the ITEM by pressing SELECT button. The dialog box of the ITEM appears.

Control and adjust through ON-SCREEN MENU

4 Move the POINTER downward by pressing POINT DOWN button. (The shape of POINTER become an arrow.)

5 Move the POINTER to the ITEM that you want to adjust and adjust the ITEM by pressing SELECT button. Refer to the following pages for details of respective adjustments.

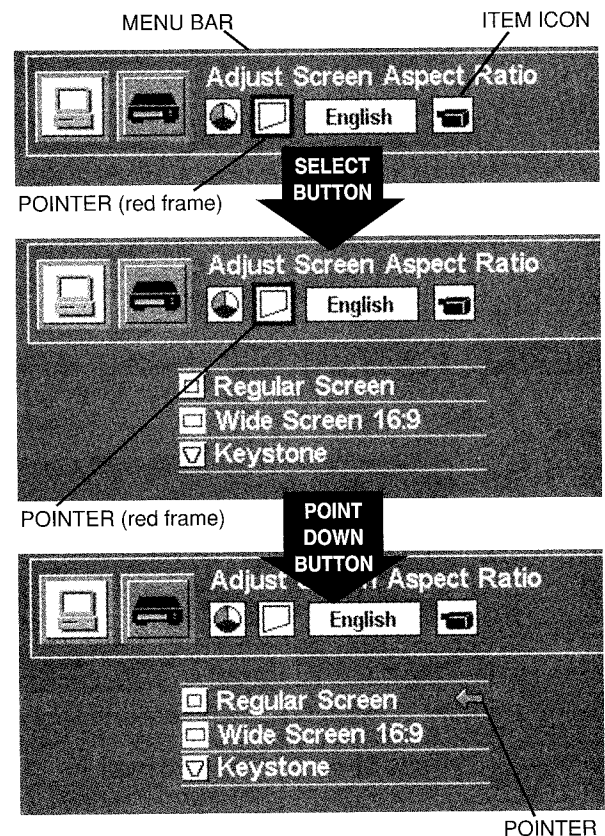

MENU BAR

Display ON-SCREEN MENU

Press MENU button to display the ON-SCREEN MENU (MENU BAR). The ON-SCREEN MENU appears at the left-upper side of the screen. Refer to the figure below for the details of the each function on the menu.

ON-SCREEN MENU

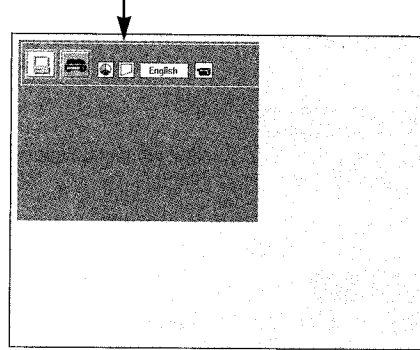

MENU BAR IN COMPUTER MODE

Press MENU BUTTON while being in Computer mode.

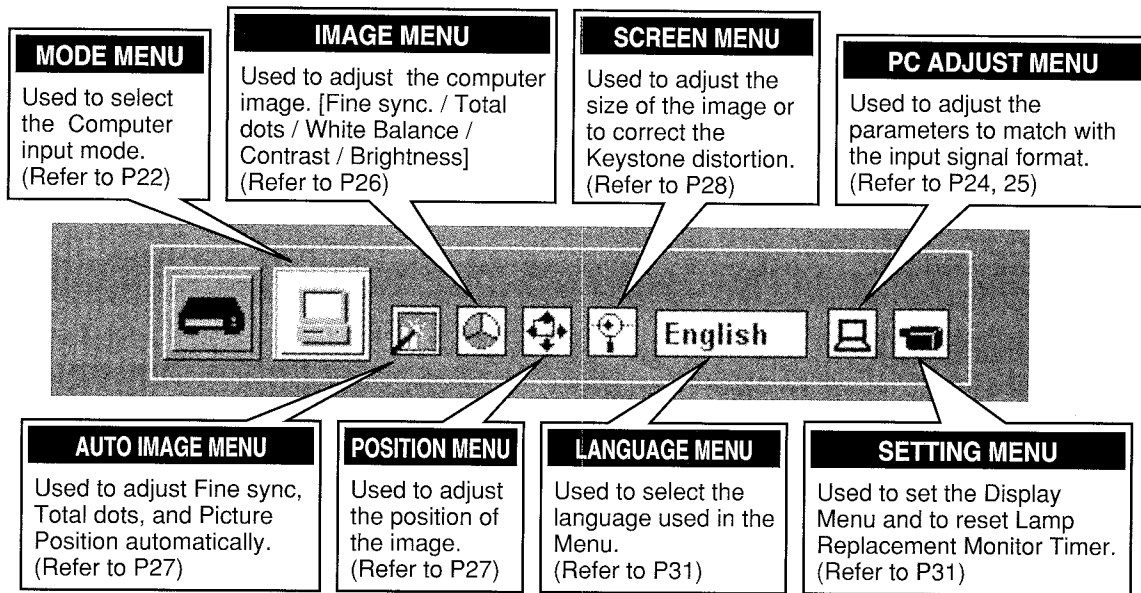

MENU BAR IN VIDEO MODE

Press MENU BUTTON while being in Video mode.

These icons have the same function as the Computer Mode.

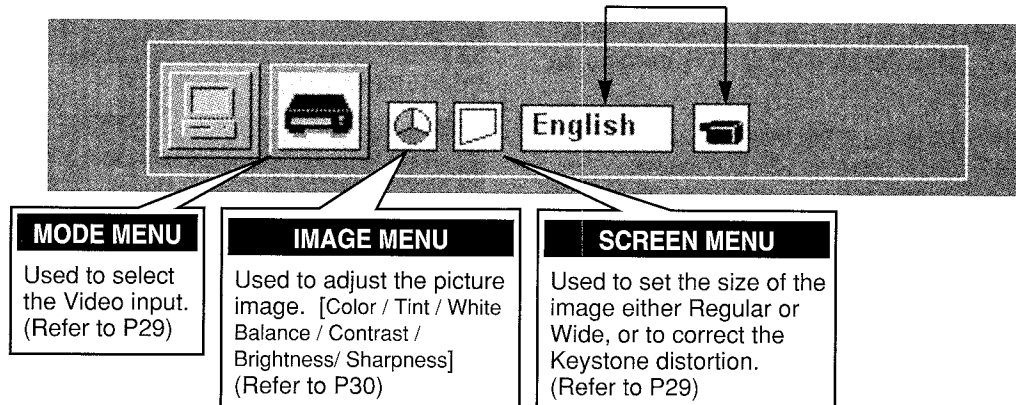

TURNING ON / OFF THE PROJECTOR

TURNING OF THE PROJECTOR

- 1 Complete the peripheral connections (with Computer, VCR, and etc.) before turning on the projector. (Refer to "CONNECTING TO THE PROJECTOR" on Pages 10~13 for connecting those equipment.)
- 2 Connect the projector's AC power cord into a wall outlet. The LAMP indicator lights RED, and the READY indicator lights GREEN.
- 3 Press the power ON-OFF button on the Remote Control Unit or on the Top Control to ON. The LAMP POWER indicator dims, and the Cooling Fans start to operate. The Preparation Display appears on the screen and the count-down starts. The signal from the source appears after 30 seconds.

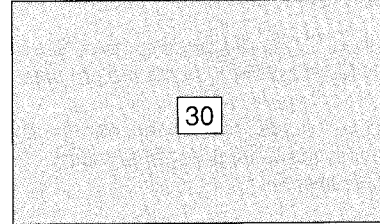

The Preparation Display disappears after 30 seconds.

TURNING OFF THE PROJECTOR

- 1 Press the power ON-OFF button on the Remote Control Unit or on the Top Control, and the message "Power off?" appears on the screen.
- 2 Press again the power ON-OFF button to turn off the projector. The LAMP indicator lights bright and the READY indicator turns off. The Cooling Fans operate for 90 seconds after the projector is turned off. (During this "Cooling Down" period, this appliance cannot be turned on.)
- 3 When the cooling the projector has finished, the READY indicator turns to green again and you can turn the projector on. After cooling down completely, disconnect the AC power cord.

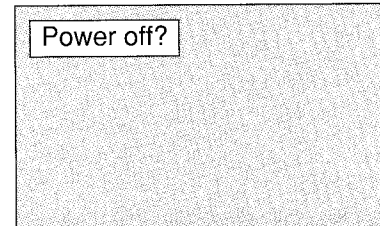

The message disappears after 4 seconds.



TO MAINTAIN THE LIFE OF THE LAMP, ONCE YOU TURN IT ON, WAIT AT LEAST 5 MINUTES BEFORE TURNING IT OFF.

When the TEMPERATURE WARNING indicator flashes red, the projector is automatically turned off. Wait at least 5 minutes before turning the projector on again.

If the TEMPERATURE WARNING indicator continues to flash, follow procedures below:

1. Disconnect the AC power cord from the AC outlet.
2. Check the air filters for dust accumulation.
3. Clean the Air Filter. (See "AIR FILTER CARE AND CLEANING" section on page 33.)
4. Press the power ON-OFF button to ON.

If the TEMPERATURE WARNING indicator still continues to flash, call your authorized dealer or service station.

NOTE: The Cooling Fan may work for cooling while the projector is turned off. When the Cooling Fan is working, TEMPERATURE WARNING INDICATOR flashes red.

ADJUSTING THE IMAGE

ZOOM ADJUSTMENT

- 1** Press the ZOOM ▲/▼ button(s) on the Top Control or on the Remote Control Unit to turn into the ZOOM mode.
- 2** Press the ZOOM ▲ button to have the image larger, and press the ZOOM ▼ button to have the smaller.

In the Computer mode, the image can be expanded, compressed, and panned with the Digital Zoom function. Refer to page 28 for the Digital Zoom operation.

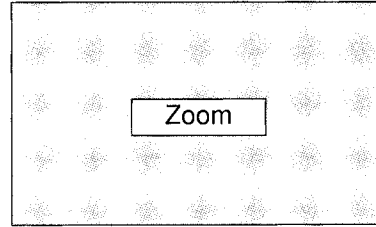

The message disappears after 4 seconds.

FOCUS ADJUSTMENT

- 1** Press the FOCUS ▲/▼ button(s) on the Top Control or on the Remote Control Unit to turn into the FOCUS mode.
- 2** Adjust the focus of the image by pressing the FOCUS ▲/▼ button.

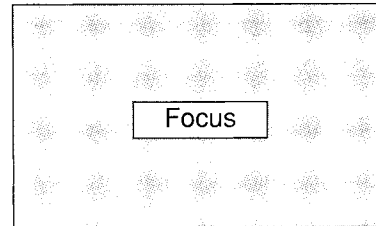

The message disappears after 4 seconds.

KEYSTONE ADJUSTMENT

If the picture obtained keystone distortion, correct screen with KEYSTONE adjustment.

- 1** Press the KEYSTONE ▲/▼ button on the Remote Control Unit or select the Keystone on the SCREEN menu. (Refer to page 28, 29.) The message "Keystone" is displayed.
- 2** Correct the Keystone distortion by pressing the KEYSTONE ▲/▼ button or the POINT UP/DOWN button(s). Press the KEYSTONE ▲ button or the POINT UP button to reduce the upper part of the image, and press the KEYSTONE ▼ button or the POINT DOWN button to reduce the lower part.

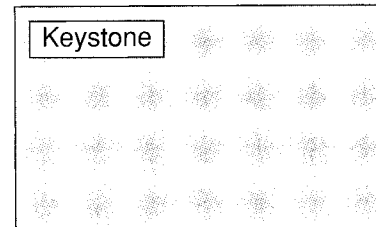

The message disappears after 4 seconds.

Reduce the upper width with the KEY STONE ▲ button or the POINT UP button.

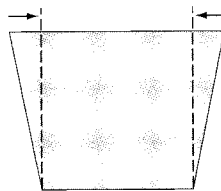

Reduce the lower width with the KEY STONE ▼ button or the POINT DOWN button.

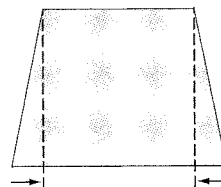

BLANK FUNCTION

Press the BLANK button on the Remote Control Unit to turn the picture into black image. This function is cancelled when the BLANK button is pressed again or any other function button is pressed.

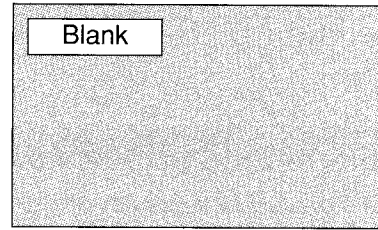

The message disappears after 4 seconds.

PICTURE FREEZE FUNCTION

Press the FREEZE button on the Remote Control Unit to turn the picture remained on-screen. This function is cancelled when the FREEZE button is pressed again or any other function button is pressed.

SOUND ADJUSTMENT

SOUND VOLUME ADJUSTMENT

Press the VOLUME (+/-) button(s) on the Top Control or on the Remote Control Unit to adjust the volume. The Volume dialog box appears on the screen for a few seconds.

The VOLUME (+) button to increase the volume, and the VOLUME (-) button for decreasing.

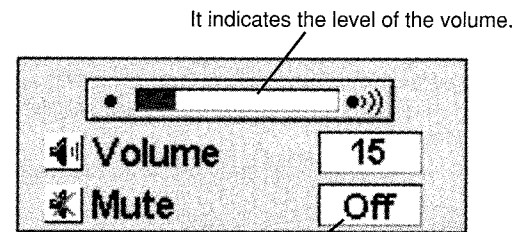

Press the MUTE button to set the Mute function On or Off.

The display disappears after 4 seconds.

SOUND MUTE ADJUSTMENT

Press the MUTE button on the Remote Control Unit to cut off the sound. To restore the sound to its previous level, press the MUTE button again or press the VOLUME (+/-) button(s).

COMPUTER MODE

SELECTING COMPUTER MODE AND SYSTEM

DIRECT OPERATION

Select COMPUTER mode by pressing the MODE button on the Top Control or the COMPUTER button on the Remote Control Unit.

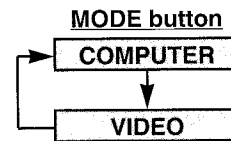

MENU OPERATION

Press the MENU button and the ON-SCREEN MENU will appear. Press the POINT LEFT/RIGHT buttons to select Computer Mode  and press the SELECT button.

CURRENT MODE DISPLAY

When selecting the Computer Mode, the Current Mode display appears. It shows the information of the computer of the mode selected.

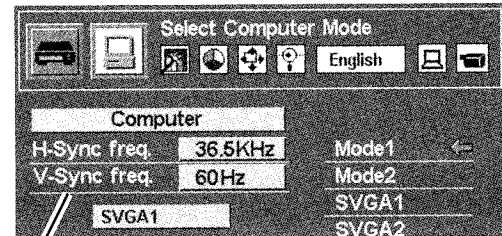

Providing the information of the computer detected by the projector.

SELECTING COMPUTER MODE AND SYSTEM

AUTOMATIC MULTISCANNING SYSTEM

This projector automatically tunes to most different types of computer based on VGA, SVGA, XGA, or SXGA (refer to "COMPATIBLE COMPUTER SPECIFICATION" on page 23). When selecting Computer, this projector automatically tunes to the incoming signal and projects the proper image without any special setting. (Setting of the Computer System may be required when connecting some computers.)

Note : The projector may provides the messages below.

Go to PC adj. The projector cannot discriminate or detect the input signal from the computer. Adjust and set the computer system manually. (Refer to page 24.)

No signal There is no signal input from the computer. Make sure the connection of the computer and the projector is set correctly. (Refer to TROUBLESHOOTING on page 35.)

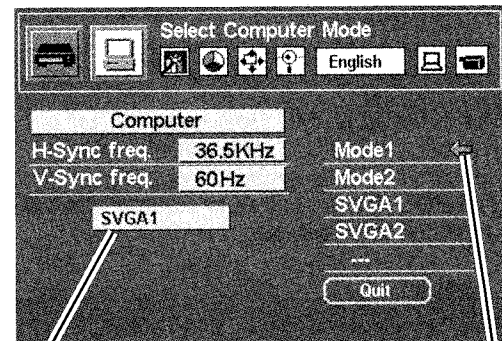

SYSTEM BOX
It displays the SYSTEM being selected.

The systems on this dialog box can be selected.

SELECT COMPUTER MODE MANUALLY

To set the Computer system manually, select the mode on the ON-SCREEN MENU.

- 1 Press the MENU button and the ON-SCREEN MENU will appear. Press the POINT LEFT/RIGHT buttons to select Computer Mode  and press the SELECT button. Another dialog box COMPUTER SYSTEM Menu will appear.
- 2 Press the POINT DOWN button and a red-arrow icon will appear. Move the arrow to the system that you want to set, and then press SELECT button.

COMPATIBLE COMPUTER SPECIFICATIONS

Basically this projector can accept the signal from all computers with the V, H-Frequency below mentioned and less than 140 MHz of Dot Clock.

ON-SCREEN DISPLAY	RESOLUTION	H-Freq. (kHz)	V-Freq. (Hz)	ON-SCREEN DISPLAY	RESOLUTION	H-Freq. (kHz)	V-Freq. (Hz)
VGA 1	640 x 480	31.47	59.88	XGA 10	1024 x 768	62.04	77.07
VGA 2	720 x 400	31.47	70.09	XGA 11	1024 x 768	61.00	75.70
VGA 3	640 x 400	31.47	70.09	XGA 12	1024 x 768 (Interlace)	35.522	43.48
VGA 4	640 x 480	37.86	74.38	XGA 13	1024 x 768	46.90	58.20
VGA 5	640 x 480	37.86	72.81	XGA 14	1024 x 768	47.00	58.30
VGA 6	640 x 480	37.50	75.00	XGA15	1024 x 768	58.03	72.0
VGA 7	640 x 480	43.269	85.00	MAC 19	1024 x 768	60.24	75.08
MAC LC13	640 x 480	34.97	66.60	MAC21	1152 x 870	68.68	75.06
MAC 13	640 x 480	35.00	66.67	SXGA 1	1152 x 864	64.20	70.40
RGB	640 x 480 (Interlace)	15.734	30	SXGA 2	1280 x 1024	62.50	58.60
RGB	768 x 576 (Interlace)	15.625	25	SXGA 3	1280 x 1024	63.90	60.00
SVGA 1	800 x 600	35.156	56.25	SXGA 4	1280 x 1024	63.34	59.98
SVGA 2	800 x 600	37.88	60.32	SXGA 5	1280 x 1024	63.74	60.01
SVGA 3	800 x 600	46.875	75.00	SXGA 6	1280 x 1024	71.69	67.19
SVGA 4	800 x 600	53.674	85.06	SXGA 7	1280 x 1024	81.13	76.107
SVGA 5	800 x 600	48.08	72.19	SXGA 8	1280 x 1024	63.98	60.02
SVGA 6	800 x 600	37.90	61.03	SXGA 9	1280 x 1024	79.976	75.025
SVGA 7	800 x 600	34.50	55.38	SXGA 10	1280 x 960	60.00	60.00
SVGA 8	800 x 600	38.00	60.51	SXGA 11	1152 x 900	61.20	65.20
SVGA 9	800 x 600	38.60	60.31	SXGA 12	1152 x 900	71.40	75.60
SVGA 10	800 x 600	32.70	51.09	SXGA 13	1280 x 1024 (Interlace)	50.00	43.00
SVGA 11	800 x 600	38.00	60.51	SXGA 14	1280 x 1024 (Interlace)	50.00	47.00
MAC1 6	832 x 624	49.72	74.55	SXGA 15	1280 x 1024	63.37	60.01
XGA 1	1024 x 768	48.36	60.00	SXGA 16	1280 x 1024	76.97	72.00
XGA 2	1024 x 768	68.677	84.997	SXGA 17	1152 x 900	61.85	66.00
XGA 3	1024 x 768	60.023	75.03	SXGA 18	1280 x 1024 (Interlace)	46.43	43.35
XGA 4	1024 x 768	56.47	70.07	SXGA 19	1280 x 1024	63.79	60.18
XGA 5	1024 x 768	60.31	74.92	MAC	1280 x 960	75.00	75.08
XGA 6	1024 x 768	48.50	60.02	MAC	1280 x 1024	80.00	75.08
XGA 7	1024 x 768	44.00	54.58	HDTV720p	1280 x 720	45.00	60.00
XGA 8	1024 x 768	63.48	79.35	HDTV1035i	1920 x 1035 (Interlace)	33.75	60.00
XGA 9	1024 x 768 (Interlace)	36.00	43.59	HDTV1080i	1920 x 1080 (Interlace)	33.75	60.00

NOTE : Specifications are subject to change without notice.

PC ADJUSTMENT

This Projector can automatically tune to the display signals from most personal computers currently distributed. However, some computers employ the special signal formats which are different from the standard ones and may not be tuned by Multiscanning of this projector. If this happens, the projector cannot reproduce a proper image and the image is recognized as a flickering picture, a non-synchronized picture, a non-centered picture or a skewed picture.

This projector has PC ADJUSTMENT function, to enable you to precisely adjust several parameters to match with those exceptional signal formats and the projector has five independent memory areas to memorize those parameters manually adjusted. This enables you to recall the setting for a specific computer whenever you use it.

- 1 Press the MENU button and the ON-SCREEN MENU will appear. Press the POINT RIGHT/LEFT buttons to select PC ADJUST  and press the SELECT button. Another dialog box "Setup Custom Mode" Menu will appear.
- 2 In this dialog box, you can store the parameter into the area from "Mode 1" to "Mode 5." When memorizing the new computer parameter, select the Mode with the message of "Free" by pressing the POINT UP/DOWN buttons and the SELECT button. To change the parameters of the Mode previously set, select the Mode with "Stored."
- 3 When the Mode is selected, Parameter adjustment dialog box appears. Move the arrow to the item that you want to change by pressing the POINT UP/DOWN buttons, and adjust the each item to match with your computer. To change the value, press either the POINT RIGHT button or the POINT LEFT button. Refer to the next page for adjusting each item.
- 4 Move the arrow to "Stored" and press the SELECT button. The parameter is memorized in the selected Mode.
- 5 To activate the Mode manually adjusted in this PC ADJUSTMENT Menu, select the Mode at the SYSTEM SELECT Menu. (Refer to page 22.)

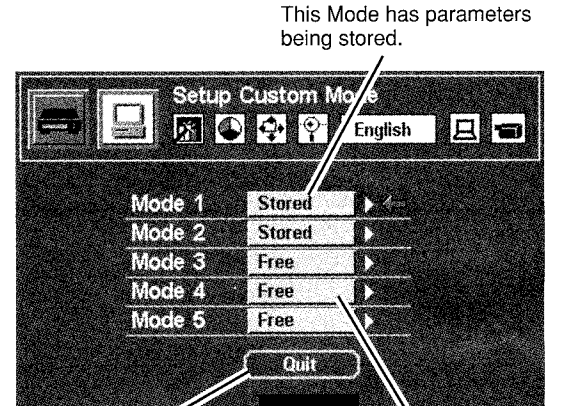

Close the PC ADJUSTMENT Menu.

The Vacant Mode.

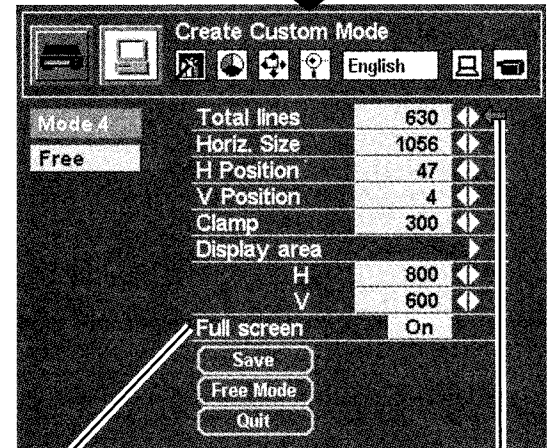

Press the SELECT button to set Full screen function on/off.

Press the POINT RIGHT/LEFT button(s) to adjust the value.

Total lines

The number of the total vertical lines. Adjust the number to match the image of your personal computer.

Horiz. size

The number of the total dots in one horizontal period. Adjust the number to match the image of your personal computer.

H Position / V Position

Adjustment of the horizontal or vertical picture position. When the image is not centered on the screen, adjust each of those items.

Clamp

Adjustment of the clamp level. When the image has a dark bar(s), try this adjustment.

Display area

Adjustment of the area displayed with this projector. Select the resolution at the Display area dialog box, or adjust the number at the column of "H" or "V" to match the resolution of the image.

Full Screen

Set "On" to resize the image with 4 x 3 aspect ratio to fit the screen.

Each of the keys operates as follow.

Free mode Clears the parameter data previously set in the selected Mode.

Save Stores the parameters in the memory.

Quit Closes the PC ADJUST Menu.

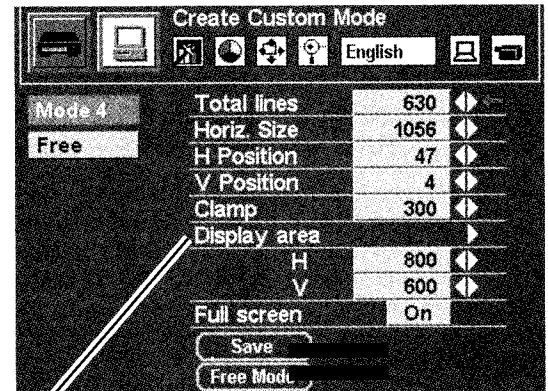

Press the SELECT button to select the typical resolution of the image.

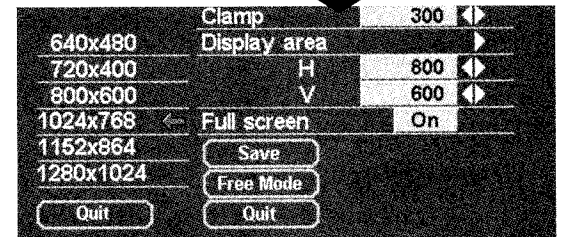

ADJUST PICTURE IMAGE MANUALLY

- 1 Press the MENU button and the ON-SCREEN MENU will appear. Press the POINT LEFT/RIGHT buttons to select IMAGE  and press the SELECT button. Another dialog box PICTURE IMAGE ADJUSTMENT Menu will appear.
- 2 Press the POINT DOWN button and a red-arrow icon will appear. Move the arrow to the item that you want to change by pressing the POINT UP/DOWN buttons. To change the value, press either the POINT RIGHT button or the POINT LEFT button.

Brightness

Press POINT LEFT button to adjust the image darker, and press POINT RIGHT button to adjust brighter. (From 0 to 63.)

Contrast

Press POINT LEFT button to adjust the image lighter, and press POINT RIGHT button to adjust deeper. (From 0 to 63.)

Fine sync

Adjust the picture as necessary to eliminate flicker from the display. (From 0 to 255.)

Horiz. size

The number of the total dots in one horizontal period. Adjust the number to match your PC image.

Color balance (Red / Green / Blue)

Move the arrow to Red, Green, or Blue that you want to adjust. Press POINT LEFT button to adjust the color of image lighter, and press POINT RIGHT button to adjust deeper. (From 0 to 63.)

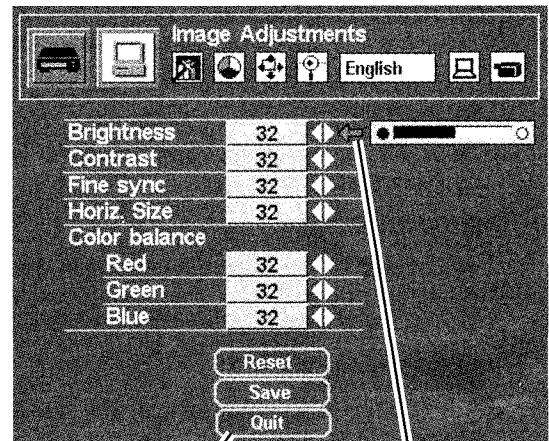

Close the PICTURE IMAGE ADJUSTMENT Menu.

Move the arrow to the item and press POINT RIGHT / LEFT button.

Each of the keys operates as follow.

Reset Recalls the data previously adjusted.

Save Stores the adjusted data in the memory.

Quit Closes the PICTURE IMAGE ADJUSTMENT Menu.

NORMAL FUNCTION

The normal picture level is preset on this projector at the factory and can be restored anytime you press the NORMAL button (located on the Top Control or on the Remote Control Units). The "Normal" display will be displayed on the screen for a few seconds.

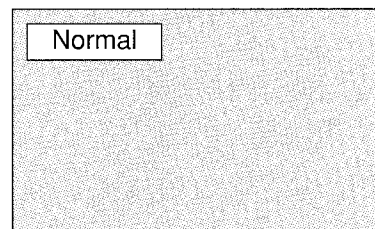

AUTO IMAGE FUNCTION

The Auto Image function is provided to automatically adjust Fine sync., Total dots, and Picture Position for most computers.

- 1 Press the MENU button and the ON-SCREEN MENU will appear. Press the POINT LEFT/RIGHT buttons to select AUTO IMAGE  and press the SELECT button. Another dialog box AUTO IMAGE Menu will appear.
- 2 Move the arrow to "Start" by pressing the POINT UP/DOWN button, and then press the SELECT button to start the Auto Image Adjustment. And this adjustment can be executed by pressing AUTO IMAGE button on the Top Control and the Remote Control Unit.

NOTE : The Fine sync., Total dots, and Picture Position of some computers may not be fully adjusted with the Auto Image Function. In that case, manual adjustment is required to make fine image. (Refer to page 26 to adjust "Fine sync." or "Total dots" and page 27 to adjust Picture Position.)

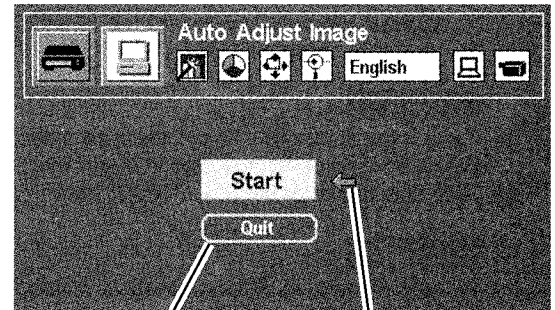

It terminates the PICTURE IMAGE ADJUSTMENT Menu.

Move the arrow to "Start" and then press the SELECT button.

PICTURE POSITION ADJUSTMENT

The position of the image can be adjusted vertically and horizontally through PICTURE POSITION ADJUSTMENT.

- 1 Press the MENU button and the ON-SCREEN MENU will appear. Press the POINT LEFT/RIGHT buttons to select POSITION  and press the SELECT button. The PICTURE POSITION dialog box will appear.
- 2 Move the image by pressing the POINT UP / DOWN / RIGHT / LEFT buttons.

To cancel POSITION mode, press the any buttons except SELECT, RIGHT CLICK, POINT or LASER button. To recall the position previously adjusted, press NORMAL button.

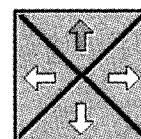
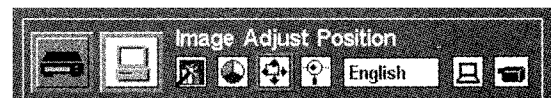

PICTURE POSITION dialog box

Press the POINT UP / DOWN / RIGHT / LEFT buttons to move the image

PICTURE SCREEN ADJUSTMENT

This projector has a picture screen resize function, which enables you to display the image in desirable size.

- 1 Press the MENU button and the ON-SCREEN MENU will appear. Press the POINT LEFT/RIGHT buttons to select SCREEN  and press the SELECT button. Another dialog box PICTURE SCREEN Menu will appear.
- 2 Press the POINT DOWN button and a red-arrow icon will appear. Move the arrow to the function that you want to select and then press SELECT button.

True

To turn the image into its original size select True in the dialog box. When the original image size is larger than the screen size (1024 x 768), this projector becomes Digital Zoom mode automatically.

Keystone

When the image is distorted vertically, select Keystone in the dialog box. The ON-SCREEN menu and SCREEN ADJUST menu disappears and the message "Keystone" is displayed. Correct the Keystone distortion by pressing the KEYSTONE ▲/▼ button or the POINT UP/DOWN button(s). Refer to KEYSTONE ADJUSTMENT on page 20.

Digital zoom

To adjust the image size or pan the image, select Digital zoom in the dialog box. The ON-SCREEN menu and SCREEN ADJUST menu disappears and the message "D. Zoom" is displayed. This projector is also turned into Digital Zoom mode by pressing the D.ZOOM ▲/▼ button on the Remote Control Unit. Refer to the following for operation.

Expand function

To expand the image size, press the D.ZOOM ▲ button or the SELECT button. The image is magnified by degrees.

Compress function

To compress the image size, press the D.ZOOM ▼ button or the RIGHT CLICK button. The size of image is reduced by degrees.

Panning function

To pan the image, press the POINT UP/DOWN/LEFT/RIGHT buttons. Panning function can work only when the image is larger than the screen size.

To cancel Digital Zoom mode, press the any buttons except D.ZOOM ▲/▼, SELECT, RIGHT CLICK, POINT or LASER button. To adjust the image to the screen size (1024 x 768), press NORMAL button.

- This projector cannot display in the resolution higher than 1280 X 1024. If your computer's screen resolution is higher than 1280 X 1024, reset the resolution to the lower before connecting the projector.
- The image data in other than XGA (1024x 768) is modified to fit the screen size in the initial mode.
- The normal "Panning Operation" may not function properly if the computer system prepared with the "PC Adjust" is used.

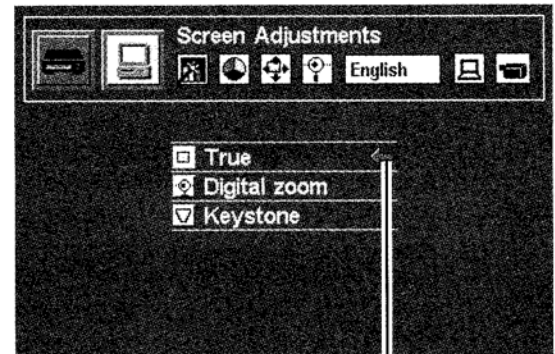

Move the arrow to the function and press the SELECT button.

VIDEO MODE

SELECTING VIDEO MODE

DIRECT OPERATION

Select VIDEO mode by pressing the MODE button on the Top Control or the VIDEO button on the Remote Control Unit.

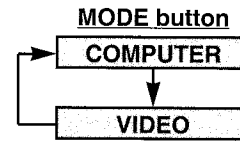

MENU OPERATION

Press the MENU button and the ON-SCREEN MENU will appear. Press the POINT LEFT/RIGHT buttons to select Video  and press the SELECT button.

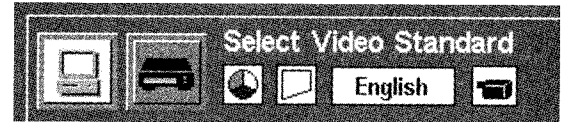

SELECTING COLOR SYSTEM

1 Press the MENU button and the ON-SCREEN MENU will appear. Press the POINT LEFT/RIGHT buttons to select Video Mode  and press the SELECT button. Another dialog box VIDEO SYSTEM Menu will appear.

2 Press the POINT DOWN button and a red-arrow icon will appear. Move the arrow to "Auto", and then press the SELECT button.

Auto

The projector automatically detects the incoming Video system, and adjusts itself to optimize its performance.

When the Video System is PAL-M or PAL-N, select the system manually.

PAL / SECAM / NTSC / NTSC4.43 / PAL-M / PAL-N

If the projector cannot reproduce the proper video image, it is required to select a specific broadcast signal format among PAL, SECAM, NTSC, NTSC 4.43, PAL-M, or PAL-N.

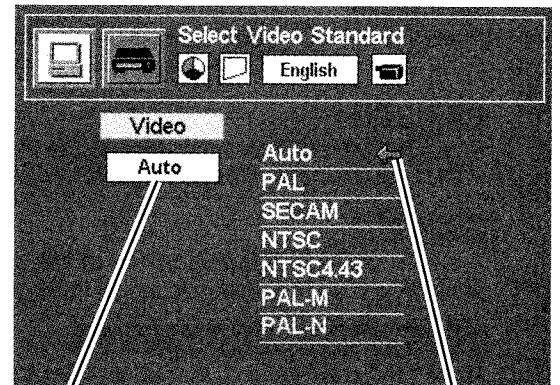

This box indicates the system being selected.

Move the arrow to the Mode and press the SELECT button.

PICTURE SCREEN ADJUSTMENT

This projector has a picture screen resize function, which enables you to display the image in desirable size.

1 Press the MENU button and the ON-SCREEN MENU will appear. Press the POINT LEFT/RIGHT buttons to select SCREEN  and press the SELECT button. Another dialog box PICTURE SCREEN ADJUSTMENT DISPLAY will appear.

2 Press the POINT DOWN button and a red-arrow icon will appear. Move the arrow to the screen size that you want to set, and then press the SELECT button.

Regular Screen

Normal Video Image size with 4 x 3 aspect ratio.

Wide Screen 16:9

Resizes the image for wide screen size with 16 x 9 aspect ratio.

Keystone

When the image is distorted vertically, select Keystone in the dialog box. Correct the Keystone distortion by pressing KEYSTONE ▲/▼ button or POINT UP/DOWN button(s). Refer to KEYSTONE ADJUSTMENT on page 20.

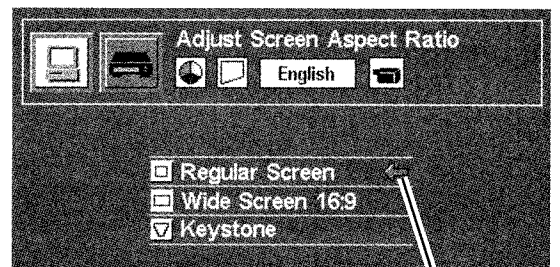

Move the pointer to the function that and press the SELECT button.

PICTURE IMAGE ADJUSTMENT

ADJUSTING THE PICTURE IMAGE

- 1 Press the MENU button and the ON-SCREEN MENU will appear. Press the POINT LEFT/RIGHT buttons to select IMAGE  and press the SELECT button. Another dialog box PICTURE IMAGE ADJUSTMENT Menu will appear.
- 2 Press the POINT DOWN button and a red-arrow icon will appear. Move the arrow to the item that you want to adjust by pressing the POINT UP/DOWN buttons. To change the value, press either the POINT RIGHT button or the POINT LEFT button.

Brightness

Press POINT LEFT button to adjust the image darker, and press POINT RIGHT button to adjust brighter. (From 0 to 63.)

Contrast

Press POINT LEFT button to adjust the image lighter, and press POINT RIGHT button to adjust deeper. (From 0 to 63.)

Color

Press POINT LEFT button to adjust the image lighter, and press POINT RIGHT button to adjust deeper. (From 0 to 63.)

Tint

Press POINT LEFT button to adjust the color more purple, and press POINT RIGHT button to adjust more green. (From 0 to 63.)

Color balance (Red / Green / Blue)

Move the arrow to Red, Green, or Blue that you want to adjust. Press POINT LEFT button to adjust the color of image lighter, and press POINT RIGHT button to adjust deeper. (From 0 to 63.)

Sharpness

Press POINT LEFT button to adjust the image softer, and press POINT RIGHT button to adjust sharper. (From 0 to 63.)

Each of the keys operates as follow.

- Reset** Recalls the data previously adjusted.
- Save** Stores the data in the memory.
- Quit** Closes the PICTURE IMAGE ADJUSTMENT Menu.

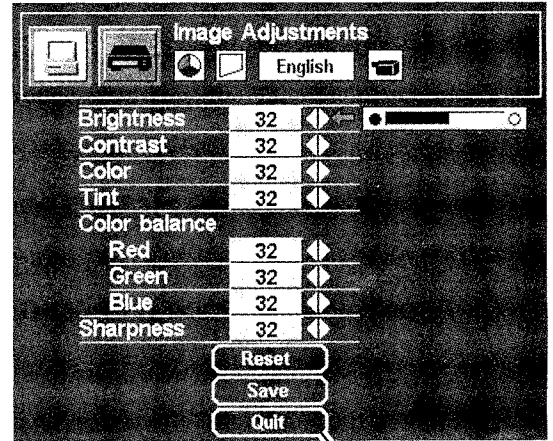

Close the PICTURE IMAGE ADJUSTMENT Menu.

NORMAL FUNCTION

The normal picture level is preset on this projector at the factory and can be restored anytime you press the NORMAL button (located on the Top Control or on the Remote Control Unit). The "Normal" display will be displayed on the screen for a few seconds.

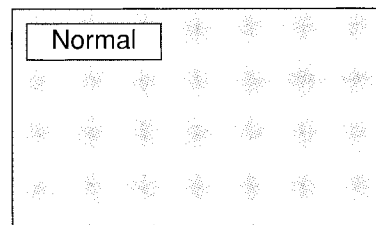

SETTING MENU

- 1 Press the MENU button and the ON-SCREEN MENU will appear. Press the POINT LEFT/RIGHT buttons to select SETTING  and press the SELECT button. Another dialog box SETTING Menu will appear.
- 2 Press the POINT DOWN button and a red-arrow icon will appear. Move the arrow to the item that you want to set, and then press the SELECT button to set it "On" or "Off".

Blue background When this function is in the "On" position, this projector will produce a blue image instead of the video noise on the screen when the input source is unplugged or turned off.

Display When this function is in the "On" position, the On-Screen Displays always appear when adjustments are made. (The following displays disappear by switching this function "Off.")

- Preparation Display
(The Number-counting-down Display)
- Mode Display
- Volume/Mute Display
- Zoom Display
- Focus Display
- Normal Display
- Blank Display
- Keystone Display
- D.Zoom Display

Ceiling When this function is in the "On" position, the top / bottom and the left / right reversed picture is provided to project the image from a ceiling mounted projector.

Rear When this function is in the "On" position, the left / right reversed picture is provided to project the image to a rear projection screen.

Curtain Turn this function "On" position in the SETTING menu. The picture will change into next one by sliding black image side ways like drawing the black curtains when the input source is turned into another one.

Lamp age The Lamp age function is designed to reset the lamp replacement monitor timer. When replacing the lamp, reset the lamp replacement monitor timer by using this function. (Refer to page 34.)

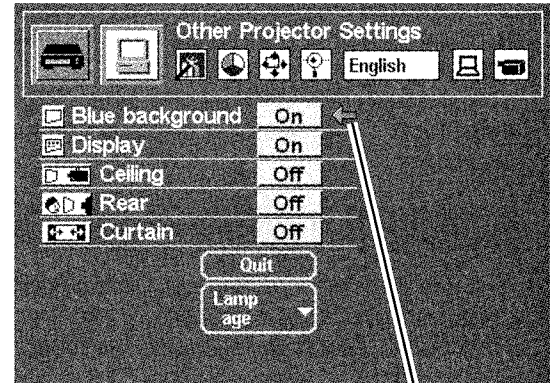

Set the Pointer to the item, and then press the SELECT button.

Ceiling function

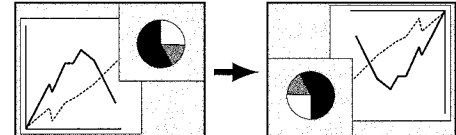

Rear function

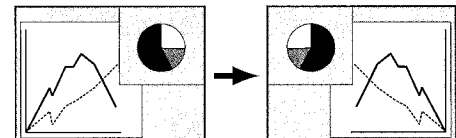

SELECTING LANGUAGE

The language used in the ON-SCREEN MENU is selectable from among English, German, French, Italian, Spanish and Japanese.

- 1 Press the MENU button and the ON-SCREEN MENU will appear. Press POINT LEFT/RIGHT buttons to select LANGUAGE  and press the SELECT button. Another dialog box LANGUAGE Menu will appear.
- 2 Press the POINT DOWN button and a red-arrow icon will appear. Move the arrow to the language that you want to set, and then press the SELECT button.



Move the Pointer to the language that you want to set, and then press the SELECT button.

OPERATING WIRELESS MOUSE

The Wireless Remote Control Unit is not only able to operate the projector but also usable as a wireless mouse for most Personal Computers. The POINT buttons and the two CLICK buttons are used for the wireless mouse operation.

The wireless mouse is usable when PC mouse pointer is displayed on the screen. When the menu or the indicator of the projector is displayed on the screen instead of the PC mouse pointer, the wireless mouse cannot be used.

INSTALLATION

To use the Wireless Remote Control Unit as the Wireless Mouse for a Personal Computer, installation of the mouse driver (not supplied) is required. Make sure that the mouse driver is properly installed in your computer. And make sure that the mouse port of the computer connected to Control Port is activated.

- 1** Connect the mouse port of your computer to the Control Port of the projector with the Control Cable. (Refer to page 10 to 13 for connection.)
- 2** Turn the projector on first, and then turn on your computer. When the computer is switched on first, the Wireless Mouse may not work properly.

Note : When the computer has no mouse port, connect the Serial Port of the computer to Control Port of the projector with the Control Cable for Serial Port.

OPERATING WIRELESS MOUSE

When controlling the pointer of the computer, operate the Wireless Mouse with POINT button, SELECT button, and RIGHT CLICK button on the Wireless Remote Control Unit.

POINT button

Used to move the pointer. The pointer is moved corresponding with the direction you are pressing.

SELECT (LEFT CLICK) button

This button has the same function as the left button in a PC mouse.

RIGHT CLICK button

This button has the same function as the right button in a PC mouse. Pressing this button does not affect any operation when in Menu mode.

POINT button (Move the pointer)

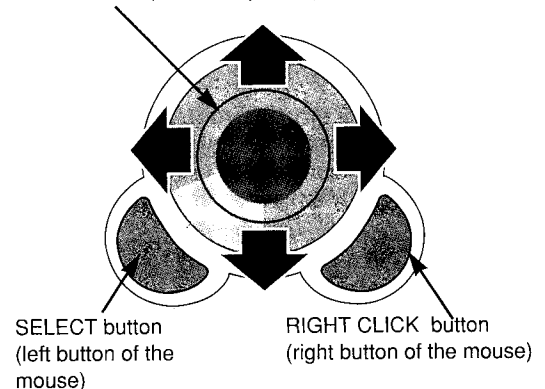

MAINTENANCE

TEMPERATURE WARNING INDICATOR

The TEMPERATURE WARNING Indicator flashes red when the internal temperature of the projector exceeds the normal temperature. The Indicator stops flashing when the temperature of the projector become normal. When the TEMPERATURE WARNING Indicator continues to flash, check the item listed below.

- 1 The Ventilation slots of the projector may be blocked. In such an event, reposition the appliance so that the ventilation slots are not obstructed.
- 2 Air filters are clogged with dust particles. Cleaning the air filters by following AIR FILTER CARE AND CLEANING below.
- 3 If the TEMPERATURE WARNING Indicator remains on after performing the above checks, the Cooling Fans or the Internal Circuits may be malfunctioning. Request service from an authorized dealer or service station.

AIR FILTER CARE AND CLEANING

The Removable Air Filters prevent dust from accumulating on the surface of the Projection Lens and the Projection Mirror. Should the Air Filters become clogged with dust particles, it will reduce the Cooling Fans' effectiveness and may result in internal heat build up and adversely affect on the life of the projector. Clean the Air Filters following the steps below:

- 1 Turn the power off, and disconnect the AC power cord from the AC outlet.
- 2 Turn the projector upside down and remove the Air Filters by pulling the latches of them upward.
- 3 Clean the Air Filters with brush or wash out the dust and particles.
- 4 Replace the Air Filter. Make sure that the Air Filters are fully inserted.



CAUTION

Do not operate the projector with the Air Filter removed. The dust is stuck on the LCD Panel and the Mirror, and it may spoil the fine picture image. Do not put the small parts into the Air Intake Vents. It result in the malfunction of the projector. The Air Filter is small part. Take care that children don't eat or swallow it.

AIR FILTERS

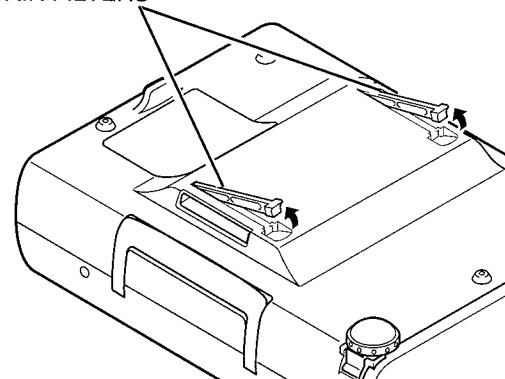

RECOMMENDATION

We recommend to avoid dusty/smoky place for operating the projector. Using in dusty place may cause the picture of poor quality.

When using under the dusty or smoky conditions, dust may accumulate on the liquid crystal panel and lens inside it, and may resultantly be projected on the screen together with the picture. When the above symptoms are noticed, contact your authorized dealer or service station for the cleaning.

CLEANING THE PROJECTION LENS

Follow these steps to clean the projection lens:

- 1 Apply a non-abrasive camera lens cleaner to a soft, dry cleaning cloth. Avoid using an excessive amount of cleaner. Abrasive cleaners, solvents or other harsh chemicals might scratch the lens.
- 2 Lightly wipe the cleaning cloth over the lens.
- 3 When you don't use the projector, replace the lens cover.

LAMP REPLACEMENT INDICATOR

When the life of the Lamp of this projector draws to an end, the LAMP REPLACEMENT indicator lights yellow. When the image becomes dark or the color of the image become unnatural, replacement of the Lamp is required.

LAMP REPLACEMENT



CAUTION

- For continued safety, replace with a lamp assembly of the same type.
- Allow the projector to cool for at least 45 minutes before you open the lamp cover. The inside of the projector can become very hot.
- Do not drop the lamp assembly or touch the glass bulb! The glass can shatter and may cause injury.

Follow these steps to replace the lamp assembly.

- 1** Turn off the projector and disconnect the AC plug. Allow the projector to cool for at least 45 minutes.
- 2** Remove a screw with a screwdriver and remove the Lamp Cover.
- 3** Remove 2 screws with a screwdriver and pull out the Lamp Assembly by grasping the handle.
- 4** Replace the Lamp Assembly with new one and tighten 2 screws. Make sure that the Lamp Assembly is set properly. And replace the Lamp Cover and tighten a screw.
- 5** Connect the AC Power Cord to the projector and turn the projector on.
- 6** Reset the Lamp Replacement Monitor Timer (refer to the section "Lamp Replacement Monitor Timer" below).

NOTE : Do not reset the LAMP REPLACEMENT MONITOR TIMER, when the lamp is not replaced.

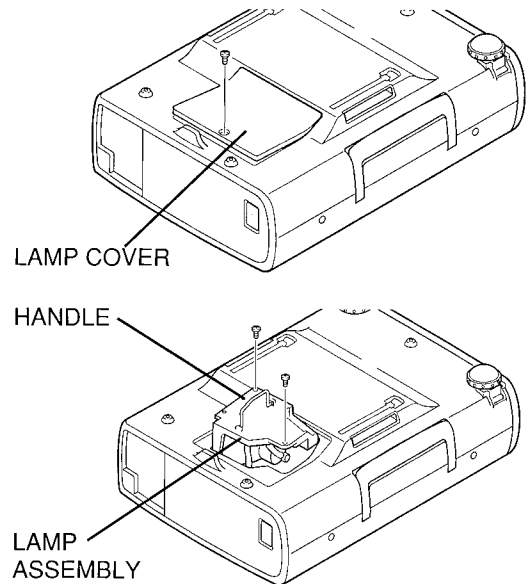

ORDER REPLACEMENT LAMP

Replacement Lamp can be ordered through your dealer. When ordering the Lamp, give the following information to the dealer.

- Model No. of your projector : ULTRALIGHT LX2
- Replacement Lamp Type No. : POA-LMP21J (Proxima Lamp No. : LAMP-019)
(Service Parts No. 610 280 6939)

LAMP REPLACEMENT MONITOR TIMER

Be sure to reset the Lamp Replacement Monitor Timer when the Lamp Assembly is replaced. When the Lamp Replacement Monitor Timer is reset, the LAMP REPLACEMENT indicator stops lighting.

- 1** Turn the projector on, and press the MENU button and the ON-SCREEN MENU will appear. Press the POINT LEFT/RIGHT buttons to select SETTING  and press the SELECT button (refer to the page 31). Another dialog box SETTING MENU will appear.
- 2** Press the POINT DOWN button and a red-arrow icon will appear. Move the arrow to Lamp age, and then press the SELECT button. The message "Lamp replace monitor Reset?" is displayed.
- 3** Select [Yes] to reset the Timer.

Do not reset the Lamp Replacement Monitor Timer, except after the lamp is replaced.

TROUBLESHOOTING

Before calling your dealer or service station for assistance, check the matters below once again.

1. Make sure you have connected the projector to your equipment as described in section "CONNECTING THE PROJECTOR" on pages 10 ~ 13.
2. Check cable connection. Verify that all computer, video and power cord are properly connected.
3. Verify that all power is switched on.
4. If the projector still does not produce the image, re-start the computer.
5. If the image still does not appear, unplug the projector from the computer and check the computer monitor's display. The problem may be with your graphics controller rather than with the projector. (When you reconnect the projector, remember to turn the computer and monitor off before you power up the projector. Power the equipment back in order of : Projector and computer.)
6. If the problem still exists, check with following chart.

Problem:	Try these Solution
No power.	<ul style="list-style-type: none"> ● Plug the projector into the AC outlet. ● Be sure READY Indicator light is On. ● Wait 90 seconds after the projector is turned OFF before turning the projector back on. <p>NOTE : After pressing the power ON-OFF switch to OFF, make sure the projector works as follow.</p> <ol style="list-style-type: none"> 1. The LAMP indicator will light and the READY indicator will turn off. 2. After 90 seconds, the READY indicator will light green again and the projector may be turned on by pressing the power ON-OFF button. <ul style="list-style-type: none"> ● Check the TEMPERATURE WARNING indicator. If the indicator flashes red, the projector cannot be turned on. (See "TURNING ON/OFF THE PROJECTOR" section on page 19.) ● Check the Projection Lamp. (Refer to the page 34.)
Image is out of focus.	<ul style="list-style-type: none"> ● Adjust the focus ● Make sure the projection screen is at least 4.6' (1.4m) from the projector. ● Check the projection lens to see if it needs cleaning. <p>NOTE : Moving the projector from a cool temperature location to a warm temperature location may result in moisture condensation on the lens. In such an event, leave the projector OFF and wait until condensation disappears.</p>
Picture is Left/Right reversed.	<ul style="list-style-type: none"> ● Check Ceiling / Rear feature. (See "SETTING" section on page 31.)
Picture is Top/Bottom reversed.	<ul style="list-style-type: none"> ● Check Ceiling feature. (See "SETTING" section on page 31.)
Some displays are not seen during the Operation.	<ul style="list-style-type: none"> ● Check Display feature.(See "SETTING" section on page 31.)
No image.	<ul style="list-style-type: none"> ● Check the connection between the computer or video equipment and the projector. ● When turning the projector on, it is about 30 seconds to display the image. ● Check the system that you select is corresponding with the computer or the video equipment. ● Make sure the temperature is not out of the Operating Temperature (5°C ~ 35°C).
No sound.	<ul style="list-style-type: none"> ● Check audio cable connection from audio input source. ● Adjust the audio source. ● Press VOLUME (+) button. ● Press MUTE button.

Problem:	Try these Solution
Remote Control Units dose not work.	<ul style="list-style-type: none">● Check the batteries.● Check the ALL-OFF switch on the Remote Control Unit is set to "ON."● Make sure anything is blocking between the Remote Receiver and the Remote Control Units.● Make sure you are not too far from the projector when using the Remote Control Units. Maximum operating range is 16.4' (5m).
Wireless Mouse function does not work.	<ul style="list-style-type: none">● Check the cable connection between the projector and the computer.● Check the mouse setting on your computer.● Turn the projector before your turn on the computer.

WARNING :

High voltages are used to operate this projector. Do not attempt to open the cabinet.

Where to Get Help

If you still need help after checking the table on the "TROUBLESHOOTING" section, you should call your dealer's technical support line and explain your problem.

If your dealer cannot solve your problem, please call Proxima's customer service. The number is :

USA or Canada Phone (800) 447-7692

FAX (858) 457-9647

Rest of Word Phone (858) 457-5500

Europe Phone +31-43-358-5210

Support FAX +31-43-358-5202

www.proxima.com <<http://www.proxima.com>>

In the event that your unit is determined to be defective, you'll be issued a Return Authorization Number.

After you've received this number, send the unit, a copy of your sales receipt, and a description of the problem, freight prepaid, to Proxima. Clearly note the Return Authorization Number on the outside of the shipping box.

TECHNICAL SPECIFICATIONS

Projector Type	ULTRALIGHT LX2
Dimensions (W x H x D)	9.41" x 3.54" x 12.72" (239mm x 90mm x 323mm) (not including Adjustable Feet)
Net Weight	8.6 lbs (3.9 kg)
LCD Panel System	0.9" TFT Active Matrix type, 3 panels
Panel Resolution	1024 x 768 dots
Number of Pixels	2,359,296 (1024 x 768 x 3 panels)
Color System	PAL, SECAM, NTSC, NTSC4.43, PAL-M and PAL-N
Scanning Frequency	H-sync. 15 ~ 100 KHz, V-sync. 50 ~ 100 Hz
Projection Image size (Diagonal)	Adjustable from 30" to 300"
Horizontal Resolution	800 TV lines
Projection Lens	F 1.7 ~ 2.0 lens with f 33.2mm ~ 43.1mm Motor zoom and focus
Throw Distance	4.6' ~ 35.4' (1.4 m ~ 10.8 m)
Projection Lamp	150 W
AV Input Jacks	RCA Type x 1 (Video, Audio R and L) and DIN 4 pin (S-Video) x 1
Computer Input Jacks	(VGA) HDB 15 Terminal x 1
Control Port Jack	DIN 8 pin x 1
Monitor Output Jack	(VGA) HDB 15 Terminal x 1
Computer Audio Input Jack	Mini Jack (stereo)
Audio Output Jack	Mini Jack (stereo)
Internal Audio Amp	1W RMS (Monaural)
Built-in Speaker	1 speaker, 1.57" x 1.18" (40mm x 30mm)
Feet Adjustment	0° to 10°
Voltage	AC 100 ~ 120 V / 200 - 240 V, 50 / 60 Hz
Power Consumption	2.5 / 1.4 A (Max. Ampere)
Operating Temperature	41 °F ~ 95 °F (5 °C ~ 35 °C)
Storage Temperature	14 °F ~ 140 °F (-10 °C ~ 60 °C)
Remote Control Transmitter	Power Source : AA Type x 2 Operating Range : 16.4' (5m) / ±30° Dimensions : 2.2" x 1.3" x 7.6" (55mm x 34mm x 192mm) Net Weight : 0.35 lbs (160 g) (including batteries) Laser Pointer : Class II Laser (Max. Output : 1mW / Wave length : 650±20nm)
Accessories	AC Power Cords (for use in the U.S.A and for use in the European countries) Remote Control Transmitter and Batteries VGA Cable MAC Adapter Control Cables (for PS/2 port x 1, for Serial port x 1, and for ADB port x 1) PC Audio Cable AV Cable S-VIDEO Cable USER'S GUIDE Lens Cover Dust Cover

- The specifications are subject to change without notice.



This symbol on the nameplate means the product is Listed by Underwriters Laboratories Inc. It is designed and manufactured to meet rigid U.L. safety standards against risk of fire, casualty and electrical hazards.

Warranty

Proxima Corporation warrants that the Proxima® Multimedia Projector product manufactured by Proxima is free from defects in materials and workmanship under normal use during the Warranty Period. The Warranty Period commences on the day of purchase by the end-user. The Warranty Period is two years. The projector lamp is not covered by this Warranty.

Each Proxima product is manufactured from new parts, or new and some used parts. In some cases, the product may have been delivered to another end-user and then returned. In all cases, the product has undergone testing and quality inspection, and Proxima's full warranty terms apply.

The end-user's sales receipt or invoice showing the date of purchase of the product and the name of the Reseller is proof of the date of purchase. The Warranty extends only to the original purchaser and is not transferable.

During the Warranty Period, Proxima will, at no additional charge, repair or replace defective parts or at the option of Proxima, replace the entire unit.

This Limited Warranty does not extend to any Proxima product that has been damaged or been rendered defective (a) as a result of accident, misuse, or other abuse; (b) by the use of parts not manufactured or sold by Proxima; or (c) by modification of the product; or (d) as a result servicing by non-authorized personnel.

Limitation of Warranties

The foregoing warranty is expressly in lieu of any other express or implied warranties, including, without limitation, warranties of merchantability or fitness for a particular purpose. To the extent not prohibited by law, all statutory warranties are hereby waived and excluded from this warranty. Proxima expressly disclaims all warranties not stated in this Limited Warranty.

For Americas:

Proxima Corporation
9440 Carroll Park Drive
San Diego, CA 92121

Ph: (858) 457-5500
(800) 447-7692 (U. S. and Canada.)

Fax. (858) 457-9647

www.proxima.com <<http://www.proxima.com>>

Part No. 710-00845-1

For Europe, Asia, Africa, Australia:

ASK Proxima ASA
K. G. Meldahlsvei 9
Postboks 1403
N-1602 Fredrikstad
tel. +47-69 34 01 55
fax. +47-69 34 06 32

Technical Support & Service
Horsterweg 24
6191 RX Beek
The Netherlands
tel. +31-43 358 5210
fax. +31-43 358 5202