

***myprojectorlamps.com***

**The most trusted, dependable name  
in projector lamp sales.**



<http://www.myprojectorlamps.com>



<http://www.myprojectorlamps.ca>



<http://www.myprojectorlamps.eu>

The following projector manual has not been modified or altered in any way.

# PROMETHEAN

MULTIMEDIA PROJECTOR

MODEL **PRM-20**  
**PRM-20(S)**

## Network Supported

- Wired LAN  
100-Base-TX/10-Base-T

\* Refer to the owner's manual below for details about network function.

- Network Set-up and Operation

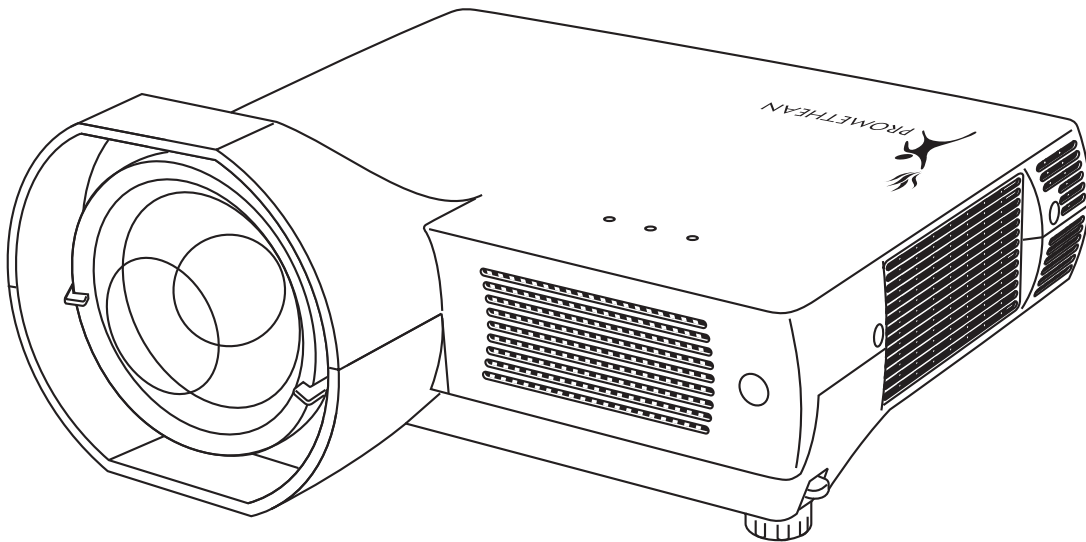

PROJECTOR

**OWNER'S MANUAL**

# Features and Design

This Multimedia Projector is designed with the most advanced technology for portability, durability, and ease of use. This projector utilizes built-in multimedia features, a palette of 16.77 million colors, and matrix liquid crystal display (LCD) technology.

## ◆ Large Screen in Limited Space

Short focus lens allows you to project large images from short distance. (p.13)

## ◆ Antitheft Alarm Function

This projector is equipped with an Antitheft alarm function which sounds when a vibration is detected. (pp.48, 51-53)

## ◆ Security Features

The projector cannot be operated without remote control. Keep the remote control securely at hand to minimize the risk of theft.

Easily identifiable orange cabinet for security.

The PIN code lock guards the projector from an unauthorized user. (pp.18, 47-48)

## ◆ Logo Function

The Logo function allows you to customize the screen logo. The Logo page identifies the owner of the projector. (pp.42, 43)

## ◆ Closed Caption

This is a printed version of the program sound or other information displayed on the screen. You can turn on the feature and switch the channels. (p.50)

## ◆ Simple Computer System Setting

The projector has a Multi-scan system to conform to almost all computer output signals quickly. (p.26)

## ◆ Compatibility

The projector widely accepts various video and computer input signals including; Computers, 6 Color systems (PAL, SECAM, NTSC, NTSC4.43, PAL-M, or PAL-N), Component video, S-video and RGB scart.

## ◆ LAN Network Function

This projector is loaded with the Wired function. You can manage the projector via network. For details, refer to the owner's manual "Network Set-up and Operation."

- The On-Screen Menu and figures in this manual may differ slightly from the product.
- The contents of this manual are subject to change without notice.

## ◆ Quick Termination

The AC power cord can be unplugged immediately after turning off the projector without waiting for the projector to cool down. (p.19)

## ◆ Digital Zoom (for Computer)

The digital zoom function allows you to focus on crucial information during a presentation. You can expand the images approx. 16 times the screen size and compress them to approximately a quarter of the screen size. (p.33)

## ◆ Blackboard Function

A blackboard can be used as a projection screen. (pp.30, 37)

\*The board color is limited to Green.

## ◆ Colorboard Function

At the time of simple projection on the colored wall, you can get the close color image to the color image projected on a white screen by selecting the similar color to the wall color from the preset four colors.

## ◆ Multilanguage Menu Display

The Operation menu is available in 16 languages: English, German, French, Italian, Spanish, Portuguese, Dutch, Swedish, Finnish, Polish, Hungarian, Romanian, Russian, Chinese, Korean, and Japanese. (p.41)

## ◆ Switchable Interface Terminal

The projector provides a switchable interface terminal. You can use the terminal as computer input or monitor output conveniently. (p.44)

## ◆ Power Management

The Power management function reduces power consumption and maintains lamp life. (p.45)

## ◆ Input Search Function

Input signal can be searched automatically. (p.44)

**You can turn on or operate the projector ONLY via the remote control. Make sure not to lose the remote control.**

# Table of Contents

<b>Features and Design</b> .....	<b>2</b>	Auto PC Adjustment	27
<b>Table of Contents</b> .....	<b>3</b>	Manual PC Adjustment	28
<b>To the Owner</b> .....	<b>4</b>	Image Level Selection	30
<b>Safety Instructions</b> .....	<b>5</b>	Image Level Adjustment	31
Air Circulation	6	Screen Size Adjustment	32
Installing the Projector in Proper Position	6	<b>Video Input</b> .....	<b>34</b>
Moving the Projector	6	Input Source Selection (Video, S-video)	34
<b>Compliance</b> .....	<b>7</b>	Input Source Selection (Component, RGB	
<b>Part Names and Functions</b> .....	<b>8</b>	Scart 21-pin)	35
Front	8	Video System Selection	36
Back	8	Image Level Selection	37
Bottom	8	Image Level Adjustment	38
Rear Terminal	9	Screen Size Adjustment	40
Top Panel	10	<b>Setting</b> .....	<b>41</b>
Antitheft Alarm Setting Buttons	10	Setting	41
Remote Control	11	<b>Antitheft Alarm Function</b> .....	<b>51</b>
Remote Control Battery Installation	12	How to Use the Antitheft Alarm Function	51
Operating Range	12	<b>Maintenance and Cleaning</b> .....	<b>54</b>
<b>Installation</b> .....	<b>13</b>	Warning Indicator	54
Positioning the Projector	13	Cleaning the Air Filters	55
Adjustable Feet	13	Resetting the Filter Counter	55
Connecting to a Computer	14	Attaching the Lens Cover	56
Connecting to Video Equipment	15	Cleaning the Projection Lens	56
Connecting to Component Video Equipment	16	Cleaning the Projector Cabinet	56
Connecting the AC Power Cord	17	Lamp Replacement	57
<b>Basic Operation</b> .....	<b>18</b>	Lamp Replacement Counter	58
Turning On the Projector	18	<b>Appendix</b> .....	<b>59</b>
Turning Off the Projector	19	Troubleshooting	59
How to Operate the On-Screen Menu	20	Menu Tree	62
Menu Bar	21	Indicators and Projector Condition	64
Focus Adjustment	22	Compatible Computer Specifications	65
Keystone Correction	22	Technical Specifications	66
Sound Adjustment	23	Dimensions	67
Remote Control Operation	23	Configurations of Terminals	68
<b>Computer Input</b> .....	<b>25</b>	PIN Code Number Memo	69
Input Source Selection	25		
Computer System Selection	26		

---

## Trademarks

Each name of corporations or products in this book is either a registered trademark or a trademark of its respective corporation.

# To the Owner

Before installing and operating the projector, read this manual thoroughly.

The projector provides many convenient features and functions. Operating the projector properly enables you to manage those features and maintain it in good condition for many years to come.

Improper operation may result in not only shortening the product life, but also malfunctions, fire hazard, or other accidents.

If your projector seems to operate improperly, read this manual again, check operations and cable connections and try the solutions in the "Troubleshooting" section on pages 59~61 of this manual. If the problem still persists, contact the dealer where you purchased the projector or the service center.

<div style="display: inline-block; text-align: center; background-color: black; color: white; padding: 2px 10px; font-weight: bold; font-size: 0.8em;"> <b>CAUTION</b>  <b>RISK OF ELECTRIC SHOCK</b>  <b>DO NOT OPEN</b> </div>
<p><b>CAUTION: TO REDUCE THE RISK OF ELECTRIC SHOCK, DO NOT REMOVE COVER (OR BACK). NO USER-SERVICEABLE PARTS INSIDE EXCEPT LAMP REPLACEMENT. REFER SERVICING TO QUALIFIED SERVICE PERSONNEL.</b></p>
<p> THIS SYMBOL INDICATES THAT DANGEROUS VOLTAGE CONSTITUTING A RISK OF ELECTRIC SHOCK IS PRESENT WITHIN THIS UNIT.</p>
<p> THIS SYMBOL INDICATES THAT THERE ARE IMPORTANT OPERATING AND MAINTENANCE INSTRUCTIONS IN THE OWNER'S MANUAL WITH THIS UNIT.</p>

The symbol mark and recycling systems described below apply to EU countries and do not apply to countries in other areas of the world.

Your product is designed and manufactured with high quality materials and components which can be recycled and/or reused.

The symbol mark means that electrical and electronic equipment, batteries and accumulators, at their end-of-life, should be disposed of separately from your household waste.

Note:

If a chemical symbol is printed beneath the symbol mark, this chemical symbol means that the battery or accumulator contains a heavy metal at a certain concentration. This will be indicated as follows: Hg: mercury, Cd: cadmium, Pb: lead

In the European Union there are separate collection systems for used electrical and electronic equipment,

batteries and accumulators.

Please, dispose of them correctly at your local community waste collection/recycling centre.

Please, help us to conserve the environment we live in!



## Safety Precaution

**WARNING:** • **THIS APPARATUS MUST BE EARTHED.**

• **TO REDUCE THE RISK OF FIRE OR ELECTRIC SHOCK, DO NOT EXPOSE THIS APPLIANCE TO RAIN OR MOISTURE.**

- This projector produces intense light from the projection lens. Avoid staring directly into the lens, otherwise eye damage could result. Be especially careful that children do not stare directly into the beam.
- Install the projector in a proper position. Otherwise it may result in fire hazard.
- Allowing the proper amount of space on the top, sides, and rear of the projector cabinet is critical for proper air circulation and cooling of the unit. The dimensions shown here indicate the minimum space required. If the projector is to be built into a compartment or similarly enclosed, these minimum distances must be maintained.
- Do not cover the ventilation slot on the projector. Heat build-up can reduce the service life of your projector, and can also be dangerous.

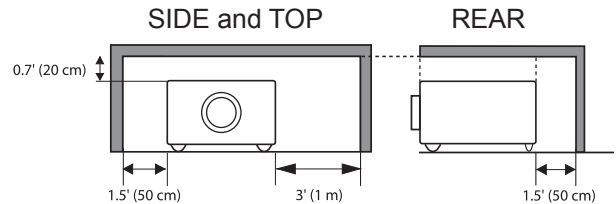

- If the projector is unused for an extended time, unplug the projector from the power outlet.
- Do not project the same image for a long time. The afterimage may remain on the LCD panels by the characteristic of panel.



## CAUTION

**DO NOT SET THE PROJECTOR IN GREASY, WET, OR SMOKY CONDITIONS SUCH AS IN A KITCHEN TO PREVENT A BREAKDOWN OR DISASTER. IF THE PROJECTOR COMES IN CONTACT WITH OIL OR CHEMICALS, IT MAY BECOME DETERIORATED.**

## CAUTION

Not for use in a computer room as defined in the Standard for the Protection of Electronic Computer/Data Processing Equipment, ANSI/NFPA 75.

Ne peut être utilisé dans une salle d'ordinateurs telle que définie dans la norme ANSI/NFPA 75 Standard for Protection of Electronic Computer/Data Processing Equipment.

**READ AND KEEP THIS OWNER'S MANUAL FOR LATER USE.**

# Safety Instructions

All the safety and operating instructions should be read before the product is operated.

Read all of the instructions given here and retain them for later use. Unplug this projector from AC power supply before cleaning. Do not use liquid or aerosol cleaners. Use a damp cloth for cleaning.

Follow all warnings and instructions marked on the projector.

For added protection to the projector during a lightning storm, or when it is left unattended and unused for long periods of time, unplug it from the wall outlet. This will prevent damage due to lightning and power line surges.

---

Do not expose this unit to rain or use near water... for example, in a wet basement, near a swimming pool, etc...

Do not use attachments not recommended by the manufacturer as they may cause hazards.

Do not place this projector on an unstable cart, stand, or table. The projector may fall, causing serious injury to a child or adult, and serious damage to the projector. Use only with a cart or stand recommended by the manufacturer, or sold with the projector. Wall or shelf mounting should follow the manufacturer's instructions, and should use a mounting kit approved by the manufacturers.

An appliance and cart combination should be moved with care. Quick stops, excessive force, and uneven surfaces may cause the appliance and cart combination to overturn.



---

Slots and openings in the back and bottom of the cabinet are provided for ventilation, to ensure reliable operation of the equipment and to protect it from overheating.

The openings should never be covered with cloth or other materials, and the bottom opening should not be blocked by placing the projector on a bed, sofa, rug, or other similar surface. This projector should never be placed near or over a radiator or heat register.

This projector should not be placed in a built-in installation such as a book case unless proper ventilation is provided.

Never push objects of any kind into this projector through cabinet slots as they may touch dangerous voltage points or short out parts that could result in a fire or electric shock. Never spill liquid of any kind on the projector.

Do not install the projector near the ventilation duct of air-conditioning equipment.

This projector should be operated only from the type of power source indicated on the marking label. If you are not sure of the type of power supplied, consult your authorized dealer or local power company.

Do not overload wall outlets and extension cords as this can result in fire or electric shock. Do not allow anything to rest on the power cord. Do not locate this projector where the cord may be damaged by persons walking on it.

Do not attempt to service this projector yourself as opening or removing covers may expose you to dangerous voltage or other hazards. Refer all servicing to qualified service personnel.

Unplug this projector from wall outlet and refer servicing to qualified service personnel under the following conditions:

- a. When the power cord or plug is damaged or frayed.
- b. If liquid has been spilled into the projector.
- c. If the projector has been exposed to rain or water.
- d. If the projector does not operate normally by following the operating instructions. Adjust only those controls that are covered by the operating instructions as improper adjustment of other controls may result in damage and will often require extensive work by a qualified technician to restore the projector to normal operation.
- e. If the projector has been dropped or the cabinet has been damaged.
- f. When the projector exhibits a distinct change in performance this indicates a need for service.

When replacement parts are required, be sure the service technician has used replacement parts specified by the manufacturer that have the same characteristics as the original part. Unauthorized substitutions may result in fire, electric shock, or injury to persons.

Upon completion of any service or repairs to this projector, ask the service technician to perform routine safety checks to determine that the projector is in safe operating condition.

## NOTE FOR CUSTOMERS IN THE US

(Hg) LAMP(S) INSIDE THIS PRODUCT CONTAIN MERCURY AND MUST BE RECYCLED OR DISPOSED OF ACCORDING TO LOCAL, STATE OR FEDERAL LAWS.



## Air Circulation

Openings in the cabinet are provided for ventilation. To ensure reliable operation of the product and to protect it from overheating, these openings must not be blocked or covered.

### CAUTION

Hot air is exhausted from the exhaust vent. When using or installing the projector, the following precautions should be taken.

- Do not put any flammable objects or spray can near the projector. Hot air is exhausted from the air vents.
- Keep the exhaust vent at least 3' (1 m) away from any objects.
- Do not touch a peripheral part of the exhaust vent, especially screws and metallic part. This area will become hot while the projector is being used.
- Do not put anything on the projector. Objects put on the cabinet will not only get damaged but also may cause fire hazard by heat.

Cooling fans are provided to cool down the projector. The fan's running speed is changed according to the temperature inside the projector.

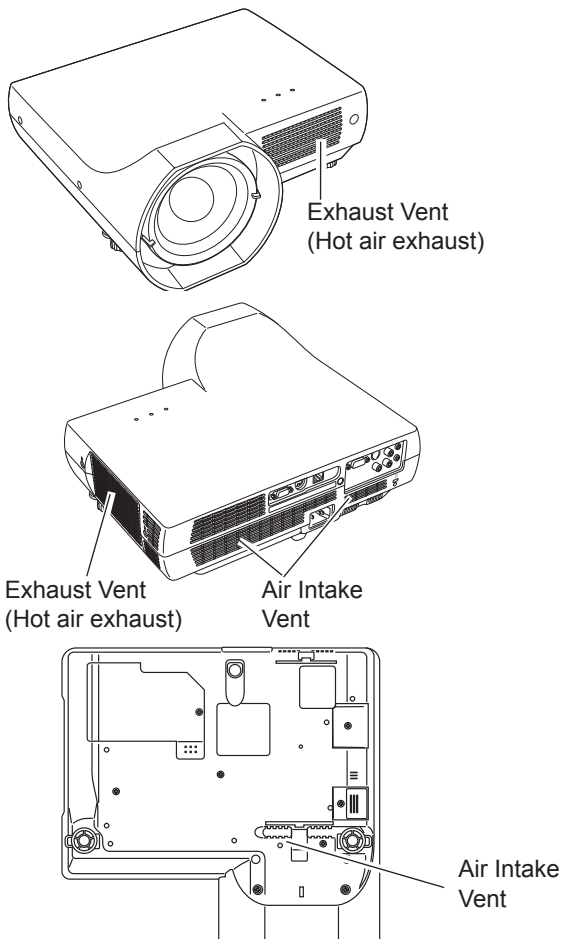

## Installing the Projector in Proper Position

Install the projector properly. Improper Installation may reduce the lamp life and cause fire hazard.

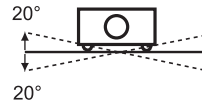

Do not roll the projector more than 20 degrees from side to side.



Do not point the projector up to project an image.



Do not point the projector down to project an image.



Do not put the projector on either side to project an image.

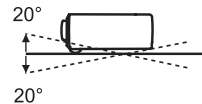

Do not pitch the projector more than 20 degrees backward and forward.

### CAUTION

Choose the running speed of cooling fans in the fan control setting according to the altitude in which the projector is being used (p.49). Failure to do so may affect the projector life.

## Moving the Projector

When moving the projector, replace the lens cover and retract the adjustable feet to prevent damage to the lens and cabinet. When the projector is not in use for an extended period, put it into a suitable case.

Handle the projector carefully; do not drop, bump, subject it to strong forces, or put other things on the cabinet.

### CAUTION IN CARRYING OR TRANSPORTING THE PROJECTOR

- Do not drop or bump the projector, otherwise damages or malfunctions may result.
- When carrying the projector, use a suitable carrying case.
- Do not transport the projector by courier or any other transport service in an unsuitable transport case. This may cause damage to the projector. For information about transporting the projector by courier or any other transport service, consult your dealer.
- Do not put the projector in a case before it is cooled enough.

# Compliance

## Federal Communications Commission Notice

This equipment has been tested and found to comply with the limits for a Class B digital device, pursuant to Part 15 of the FCC Rules. These limits are designed to provide reasonable protection against harmful interference in a residential installation. This equipment generates, uses, and can radiate radio frequency energy. If it is not installed and used in accordance with the instructions, it may cause harmful interference to radio communications. However, there is no guarantee that interference will not occur in a particular installation. If this equipment does cause harmful interference to radio or television reception, which can be determined by turning the equipment off and on, the user is encouraged to try to correct the interference by one or more of the following measures:

- Reorient or relocate the receiving antenna.
- Increase the separation between the equipment and receiver.
- Connect the equipment into an outlet on a circuit different from that to which the receiver is connected.
- Consult the dealer or an experienced radio/TV technician for help.

Use of shielded cable is required to comply with Class B limits in Subpart B of Part 15 of FCC Rules.

Do not make any changes or modifications to the equipment unless otherwise specified in the instructions. If such changes or modifications should be made, you could be required to stop operation of the equipment.

Model Number : PRM-20, PRM-20(S)  
Trade Name : Promethean  
Responsible party : Promethean Inc.  
Address : 1165 Sanctuary Parkway, Suite 400, Atlanta, GA 30004 USA  
Telephone No. : 678 762 1500

## AC Power Cord Requirement

The AC Power Cord supplied with this projector meets the requirement for use in the country you purchased it.

### AC Power Cord for the United States and Canada:

AC Power Cord used in the United States and Canada is listed by the Underwriters Laboratories (UL) and certified by the Canadian Standard Association (CSA).

AC Power Cord has a grounding-type AC line plug. This is a safety feature to be sure that the plug will fit into the power outlet. Do not try to defeat this safety feature. Should you be unable to insert the plug into the outlet, contact your electrician.

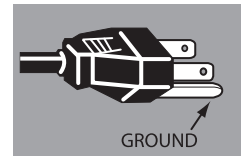

### AC Power Cord for the United Kingdom:

This cord is already fitted with a moulded plug incorporating a fuse, the value of which is indicated on the pin face of the plug. Should the fuse need to be replaced, an ASTA approved BS 1362 fuse must be used of the same rating, marked thus  $\diamond$ . If the fuse cover is detachable, never use the plug with the cover omitted. If a replacement fuse cover is required, ensure it is of the same colour as that visible on the pin face of the plug (i.e. red or orange). Fuse covers are available from the Parts Department indicated in your User Instructions.

If the plug supplied is not suitable for your socket outlet, it should be cut off and destroyed.

The end of the flexible cord should be suitably prepared and the correct plug fitted.

**WARNING: A PLUG WITH BARED FLEXIBLE CORD IS HAZARDOUS IF ENGAGED IN A LIVE SOCKET OUTLET.**

The Wires in this mains lead are coloured in accordance with the following code:

Green-and-yellow ..... Earth  
Blue ..... Neutral  
Brown ..... Live

As the colours of the wires in the mains lead of this apparatus may not correspond with the coloured markings identifying the terminals in your plug proceed as follows:

The wire which is coloured green-and-yellow must be connected to the terminal in the plug which is marked by the letter E or by the safety earth symbol  $\perp$  or coloured green or green-and-yellow.

The wire which is coloured blue must be connected to the terminal which is marked with the letter N or coloured black.

The wire which is coloured brown must be connected to the terminal which is marked with the letter L or coloured red.

**WARNING: THIS APPARATUS MUST BE EARTHED.**

**THE SOCKET-OUTLET SHOULD BE INSTALLED NEAR THE EQUIPMENT AND EASILY ACCESSIBLE.**



# Part Names and Functions

## Front

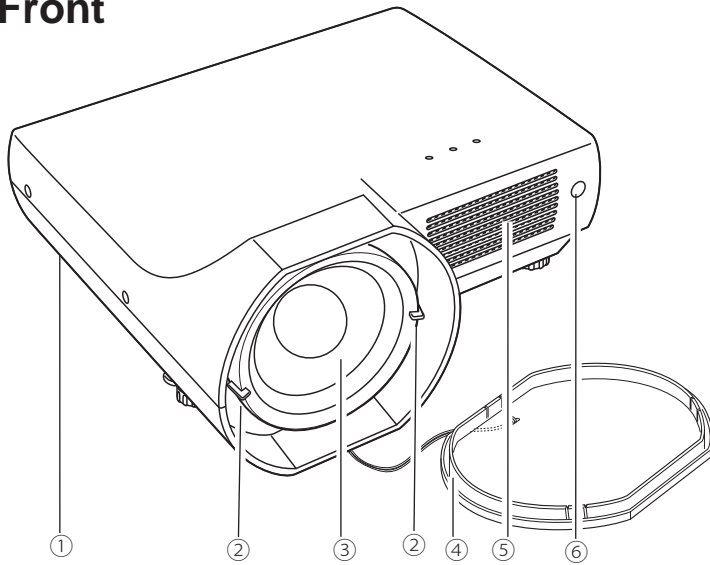

- ① Antitheft alarm setting buttons
- ② Focus Lever
- ③ Projection Lens
- ④ Lens Cover  
(See p. 56 for attaching)

### CAUTION

Do not turn on the projector with putting the lens cover on. The light beam may damage lens cover and result in fire hazard.

Attach the lens cover while the projector is not in use to avoid scratching the lens surface.

- ⑤ Exhaust Vents

### CAUTION

Hot air is exhausted from the exhaust vent. Do not put heat-sensitive objects near this side.

## Back

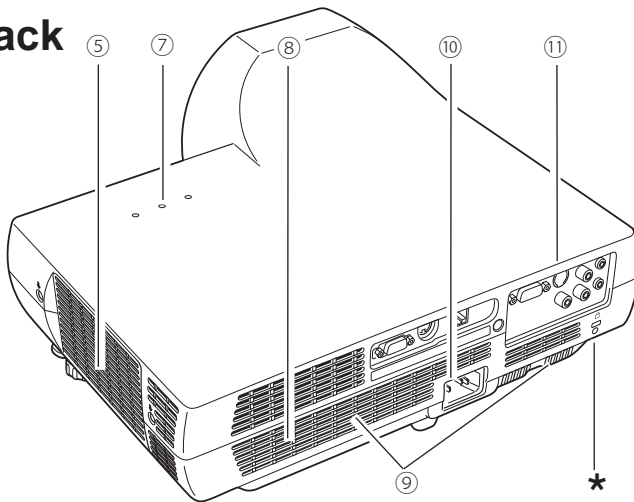

- ⑥ Infrared Remote Receiver
- ⑦ Indicators
- ⑧ Speaker
- ⑨ Air Intake Vent
- ⑩ Power Cord Connector
- ⑪ Terminals and Connectors

- ⑫ Lamp Cover

- ⑬ Air Filters

- ⑭ Battery Compartment  
(For Antitheft alarm function)

- ⑮ Adjustable Feet

## Bottom

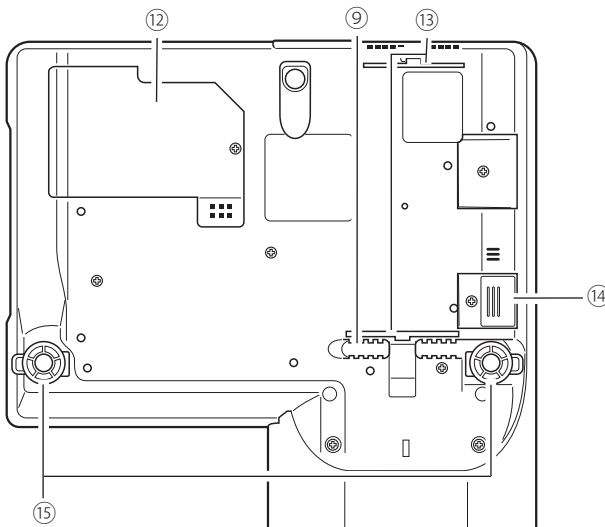

### **\* Kensington Security Slot**

This slot is for a Kensington lock used to deter theft of the projector.

\*Kensington is a registered trademark of ACCO Brands Corporation.

## Rear Terminal

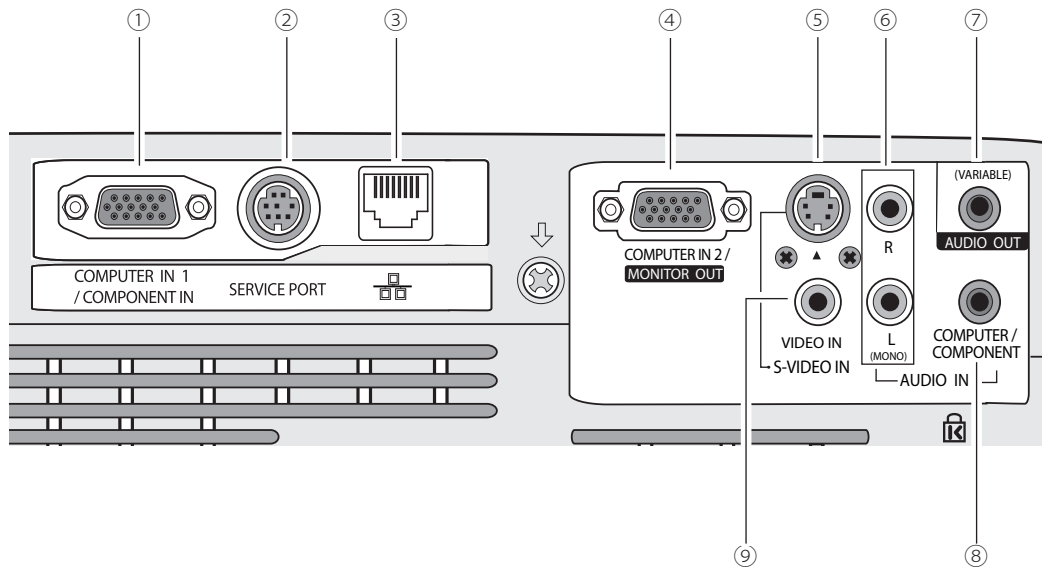

**① COMPUTER IN 1/COMPONENT IN**

Connect output signal from a computer, RGB scart 21-pin video output, or component video output to this terminal (pp.14, 16).

When the cable is of the longer variety, it is advisable to use this terminal and not COMPUTER IN 2/MONITOR OUT.

**② SERVICE PORT**

When controlling the projector from a computer, connect the computer to this connector with a control cable.

**③ LAN Connection Terminal**

Connect the LAN cable (Refer to the owner's manual of "Network Set-up and Operation".).

**④ COMPUTER IN 2/MONITOR OUT**

This terminal is switchable and can be used for input from a computer or output to the other monitor.

Set the terminal up as either Computer input or Monitor output properly. [Used for Monitor out, this terminal outputs only incoming signal from COMPUTER IN 1/COMPONENT IN terminal (pp. 14, 44)].

**⑤ S-VIDEO IN**

Connect the S-VIDEO output from video equipment to this jack (p.15).

**⑥ AUDIO IN**

Connect the audio output from video equipment connected to ⑤ or ⑨ to this jack. [When the audio output is monaural, connect it to L (MONO) jack (p.15).

**⑦ AUDIO OUT (VARIABLE)**

Connect an external audio amplifier to this jack (pp.14 - 16).

This terminal outputs sound from AUDIO IN terminal (⑥ or ⑧).

**⑧ COMPUTER/COMPONENT AUDIO IN**

Connect the audio output (stereo) from a computer or video equipment connected to ① or ④ to this jack (pp.14, 16).

**⑨ VIDEO IN**

Connect the composite video output from video equipment to VIDEO jack (p.15).

### Top Panel

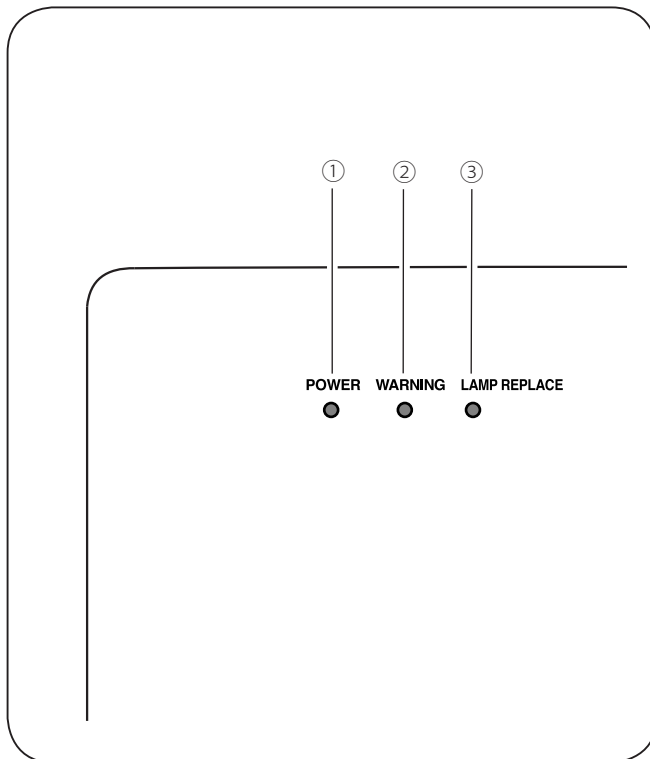

- ① **POWER indicator**  
It turns red when the projector is in the stand-by mode.  
It remains green while the projector is under operation.  
(pp. 18, 64)
- ② **WARNING indicator**  
Emit a red light when the projector detects abnormal condition. This also blinks red when the internal temperature of the projector exceeds the operating range. (pp. 54, 64)
- ③ **LAMP REPLACE indicator**  
Turn yellow when the life of the projection lamp draws to an end. (pp. 57, 64)

### Antitheft Alarm Setting Buttons

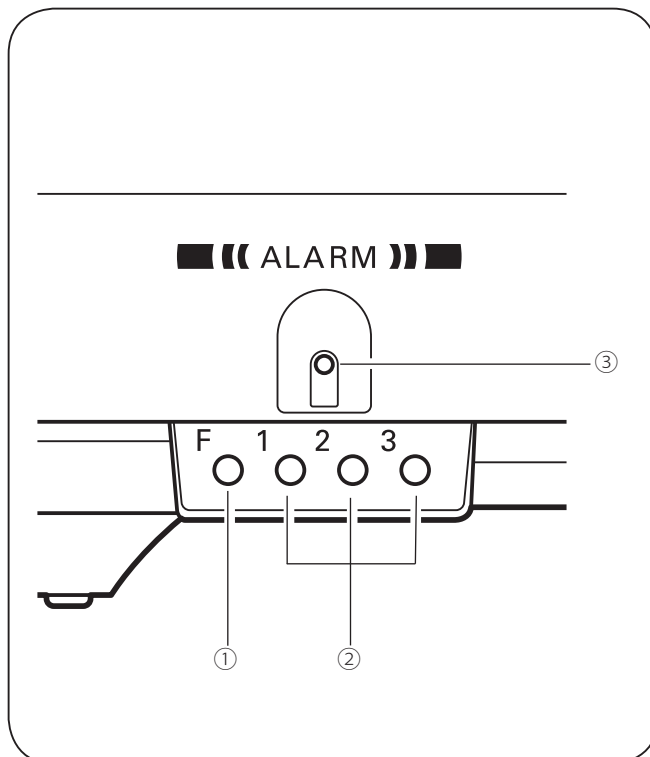

These buttons are used for Antitheft alarm function.  
(pp. 51-53)

- ① **F button**  
Used for Antitheft alarm setting.
- ② **Buttons 1-3**  
Used for Antitheft alarm setting.
- ③ **ALARM indicator**  
Blinks red to indicate the battery condition or key operation.

## Remote Control

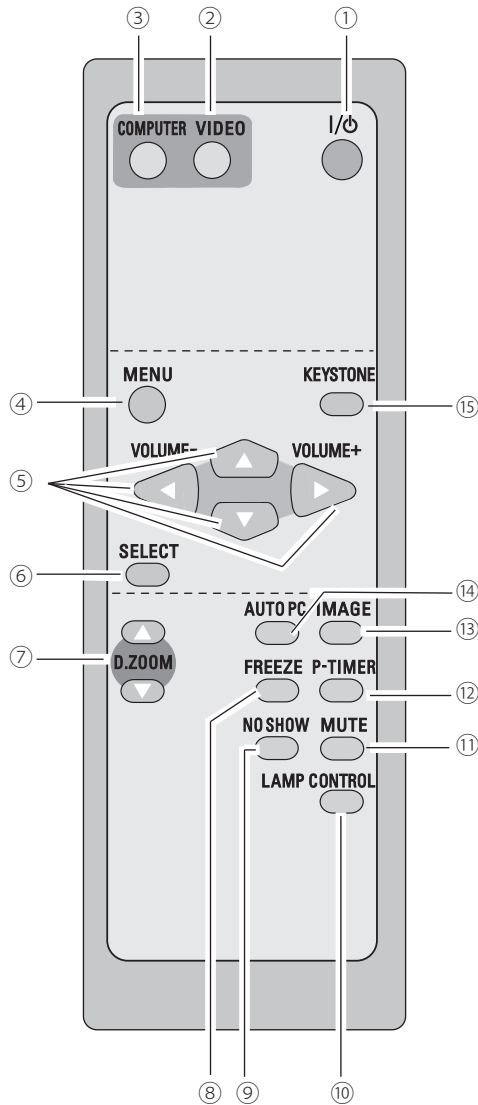

**You can turn on or operate the projector ONLY via the remote control. Make sure not to lose the remote control.**

- ① **POWER ON/STAND-BY button**  
Turn the projector on or off (pp.18, 19).
- ② **VIDEO button**  
Select VIDEO input port (pp.23, 34).
- ③ **COMPUTER button**  
Select COMPUTER input port (pp.23, 25, 35).
- ④ **MENU button**  
Open or close the On-Screen Menu (p.20).
- ⑤ **Point ▲▼◀▶ (VOLUME + / -) buttons**
  - Select an item or adjust the value in the On-Screen Menu. (p.20)
  - Pan the image in Digital zoom + mode (p.33).
  - Adjust the volume level (Point ◀▶ buttons) (p.23).
- ⑥ **SELECT button**
  - Execute the selected item (p.20).
  - Expand or compress the image in Digital zoom mode. (p.33)
- ⑦ **D.ZOOM ▲▼ buttons**  
Zoom in and out the images (pp.24, 33).
- ⑧ **FREEZE button**  
Freeze the picture (p.23).
- ⑨ **NO SHOW button**  
Temporarily turn off the image on the screen (p.24).
- ⑩ **LAMP CONTROL button**  
Select the lamp mode (pp.24, 46).
- ⑪ **MUTE button**  
Mute the sound (p.23).
- ⑫ **P-TIMER button**  
Operate the P-timer function (p.24).
- ⑬ **IMAGE button**  
Select the image level (pp.24, 30, 37).
- ⑭ **AUTO PC button**  
Automatically adjust the computer image to its optimum setting (pp.24, 27).
- ⑮ **KEYSTONE button**  
Correct the keystone distortion (pp.22, 41).



- To ensure safe operation, observe the following precautions:
- Do not bend, drop, or expose the remote control to moisture or heat.
  - For cleaning, use a soft dry cloth. Do not apply benzene, thinner, spray, or any other chemicals.

### Remote Control Battery Installation

- 1** Open the battery compartment lid.

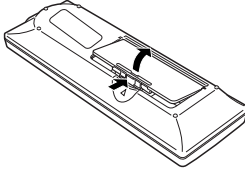

- 2** Install new batteries into the compartment.

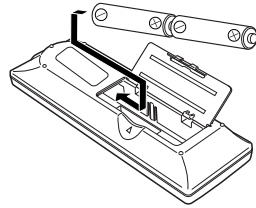

**Two AA size batteries**  
For correct polarity (+ and -), be sure battery terminals are in contact with pins in the compartment.

- 3** Replace the compartment lid.

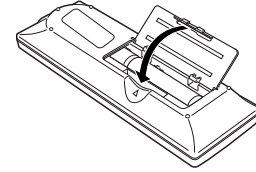

To ensure safe operation, please observe the following precautions:

- Use two (2) AA or LR6 type alkaline batteries.
- Always replace batteries in sets.
- Do not use a new battery with a used battery.
- Avoid contact with water or liquid matter.
- Do not expose the remote control to moisture or heat.
- Do not drop the remote control.
- If the battery has leaked on the remote control, carefully wipe the case clean and install new batteries.
- Risk of explosion if a battery is replaced by an incorrect type.
- Dispose of used batteries according to the instructions.

### Operating Range

Point the remote control toward the projector (Infrared Remote Receiver) when pressing any button. Maximum operating range for the remote control is about 16.4' (5 m) and 60 degrees in front of the projector.

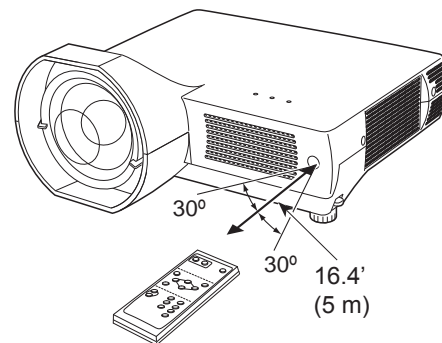

# Installation

## Positioning the Projector

For the projector positioning, see the figures below.

The projector should be set perpendicularly to the plane of the screen.

✓ **Note:**

- This projector is not equipped with an optical zoom. To adjust the screen size, change the throw distance.
- The brightness in the room has a great influence on picture quality. It is recommended to limit the ambient lighting in order to get the best image.
- All measurements are approximate and may vary from the actual sizes.

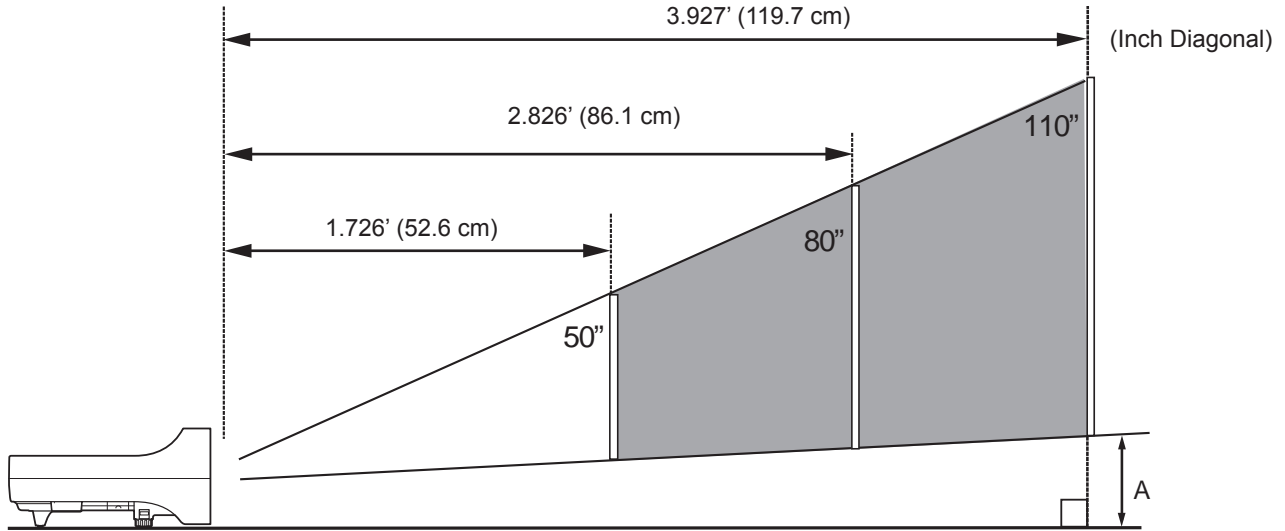

Screen Size (W x H) mm	50"	80"	110"
16:10 aspect ratio	1077 x 673	1723 x 1077	2369 x 1481
Throw distance	1.726' (52.6 cm)	2.826' (86.1 cm)	3.927' (119.7 cm)
A	0.623' (19.0 cm)	0.846' (25.8 cm)	1.069' (32.6 cm)

## Adjustable Feet

Projection angle can be adjusted up to 10.0 degrees with the adjustable feet.

- 1 Lift the front of the projector and pull the feet lock latches on both sides of the projector upward.
- 2 Release the feet lock latches to lock the adjustable feet and rotate the adjustable feet to adjust the position and tilt.
- 3 To retract the adjustable feet, lift the front of the projector and pull and undo the feet lock latches. Keystone distortion of the projected image can be corrected by remote control operation or menu operation (pp.22, 41).

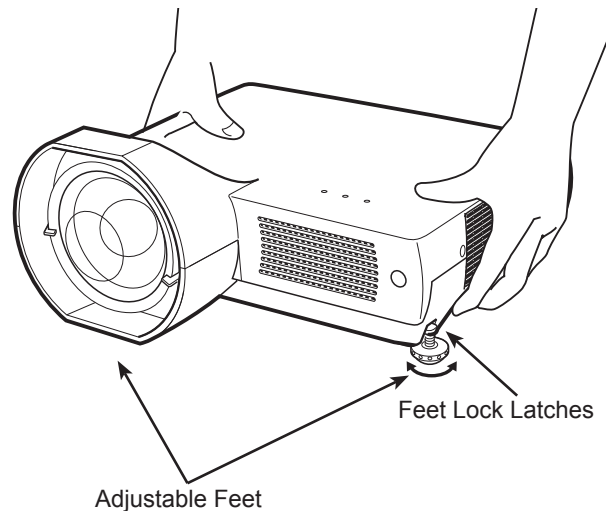



## Connecting to a Computer

### Cables used for connection

- VGA Cables (Mini D-sub 15 pin)\*
- Audio Cables (Mini Plug: stereo)

(\*One cable is supplied; other cables are not supplied with the projector.)

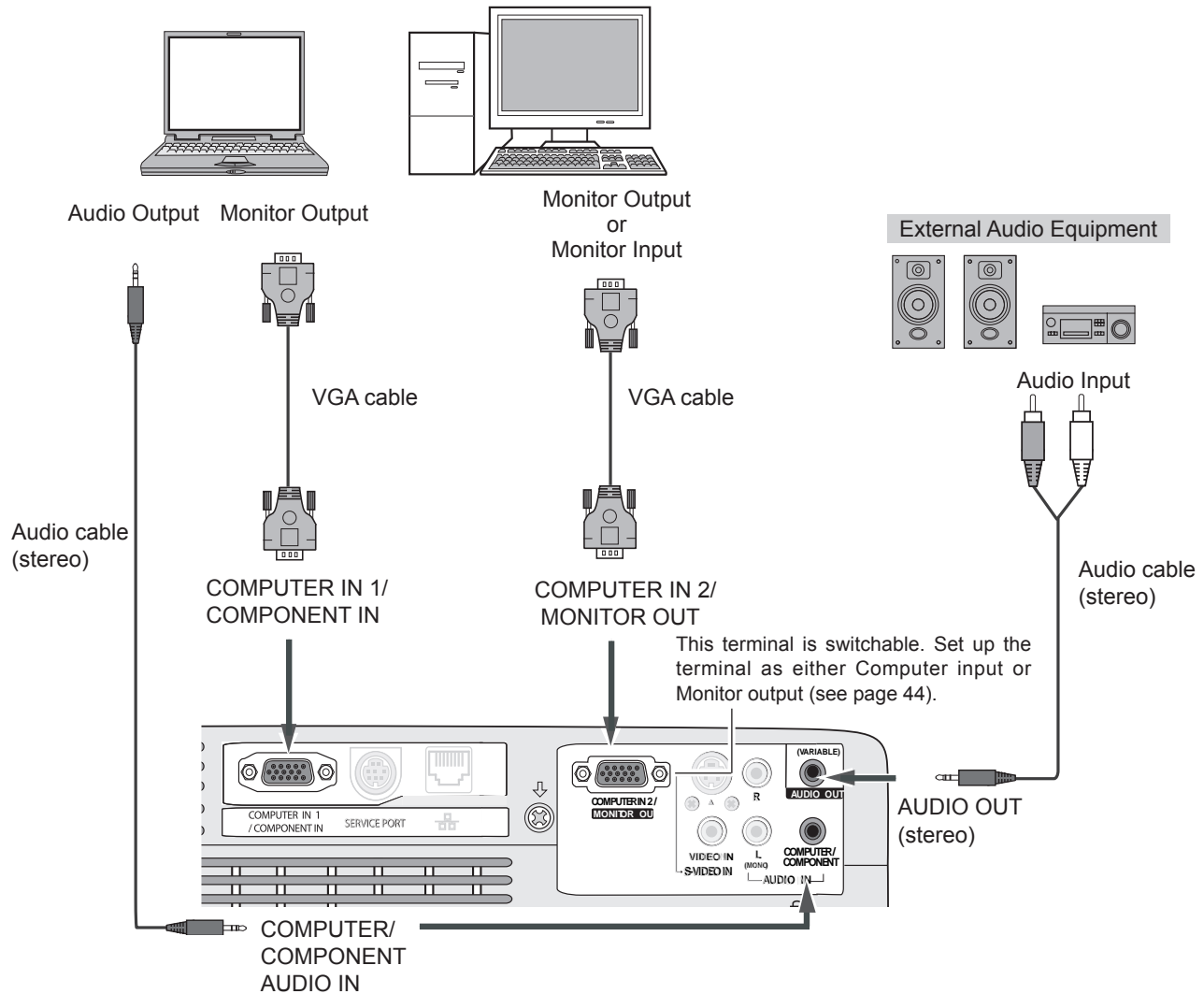

### ✓ Note:

- Input sound to the **COMPUTER/COMPONENT AUDIO IN** terminal when using the **COMPUTER IN 1/COMPONENT IN** and the **COMPUTER IN 2/MONITOR OUT** terminal as input.
- When the **AUDIO OUT** is plugged-in, the projector's built-in speaker is not available.
- When the cable is of the longer variety, it is advisable to use the **COMPUTER IN 1/COMPONENT IN** and not the **COMPUTER IN 2 /MONITOR OUT**.



Unplug the power cords of both the projector and external equipment from the AC outlet before connecting the cables.

## Connecting to Video Equipment

### Cables used for connection

- Video and Audio Cable (RCA x 3)
  - S-VIDEO Cable
  - Audio Cable (Mini Plug: stereo)
- (Cables are not supplied with the projector.)

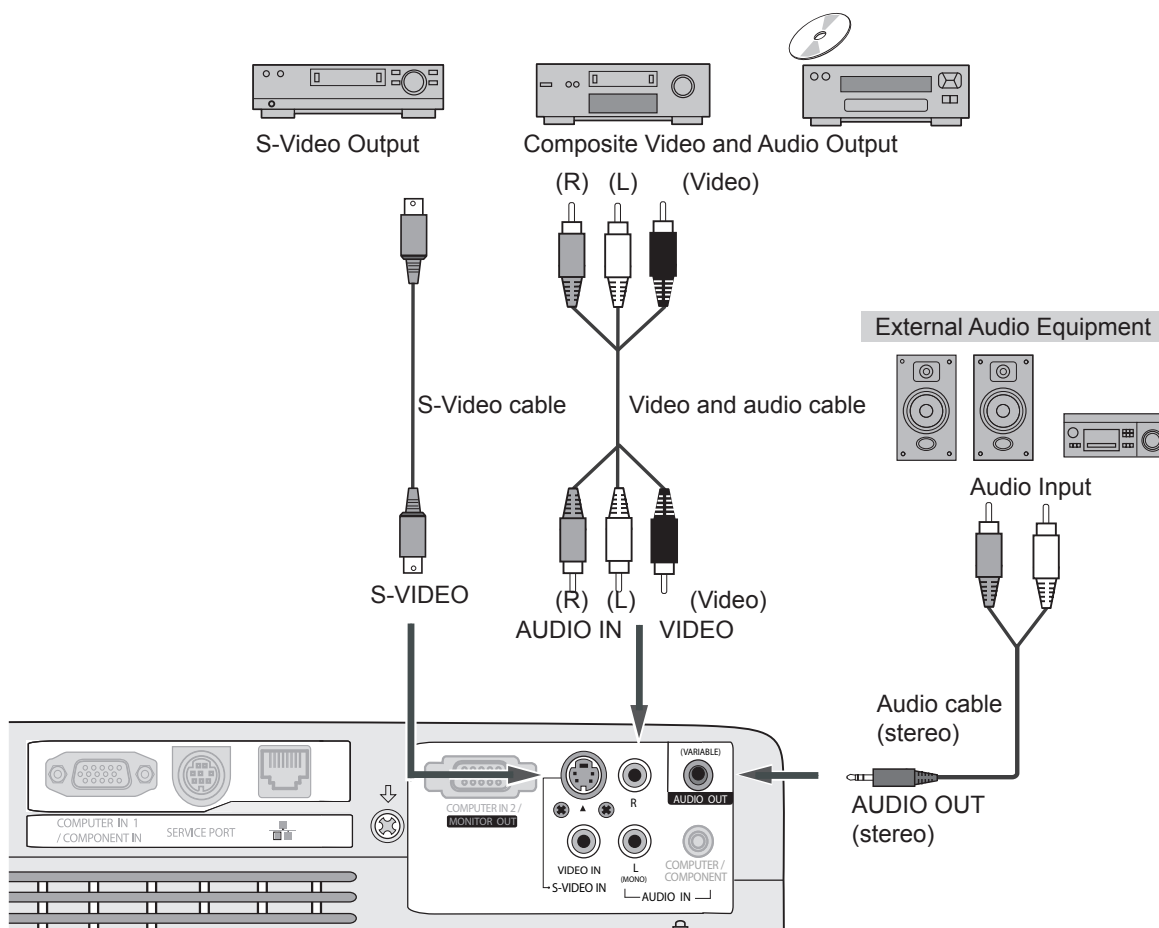

✓ **Note:**

- When the AUDIO OUT is plugged-in, the projector's built-in speaker is not available.
- The S-VIDEO jack connection overrides the VIDEO jack connection when "Auto" is selected in the Input Menu (p.34).



Unplug the power cords of both the projector and external equipment from the AC outlet before connecting the cables.

## Connecting to Component Video Equipment

### Cables used for connection

- Audio Cables (Mini Plug: stereo)
  - Scart-VGA Cable
  - Component Cable
  - Component-VGA Cable
- (Cables are not supplied with the projector.)

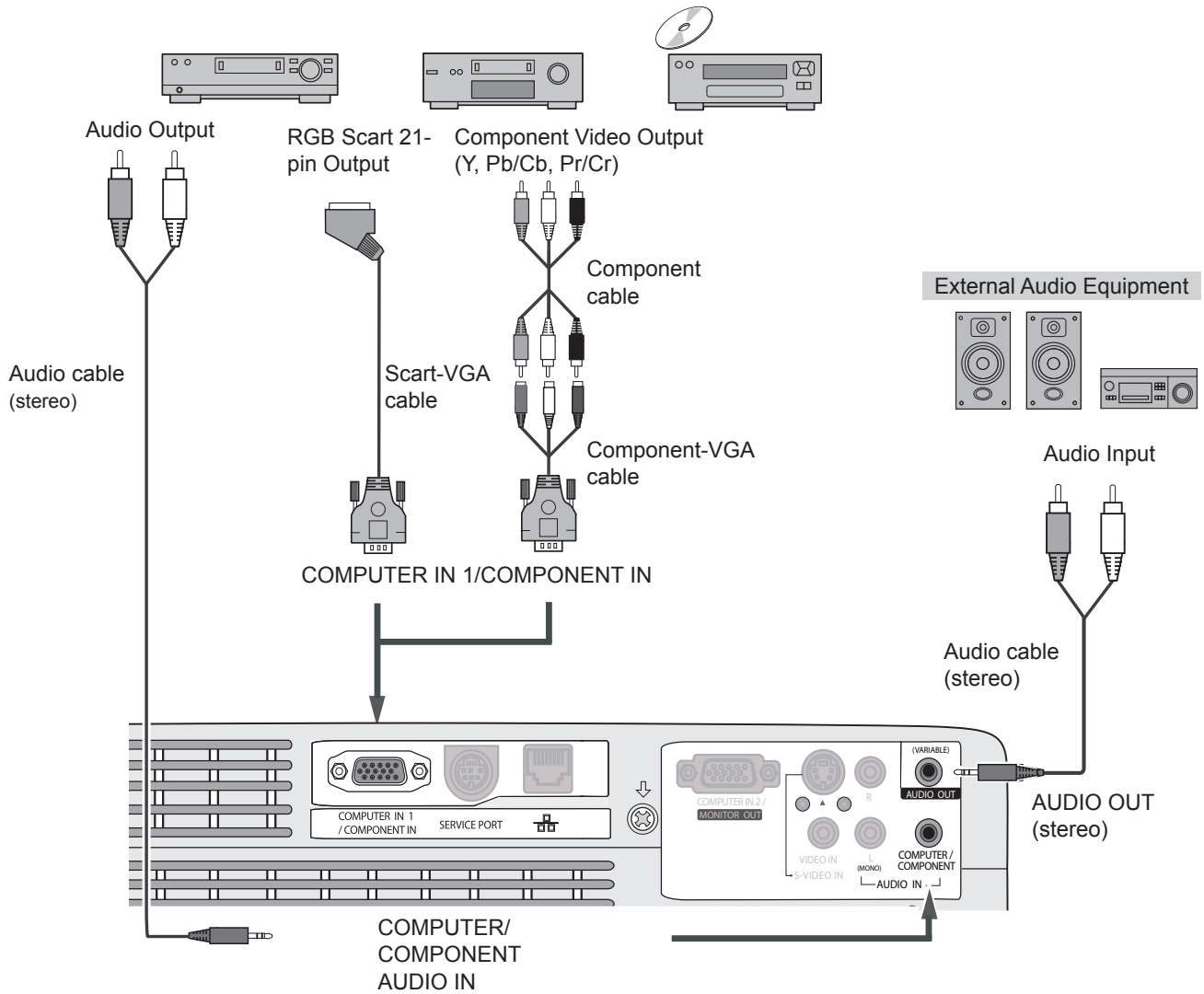

### ✓ Note:

When the AUDIO OUT is plugged-in, the projector's built-in speaker is not available.



Unplug the power cords of both the projector and external equipment from the AC outlet before connecting the cables.

## Connecting the AC Power Cord

This projector uses nominal input voltages of 100–120 V or 200–240 V AC and it automatically selects the correct input voltage. It is designed to work with single-phase power systems having a grounded neutral conductor. To reduce the risk of electrical shock, do not plug into any other type of power system.

If you are not sure of the type of power being supplied, consult your authorized dealer or service station. Connect the projector with all peripheral equipment before turning it on.

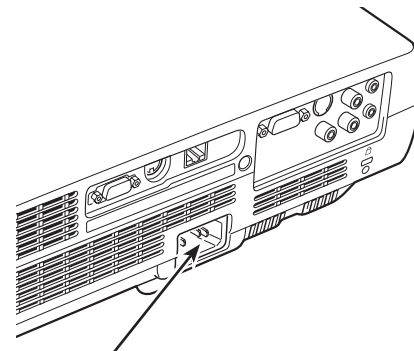

Connect the AC power cord (supplied) to the projector.



### CAUTION



The AC outlet must be near this equipment and must be easily accessible.

✓ **Note:**

Unplug the AC power cord when the projector is not in use. When the projector is connected to an outlet with the AC power cord, it is in stand-by mode and consumes a little electric power.

### NOTE ON THE POWER CORD

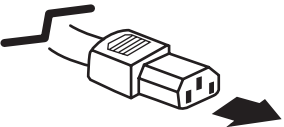
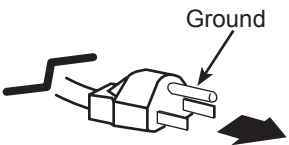
AC power cord must meet the requirements of the country where you use the projector. Confirm the AC plug type with the chart below and proper AC power cord must be used. If the supplied AC power cord does not match your AC outlet, contact your sales dealer.

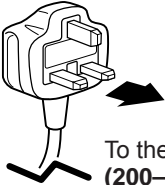
Projector side	AC outlet side		
 <p data-bbox="207 1434 407 1520">To power cord connector on your projector.</p>	<p data-bbox="495 1241 797 1266">For the U.S.A. and Canada</p>  <p data-bbox="570 1451 748 1503">To the AC outlet. (120 V AC)</p>	<p data-bbox="841 1241 1115 1266">For Continental Europe</p>  <p data-bbox="938 1461 1117 1514">To the AC outlet. (200–240 V AC)</p>	<p data-bbox="1239 1241 1377 1266">For the U.K.</p>  <p data-bbox="1263 1451 1442 1503">To the AC outlet. (200–240 V AC)</p>

# Basic Operation

## Turning On the Projector

- 1 Complete peripheral connections (with a computer, VCR, etc.) before turning on the projector.
- 2 Connect the projector's AC power cord into an AC outlet. The POWER indicator turns red. Open the lens cover.
- 3 Press the POWER ON/STAND-BY button on the remote control. The POWER indicator becomes green and the cooling fans start to operate. The preparation display appears on the screen and the count down starts.
- 4 After the countdown, the input source that was selected the last time and the Lamp control status icon (see page 46) will appear on the screen. If the projector is locked with a PIN code, a PIN code Input Dialog Box appears. Enter the PIN code as instructed below.

### Enter a PIN code

Select a number by pressing the Point ▲▼ buttons, and then press the Point ► button to fix the number and move the pointer. The number changes to "\*". If you fixed an incorrect number, move the pointer to the number you want to correct by pressing the Point ◀ button, and then select the correct number by pressing the Point ▲▼ buttons.

Repeat this step to complete entering a four-digit number. "1234" is set as the initial PIN code at the factory.

After entering the four-digit number, move the pointer to "Set" by pressing the Point ► button. Press the SELECT button so that you can start to operate the projector.

If you entered an incorrect PIN code, "PIN code" and the number (\*\*\*\*) turns red. Enter the correct PIN code all over again.

### What is PIN code?

PIN (Personal Identification Number) code is a security code that allows the person who knows it to operate the projector. Setting the PIN code prevents unauthorized use of the projector.

A PIN code consists of a four-digit number. Refer to the PIN code lock function in the Setting Menu on pages 47–48 for locking operation of the projector with your PIN code.



#### CAUTION ON HANDLING THE PIN CODE

If you forget your PIN code, the projector can no longer be started. Take a special care in setting a new PIN code; write down the number in a column on page 69 of this manual and keep it on hand. Should the PIN code be missing or forgotten, consult your dealer or service center.



The preparation display disappears after 30 seconds.

### Selected Input Source and Lamp control



See page 46 for the Lamp control status.

#### ✓Note:

The Filter warning and Lamp replacement icons may appear on the screen depending on the usage state of the projector.

### PIN Code Input Dialog Box

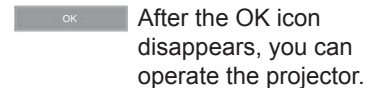
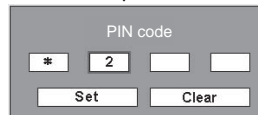
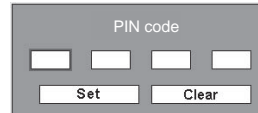

#### ✓Note:

- When the Input Search function is set on On1 or On2, the input signal will be searched automatically (p.44).
- When the Logo select function is "Off," the logo will not be displayed on the screen (p.42).
- When the "Countdown off" or "Off" is selected in the Display function, the countdown will not be shown on the screen (p.41).
- During the countdown period, all operations are invalid.
- If the PIN code number is not entered within three minutes after the PIN code dialog box appeared, the projector will be turned off automatically.
- The "1234" is set as the initial PIN code at the factory.

## Turning Off the Projector

- 1 Press the POWER ON/STAND-BY button on the remote control, and “Power off?” appears on the screen.
- 2 Press the POWER ON/STAND-BY button again to turn off the projector. The POWER indicator starts to blink red, and the cooling fans keep running. (You can select the level of the fans’ quietness and running speed. See page 49.) At this time you can unplug the AC power cord even if the fans are still running.
- 3 When the projector has cooled down enough to be turned on again, the POWER indicator stops blinking.

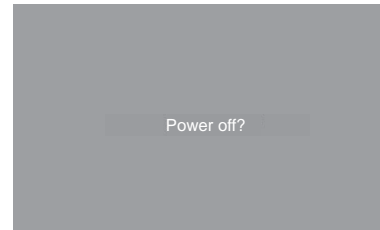

“Power off” disappears after 4 seconds.

 TO MAINTAIN THE LAMP LIFE, ONCE YOU TURN THE PROJECTOR ON, WAIT AT LEAST 5 MINUTES BEFORE TURNING IT OFF.

 DO NOT OPERATE THE PROJECTOR CONTINUOUSLY WITHOUT REST. CONTINUOUS USE MAY RESULT IN SHORTENING THE LAMP LIFE. TURN OFF THE PROJECTOR AND LET STAND FOR ABOUT AN HOUR IN EVERY 24 HOURS.

✓ **Note:**

- When the On start function is “On,” this projector is turned on automatically by connecting the AC power cord to an AC outlet (p. 46).
- The running speed of cooling fans is changed according to the temperature inside the projector.
- Do not put the projector in a case before the projector is cooled enough.
- If the WARNING indicator blinks or emits a red light, see “Warning Indicator” on page 54.
- While the POWER indicator is blinking, the lamp is being cooled down and the projector cannot be turned on. Wait until the POWER indicator stops blinking to turn on the projector again.
- The fan rotation will terminate directly if the AC power cord is unplugged immediately after the projector is turned off.
- The projector can be turned on after the POWER indicator turns red. The waiting time to restart will be shortened when the normal power-off processing for fan cooling is completed, compared with the time the AC power cord is immediately unplugged after the power-off.



## How to Operate the On-Screen Menu

The projector can be adjusted or set via the On-Screen Menu. For each adjustment and setting procedure, refer to the respective sections in this manual.

- 1 Press the MENU button on the remote control to display the On-Screen Menu.
- 2 Use the Point ◀▶ buttons to select a Menu icon; use the Point ▲▼ buttons to select an item.
- 3 Press the SELECT button to show the item data. To adjust the data, use the Point ◀▶ buttons. Refer to the relevant pages for more details about each adjustment.

To close the On-Screen Menu, press the MENU button again.

✓ **Note:**

*The selected item is not active until the SELECT button is pressed.*

### Remote Control

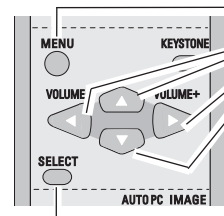

MENU button  
POINT buttons

### SELECT button

### On-Screen Menu

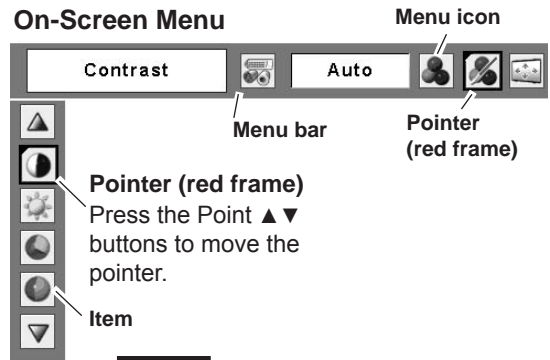

Press the SELECT button here to display previous items.

Press the SELECT button here to display next items.

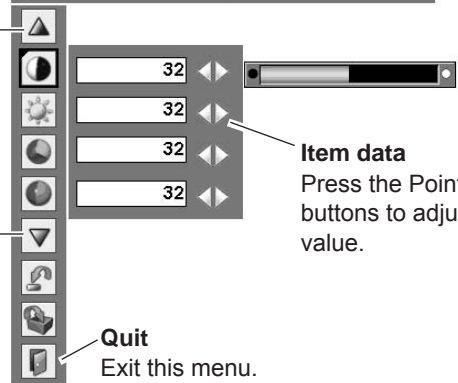

**Item data**  
Press the Point ◀▶ buttons to adjust the value.

**Quit**  
Exit this menu.

## Menu Bar

For detailed functions, see Menu Tree on pages 62-63.

### For computer source

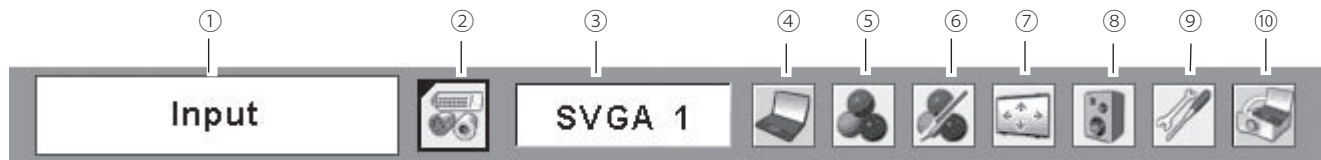

#### ① Guide Window

Shows the selected Menu of the On-Screen Menu.

#### ② Input Menu

Used to select the input source, Computer or Video (p.25).

#### ③ PC System Menu

Used to select the computer system (p.26).

#### ④ PC Adjust Menu

Used to adjust parameters to match with input signal format (pp.27–29).

#### ⑤ Image Select Menu

Used to select an image level from Dynamic, Standard, Real, Blackboard (Green), Colorboard and Image 1–4 (p.30).

#### ⑥ Image Adjust Menu

Used to adjust the computer image from Contrast, Brightness, Color temp., White balance (R/G/B), Sharpness, and Gamma (pp.31–32).

#### ⑦ Screen Menu

Used to adjust the size of image from Normal, True, Full, Custom, and Digital zoom +/- (pp.32–33).

#### ⑧ Sound Menu

Used to adjust the volume or mute the sound (p.23).

#### ⑨ Setting Menu

Used to set the projector's operating configurations (pp.41–50).

#### ⑩ Wired Menu

See owner's manual "Network Set-up and Operation".

#### ✓ Note:

*Items will be same as the items in video source when 480i, 575i, 480p, 575p, 720p, 1035i or 1080i is selected.*

### For video source

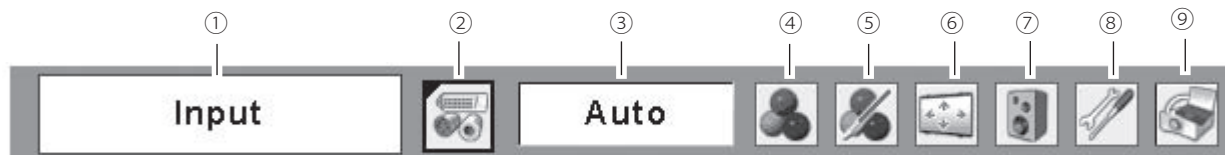

#### ① Guide Window

Shows the selected Menu of the On-Screen Menu.

#### ② Input Menu

Used to select input source, Video or Computer (pp.34–35).

#### ③ AV System Menu

Used to select the system of selected video source (p.36).

#### ④ Image Select Menu

Used to select an image level from Dynamic, Standard, Cinema, Blackboard (Green), Colorboard and Image 1–4 (p.37).

#### ⑤ Image Adjust Menu

Used to adjust the picture image from Contrast, Brightness, Color, Tint, Color temp., White balance (R/G/B), Sharpness, Gamma, Noise reduction, and Progressive (pp.38–39).

#### ⑥ Screen Menu

Used to set the size of image to Normal, Full, Zoom, Wide, Natural wide, or Custom (p.40).

#### ⑦ Sound Menu

Used to adjust the volume or mute the sound (p.23).

#### ⑧ Setting Menu

Used to set the projector's operating configurations (pp.41–50).

#### ⑨ Wired Menu

See owner's manual "Network Set-up and Operation".

## Focus Adjustment

Adjust the lens focus with the focus lever.

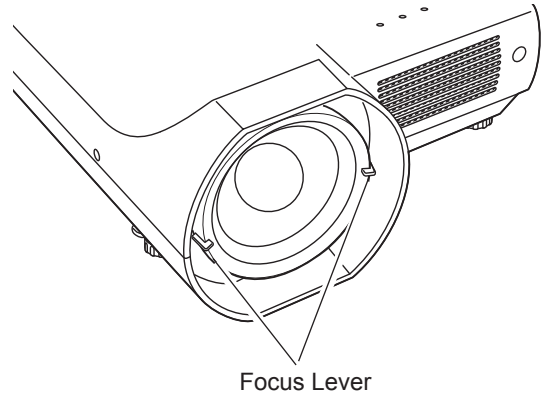

## Keystone Correction

If a projected picture has keystone distortion, correct the image with the Keystone function.

Press the KEYSTONE button on the remote control. The keystone dialog box appears. Correct keystone distortion with the Point ▲▼ buttons. Keystone adjustment can be stored (p.41).

Reduce the upper width with the Point ▲ button.

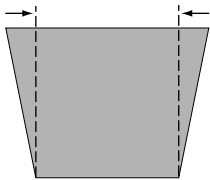

Reduce the lower width with the Point ▼ button.

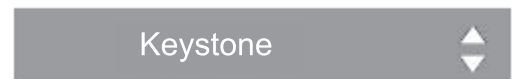
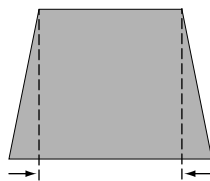

- The arrows are white when there is no correction.
- The direction of the arrow which are being corrected turns red.
- The arrows disappear at the maximum correction.
- If you press the KEYSTONE button on the remote control once more while the keystone dialog box is being displayed, the keystone adjustment is canceled.
- The adjustable range can be limited depending on the input signal.
- The projected picture may fluctuate momentarily depending on the keystone adjustment.
- "Keystone" disappears after 4 seconds.

## Remote Control

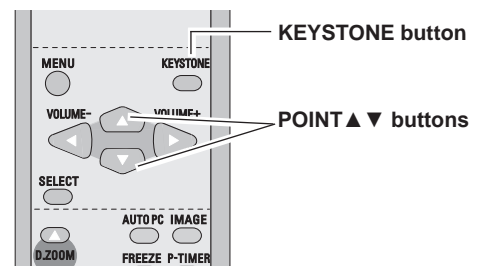

## Sound Adjustment

### Direct Operation

#### Volume

Press the VOLUME+/- buttons on the remote control to adjust the volume. The volume dialog box appears on the screen for a few seconds.

#### Mute

Press the MUTE button on the remote control to turn off the sound. To restore the sound to its previous level, press the MUTE button again or press the VOLUME+/- buttons. Mute function is also effective for AUDIO OUT jack.

### Menu Operation

- 1 Press the MENU button to display the On-Screen Menu. Use the Point ◀▶ buttons to move the red frame pointer to the Sound Menu icon.
- 2 Press the Point ▲▼ buttons to move the red frame pointer to the desired item, and then press the SELECT button.

#### Volume

Press the Point ▶ button to turn up the volume; press the Point ◀ button to turn down the volume.

#### Mute

Press the Point ◀▶ buttons to switch the mute function On/Off. When the sound is turned off, "On" is displayed. Press the Point ◀▶ buttons again to turn the sound back on.

### Remote Control

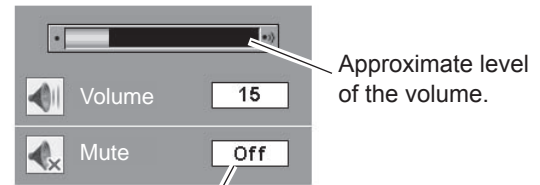
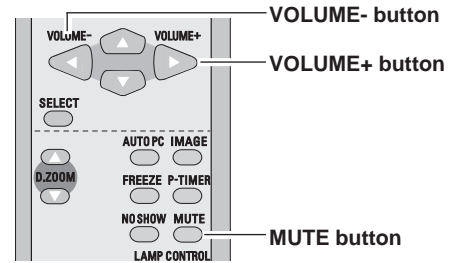

Press the MUTE button to set the Mute function On or Off. The display disappears after 4 seconds.

### Sound Menu

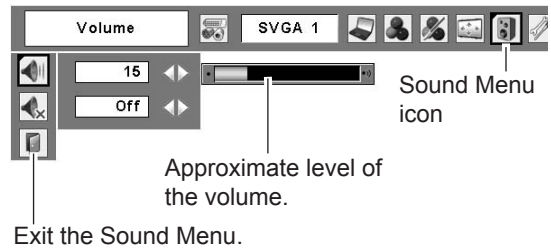

## Remote Control Operation

Using the remote control for some frequently used operations is advisable. Just pressing one of the buttons enables you to make the desired operation quickly without calling up the On-Screen Menu.

### COMPUTER/VIDEO button

Press the COMPUTER or VIDEO button to select an input source. See pages 25, 34–35 for more details.

### FREEZE button

Press the FREEZE button to freeze the picture on the screen. To cancel the Freeze function, press the FREEZE button again or press any other button.

### Remote Control

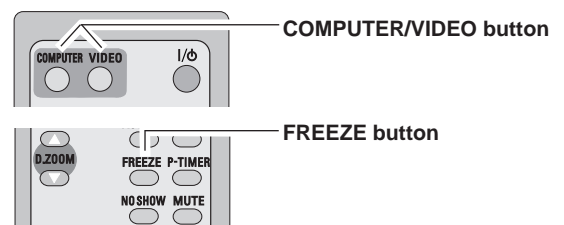

#### ✓ Note:

See the next page for the description of other buttons.

## AUTO PC button

Press the AUTO PC button to operate the Auto PC function. See page 27 for more details.

## D.ZOOM buttons

Press the D.ZOOM buttons to zoom in and zoom out the images. See page 33 for more details.

## NO SHOW button

Press the NO SHOW button to black out the image. To restore to normal, press the NO SHOW button again or press any other button. When the projected image is captured and is set as "User" in the Logo selection (p.42), the screen changes each time you press the NO SHOW button as follows.

black out → the captured image → normal → .....

## KEYSTONE button

For details, see page 22.

## IMAGE button

Press the IMAGE button to select an image level of the screen. See pages 30, 37 for more details.

## P-TIMER button

Press the P-TIMER button. The timer display "00:00" appears on the screen and the timer starts to count time (00:00–59:59).

To stop the P-Timer, press the P-TIMER button. Press the P-TIMER button again, then the P-timer display disappears.

## LAMP CONTROL button

Press the LAMP CONTROL button to select the lamp mode to change the brightness of the screen.

- 💡 High ..... Brighter than the Normal mode
- 💡 Auto ..... Brightness according with the input signal
- 💡 Normal ... Normal brightness

## Remote Control

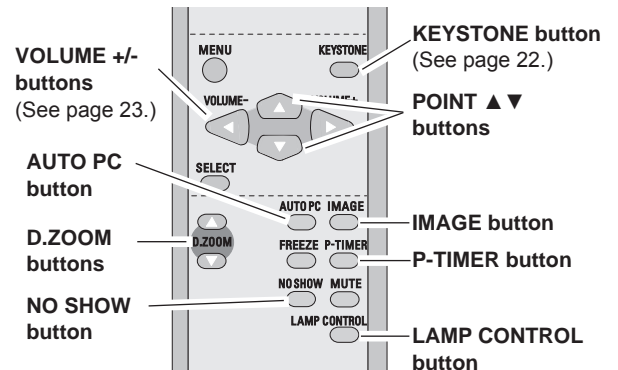

### ✓ Note:

See the previous page for the description of other buttons.

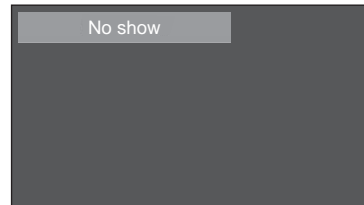

"No show" disappears after 4 seconds.



P-Timer display

# Computer Input

## Input Source Selection

### Direct Operation

Select either Computer 1 or Computer 2 by pressing the COMPUTER button on the remote control. Before using COMPUTER button, select the correct input source through Menu operation as described below.

### Remote Control

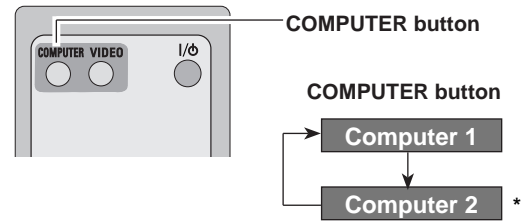

\*See Notes at the bottom of this page.

### Menu Operation

- 1 Press the MENU button to display the On-Screen Menu. Use the Point ◀▶ buttons to move the red frame pointer to the Input Menu icon.
- 2 Use the Point ▲▼ buttons to move the red arrow pointer to either Computer 1 or Computer 2, and then press the SELECT button.
- 3 After the Source Select Menu appeared for Computer 1, move the pointer to RGB and then press the SELECT button.

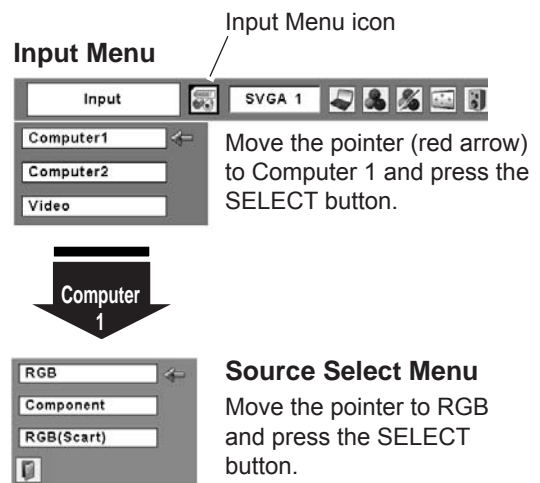

#### ✓ Note:

- Computer 2 is not displayed when the COMPUTER IN 2/MONITOR OUT terminal is set as Monitor out (p.44).
- Computer 2 (COMPUTER IN 2/MONITOR OUT) can accept only the RGB signal.
- When the Input Search function is set On1 or On2, the input signal will be searched automatically (p.44)

### Input Menu

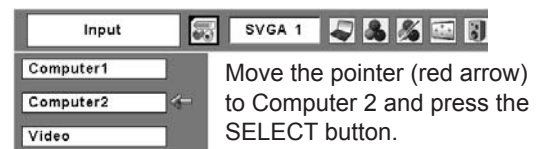



## Computer System Selection

The projector automatically tunes to various types of computers based on VGA, SVGA, XGA, SXGA, WXGA, or UXGA with its Multi-scan system and Auto PC Adjustment. If computer is selected as a signal source, the projector automatically detects the signal format and tunes to project proper images without any additional setting. (Signal formats provided in this projector is shown on page 65.)

One of the following messages may appear when:

**Auto** The projector cannot recognize the connected signal conforming to the provided PC Systems. "Auto" is displayed on the PC System Menu icon and the Auto PC Adjustment function works to display proper images. If images are not projected properly, adjust manually. (pp.28–29)

----- There is no signal input from computer. Check the connection between your computer and the projector. (See "Troubleshooting" on page 59.)

**Mode 1** The preset system is manually adjusted in the PC Adjust Menu. The adjusted data can be stored in Mode 1–5 (pp.28–29).

**SVGA 1** A PC System provided in the projector is selected. The projector selects a proper system provided in the projector and displays it.

\*Mode 1 and SVGA 1 are examples.

### PC System Menu

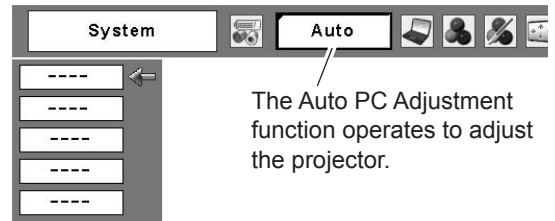

### Selecting Computer System Manually

PC system can also be selected manually.

**1** Press the MENU button to display the On-Screen Menu. Use the Point ◀▶ buttons to move the red frame pointer to the PC System Menu icon.

**2** Use the Point ▲▼ buttons to move the red arrow pointer to the desired system, and then press the SELECT button.

### PC System Menu

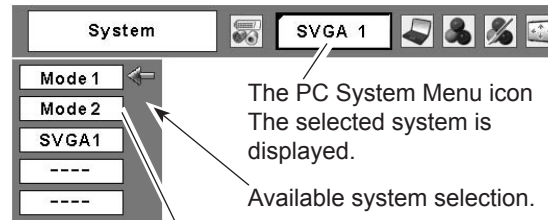

Custom Mode (1–5) set in the PC Adjust Menu (pp.28-29).

## Auto PC Adjustment

Auto PC Adjustment function is provided to automatically adjust Fine sync, Total dots, Horizontal, and Vertical positions to conform to your computer.

### Direct Operation

The Auto PC adjustment function can be operated directly with the AUTO PC button on the remote control.

### Remote Control

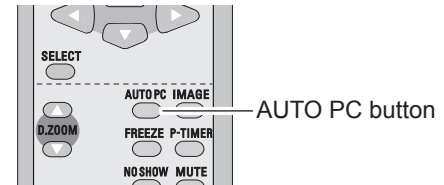

### Menu Operation

#### Auto PC adj.

- 1 Press the MENU button to display the On-Screen Menu. Use the Point ◀▶ buttons to move the red frame pointer to PC Adjust Menu.
- 2 Use the Point ▲▼ buttons to move the red frame pointer to Auto PC adj. and then press the SELECT button twice.

#### To store the adjusted parameters

The system parameters adjusted in the Auto PC Adjustment can be stored in the projector. Once parameters are stored, the setting can be done just by selecting a Mode in the PC System Menu (p.26). See "Store" on page 29, for details.

#### ✓ Note:

- Fine sync, Total dots, Horizontal, and Vertical positions of some computers cannot be fully adjusted with this Auto PC Adjustment function. When the image is not provided properly with this operation, manual adjustments are required (pp.28–29).
- The Auto PC Adjustment cannot be operated when 480i, 575i, 480p, 575p, 720p, 1035i, or 1080i is selected in the PC System Menu (p.26).

### PC Adjust Menu

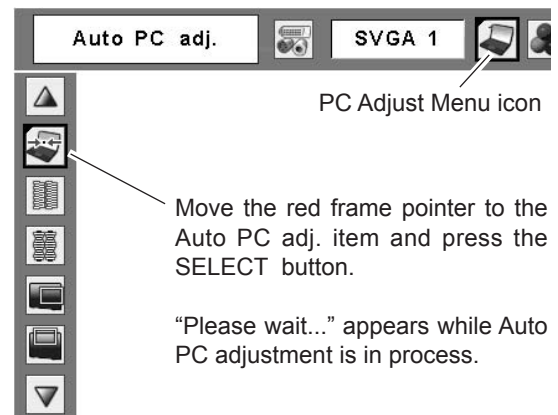

## Manual PC Adjustment

Some computers employ special signal formats which may not be tuned by Multi-scan system of this projector. Manual PC Adjustment enables you to precisely adjust several parameters to match those signal formats. The projector has five independent memory areas (Mode 1–5) to store those parameters manually adjusted, which allows you to recall the setting for a specific computer.

- 1 Press the MENU button to display the On-Screen Menu. Use the Point ◀▶ buttons to move the red frame pointer to the PC Adjust Menu icon.
- 2 Use the Point ▲▼ buttons to move the red frame pointer to the desired item and then press the SELECT button to display the adjustment dialog box. Press the Point ◀▶ buttons to adjust the value.

### Fine sync

Use the Point ◀▶ buttons to adjust the value to cut off flicker from the image displayed (from 0 to 31).

### Total dots

Use the Point ◀▶ buttons to adjust the number of total dots in one horizontal period to match your PC image.

### Horizontal

Use the Point ◀▶ buttons to adjust the horizontal picture position.

### Vertical

Use the Point ◀▶ buttons to adjust the vertical picture position.

### Current mode

Press the SELECT button to show H-sync freq. and V-sync freq. of the connected computer.

### Clamp

Use the Point ◀▶ buttons to adjust the clamp level. When the image has dark bars, try this adjustment.

**PC Adjust Menu** PC Adjust Menu icon

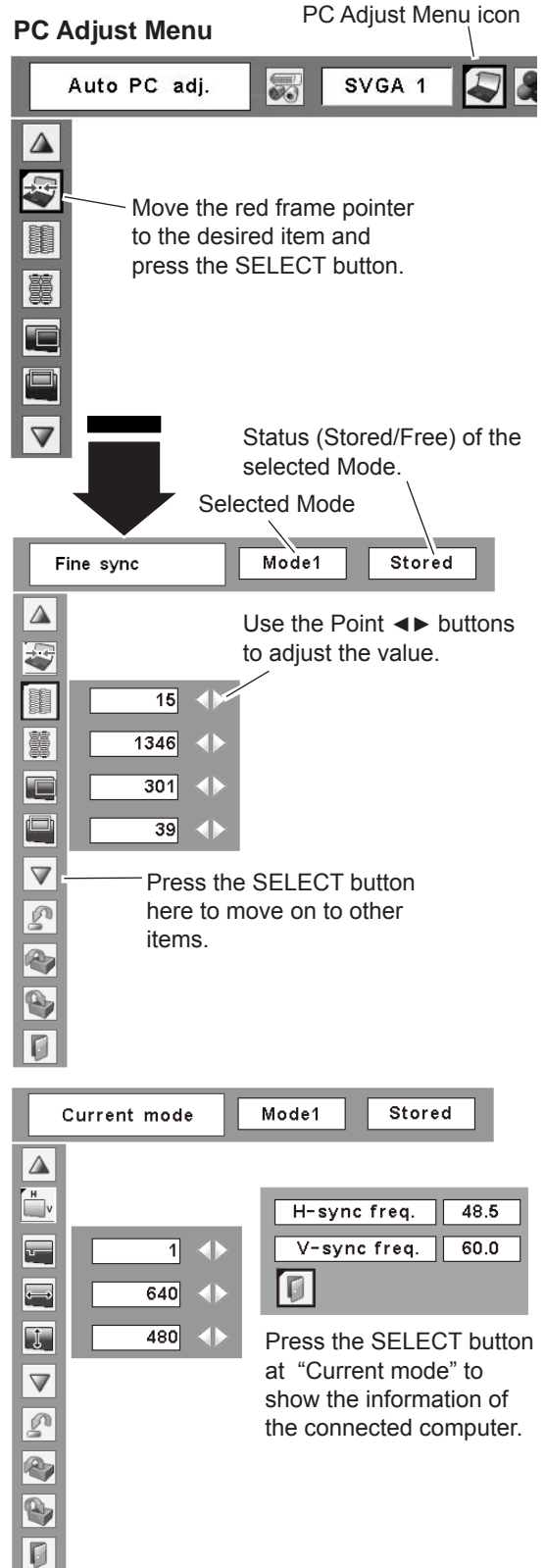

Auto PC adj. SVGA 1

Move the red frame pointer to the desired item and press the SELECT button.

Status (Stored/Free) of the selected Mode.

Selected Mode

Fine sync Mode1 Stored

Use the Point ◀▶ buttons to adjust the value.

15 1346 301 39

Press the SELECT button here to move on to other items.

Current mode Mode1 Stored

H-sync freq. 48.5  
V-sync freq. 60.0

Press the SELECT button at "Current mode" to show the information of the connected computer.

1 640 480

## Display area H

Use the Point ◀▶ buttons to adjust the horizontal area displayed by this projector.

## Display area V

Use the Point ◀▶ buttons to adjust the vertical area displayed by this projector.

## Reset

To reset the adjusted data, select “Reset” and press the SELECT button. A confirmation box appears and then select “Yes.” All adjustments return to their previous figures.

## Mode free

To clear the stored data, select “Mode free” and then press the SELECT button. Move the red arrow pointer to the Mode that you want to clear and then press the SELECT button.

## Store

To store the adjusted data, select “Store” and then press the SELECT button. Move the red arrow pointer to one of the Mode 1 to 5 in which you want to store, and then press the SELECT button.

## Quit

Exit the PC Adjust Menu.

### ✓ Note:

*Display area (H/V) cannot be selected when 480i, 575i, 480p, 575p, 720p, 1035i, or 1080i is selected in the PC System Menu (p.26).*

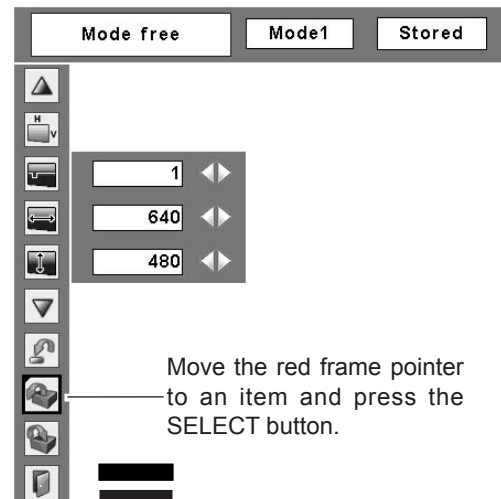

Move the red frame pointer to an item and press the SELECT button.

**To clear adjusted data** This Mode has stored parameters.

Where to free?		800	142	34	1024	768
Mode1	Stored	800	142	34	1024	768
Mode2	Free	800	142	34	1024	768
Mode3	Free	800	142	34	1024	768
Mode4	Free	800	142	34	1024	768
Mode5	Free	800	142	34	1024	768

Vacant Mode

Values of “Total dots,” “Horizontal,” “Vertical,” “Display area H,” and “Display area V.”

### To store adjusted data

Where to store?		800	142	34	1024	768
Mode1	Stored	800	142	34	1024	768
Mode2	Free	800	142	34	1024	768
Mode3	Free	800	142	34	1024	768
Mode4	Free	800	142	34	1024	768
Mode5	Free	800	142	34	1024	768

Close this dialog box.

## Image Level Selection

### Direct Operation

Select an image level from among Dynamic, Standard, Real, Blackboard (Green), Colorboard, Image 1, Image 2, Image 3, and Image 4 with the IMAGE button on the remote control.

### Dynamic

For viewing pictures in a bright room.

### Standard

Normal picture level preset on the projector.

### Real

Picture level with improved halftone for graphics.

### Blackboard (Green)

For viewing the image projected on a blackboard. This mode assists to enhance the image projected on a blackboard. This is mainly effective on a green colored board, not truly effective on a black colored board.

### Colorboard

At the time of simple projection on the colored wall, you can get the close color image to the color image projected on a white screen by selecting the similar color to the wall color from the preset four colors.

### Image 1-4

User preset image in the Image Adjust Menu (pp.31-32).

### Menu Operation

- 1 Press the MENU button to display the On-Screen Menu. Use the Point ◀▶ buttons to move the red frame pointer to the Image Select Menu icon.
- 2 Use the Point ▲▼ buttons to move the red frame pointer to the desired level and then press the SELECT button.

### Dynamic

For viewing pictures in a bright room.

### Standard

Normal picture level preset on this projector.

### Real

Picture level with improved halftone for graphics.

### Blackboard(Green)

For viewing the image projected on a blackboard. See above for further description.

### Colorboard

At the time of simple projection on the colored wall, you can get the close color image to the color image projected on a white screen by selecting the similar color to the wall color from the preset four colors. Press the SELECT button to choose the color.

### Image 1-4

User preset image in the Image Adjust Menu (pp.31-32).

### Remote Control

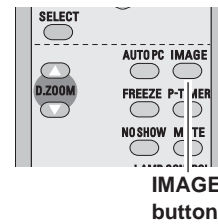

### IMAGE button

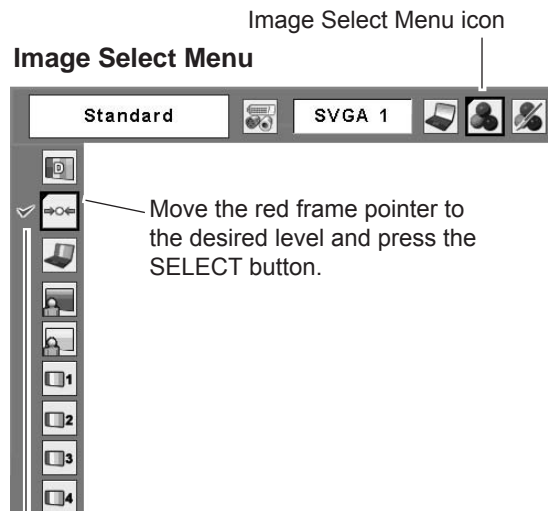
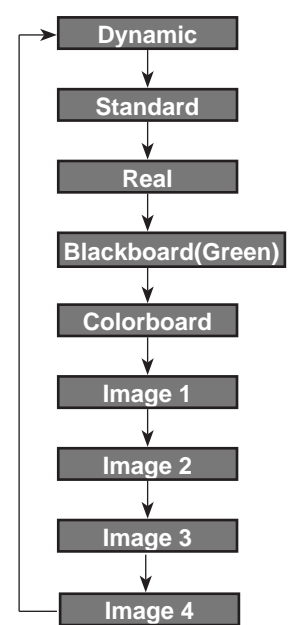

The image level being selected.

## Image Level Adjustment

- 1 Press the MENU button to display the On-Screen Menu. Use the Point ◀▶ buttons to move the red frame pointer to the Image Adjust Menu icon.
- 2 Use the Point ▲▼ buttons to move the red frame pointer to the desired item, and then press the SELECT button. The level of each item is displayed. Use the Point ◀▶ buttons to adjust each level.

### Contrast

Press the Point ◀ button to decrease the contrast; press the Point ▶ button to increase the contrast (from 0 to 63).

### Brightness

Press the Point ◀ button to decrease the brightness; press the Point ▶ button to increase the brightness (from 0 to 63).

### Color temp.

Use the Point ◀▶ buttons to select the desired Color temp. level (XLow, Low, Mid, or High).

### White balance (Red)

Press the Point ◀ button to lighten the red tone; press the Point ▶ button to deepen the red tone (from 0 to 63).

### White balance (Green)

Press the Point ◀ button to lighten the green tone; press the Point ▶ button to deepen the green tone (from 0 to 63).

### White balance (Blue)

Press the Point ◀ button to lighten the blue tone; press the Point ▶ button to deepen the blue tone (from 0 to 63).

### Sharpness

Press the Point ◀ button to decrease the sharpness of the image; press the Point ▶ button to increase the sharpness of the image (from 0 to 15).

### Gamma

Use the Point ◀▶ buttons to adjust the gamma value to get better balance of contrast (from 0 to 15).

### Reset

To reset the adjusted data, select “Reset” and press the SELECT button. A confirmation box appears and then select “Yes.” All adjustments return to their previous figures.

## Image Adjust Menu

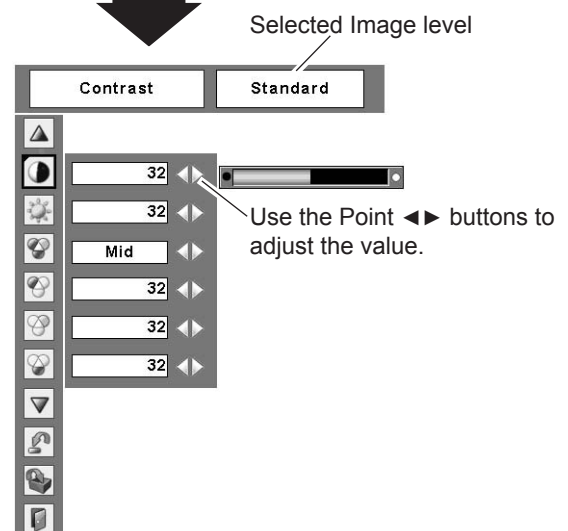
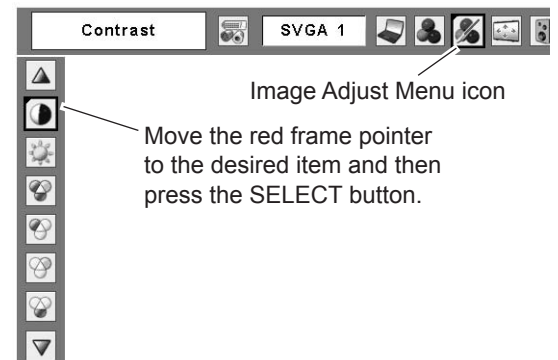

### ✓Note:

*After adjusting the White balance Red, Green, or Blue, the Color temp. level will change to “Adj.”*



## Store

To store the adjusted data, select “Store” and press the SELECT button. The Image Level Menu appears. Use the Point ▲▼ buttons to choose one of the four image level and press the SELECT button. A confirmation box appears and then select “Yes.”

The stored data can be called up by selecting “Image” in the Image Level Selection on page 30.



## Quit

Exit the Image Adjust Menu.

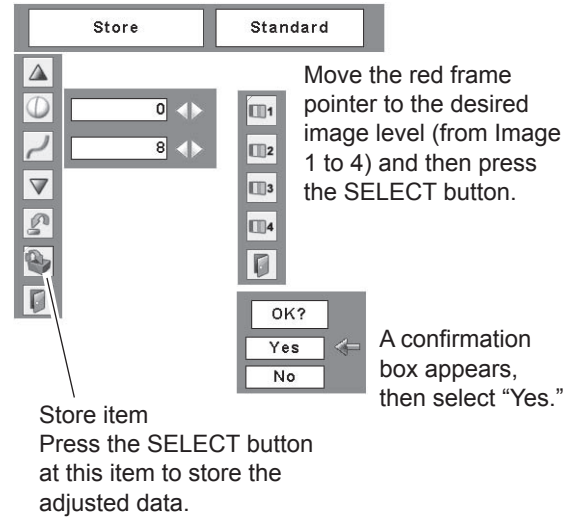

## Screen Size Adjustment

This projector has the picture screen resize function, which enables you to customize the image size.

- 1 Press the MENU button to display the On-Screen Menu. Use the Point ◀▶ buttons to move the red frame pointer to the Screen Menu icon.
- 2 Use the Point ▲▼ buttons and move the red frame pointer to the desired function and then press the SELECT button.



## Normal

Provide the image to fit the screen size while maintaining the aspect ratio of input signal.



## True

Provide the image in its original size. When the original image size is larger than the screen size (1280 x 800), the projector automatically switches to the panning mode. Use the Point ◀▶ ▲▼ buttons to pan the image. When adjusted, the arrows turn red. When reached to the correction limit, the arrows disappear.



## Full

Provide the full screen image.

## Screen Menu

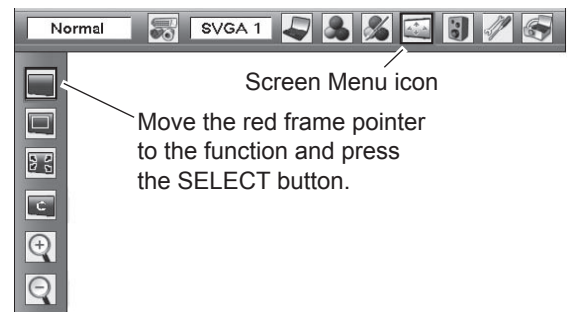

### ✓Note:

- This projector cannot display any resolution higher than 1600 x 1200. If your computer's resolution is higher than that, lower the resolution before connecting to the projector.
- The image data other than 1280 x 800 is modified to fit the screen size in initial mode.
- True, Full and D.Zoom+/- are not available when the 4:3 or 16:9 function is selected in the Screen aspect (p.44).
- The items will be same as the items in video source when 480i, 575i, 480p, 575p, 720p, 1035i or 1080i is selected in the PC system Menu (p.26).



## Custom

Adjust the screen scale and position manually with this function.

Press the SELECT button at Custom and the “Custom” is displayed on the screen for a few seconds and then the Aspect dialog box appears.

Scale H/V.....Adjust the Horizontal/Vertical screen scale.

H&V .....When set to “On,” the aspect ratio is fixed. “Scale V” appears dimmed and becomes unavailable. Adjust “Scale H,” then the screen scale is automatically modified based on the aspect ratio.

Position H/V.....Adjust the Horizontal/Vertical screen position.

Common..... Save the adjusted scale to all the inputs. Press the SELECT button at Common to display a confirmation box. To save the scale, press the SELECT button at “Yes.” When Custom is selected, the saved scale is used.

Reset..... Reset the all adjusted values. Press the SELECT button at Reset to display a confirmation box. To reset, press the SELECT button at “Yes.”

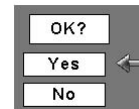
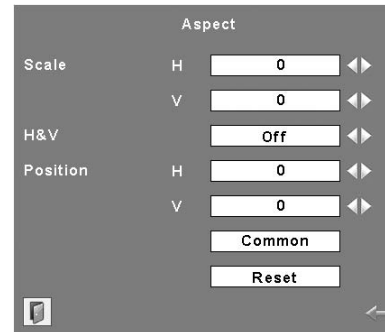

Press the SELECT button at Common or Reset, to display a confirmation box.

### ✓Note:

- When no signal is detected, “Normal” is set automatically and the Aspect dialog box disappears.
- The adjustable range for Scale H/V and Position H/V is limited depending on the input signal.
- When “Custom” is selected , “Digital zoom -” is invalid.

## For zooming in and out the images

### Digital zoom +

When Digital zoom + is selected, the On-Screen Menu disappears and “D. zoom +” is displayed. Press the SELECT button to expand the image size. Use the Point  buttons to pan the image. The Panning function can work only when the image is larger than the screen size.

A projected image can be also expanded by pressing the D.ZOOM  button on the remote control.

### Digital zoom -

When Digital zoom - is selected, the On-Screen Menu disappears and “D. zoom -” is displayed. Press the SELECT button to compress image size.

The projected image can be also compressed by pressing the D.ZOOM  button on the remote control.

To exit the Digital zoom +/- mode, press any button except the D.ZOOM , SELECT, and Point buttons.

To return to the previous screen size, select a screen size in the Screen Size Adjustment or select an input source from the Input Source Selection (p.25) again, or adjust the screen size with the D.ZOOM  buttons.

## Remote Control

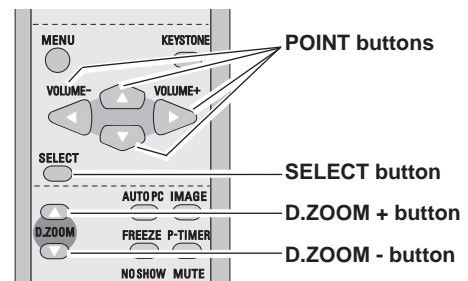

### ✓Note:

- The panning function may not operate properly if the stored Mode in the PC Adjust Menu is used (p.29).
- The minimum compression ratio can be limited depending on the input signal or when the Keystone function is working or when the custom is selected for the screen size.
- The items will be same as the items in video source when 480i, 575i, 480p, 575p, 720p, 1035i or 1080i is selected in the PC system Menu (p.26).
- Digital zoom +/- cannot be selected when Full or True is selected.
- When “Custom” is selected , “Digital zoom -” is invalid.
- True, Full and D.Zoom+/- are not available when the 4:3 or 16:9 function is selected in the Screen aspect (p.44).

# Video Input

## Input Source Selection (Video, S-video)

### Direct Operation

Select Video by pressing the VIDEO button on the remote control.

Before using VIDEO button, select the correct input source through menu operation as described below.

### Remote Control

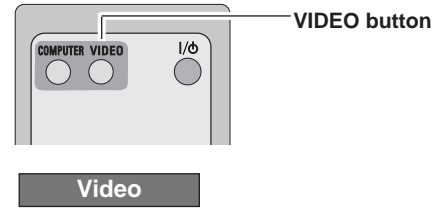

### Menu Operation

- 1 Use the MENU button to display the On-Screen Menu. Press the Point ◀▶ buttons to move the red frame pointer to the Input Menu icon.
- 2 Use the Point ▲▼ buttons to move the red arrow pointer to Video and then press the SELECT button to display the Source Select Menu .
- 3 Move the pointer to the desired source and then press the SELECT button.

**Auto** When selecting "Auto," the projector automatically detects the incoming video signal, and adjusts itself to optimize its performance. The projector selects connection in the following order:

1. S-video
2. Video

**Video** When the video input signal is connected to the VIDEO jack, select Video.

**S-video** When the video input signal is connected to the S-VIDEO jack, select S-video.

#### ✓ Note:

- Computer 2 is not displayed when the COMPUTER IN 2/MONITOR OUT terminal is set as Monitor out (p.44).
- When the Input Search function is set On1 or On2, the input signal will be searched automatically (p.44).

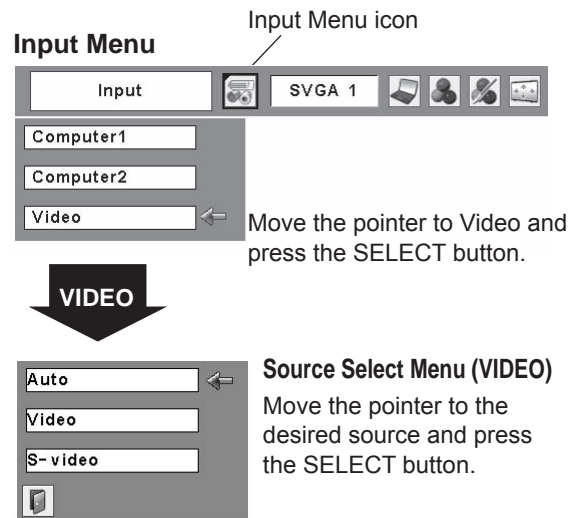

## Input Source Selection (Component, RGB Scart 21-pin)

### Direct Operation

Select Computer 1 by pressing the COMPUTER button on the remote control.  
 Before using COMPUTER button, select the correct input source through Menu operation as described below.

### Remote Control

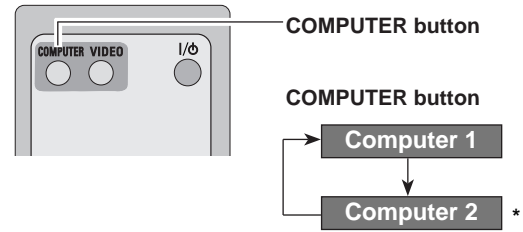

\*See Note at the bottom of this page.

### Menu Operation

- 1 Use the MENU button to display the On-Screen Menu. Press the Point ◀▶ buttons to move the red frame pointer to the Input Menu icon.
- 2 Use the Point ▲▼ buttons to move the red arrow pointer to Computer 1 and then press the SELECT button.
- 3 After the Source Select Menu appeared for Computer 1, move the pointer to Component or RGB (Scart) and then press the SELECT button.

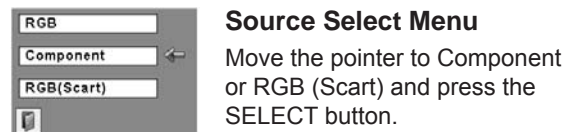
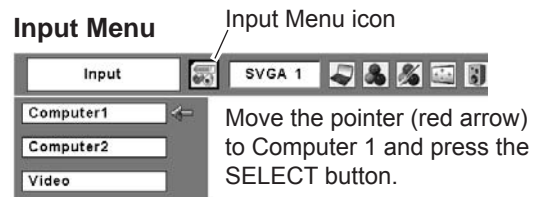

- Component** When the input source is coming from video equipment connected to the COMPUTER IN 1/COMPONENT IN terminal with a Component-VGA Cable (not supplied), select Component.
- RGB (Scart)** When the input source is coming from video equipment connected to the COMPUTER IN 1/COMPONENT IN terminal with a Scart-VGA Cable (not supplied), select RGB (Scart).

✓ **Note:**

- Computer 2 is not displayed when the COMPUTER IN 2/ MONITOR OUT terminal is set as Monitor out (p.44).
- Computer 2 (COMPUTER IN 2/MONITOR OUT) can accept only RGB signal.
- When the Input Search function is set On1 or On2, the input signal will be searched automatically (p.44)

## Video System Selection

- 1 Press the MENU button to display the On-Screen Menu. Use the Point ◀▶ buttons to move the red frame pointer to the AV System Menu icon.
- 2 Use the Point ▲▼ buttons to move the red arrow pointer to the desired system and then press the SELECT button.

### Video or S-video

#### Auto

The projector automatically detects an incoming video system, and adjusts itself to optimize its performance. When Video System is PAL-M or PAL-N, select the system manually.

#### PAL/SECAM/NTSC/NTSC4.43/PAL-M/PAL-N

If the projector cannot reproduce proper video image, select a specific broadcast signal format from among PAL, SECAM, NTSC, NTSC 4.43, PAL-M, and PAL-N.

### AV System Menu (Video or S-video)

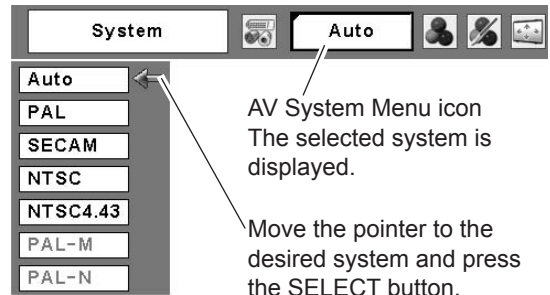

### Component

#### Auto

The projector automatically detects an incoming video signal, and adjusts itself to optimize its performance.

#### COMPONENT VIDEO SIGNAL FORMAT

If the projector cannot reproduce proper video image, select a specific component video signal format from among 480i, 575i, 480p, 575p, 720p, 1035i, and 1080i.

### AV System Menu (Component)

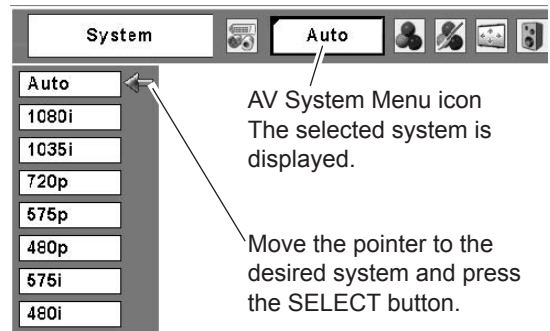

✓ **Note:**

*The AV System Menu cannot be selected when selecting RGB (Scart).*

## Image Level Selection

### Direct Operation

Select an image level from among Dynamic, Standard, Cinema, Blackboard (Green), Colorboard, Image 1, Image 2, Image 3, and Image 4 with the IMAGE button on the remote control.

#### Dynamic

For viewing pictures in a bright room.

#### Standard

Normal picture level preset on this projector.

#### Cinema

Picture level adjusted for the picture with fine tone.

#### Blackboard (Green)

For viewing the image projected on a blackboard. This mode assists to enhance the image projected on a blackboard. This is mainly effective on a green colored board, not truly effective on a black colored board.

#### Colorboard

At the time of simple projection on the colored wall, you can get the close color image to the color image projected on a white screen by selecting the similar color to the wall color from the preset four colors.

#### Image 1–4

User preset image in the Image Adjust Menu (pp. 38-39).

### Menu Operation

- 1 Press the MENU button to display the On-Screen Menu. Use the Point ◀▶ buttons to move the red frame pointer to the Image Select Menu icon.
- 2 Use the Point ▲▼ buttons to move the red frame pointer to the desired level and then press the SELECT button.

#### Dynamic

For viewing pictures in a bright room.

#### Standard

Normal picture level preset on this projector.

#### Cinema

Picture level with improved halftone for graphics.

#### Blackboard(Green)

For viewing the image projected on a blackboard. See above for further description.

#### Colorboard

At the time of simple projection on the colored wall, you can get the close color image to the color image projected on a white screen by selecting the similar color to the wall color from the preset four colors. Press the SELECT button to choose the color.

#### Image 1–4

User preset image in the Image Adjust Menu (pp. 38-39).

### Remote Control

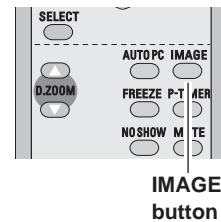

### IMAGE button

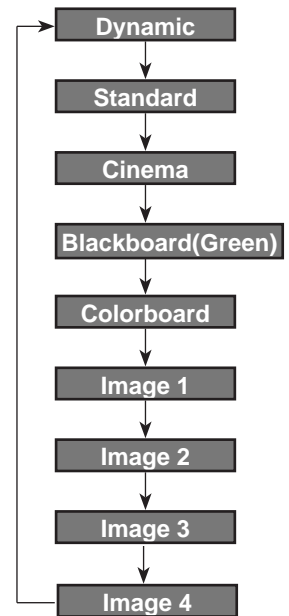

### Image Select Menu

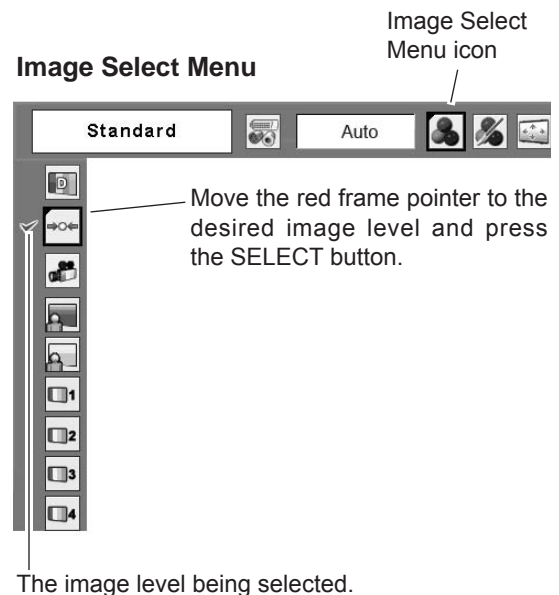

## Image Level Adjustment

- 1 Press the MENU button to display the On-Screen Menu. Use the Point ◀▶ buttons to move the red frame pointer to the Image Adjust Menu icon.
- 2 Use the Point ▲▼ buttons to move the red frame pointer to the desired item and then press the SELECT button. The level of each item is displayed. Adjust each level by pressing the Point ◀▶ buttons.

### Contrast

Press the Point ◀ button to decrease the contrast; press the Point ▶ button to increase the contrast (from 0 to 63).

### Brightness

Press the Point ◀ button to decrease the brightness; press the Point ▶ button to increase the brightness (from 0 to 63).

### Color

Press the Point ◀ button to decrease the intensity of the color; press the Point ▶ button to increase the intensity of the color (from 0 to 63).

### Tint

Use the Point ◀▶ buttons to adjust the tint value to get a proper color balance (from 0 to 63).

### Color temp.

Use the Point ◀▶ buttons to select the desired Color temp. level (XLow, Low, Mid, or High).

### White balance (Red)

Press the Point ◀ button to lighten the red tone; press the Point ▶ button to deepen the red tone (from 0 to 63).

### White balance (Green)

Press the Point ◀ button to lighten the green tone; press the Point ▶ button to deepen the green tone (from 0 to 63).

### White balance (Blue)

Press the Point ◀ button to lighten the blue tone; press the Point ▶ button to deepen the blue tone (from 0 to 63).

✓ **Note:**

- The Tint cannot be selected when the video system is PAL, SECAM, PAL-M, or PAL-N.
- After adjusting the White balance Red, Green or Blue, the Color temp. level will change to "Adj."

### Image Adjust Menu

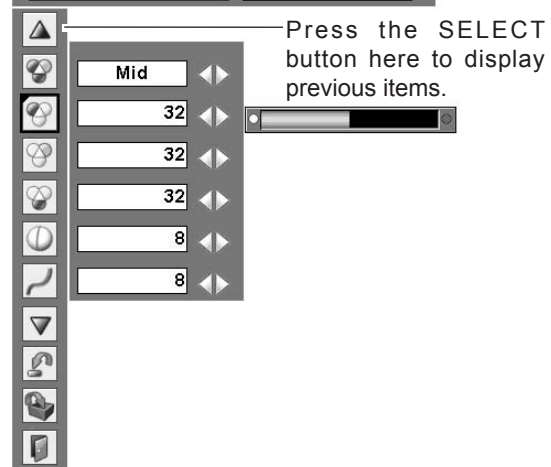
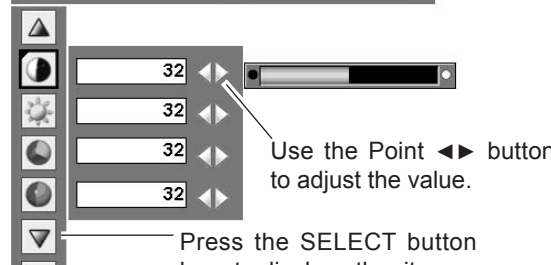
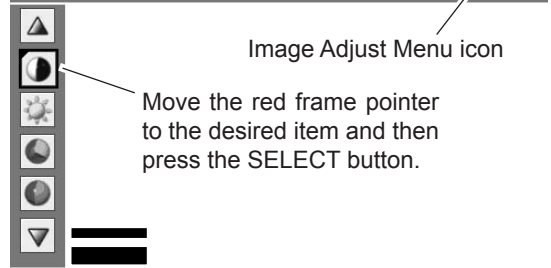

## Sharpness

Press the Point ◀ button to decrease the sharpness of the image; press the Point ▶ button to increase the sharpness of the image (from 0 to 15).

## Gamma

Use the Point ◀▶ buttons to adjust the gamma value to get better balance of contrast (from 0 to 15).

## Noise reduction

Noise interference on the screen can be reduced. Select one of the following options to get smoother images.

- Off.....Disabled.
- L1 .....Lower reduction
- L2 .....Higher reduction

## Progressive

An interlaced video signal can be displayed in a progressive picture. Select one of the following options.

- Off.....Disabled.
- L1..... For an active picture.
- L2..... For a still picture.
- Film..... For watching a film. With this function, the projector reproduces pictures faithful to the original film quality.

## Reset

To reset the adjusted data, select Reset and press the SELECT button. A confirmation box appears and then select "Yes." All adjustments return to their previous figures.

## Store

To store the adjusted data, select Store and press the SELECT button. Select a level from Image 1 to 4 with the Point ▲▼ buttons and press the SELECT button. A confirmation box appears and then select "Yes." Stored data can be called up by selecting "Image" in the Image Level Selection on page 37.

## Quit

Exit the Image Adjust Menu.

### ✓ Note:

Noise reduction and Progressive cannot be selected when 480p, 575p, 720p, 1035i, or 1080i is selected (p.36).

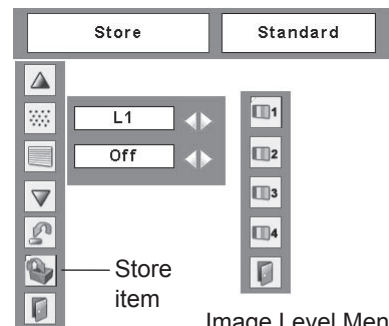
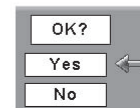

Image Level Menu

Move the red frame pointer to an image item to be set and then press the SELECT button.



A confirmation box appears and then select "Yes."



## Screen Size Adjustment

This projector has the picture screen resize function, which enables you to customize the image size.

- 1 Press the MENU button to display the On-Screen Menu. Use the Point ◀▶ buttons to move the red frame pointer to the Screen Menu icon.
- 2 Use the Point ▲▼ buttons and move the red frame pointer to the desired function and then press the SELECT button.



### Normal

Provide the image to fit the screen size while maintaining the aspect ratio of input signal.



### Full

Provide the full screen image.



### Zoom

Pan the horizontal direction of the image and cut the vertical direction of the image to fit the screen size (16:9). Only for 4:3 video aspect ratio signals.



### Wide

Provide the image at a wide screen ratio of 16:9.



### Natural wide

Modify the 4:3 aspect ratio image to fit the screen size (16:9 aspect ratio) by stretching the image to make it look natural.



### Custom

Adjust the screen scale and position manually. Press the SELECT button at Custom icon. "Custom" is displayed on the screen for a few seconds and then the Aspect dialog box appears.

- Scale H/V..... Adjust the Horizontal/Vertical screen scale.
- H&V ..... When selecting "On," the aspect ratio is fixed. "Scale V" appears dimmed and becomes unavailable. Adjust Scale H, then the screen scale is automatically modified based on the aspect ratio.
- Position H/V..... Adjust the Horizontal/Vertical screen position.
- Common ..... Save the adjusted scale to all the inputs. Press the SELECT button at Common to display the confirmation box. To save the scale, press the SELECT button at "Yes." When Custom is selected, the saved scale is used.
- Reset ..... Reset the all adjusted values. Press the SELECT button at Reset to display the confirmation box. To reset, press the SELECT button at "Yes."

### Screen Menu

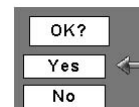
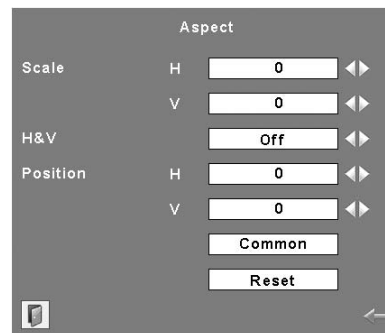
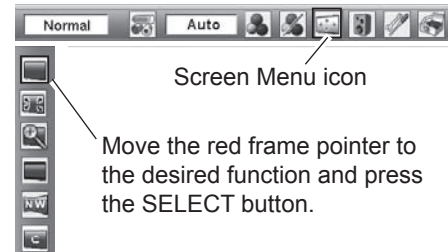

Press the SELECT button at Common or Reset, to display the confirmation box.

### ✓ Note:

- Zoom, Wide and Natural wide are not available when 720p, 1035i, or 1080i is selected in the AV System Menu (p.36).
- When no signal is detected, Normal is set automatically and Aspect dialog box disappears.
- The adjustable range of Scale H/V and Position H/V can be limited depending on the input signal.
- Zoom, Natural wide, Wide and Full are not available when the 4:3 or 16:9 function is selected in the Screen aspect (p.44).



# Setting

## Setting

This projector has Setting menu that allows you to set up the other various functions described as follows:

- 1 Press the MENU button to display the On-Screen Menu. Use the Point ◀▶ buttons to move the red frame pointer to the Setting Menu icon.
- 2 Use the Point ▲▼ buttons to move the red frame pointer to the item that you want to set and then press the SELECT button. The Setting dialog box appears.

### Language

The language used in the On-Screen Menu is available in English, German, French, Italian, Spanish, Portuguese, Dutch, Swedish, Finnish, Polish, Hungarian, Romanian, Russian, Chinese, Korean, or Japanese.

### Keystone

This function corrects distortion of a projected image. Select either Store or Reset with the Point ◀▶ buttons, and then press the SELECT button. The keystone dialog box appears. Correct keystone with the Point ▲▼ buttons (p.22).

Store.....Store the keystone correction even when the AC power cord is unplugged.

Reset.....Reset the keystone correction when the AC power cord is unplugged.

### Blue back

Press the Point ◀▶ buttons to switch on/off. When this function is "On," a blue image is displayed while the input signal is not detected.

### Display

Press the Point ◀▶ buttons to switch on/off. This function decides to display the On-Screen Displays.

On .....Display all the On-Screen Displays. Use this function when you want to project images after the lamp becomes bright enough. This mode is set as a default.

Countdown off... Display the input image instead of the countdown when turning on the projector. Use this function when you want to project the image as early as possible even when the lamp is not bright enough.

Off.....Do not show the On-Screen Displays. except:

- On-Screen Menu
- "Power off?"
- P-Timer
- "No signal" for Power management item (p.45)
- "Please wait..."
- Arrows for panning mode (pp.32–33)

## Setting Menu (Language)

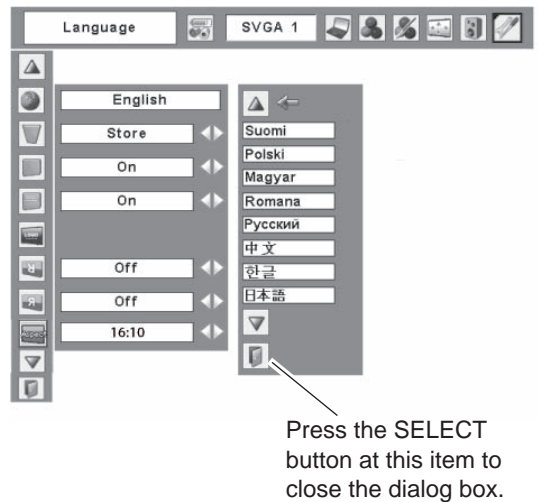
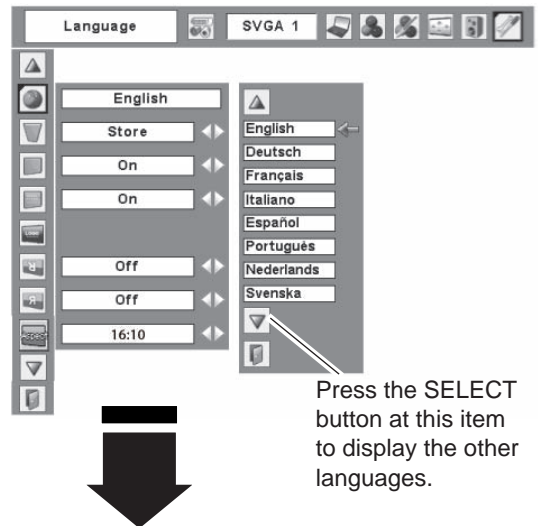
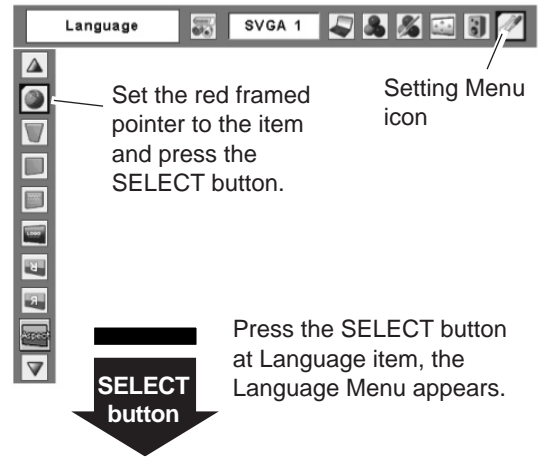



## Logo (Logo and Logo PIN code lock settings)

This function allows you to customize the screen logo with Logo select, Capture, and Logo PIN code lock functions.

✓ **Note:**

When "On" is selected in Logo PIN code lock function, Logo select and Capture functions cannot be selected.



## Logo select

This function decides the start-up display as follows:

- User.....The image you captured
- Default.....The factory-set logo
- Off.....Countdown only



## Capture

This function enables you to capture the image being projected and use it for a start-up display or interval of presentations.

After capturing the projected image, go to the Logo select function and set it to "User." Then the captured image is displayed when the projector is turned on next time or the NO SHOW button is pressed (p 24).

To capture the image, select "Yes." To cancel the Capture function, select "No."

✓ **Note:**

- Before capturing an image, select "Standard" in the Image Select Menu to capture a proper image (pp.30, 37).
- A signal from a computer can be captured up to WXGA(1280 x 800). A signal from video equipment can be captured except for 720p, 1035i, and 1080i.
- When you capture the image that has been adjusted by the Keystone or the Custom function, the adjusted data is automatically reset and the projector captures an image without keystone or custom adjustment.
- When the Logo PIN code lock function is "On," Capture menu cannot be selected.
- When you start to capture a new image, the previously stored image is cleared even if you cancel the capturing.
- "User" cannot be selected when the image is not captured.

## Logo select

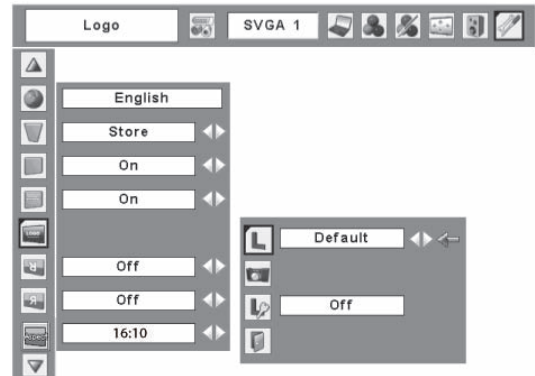

## Capture

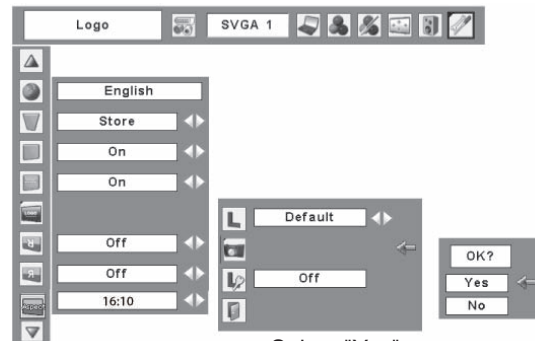

Select "Yes" to capture the projected image.

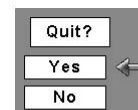

Select "Yes" to stop capturing.



### Logo PIN code lock

This function prevents an unauthorized person from changing the screen logo.

Off.....the screen logo can be changed freely from the Logo select menu (p.42).

On.....the screen logo cannot be changed without the Logo PIN code.

If you want to change the Logo PIN code lock setting, enter a Logo PIN code along the following steps. The initial Logo PIN code is set "4321" at the factory.

### Enter a Logo PIN code

Select a number by pressing the Point ▲▼ buttons. And then press the Point ► button to fix the number and move the pointer. The number changes to "\*". If you fixed an incorrect number, move the pointer to the number you want to correct by pressing the Point ◀ button, and then select the correct number by pressing the Point ▲▼ buttons.

Repeat this step to complete entering a four-digit number.

After entering the four-digit number, move the pointer to "Set" by pressing the Point ► button. Press the SELECT button so that you can change the following Logo PIN code lock settings.

If you entered an incorrect PIN code, "Logo PIN code" and the number (\*\*\*\*) turns red. Enter a correct Logo PIN code all over again.

### Change the Logo PIN code

Logo PIN code can be changed to your desired four-digit number. Select "Logo PIN code change" with the Point ▼ button and press the SELECT button. Set a new Logo PIN code.

Be sure to note the new Logo PIN code and keep it on hand. If you lost the number, you could no longer change the Logo PIN code setting. For details on PIN code setting, refer to relevant instructions of the PIN code lock function on pages 47–48.

#### CAUTION:

**WHEN YOU HAVE CHANGED THE LOGO PIN CODE, WRITE DOWN THE NEW PIN CODE IN COLUMN OF THE LOGO PIN CODE NO. MEMO ON PAGE 69, AND KEEP IT SECURELY. SHOULD THE LOGO PIN CODE BE LOST OR FORGOTTEN, THE LOGO PIN CODE SETTING CAN NO LONGER BE CHANGED.**

### Logo PIN code lock

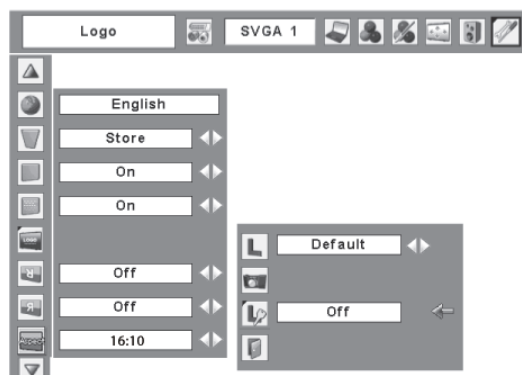

### Logo PIN code lock Dialog Box

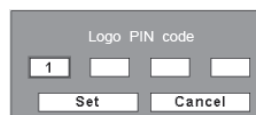

After a correct Logo PIN code is entered, the following dialog box appears.



Select On/Off by pressing the Point ◀► buttons or change the Logo PIN code.

## Ceiling

When this function is set to "On", the picture is top/bottom and left/right reversed. This function is used to project the image from a ceiling-mounted projector.

## Rear

When this function is set to "On", the picture is left/right reversed. This function is used to project the image to a rear projection screen.

## Screen aspect

This function is used to project the image to a 4:3 or 16:9 projection screen.

4:3 ..... Set to a 4:3 projection screen.

16:9 ..... Set to a 16:9 projection screen.

16:10 .... 16:10 is the aspect of the LCD panel. The original Screen Menu is available.

## Terminal

The COMPUTER IN 2/MONITOR OUT terminal on the back of the projector is switchable for computer input or monitor output (p.9). Select Computer 2 or Monitor Out with the Point ◀▶ buttons.

Computer 2.....computer input  
Monitor Out.....monitor out

Terminal function is not available when Computer 2 to the input source is selected. Change the input source to the others (Computer1 or Video) so that the Terminal function is available (pp.25, 34–35).

## Input search

This function detects the input signal automatically. When finding a signal, the search will stop. Use the Point ◀▶ buttons to select one of the following.

Off ..... Input search does not work.

On1 ..... Input search works under the situation below.

- When the COMPUTER button or VIDEO button on the remote control is pressed.

On2 ..... Input search works under the situation below.

- When the projector is turned on with pressing the POWER ON/STAND-BY button on the remote control. (After the countdown)
- When the COMPUTER button or VIDEO button on the remote control is pressed.
- When the current input signal is missed. \*

\* If the No show or Freeze function is active, cancel it to activate the Input search. It is not available when On-Screen menu is displayed.

## Ceiling

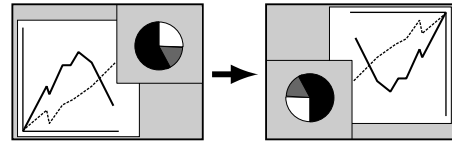

## Rear

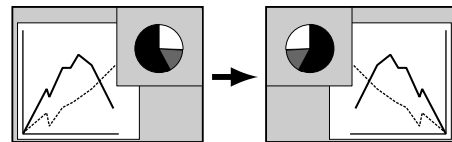

### ✓Note:

- When the 4:3 or 16:9 function is selected, True, Full and D.Zoom+/- are not available in the PC screen (pp.32-33).
- When the 4:3 or 16:9 function is selected, Zoom, Natural wide, Wide and Full are not available in the AV screen (p.40).

### ✓Note:

- While Input search is set On1 or On2, the status of Input and Lamp are displayed every time the signal is switched.
- Only the input source selected at the last time can be detected.
- If COMPUTER/VIDEO button on the remote control is pressed during Input search is in progress, Input search will stop.

## Standby mode

This function is available when operating the projector via network.

Normal..... Supply the power to the network function even after turning off the projector. You can turn on/off the projector via network, modify network environment, and receive an e-mail about projector status while the projector is powered off.

Eco..... Select "Eco" when you do not use the projector via network. The projector's network function will stop when turning off the projector.

Refer to the owner's manual "Network Set-up and Operation".

## Power management

For reducing power consumption as well as maintaining the lamp life, the Power management function turns off the projection lamp when the input signal is interrupted and no button is pressed for a certain period.

When the input signal is interrupted and no button is pressed for more than 30 seconds, the timer display with "No signal" appears. The countdown starts to turn off the lamp.

Select one of the operations.

Ready.....When the lamp has been fully cooled down, the POWER indicator changes to green blinking. In this condition, the projection lamp is turned on if the input signal is reconnected or any button on the remote control is pressed.

Shut down...When the lamp has been fully cooled down, the power is turned off.

Off..... Power management function is off.

Then set the countdown timer with the Point ◀▶ buttons.

### ✓Note:

Factory default is "Ready: 5 min."

## Power management



Time left before Lamp is off.

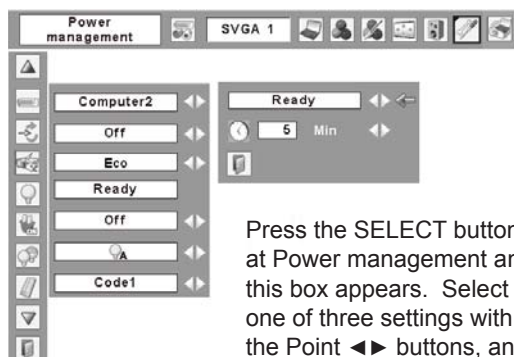

Press the SELECT button at Power management and this box appears. Select one of three settings with the Point ◀▶ buttons, and go to the timer with the Point ▲▼ buttons and set time with the Point ◀▶ buttons.



## On start

When this function is set to “On,” the projector is automatically turned on just by connecting the AC power cord to an outlet.

✓ **Note:**

*Be sure to turn the projector off properly (see “Turning Off the Projector” on page 19). If the projector is turned off in the incorrect sequence, the On start function does not operate properly.*



## Lamp control

You can change the brightness of the screen.

- High ..... Brighter than the Normal mode
- Auto ..... Brightness according with the input signal
- Normal ... Normal brightness

✓ **Note:**

*Lamp mode cannot be changed for a while after turning on the projector. Lamp needs some time to stabilize after the power is turned on. Stored lamp mode will be active after the lamp is stabilized.*



## Remote control

This projector provides two different remote control codes; the factory-set, initial code (Code 1) and the secondary code (Code 2). This switching function prevents remote control interference when several projectors or video equipment are operated at the same time.

When the projector is operated in “Code 2,” both the projector and the remote control must be switched to “Code 2.”

### To change the code for the projector:

Select either “Code 1” or “Code 2” in this Setting Menu.

### To change the code for the remote control:

Press and hold both the MENU and IMAGE buttons together for more than 5 seconds. After changing the code, make sure the remote control operates properly.

✓ **Note:**

- When different codes are set on the projector and on the remote control, any operation cannot be made. In that case, switch the code on the remote control to fit the code on the projector.
- If the batteries are removed from the remote control for a long period of time, the remote control code will be reset.

## On start

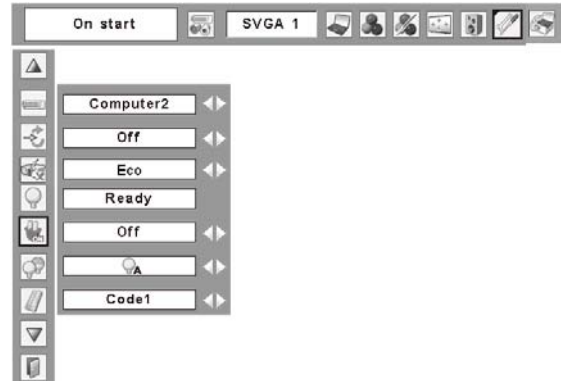

## Remote control

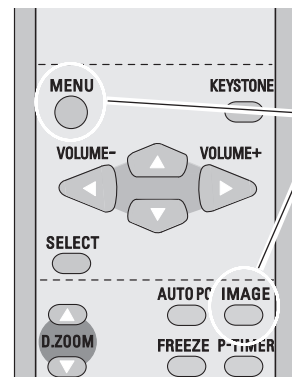

Press and hold MENU and IMAGE buttons for more than 5 seconds.



 **Security (Alarm and PIN code lock settings)**

This function allows you to use PIN code lock and Alarm function to set the security for the projector operation.

 **PIN code lock**

This function prevents the projector from being operated by unauthorized persons and provides the following setting options for security.

- Off..... The projector is not locked with the PIN code.
- On1.....Requires to enter a PIN code every time turning on the projector.
- On2.....Requires to enter a PIN code to operate the projector once the power cord is unplugged; as long as the AC power cord is connected, the projector can be operated without a PIN code.

Whenever you change the PIN code lock setting or the PIN code (a four-digit number), you are required to enter the PIN code. "1234" is set as the initial PIN code at the factory.

**Enter a PIN code**

Select a number by pressing the Point ▲▼ buttons. And then press the Point ► button to fix the number and move the pointer. The number changes to "\*". If you fixed an incorrect number, move the pointer to the number you want to correct by pressing the Point ◀ button, and then select the correct number by pressing the Point ▲▼ buttons.

Repeat this step to complete entering a four-digit number.

After entering the four-digit number, move the pointer to "Set" by pressing the Point ► button. Press the SELECT button so that you can change the following PIN code lock settings. If you entered an incorrect PIN code, "PIN code" and the number (\*\*\*\*) turns red. Enter a correct PIN code all over again.

**Change the PIN code lock setting**

Select Off, On1, or On2 with the Point ◀► buttons and then move the red arrow pointer to "Quit" with the Point ▼ button. Press the SELECT button to close the dialog box.

**PIN code lock**

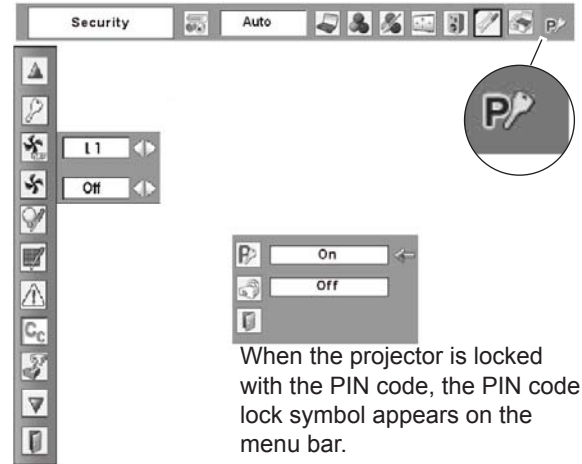

When the projector is locked with the PIN code, the PIN code lock symbol appears on the menu bar.

**Enter a PIN code**

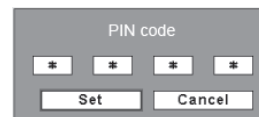
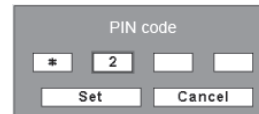
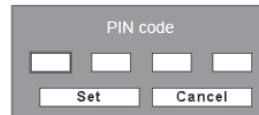

The input numbers change to "\*" for security reasons.

Move the pointer to "Set" by pressing the Point ► button. And then press the SELECT button.

**Change the PIN code lock setting**



Select a desired setting with the Point ◀► buttons.

## Change the PIN code

The PIN code can be changed to your desired four-digit number.

Select "PIN code change" with the Point ▼ button, and press the SELECT button to display the New PIN code input dialog box.

Select a number by pressing the Point ▲▼ buttons. And then press the Point ► button to fix the number and move the pointer. Repeat it to complete entering a four-digit number. After entering the four-digit number, move the pointer to "Set" by pressing the Point ► button. Then press the SELECT button.

### CAUTION:

**WHEN YOU HAVE CHANGED THE PIN CODE, WRITE DOWN THE NEW PIN CODE IN COLUMN OF THE PIN CODE NO. MEMO ON PAGE 69, AND KEEP IT SECURELY. IF YOU FORGET YOUR PIN CODE, THE PROJECTOR CAN NO LONGER BE STARTED.**



## Alarm

Make some settings for the Antitheft alarm function. (pp. 51-53)

Press the SELECT button at Alarm icon to display the Alarm setting box.

When the Antitheft alarm function is set, "On" is displayed. When the function is released, "Off" is displayed. See p.51 to set or release this function.

Select Alarm volume, Sensitivity or Ringing time with the Point ▲▼ buttons, and set each item with the Point ◀▶ buttons.

### Alarm volume

- Small
- Medium
- Large

### Sensitivity

- Low..... Less sensitive.
- Medium ..... Normal sensitive.
- High ..... Highly sensitive (default setting).

### Ringling time

- 10 seconds ..... Default setting.  
Ring about 10 seconds.
- 60 seconds ..... Ring about 60 seconds.
- Long time..... Ring until the end of the battery life.

## Change the PIN code



Select PIN code change and press the SELECT button. The New PIN code input dialog box appears.

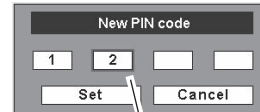

The input numbers are being displayed for confirmation.

## Alarm

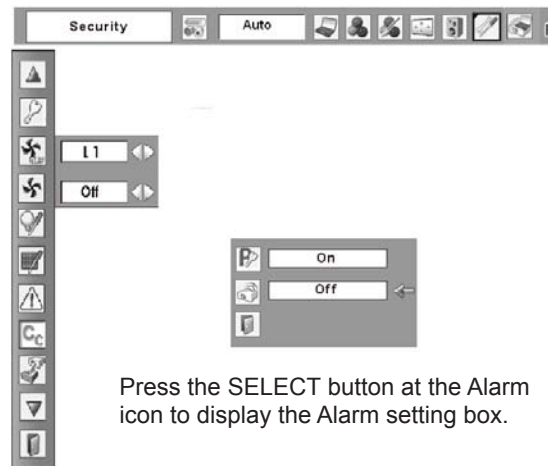

Press the SELECT button at the Alarm icon to display the Alarm setting box.

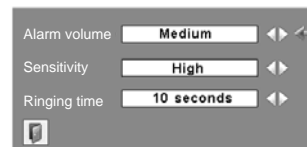

Set Sensitivity or Ringing time with the Point ◀▶ buttons.

### ✓ Note:

- The Alarm icon becomes gray and cannot be selected when the Antitheft alarm function is "On", a battery is not installed, or the battery is coming to the end of its life.
- While the Alarm icon is selected, the Antitheft alarm setting buttons on the side panel cannot be operated.
- When selecting "Long time" in Ringing time, the length of alarm ringing time differs depending on the battery life.



 **Fan**

This function provides the following options in the cooling fans' operation after turning off the projector (p.19).

- L1 ..... Normal operation
- L2 ..... Slower and lower-sound than the normal operation (L1), but it takes longer to cool down the projector.

 **Fan control**

Choose the running speed of cooling fans from the following options according to the ground elevation under which you use the projector.

- Off..... Normal speed. Set this function to "Off" when using the projector in non-high altitude environment.
- On 1..... Faster than Off mode. Select this mode when using the projector in high altitudes (about 1,200 meters or more above the sea level) where the fans have less cooling effect.
- On 2..... Faster than On 1 mode. Select this mode when using the projector in higher altitudes than above where the fans have lesser cooling effect.

 **Lamp counter**

This function is used to reset the lamp replacement counter. When replacing the projection lamp, reset the lamp replacement counter by using this function. See page 58 for operation.

 **Filter counter**

This function is used to set a frequency for the filter cleaning.

When the projector reached a specified time between cleanings, a Filter warning icon appears on the screen, notifying the cleaning is necessary. After cleaning the filter, be sure to select RESET and set the timer. The Filter warning icon will not turn off until the filter counter is reset.

For details about resetting the timer, refer to "Resetting the Filter Counter" on page 55.

**Filter counter**

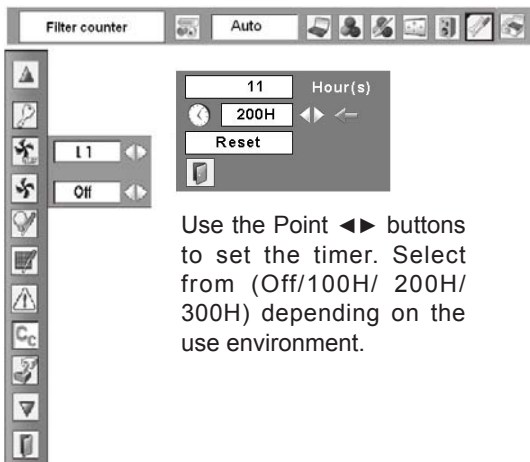

Use the Point ◀▶ buttons to set the timer. Select from (Off/100H/ 200H/ 300H) depending on the use environment.

✓**Note:**

Setting "Fan control" to On1 or On2 affects L2 operation in "Fan."

✓**Note:**

- Fan noise becomes louder in On 1 and On2.
- Failure to set the running speed of cooling fans properly may affect the projector life.

Lamp replacement icon



This icon appears on the screen when the end of lamp life is reached.

✓**Note:**

This icon also appears at turning on and selecting input source.

**Fig.1** Filter warning icon



Filter warning icon appears on the screen at a set time.

✓**Note:**

This icon also appears at turning on.

**Fig.2** Filter warning icon



✓**Note:**

- At selecting input source, the icon (Fig.2) will appear.
- The Filter warning icons (Fig.1 and Fig.2) will not appear when the Display function is set to "Off" (p.41), during "Freeze"(p.23), or "No show" (p.24).



## Warning log

This function records anomalous operations while the projector is in operation and use it when diagnosing faults. Up to 10 warning logs are displayed with the latest warning message at the top of the list, followed by previous warning messages in chronological order.

✓ **Note:**

When the Factory default function is executed, all the warning log records will be deleted.



## Closed Caption

Closed Caption is a function that displays the audio portion of a TV program as text on the screen. If the input signal contains closed captions, you can turn on the feature and switch the channels. Press the Point ◀▶ buttons to select CC1, CC2, CC3 or CC4. If the closed caption is not clear, you can change the text from Color to White.

✓ **Note:**

The Closed Caption is available only under the situation below.

- When the input signal is NTSC of composite and S-video, and the system is set according to the signal or set on "Auto".
- The system must be set on NTSC or Auto in Video System Selection. (p.36)
- The icon of Closed Caption is displayed in gray while it is not available.
- The closed caption is unavailable when On-Screen menu and P-Timer are displayed.



## Factory default

This function returns all setting values except for the user logo, PIN code lock, Logo PIN code lock, the lamp counter and the filter counter to the factory default settings.



## Quit

Exit the Setting Menu.

## Closed Caption

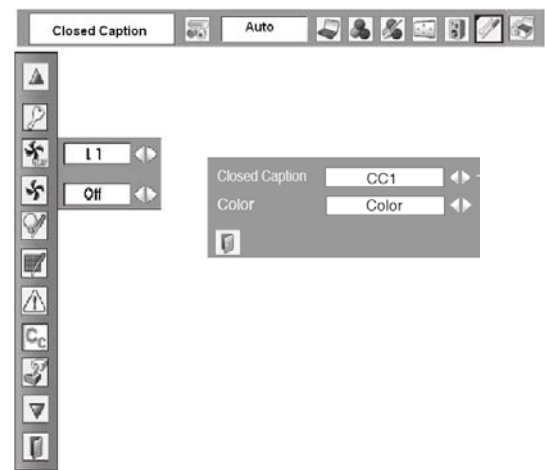

## Factory default

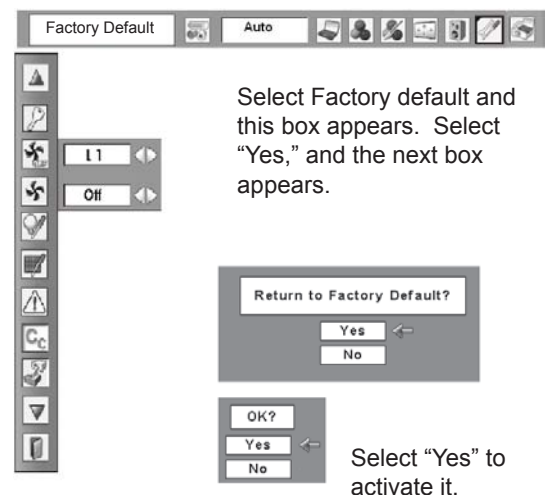

# Antitheft Alarm Function

## How to Use the Antitheft Alarm Function

The Antitheft alarm function is to prevent the projector from being stolen. With this function on, the alarm rings when an unauthorized person tries to move the projector.

✓ **Note:**

- This function is not a guarantee against stealing.
- The alarm does not ring while the AC power cord is connected even if the projector detects vibrations.
- Pressing the button is always accompanied by a sound. If any sound is not produced after pressing the button, you need to press it again.

### Install a battery

Before operating the Antitheft alarm function, install a battery in the projector. (see p. 53 for installation)

### Set and release the Antitheft alarm function

#### Set the alarm

Press the F button twice to turn the alarm function on. The ALARM indicator blinks for a few seconds and the projector enters the warning mode.

While the Antitheft alarm function is on, the projector emits a low-pitched sound when detecting a vibration. When the projector does not detect a vibration for a few seconds after the sound, it goes back to the warning mode. When the projector detects more vibrations after the low-pitched sound, the alarm starts ringing.

✓ **Note:**

- You can test the alarming sound without setting the alarm. Press and hold the F button then the alarm starts ringing. The length of the ringing time is what you set on the "Ringing time". (p. 48)
- If you want to stop the alarm while it is ringing, insert the AC power cord or press the F button and enter the four-digit PIN code.

#### Release the alarm setting

**1** Press the F button and enter the four-digit PIN code within about 10 seconds. (The default PIN code is "1111".) When the alarm is released, you hear high-pitched confirmation sound.

When entering an incorrect PIN code, you hear low-pitched sound. If you enter an incorrect PIN code 3 times, the alarm starts ringing.

#### Side Control

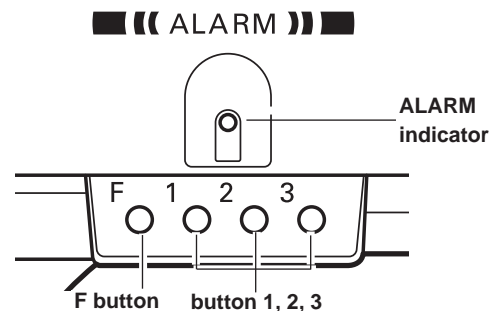

## Settings

### Change the PIN code

- 1** Press the F button and enter the four-digit PIN code within about 10 seconds. The ALARM indicator blinks red for a few seconds and high-pitched confirmation sound is made.
- 2** While the indicator is blinking, enter new PIN code then you will hear the high-pitched confirmation sound and the ALARM indicator is off.

When typing an incorrect PIN code, you will hear low-pitched sound. If you enter incorrect PIN codes 3 times, the alarm starts ringing.

A PIN code for Antitheft alarm function is the combination of 1, 2, or 3. Enter the PIN code with the button 1, 2, and 3. The default PIN code is set as "1111".

### Reset the settings

Select Factory default in the Setting menu to reset the settings for the Antitheft alarm function.

✓ **Note:**

- *This is effective only when the Antitheft alarm setting is released.*
- *You can make some more detailed settings. (p. 48)*

**CAUTION:**  
**WHEN YOU HAVE CHANGED THE PIN CODE, WRITE DOWN THE NEW PIN CODE AND KEEP IT SECURELY. IF YOU FORGET YOUR PIN CODE, SOME SETTINGS OF THE ALARM FUNCTION CAN NO LONGER BE CHANGED.**

### Side Control

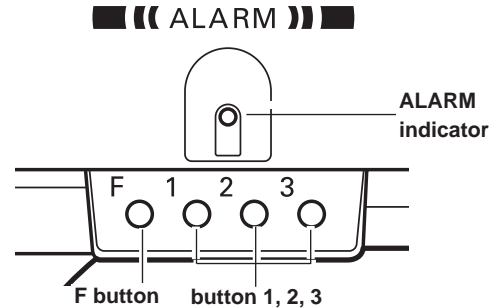

## How to install the battery

To use the Antitheft alarm function, you need to install a battery. (Use CR2 3V lithium battery.)

Unplug the AC power cord from the wall outlet before installing the battery. Remove the screw and open the battery cover on the bottom of the projector.

When the battery is installed properly, the ALARM indicator blinks for about 10 seconds.

After placing the battery, put the cover back and secure it with the screw.

When the life of the battery draws to an end, the ALARM indicator flashes and warning sound is made at some intervals.

Replace the battery by following the procedures above.

### ✓ Note:

- Even after changing the battery, the PIN code you have changed and settings you have made are effective.
- When changing the battery, set the Antitheft alarm function off. Otherwise the alarm starts ringing when you try to open the battery cover.
- Remove the battery if you carry your projector frequently and use the carrying case. If you do not remove the battery, the alarm may be triggered when the Alarm buttons are accidentally pressed inside the carrying case.

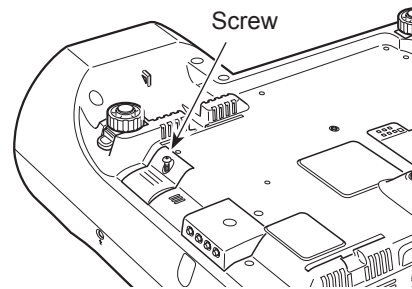

Loosen the screw and open the battery cover.

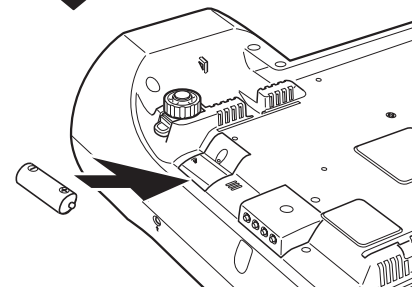

Install the battery then replace the battery cover and secure it with the screw.



To insure safe operation, please observe the following precautions:

- Do not keep the battery mixing with wire or metal products to avoid causing a short.
- Keep the battery away from babies and children to prevent them from swallowing it.
- Do not charge the battery.
- Do not disassemble, or apply pressure to transform the battery.
- Avoid contact with water or liquid.
- Do not expose to moisture or heat.
- If the battery has leaked, carefully wipe the battery compartment clean and install new battery.
- Do not replace the battery with an incorrect type or in an incorrect direction.
- Dispose of used battery after insulating the battery with putting insulating tape on either or both sides on the top/bottom of the battery.
- Dispose of used battery according to the local regulations.
- Danger of explosion if battery is incorrectly replaced. Replace only with the same or equivalent type recommended by the manufacturer.

# Maintenance and Cleaning

## Warning Indicator

The WARNING indicator shows the state of the function which protects the projector. Check the state of the WARNING indicator and the POWER indicator to take proper maintenance.

### The projector is shut down and the WARNING indicator is blinking red.

When the temperature inside the projector reaches a certain level, the projector is automatically shut down to avoid overheating. The POWER indicator is blinking while the projector is being cooled down. When the projector has cooled down enough (to its normal operating temperature), it can be turned on again by pressing the POWER ON/STAND-BY button.

✓ **Note:**

*The WARNING indicator continues to blink even after the temperature inside the projector returns to normal. When the projector is turned on again, the WARNING indicator stops blinking.*

**Then check the matters below:**

- Did you provide appropriate space for the projector to be ventilated? Check the installing condition to see if ventilation slots are not blocked.
- Has the projector been installed near an Air-Conditioning/ Heating Duct or Vent? Move the installation of the projector away from the duct or vent.
- Are the air filters clean? Clean the air filters periodically. (p.55)

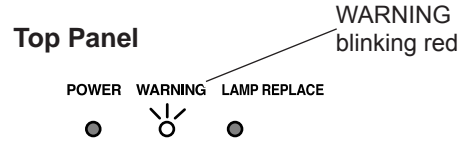

### The projector is shut down and the WARNING indicator lights red.

When the projector detects an abnormal condition, it is automatically shut down to protect the inside of the projector and the WARNING indicator lights red. In this case, unplug the AC power cord and plug it, and then turn on the projector once again to verify operation. If the projector cannot be turned on and the WARNING indicator lights red, unplug the AC power cord and contact the service station.

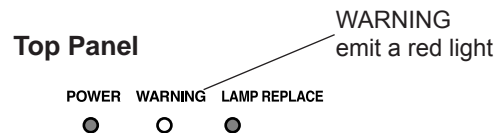

**CAUTION**

DO NOT LEAVE THE PROJECTOR WITH THE AC POWER CORD CONNECTED UNDER AN ABNORMAL CONDITION. IT MAY RESULT IN FIRE OR ELECTRIC SHOCK.

## Cleaning the Air Filters

Air filters prevent dust from accumulating on the surface of the optical elements inside the projector. Should the air filters become clogged with dust particles, they will reduce cooling fans' effectiveness and may result in a buildup of internal heat and adversely affect the life of the projector. Clean the air filters by following the steps below.

- 1** Turn off the projector, and unplug the AC power cord from the AC outlet.
- 2** Turn over the projector and remove the air filters by pulling the latches upward.
- 3** Clean the air filters with a brush or rinse them softly. When rinsing the air filters, dry them well.
- 4** Replace the air filters properly. Make sure that the air filters are fully inserted.



### CAUTION

Do not operate the projector with the air filters removed. Dust may accumulate on the optical elements degrading picture quality. Do not put anything into the air intake vents. Otherwise it may result in malfunction of the projector.

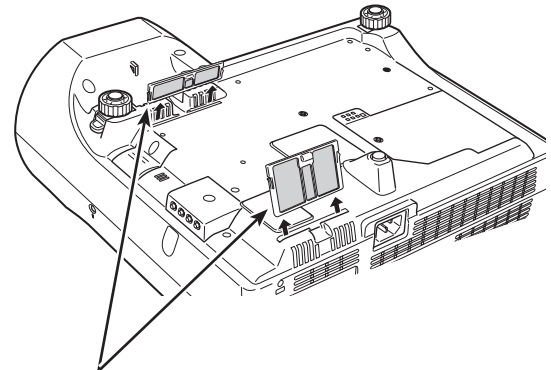

Air filters  
Pull up and remove.

### ✓Note:

When reinserting the air filters, be sure that the slit part is facing the outer side.

## RECOMMENDATION

**We recommend avoiding dusty/smoky environments when you operate the projector. Usage in these environments may cause poor image quality.**

When you use the projector under dusty or smoky conditions, dust may accumulate on the lens, LCD panels, or optical elements inside the projector degrading the quality of a projected image.

When the symptoms above are noticed, contact your authorized dealer or service station for proper cleaning.

## Resetting the Filter Counter

Be sure to reset the Filter counter after cleaning or replacing the filters.

- 1** Press the MENU button to display the On-Screen Menu. Use the Point ◀▶ buttons to move the red frame pointer to the Setting Menu icon.
- 2** Use the Point ▲▼ buttons to move the red frame pointer to Filter counter and then press the SELECT button. A dialog box appears showing the total accumulated time of the filter use, a timer setting option, and the reset option. Select Reset and the "Filter counter Reset?" appears. Select [Yes] to continue.
- 3** Another confirmation dialog box appears, select [Yes] to reset the Filter counter.

### Filter counter

Select Reset and the "Filter counter Reset?" appears.

Select [Yes], then another confirmation box appears.

Select [Yes] again to reset the Filter counter.



### Attaching the Lens Cover

When moving the projector or while it is not in use, replace the lens cover.

- 1 Thread the string through the hole on the lens cover and then tie a knot in the string to secure it in place.
- 2 Thread the other end of the string through the hole on the bottom of the projector. Then pass the lens cover through the resulting loop of the string and pull it to tighten the knot.

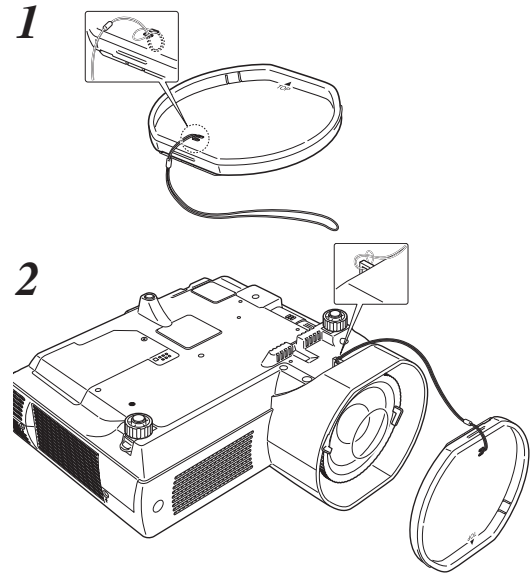

### Cleaning the Projection Lens



This projector is equipped with a plastic lens. Do not rub the lens with a hard fiber cloth or hit it with something hard to prevent the lens from scratching. Do not use a chemical cleaner (liquid and solid) to avoid deteriorating the lens.

Unplug the AC power cord before cleaning.

First, remove the dust with a blower. Then gently wipe the lens surface. Use a lens cleaning paper moistened with methyl alcohol (methanol). Avoid excessive use of cleaner. Do not use abrasive cleaners, solvents, or other harsh chemical cleaners to avoid damages the lens.

When the projector is not in use, replace the lens cover.

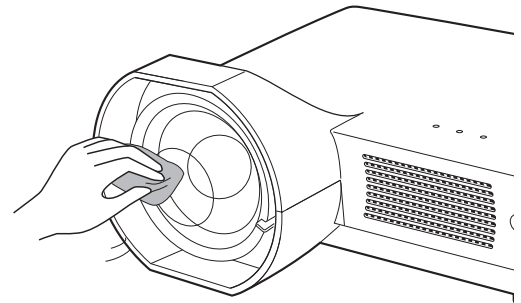

### Cleaning the Projector Cabinet

Unplug the AC power cord before cleaning.

Gently wipe the projector body with a soft dry cleaning cloth. When it is heavily soiled, use a small amount of mild detergent and finish with the cleaning cloth. Avoid excessive use of cleaner. Abrasive cleaners, solvents, or other harsh chemicals might scratch the surface of the cabinet.

When the projector is not in use, put the projector in an appropriate case to avoid dust and being scratched.

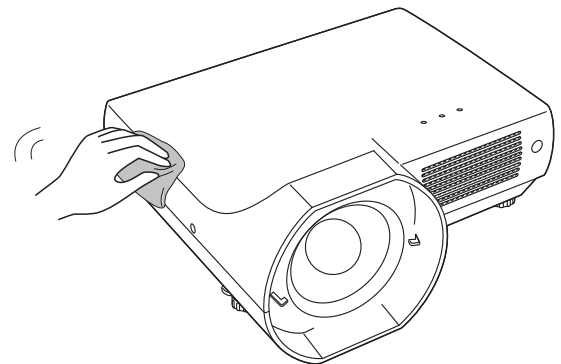



## Lamp Replacement

When the projection lamp of the projector reaches the end of its life, the LAMP REPLACE indicator emits a yellow light. If this indicator lights yellow, replace the lamp with a new one promptly.



### Top Panel

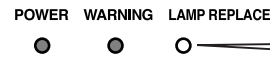

This indicator turns yellow when the projection lamp reaches the end of its life.

### Lamp replacement icon



#### ✓ Note:

The Lamp replacement icon will not appear when the Display function is set to "Off" (p.41), during "Freeze" (p.23), or "No show" (p.24).



## CAUTION

Allow the projector to cool for at least 45 minutes before you open the Lamp cover. The inside of the projector can become very hot.



## CAUTION

For continued safety, replace with a lamp of the same type. Do not drop a lamp or touch a glass bulb! The glass can shatter and may cause injury.

Follow these steps to replace the lamp.

- 1** Turn off the projector and unplug the AC power cord. Let the projector cool for at least 45 minutes.
- 2** Turn the projector over. Remove the screw that secures the lamp cover, and then open the lamp cover.
- 3** Remove the two screws that secure the lamp. Lift the lamp out of the projector by using the built in handle.
- 4** Replace the lamp with a new one and secure it with the two screws. Make sure that the lamp is set properly. Put the lamp cover back and secure it with the screw.
- 5** Connect the AC power cord to the projector and turn on the projector.
- 6** **Reset the lamp replacement counter.**  
See "Lamp Replacement Counter" on the next page.

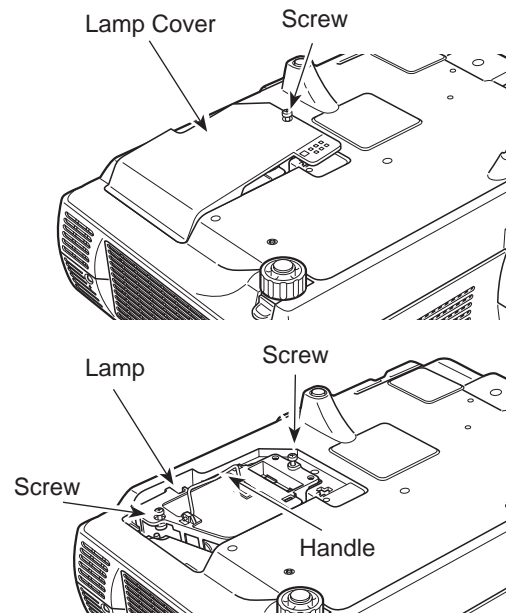

### ORDER REPLACEMENT LAMP

Replacement lamp can be ordered through your dealer. When ordering a projection lamp, give the following information to the dealer.

- **Model No. of your projector** : PRM-20 , PRM-20(S)
- **Replacement Lamp Type No.** : POA-LMP126  
(Service Parts No. 610 340 8569)

## Lamp Replacement Counter

Be sure to reset the Lamp replacement counter after the lamp is replaced. When the Lamp replacement counter is reset, the LAMP REPLACE indicator stops lighting.

- 1 Turn the projector on and press the MENU button to display the On-Screen Menu. Use the Point ◀▶ buttons to move the red frame pointer to the Setting Menu icon.
- 2 Use the Point ▲▼ buttons to move the red frame pointer to Lamp counter and then press the SELECT button. The first dialog box appears showing the total accumulated lamp time and reset option. If you select Reset, "Lamp replacement counter Reset?" appears. Select "Yes" to continue.
- 3 Another confirmation dialog box appears, and select "Yes" to reset the Lamp replacement counter.

✓ **Note:**

*Do not reset the Lamp replacement counter without implementing lamp replacement. Be sure to reset the Lamp replacement counter only after replacing the lamp.*

### Lamp counter

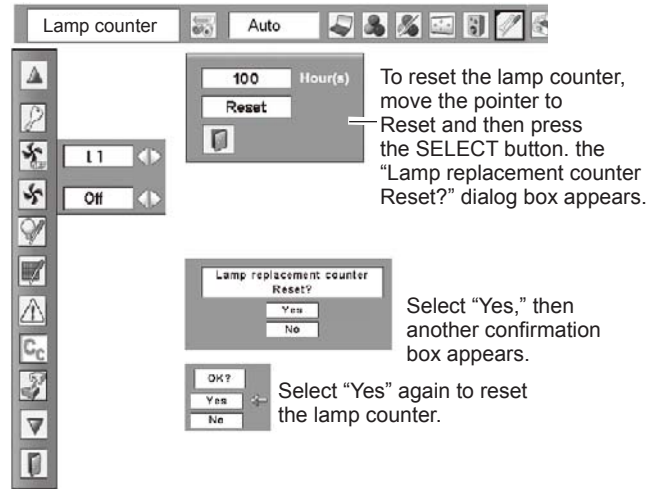

## LAMP HANDLING PRECAUTIONS

This projector uses a high-pressure lamp which must be handled carefully and properly. Improper handling may result in accidents, injury, or create a fire hazard.

- Lamp life may differ from lamp to lamp and according to the environment of use. There is no guarantee of the same life for each lamp. Some lamps may fail or terminate their life in a shorter period of time than other similar lamps.
- If the projector indicates that the lamp should be replaced, i.e., if the LAMP REPLACE indicator lights up, replace the lamp with a new one IMMEDIATELY after the projector has cooled down.  
(Follow carefully the instructions in the Lamp Replacement section of this manual.) Continuous use of the lamp with the LAMP REPLACE indicator lighted may increase the risk of lamp explosion.
- A Lamp may explode as a result of vibration, shock, or degradation as a result of hours of use, as it comes to the end of life. Risk of explosion may differ according to the environment or conditions in which the projector and lamp are being used.

### IF A LAMP EXPLODES, THE FOLLOWING SAFETY PRECAUTIONS SHOULD BE TAKEN.

If a lamp explodes, disconnect the projector's AC plug from the AC outlet immediately. Contact an authorized service station for a checkup of the unit and replacement of the lamp. Additionally, check carefully to ensure that there are no broken shards or pieces of glass around the projector or coming out from the cooling air circulation holes. Any broken shards found should be cleaned up carefully. No one should check the inside of the projector except those who are authorized trained technicians and who are familiar with projector service. Inappropriate attempts to service the unit by anyone, especially those who are not appropriately trained to do so, may result in an accident or injury caused by pieces of broken glass.

# Appendix

## Troubleshooting

Before calling your dealer or service center for assistance, check the items below once again.

- Make sure you have properly connected the projector to peripheral equipment as described on pages 14-16.
- Make sure all equipment is connected to the AC outlet and the power is turned on.
- When you operate the projector with a computer and it does not project an image, restart the computer.

---

**Problem:****– Solutions**

---

**No power**

- Plug the power cord of the projector into the AC outlet.
  - See if the POWER indicator lights red.
  - Wait until the POWER indicator stops blinking to turn on the projector again. The projector can be turned on after the POWER indicator turns red (see page 19).
  - Check the WARNING indicator. If the WARNING indicator lights red, the projector cannot be turned on (see on page 54).
  - Check the projection lamp (see page 57).
- 

**PIN code dialog box appears at start-up**

- PIN code lock is being set. Enter a PIN code; the "1234" or numbers you have set (see pages 18, 47–48).
- 

**The initial display is not shown.**

- Make sure "Off" or "Countdown Off" are not chosen at Display function (see page 41).
- 

**The initial display is not same with the default one.**

- Make sure "User" or "Off" are not chosen at Logo function (see page 42).
- 

**Input signal switches automatically. (or does not switch automatically)**

- Make sure Input search function is adjusted properly (see page 44).
- 

**No image**

- Check the connection between your computer or video equipment and the projector (see pages 14-16)
  - See if the input signal is correctly output from your computer. Some laptop computers may need to be changed the setting for monitor output when connected to the projector. See your computer's instruction manual for the setting
  - It takes about 30 seconds to display an image after turning on the projector.
  - See if the selected system is corresponding with your computer or video equipment (see pages 26, 36)
  - Select correct input source once again through menu operation (see pages 25, 34–35).
  - Make sure the temperature is not out of the specified operating temperature (41 °F–95 °F [5 °C–35 °C]).
  - When "No Show" is operating, the image can not be displayed. Press the NO SHOW button or any other button on the remote control.
- 

**Image is out of focus.**

- Adjust focus of the projector (see page 22).
  - Provide proper distance between the projector and the projection screen (see page 13).
  - Check the projection lens to see if it needs cleaning (see page 56).
  - Moving the projector from a cool to warm place may result in moisture condensation on the projection lens. If this occurs, leave the projector off and wait until condensation evaporates.
  - Projecting from the excessive slant angle to the screen may cause keystone distortion and partial imperfect focus.
-

---

<b>Picture is not bright enough.</b>	<ul style="list-style-type: none"><li>– Check if "Contrast" or "Brightness" are adjusted properly (see pages 31, 38).</li><li>– Check if "Image level" is selected properly (see pages 30, 37).</li><li>– Check the LAMP REPLACE indicator. If it lights, the end of lamp life is approaching. Replace the lamp with a new one promptly (see pages 57-58, 64).</li><li>– Check the Lamp control function (see pages 24, 46).</li></ul>
<b>The color is strange.</b>	<ul style="list-style-type: none"><li>– Check the Input signal, color system, video system, or computer system mode.</li><li>– Adjust the Image level properly (see pages 31, 38).</li></ul>
<b>Image is Left/Right reversed. Image is Top/Bottom reversed.</b>	<ul style="list-style-type: none"><li>– Check the Ceiling/Rear function (see page 44).</li><li>– Check the Ceiling function (see page 44).</li></ul>
<b>The image is distorted or runs off.</b>	<ul style="list-style-type: none"><li>– Check the PC Adjustment menu or Screen menu and adjust them (see pages 26-29, 32-33, 40).</li></ul>
<b>No sound</b>	<ul style="list-style-type: none"><li>– Check the audio cable connection from audio input source.</li><li>– Adjust the audio source.</li><li>– Press the Volume + button (see page 23).</li><li>– Press the Mute button (see page 23).</li><li>– When the AUDIO OUT is plugged in, the projector's built-in speaker is not available.</li><li>– Is the image projected? You will hear the sound only when the image is projected.</li></ul>
<b>Some displays are not seen during the operation.</b>	<ul style="list-style-type: none"><li>– Check the Display function (see page 41).</li></ul>
<b>Auto PC adjustment function does not work.</b>	<ul style="list-style-type: none"><li>– Check the Input signal. Auto PC Adjustment function can not work when 480p, 575p, 720p, 480i, 575i, 1035i, or 1080i is selected (see page 27).</li></ul>
<b>The setting does not remain after turning off power.</b>	<ul style="list-style-type: none"><li>– Make sure you selected "Store" after adjusting settings. Some settings cannot be stored if not registered with "Store."</li></ul>
<b>Power management function does not work.</b>	<ul style="list-style-type: none"><li>– Power management function cannot work while "Freeze" or "No Show" function is running.</li></ul>
<b>Image disappears automatically</b>	<ul style="list-style-type: none"><li>– Check the power management function in the Setting. The power management is set to "On" at the factory.</li></ul>
<b>Capture function does not work.</b>	<ul style="list-style-type: none"><li>– Check the connection and the Input signal to see if there is signal.</li></ul>
<b>The Remote Control does not work.</b>	<ul style="list-style-type: none"><li>– Check the batteries.</li><li>– Make sure no obstruction is between the projector and the remote control.</li><li>– Make sure you are not too far from the projector when using the remote control. Maximum operating range is 16.4' (5 m).</li><li>– Make sure the code of the remote control is conformed to that of the projector (see page 46).</li></ul>

---

<b>Indicator blinks or lights.</b>	– Check the status of the projector with referring to "indicators and Projector Condition" (see page 64).
<b>Alarm does not stop ringing.</b>	– Connect the AC power cord to the AC outlet. (Alarm will not stop ringing when the alarm goes off while trying to remove the battery cover.) (see pages 51-53).
<b>Alarm rings even when the warning mode is turned off.</b>	– The battery may be coming to the end of its life. Replace the battery with a new one promptly.
<b>Warning mode is not turned on.</b>	– If you cannot hear the bleeping sound when you press the Alarm buttons, you are not pressing the buttons correctly. Try to set the Alarm setting again (see page 51).
<b>Computer 2 cannot be selected.</b>	– Select Computer 2 in the Terminal function (see page 44).
<b>The terminal function cannot be selected.</b>	– The Terminal function cannot be selected after Computer 2 is selected. Select other input source such as Computer 1 or Video with the COMPUTER button or the VIDEO button on the remote control so that the Terminal function can be selected.
<b>The exclamation mark appears on the screen.</b>	– Your operation is invalid. Operate correctly.
<b>Unable to unlock the Logo PIN code lock or Security PIN code lock.</b>	– Contact the dealer where you purchased the projector or the service center.

**WARNING :**

**High voltages are used to operate this projector. Do not attempt to open the cabinet.**

If problems still persist after following all operating instructions, contact the dealer where you purchased the projector or the service center. Specify the model number and explain about the problem. We will advise you how to obtain service.

 The CE Mark is a Directive conformity mark of the European Community (EC).



This symbol on the nameplate means the product is Listed by Underwriters Laboratories Inc. It is designed and manufactured to meet rigid U.L. safety standards against risk of fire, casualty and electrical hazards.

# Menu Tree

## Computer Input/Video Input

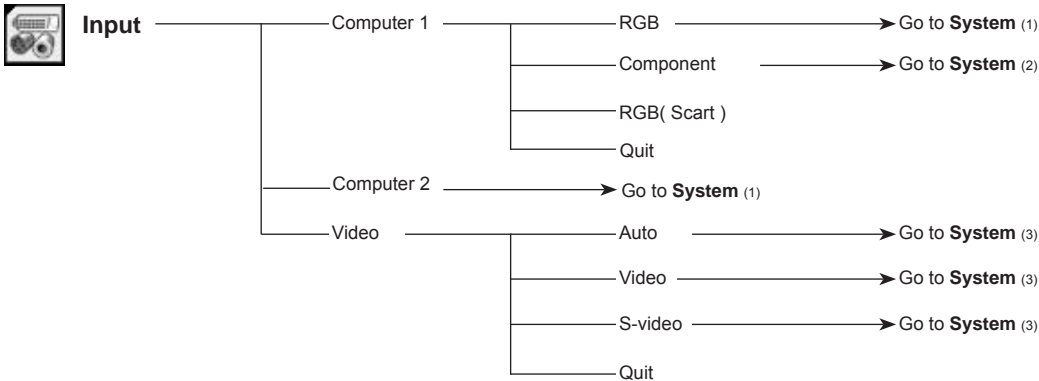

## Sound

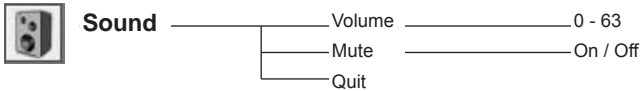

## Computer Input

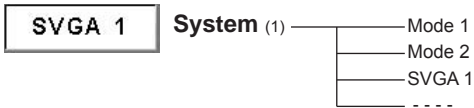

\*Systems displayed in the System Menu vary depending on an input signal.

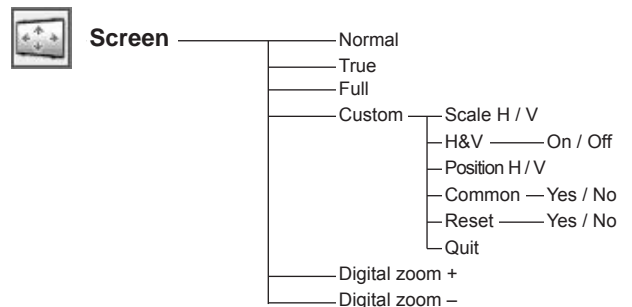
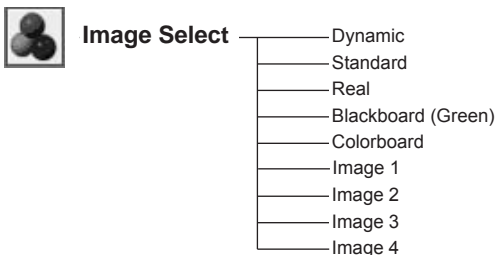
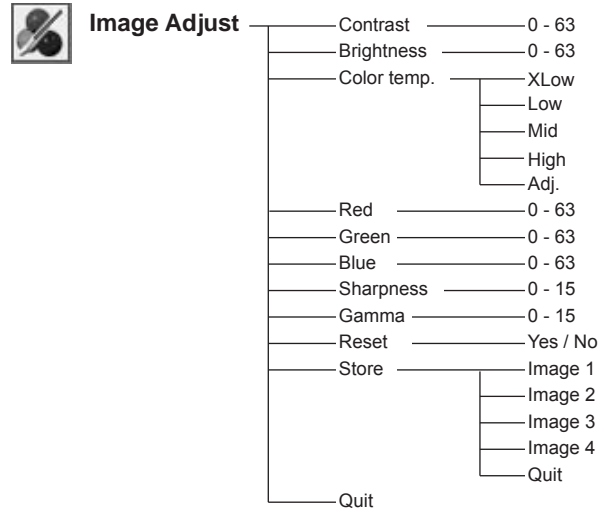
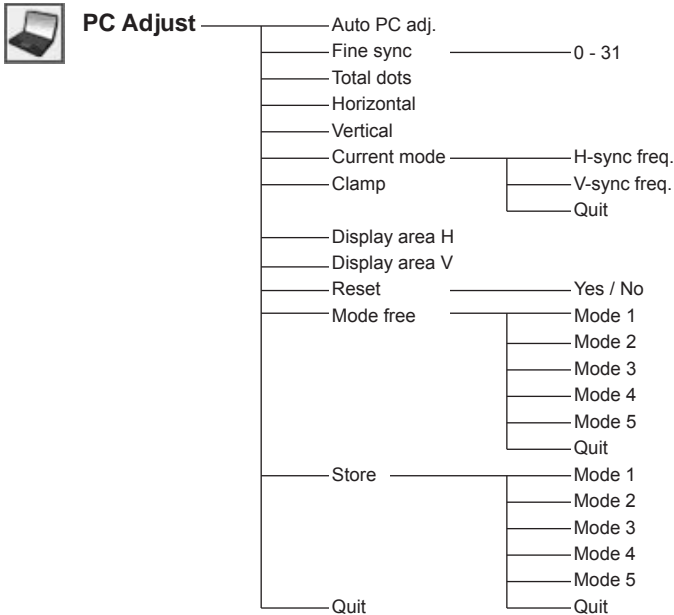

## Video Input

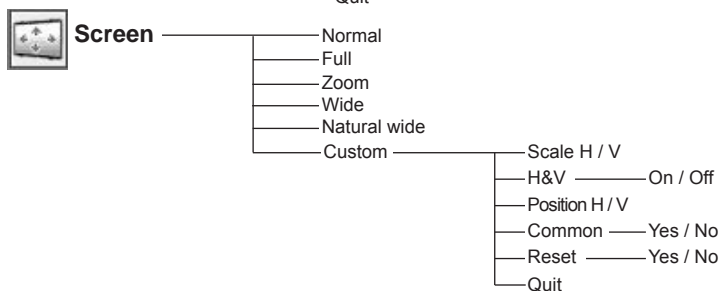
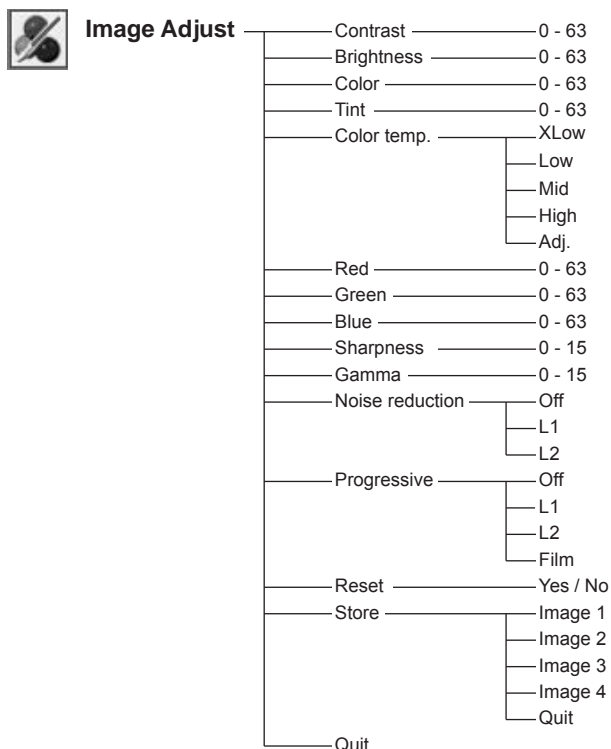
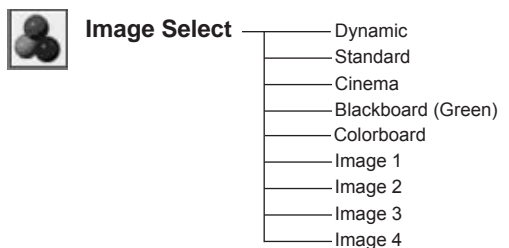
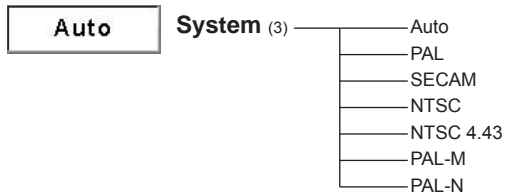
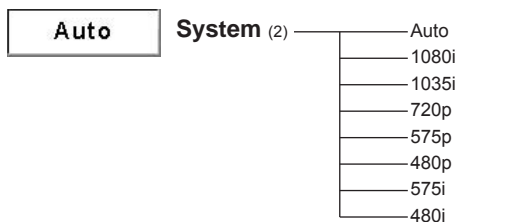

## Setting

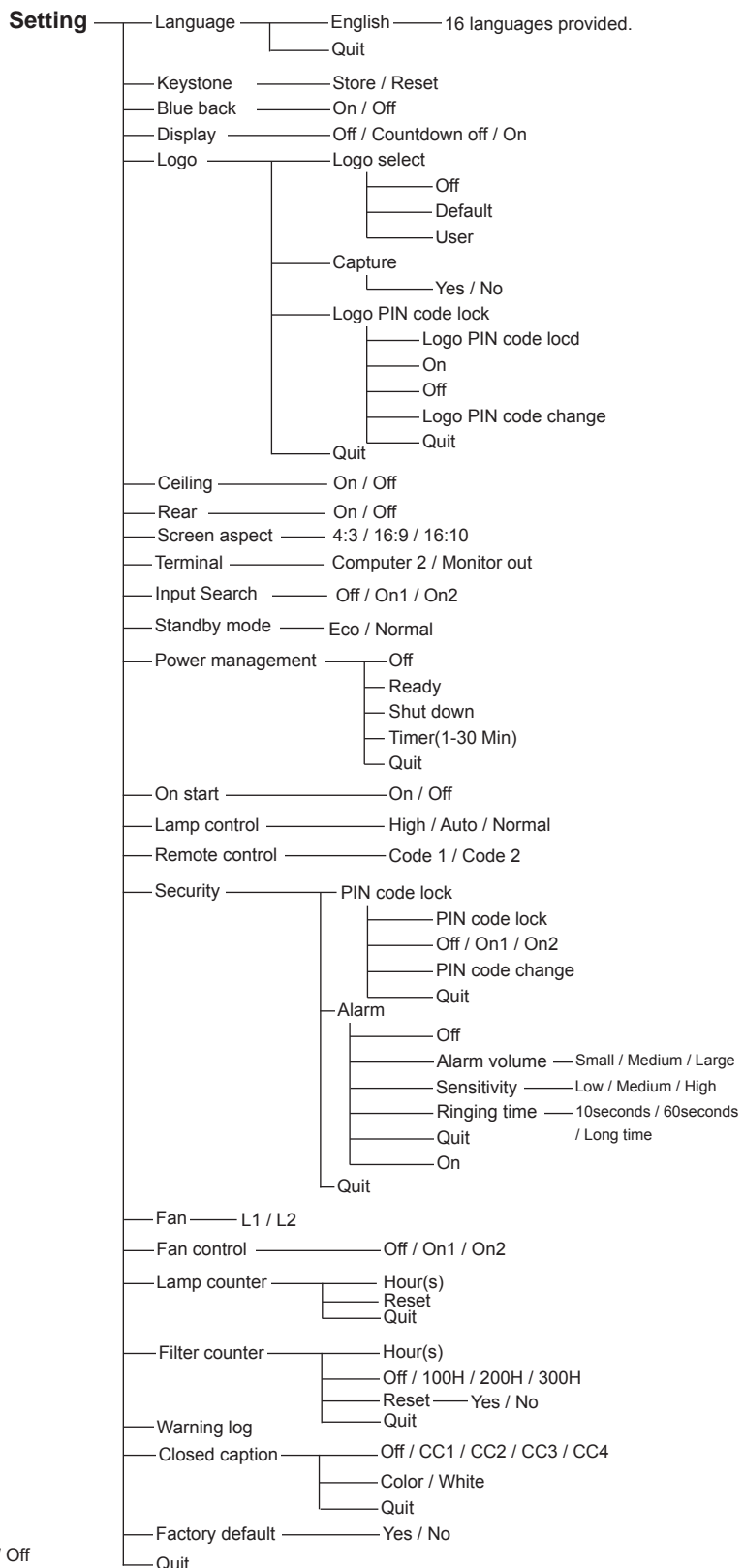



## Indicators and Projector Condition

Check the indicators for projector condition.

Indicators			Projector Condition
POWER red/green	WARNING red	LAMP REPLACE yellow	
●	●	●	The projector is off. (The AC power cord is unplugged.)
⦿	●	*	The projector is preparing for stand-by or the projection lamp is being cooled down. The projector cannot be turned on until cooling is completed.
⦿	●	*	The projector is ready to be turned on with the POWER ON/STAND-BY button.
○	●	*	The projector is operating normally.
⦿	●	*	The projector is in the Power management mode.
⦿	⦿	*	The temperature inside the projector is abnormally high. The projector cannot be turned on. When the projector is cooled down enough and the temperature returns to normal, the POWER indicator lights red and the projector can be turned on. (The WARNING indicator keeps blinking.) Check and clean the air filters.
⦿	⦿	*	The projector has been cooled down enough and the temperature returns to normal. When turning on the projector, the WARNING indicator stops blinking. Check and clean the air filters.
●	⦿	*	The projector detects an abnormal condition and cannot be turned on. Unplug the AC power cord and plug it again to turn on the projector. If the projector is turned off again, unplug the AC power cord and contact the dealer or the service center for service and checkup. Do not leave the projector on. It may cause an electric shock or a fire hazard.

○ ••• green.

⦿ ••• red

● ••• off

⦿ ••• blinks green.

⦿ ••• blinks red.

\* When the projection lamp reaches the end of its life, the LAMP REPLACE indicator lights yellow. When this indicator lights yellow, replace the projection lamp with a new one promptly. Reset the lamp replacement counter after replacing the lamp. See pages 57-58.

## Compatible Computer Specifications

Basically this projector can accept the signal from all computers with the V-, H-Frequency mentioned below and less than 140 MHz of Dot Clock.

When selecting these modes, Screen, Auto PC adjustment and PC adjustment can be limited.

ON-SCREEN DISPLAY	RESOLUTION	H-Freq. (kHz)	V-Freq. (Hz)	ON-SCREEN DISPLAY	RESOLUTION	H-Freq. (kHz)	V-Freq. (Hz)
VGA1	640x480	31.47	59.88	SXGA6	1280x1024	71.69	67.19
VGA2	720x400	31.47	70.09	SXGA7	1280x1024	81.13	76.107
VGA3	640x400	31.47	70.09	SXGA8	1280x1024	63.98	60.02
VGA4	640x480	37.86	74.38	SXGA9	1280x1024	79.976	75.025
VGA5	640x480	37.86	72.81	SXGA10	1280x960	60.00	60.00
VGA6	640x480	37.50	75.00	SXGA11	1152x900	61.20	65.20
VGA7	640x480	43.269	85.00	SXGA12	1152x900	71.40	75.60
MAC LC13	640x480	34.97	66.60	SXGA13	1280x1024	50.00	86.00 (Interlace)
MAC 13	640x480	35.00	66.67	SXGA14	1280x1024	50.00	94.00 (Interlace)
480p	640x480	31.47	59.88	SXGA15	1280x1024	63.37	60.01
575p	768x575	31.25	50.00	SXGA16	1280x1024	76.97	72.00
575i	768x576	15.625	50.00 (Interlace)	SXGA17	1152x900	61.85	66.00
480i	640x480	15.734	60.00 (Interlace)	SXGA18	1280x1024	46.43	86.70 (Interlace)
SVGA1	800x600	35.156	56.25	SXGA19	1280x1024	63.79	60.18
SVGA2	800x600	37.88	60.32	SXGA20	1280x1024	91.146	85.024
SVGA3	800x600	46.875	75.00	SXGA+ 1	1400x1050	63.979	60.190
SVGA4	800x600	53.674	85.06	SXGA+ 2	1400x1050	65.346	60.116
SVGA5	800x600	48.08	72.19	SXGA+ 3	1400x1050	65.121	59.902
SVGA6	800x600	37.90	61.03	MAC21	1152x870	68.68	75.06
SVGA7	800x600	34.50	55.38	MAC	1280x960	75.00	75.08
SVGA8	800x600	38.00	60.51	MAC	1280x1024	80.00	75.08
SVGA9	800x600	38.60	60.31	WXGA1	1366x768	48.36	60.00
SVGA10	800x600	32.70	51.09	WXGA2	1360x768	47.70	60.00
SVGA11	800x600	38.00	60.51	WXGA3	1376x768	48.36	60.00
MAC16	832x624	49.72	74.55	WXGA4	1360x768	56.16	72.00
XGA1	1024x768	48.36	60.00	WXGA6	1280x768	47.776	59.870
XGA2	1024x768	68.677	84.997	WXGA7	1280x768	60.289	74.893
XGA3	1024x768	60.023	75.03	WXGA8	1280x768	68.633	84.837
XGA4	1024x768	56.476	70.07	WXGA9	1280x800	49.600	60.050
XGA5	1024x768	60.31	74.92	WXGA10	1280x800	41.20	50.00
XGA6	1024x768	48.50	60.02	WXGA 11	1280x800	49.702	59.810
XGA7	1024x768	44.00	54.58	WUXGA 1	1920 x 1200	74.556	59.885
XGA8	1024x768	63.48	79.35	WUXGA 2	1920 x 1200	74.038	59.950
XGA9	1024x768	36.00	87.17 (Interlace)	WSXGA+ 1	1680 x 1050	65.290	59.954
XGA10	1024x768	62.04	77.07	WXGA+ 1	1440 x 900	55.935	59.887
XGA11	1024x768	61.00	75.70	WXGA+ 2	1440 x 900	74.918	60.000
XGA12	1024x768	35.522	86.96 (Interlace)	UXGA1	1600x1200	75.00	60.00
XGA13	1024x768	46.90	58.20	UXGA2	1600x1200	81.25	65.00
XGA14	1024x768	47.00	58.30	UXGA3	1600x1200	87.5	70.00
XGA15	1024x768	58.03	72.00	UXGA4	1600x1200	93.75	75.00
MAC19	1024x768	60.24	75.08	720p	1280x720	37.50	50.00
SXGA1	1152x864	64.20	70.40	720p	1280x720	45.00	60.00
SXGA2	1280x1024	62.50	58.60	1035i	1920x1035	33.75	60.00 (Interlace)
SXGA3	1280x1024	63.90	60.00	1080i	1920x1080	33.75	60.00 (Interlace)
SXGA4	1280x1024	63.34	59.98	1080i	1920x1080	28.125	50.00 (Interlace)
SXGA5	1280x1024	63.74	60.01				

## Technical Specifications

### Mechanical Information

Projector Type	Multi-media Projector
Dimensions (W x H x D)	12.59" x 5.73" x 11.85" (319.9 mm x 145.5 x 300.9 mm) (Not including protrusions)
Net Weight	7.5 lbs (3.4 kg)
Feet Adjustment	0° to 10.0°

### Panel Resolution

LCD Panel System	0.59" TFT Active Matrix type, 3 panels
Panel Resolution	1,280 x 800 dots
Number of Pixels	3,072,000 (1,280 x 800 x 3 panels)

### Signal Compatibility

Color System	PAL, SECAM, NTSC, NTSC4.43, PAL-M, and PAL-N
High Definition TV Signal	480i, 480p, 575i, 575p, 720p, 1035i, and 1080i
Scanning Frequency	H-sync. 15–100 kHz, V-sync. 50–100 Hz

### Optical Information

Projection Image Size (Diagonal)	Adjustable from 50" to 110"
Projection Lens	F 1.8 lens with f 6.6 mm with manual focus
Throw Distance	1.77' - 3.94' (0.53 m - 1.20 m)
Projection Lamp	200 W

### Interface

Video Input Jack	RCA Type x 1
S-Video Input Jack	Mini DIN 4 pin x 1
Audio Input Jacks	RCA Type x 2
Computer Input 1 / Component Input Terminal	Analog RGB (Mini D-sub 15 pin) Terminal x 1
Computer Input 2 / Monitor Output Terminal	Analog RGB (Mini D-sub 15 pin) Terminal x 1 (In/Out switchable)
Computer/ Component Audio Input Jack	Mini Jack (stereo) x 1
Service Port Connector	Mini DIN 8 pin x 1
LAN Connection Terminal	100 Base-TX (100Mbps)/10Base-T (10Mbps), RJ45
Audio Output Jack	Mini Jack (stereo) x 1 (Variable)

### Audio

Internal Audio Amp	1.0 W RMS
Built-in Speaker	1 speaker, ø1.1" (28 mm)

### Power

Voltage and Power Consumption	AC 100–120 V (3.2 A Max. Ampere), 50/60 Hz (The U.S.A and Canada) AC 200–240 V (1.6 A Max. Ampere), 50/60 Hz (Continental Europe and The U.K.)
-------------------------------	---

### Operating Environment

Operating Temperature	41°F–95°F (5°C–35°C)
Storage Temperature	14°F–140°F (-10°C–60°C)

### Remote Control

Battery	AA or LR6 1.5V ALKALINE TYPE x 2
Operating Range	16.4' (5 m)±30°
Dimensions	1.9" (W) x 0.87" (H) x 5.7" (D) (49 mm x 22 mm x 145.3 mm)
Net Weight	3.53 oz (100 g) (including batteries)

### Antitheft Alarm

Battery	CR2 3V LITHIUM BATTERY x 1
---------	----------------------------

**Accessories**

- Owner's Manual(CD-ROM)
- Network Application (CD-ROM)
- Quick Reference Guide
- AC Power Cord
- Remote Control and Batteries
- Battery for Antitheft alarm function
- VGA Cable
- Lens Cover with String
- PIN Code Label
- Alarm Label

- The specifications are subject to change without notice.
- LCD panels are manufactured to the highest possible standards. Even though 99.99% of the pixels are effective, a tiny fraction of the pixels (0.01% or less) may be ineffective by the characteristics of the LCD panels.

**Dimensions**

Unit: inch (mm)

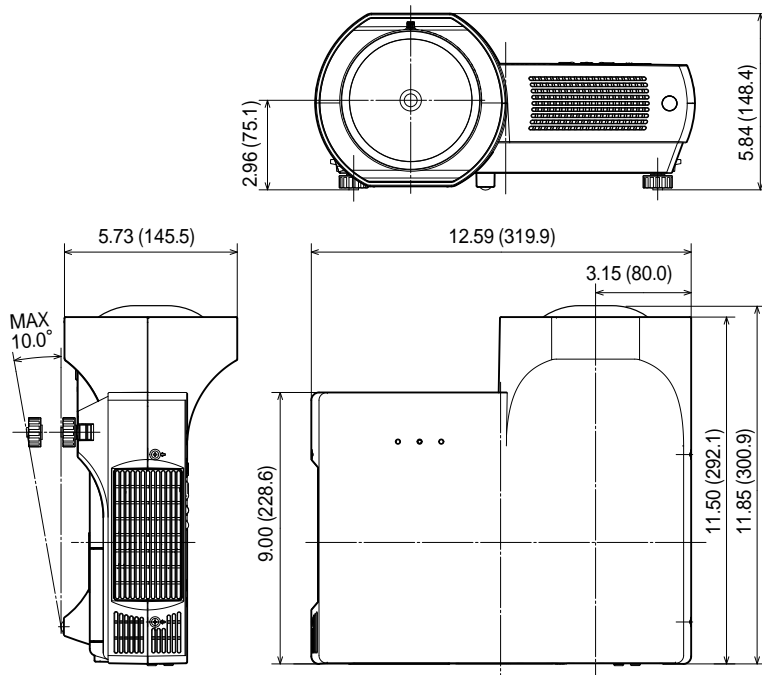

Screw Holes for Ceiling Mount  
Screw: M4  
Depth: 0.47 (12.0)

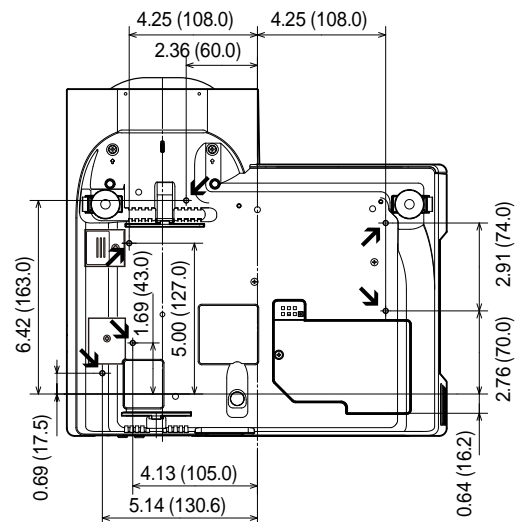

## Configurations of Terminals

### COMPUTER INPUT/COMPONENT INPUT/MONITOR OUTPUT TERMINAL (ANALOG)

Terminal : Analog RGB (Mini D-sub 15 pin)

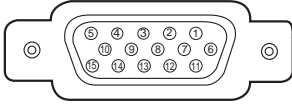

1	Red (R/Cr) Input / Output	9	+5V Power / -----
2	Green (G/Y) Input / Output	10	Ground (Vert.sync.)
3	Blue (B/Cb) Input / Output	11	Ground / -----
4	-----	12	DDC data / -----
5	Ground (Horiz.sync.)	13	Horiz. sync. Input/Output (Composite H/V sync.)
6	Ground (Red)	14	Vert. sync.
7	Ground (Green)	15	DDC clock / -----
8	Ground (Blue)		

### SERVICE PORT CONNECTOR

Terminal : Mini DIN 8-PIN

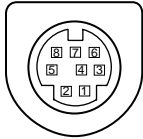

	Serial
1	R X D
2	-----
3	-----
4	GND
5	RTS / CTS
6	T X D
7	GND
8	GND

### LAN TERMINAL

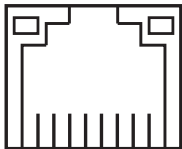

87654321

1	TX +	5	-----
2	TX -	6	RX -
3	RX +	7	-----
4	-----	8	-----

## PIN Code Number Memo

Write down the PIN code number in the column below and keep it with this manual securely. If you forgot or lost the number and unable to operate the projector, contact the service station.

**PIN Code Lock No.**

--	--	--	--

Factory default set No: 1 2 3 4\*

**Logo PIN Code Lock No.**

--	--	--	--

Factory default set No: 4 3 2 1\*

**Alarm PIN Code No.**

--	--	--	--

Factory default set No: 1 1 1 1\*

\* Should the four-digit number be changed, the factory set number will be invalid.

While the projector is locked with the PIN code...

Put the label below (supplied) to a prominent place of the projector's body while it is locked with a PIN code.



While the Antitheft alarm function is set...

Put the label below (supplied) to a prominent place of the projector's body while the Antitheft alarm function is set.

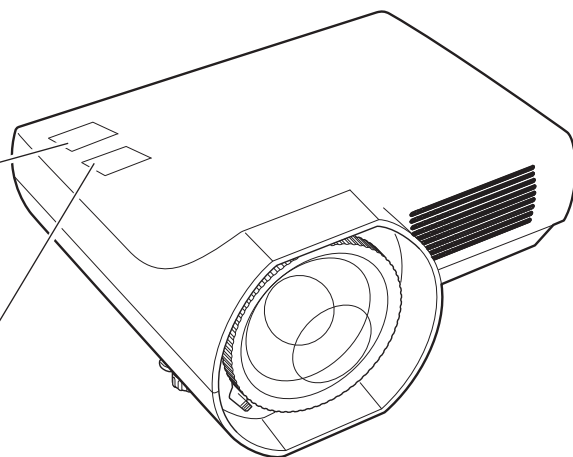



# PROJECTOR