

myprojectorlamps.com

**The most trusted, dependable name
in projector lamp sales.**



<http://www.myprojectorlamps.com>



<http://www.myprojectorlamps.ca>



<http://www.myprojectorlamps.eu>

The following projector manual has not been modified or altered in any way.

DATA PROJECTOR

U2-X2000

User's Manual

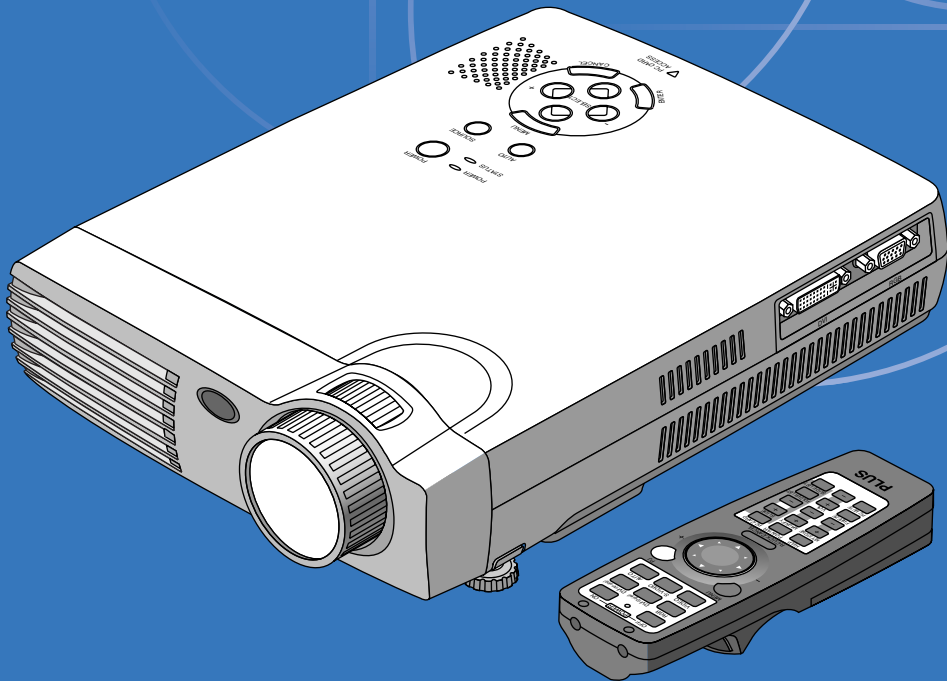

IMPORTANT

- * DLP™ (Digital Light Processing) and DMD™ (Digital Micromirror Device) are registered trademarks of Texas Instruments Incorporated (U.S.A.).
- * DMD™ is an ultra-precise part developed by Texas Instruments (U.S.A.) which takes the place of liquid crystal (in the projector).
- * AccuBlend is a trademark of NEC Viewtechnology, Ltd.
- * VGA and XGA are trademarks or registered trademarks of International Business Machines Corporation (U.S.A.).
- * S-VGA is a registered trademark of Video Electronics Standards Association.
- * Microsoft, Windows, and PowerPoint are registered trademarks of Microsoft Corporation (U.S.A. and other countries).
- * Macintosh is a trademark of Apple Computer Inc. (U.S.A.).
- * TMDS is a trademark of Silicon Image, Inc.

Note that even in the absence of explanatory notes, serious attention is paid to the trademarks of the various companies and to the product trademarks.

IMPORTANT SAFETY INFORMATION

Precautions

Please read this manual carefully before using your PLUS U2-X2000 Data Projector and keep the manual handy for future reference.

CAUTION

TO PREVENT SHOCK, DO NOT OPEN THE CABINET. NO USER-SERVICEABLE PARTS INSIDE. REFER SERVICING TO QUALIFIED PLUS SERVICE PERSONNEL.



This symbol warns the user that uninsulated voltage within the unit may have sufficient magnitude to cause electric shock. Therefore, it is dangerous to make any kind of contact with any part inside of this unit.



This symbol alerts the user that important literature concerning the operation and maintenance of this unit has been included. Therefore, it should be read carefully in order to avoid any problems.

The above cautions are given on the bottom of the product.

WARNING

TO PREVENT FIRE OR SHOCK, DO NOT EXPOSE THIS UNIT TO RAIN OR MOISTURE. DO NOT USE THIS UNIT'S GROUNDED PLUG WITH AN EXTENSION CORD OR IN AN OUTLET UNLESS ALL THREE PRONGS CAN BE FULLY INSERTED. DO NOT OPEN THE CABINET. THERE ARE HIGH-VOLTAGE COMPONENTS INSIDE. ALL SERVICING MUST BE DONE BY QUALIFIED PLUS SERVICE PERSONNEL.

WARNING

This is a class A product. In a domestic environment this product may cause radio interference in which case the user may be required to take adequate measures.

RF Interference

WARNING

The Federal Communications Commission does not allow any modifications or changes to the unit EXCEPT those specified by PLUS Technologies in this manual. Failure to comply with this government regulation could void your right to operate this equipment.

This equipment has been tested and found to comply with the limits for a Class A digital device, pursuant to Part 15 of the FCC Rules. These limits are designed to provide reasonable protection against harmful interference when the equipment is operated in a commercial environment. This equipment generates, uses, and can radiate radio frequency energy and, if not installed and used in accordance with the instruction manual, may cause harmful interference to radio communications. Operation of this equipment in a residential area is likely to cause harmful interference in which case the user will be required to correct the interference at his own expense.

IMPORTANT SAFETY INFORMATION

Important Safeguards

These safety instructions are to ensure the long life of the unit and to prevent fire and shock. Please read them carefully and heed all warnings.

Installation

- For best results, use the unit in a darkened room.
- Place the unit on a flat, level surface in a dry area away from dust and moisture.
- Do not place the unit in direct sunlight, near heaters or heat radiating appliances.
- Exposure to direct sunlight, smoke or steam can harm internal components.
- Handle the unit carefully. Dropping or jarring can damage internal components.
- Do not place heavy objects on top of the unit.

Power Supply

- The unit is designed to operate on a power supply of 100 - 240 V 50/60 Hz AC. Ensure that your power supply fits these requirements before attempting to use the unit.
- For PLUGGABLE EQUIPMENT, the socket-outlet shall be installed near the equipment and shall be accessible.
- Handle the power cable carefully and avoid excessive bending. A damaged cord can cause electric shock or fire.
- Disconnect the power cable (mains lead) from the power outlet after using the unit. Before disconnecting the power cable, make sure that the POWER indicator lights in amber (not blinking or in green).

Cleaning

- Disconnect the power cable (mains lead) from the unit.
- Clean the cabinet of the unit periodically with a damp cloth. If heavily soiled, use a mild detergent. Never use strong detergents or solvents such as alcohol or thinner.
- Use a blower or lens paper to clean the lens, and be careful not to scratch or mar the lens.
- Clean the ventilation slots and speaker grills on the unit periodically using a vacuum cleaner. If accumulated dust blocks the ventilation slots, the unit will overheat, which may cause the unit to malfunction. Use a soft brush attachment when using the vacuum cleaner. Do not use a hard attachment, such as a crevice tool, to prevent the damage to the unit.

Lamp Replacement

- Be sure to replace the lamp when the Status indicator comes on. If you continue to use the lamp after 1000 hours of usage, the lamp will turn off.

Fire and Shock Precautions

- Ensure that there is sufficient ventilation and that vents are unobstructed to prevent the buildup of heat inside the unit. Allow at least 10 cm (3 inches) of space between the unit and walls.
- Prevent foreign objects such as paper clips and bits of paper from falling into the unit. Do not attempt to retrieve any objects that fell into the unit. Do not insert any metal objects such as a wire or screwdriver into the unit. If something should fall into the unit, immediately disconnect the power cable from the unit and have the object removed by a qualified PLUS service person.
- Do not place any liquids on top of the unit.
- **Do not look into the lens while the unit is on. Serious damage to your eyes could result.**

Carrying around

When carrying the unit around, please use the carrying case that comes with it and, to protect the lens from scratches, always shut the sliding lens cap. Also, do not subject the unit to strong mechanical shock.

Major Features

■ **Book-sized, lightweight (at about 2.5 kg/5.5 lb) high-intensity mobile projector**

The synergy of DMD™ and our own optical design serve to improve the optical utilization efficiency. The three light sources (RGB) required in color expression are reproduced with one DMD™. These factors have enabled a design that offers both high intensity and small size/lightweight features.

■ **Sharp, clear picture**

The absence of RGB color infidelity and the inconspicuous gaps between the individual dots permit the display of small characters and diagrams with distinct clarity. An up-close look reveals the difference even more.

■ **Resolutions up to UXGA supported with Advanced AccuBlend function**

Full support of XGA (1024 × 764 dots), and coverage up to UXGA (1600 × 1200 dots) input signals with the Advanced AccuBlend function.

■ **Built-in viewer allows presentations to be made with the stand alone projector**

The built-in viewer permits presentations to be made without a personal computer using presentation materials (created with a personal computer) that have been recorded to a compact flash card, or memory card playback* of pictures taken with a digital camera, etc.

(*Some memory cards cannot be played back.)

■ **Powerful functions for presentations**

The remote control with a remote mouse function allows projector operation and personal computer mouse operation, there is a digital zoom function for enlargement of selected parts, there is a projector pointer function that has several types of arrow cursors, and the projector is equipped with a connector that supports USB which when used with a commercial USB mouse* allows menu operation of the projector as well as the drawing of simple diagrams on the screen. (*Some USB mouse products cannot be used.)

■ **Beautiful reproduction of high-quality images from DVD**

Faithful reproduction of color tones gives rise to the display of natural images. High-quality images such as those from DVD and other sources bring out the display capabilities that are an essential strength of the digital projector.

■ **Inclusion of RGB and DVI connectors allows more kinds of personal computers to be connected**

(Some computers cannot be used, depending on the frequency of the personal computer. See the Table of Supported Frequencies on Page E-79.)

■ **Econo-mode switch function for the lamp output**

Econo-mode saves on maintenance costs by conserving power and extending lamp life.

Advanced AccuBlend

Advanced AccuBlend is a technology that uses digital interpolation technology to convert and display resolutions under conditions that are easier to view when using enlarged displays and when the number of dots of the personal computer output signal differ from the number of dots of the projector DMD panel (e.g., the personal computer output is 1280 × 1024 dots and the projector is 1024 × 768 dots).

In the method that was in use up until now, a simple thinning out and rewriting process was all that was used. This resulted in some problems which hampered readability such as when a number of ruled lines in a table would completely disappear and diagonal lines would be notched. Advanced AccuBlend serves to resolve or reduce such problems.

Table of Contents

Preparation and Background Knowledge

IMPORTANT SAFETY INFORMATION	E-2
Major Features	E-4
Table of Contents	E-5
Checking the Supplied Accessories	E-7
Names of the Main Unit Parts	E-9
Using CompactFlash Cards	E-11
Names of the Remote Control Parts	E-12
Preparing the Remote Control	E-13
Inserting Batteries	E-13
Remote Control Range	E-13
Operating a Personal Computer with the Remote Control	E-14
Connections with the Personal Computer	E-14
Switching Between Projector Mode and Personal Computer Mode	E-15

Setup and Projection

The Procedure Up to Projecting to the Screen	E-16
Placement Guide	E-17
Screen Size and Projection Distance	E-17
Connecting Personal Computers and Video Equipment	E-18
Connections with Personal Computers	E-18
Personal Computers with a DVI Connector	E-18
Personal Computers with a Mini D-Sub 15-Pin Connector	E-19
To Output the External Output Signal of a Notebook Computer	E-20
Video Equipment with VIDEO Connectors	E-21
Video Equipment with S-VIDEO Connectors	E-21
Connections with Component Signals	E-22
Connections with the AUDIO Jack	E-23
Power Cable Connections and Switching the Power On/Off	E-24
Operating	E-24
Finishing	E-26
Adjustment of the Projection Screen	E-27
Adjustment of the Projection Screen	E-27

General Operation

General Operation	E-29
Input Selection	E-29
Automatic Adjustment of Analog RGB	E-29
Viewing the Projector Operation Description	E-30
Using the Pointer	E-30
Enlarging the Image	E-31
Adjustment of the Volume	E-31
Correcting Keystone Distortion of the Projection Screen	E-32
Freezing a Moving Picture	E-32
Cancelling Video and Audio	E-32

Menu Operations

Menu Operation Method	E-33
Operating Menus	E-34
Menu list	E-38

Adjustments and Settings

Source Select/Picture/Volume	E-40
Source Select	E-40
Picture	E-40
Volume	E-40
Image Options	E-41
Keystone	E-41
Lamp Mode	E-41
Aspect Ratio	E-41
Noise Reduction	E-42
Position/Clock	E-42
Resolution	E-43
Video Filter	E-43
Factory Default	E-44

Table of Contents

Color Management	E-45
Gamma Correction	E-45
Color Matrix	E-45
White Balance	E-45
Projector Options [Menu]	E-46
Menu Mode	E-46
Language	E-48
Projector Pointer	E-48
Menu Display Time	E-48
Source Display	E-49
No Input	E-49
Volume Bar	E-49
Keystone Bar	E-49
Projector Options [Setup]	E-50
Orientation	E-50
Cinema Position	E-50
Background	E-50
Mouse	E-51
PC Card Viewer Options	E-52
Capture Option	E-52
Signal Select	E-53
Auto Adjust (RGB only)	E-53
Auto Start	E-54
Power Management	E-54
Power Off Confirmation	E-54
Keystone Save	E-55
White Segment	E-55
Clear Lamp Hour Meter	E-55
Communication Speed	E-56
Default Source Select	E-56
Control Panel Key Lock	E-56
Tools	E-57
Capture function	E-57
PC card file function	E-58
Chalkboard	E-60
Help	E-62
Contents	E-62
Information	E-63
Using a USB Mouse	E-64
Connecting the USB Mouse	E-64
Operating menus using the USB mouse	E-64
Using the PC Card Viewer function	E-65

Miscellaneous

When the STATUS Indicator is Lit/Flashes	E-72
Troubleshooting	E-73
Cleaning	E-74
Replacing the Lamp Cartridge	E-75
Specifications	E-78
Table of Supported Frequency	E-79
Cabinet Dimensions	E-80

Checking the Supplied Accessories

Remove the main unit and the accessories from the box and check that the following items are included.

Wireless remote control [1] / Size AA batteries [2]

This controls the projector. Please insert the supplied batteries into the remote control prior to first use. (See Page E-13.)

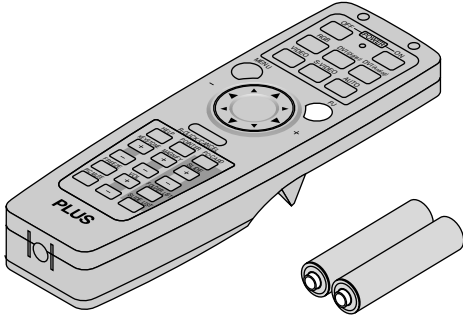

Power cable (1.8 m / 5.9 feet) [1]

This power cable supplies power to the unit. See Page E-24 about connections.

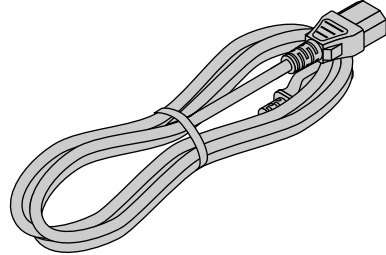

RGB signal cable (Mini D-sub 15-pin, 2 m / 6.6 feet) [1]

This is used in making connections with a personal computer. See Page E-19 about connections.

No. 772709000

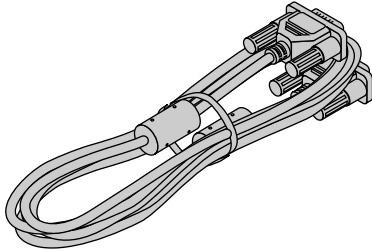

DVI / Mini D-sub 15-pin conversion cable (18 cm / 0.6 feet) [1]

This is used in making connections with a personal computer. See Page E-20 about connections.

No. 772708000

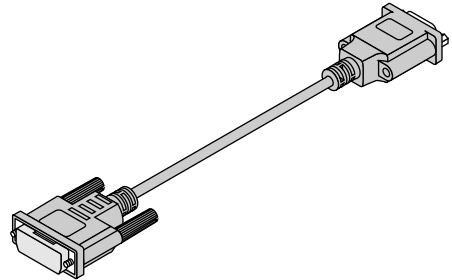

Video cable (RCA pin plug, 2 m / 6.6 feet) [1]

This cable is used in the connection of video equipment that has a video connector. Connections are described on Page E-21.

No. 771703000

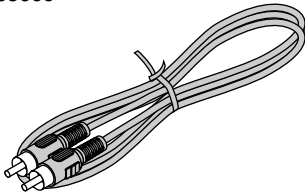

S-Video cable (Mini DIN 4-pin plug, 2 m / 6.6 feet) [1]

This cable is used in the connection of video equipment that has an S-video connector. Connections are described on Page E-21.

No. 771709000

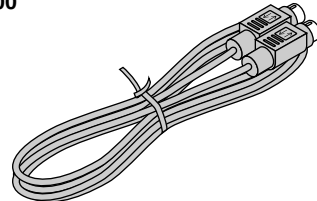

Audio conversion cable (Mini plug / RCA pin plug, 15 cm / 0.5 feet) [1]

This cable is used with equipment whose audio connector is of the phono pin type. Connections are described on Page E-23.

No. 770704000

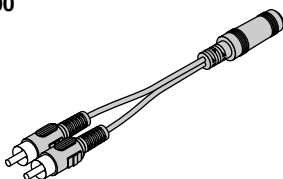

Audio cable (Mini plug, 2 m / 6.6 feet) [1]

This cable is used with equipment that has phono type audio jacks. Connections are described on Page E-23.

No. 769710000

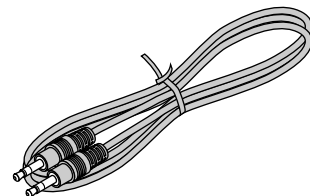

Checking the Supplied Accessories

CompactFlash Card (16 MB) [1] / PC Card Adapter [1]

This card and adapter are used for saving slides created on a personal computer and for playback on a projector. Usage is described on Page E-11.

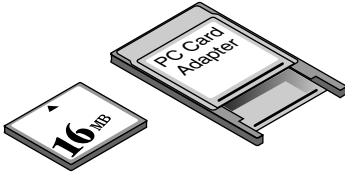

Carrying case (for projector and accessories) [1]

This is a case designed for storing the projector and its accessories.

Use this carrying case when storing or moving the projector.



USB mouse cable (2 m / 6.6 feet) [1] No. 769713000 / PS/2 mouse cable (2 m / 6.6 feet) [1] No. 769712000

This is used when controlling personal computer mouse operation with a remote control. Connections are described on Page E-14.

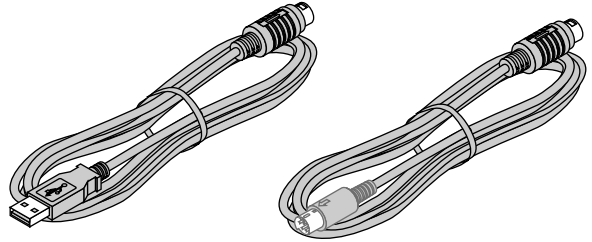

HOW TO PUT THE PROJECTOR INTO THE CARRYING CASE

Attach the lens cap to the projector before putting the projector into the carrying case, and then fasten the velcro strap. Put accessories into the pocket.



User's Manual (CD-ROM edition) [1]

User's Manual (Simplified Edition) [1]

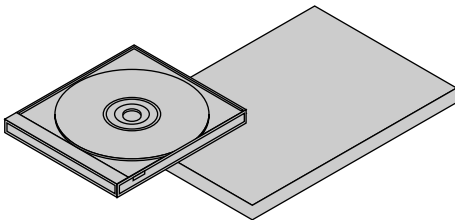

Software CD-ROM (1)

This CD-ROM includes:

- PC Card Viewer Utility
- PC Card Viewer PPT Converter
- PC Control Utility

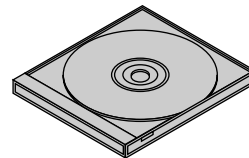

Names of the Main Unit Parts

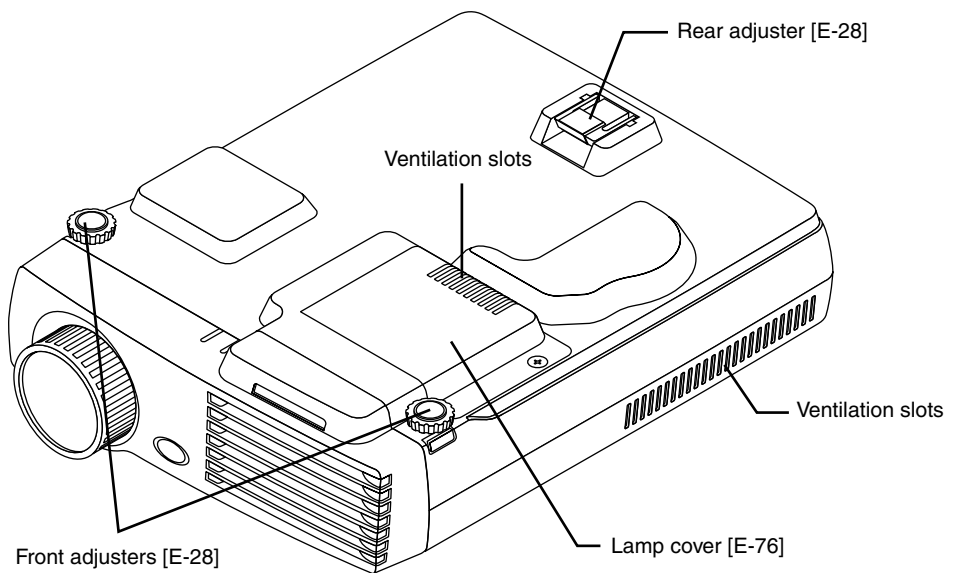
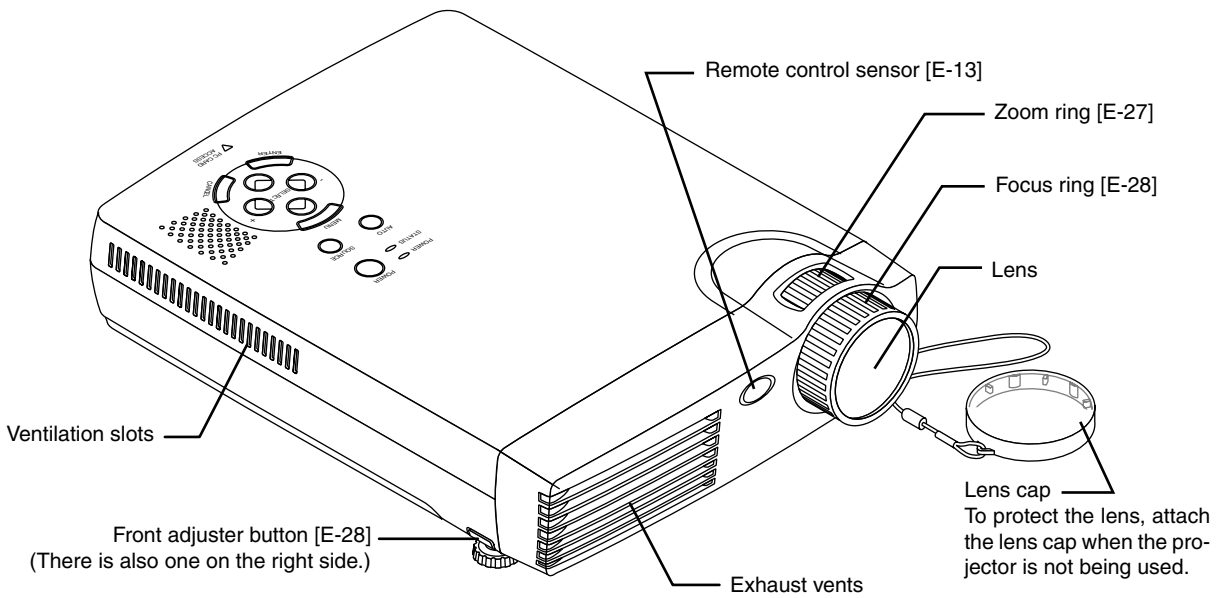

Names of the Main Unit Parts

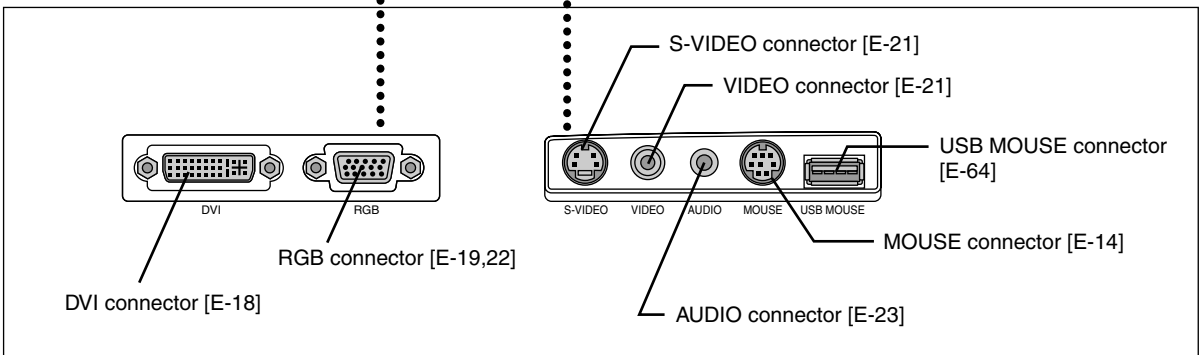
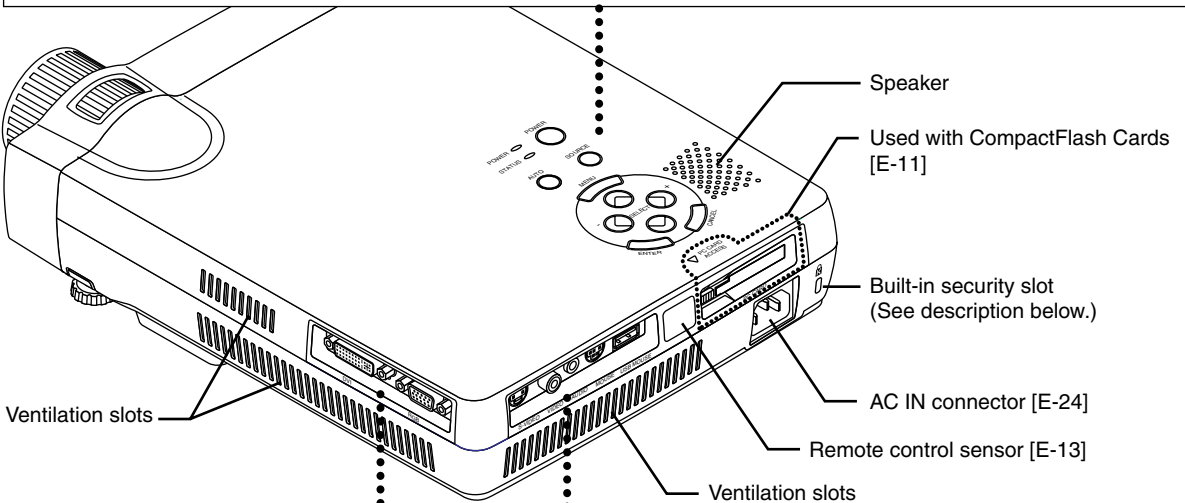
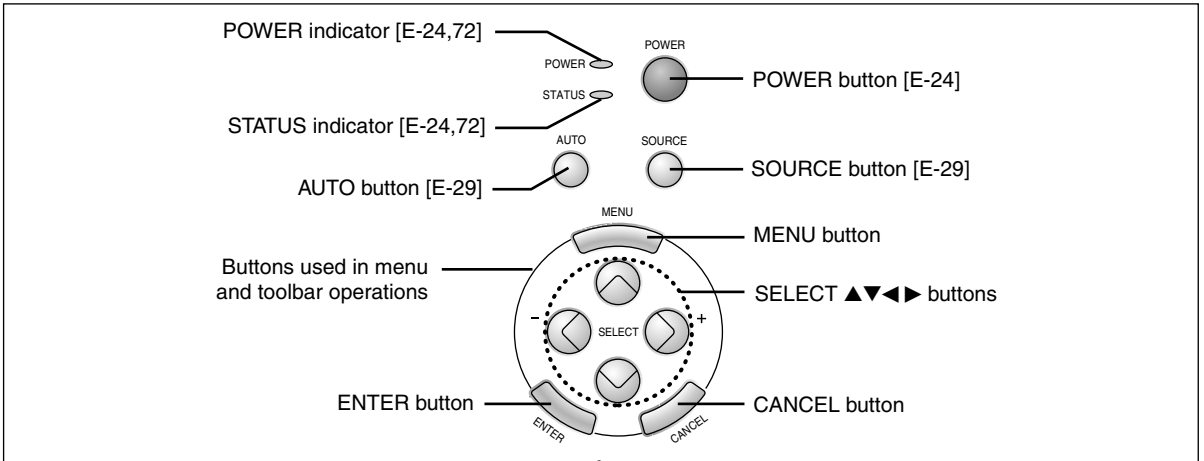

Built-in Security Slot

This security slot supports the MicroSaver Security System manufactured by Kensington Microware Inc.

Using CompactFlash Cards

CompactFlash Cards are used in the data storage of presentation materials created by personal computer as well as in the storage and playback of images that are projected by the projector (i.e., image capture).

Insertion to and Removal from PC Card Slots

Insertion

Keeping the card level and with the front side facing upward, slowly insert the card into the PC Card slot.

When fully inserted the PC Card eject button pops out.

Note: Insertion Orientation of CompactFlash Card

The card has a specific insertion orientation. The card cannot be inserted backward even if attempted and excessive force will cause damage to the equipment. If available, please see the instruction manual of your CompactFlash Card for information about insertion direction.

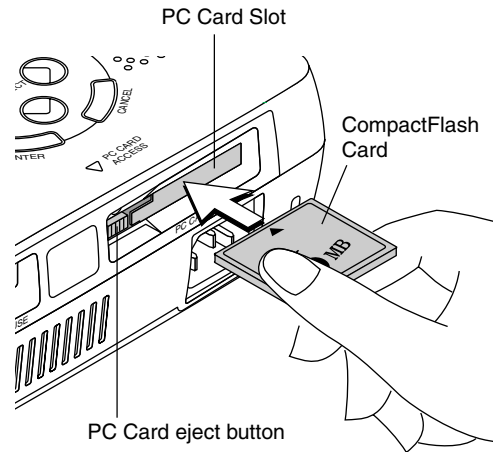

Removal

A press of the PC Card eject button will cause the card to pop out a little. Hold the card by both edges and remove it.

Note:

Do not eject the card when the PC CARD ACCESS indicator is lit (i.e., when the card is being accessed for data). Doing so will damage the CompactFlash Card.

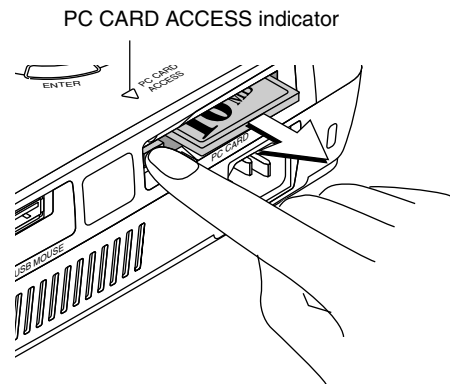

When Inserting to the PC Card Slot of a Personal Computer

Hold the CompactFlash Card in the proper orientation as illustrated in the diagram and firmly insert it into the accessory PC Card adapter. Now insert the adapter into the PC Card slot of the personal computer

Note:

Memory cards that can be used in this projector are CompactFlash Cards of the CFA specification.

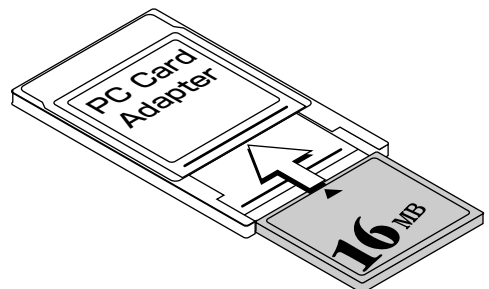

Names of the Remote Control Parts

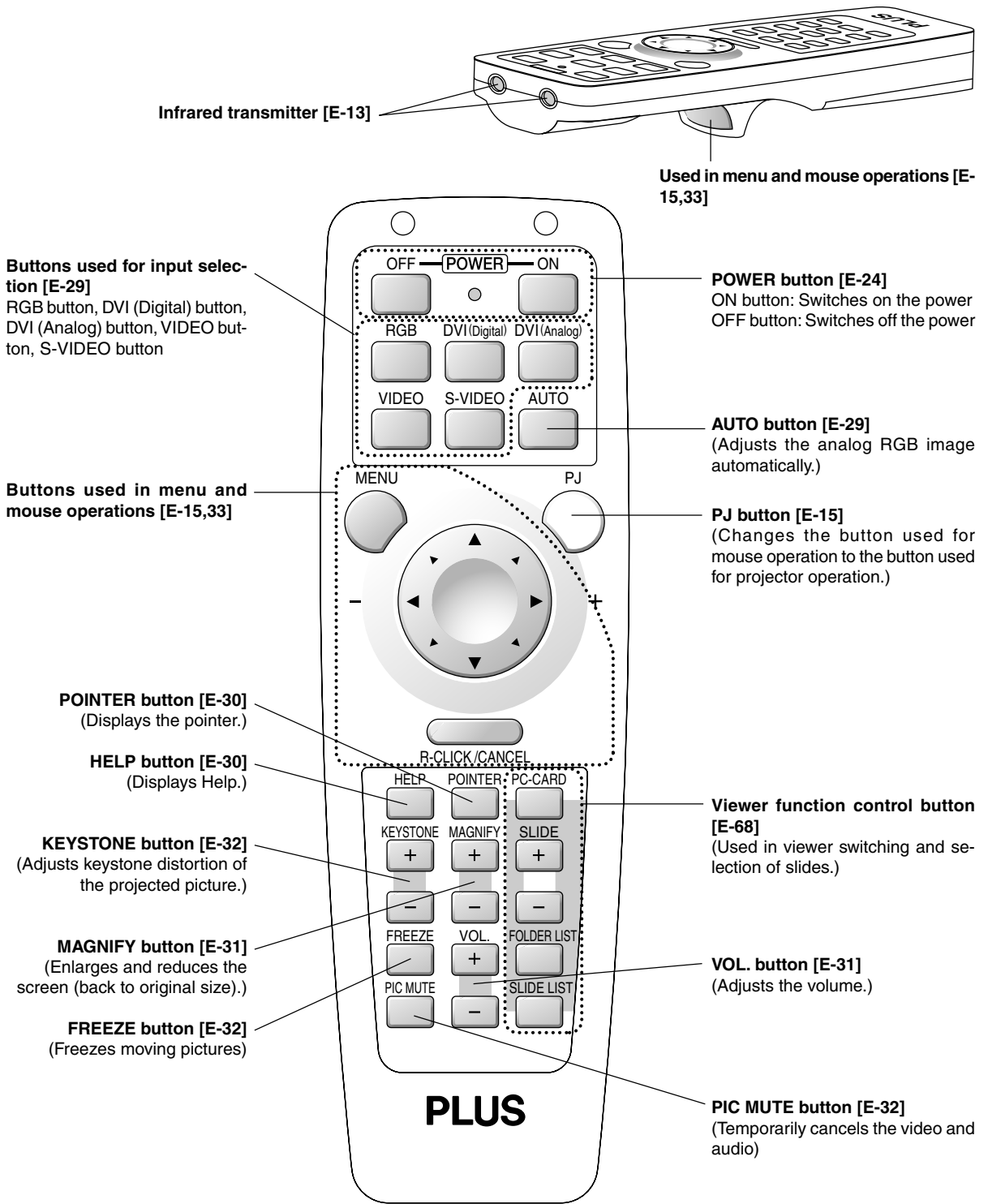

Note: Handling of the Remote Control

- * Do not drop the remote control or handle it inappropriately.
- * Do not expose the remote control to water or other liquids. Should the remote control become wet, wipe it dry immediately.
- * Try to avoid use in hot and/or humid locations.
- * Remove the batteries from the remote control when it is not going to be used for a long period.
- * Some operations are available only through the use of the remote control and attention should be given to its careful handling.

Preparing the Remote Control

Inserting Batteries

- 1** Slide the battery compartment cover (located on the bottom of the remote control) and pull off.

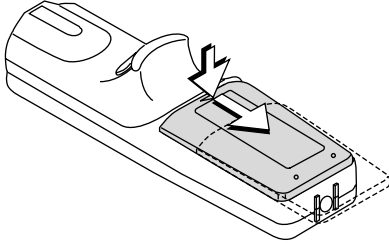

- 2** Insert the batteries to match the "+" and "-" as indicated inside the compartment.

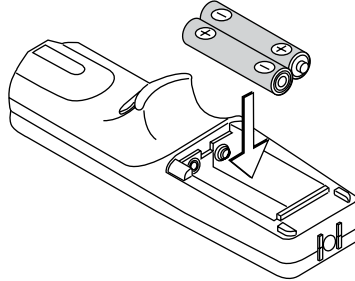

- 3** Return the cover to the original condition.

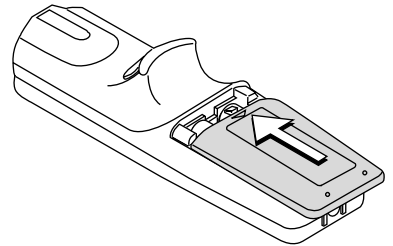

* When replacing the batteries, replace both batteries at the same time with the same type of size AA battery.

Remote Control Range

Point the infrared transmitter of the remote control toward the remote control sensor located at the front or rear of the main unit and operate.

Reception of the remote control signal should generally be possible within the range illustrated below.

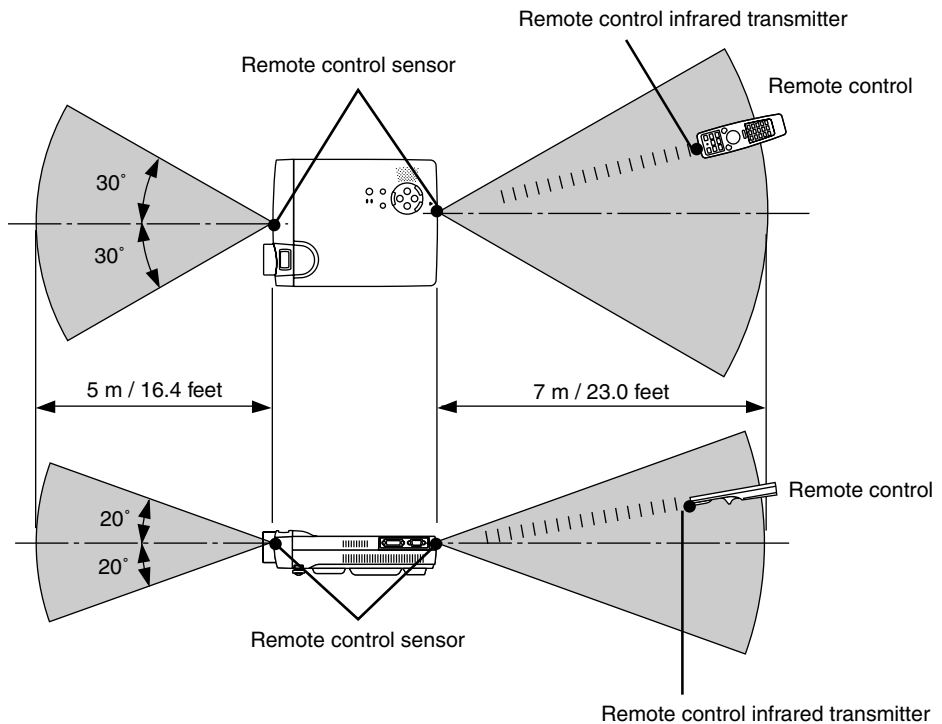

Note:

- * Exposure of the main unit's remote control sensor or the remote control infrared transmitter to bright light or the obstruction of the signal by an obstacle located in the pathway may prevent operation.
- * The remote control will not function when the battery is exhausted.
- * When the same button of the remote control is held down for one minute or longer, the energy saving function will be activated and the remote control transmission will stop. This is not a fault of the unit.

Operating a Personal Computer with the Remote Control

When the personal computer and projector are connected, a portion of the buttons of remote control assume the mouse functions of the personal computer.

Aim the remote control in the direction of the projector's remote control sensor and operate it to control the personal computer mouse operations.

Connections with the Personal Computer

Disconnect the mouse that is currently used with the personal computer and connect the appropriate cable to that connector. The cable will differ depending on the port form of the personal computer's connector. Please see the instruction manual of the personal computer for information about the personal computer's connector for mouse connections.

Note

- * Make sure that the power of the personal computer has been switched off before making connections.
- * Connect cables securely.
- * Depending on such factors as the type of connection and the operating system of the personal computer, a change of settings or restarting of the computer may be necessary.
- * Connection and use of a USB mouse cable to the USB MOUSE connector of this projector is not possible.

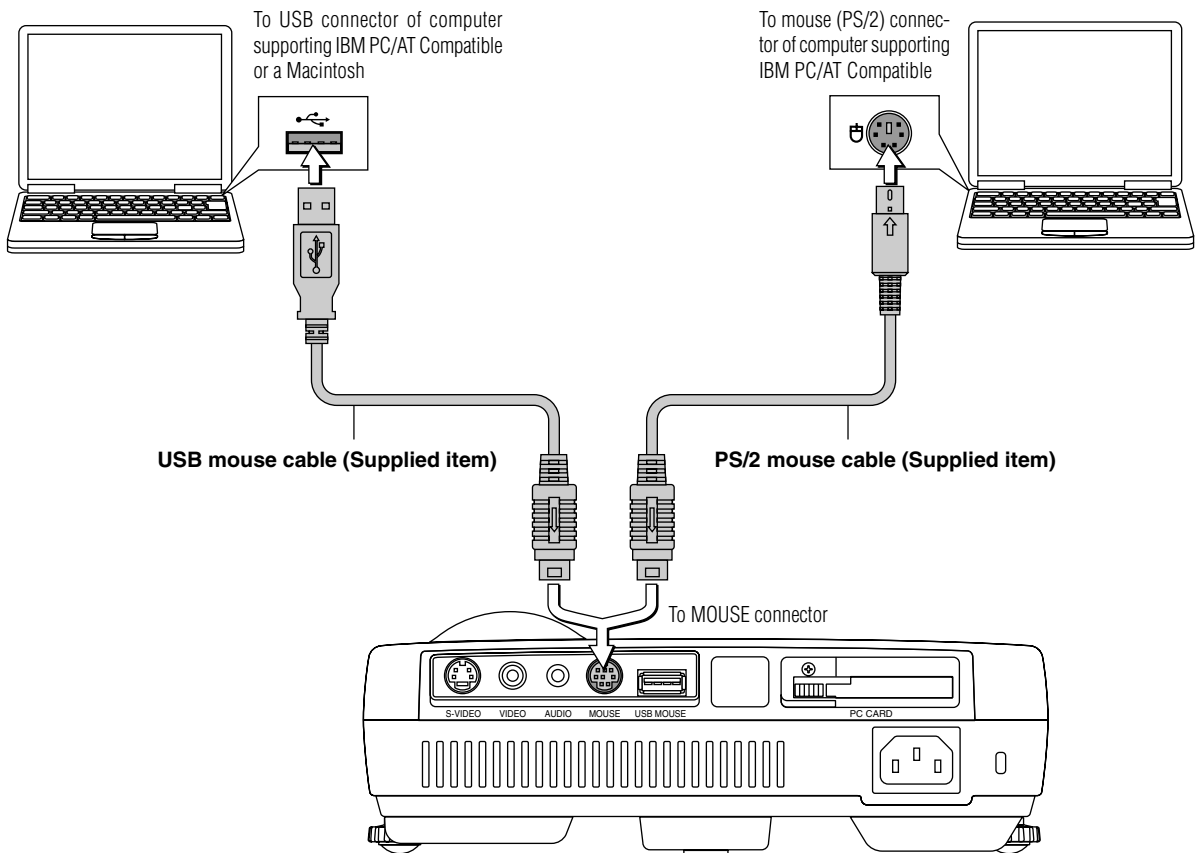

Note: Connections with USB Cables

- * Computers supporting IBM PC/AT Compatible require Windows 98/2000 operating system.
- * When the cable is disconnected and then reconnected to the USB port of the personal computer or the MOUSE connector of the projector, allow at least 5 seconds before reconnecting. Do not repeatedly disconnect and reconnect the cable in a momentary fashion. The personal computer may not be able to correctly identify the projector as a result.
- * The supplied USB cable is a dedicated cable for this projector. There is no guaranty that it will work in connections with other USB equipment.

Operating a Personal Computer with the Remote Control

Switching Between Projector Mode and Personal Computer Mode

The SELECT, CANCEL, and ENTER buttons of the remote control assume the role of the mouse function buttons of the personal computer.

Switching between the projector and personal computer modes selects whether the aforementioned 3 buttons are set as the operation buttons of the projector or the mouse function buttons of the personal computer.

Projector Mode

Press the PJ button to light it in red and the buttons will be set to the functions of the SELECT, CANCEL, and ENTER buttons.

Personal Computer Mode

When the PJ button is unlit or has been pressed again and is no longer illuminated, the buttons return to the functions of the mouse function buttons.

Buttons other than the mouse function buttons serve as the operation buttons of the projector regardless of the projector and personal computer modes.

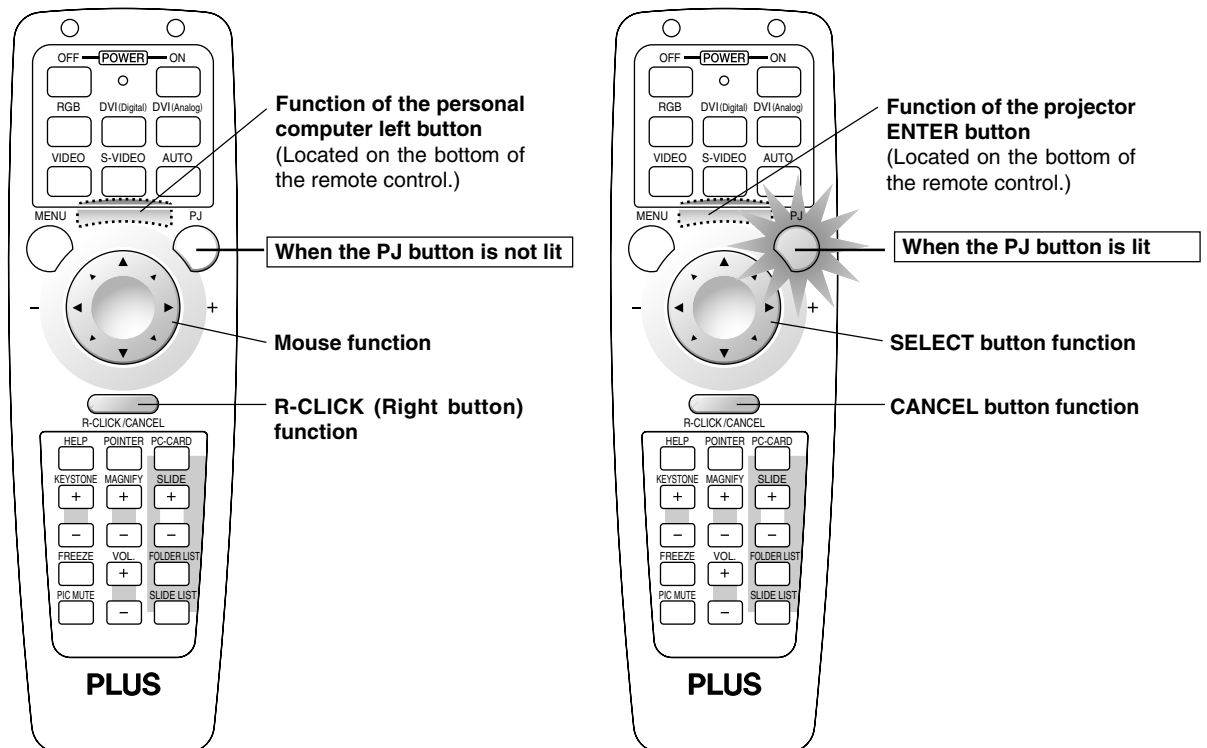

Note:

* When the PJ button has been pressed and a button operation is not executed within 10 seconds, the lamp will go out and the projector will return to the personal computer mode.

* When the MENU button, POINTER button, HELP button, PC-CARD button, FOLDER LIST button, or SLIDE LIST button is pressed, the PJ button lights automatically and the projector mode is set.

The Procedure Up to Projecting to the Screen

Perform setup adjustments in the following order.

1 Position the projector

Determine the locations to set up the screen and the projector.
See "Screen Size and Projection Distance" on Page E-17

2 Connect the video equipment and personal computer

Connect your equipment to the projector.

When making connections with the personal computer's DVI connector or RGB connector, see "Connections with Personal Computers" on Pages E-18 and E-19.

When making connections with the video equipment's video connector or an S-video connector, see "Connections with Composite Signals" on Page E-21.

When making connections with the video equipment's YCbCr connector or YPbPr connector, see "Connections with Component Signals" on Page E-22.

When playing the audio through the built-in speaker of the projector, see "Connections with the AUDIO Jack" on Page E-23.

3 Connecting the power cable and switching on the power

See "Operating" on Page E-24.

See "Finishing" on Page E-26.

4 When selecting the language of menu displays, etc.

(Only when the power is first switched on following purchase)

See "When the Start Screen Appears Upon Switching On the Power" on Page E-25.

5 Switching on the power of the personal computer and video equipment

6 Properly adjust the projection image to the screen

See "Adjustment of the Projection Screen" on Page E-27.

7 Selecting input equipment

See "Input Selection" on Page E-29.

8 Adjust the screen or video image

Adjust the image to the optimum condition as required.

See the Table of Contents for the adjustment items.

Note:

* Please purchase a screen.

* A component cable (Order code 28-690), which is available separately, is required to connect a DVD player or other equipment with YCbCr connectors.

* A component cable (Order code 28-690), which is available separately, is required to connect high definition (HD) video equipment or other equipment with YPbPr connectors.

Placement Guide

- * Use this information as a guide to find out about the screen size when the projector is placed at a certain location, or to find out the approximate size of a screen that will be required.
- * The projection distance over which focussing is adjustable is 1.3 m (4.2 feet) to 14.65 m (48 feet) from the front of the projector lens. The projector should be placed within this range.

Screen Size and Projection Distance

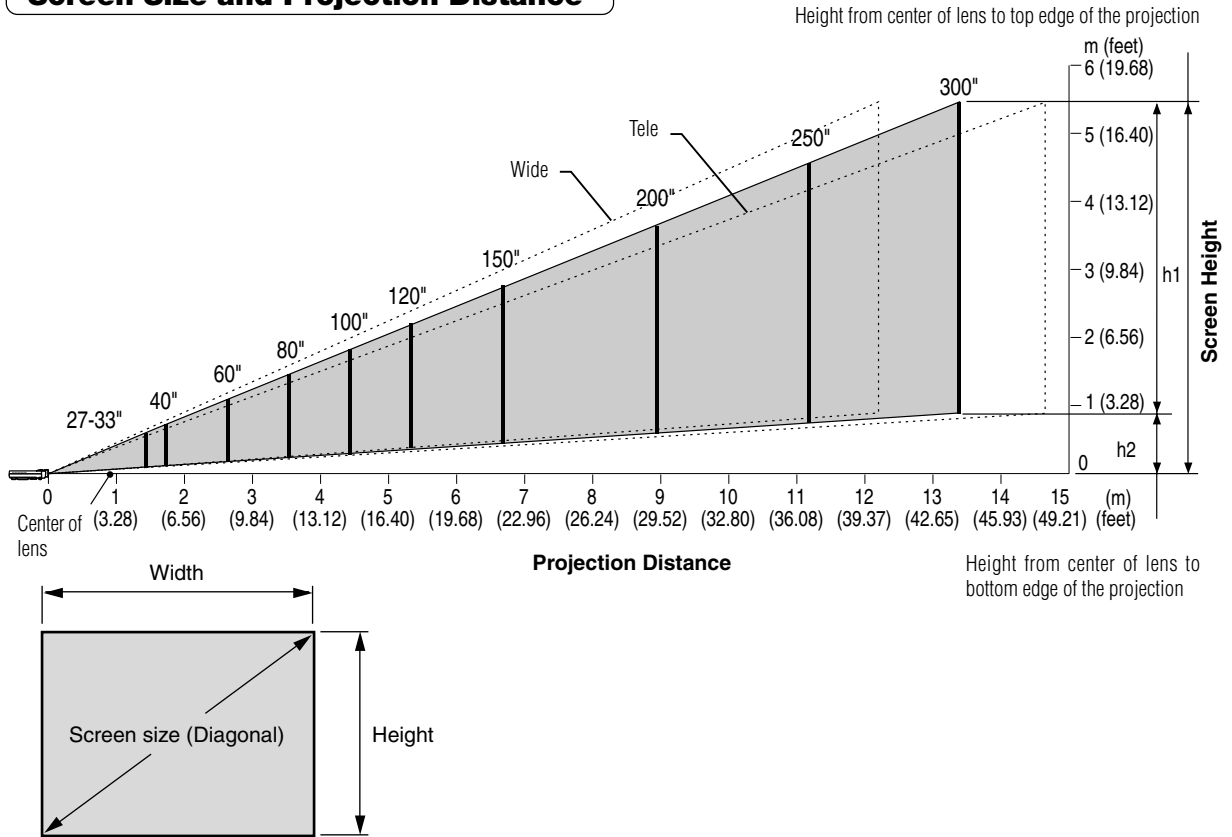

Screen Size Designation (Inches)	Screen Size Width x Height		Projection Distance		Height h1		Height h2	
			(m)	(feet)	(m)	(feet)	(m)	(feet)
	(m)	(feet)	Wide - Tele	Wide - Tele	(m)	(feet)	(m)	(feet)
27"	0.56 × 0.42	1.83 × 1.37	- - 1.30	- - 4.26	0.50	1.64	0.08	0.26
33"	0.67 × 0.50	2.19 × 1.64	1.30 - 1.57	4.26 - 5.15	0.59	1.93	0.09	0.29
40"	0.81 × 0.61	2.65 × 2.00	1.58 - 1.91	5.18 - 6.26	0.72	2.36	0.11	0.36
60"	1.21 × 0.91	3.96 × 2.98	2.40 - 2.89	7.87 - 9.48	1.09	3.57	0.17	0.55
80"	1.62 × 1.21	5.31 × 3.96	3.21 - 3.87	10.53 - 12.69	1.45	4.75	0.23	0.75
100"	2.03 × 1.52	6.66 × 4.98	4.03 - 4.85	13.22 - 15.91	1.81	5.93	0.29	0.95
120"	2.43 × 1.82	7.97 × 5.97	4.85 - 5.83	15.91 - 19.12	2.18	7.15	0.35	1.14
150"	3.04 × 2.28	9.97 × 7.48	6.07 - 7.30	19.91 - 23.95	2.73	8.95	0.44	1.44
200"	4.06 × 3.04	13.32 × 9.97	8.12 - 9.75	26.64 - 31.98	3.64	11.94	0.59	1.93
250"	5.08 × 3.81	16.66 × 12.50	10.16 - 12.20	33.33 - 40.02	4.55	14.92	0.74	2.42
300"	6.09 × 4.57	19.98 × 14.99	12.20 - 14.65	40.02 - 48.06	5.46	17.91	0.89	2.91

Connecting Personal Computers and Video Equipment

Connecting this unit with a personal computer permits presentation data to be projected as a large screen display at conferences, lectures, and on other occasions. Furthermore, connecting this unit to a DVD player or other video equipment source in combination with an audio/video amplifier and speaker system will allow you to enjoy convincing home theater.

Connections with Personal Computers

Please check the following matters before making connections to the personal computer.

- * Suitable resolution for the projector is 1024×768 dots (XGA), and the displayable resolution will differ depending on the personal computer.
See "Table of Supported Frequency" on Page E-79.
- * When making connections to a Macintosh, change to a displayable resolution at the personal computer side.
- * The setting method of the personal computer will differ depending on the personal computer that you are using. For information, read the instruction manual for your personal computer, read the on-line help, or contact the manufacturer of your personal computer.

Personal Computers with a DVI Connector

- * Make the connection to the DVI connector of the projector using a DVI-D cable (which is commercially available).
When connecting, arrange the connectors in the proper orientation and plug in. Turn the screw knobs and fasten to the connector of the projector.
- * Switch the input selection of the projector to "DVI (DIGITAL)".

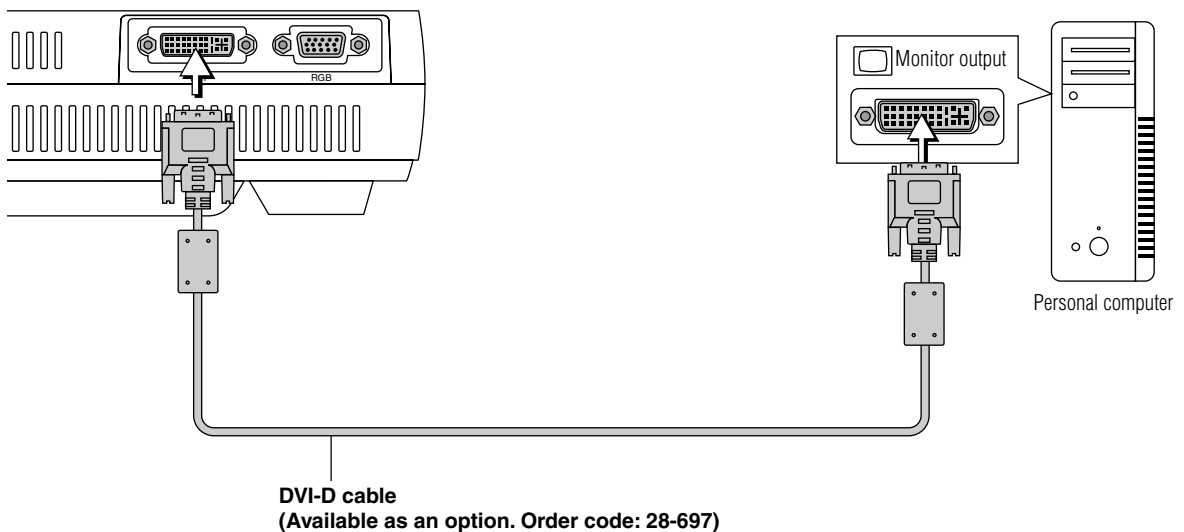

Note:

This projector uses a 29-pin DVI-I connector that supports the digital interface. Digital signal TMDS (Transition Minimized Differential Signaling) of the DVI (Digital Visual Interface) standard is used.

Personal Computers with a Mini D-Sub 15-Pin Connector

- * When making connection with the RGB connector of the projector, use the supplied RGB signal cable. When connecting, arrange the connectors in the proper orientation and plug in. Turn the screw knobs and fasten to the connector of the projector.
Switch the input selection of the projector to "RGB".
- * When making connection with the projector's DVI connector, make the connection via the supplied DVI/mini D-Sub 15-pin conversion cable.
Switch the input selection of the projector to "DVI (ANALOG)".

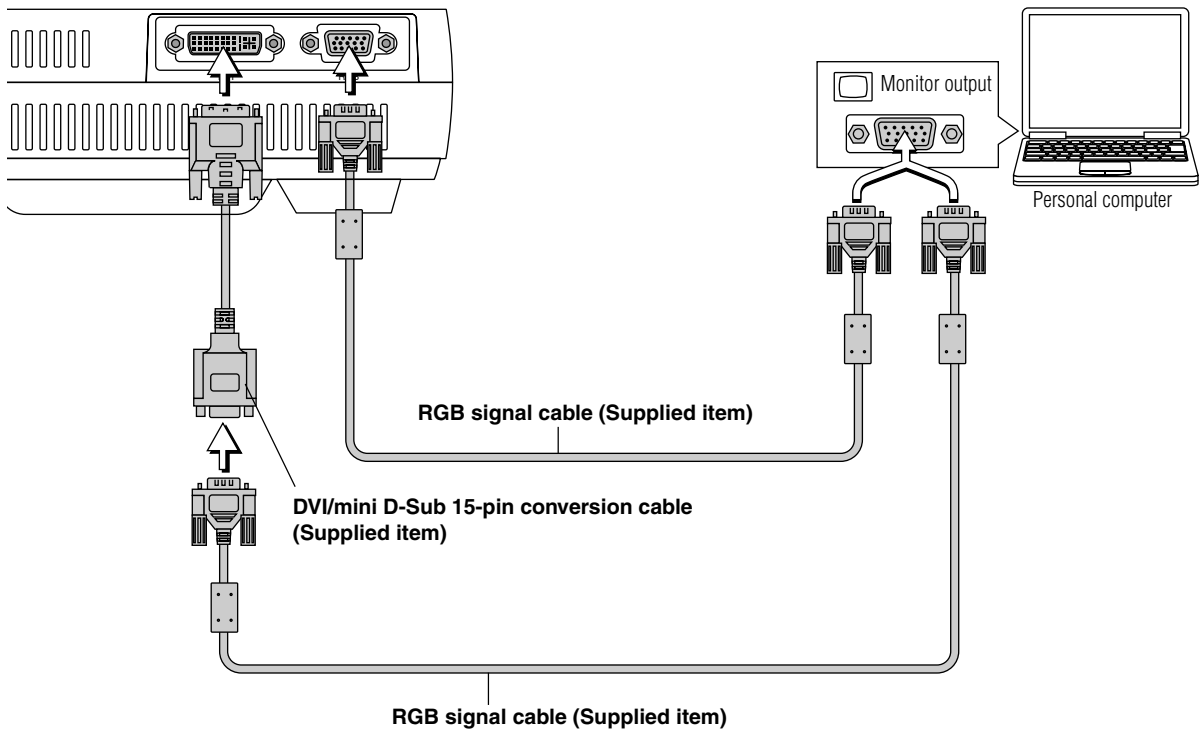

Note:

- * Before making connections, check the power of the projector and the equipment to be connected is switched off.
- * When projection will be with a notebook computer connected, knowledge will be required for the cable connection and notebook computer startup procedure as well as the operation that follows startup. Please consult the instruction manual of your notebook computer or the on-line help.

To Output the External Output Signal of a Notebook Computer

When projection will be with a notebook computer connected, knowledge will be required for the cable connection and notebook computer startup procedure as well as the operation that follows notebook startup. Please consult the instruction manual of your notebook computer or the on-line help while performing the following procedure.

- 1** Check whether a signal is being sent from the notebook computer to the projector.
An indication appearing on the liquid crystal display of the notebook computer does not necessarily mean that an external output signal is being output.
REFERENCE: When the sync frequencies under [Help] → [Information] on the menu of the projector do not display, an external output signal is not being output from the personal computer.
- 2** Should a sign not be output from the notebook computer, please try the operation described below.
For an IBM PC/AT compatible computer, press the [Fn] key plus any one of the [F1] to [F12] keys. (See the table below.)

Manufacturer	Model	Key
akia	All computers	Fn + F2
COMPAQ	ARMADA Series	Fn + F4
	PRESARIO Series	Fn + F3
DELL	All computers	Fn + F8
FUJITSU	All computers	Fn + F10
GATEWAY	All computers	Fn + F3
IBM	All computers	Fn + F7
NEC	All computers	Fn + F3
Panasonic	All computers	Fn + F3
SHARP	All computers	Fn + F5
SONY	All computers	Fn + F7
SOTEC	All computers	Fn + F3
TOSHIBA	All computers	Fn + F5

Note: Table information is current to June 2001.

Note:

When the liquid crystal display of the notebook computer and the projector are displayed at the same time, the projected image might not be correct even though the liquid crystal display shows a correct indication. Should this occur, stop the simultaneous display of the notebook computer and try the mode with external output only. Try an operation such as that described in aforementioned Step 2 and try closing the liquid crystal panel which might result in external output only.

Connecting Personal Computers and Video Equipment

Connections with Composite Signals

Video Equipment with VIDEO Connectors

- * Make the connection to the VIDEO connector of the projector using the supplied video cable.
- * Switch the input selection of the projector to "VIDEO".

Video Equipment with S-VIDEO Connectors

- * Make the connection to the S-VIDEO connector of the projector using the supplied S-video cable.
- * Switch the input selection of the projector to "S-VIDEO".

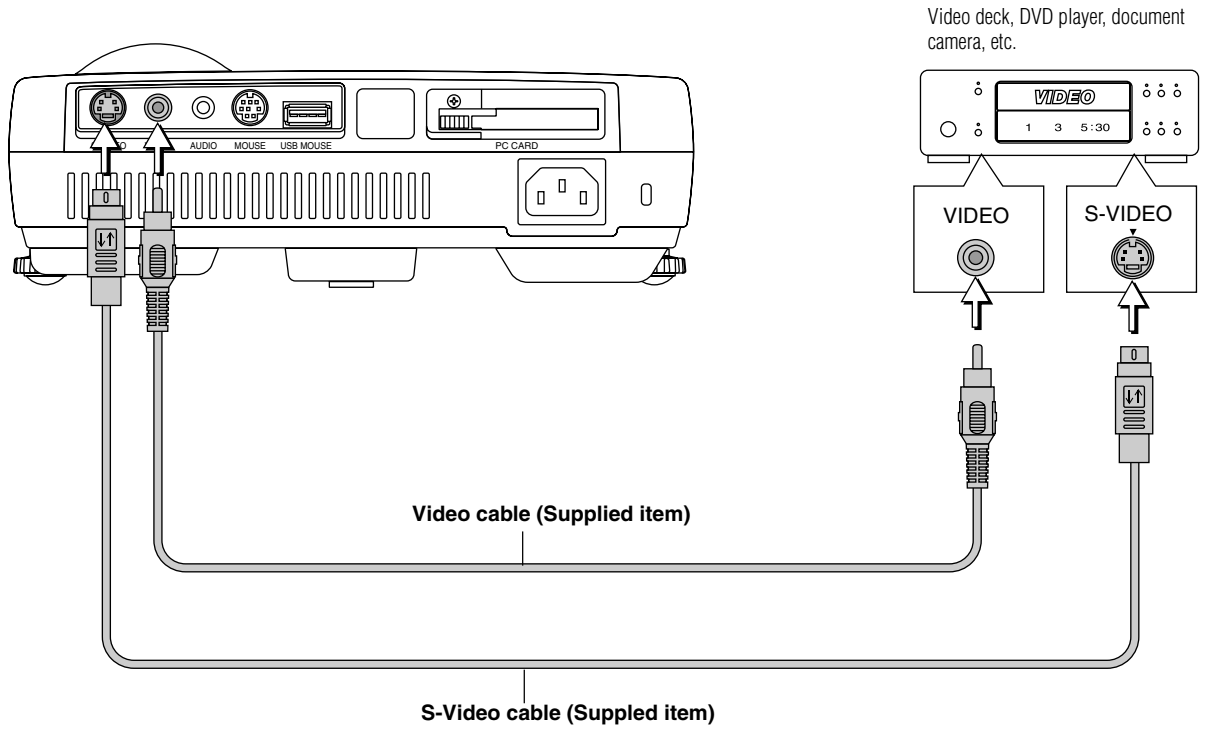

Connections with Component Signals

When the Video Connectors are Y, Cb, and Cr Connectors

- * Make the connection to the projector's RGB connector using the supplied component cable.
- * Switch the input selection of the projector to "RGB".
Usually, the projector identifies RGB and component automatically, but when identification cannot be made, set the RGB signal to component from the projector's menu with the [Setup] → [Page 3] → [Signal Select] screens.

When the Video Connectors are Y, Pb, and Pr Connectors

- * Make the connection to the projector's RGB connector using the supplied component cable.
- * Switch the input selection of the projector to "RGB".
When making connection to a YPbPr output connector (i.e., a high definition video output) such as high definition video, use the [Color Management] → [Color Matrix] screen of the menu to set [Select Color Matrix] to HDTV, and set [Select Color Matrix Type] to Pb/Pr.

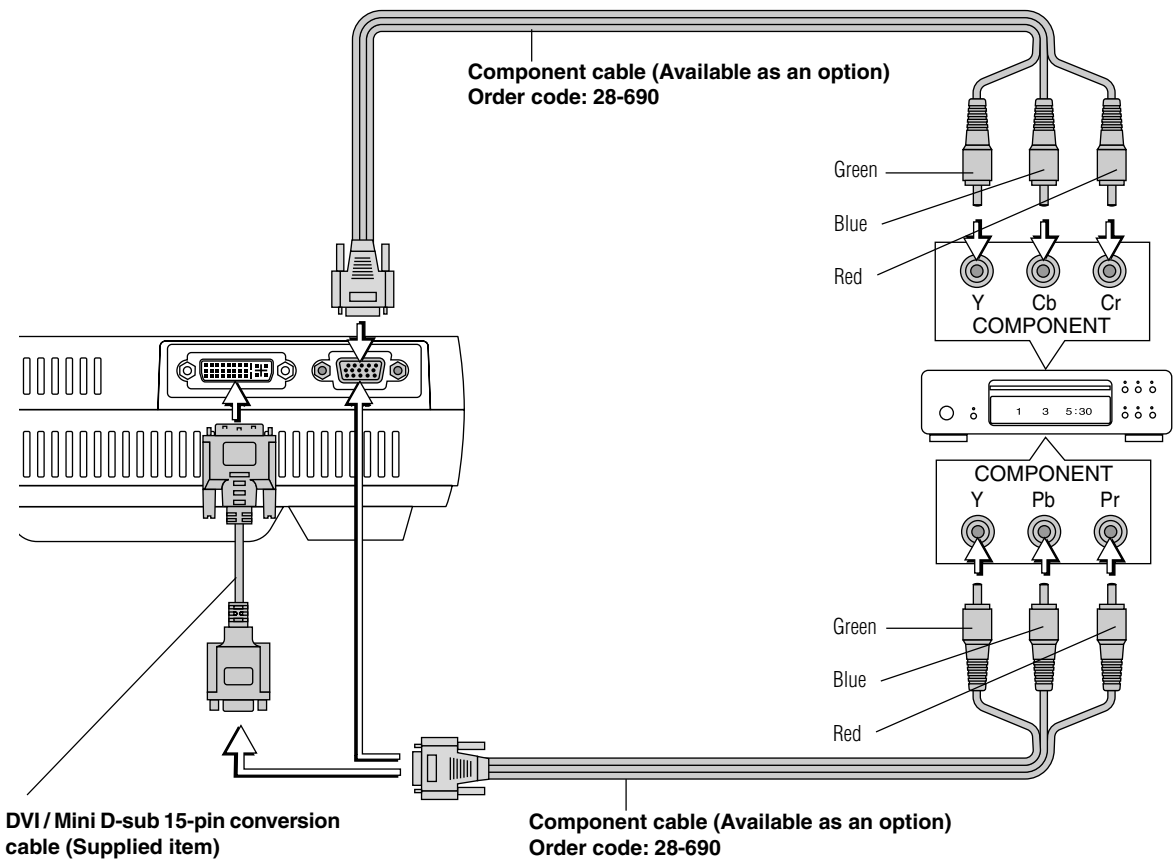

Note:

When connecting a component signal to the DVI connector, connect a component cable via the supplied DVI/mini D-Sub 15-pin conversion cable. The input selection at this time will be "DVI (ANALOG)", and the signal selection and color matrix settings will be the same as with analog RGB.

Connections with the AUDIO Jack

- * Make the connection to the projector's AUDIO jack using the supplied audio cable. When the audio jack of the equipment that is to be connected is of the RCA phono type, make connection via the supplied audio conversion cable.
- * The built-in speaker of the projector provides monaural audio. To enjoy convincing audio reproduction, please connect the audio output of the video equipment to your audio system.
- * The built-in speaker outputs the audio of the equipment connected to the AUDIO jack.

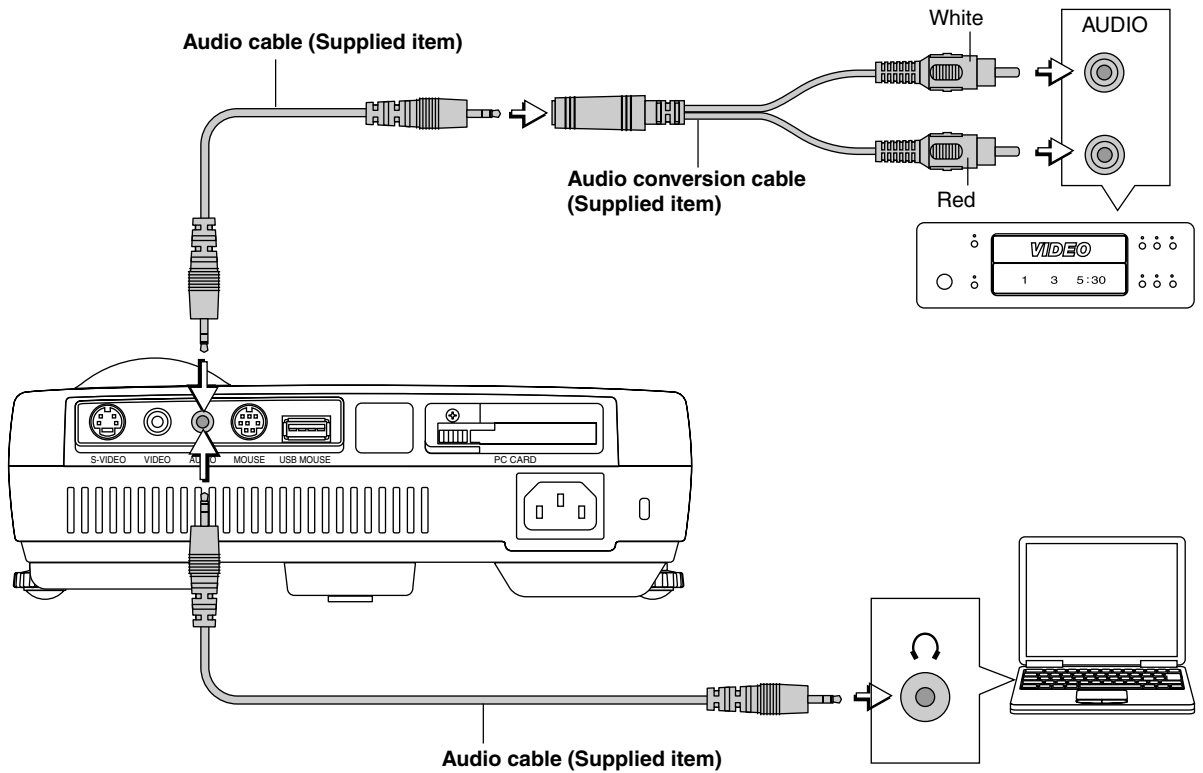

Power Cable Connections and Switching the Power On/Off

There is an order in which the power cable is connected and the power is switched on/off.

Operating

- 1 Connect the AC IN connector of the projector and the power outlet using the supplied power cable.**
The POWER indicator will light in amber, and the unit will enter the standby mode.

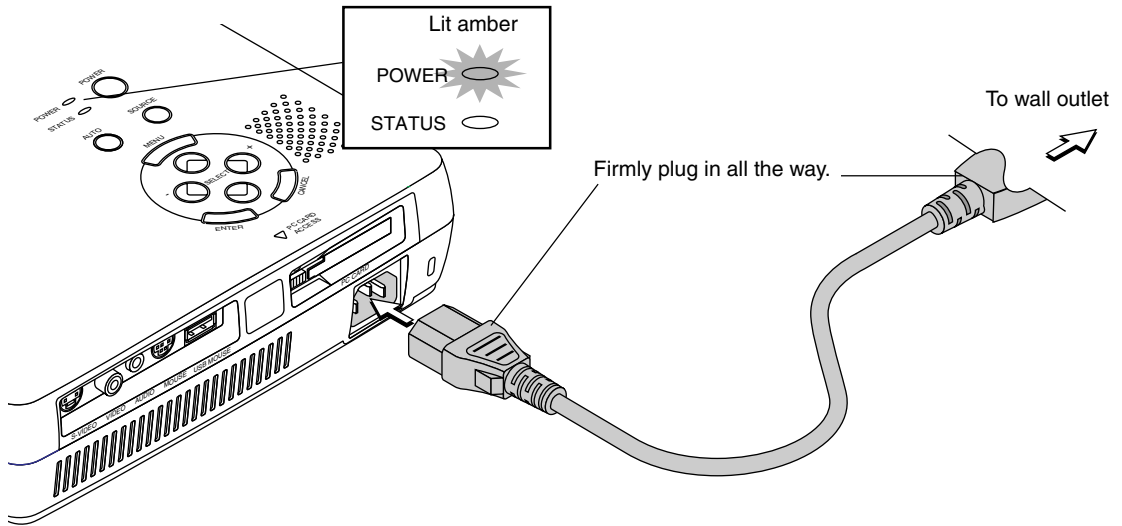

- 2 Switch on the projector power**
Projector operation: Press the POWER button.

Remote control operation: Press the POWER ON button.

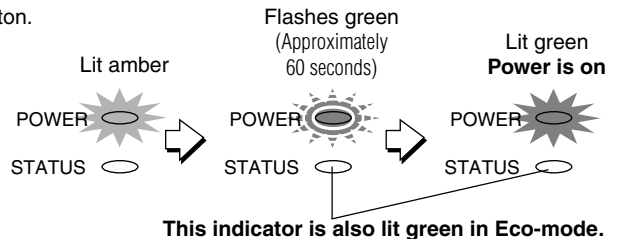
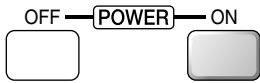

- * The language selection screen will appear when the power is switched on for the first time following purchase. See Page E-25 for information about language selection.
- * The POWER indicator changes to a flashing green and lights steadily after about 60 seconds. The projection screen reaches normal mode brightness.
- * When [Auto Start] has been set to ON, the projector starts automatically upon connecting the power cable.
- * The POWER indicator's steady green light and the STATUS indicator's flashing amber indicate that the projector is retrying to turn on the lamp.
- * At such times that the power does not come on, see "When the STATUS Indicator is Lit/Flashes" on Page E-72.

The projector is now capable of regular projection.

- 3 Switch on the power of the connected equipment**

Note:

- * When the power plug will be unplugged from the power outlet, please place the projector near the power outlet so that it may be reached easily.
- * Press the POWER button or the POWER ON button after the POWER indicator is lit in amber.

Power Cable Connections and Switching the Power On/Off

When the Start Screen Appears Upon Switching On the Power

The start screen will appear when the power is switched on for the first time following purchase. Follow the procedure below to select the display language of the projector.

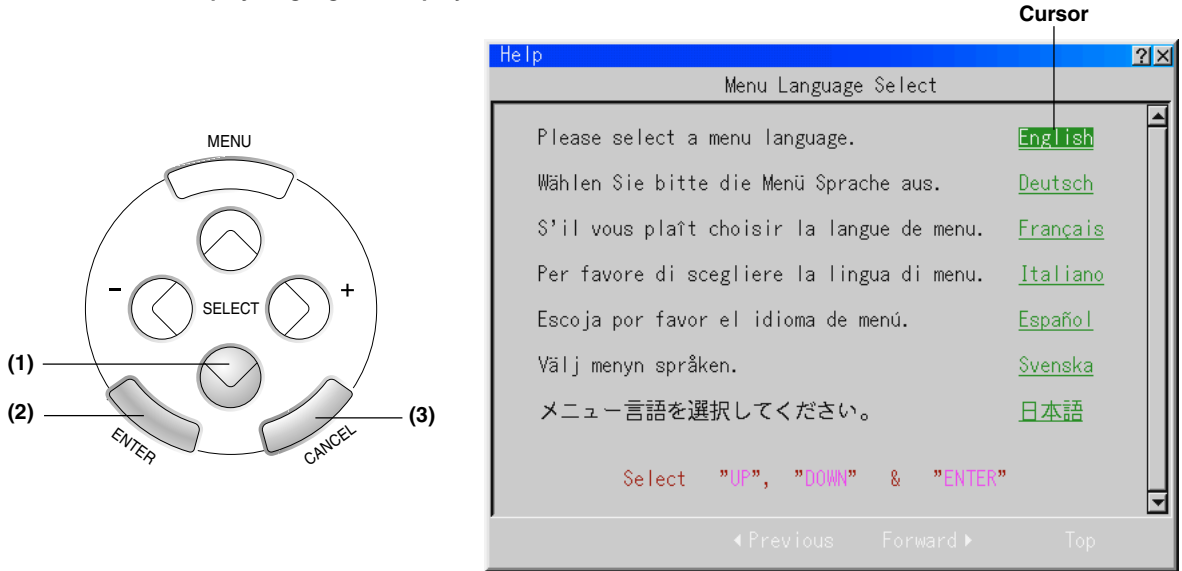

(1) Press the SELECT ▼ button of the projector and align the green cursor with [English].

When remote control operation is used, set the unit to projector mode (in which the PJ button lights in red) before performing this procedure.

(2) Press the ENTER to finalize.

The menu will be displayed in the selected language.

(3) Press the CANCEL button to delete the menu.

This completes the selection of the display language.

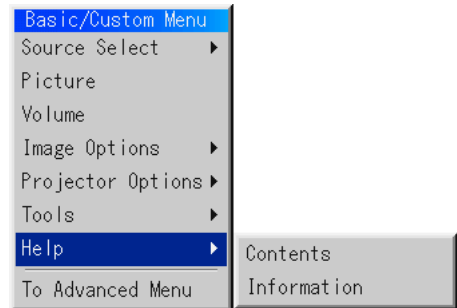

Finishing

1 Switch off the power of the connected equipment

2 Switch off the power of the projector

Projector operation: Press and hold the POWER button for 2 seconds or longer.

Remote control operation: Press and hold the POWER OFF button for 2 seconds or longer.

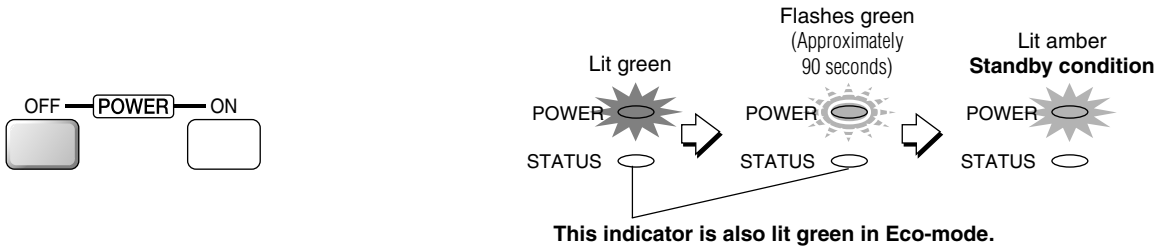

When a check has been placed in the [Power Off Confirmation] box (as described on Page E-54), the message screen will be displayed. When performing operations with the remote control, press the PJ button (which will light in red), then press the SELECT ◀ button, select [Yes], and press the ENTER button.

A message to the effect of "Wait a little while" is displayed, the power is switched off a little while later, the POWER indicator flashes green for 90 seconds and then turns to amber with a steady light (indicating the standby condition).

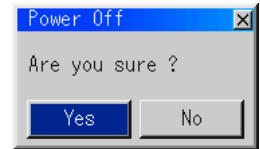

3 Unplug the power cable

Check that the POWER indicator is lit in amber and then unplug the power cable.

The POWER indicator will go off when the power cable is unplugged.

CAUTION

Do not unplug the power cable when the POWER indicator is flashing green. Doing so may shorten the life of the lamp or result in breakdown of the projector.

Adjustment of the Projection Screen

Switch on the power of the connected equipment and make the adjustments with the video signal being input to the projector.

Adjustment of the Projection Screen

1 Turn the zoom ring and adjust the size of the screen.

Adjust to the size to fill the screen. If the size of the screen is outside of the adjustment range, move the projector back or forward.

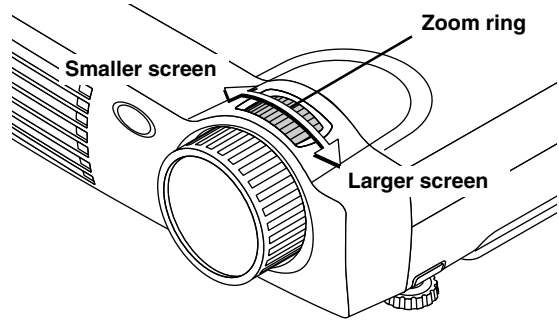

2 Adjust the projection image to the screen.

Check that the screen is set level and vertically.

- (1) If the image is shifted to the left or right, move the main unit horizontally. (Align the center of the screen and the center of the projector lens.)
- (2) If the image is shifted vertically, move the image up or down with the adjuster. See "Making Adjustments with the Adjusters" on Page E-28.
- (3) If the image is slanted, adjust by turning the right or left front adjuster. See "Making Adjustments with the Adjusters" on Page E-28.
- (4) A projection image such as that illustrated in the diagram is the result of the projector not being perpendicular to the screen. Set the projector so that it is pointing straight toward the screen.
- (5) If the image shows keystone distortion, adjust using remote control or menu operations. See "Correcting Keystone Distortion of the Projection Screen" on Page E-32.

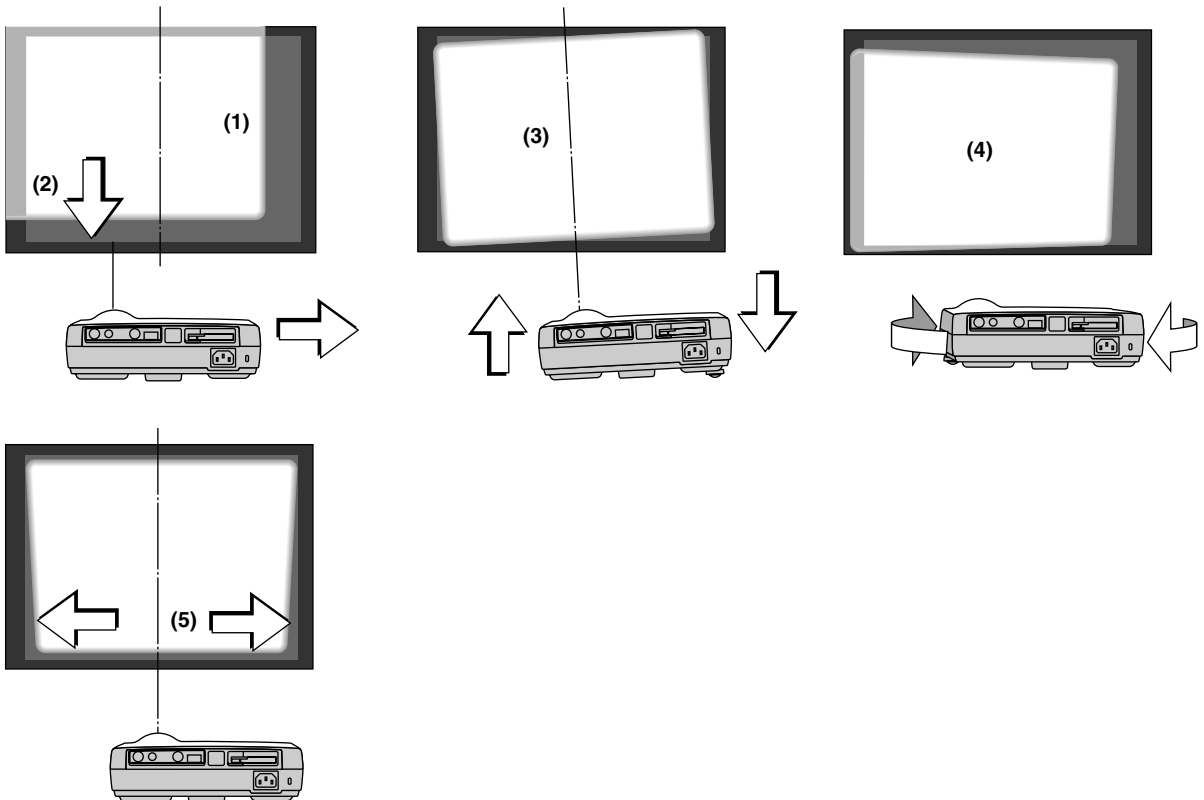

3 Turn the focus ring and adjust the focus of the screen

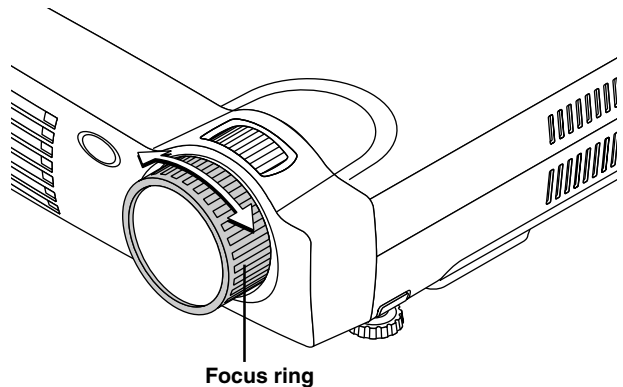
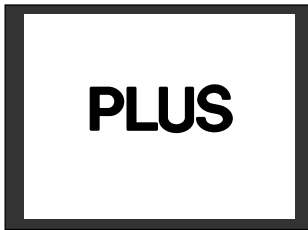

Making Adjustments with the Adjusters

Raising the projection image

While viewing the projection image, (1) press and hold the front adjuster buttons located at the left and right and, (2) raise the projector to align the image with the screen, then release your fingers.

Turn the left and right front adjusters for fine adjustment. Adjust so that there is no shaking of the projector.

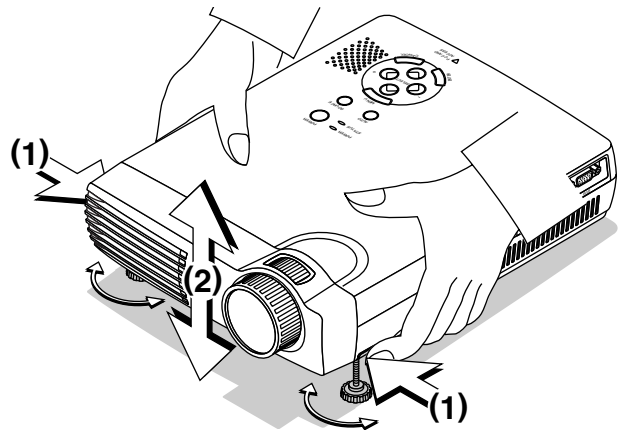

Lowering the projection image

Lower the front adjusters using the operation described above.

Raise the rear adjuster. Turn the left and right front adjusters to make fine adjustments.

Adjust so that there is no shaking of the projector.

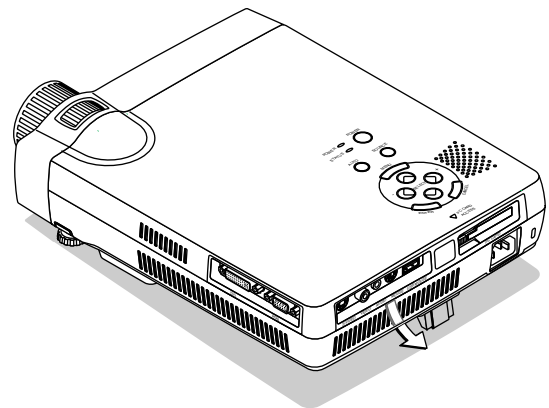

Note:

When the projector has a suspended installation or rear projection is used, the orientation of the projection will need to be changed. Please see "Orientation" on Page E-50.

General Operation

This section describes the use of direct operation with the main unit or remote control buttons.

Input Selection

This operation selects the input signal to be projected.

Projector operation: Press the SOURCE button.

The selection changes one step in the following sequence with each press: RGB → DVI (DIGITAL) → DVI (ANALOG) → Video → S-video → PC Card Viewer. Input connectors that do not have a signal present will be skipped.

Remote control operation: Press the RGB, DVI (Digital), DVI (Analog), VIDEO, S-VIDEO, and PC-CARD buttons directly.

Note:

- * The source input connector to be projected can be specified when the projector power is switched on. See "Default Source Select" on Page E-56.
- * The source input connector can be displayed when the input is switched. See "Source Display" on Page E-49.

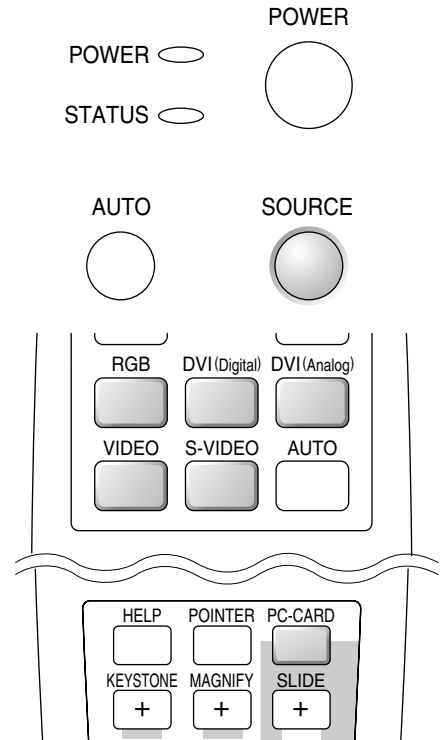

Automatic Adjustment of Analog RGB

This function automatically adjusts the position shift of the projected RGB and DVI (analog) input signal, the size of the picture, vertical striping, and color infidelity.

Projector operation/Remote control operation: Press the AUTO button. A press of the AUTO button starts the automatic adjustment.

Note:

- * If the display position is shifted, vertical lines appear on the picture, or the projection is not good even after using automatic adjustment, or if it takes appreciable time until the display appears when source signals are switched, please perform image adjustment manually. See "Position/Clock" on Page E-42.
- * When the image extends beyond the boundaries of the screen or is smaller than the screen, set the display resolution of the projector to "Full". See "Resolution" on Page E-43.
- * This function will not be available when a component signal is input to the RGB connector or DVI connector.

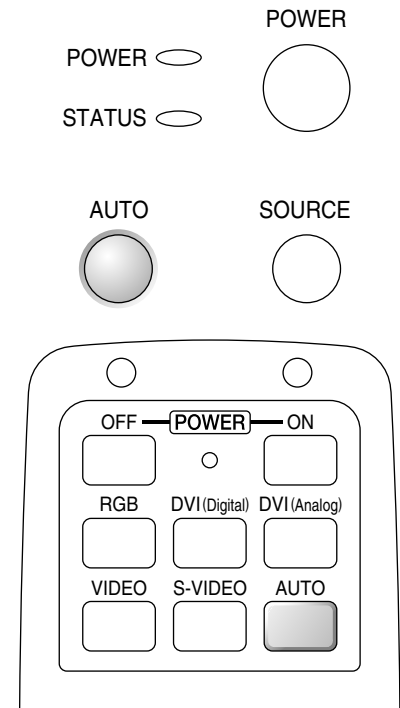

Viewing the Projector Operation Description

The method of menu operation and the projector adjustment/settings method is covered here.

- (1) Press the HELP button display the table of contents.
Displaying the various adjustment and setting screens will show the help contents of the selected item.
- (2) Move the cursor with the SELECT ▲▼ button and press the ENTER button to change to the page of the item that is at the cursor position.
Use the SELECT ◀▶ button to return or advance to pages that have been followed.
- (3) Press the R-CLICK/CANCEL button exit the help display.

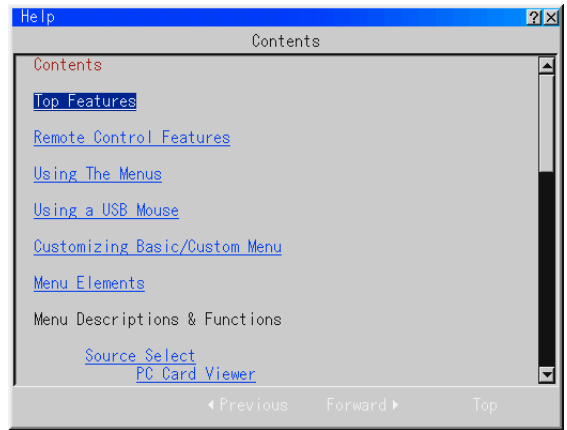

Note

Pressing the HELP button results in the mouse function button entering the projector mode.
See "Switching Between Projector Mode and Personal Computer Mode" on Page E-15.

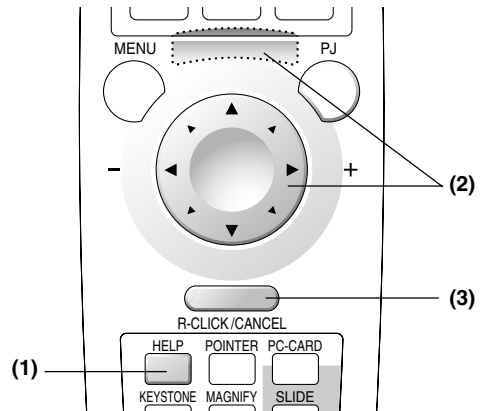

Using the Pointer

Use the pointer to indicate the place on the projected screen that you wish to describe.

- (1) Press the POINTER button to display the pointer.
- (2) Use the SELECT ▲▼◀▶ buttons to move the pointer to the desired position.

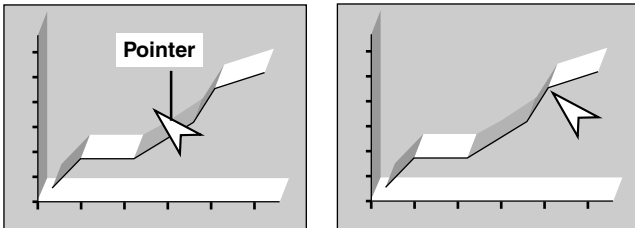

- (3) Press the POINTER button to delete the pointer.

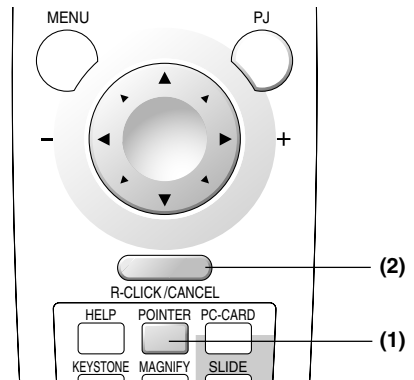

Note:

* Pressing the POINTER button results in the mouse function button entering the projector mode.
See "Switching Between Projector Mode and Personal Computer Mode" on Page E-15.
* The form of the pointer can be changed. See "Projector Pointer" on Page E-48.

General Operation

Enlarging the Image

The target portion can be enlarged and displayed at up to 4 times magnification as well as moved.

- (1) Press the POINTER button to display the pointer.
- (2) Use the SELECT \blacktriangle \blacktriangledown \blacktriangleleft \blacktriangleright buttons to move the pointer to the location that you wish to enlarge.

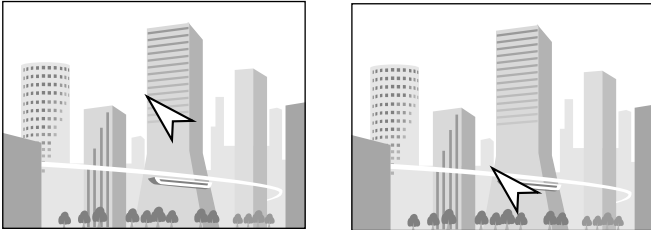

- (3) Press the MAGNIFY + button to enlarge the screen. The pointer will change to the magnify pointer.
 - * The SELECT \blacktriangle \blacktriangledown \blacktriangleleft \blacktriangleright buttons can be used to move the enlarged image. After the magnify pointer is moved to a corner of the screen, the image will move in that direction.

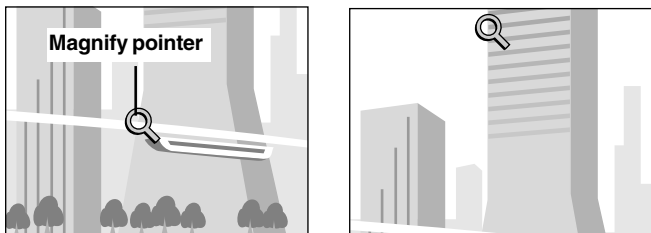

- (4) Press the MAGNIFY - button to reduce the size of the screen (to the original size).

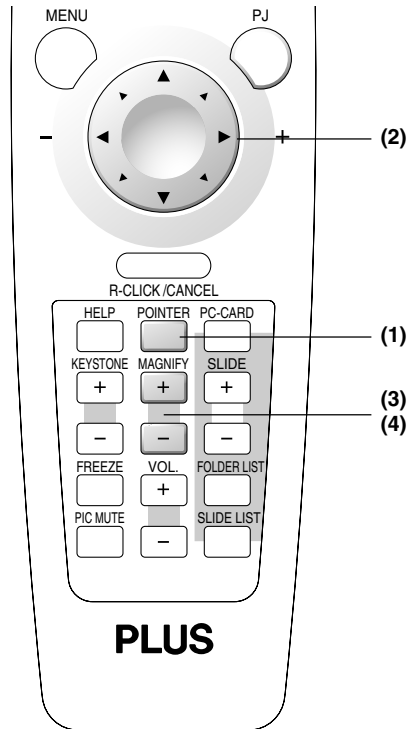

Note

Pressing the POINTER button results in the mouse function button entering the projector mode. See "Switching Between Projector Mode and Personal Computer Mode" on Page E-15.

Adjustment of the Volume

This is the volume adjustment of the projector's built-in speaker.

Pressing the VOL.+ button raises the volume and pressing the VOL.- button lowers the volume.

Note:

- * When the menu is not displayed, the SELECT \blacktriangle \blacktriangledown buttons of the projector can be used to control the volume.
- * The volume display will be closed when there has not been a button operation in 3 seconds. Also note that the volume adjustment display will not appear when the volume bar has been set to not display.
- * The audio of the equipment that is connected to the AUDIO connector will continue to be output even when the input selection is changed, but the volume adjustment value will be stored.

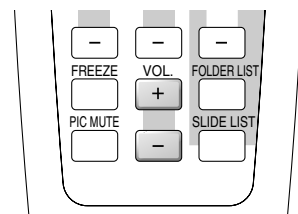

Volume Display



General Operation

Correcting Keystone Distortion of the Projection Screen

When the face of the projector and screen are not parallel (in the vertical orientation), keystone distortion will result. This keystone correction function is used to compensate for this.

Press the KEYSTONE +/- button and adjust so that the left and right sides of the image become parallel.

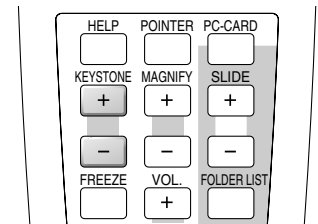
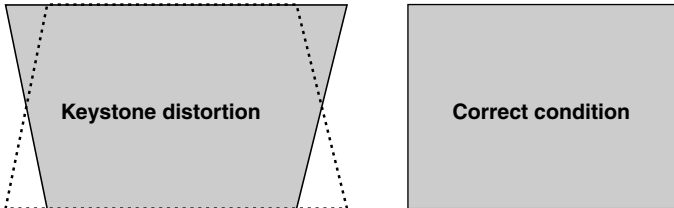

Keystone correction display



Note

- * The keystone distortion correction value can be saved. See "Keystone Save" on Page E-55.
- * Keystone correction can be performed over a range of +/- 30° with reference to the projection angle. Note that when displaying a signal of a resolution higher than the number of display pixels of the projector, the correctable range will be narrower.
- * In the absence of a button operation for 3 seconds, the keystone adjustment display will
- * The keystone correction display will be closed when there has not been a button operation in 3 seconds. Also note that the keystone correction display will not appear when the keystone bar has been set to not display.

Freezing a Moving Picture

This function is used to stop a moving picture such as a video image when you wish to view it carefully.

Press the FREEZE button to provide a still picture, then press it again to return to a moving picture.

Note

Pressing the FREEZE button projects the picture that is saved in the still picture memory so that the moving picture continues to advance without interruption.

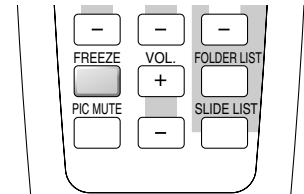

Cancelling Video and Audio

This function is used to temporarily mute the video and audio. (The menu display will not disappear.)

A press of the PIC MUTE button causes the picture and audio to disappear. Another press results in the return of the picture and audio.

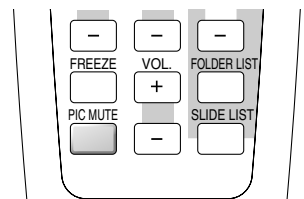

Menu Operation Method

This projector is equipped with two menu modes allowing you to select adjustment and setting items from menus for quick operation.

- Advanced menu: All menu items are displayed.
- Basic menu: Menu items you have registered are displayed.
To change the registered items, see “Basic/Custom Menu Edit” on page E-46.

Note:

- This section only describes the procedure for operating menus. Refer to this page if you forget how to perform the procedure while operating menus.
- For instructions on the menu functions and on the adjustments and settings, refer to the descriptions on the pages specific to the functions, adjustments and settings.
- To make adjustments and settings, select the desired input and project an image, then adjust to the optimum status.
- To restore the various items changed using the menus to their default values (the values set upon shipment from the factory), see “Factory Default” on page E-44. (Note that some items are not restored to their default values.)
- The adjustment and setting items differ according to which input is selected. Menu names that cannot be adjusted or set with the selected input signal are displayed in white characters.
- Menu display

If no operation is performed for 45 seconds (with the standard setting) while a menu is displayed, the display closes and the settings/adjustments remain unchanged. If the MENU, ENTER, CANCEL or SELECT ◀ or ▶ button is pressed, the menu reappears as it was before it closed. This reopen function is canceled if the input is switched or if the power is turned off.

The menu display automatically closes when the “Help” window is displayed.

Names and functions of remote control unit buttons used for menu operations

The buttons on the main unit operate in the same way.

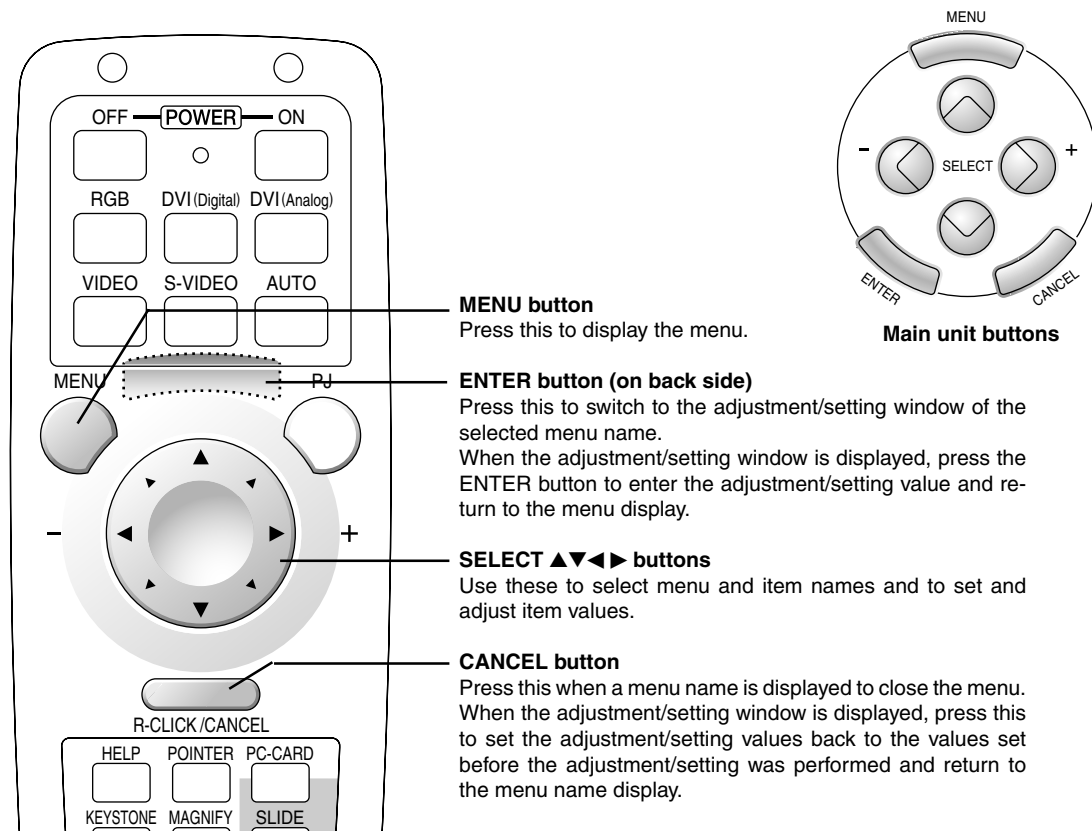

Operating Menus

Displaying menus

1 Press the MENU button to display the menu.



Note:
When an interlace signal movie is being projected, the screen may be disturbed when the menu is displayed.



Selecting menu names

2 Use the SELECT ▲▼ buttons to select the menu name.

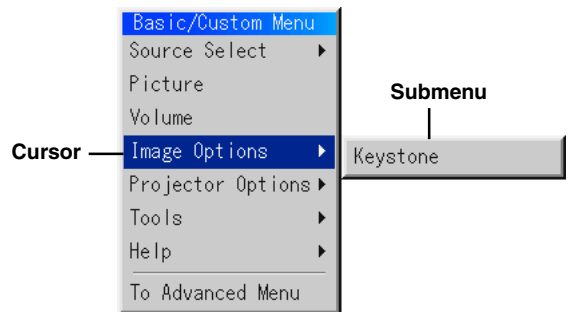
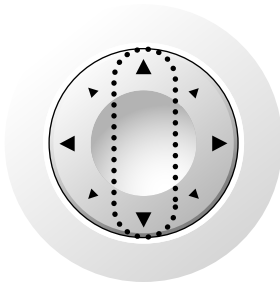

The [▶] mark at the right of menu names indicates that there is a submenu. The submenu appears when the cursor is set to that menu name.
When the cursor is set to menu names without the [▶] mark and the ENTER button is pressed, the adjustment/setting window appears.

3 Press the SELECT ▶ button to move the cursor to the submenu, then use the SELECT ▲▼ buttons to select the menu name.

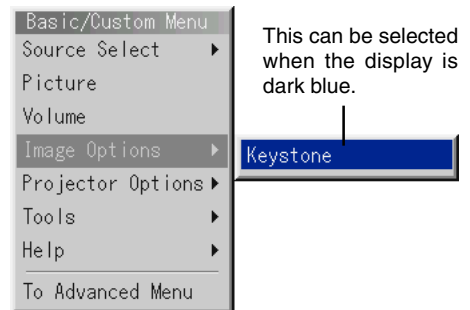
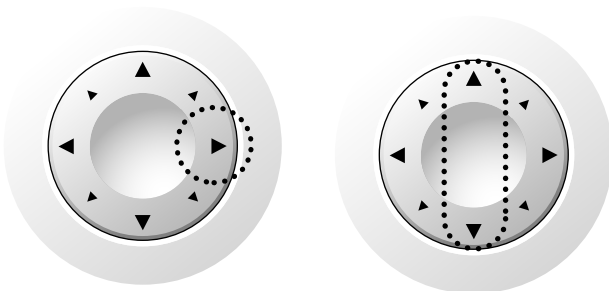

The [▶] mark at the right of menu names on submenus indicates that there is a second submenu.

Menu Operation Method

Entering menu names

- 4** Press the **ENTER** button to enter that menu name and switch to the adjustment/setting display.

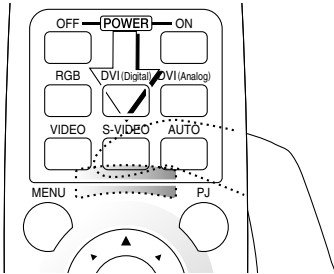

The same operation can be performed by pressing the **SELECT** ► button.

For instructions on making adjustments/settings, refer to the following page.

Ending

- 5** The menu display reappears once the setting/adjustment has been completed. The submenus and menus close one step at a time each time the **CANCEL** button is pressed.

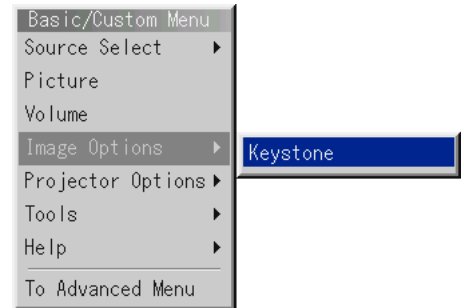

Note: To switch the basic menu temporarily to the advanced menu ...

Use the **SELECT** ▲▼ buttons to select "To Advanced Menu", then press the **ENTER** button.

The display switches temporarily to the advanced menu.

Press the **MENU** button again to return to the basic menu display.

To display the advanced menu permanently, see "Menu Mode" on page E-46.



Menu Operation Method

Making settings/adjustments

Selecting items

Use the SELECT ▲▼ buttons to select items.

When an item is selected, the cursor moves to the setting value.

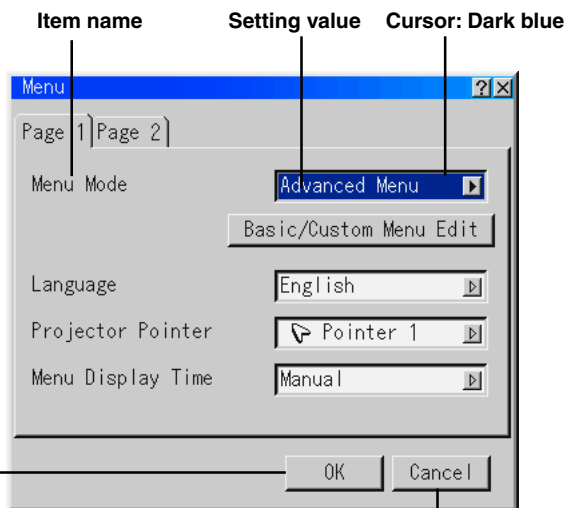
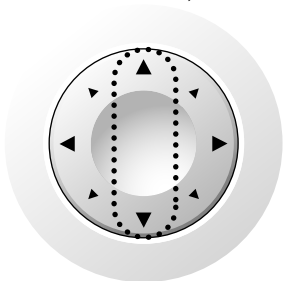

OK button

Use this to enter settings.

Set the cursor to "OK" and press the ENTER button to enter the setting value and return to the menu display.

Cancel button

Use this to cancel setting values.

Set the cursor to "Cancel" and press the ENTER button to cancel the setting value and return to the menu display.

The same operation can be performed by pressing the CANCEL operation button.

Page tabs

Page tabs are displayed when there are multiple pages of setting items.

Use the SELECT ▲▼ buttons to move the cursor to the row of page tabs.

Use the SELECT ◀▶ buttons to move the cursor to the desired page tab and switch to that page.

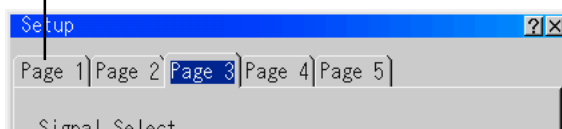

Adjustments

Use the SELECT ▲▼ buttons to select the desired item.

The selected item is darker than the other items.

Use the SELECT ◀▶ buttons to adjust.

When a value is adjusted, the adjustment bar changes to indicate the approximate adjustment value.

Press the SELECT ► button to display the adjustment bar.

For some items, part of the adjustment bar switches to green when the item is set to the standard adjustment value.

Adjustment bar



Menu Operation Method

Selecting items from pull-down lists

Use this procedure to select items from the pull-down list.

Press the SELECT ► button to display the pull-down list.

Use the SELECT ▲▼ buttons to select the desired setting, then press the ENTER button.

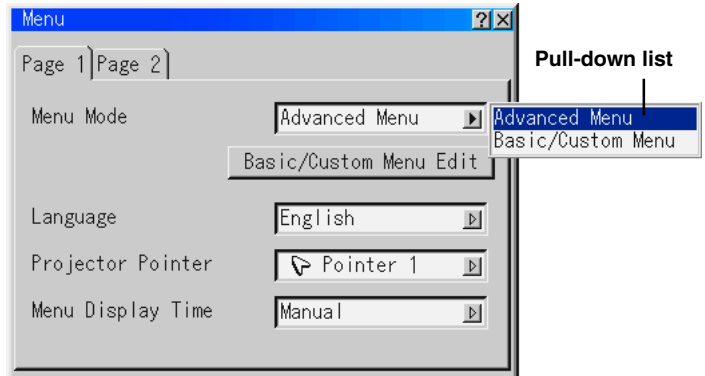

Selecting radio buttons

Radio buttons are used in cases in which only one setting can be selected at a time.

Use the SELECT ◀▶ buttons to move the cursor to the desired setting and put a dot in the radio button.

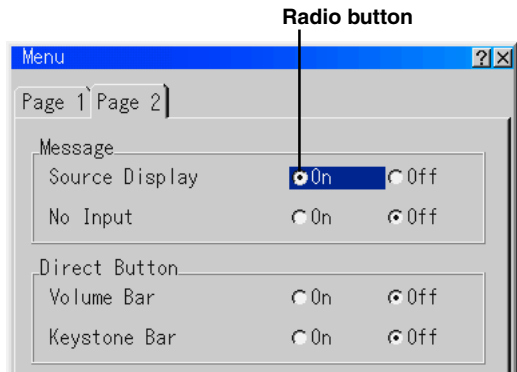

Check boxes

Check boxes are used for settings for which several settings can be selected at the same time.

Press the ENTER button at the box you want to set to check that box. (If the ENTER button is pressed at a box that is checked, the check turns off.)

Check box

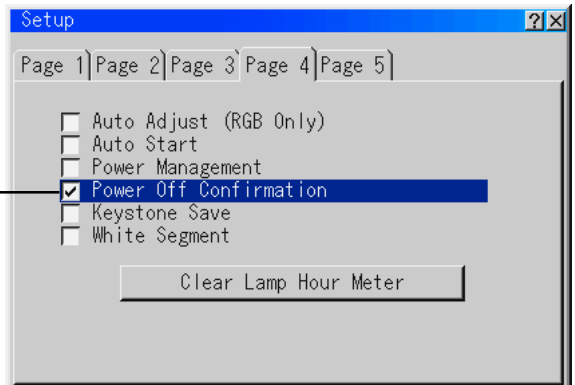

Setting buttons

When the ENTER button is pressed at setting buttons, a display containing further settings or confirmation messages appears.

The operation of the setting window differs according to the setting. At confirmation messages, use the SELECT ◀▶ buttons to select "OK" or "Cancel".

Setting button

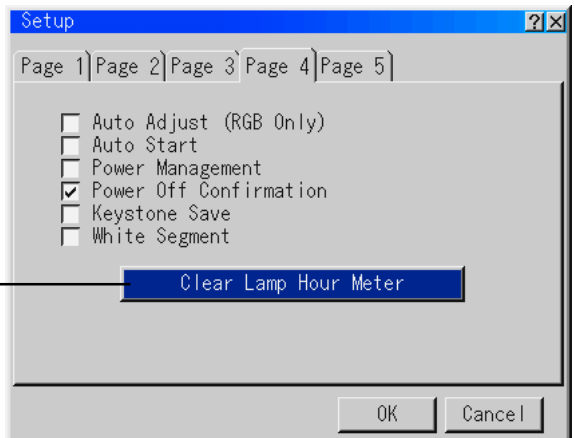

Menu Operation Method

Menu list

The following tables show the menu and item names displayed when the advanced menu is selected. If a menu and item name is displayed in white characters, that adjustment/setting cannot be performed with the currently selected input signal.

Menu Name		Item Name	Reference Page	
Source Select		RGB/DVI(DIGITAL)/DVI(ANALOG)/		
		Video/S-Video/ PC Card Viewer	E-40 E-65	
Picture		Brightness/Contrast/Color/Hue/ Sharpness	E-40	
Volume		Volume	E-40	
Image Options	Keystone		Keystone	E-41
	Lamp Mode		Lamp Mode	E-41
	Advanced Options	Aspect Ratio	Aspect Ratio	E-41
		Noise Reduction	Noise Reduction	E-42
		Position/Clock	Horizontale/Vertical/Clock/Phase	E-42
		Resolution	Resolution	E-43
		Video Filter	Video Filter	E-43
	Factory Default		Factory Default	E-44
Color Management	Gamma Collection		Gamma Collection	E-45
	Color Matrix	Select Color Matrix	E-45	
		Select Color Matrix Type	E-45	
	White Balance	Brightness R/Brightness G/Brightness B Contrast R/Contrast G/Contrast B	E-45	

Menu Name			Item Name	Reference Page	
Projector Options	Menu	Page 1	Menu Mode	E-46	
			Basic/Custom Menu Edit	E-46	
			Language	E-48	
			Pointer	E-48	
			Menu Display Time	E-48	
			Page 2	Message	Source Display
	No Input	E-49			
	Direct Button	Volume Bar		E-49	
		Keystone Bar		E-49	
	Setup	Page 1	Orientation	E-50	
			Cinema Position	E-50	
			Background	E-51	
			Mouse	Button	E-51
				Sensitivity	E-51
			Page 2	PC Card Viewer Option	Show Folder List
		Auto Play/Manual Play			E-52
		Interval			E-52
		Capture Options		E-52	

Menu Operation Method

Menu Name			Item Name	Reference Page	
Projector Options	Setup	Page 3	Signal Select	RGB	E-53
				DVI(ANALOG)	E-53
				Video	E-53
				S-Video	E-53
		Page 4	Auto Adjust (RGB only)	E-53	
			Auto Start	E-54	
			Power Management	E-54	
			Power Off Confirmation	E-54	
			Keystone Save	E-55	
			White Segment	E-55	
			Clear Lamp Hour Meter	E-55	
		Page 5	Communication Speed	E-56	
			Default Source Select	E-56	
Control Key Lock	E-56				
Tools	Capture		E-57		
	PC Card Files		E-58		
	Chalk Board		E-60		
Help	Contents		E-62		
	Information	Page 1	Source Name/Input Terminal/Horizontal Frequency/ Vertical Frequency/Sync Polarity	E-63	
		Page 2	Signal Type/Video Type/Sync Type/ Interrace/Resolution	E-63	
		Page 3	Aspect Ratio/Gamma Collection/Noise Reduction/ Color Matrix/Matrix Type	E-63	
		Page 4	Remaining Lamp Time/Lamp Hour Meter/Projector Usage	E-63	

Source Select/Picture/Volume

Source Select

Use the following procedure to select the viewer or signal being input to the projector.

The currently selected input signal is indicated by a check mark (✓).

- RGB Select this to project the analog RGB signal input to the RGB terminal.
- DVI (DIGITAL) Select this to project the digital signal input to the DVI terminal.
- DVI (ANALOG) Select this to project the analog signal input to the DVI terminal.
- Video Select this to project the video signal input to the VIDEO terminal.
- S-Video Select this to project the S-video signal input to the S-VIDEO terminal.
- PC Card Viewer Select this to display slides.
For instructions on using the viewer, see "Using the PC Card Viewer function" on page E-65.

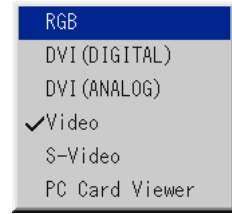

Note:

When automatic identification is not possible, the source setting must be made to project component signals connected to the RGB and DVI terminals.
See "Signal Select" on page E-53.

Picture

Use this to adjust the brightness, contrast, etc., to suit the lighting of the room in which the projector is being used.
These adjustments can be made separately for the different input terminals.

Items that cannot be adjusted with the currently selected input signal are displayed in white characters.

Use the SELECT ▲▼ buttons to select the item, then use the SELECT ◀▶ buttons to adjust the value.

Item Name	SELECT ◀ Button	SELECT ▶ Button
Brightness	Darker	Brighter
Contrast	Less contrast	More contrast
Color	Less dense color	Denser color
Tint	More red	More green
Sharpness	Softer image	Sharper image



Volume

Use this to adjust the volume of the projector's built-in speaker. This adjusts the volume of the audio input signals connected to the AUDIO terminal.

Press the SELECT ▶ button to increase the volume, the SELECT ◀ button to decrease the volume.

- The adjustment is stored separately for the individual sources.
- The sound of the device connected to the AUDIO terminal is produced even when the input is switched.



Image Options

Keystone

Use this to adjust for trapezoidal (keystone) distortion of the projected image.

Adjust using the SELECT ◀▶ buttons.

Note:

- The keystone adjustment value can be stored in the memory. See “Keystone Save” on page E-55.
- The keystone adjustment can be set within a range of $\pm 30^\circ$ with respect to the angle of projection. The adjustable range becomes narrower if a signal with a resolution greater than the projector’s native resolution (number of pixels displayed) is displayed.

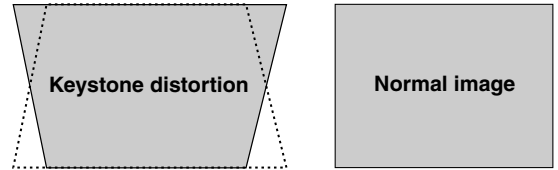

Lamp Mode

Use this if the picture is projected on a small screen and the picture is too bright or when projecting images in dark rooms.

Use the SELECT ◀▶ buttons to select the lamp mode.

Normal The lamp brightness is set to 100%.
The picture is bright.

Eco The lamp brightness is set to 80%.
Using this mode lengthens the lamp’s service life.



Note:

Frequent switching this mode can degrade the lamp.

Aspect Ratio

Use this to set the size of the projected picture.

Use the SELECT ◀▶ buttons to select the aspect ratio.

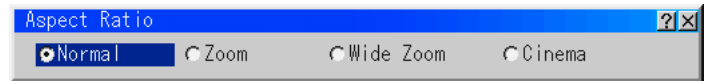

Normal Set this for the normal aspect ratio.
(4:3 input signals are projected in 4:3 screen size.)

Zoom Set this for a wider picture.
(When 16:9 letterbox signals are input, the picture is widened in the horizontal and vertical directions and projected in 4:3 size.)

Wide Zoom . Set this to widen the picture in the horizontal direction.
(When 16:9 squeeze signals are input, the picture is widened in the horizontal direction and projected in 4:3 size.)

Cinema Set this to narrow the picture in the vertical direction.
(When 16:9 squeeze signals are input, the picture is narrowed and projected in 16:9 size.)
The display position (right edge, center and left edge) can be changed using the “Cinema Position” setting. See “Cinema Position” on page E-50.

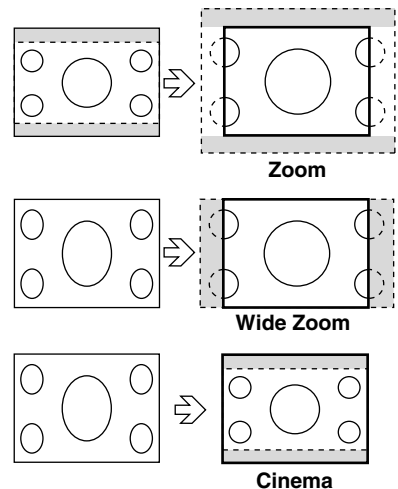

Image Options

Noise Reduction

Use this to reduce noise that causes roughness of the picture or muddiness of colors.

Use the SELECT ◀▶ buttons to select the noise reduction mode.

Off Noise reduction is turned off.

Low, Medium and High
..... Select the strength of the noise reduction of the brightness signal in one of three steps.

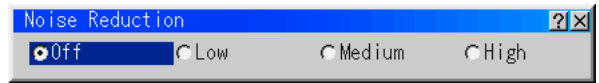

Position/Clock

Use this to adjust the picture's display position and the phase of analog RGB signals. Normally these settings are adjusted automatically when the source is selected. Adjust them if they have not been sufficiently adjusted with the automatic adjustment.

For RGB sources, if "Auto Adjust" is set, this is displayed in white characters and cannot be selected. Switch to the manual mode. See "Auto Adjust (RGB only)" on page E-53.

Use the SELECT ▲▼ buttons to select the item, then use the SELECT ◀▶ buttons to adjust.

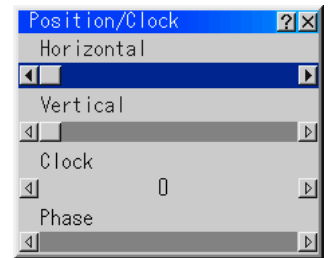

Horizontal

Use this to adjust when the image is off-centered to the left or right.

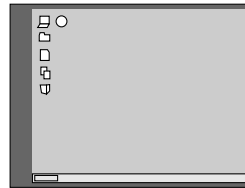

Vertical

Use this to adjust when the image is off-centered upwards or downwards.

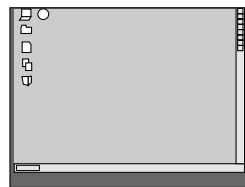

Clock

Adjust this if there are light and dark vertical stripes on the picture. Adjust so that the vertical strips disappear and the picture's brightness is uniform.

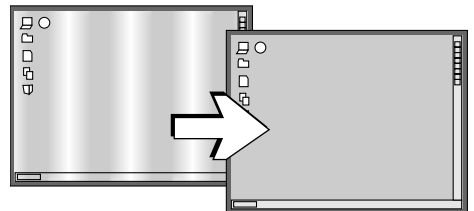

Phase

Adjust this if the picture's colors are out of phase or the picture is flickering. Adjust so that the colors appear normal and the picture stops flickering.

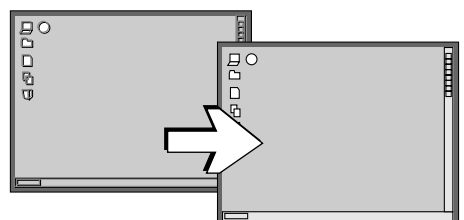
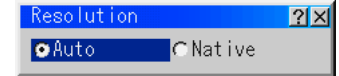

Image Options

Resolution

The projector's native resolution (number of pixels displayed) for RGB signals is 1024 x 768 dots. The size of characters or ruled lines may not be uniform when images with other resolutions are displayed. Use the Advanced AccuBlend function to correct for this. Turn the Advanced AccuBlend function on or off here.



When the source is set to RGB, if "Auto Adjust (RGB only)" is set, "Resolution" displayed in white characters and cannot be selected. Switch to the manual mode. See "Auto Adjust (RGB only)" on page E-53.

Use the SELECT ◀▶ buttons to select the resolution.

Auto Select this to turn the Advanced AccuBlend function on.
The projector automatically expands or reduces the images when they are projected.
This setting applies to all sources (not only the currently projected source).

Native Select this to turn the Advanced AccuBlend function off.
If the resolution of the currently projected source is lower than the projector's native resolution (number of pixels displayed), the projected image is reduced to its original size.

Note:

Signals with a resolution higher than the projector's native resolution (SXGA and UXGA signals) are displayed in the auto mode (1024 x 768 dots), even if the resolution is set to "Native".

Video Filter

Use this to reduce roughness of the picture or jitter of characters, etc.

By default this setting is set to the optimum values for the different sources. When the source is set to RGB, if "Auto Adjust (RGB only)" is set, "Video Filter" is displayed in white characters and cannot be selected. Switch to the manual mode. See "Auto Adjust (RGB only)" on page E-53.

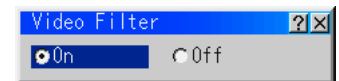

Use the SELECT ◀▶ buttons to select the setting.

On The filter is turned on.

Off The filter is turned off.

Factory Default

Use this to set all the adjustments and settings stored in the projector or the adjustments for the currently displayed source only back to the default values.

Use the SELECT ◀▶ buttons to select the desired mode.

The  icon is displayed while the values are being reset.

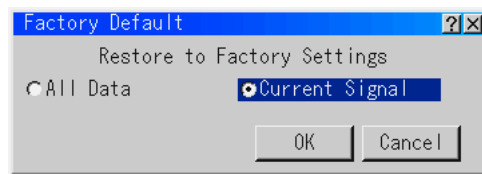

All Data Select this to set all the adjustment and setting values adjusted or set for all the sources back to their factory default values.

Data reset

All adjustment and setting values other than “Language”, “Communication Speed”, “Remaining Lamp Time”, “Lamp Hour Meter” and “Projector Usage”

(To reset the “Clear Lamp Hour Meter” setting, see page E-55.)

Current Signal

..... Select this to set the adjustment and setting values for the currently displayed source only back to the factory default values.

Data reset

“Brightness”, “Contrast”, “Color”, “Hue”, “Sharpness”, “Gamma Correction”, “Aspect Ratio”, “Noise Reduction”, “Color Matrix”, “White Balance”, “Horizontal”, “Vertical”, “Clock”, “Phase”, “Resolution” and “Video Filter”.

Color Management

Gamma Correction

Select the gradation of the black parts of the image. This makes even the darker parts of the picture look clearer.

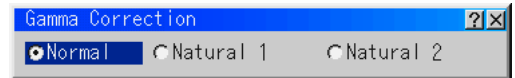

Select the gamma correction mode using the SELECT ◀▶ buttons.

Normal This is the standard setting.

Natural 1 Natural hues are stressed.
This setting is suited for watching TV programs and general image sources.

Natural 2 The dark parts of signals look clearer.
This setting is suited for watching movies.

Color Matrix

Use the SELECT ▲▼ buttons to select the item, then use the SELECT ◀▶ buttons to select the setting.

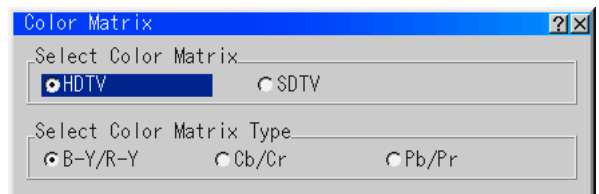

Select Color Matrix

Set the color matrix for high definition TV programs or digital programs. Select the input signal color matrix type.

HDTV High definition broadcast color matrix

SDTV Digital broadcast color matrix

Select Color Matrix Type

Select the format for separating video composite signals into RGB signals.

Set the input signal color matrix type.

B-Y/R-Y B-Y/R-Y matrix type

Cb/Cr Cb/Cr matrix type

Pb/Pr Pb/Pr matrix type

White Balance

This adjusts the signal's white and black levels to optimize color reproduction.

Use the SELECT ▲▼ buttons to select the item, then use the SELECT ◀▶ buttons to adjust.

Use "Brightness R", "Brightness G" and "Brightness B" to adjust the black of the picture.

Use "Contrast R", "Contrast G" and "Contrast B" to adjust the white of the picture.



Projector Options [Menu]

Menu Mode

Select the menu to be displayed.

Upon shipment from the factory, the menu mode is set to the basic menu on which basic menu items are registered. To change the items registered on the basic menu, follow the instructions at "Basic/Custom Menu Edit".

Select the menu mode from the menu mode pull-down list.

Advanced Menu

..... All the menus are displayed.

Basic/Custom Menu

..... The menus you have registered are displayed.

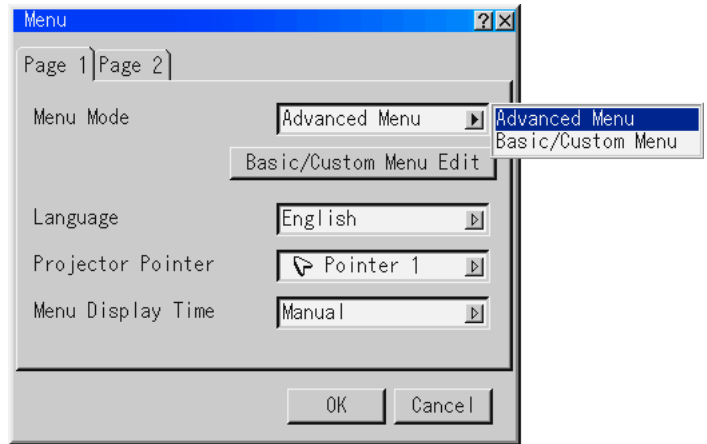

Basic/Custom Menu Edit

Register and delete menu items to be displayed on the basic menu.

- 1 Select "Basic/Custom Menu Edit", then press the ENTER button. The basic menu editing display opens.
- 2 Use the SELECT ▲▼ buttons to set the cursor to the menu item to be registered or deleted.
- 3 Press the ENTER button to select whether to register (checking the check box) or delete (unchecking the check box) the menu item.
 - Select other menu items in the same way.
 - When the cursor is moved to the very bottom of the display and the SELECT ▼ button is pressed, the display scrolls one line and the next menu item appears.
- 4 Once the menu items have been set as desired, use the SELECT ► button to select "OK", then press the ENTER button. The basic menu editing display closes and the menu setting window reappears.
 - Once "OK" is selected, operating the "Cancel" button (menu setting) is no longer possible. In this case, return to "Basic/Custom Menu Edit" and move the cursor to "Cancel", then press the ENTER button.
- 5 Once the menu settings are completed, set them using the "OK" button.

Resetting the registered items to the factory defaults

At "Basic/Custom Menu Edit", select "Reset", then press the ENTER button. The menu items are reset to the factory defaults.

Press the SELECT ▲ button, select "OK", then press the ENTER button.

The menu setting window reappears.

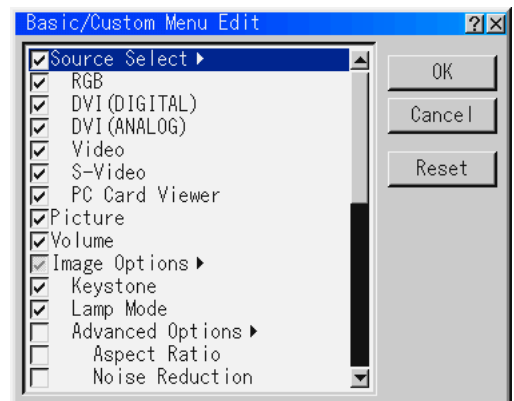
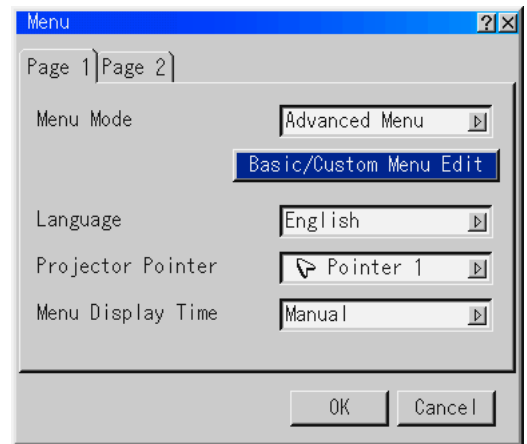

Projector Options [Menu]

Note:

When items containing the **[▶]** mark (Source Select, etc.) are registered, submenus are displayed. Entire submenus can be registered by selecting that item.

If more than one item on a submenu is set to be deleted, the checks next to item names with the **[▶]** mark are displayed in gray.

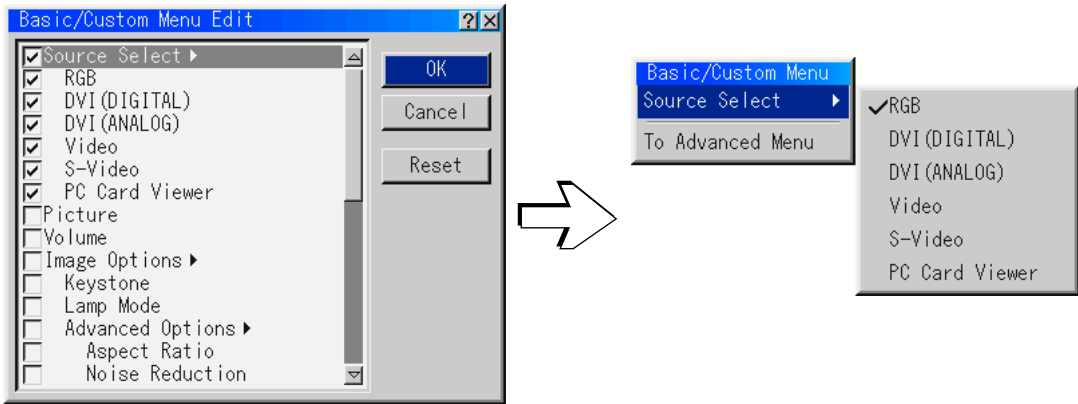

To set so that the submenu is not displayed, uncheck the item name containing the **[▶]** mark and check the items individually. Up to 12 items can be registered without displaying submenus. (The maximum number of items that can be registered is 12 even when the list contains both items for which submenus are displayed and items for which submenus are not displayed.)

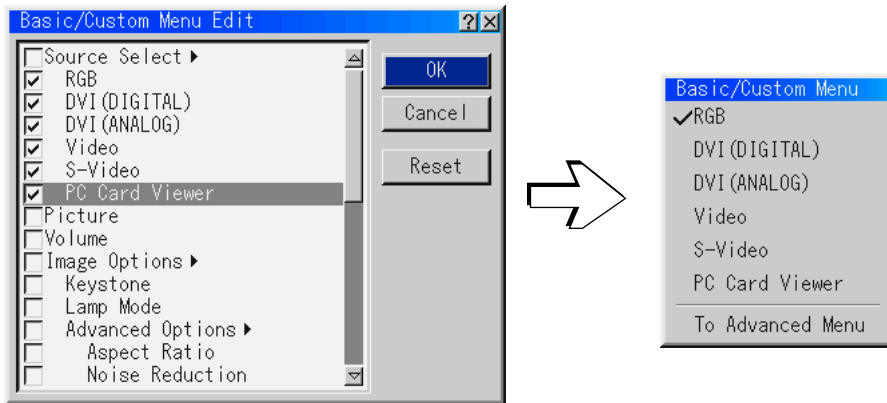

When the "OK" button on the basic menu editing window is selected while "Advanced Menu" is set, the "Change Basic/Custom menu now?" display appears.

When "Yes" is selected, all the currently opened windows close and the basic menu is displayed. When "No" is selected, the basic menu edit settings are stored and the menu mode remains set to the advanced menu.

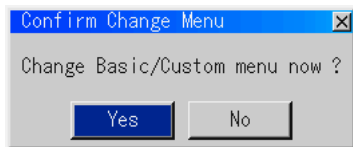

Basic menu items by factory default

The following items are checked:

Source Select (RGB, DVI (DIGITAL), DVI (ANALOG), Video, S-Video and PC Card Viewer)

Picture

Volume

Image Options (Keystone)

Projector Options (Menu and Setup)

Tools (Capture, PC Card Files, Chalkboard)

Help (Contents and Information)

Projector Options [Menu]

Language

Select the language in which menus and other on-screen displays are displayed.

Select the language from the “Language” pull-down list.

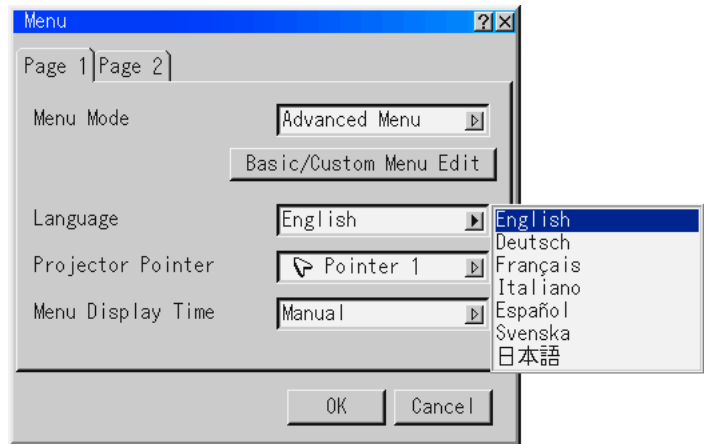

Projector Pointer

The pointer can be used to point to parts of projected images to explain them.
Set the pointer shape.

Select the type of pointer from the “Pointer” pull-down list.

Note:

It may not be possible to use the pointer function when displaying the pictures of TV games, etc. (15 kHz non-interlaced signals).

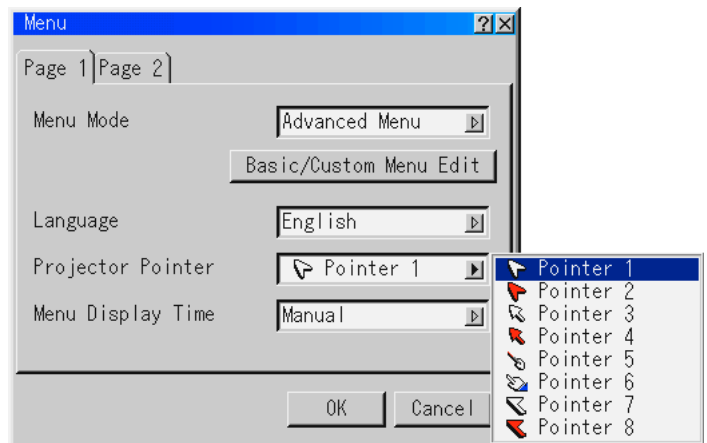

Menu Display Time

Select the time after which the menu displayed on the screen automatically disappears from the screen if no button is operated.

Select the menu display time from the “Menu Display Time” pull-down list.

Note: When set to automatic

- If the MENU, ENTER, CANCEL or SELECT ◀▶ button is pressed after the menu has automatically turned off, the menu reappears as it was before it turned off.
- If the input signal is changed after the menu has automatically turned off, the menu does not reappear as it was before it turned off. Operation is the same as with normal menu operation.

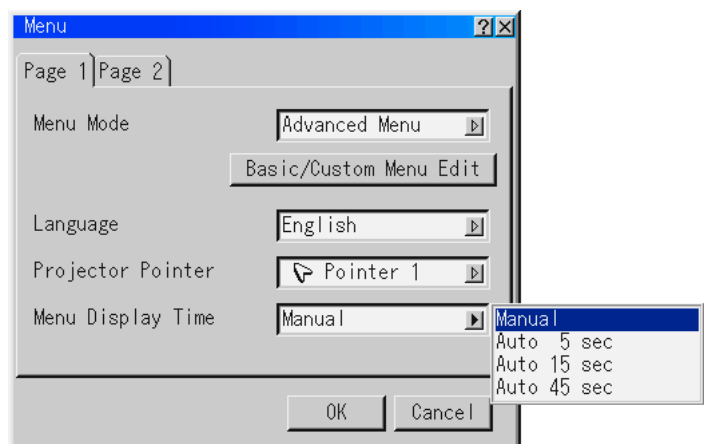

Projector Options [Menu]

Source Display

Set whether or not to display the input selection (source) when the input signal (source) is changed.

Select "On" or "Off" at "Source Display".

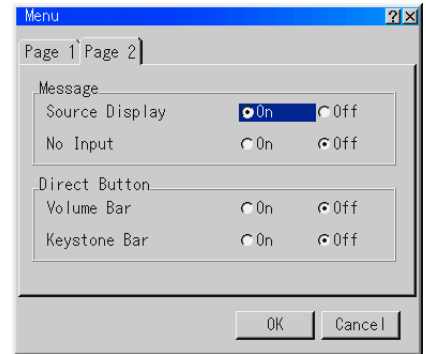

No Input

Set whether or not to display on the screen the fact that there is no input when no signal is being input.

Select "On" or "Off" at "No Input".

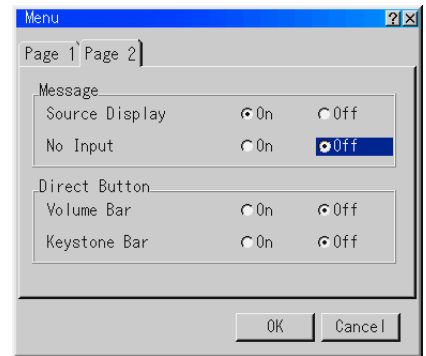

Volume Bar

Set whether or not to display the volume adjustment bar when the volume is adjusted with the VOL + and - buttons. The bar is only displayed when the volume is adjusted.

Select "On" or "Off" at "Volume Bar".

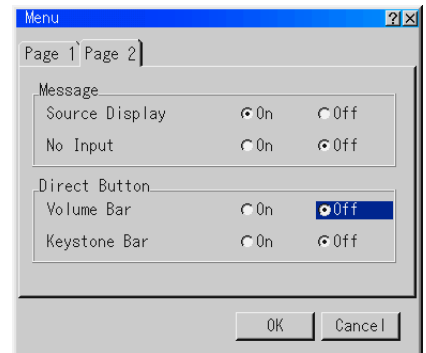

Keystone Bar

Set whether or not to display the keystone correction adjustment bar when keystone correction is adjusted with the KEYSTONE + and - buttons. The bar is only displayed when keystone correction is adjusted.

Select "On" or "Off" at "Keystone Bar".

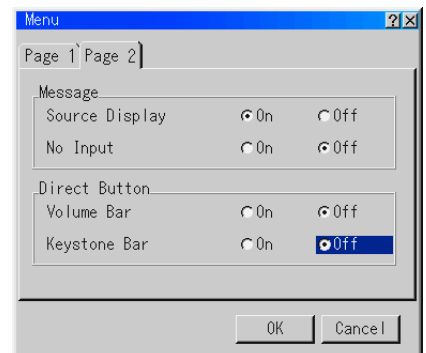

Projector Options [Setup]

Orientation

Select the method of projection onto the screen. Set this to project images from the front or back of the projector.

Select the mode from the “Orientation” pull-down list.

Desktop front Project from the front of the projector installed on a table.

Ceiling Rear Project from the rear of the projector installed on the ceiling.

Desktop Rear Project from the rear of the projector installed on a table.

Ceiling Front Project from the front of the projector installed on the ceiling.

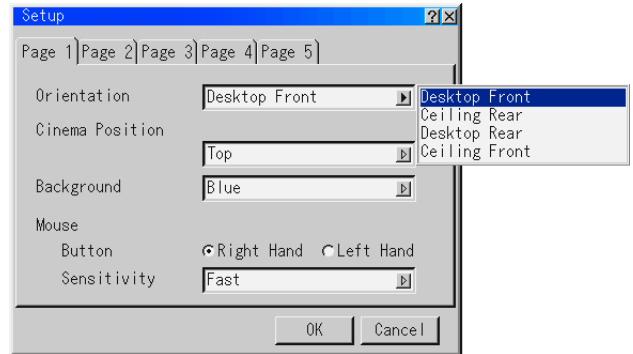

Cinema Position

Select the vertical position of the picture when the cinema mode is set for “Aspect”.

Select the mode from the “Cinema Position” pull-down list.

Top There is a black section at the bottom edge.

Center There is a black section at both the top and bottom edges.

Bottom There is a black section at the top edge.

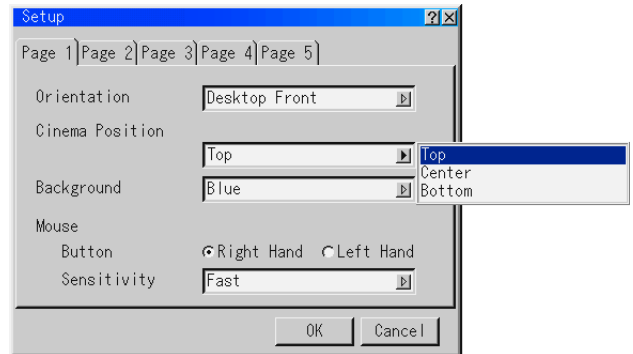

Background

Set the color of the background when there is no input signal.

Select the color from the “Background” pull-down list.

Blue The background is blue.

Black The background is black.

Logo An image is displayed on the background.

Note:

- No logo is registered upon shipment from the factory. When “Logo” is selected, the logo is displayed on a black background.
- Backgrounds you have created can be set at “Background”. See “Setting the background logo” on page E-59.

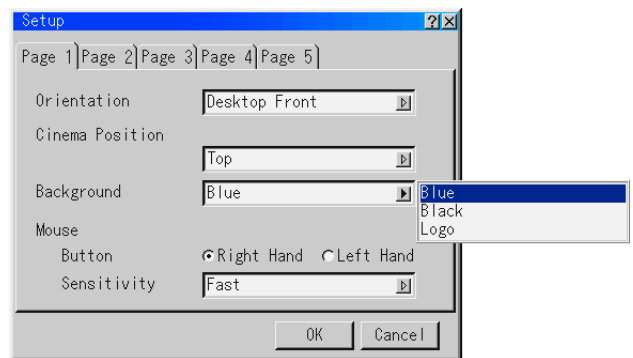

Projector Options [Setup]

Mouse

When a commercially available USB compatible mouse is connected to the projector, menu operations can be performed using the mouse. To do so, make these settings.

Button

Use this to switch the functions of the left and right mouse buttons.

Select the mode at "Button".

Right Hand . The mouse buttons are set to operate for right-handed users.

Left Hand The mouse buttons are set to operate for left-handed users.

Sensitivity

Select the speed of the pointer when the mouse is moved.

Select the mouse speed at "Sensitivity".

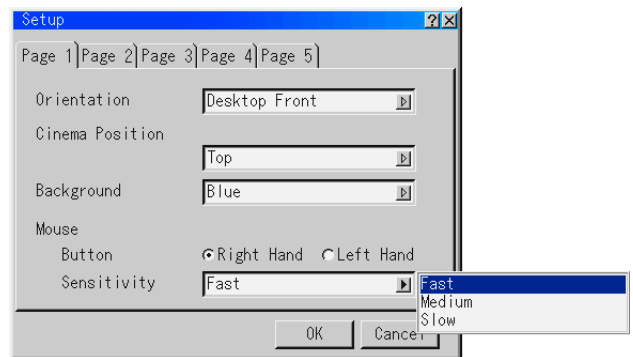
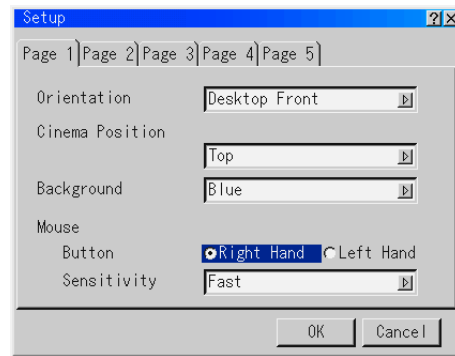

PC Card Viewer Options

Make the initial settings for viewer playback. For instructions on using the viewer, see page E-65.

Show Folder List

Set the start status set the start status when CompactFlash Card is inserted.

Set the status at "Show Folder List".

When checked The folder list is displayed.
When not checked The slide screen appears.

Auto Play/Manual Play

Set whether to play in the automatic mode when the viewer toolbar's play icon ► is pressed.

Select automatic playback or manual playback.

When automatic playback is selected, the slide switching time can be set.

Set the cursor to the display of the interval (in seconds) and use the SELECT ◀▶ buttons to set the interval time. The interval time can be set between 5 and 300 seconds in steps of 1 second.

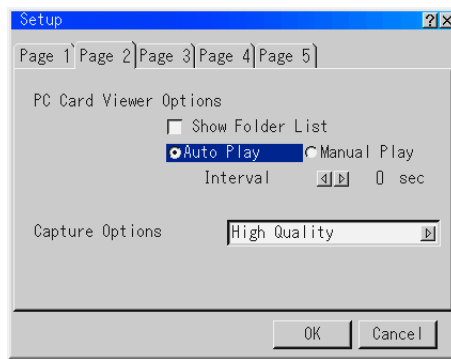
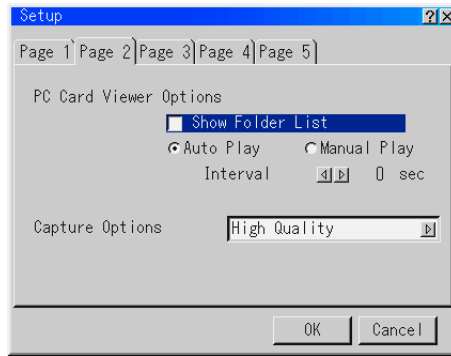

Capture Option

Set the data compression (reduction) rate when data is captured with the capture function.

Capture: Data is compressed in JPEG format. For instructions on using the capture function, see page E-57.

Select the compression rate at "Capture Option".

High Quality Picture quality is prioritized. Image data size is higher.

Normal Standard compression

High Compression Image quality decreases somewhat but data size is lower.

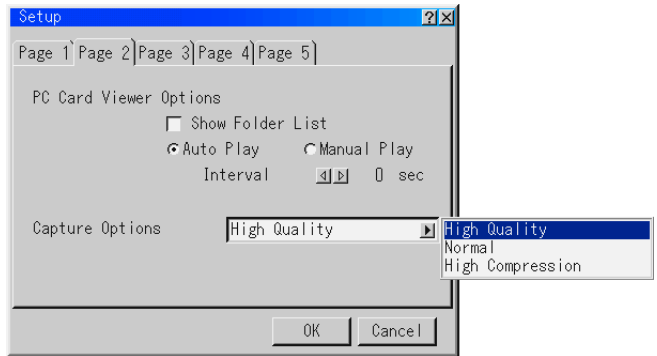

Projector Options [Setup]

Signal Select

This selects the signal mode of the RGB input, DVI (ANALOG) input, VIDEO input, and S-VIDEO input terminals.

Normally select "Automatic identification".

If the signal cannot be identified automatically, set to the signal mode of the output device connected to the projector.

RGB/DVI (Analog)

Set this when the component signal of a DVD player, etc., is connected to the projector's RGB terminal or DVI terminal with a special cable.

Select the mode from the "RGB" or "DVI (ANALOG)" pull-down list.

Video/S-Video

Set the composite signal format. Set to the signal mode in your country.

Select the format from the "Video" or "S-Video" pull-down list.

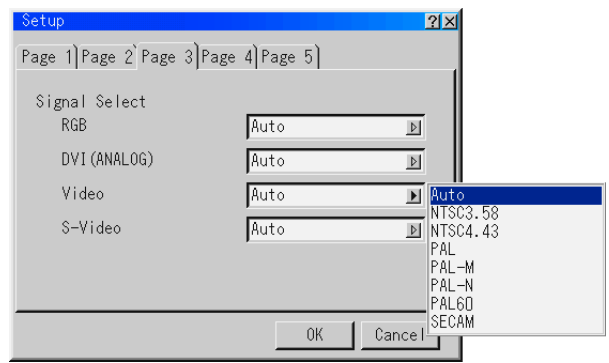
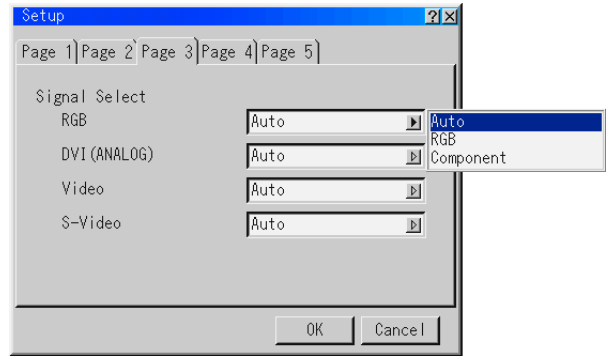

Auto Adjust (RGB only)

Set whether to adjust for offset of the RGB signal display position and pixels automatically or manually.

Press the ENTER button at "Auto Adjust (RGB only)" to set.

When checked Display position and pixel adjustment is performed automatically.

When not checked Display position and pixel adjustment can be performed manually. See "Position/Clock" on page E-42.

Note:

Depending on the image, it may not be possible to adjust properly or some time may be required for the adjustment to be completed when the signal is switched. In this case adjust manually.

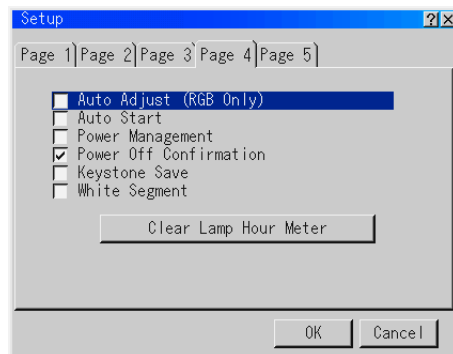

Projector Options [Setup]

Auto Start

The projector starts up automatically when the power is supplied to the power plug.

Use this to control the projector using a control console, etc.

Press the ENTER button at “Auto Start” to set.

When checked The auto start function is activated and the projector starts up.

When not checked The standby mode is set.

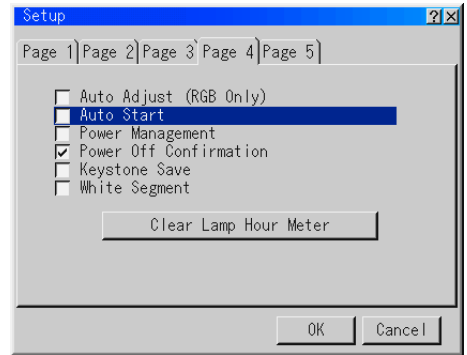

Power Management

The power automatically turns off and the standby mode is set when there has been no RGB or DVI signal input in 5 minutes.

Press the ENTER button at “Power Management” to set.

When checked The standby mode is set automatically.

When not checked The power management function is not activated.

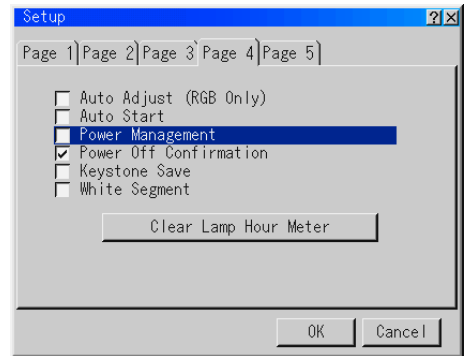

Power Off Confirmation

A confirmation message appears when the power is turned off.

Press the ENTER button at “Power Off Confirmation” to set.

When checked The confirmation message is displayed.

When not checked The confirmation message is not displayed.

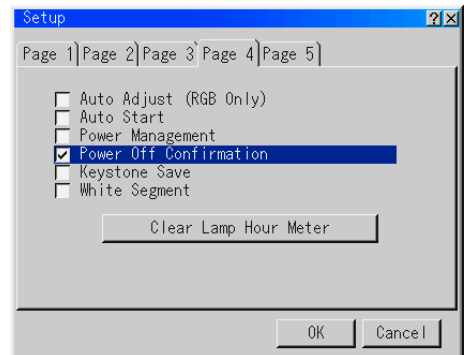

When the setting is validated (when the check box is checked)

A confirmation message appears when the power is turned off. Select [YES] and then press the ENTER button to turn the power off.

The confirmation message closes and the standby mode is set.

If “Cancel” is selected and the ENTER button is pressed, the operation to turn the power off is canceled.

Projected picture

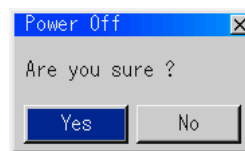

Projector Options [Setup]

Keystone Save

The adjustment value adjusted at “Keystone” is saved. The data is not lost even when the power is turned off.

Press the ENTER button at “Keystone Save” to set.

When checked The adjustment value is saved.

When not checked The adjustment value is not saved.

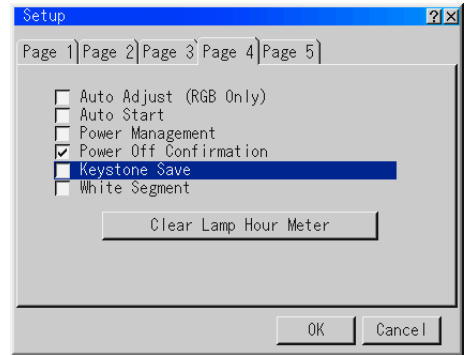

White Segment

Select whether to stress brightness or colors.

Press the ENTER button at “White Segment” to set.

When checked The picture gets brighter.

When not checked The picture has natural colors.

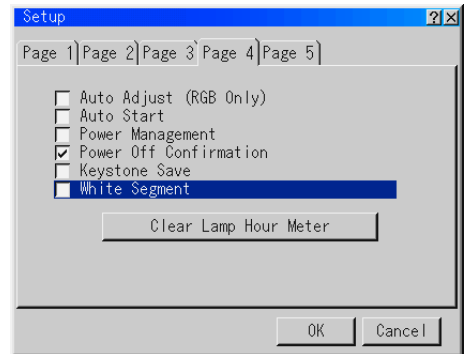

Clear Lamp Hour Meter

Use this to clear the “Remaining Lamp Time” and “Lamp Hour Meter” settings after replacing the lamp.

Press the ENTER button at “Clear Lamp Hour Meter”. A confirmation message appears.

Select “OK” and press the ENTER button to clear.

Note:

- When “OK” is selected and the ENTER button is pressed, operating the “Cancel” button (at setup) is no longer possible.
- The “Remaining Lamp Time” and “Lamp Hour Meter” settings are not cleared with the “Factory Default” command at “Image Options”.

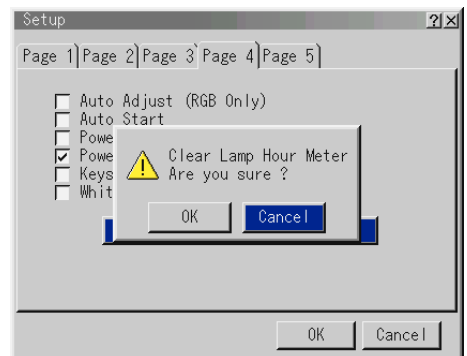
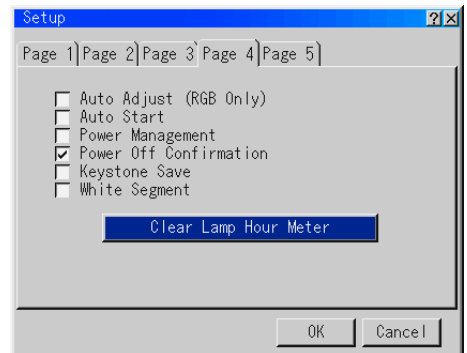

Projector Options [Setup]

Communication Speed

Set the PC CONTROL data communication speed. Set according to the communication speed of the connected device.

Select the speed from the “Communication Speed” pull-down list.

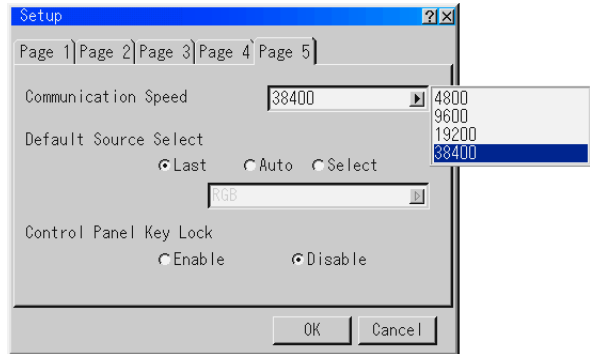

Default Source Select

Set which input signal (input terminal) to set when the projector is started up.

Select the source from “Default Source Select”.

Last The input signal last projected is projected.

Auto The input signals are automatically detected and the first input signal found is projected.

Select The selected input signal is projected.

When “Select” is selected, the input signal can be selected. Select the input signal from the “Select Items” pull-down list.

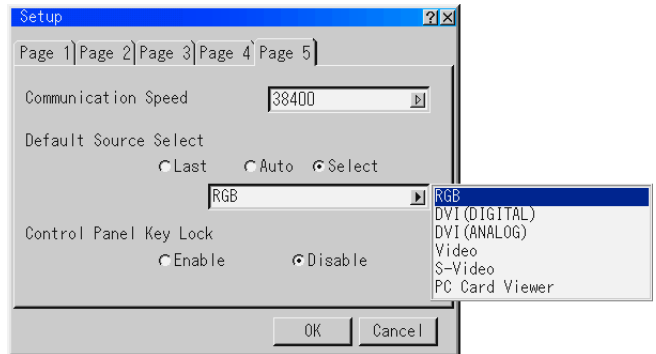

Control Panel Key Lock

Use this to lock the operating buttons on the projector so that they cannot be operated.

Set this at “Control Panel Key Lock”.

Enable The buttons on the projector’s control panel do not function.

Disable The buttons on the projector’s control panel function.

Note:

When the projector’s buttons are locked, they can be unlocked by pressing the CANCEL button on the projector for 10 seconds.

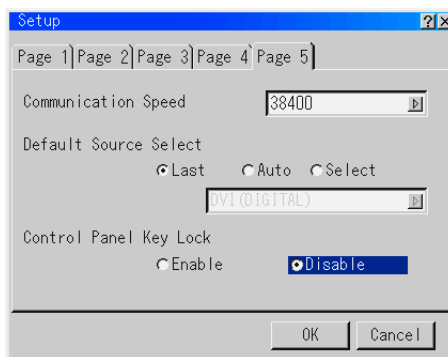

Tools

With this projector, you can save the image being projected (capture function) and display documents created on a computer (PC card file function). You can also draw on the projector's image (chalkboard function). A USB mouse is required to use the chalkboard function.

Capture function

Use this function to store images being projected in the capture folder of a CompactFlash card.

When "Capture" is selected, the capture toolbar is displayed in the bottom left corner of the projected image.

The capture function cannot be selected if no CompactFlash card is loaded. ("Capture" is displayed in white characters.)

Use the SELECT ◀▶ buttons to move the cursor (blue frame), then press the ENTER button.

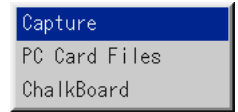

Capture toolbar

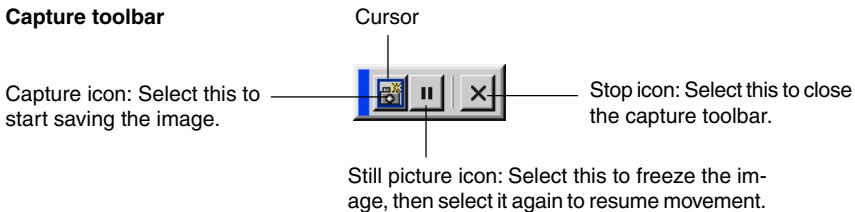

Capturing images

1. Load a CompactFlash card in the PC card slot.
2. Project the image you want to capture on the projector.
3. Display the capture toolbar.
4. Start capturing.

- The "📷" icon is displayed at the center of the picture during capturing. (Normally 5 to 10 seconds are required. More time may be required, depending on the image and its resolution.)
- "Card error" is displayed if the image could not be captured or if there was not enough empty space on the CompactFlash card.
- For greater convenience when capturing video or movie images, use the still picture icon [⏸] to freeze the image at the point from which you want to start capturing.
- To view or delete captured images with the viewer, see "Viewing Digital Images" on page E-70.

Note:

- Captured images with resolutions exceeding the projector's native resolution (number of pixels displayed) will not be displayed properly.
- The chalkboard toolbar cannot be displayed while the capture toolbar is displayed. (The chalkboard toolbar is not displayed even if "Chalkboard" is selected.)
- Captured images are stored in JPEG format and given file names automatically.
- The size of captured image files depends on the resolution of the input signal.
- When captured image files are displayed using the viewer function, the image size may differ according to the signal.
- The image data is compressed in JPEG format, so the picture quality decreases somewhat.

Notice

Do not remove the CompactFlash card or turn off the projector's power during capturing (while the 📷 icon is displayed). Doing so may damage the CompactFlash card.

Copyrights

According to copyright laws, copyrighted images, photographs, illustrations, etc., captured using the capture function or captured then processed and edited should not be used without the permission of the copyright holder except for personal enjoyment.

PC card file function

Use the PC card file function to project documents you have created using your own software rather than slides edited and stored using the viewer software.

Select "PC Card Files" to display the file selection window.

- The PC card file function cannot be selected if no CompactFlash card is loaded. ("PC Card Files" is displayed in white characters.)
- The file formats that can be used with the PC card file function are as follows:
 - .txt Text files
 - .idx Index files
 - .htm HTML files
 - .jpg Image files in JPEG format
 - .bmp Image files in bitmap format



Files of other formats can be displayed on the file list when "All" is selected, but they cannot be opened.

Note:

The "PC Card Files" window may not be displayed properly when signals of XGA or greater (with a resolution of 1024 x 768 dots or greater) are being projected.

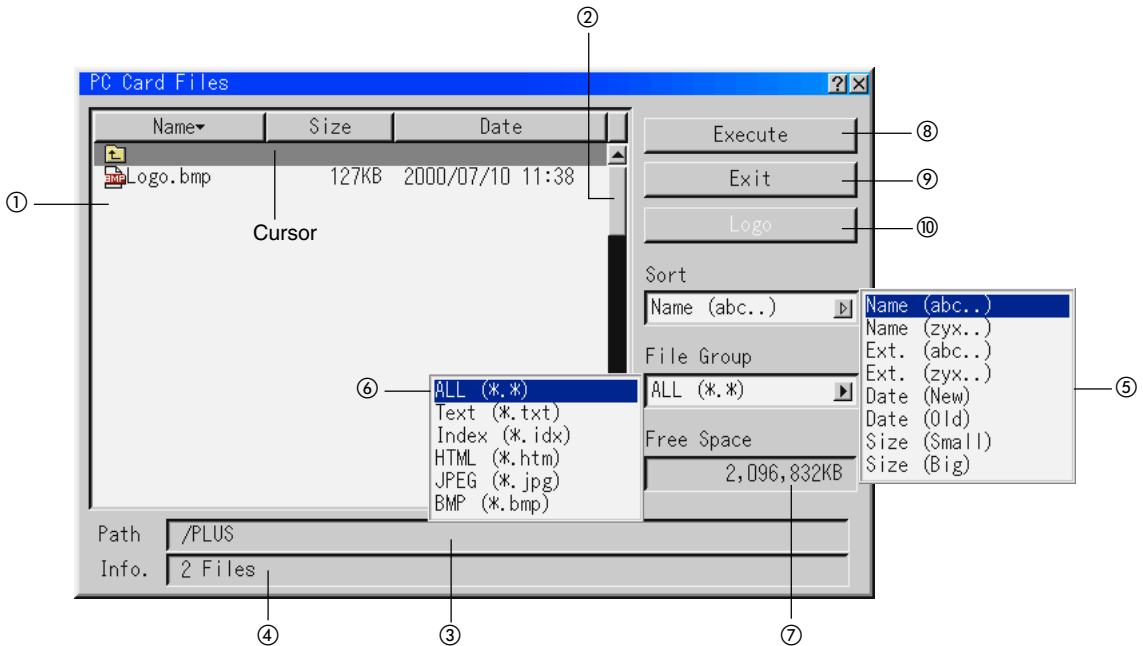

Functions of parts

- ① File list: A list of the files stored on the CompactFlash card is displayed here.
- ② Scroll bar: The list scrolls one line at a time when the SELECT ▲▼ button is pressed while the cursor is at the top or bottom of the list. (The scroll bar is displayed when there are more files on the file list than can be displayed in the file list area.)
- ③ Path: The path of the selected file is displayed here.
- ④ Info.: The total number of files on the file list is displayed here.
- ⑤ Sort: Use this to sort the files by file name, extension, date or size, in ascending or descending order. Press the SELECT ► button to display a pull-down list.
- ⑥ File Group: Files of the selected type ("All", ".txt", ".idx", ".htm", ".jpg" or ".bmp") are displayed on the file list. Press the SELECT ► button to display a pull-down list. When "All" is selected, even files that cannot be opened are displayed on the file list.

Tools

- ⑦ Free Space: The free space on the CompactFlash card is displayed here in units of kilobytes.
- ⑧ Execute: Select this to project the selected file.
When files of JPEG or bitmap format are executed, the input switches to the viewer input.
When the "Return" icon on the toolbar displayed in the bottom left corner of the picture is selected, the "PC Card Files" window reappears.

Selecting icons on the toolbar

Use the SELECT ◀▶ buttons to move the cursor (blue frame) to the desired icon, then press the ENTER button.

- ⑨ Exit: Select this to quit the PC card file mode and return to the menu display.
- ⑩ Logo: Select this to capture a logo (background) created on the computer.

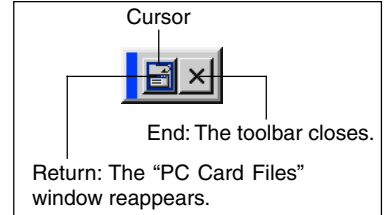

Using the PC card file function

1. Load a CompactFlash card into the PC card slot.
2. Display the "PC Card Files" window.
3. Use the SELECT ▲▼ buttons to select the file.
4. Use the SELECT ▶ button to move the cursor (blue frame) to "Execute", then press the ENTER button. The selected file is projected.
 - When files other than JPEG and bitmap files are selected, the window is displayed over the entire screen. Press the CANCEL button to return to the "PC Card Files" window.
 - When JPEG or bitmap files are selected, the input switches to the viewer input. When the "Return" icon on the toolbar displayed in the bottom left corner of the picture is selected, the "PC Card Files" window reappears.
 - To return to the file list, press the SELECT ◀ button. A pull-down list appears when the SELECT ▶ button is pressed. Select using the SELECT ▲▼ buttons then press the ENTER button to select.
5. Set the cursor to "Exit" then press the ENTER button to close the "PC Card Files" window.

Setting the background logo

You can create your own background which is displayed when there is no signal. Create the background on a computer and store it on a CompactFlash card.

Notice

- Create the background as an image file of JPG or bitmap format, with a file size of 64 kb or less.
- When the logo data is changed, the original data cannot be retrieved even by resetting the data.

Select the logo image you have created then set the cursor to "Logo" and press the ENTER button. A confirmation message appears. Select "OK" then press the ENTER button to change the logo.

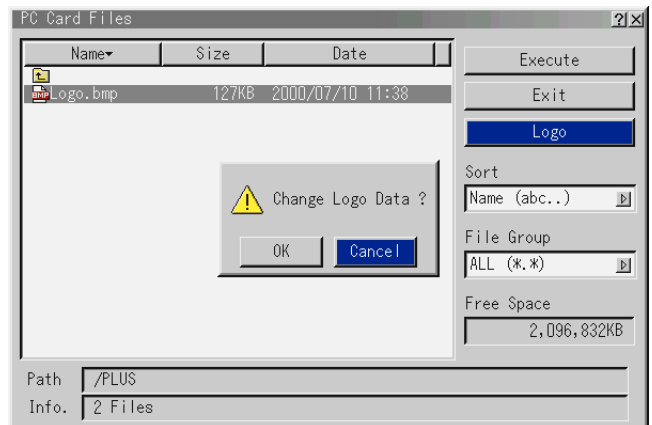

Chalkboard

This function allows you to draw freehand (free curves) using a commercially available USB mouse. It comes in handy during presentations.

(Not all USB mice can be used.)

Note:

- The chalkboard function cannot be selected if no USB mouse is connected. (“Chalkboard” is displayed in white characters.)
- The chalkboard function can be selected even when the viewer toolbar is displayed. It is not possible to capture the drawings made using the chalkboard function.
- The menu does not appear when the right mouse button is clicked while the chalkboard toolbar is displayed. To display the menu, quit the chalkboard mode first.
- The chalkboard mode is forcibly quit when the input is switched with the SOURCE button on the projector or the input selector buttons on the remote control unit or when the input signal is switched.
- When “Chalkboard” is selected while the capture toolbar is displayed, the capture function is quit.
- Letters or diagrams drawn using the chalkboard function cannot be captured and saved.
- Menu selection is not possible while the chalkboard toolbar is displayed or when it is minimized with the minimize icon.
- The chalkboard function can be used while using the viewer function, but the drawings are cleared when the slide is switched or other operations are performed.

Select “Chalkboard” to display the chalkboard toolbar.

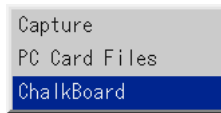

Selecting icons from the chalkboard toolbar

Set the USB mouse’s pointer to the desired icon and click the left mouse button to select that icon.

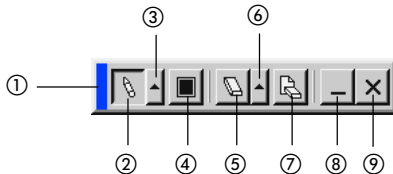

Functions of icons

- ① Move: Left-click and drag to move the displayed position.
- ② Pen: Left-click to set the drawing mode. Lines are drawn as the mouse is moved.
- ③ Pen line type selection: Left-click to display a list of the types of lines. Left-click on the desired line type to set that line type and close the list of line types.
- ④ Color: Use this to select the pen color. Left-click to display a list of colors. Left-click on the desired color to set that color and close the list of colors.
- ⑤ Eraser: Left-click to set the eraser. The lines are erased as the mouse is moved.
- ⑥ Eraser line type selection: Left-click to display a list of the types of lines. Left-click on the desired line type to set that line type and close the list of line types.
- ⑦ Clear: Left-click to clear the entire screen.
- ⑧ Minimize: Left-click to temporarily close the chalkboard toolbar. Right-click on the screen to redisplay the chalkboard toolbar.
- ⑨ Quit: Left-click to clear the entire screen and quit the chalkboard function.



Drawing

Preparations: Connect a USB mouse. After several seconds, the mouse cursor appears. See “Using a USB Mouse” on page E-64.

1. **Click the mouse to display the menu, then click “Chalkboard” to select the chalkboard function. The display switches to the chalkboard toolbar.**
2. **Select the pen type.**
3. **Select the pen color.**
4. **Use the mouse to draw.**

Left-click the pen icon. The icon hollows and the drawing mode is set.
Pressing the left mouse button, move the mouse to draw lines on the screen corresponding to the movement of the mouse.
To temporarily close the chalkboard toolbar, left-click the minimize icon. Right-click to reopen the chalkboard toolbar.

 - To partially clear lines, left-click the eraser icon then move the mouse over the lines you want to erase while pressing the left mouse button.
 - To clear the entire screen, left-click the clear icon. The entire screen is cleared.
5. **Left-click the quit icon to clear the entire screen and quit the chalkboard function.**

Help

Contents

The help file includes instructions on operating the projector.
Select "Contents" to display the contents.

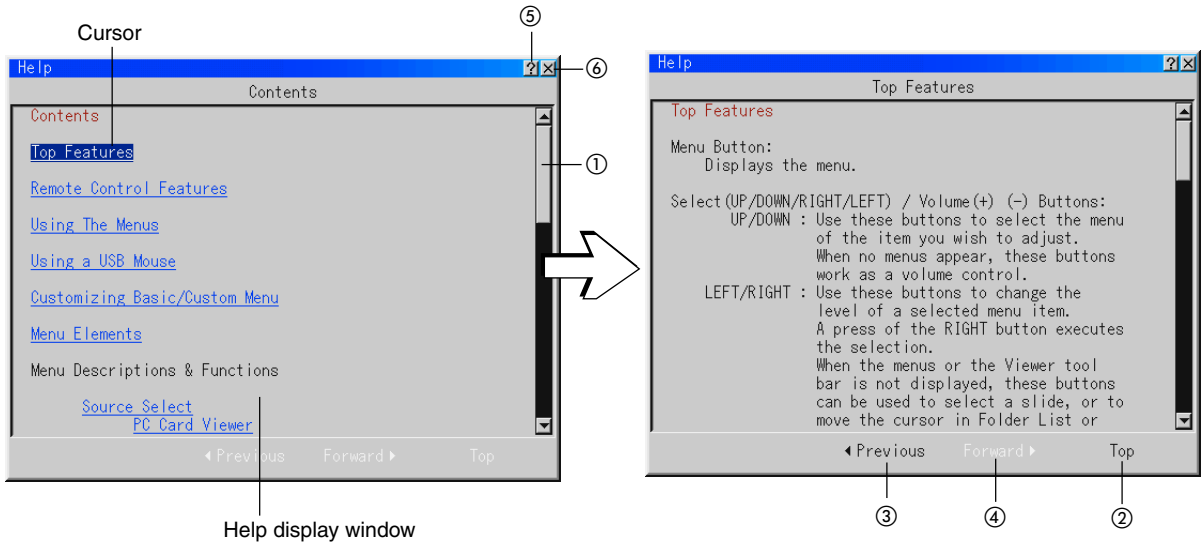

Operation

Use the SELECT ▲▼ buttons to move the cursor to a related item.

When the cursor is moved to an underlined word or character and the ENTER button is pressed, for blue characters the screen switches to the page of a related item and for green characters the screen switches to an adjustment display.

Scrolling

If there is no related item on the screen, use the SELECT ▲▼ buttons to scroll to the next screen containing a related item.

Returning and advancing

Use this function to return or advance to pages you have already opened. (This is not a function for moving ahead or behind one page at a time.)

Press the SELECT ◀ button to return to the previously displayed page. Press the SELECT ▶ button to advance to the page displayed before returning to the previously displayed page.

Quitting

Press the CANCEL button.

With a USB mouse, click ▲ ① to scroll up, ▼ to scroll down. Click "Contents" ② to return to the contents page. Click "Previous" ③ or "Forward" ④ to return or advance to previously displayed pages. Click ⑤ to move to the help instructions page. Click ⑥ to close the help window.

Information

Use this function to display details about the currently selected input signal or the lamp usage time. Select "Information" to display the information window. Use the SELECT ► button to select the page.

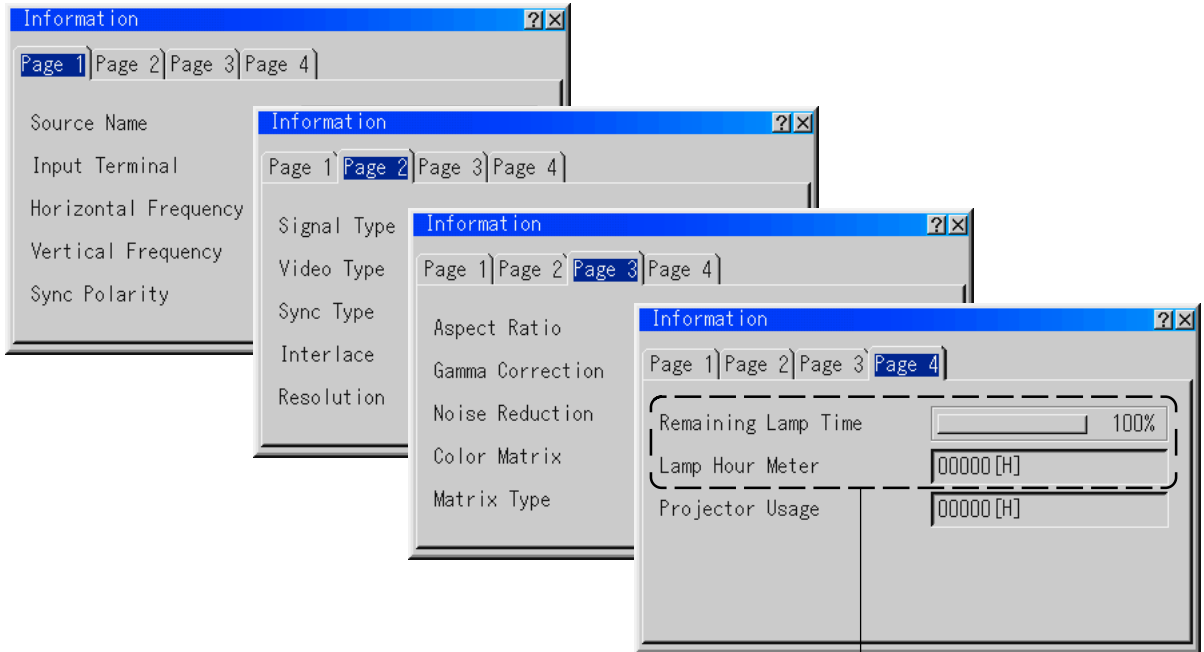

“Remaining Lamp Time” and “Lamp Hour Meter” displays

This projector is equipped with an economy mode. The lamp service life differs in the normal and economy modes. The total time the lamp has been used is displayed at “Lamp Hour Meter”. The percentage of time remaining with respect to the time the lamp has been used is displayed at “Remaining Lamp Time”.

- When “Remaining Lamp Time” reaches 0%, the message “It is time to replace the lamp. Replace the lamp as soon as possible, following the instructions in the manual.” appears. (The message remains displayed as long as an image is projected.) Replace the lamp with a new one. For instructions on replacing the lamp, see “Replacing the Lamp Cartridge” on page E-75.
- Once the end of the lamp’s service life is reached (when “Remaining Lamp Time” reaches 0%), the “Remaining Lamp Time” display switches to a red time display. If the lamp is used another 100 hours, the power will no longer turn on, regardless of the lamp mode setting.

	Lamp Hour Meter		Remaining lamp time
	When only the normal mode is used (minimum)	When only the economy mode is used (maximum)	
Upon shipment from factory	0000 hours	0000 hours	100%
Lamp service life	1000 hours	1500 hours	0%

Using a USB Mouse

When a USB mouse is connected to the projector's USB terminal, it can be used to operate the menus and to use the chalkboard function.

For instructions on using the chalkboard function, see "Chalkboard" on page E-60.

Connecting the USB Mouse

Connect the mouse's USB terminal to the projector's USB MOUSE terminal.

Notice

Do not connect any USB devices other than a mouse to the USB MOUSE terminal.

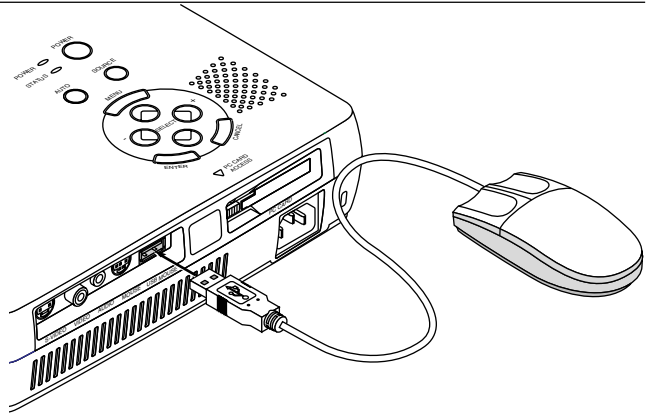

Operating menus using the USB mouse

Display of the mouse cursor

The mouse cursor appears when the USB mouse is connected.

The mouse cursor turns off if no mouse operation is performed for a specific length of time (about 7 seconds).

The mouse cursor reappears automatically when the mouse is operated.

Display of menus

The menu appears at the position of the mouse cursor when the mouse is clicked on the screen.

When the mouse cursor is set to a menu item with the [▶] mark, the submenu appears.

To close the menu, click at any position on the screen other than on the menu.

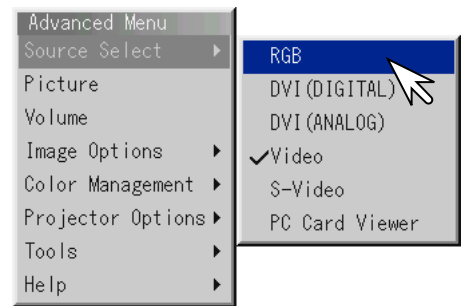

Operation for displaying adjustment and setting displays

Select a menu item and click to display the adjustment or setting display.

Examples of operation

At menu displays, click "◀" or "▶" (or hold in the mouse button) to adjust. Adjusting is also possible by clicking the adjustment bar, holding in the button and dragging (moving) to the left or right.

To close, click "X". The menu display reappears.

If any position on the screen is clicked while an adjustment or setting display is displayed, the menu appears at the position of the cursor. Multiple adjustment or setting displays can be displayed.

When "?" is clicked, the help display for that item appears. For instructions on using the help function, see page E-62.



Note:

- The positions of the menu and the adjustment and setting displays can be moved by left-clicking on the title bar (or the blue section at the left edge of toolbars) and dragging.
- Not all USB mice can be used.

Using the PC Card Viewer function

Using the PC Card Viewer function

Note:

When using the supplied software (CD-ROM) the software is designed to use with a personal computer only. Do not play the software on CD player. Doing so could cause damage to speakers.

Features

The Viewer feature allows slides stored on a CompactFlash memory card (referred to as CompactFlash card in this manual) to be displayed on the projector. Even if no computer is available, presentations can be conducted simply with the projector. This feature is convenient for holding presentations at meetings and in offices, as well as for playing images taken on digital cameras.

Easy to use

- Presentations can be started immediately simply by inserting a CompactFlash card (not supplied)
- Easy slide switching
- Remote control operation
- Jumping to list of slides or any specific slide

High quality images

- High resolution up to 1024 × 768 dots
- 24-bit full color playback
- Viewing of digital camera images

Simple utility software (for computer)

- PC Card Viewer Utility operable on Windows 95/98 / Me / NT4.0 (SP3 or later)/2000
- Slides can be created by capturing the currently displayed image
- Control screen for displaying lists of slides and editing
- PC Card Viewer PPT Converter 1.0 [Add-In Version] converts files created with Microsoft PowerPoint 95/97/2000 (hereafter referred to as PowerPoint) into indexes playable with PC Card Viewer

* Microsoft, Windows and PowerPoint are registered trademarks of Microsoft Corporation.

Inserting and Ejecting a CompactFlash Card

A CompactFlash card is used to view presentation data prepared on the computer and to capture and play images projected with the projector.

Inserting the CompactFlash Card

- Hold the CompactFlash card horizontally and insert it slowly into card slot with its top facing up.
- The eject button pops out once the CompactFlash card is fully inserted. Check that the CompactFlash card is fully inserted.

Note: Do not try to force the CompactFlash card into the slot.

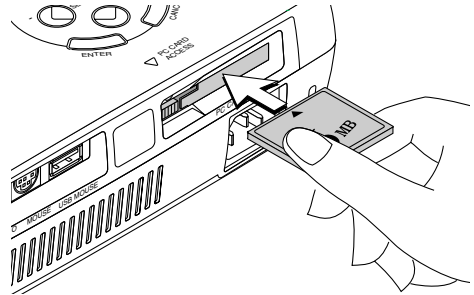

Ejecting the CompactFlash Card

Press the eject button. The CompactFlash card pops out a little. Grasp the edges of the CompactFlash card and pull it out. Do not eject the CompactFlash card while its data is being accessed.

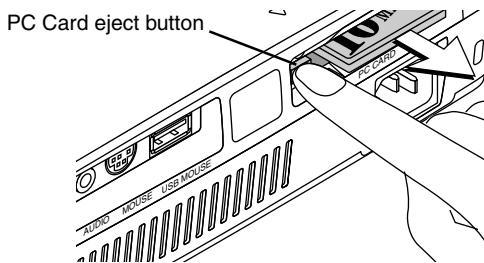

Insert the CompactFlash card on a PC card adapter when using on your PC.

- Set the CompactFlash card in the direction shown in the diagram and insert it into the card adapter.

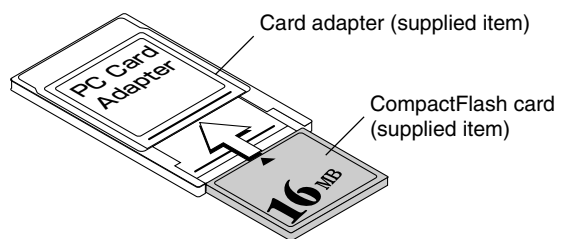

Direction for Inserting the CompactFlash Card

The CompactFlash card has a top and bottom and must be inserted into the PC card slot in a specific direction. It cannot be inserted backwards or upside-down. Attempting to force it into the slot in the wrong direction may break the internal pin and damage the card slot. Refer to the CompactFlash card's operating instructions for the proper direction of insertion.

CompactFlash Card Type

The PC Card slot accepts CompactFlash only.

Using the PC Card Viewer function

Installing the PC Card Viewer Software

Before Installing

Perform the following before installing the PC Card Viewer software:

- If Windows is already started, exit all applications. Installation may not be performed properly if any applications are running.

Installation

Install the viewer software as described below.

To quit installation before it is completed, press the "Cancel" button then follow the instructions in the dialog box.

1. Start up Windows.
2. Insert the CD-ROM into the CD-ROM drive.
The auto CD play function automatically starts the CD-ROM's program and the contents screen appears.

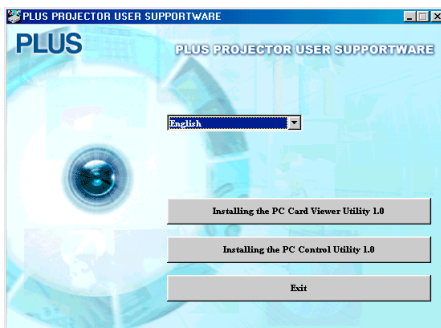

- * The auto CD play function operates if the "Auto insert notification" box in the computer's CD-ROM control panel is checked. (The box is checked by default.)

3. Click [Installing the PC Card Viewer Utility 1.0]
The setup dialog appears.

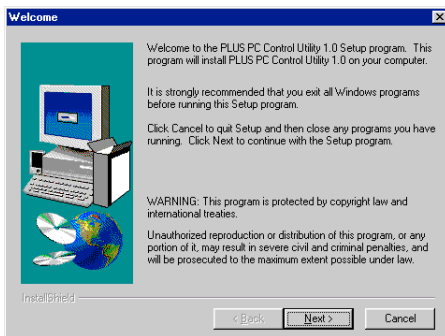

- * Follow the instructions in the setup dialog to complete the installation.

For instructions on uninstalling the PC Card Viewer software, see page E-70.

Starting Up the PC Card Viewer Software on your PC (PC Card Viewer Utility 1.0)

Use the PC Card Viewer Utility 1.0 for creating viewer slides. To start the PC Card Viewer software:

- * Select [Start]-[Programs]-[PLUS Projector Tools]-[PC Card Viewer Utility 1.0].

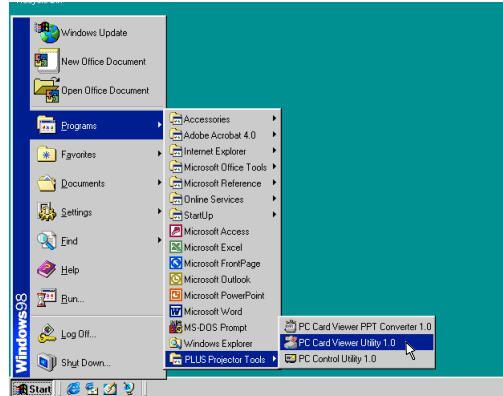

Refer to online help for instructions on using the PC Card Viewer software.

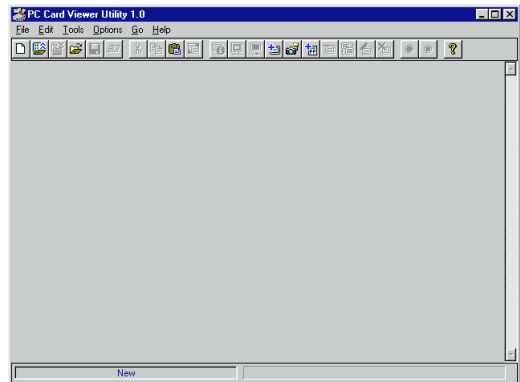

Contents of the English version PC Card Viewer software (PC Card Viewer Utility 1.0)

This is the software used for creating PC Card Viewer slides. In this manual it is referred to as the "PC Card Viewer software".

PC Card Viewer PPT Converter 1.0

This is an application that converts files created with Microsoft PowerPoint 97/2000 into indexes so that they can be played directly with the PC Card Viewer Utility 1.0.

PC Card Viewer PPT Converter is installed automatically when you install the PC Card Viewer Utility.

To start PC Card Viewer PPT Converter:

- * Select PC Card Viewer PPT Converter from PLUS Projector Tools.

Basic Operation of the PC Card Viewer Software

PC Card Viewer Utility is an application for editing documents, converting them into slides and storing them on CompactFlash cards as playback data (indexes) for presentations using projectors.

Using the PC Card Viewer function

Operating the PC Card Viewer Function from the Projector (playback)

This section describes the operation for showing slides of presentation documents created using the PC Card Viewer function with the projector.

It is also possible to make slides directly from the images projected with the projector.

Projecting slides

1. Insert a CompactFlash card into the card slot.
Insert the CompactFlash card with the side with the insertion direction arrow on the top.
* Press the eject button to eject the card.
2. Select the "PC Card Viewer" from the Source Select menu.

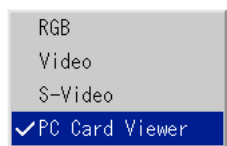

3. Project slides.

Checking "Show Folder List", means that selecting PC Card Viewer input displays a list of the folders in the CompactFlash card and if "Auto Play" is checked the projector automatically starts to play slides at the first slide of the folder you have selected.

A tool bar will appear when you press the MENU button on the remote control or the projector cabinet or clicking with the right button of a mouse.

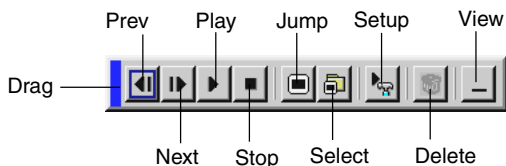

The tool bar includes the following buttons:

Drag: Drags to move the tool bar. This is available for USB mouse operation only.



Prev: Returns to the previous slide or folder. Or this lets you play slides back in reverse.



Next: Advances to the next slide or folder. Or this lets you play slides back.



Play: Plays back automatically or manually depending on the setting on PC Card Viewer Options of the menu. This allows you to move on to the next slide when "Manual Play" is selected.



Stop: This allows you to stop Auto Play while you are playing back and to resume playing from the selected slide or folder when "Auto Play" is selected.



Jump: Displays a list of slides while you are playing back.



Select: Displays a list of folders while you are playing back.



Setup: Displays the PC Card Viewer Options dialog box on Page 2 of the Setup dialog box.



Delete: Deletes a captured slide(s) or all the captured slides in the Capture – specific folder.



View: Hides the tool bar while you are playing back. Pressing the MENU button or clicking with the right button of a mouse shows it again.

Note:

If no memory card is inserted in the PC CARD slot, there is no signal, and a black, blue or logo background is displayed, depending on the setting.

Playback is stopped when SLIDE +/- button on the remote control or ◀▶ button on the cabinet is pressed in Auto Play mode.

Note:

Up to 12 indexes can be displayed on the list of folders. The folder in the right bottom is always a folder exclusively for captured images, but is only displayed when images have been captured. To display the list of folders when there are 13 or more indexes stored on the CompactFlash card, select "Edit index" from the PC Card Viewer software's "File" menu and move the index you want to display to within 12 indexes from the top of the folder index. For details on indexes, refer to the PC Card Viewer software's help folder.

Using the PC Card Viewer function

When the tool bar is not displayed:

Press the FOLDER LIST button on the remote control to display folders from a CompactFlash card in the projector's PC Card slot.

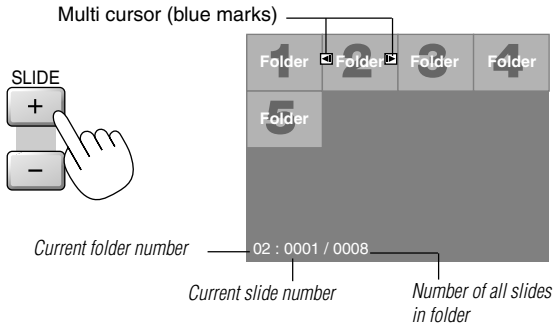

Use the SLIDE +/- button to advance to the next folder or return to the previous folder.



Slide(Table) cursor (green marks)



Use the SLIDE +/- button to advance to the next slide or return to the previous slide.



Note:

You can also use the ◀▶ button on the remote control to select folders or slides.

If you use the ◀▶ button on the remote control for PC Card Viewer operation, press the PJ button to switch to the Projector mode and the PJ button lights red.

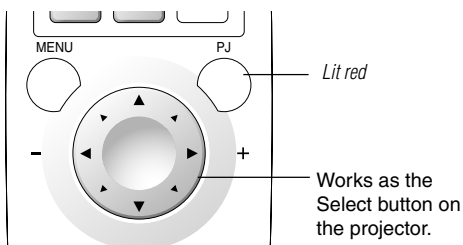

Auto Play Mode

- If the "Auto Play" option is selected in "PC Card Viewer Options" of the menu, any given slide will start to play automatically. You can also specify Auto Play Interval between 5 and 300 seconds.

Switching to Slides Directly from Other Input Modes

With this function it is possible to switch directly to a slide when the picture of a VCR or computer is being projected.

Example: When conducting presentations using a combination of slides and moving pictures from a VCR, etc., it is possible to switch from a PC Card Viewer slide to the video picture then back to the PC Card Viewer slide simply by using a source button and PC CARD button.

Note:

Even if you switch the current PC Card Viewer source to another source, the current slide is retained. When you return back to the PC Card Viewer, you will get the slide that has been retained.

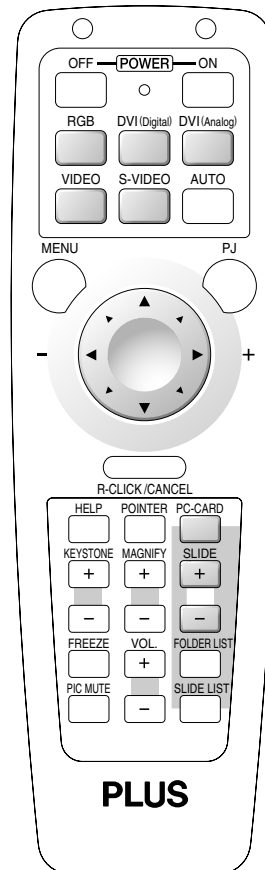

Note:

The PC card editing operation cannot be performed from the projector. Do so using the PC Card Viewer software.

Using the PC Card Viewer function

Capturing Images Displayed on the Projector

Storing images displayed on the projector on the CompactFlash card

Preparations:

Insert the CompactFlash card into the card slot.
Insert the CompactFlash card with the side with the insertion direction arrow on the top.

* Press the eject button to eject the card.

1. Project the image you wish to store on the projector.

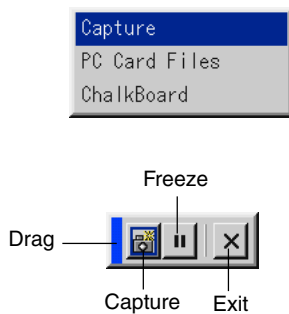

2. Select the "Capture" from the Tools menu.

3. A tool bar will appear.

The tool bar includes the following buttons:

Drag: Drags to move the tool bar (for USB mouse operation only).

Capture: Captures an image and save it as a JPEG file in a CompactFlash card.

Freeze: Freezes and unfreezes images.

Exit: Exits the Capture function. Another option to exit the Capture function is to press MENU or CANCEL button on the remote control or projector cabinet.

Note:

You can compress a captured file (JPEG) using the Capture Options in the Setup dialog.

Note:

Captured images with higher resolution than the projector's native resolution cannot be displayed correctly.

Note:

- File size of the captured image varies depending on the resolution of an input signal.
- Since an image data is compressed with the JPEG format, the image is slightly degraded.

Note:

An hourglass indicating that an image is being captured appears on the projector's display. Do not eject the CompactFlash card or turn off the projector's power while this icon is displayed. Doing so will damage the CompactFlash card data.

If the CompactFlash card data is damaged, use a computer to repair the data.

Note:

The folder in the right bottom is always a folder exclusively for captured images. To display the list of folders when there are 13 or more indexes stored on the CompactFlash card, select "Edit index" from the PC Card Viewer software's "File" menu and move the index you want to display to within 12 indexes from the top of the folder index. For details on indexes, refer to the PC Card Viewer software's help file.

Using the PC Card Viewer function

Deleting Captured Images

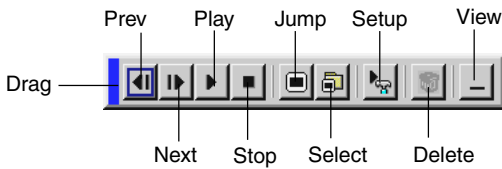

Using the Delete button on the tool bar for PC Card Viewer can delete captured images.

To delete captured images:

- 1) Select PC Card Viewer.
- 2) Use ► button to select the Capture folder in the right bottom of the screen.
- 3) Press the MENU button to display the tool bar.
- 4) Use the ◀ or ▶ button to select the Delete icon and press the ENTER button or click with a mouse button.

Viewing Digital Images

Digital images can be played with the PC Card Viewer if the following conditions are met:

- If the image can be stored on an MS-DOS format CompactFlash card
- If the image can be stored in a format supported by the PC Card Viewer.

With the PC Card Viewer, images on the card are searched for in directories and images in JPEG or BMP format are recognized as slides.

Searchable directories are directories within two steps from the root directory, and searchable images are images within the first 12 files in the directory. Only file and slide switching are possible.

Note:

The maximum number of images recognized as slides within one directory is 128.

Uninstalling the PC Card Viewer Software

Even if you do not know the PC Card Viewer software's file names or where they are stored, the PC Card Viewer software files can be easily removed from the system using the "Install/Uninstall Applications" control panel in Windows. (Normally there is no need to perform this operation.)

Uninstalling the software

Use the procedure described below to uninstall the PC Card Viewer software files.

1. From the "Start" menu, select "Settings" then "Control Panels".

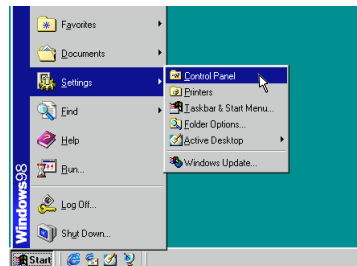

2. In the "Control Panels" dialog box, double-click on "Add/Remove Programs".

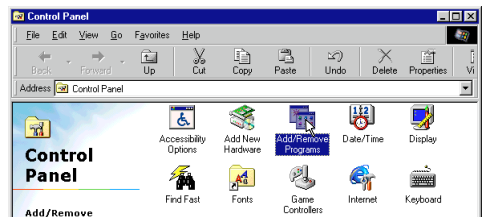

3. In the "Add/Remove Programs Properties" dialog box, click the "Setup/Remove" tab, then select "PC Card Viewer Utility 1.0" from the list of applications and click on "Add/Remove".

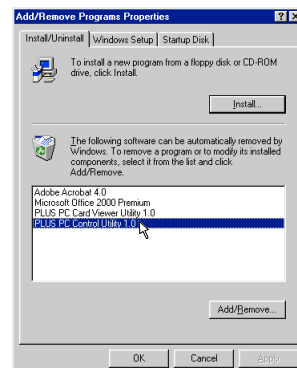

4. In the "Confirm File Deletion" dialog box, click "Yes".

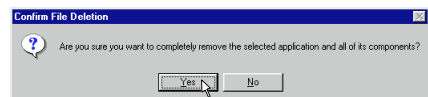

5. Once the application is uninstalled, click on "OK" in the "Remove Program From Your Computer" dialog box.

Using the PC Card Viewer function

Terminology

PC card	This is the name of a card currently being standardized by the Japan Electronic Industry Association (JEIDA) and PCMCIA (Personal Computer Memory Card Interface Association) of the United States.
ATA card	A type of PC card. ATA was originally a type of interface between computers and fixed disk devices. The ATA card is a standard card-type recording medium.
CompactFlash	CompactFlash card is a small removable card conforming to ATA specifications. It is one-fourth the volume of a PCMCIA card.
TYPE (I, II and III)	PCMCIA 2.1 PC cards are divided into three types according to their thickness: Type I (3.3 mm), Type II (5.0 mm) and Type III (10.5 mm).
BMP	A type of image format. The standard Windows Bit Map format used for MS-DOS/Windows-compatible computers.
JPEG	A type of image format. "JPEG" is the abbreviation of Joint Photographic Experts Group. JPEG compression offers efficient data storage. The data not required for displaying the image is identified and deleted. Since the data is deleted, JPEG algorithms are said to be irreversible. This means that once the image is compressed, the decompressed image it is not the same as the original image.









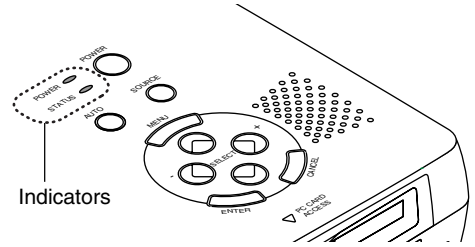



When the STATUS Indicator is Lit/Flashes

When an indicator is lit or flashing

The indicators on the projector's control panel light or flash to notify of problems, as described below.

An indicator is also used to notify you of the currently set power mode (under normal circumstances). See "Power Cable Connections and Switching the Power On/Off" on page E-24.



Indicator status	What you should do
POWER  Lit green STATUS  Lit red	It is time to replace the lamp. Replace with a new lamp cartridge.
POWER  Lit amber STATUS  Lit red	The lamp has reached the end of its service life. The power will no longer turn on. The projector can be used for 100 hours after the lamp has reached the end of its service life (when "Remaining Lamp Time" reaches 0%). Replace with a new lamp cartridge.
POWER  Lit amber STATUS  Flashing red (lit for 0.5 seconds/off for 0.5 seconds)	The lamp cover is open. The lamp cover is not properly mounted. Mount it properly.
POWER  Lit amber STATUS  Flashing red (lit for 2 seconds/off for 2 seconds)	The temperature is abnormally high. <ul style="list-style-type: none"> The temperature protector has been activated. If the room temperature is high, move the projector to a cool place. If the projector's internal temperature is high, check the cooling fan's ventilation slots and clean them if they are clogged. When the temperature protector is activated, the power turns off and in some cases will not turn back on immediately. In this case wait about 1 minute, then try again.
POWER  Lit amber STATUS  Flashing red (lit for 4 seconds/off for 4 seconds)	The fan has stopped. Unplug the power cable and contact a store that sells the U2-X2000 for repairs.
POWER  Lit amber STATUS  Flashing red (lit for 6 seconds/off for 6 seconds)	The lamp will not light. Wait at least 1 minute, then turn the power back on. If the problem persists, unplug the power cord and contact a store that sells the U2-X2000 for repairs.

Should an indicator be in a condition other than normal or flash at a rate other than the aforementioned, disconnect the power cable and contact your store of purchase.

Thermal Protector

When the internal temperature of the projector becomes abnormally high, the STATUS indicator will flash red (at a rate of once per second) and the POWER indicator will light red.

The thermal protector is activated and the power of the projector is switched off simultaneously.

Should this occur, proceed with the following actions.

1. Switch off the power and disconnect the power plug from the wall outlet.

2. Check the following matters and take the required measures.

When the projector is being used in a location that has a high ambient temperature, set it up again in a cool location. Check the outflow and intake holes and clean them if they are obstructed.

3. Wait about 60 minutes until the temperature of the projector drops.

If after having performed the above matters, the problem still has not been solved, please contact your store of purchase.

Troubleshooting

Check the following matters before requesting servicing.

Problem	Check	Reference Page
Power does not turn on	<ul style="list-style-type: none"> * Is the power cord plugged into a power outlet? * Is the lamp cover properly mounted? * Is the projector's temperature high? To protect the projector, the power cannot be turned on when the projector's temperature is abnormally high. * Has the lamp reached the end of its service life? 	<p>E-24 E-76 E-72 E-72</p>
No image is produced	<ul style="list-style-type: none"> * Is a connected input selected? * Is the cable properly connected to the input terminal? * When a computer is connected, are signals being output from the computer? * Does the signal being input have a frequency usable with this projector? * Are the brightness and contrast adjusted to the minimum? * When the component signal of a DVD player is connected to the RGB or DVI terminal (analog signal), if no image is produced, have you selected RGB/component? * For an RGB input, has the picture been properly adjusted? 	<p>E-29 E-18 -E-22 E-20 E-79 E-40 E-55 E-42</p>
Image is distorted	<ul style="list-style-type: none"> * Is the projector properly installed? * For trapezoidal (keystone) distortion, perform keystone adjustment. 	<p>E-27 E-32</p>
Image is out of focus	<ul style="list-style-type: none"> * Is the lens properly focused? * Are the screen and projector installed at the proper distance? * Does the projection distance exceed the focusing range? * Is there condensation on the lens, etc.? If the projector is moved from a cool storage area to a warm place and the power is turned on, condensation may form on the lens or internal optical parts. If this happens, wait until the condensation has evaporated before using the projector. 	<p>E-28 E-17 E-17 -</p>
Image is not in proper position and is not displayed properly	<ul style="list-style-type: none"> * For a computer input, are the horizontal and vertical positions properly adjusted? * Does the input signal have a compatible resolution and frequency? Check the computer's resolution. 	<p>E-42 E-79</p>
Video image is crushed	<ul style="list-style-type: none"> * If the image is crushed in the horizontal or vertical direction or if it is not displayed over the entire screen, select a different aspect ratio. 	E-41
Colors of the overall image are strange	<ul style="list-style-type: none"> * When a component signal is being input, is the color matrix setting proper? * For a composite input, is the hue properly adjusted? 	<p>E-45 E-40</p>
Characters flicker or colors are offset for RGB and DVI (analog) inputs	<ul style="list-style-type: none"> * Turn on the auto image adjust mode. If the auto image adjust mode is off (manual), adjust the clock frequency and phase. 	E-42
STATUS indicator is flashing	<ul style="list-style-type: none"> * See "When an indicator is lit or flashing". 	E-72
Remote control unit does not operate	<ul style="list-style-type: none"> * Are the remote control unit's batteries worn? Replace with new batteries. * Is there an obstacle between the remote control unit and the projector's remote control signal sensor? * Is the remote control unit outside of range? * Are you pointing the remote control unit's transmitter towards the projector's remote control signal sensor? 	<p>E-13 E-13 E-13 E-13</p>
Projector cannot be operated with the SELECT, ENTER and R-CLICK/CANCEL buttons on the remote control unit	<ul style="list-style-type: none"> * Is the computer mouse mode set? Press the "PJ" button so that the button lights red. 	E-15
USB mouse does not operate	<ul style="list-style-type: none"> * Is the USB mouse properly connected? (Not all USB mice can be used.) 	E-64
Projector buttons do not function	<ul style="list-style-type: none"> * Is the Control Panel Key Lock set to [Enable]? 	E-56

Cleaning

- Be certain to disconnect the power plug from the power outlet before cleaning.
- Do not spray or otherwise expose the projector, lens, or screen to volatile substances such as insecticides. Do not leave rubber or vinyl products in contact with the projector for long periods. Doing so could cause them to undergo qualitative changes or the coatings may peel, etc.

Cleaning a Soiled Projector Main Unit

- * Wipe with a lint-free, soft, dry cloth.
When very dirty, wipe with a cloth that has been moistened with a diluted neutral detergent, then finish with a dry cloth. If a chemically-treated cloth is going to be used, please follow any written warnings.
- * Do not wipe with thinner, benzene, or other solvents. Doing so could cause them to undergo qualitative changes or the coatings may peel, etc.
- * When removing the dust of the outflow and intake holes, use the brush attachment on a vacuum cleaner to clean out the dust. Avoid using the vacuum directly without attaching the adapter as well as the use of a nozzle adapter.
- * Do not scratch or otherwise hit the projector body with your nails or other hard object, since this will cause scratches.

Dirty Lens

- * Clean using the same method you would use to clean a camera lens: Use a commercial blower for camera use or cleaning paper for eye glasses. Be careful not to scratch the lens at this time.

Dust of the Intake and Outflow Holes

Dust that collects in the intake and outflow holes will obstruct the ventilation and cause the internal temperature to rise which could cause damage. Clean this area carefully. As a guideline, clean at least every 100 hours.

- * Switch off the power, check that the POWER indicator has changed to a steadily lit amber, then unplug the power cable.
- * Clean out the holes from the outside using a vacuum cleaner. Use the brush adapter of the vacuum cleaner to do this. Avoid using the vacuum directly without attaching the adapter as well as the use of a nozzle adapter.

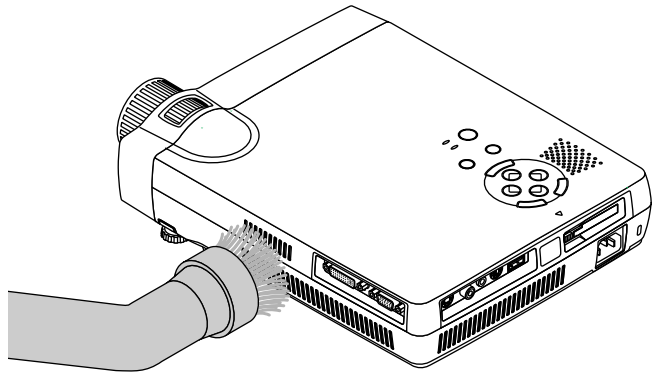

Cleaning the Inside of the Projector

Cleaning of the inside of the projector is required about once a year. Failure to clean over a long period while dust has collected inside the projector could cause a fire or breakdown. Do not clean the inside of the projector by yourself. Please be sure to contact your dealer.

Replacing the Lamp Cartridge

- The lamp as a light source used in the unit has a lifespan. The rated lamp life is about 1,000 hours. The rated lamp life is the average life of the lamps produced and tested (under the test conditions of our company) for a long term, however, it may become shorter depending on the conditions of usage.
- When the lamp usage time (the time indicated at “Lamp Hour Meter”) reaches 1000 hours (when the projector is used in the normal mode only), the STATUS indicator lights red and the message “It is time to replace the lamp. Replace the lamp as soon as possible, following the instructions in the manual.” appears on the screen. This indicates it is time to replace the lamp cartridge. Do so using the procedure described below. The lamp’s service life will be extended if the projector is frequently used in the economy mode. In this case the usage time is extended.
- See page E-63 for instructions on getting an approximation of the current remaining lamp usage time.
- If the projector is used another 100 hours after the lamp’s service life is reached, the power is set to the standby mode and no longer turns on.
- Contact a store that sells the U2-X2000 for a replacement lamp. Indicate you need a U2-200 replacement lamp for the U2-X2000 (order code 28-320).



CAUTION

- DO NOT TOUCH THE LAMP immediately after it has been used. It will be extremely hot. Allow at least one hour for the lamp to cool before handling.
- DO NOT LOOSEN ANY SCREWS except for those mentioned in the instructions below. There is danger of electric shock.



CAUTION

Do not use a lamp cartridge other than the PLUS replacement lamp cartridge. Order this from your PLUS dealer using the unit model number.

Replacing the Lamp Cartridge

Preparations: Turning the projector upside-down on top of a soft cloth, etc., so that it does not get scratched makes it easier to replace the lamp cartridge. Turn the projector right-side up after replacing the lamp cartridge.

1 Unplug the power cord.

2 Turn the projector upside-down.

3 Remove the lamp cover.

(1) Turn the lamp cover's set screw counterclockwise and loosen until the screw turns freely. (The screw does not come off.)

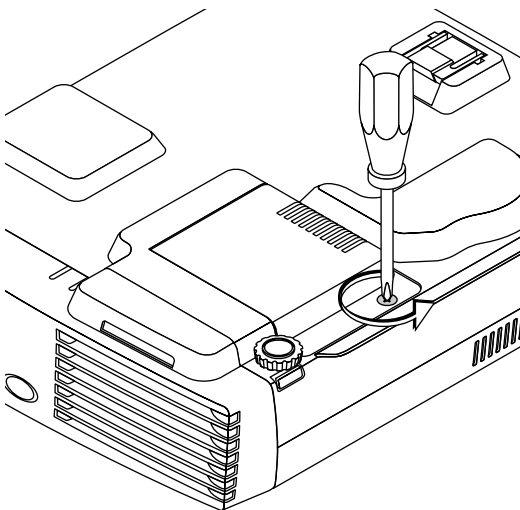

(2) Open the lamp cover a little, then pull it in the direction of the arrow and remove it.

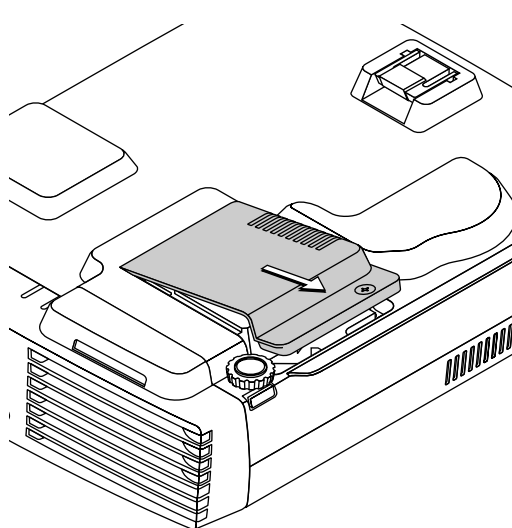

4 Remove the lamp cartridge.

(1) Turn the lamp cartridge's two set screws counterclockwise and loosen them until the screws turn freely. (The screws do not come off.)

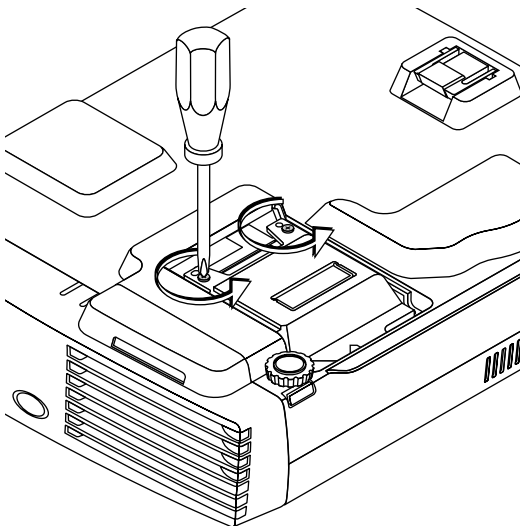

(2) Grasp the lamp cartridge's handle and pull upward to remove the lamp cartridge.

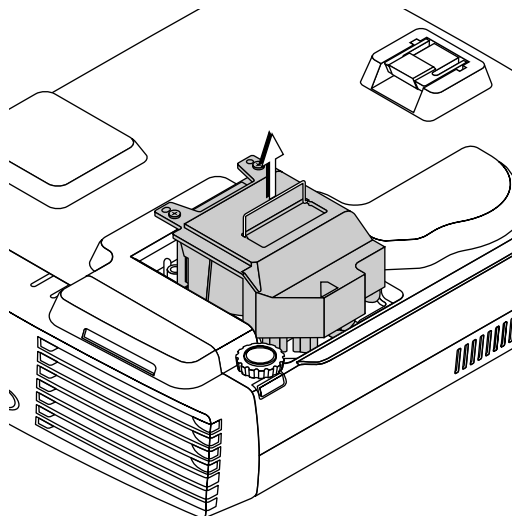

Replacing the Lamp Cartridge

5 Mount the new lamp cartridge.

(1) Placing the lamp cartridge with its socket facing towards you, slowly press the lamp cartridge in. (Line it up with the screw holes in the projector.)

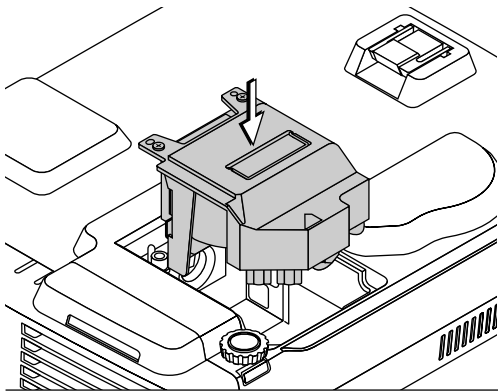

(2) Turn the two lamp cartridge screws clockwise to tighten them.

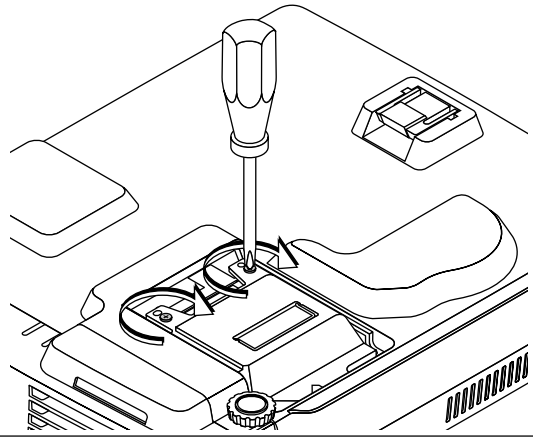

6 Mount the lamp cover.

(1) Set the tip of the lamp cover in place, then close the lamp cover.

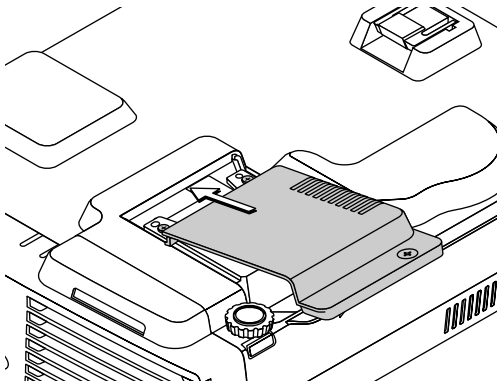

(2) Turn the lamp cover's screw clockwise to tighten it.

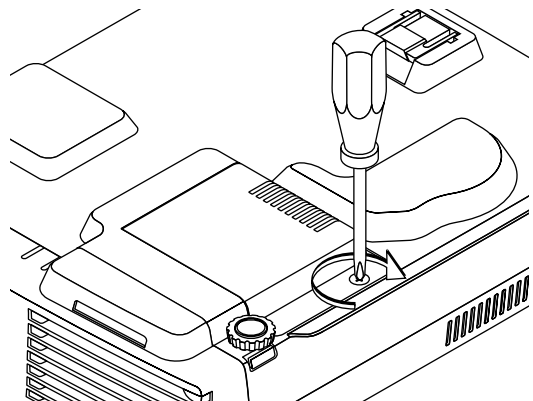

7 Reset the lamp hour meter.

First connect the power cord and turn on the power.

From the menu, select "Projector Options" → "Setup" → "Page 4" → "Clear Lamp Hour Meter" to reset the hour meter. See "Clear Lamp Hour Meter" on page E-55.

Note:

If the projector is used another 100 hours after the lamp's service life is reached, the power will no longer turn on. If this happens, in the standby mode press the HELP button on the remote control unit for at least 10 seconds to clear the remaining lamp time setting and the lamp hour meter. If the STATUS indicator turns off, the remaining lamp time setting and the lamp hour meter have been cleared.

Purchase a replacement lamp from a store that sells the U2-X2000. Indicate you need a U2-200 replacement lamp for the U2-X2000 (order code 28-320).

Specifications

Optical

Method of projection :	DLP™ (single chip DMD™)
DMD™	0.9 inches 1024 × 768 dots
Lamp	200 W ultra-high pressure mercury lamp
Projection lens :	Manual zoom, manual focus, F = 2.4 to 2.7, f = 35 to 42 mm
Image size	Minimum 27 inches (projection distance: 1.3 meters, tele mode) Maximum 300 inches (projection distance: 12.2 meters, wide mode)
Light Output	2000 ANSI lumens
Contrast Ratio	650:1 (Full on/off)

Electrical

Inputs	Video (NTSC3.58/NTSC4.43/PAL/PAL_N/PAL_M/PAL60/SECAM) RGB (Horizontal :15 to 100 kHz, Vertical 50 to 120 Hz)
Color Reproduction	Full color (16,770,000 colors)
Resolution	VGA (640 × 480) expansion/true, S-VGA (800 × 600) expansion/true XGA (1024 × 768) true, S-XGA (1280 × 1024) compression U-XGA (1600 × 1200) compression *1 (Advanced AccuBlend *3)
Input Current	2.8 A
Power Requirement	100 - 240 V AC, 50/60 Hz
Power Consumption	280 watts

Mechanical

Mouse output terminal :	Mini-DIN (9-pin) × 1
USB mouse :	USB (A Type) × 1 *2
PC card slot :	For CFA CompactFlash card × 1
Dimensions Excluding Stand	230 mm (W) × 58 mm (H) × 295 mm (D) 9.0 in.(W) × 2.3 in.(H) × 11.6 in.(D)
Weight	Approximately 2.5 kg / 5.5 lbs
Operational Temperatures	Data projector: 5° to 35°C (41° to 95°F), 30 to 85% humidity
Regulations	UL Approved (UL 1950, CSA 950) Meets FCC Class A requirements Meets EMC Directive (EN55022, EN55024) Meets Low Voltage Directive (EN60950)



*1:U-XGA: Only separate signals supported

*2: Some USB mice may not operate. (Main unit operation specific)

*3: Trademark of NEC Viewtechnology, Ltd.

- Specifications and design are subject to change without notice.

Table of Supported Frequency

The projector automatically identifies the signal input from the computer and selects the optimum resolution as shown on the table below.

Manual adjustments may be required for some input signals. See "Position/Clock" on page E-42.

Signal	Resolution	Frequency H. (kHz)	Refresh Rate (Hz)	Digital	Analog
VIDEO (NTSC)	-	15.734	60	○	-
VIDEO (PAL/SECAM)	-	15.625	50	○	-
VESA	640 × 350	37.9	85.1	-	○
	640 × 400	37.9	85.1	-	○
	640 × 480	31.5	59.9	-	○
	640 × 480	37.9	72.8	-	○
	640 × 480	37.5	75.0	-	○
	640 × 480	43.3	85.0	-	○
	720 × 400	37.9	85.0	-	○
	800 × 600	35.2	56.3	-	○
	800 × 600	37.9	60.3	-	○
	800 × 600	48.1	72.2	-	○
	800 × 600	46.9	75.0	-	○
	800 × 600	53.7	85.1	-	○
	1024 × 768	35.5	43 INT	-	○
	1024 × 768	48.4	60.0	-	○
	1024 × 768	56.5	70.1	-	○
	1024 × 768	60.0	75.0	-	○
	1024 × 768	68.7	85.0	-	○
	1152 × 864	67.5	75.0	-	○(*1)
	1280 × 960	60.0	60.0	-	○(*1)
	1280 × 960	85.9	85.0	-	○(*1)
	1280 × 1024	64.0	60.0	-	○(*1)
	1280 × 1024	74.9	69.9	-	○(*1)
	1280 × 1024	78.9	74.1	-	○(*1)
	1280 × 1024	80.0	75.0	-	○(*1)
	1280 × 1024	91.1	85.0	-	○(*1)
	1600 × 1200	75.0	60.0	-	○(*1)
	1600 × 1200	81.3	65.0	-	○(*1)
	1600 × 1200	87.5	70.0	-	○(*1)
	1600 × 1200	93.8	75.0	-	○(*1)
NEC	640 × 480	31.5	59.9	-	○
	640 × 400	24.8	56.4	-	○
	640 × 400	31.5	70.0	-	○
	640 × 480	31.5	60.0	-	○
NEC(EWS4800)	1280 × 1024	75.1	71.2	-	○(*1)
IBM	640 × 400	31.5	70.0	-	○
	640 × 480	31.5	60.0	-	○
	640 × 480	39.4	75.0	-	○
	720 × 350	31.5	70.1	-	○
MAC	640 × 400	35.0	66.0	-	○
	640 × 480	31.5	60.0	-	○
	640 × 480	35.0	66.7	-	○
MAC 16"	832 × 624	49.7	74.6	-	○
MAC 19"	1024 × 768	60.2	74.9	-	○
MAC 21"	1152 × 870	68.7	75.1	-	○(*1)
SUN	1152 × 900	61.8	66.0	-	○(*1)
HDTV(1080i)	1920 × 1080	33.75	60	○	-
HDTV(720p)	1280 × 720	45	60	○	-
SDTV(480p)	720 × 480	31.47	59.94	○	-
DVD YCbCr	-	15.734	59.94	○	-
DVD YCbCr	-	15.625	50	○	-

○ : Supported frequency

○(*1) : Supported with Advanced AccuBlend

- : Not supported frequency

* Factory presets have been set to the standard signals for the display resolution/frequency, but depending on the personal computer adjustment may be required.

* Proper display may not be possible for composite sync signals, sync-on-green sync signals, etc.

* In Advanced AccuBlend displays, there may be unevenness in the characters or the thickness of ruled lines.

* U-XGA supports only separate signals.

Cabinet Dimensions

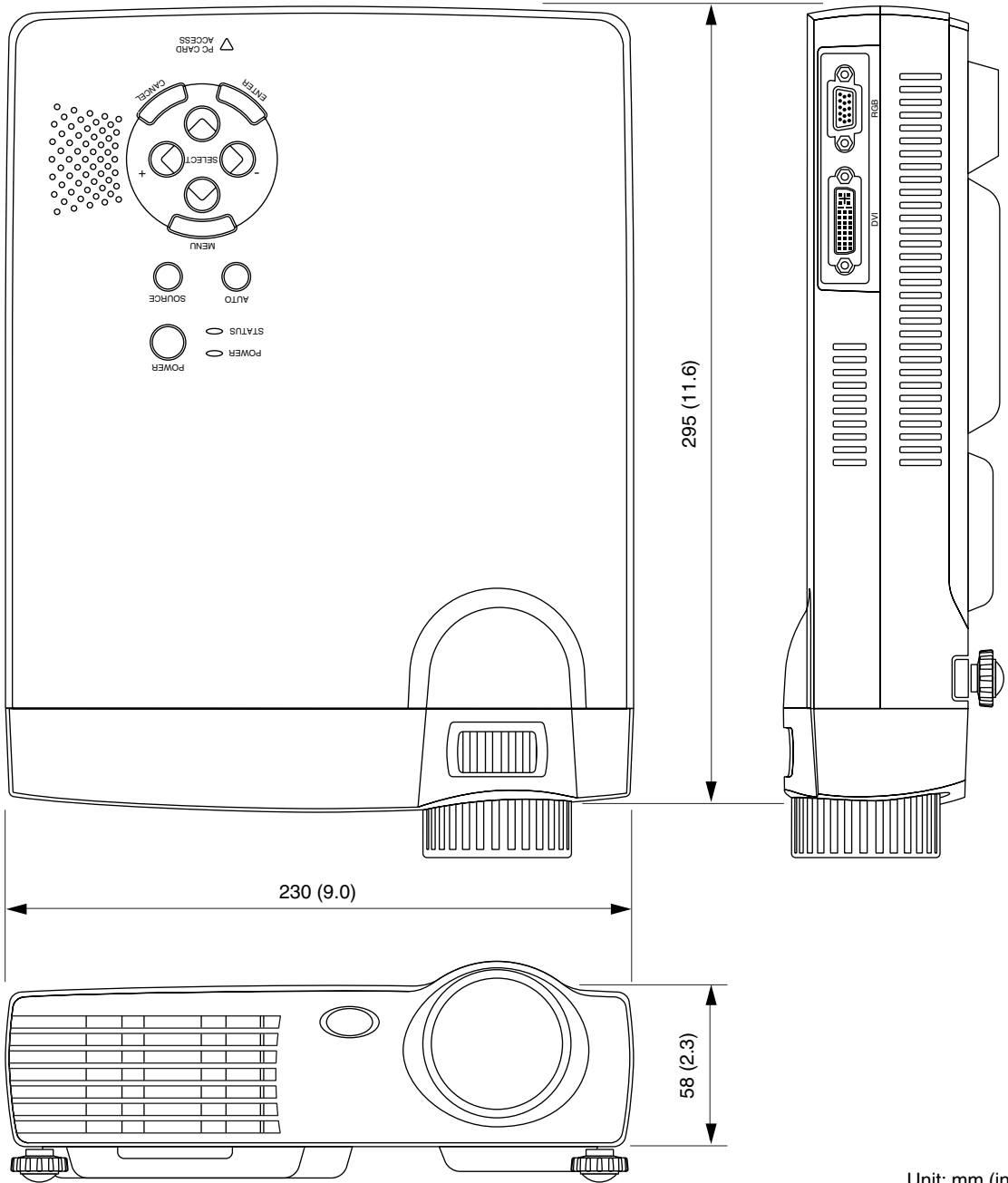

Unit: mm (inch)

PLUS Vision Corp.

20-11, Otowa 1-chome, Bunkyo-ku, Tokyo, 112-0013 JAPAN

www.plus-vision.com

TEL: +81-(0)3-3942-3157

FAX: +81-(0)3-3942-3160



PLUS Industrial Corporation is certified to ISO 9001.
Certificate No. Q1001219118017.



Otowa Head Office and PLUSLAND of PLUS Corporation
and PLUS Industrial Corporation are certified to ISO 14001.
ISO 14001 Certificate No. NQE-9809008A.

* PLUS Vision Corp. is certified to ISO 14001 as a member of the PLUS group.