

***myprojectorlamps.com***

**The most trusted, dependable name  
in projector lamp sales.**



<http://www.myprojectorlamps.com>



<http://www.myprojectorlamps.ca>



<http://www.myprojectorlamps.eu>

The following projector manual has not been modified or altered in any way.



PD7170  
Home Theater  
Projector



**Installation & Operation Manual**  
[www.planarhometheater.com](http://www.planarhometheater.com)



---

# TWO YEAR LIMITED WARRANTY

## For Projectors, Video Processors and Controllers

Congratulations on your purchase of a Planar video product and welcome to the Planar family! With proper installation, setup and care, you should enjoy many years of unparalleled video performance.

This is a LIMITED WARRANTY as defined in the Magnuson-Moss Warranty Act. Please read it carefully and retain it with your other important documents.

### WHAT IS COVERED UNDER THE TERMS OF THIS LIMITED WARRANTY:

**SERVICE LABOR:** Planar will pay for service labor by a Planar Authorized Service Center when needed as a result of manufacturing defect for a period of two (2) years from the effective date of delivery to the end user (excluding the lamp).

**PARTS (not including the lamp):** Planar will provide new or rebuilt replacement parts for the parts that fail due to defects in materials or workmanship for a period of two (2) years from the effective date of delivery to the end user. Such replacement parts are then subsequently warranted for the remaining portion (if any) of the original warranty period.

**PROJECTOR LAMP:** Planar will pay for service labor by a Planar Authorized Service Center when needed as a result of a manufacturing defect for a period of six (6) months or 1000 hours, whichever comes first, from the effective date of delivery to the end user. In addition, Planar will provide a new or rebuilt replacement lamp for the lamp that fails due to defects in materials or workmanship for a period of six (6) months or 1000 hours, whichever comes first, from the effective date of delivery to the end user. Such replacement lamps are then subsequently warranted for the remaining portion (if any) of the original warranty period.

### WHAT IS NOT COVERED UNDER THE TERMS OF THIS LIMITED WARRANTY:

This Limited Warranty only covers failure due to defects in materials and workmanship that occur during normal use and does not cover normal maintenance. This Limited Warranty does not cover cabinets or any appearance items; failure resulting from accident, misuse, abuse, neglect, mishandling, misapplication, faulty or improper installation or setup adjustments; improper maintenance, alteration, improper use of any input signal; damage due to lightning or power line surges, spikes and brownouts; damage that occurs during shipping or transit; or damage that is attributed to acts of God. In the case of remote control units, damage resulting from leaking, old, damaged or improper batteries is also excluded from coverage under this Limited Warranty.

CAUTION: THIS LIMITED WARRANTY ONLY COVERS PLANAR PRODUCTS PURCHASED FROM PLANAR AUTHORIZED DEALERS. ALL OTHER PRODUCTS ARE SPECIFICALLY EXCLUDED FROM COVERAGE UNDER THIS WARRANTY. MOREOVER, DAMAGE RESULTING DIRECTLY OR INDIRECTLY FROM IMPROPER INSTALLATION OR SETUP IS SPECIFICALLY EXCLUDED FROM COVERAGE UNDER THIS LIMITED WARRANTY. IT IS IMPERATIVE THAT INSTALLATION AND SETUP WORK BE PERFORMED ONLY BY AN AUTHORIZED PLANAR DEALER TO PROTECT YOUR RIGHTS UNDER THIS WARRANTY. THIS WILL ALSO ENSURE THAT YOU ENJOY THE FINE PERFORMANCE OF WHICH YOUR PLANAR PRODUCT IS CAPABLE WHEN INSTALLED AND CALIBRATED BY PLANAR AUTHORIZED PERSONNEL.

---

## **RIGHTS, LIMITS AND EXCLUSIONS:**

Planar limits its obligations under any implied warranties under state laws to a period not to exceed the warranty period. There are no express warranties. Planar also excludes any obligation on its part for incidental or consequential damages related to the failure of this product to function properly. Some states do not allow limitations on how long an implied warranty lasts, and some states do not allow the exclusion or limitation of incidental or consequential damages. So the above limitations or exclusions may not apply to you. This warranty gives you specific legal rights, and you may also have other rights that vary from state to state.

## **EFFECTIVE WARRANTY DATE:**

This warranty begins on the effective date of delivery to the end user. For your convenience, keep the original bill of sale as evidence of the purchase date.

## **IMPORTANT – WARRANTY REGISTRATION:**

Please fill out and mail your warranty registration card. It is imperative that Planar knows how to reach you promptly if we should discover a safety problem or product update for which you must be notified.

## **CONTACT A PLANAR AUTHORIZED SERVICE CENTER TO OBTAIN SERVICE:**

Repairs made under the terms of this Limited Warranty covering your Planar video product will be performed at the location of the product, during usual working hours, providing location of product is within normal operating distance from a Planar Authorized Service Center. In some instances it may be necessary for the product to be returned to the Planar factory for repairs. If, solely in Planar's judgment, location of product to be repaired is beyond normal operating distance of the closest Planar Authorized Service Center, or the repair requires the unit be returned to the Planar factory, it is the owner's responsibility to arrange for shipment of the product for repair. These arrangements must be made through the selling Planar Dealer. If this is not possible, contact Planar directly for a Return Authorization number and shipping instructions. Planar will return product transportation prepaid in the United States, unless no product defect is discovered. In that instance, shipping costs will be the responsibility of the owner.

## **COPYRIGHT AND TRADEMARKS:**

© Copyright 2008 Planar Systems, Inc. This document contains proprietary information protected by copyright, trademark and other intellectual property laws. All rights are reserved. No part of this manual may be reproduced by any mechanical, electronic or other means, in any form, without prior written permission of the manufacturer.

Trademarks and registered trademarks used in this document are the property of their respective owners.

---

**ADDITIONAL INFORMATION:**

To locate the name and address of the nearest Planar Authorized Service Center, or for additional information about this Limited Warranty, please call or write:

**Planar Systems, Inc.**  
**1195 NW Compton Drive**  
**Beaverton, OR 97006-1992**  
**Ph: (503) 748-5799**  
**Fax: (503) 682-9441**  
**Toll Free: (866) PLANAR1**

---

**PLANAR VIDEO PRODUCT INFORMATION**  
**RETAIN THIS INFORMATION FOR YOUR RECORDS**

\_\_\_\_\_

Model Purchased \_\_\_\_\_ Date \_\_\_\_\_

\_\_\_\_\_

Serial Number \_\_\_\_\_

\_\_\_\_\_

Planar Authorized Dealer Name \_\_\_\_\_

\_\_\_\_\_

Address \_\_\_\_\_

\_\_\_\_\_

City \_\_\_\_\_ State/Province \_\_\_\_\_ Postal Code \_\_\_\_\_

\_\_\_\_\_

Phone \_\_\_\_\_ Fax \_\_\_\_\_

# Important Safety Instructions

Thank you for your purchase of this quality Planar product! For best performance, please read this manual carefully as it is your guide through the menus and operation.

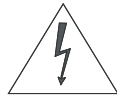
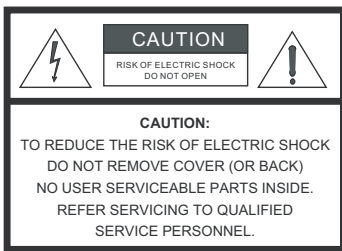

## WARNING

This symbol is intended to alert the user to the presence of uninsulated "dangerous voltage" within the product's enclosure that may be of sufficient magnitude to constitute a risk of electric shock.



This symbol is intended to alert the user to the presence of important operating and maintenance (servicing) instructions in the literature accompanying the appliance.

1. Read these instructions.
2. Keep these instructions.
3. Heed all warnings.
4. Follow all instructions.
5. Do not use this apparatus near water.
6. Clean only with a dry cloth.
7. Do not block any of the ventilation openings. Install in accordance with the manufacturer's instructions.
8. Do not install near any heat sources such as radiators, heat registers, stoves, or other apparatus (including amplifiers) that produce heat.
9. Do not defeat the safety purpose of the polarized or grounding type plug. A polarized plug has two blades with one wider than the other. A grounding type plug has two blades and a third grounding prong. The wide blade or the third prong is provided for your safety. When the provided plug does not fit into your outlet, consult an electrician for the replacement of the obsolete outlet.
10. Protect the power cord from being walked on or pinched particularly at plugs, convenience receptacles and the point where they exit from the apparatus.
11. Only use the attachments/accessories specified by Planar Systems.
12. Use only with a cart, stand, tripod, bracket or table specified by the manufacturer or sold with the apparatus. When a cart is used, use caution when moving the cart/apparatus to avoid injury from tip-over.
13. Unplug this apparatus during lightning storms or when unused for long periods of time.
14. Refer all servicing to qualified service personnel. Servicing is required when the apparatus has been damaged in any way, such as power supply cord or plug is damaged, liquid has been spilled or objects have fallen into the apparatus, the apparatus has been exposed to rain or moisture, does not operate normally, or has been dropped.
15. The +12V trigger only outputs 12Vdc signal for triggering. Do not connect to any other power input or output. This could cause damage to this unit.
16. Keep the packing material in case the equipment should ever need to be shipped.
17. The lamp becomes extremely hot during operation. Allow the projector to cool down for approximately 45 minutes prior to removing the lamp assembly for replacement.



18. Do not operate lamps beyond the rated lamp life. Excessive operation of lamps beyond rated life could cause them to explode in rare occasions.
19. Never look directly into the lens when the lamp is on.

# Compliance Information

## DECLARATION OF CONFORMITY:

Manufacturer's Name: Planar Systems, Inc.

Manufacturer's Address: 1195 NW Compton Drive, Beaverton, OR 97006

hereby declares that the products Model Numbers:

PD7170

conform with the provisions of:

Council Directive 2004/108/EC on Electromagnetic Compatibility;

EN 55022 "Limits and methods of measurements of radio interference characteristics of information technology equipment" 1998;

EN 55024 "Limits and methods of measurements of immunity characteristics of information technology equipment" 1998;

Including:

- EN 61000-4-2 "Electromagnetic compatibility (EMC) Part 4: Testing and measurement techniques Section 2: Electrostatic discharge immunity test"
- EN 61000-4-3 "Electromagnetic compatibility (EMC) Part 4: Testing and measurement techniques Section 3: Radiated, Radio-Frequency, Electromagnetic Field Immunity Test"
- EN 61000-4-4 "Electromagnetic compatibility (EMC) Part 4: Testing and measurement techniques Section 4: Electrical fast transient/burst immunity test"
- EN 61000-4-5 "Electromagnetic compatibility (EMC) Part 4: Testing and measurement techniques Section 5: Surge immunity test"
- EN 61000-4-6 "Electromagnetic compatibility (EMC) Part 4: Testing and measurement techniques Section 6: Conducted disturbances induced by radio-frequency fields immunity test"
- EN 61000-4-8 "Electromagnetic compatibility (EMC) Part 4: Testing and measurement techniques Section 8: Conducted disturbances induced by power frequency magnetic fields immunity test"
- EN 61000-4-11 "Electromagnetic compatibility (EMC) Part 4: Testing and measurement techniques Section 11: Voltage dips, short interruptions and voltage variations immunity tests"

And:

- EN 61000-3-2 "Electromagnetic compatibility (EMC) Part 3, Section 2: Limits for harmonic current emissions (equipment input current up to and including 16 A per phase)" 2000;
- EN 61000-3-3 "Electromagnetic compatibility (EMC) Part 3, Section 3: Limitations of voltage changes, voltage fluctuations and flicker in public low-voltage supply systems, for equipment with rated current up to and including 16 A and not subject to conditional connection" 1995;

Council Directive 2006/95/EC and amended by M1 and C1 on Low Voltage Equipment Safety;

EN 60950 "Safety of information technology equipment, including electrical business equipment"



---

The Technical Construction file required by this Directive is maintained at the corporate headquarters of Planar Systems, Inc., 1195 NW Compton Drive, Beaverton, OR 97006.

Date of Declaration: February 2008

#### **FCC PART 15:**

NOTE: This equipment has been tested and found to comply with the limits for a Class B digital device, pursuant to Part 15 of the FCC Rules. These limits are designed to provide reasonable protection against harmful interference in a residential installation.

This equipment generates, uses and can radiate radio frequency energy and, if not installed and used in accordance with the instructions, may cause harmful interference to radio communications. However, there is no guarantee that interference will not occur in a particular installation. If this equipment does cause harmful interference to radio or television reception, which can be determined by turning the equipment off and on, the user is encouraged to try to correct the interference by one or more of the following measures:

- Reorient or relocate the receiving antenna.
- Increase the separation between the equipment and receiver.
- Connect the equipment into an outlet on a circuit different from that to which the receiver is connected.
- Consult the dealer or an experienced radio/TV technician for help.

#### **INDUSTRY CANADA (ICES-003):**

This Class B digital apparatus complies with Canadian ICES-003.

Cet appareil numérique de la classe B est conforme à la norme NMB-003 du Canada.

#### **IMPORTANT RECYCLE INSTRUCTIONS**



Lamp(s) inside this product contain mercury. This product may contain other electronic waste that can be hazardous if not disposed of properly. Recycle or dispose in accordance with local, state, or federal Laws.

For more information, contact the Electronic Industries Alliance at [WWW.EIAE.ORG](http://WWW.EIAE.ORG).

For lamp specific disposal information check [WWW.LAMPRECYCLE.ORG](http://WWW.LAMPRECYCLE.ORG).

#### **DISPOSAL OF OLD ELECTRICAL AND ELECTRONIC EQUIPMENT (Applicable throughout the European Union and other European countries with separate collection programs)**



This symbol found on your product or on its packaging, indicates that this product should not be treated as household waste when you wish to dispose of it. Instead, it should be handed over to an applicable collection point for the recycling of electrical and electronic equipment. By ensuring this product is disposed of correctly, you will help prevent potential negative consequences to the environment and human health, which could otherwise be caused by inappropriate disposal of this product. The recycling of materials will help to conserve natural resources. This symbol is only valid in the European Union. If you wish to discard this product, please contact your local authorities or dealer and ask for the correct method of disposal.

# Table of Contents

---

<b>TWO YEAR LIMITED WARRANTY</b> .....	<b>iii</b>
<b>Important Safety Instructions</b> .....	<b>vi</b>
<b>Compliance Information</b> .....	<b>vii</b>
<b>1. Introduction</b> .....	<b>1</b>
About This Manual .....	1
Target Audience .....	1
If You Have Comments About This Manual... ..	1
Textual and Graphic Conventions.....	1
Using This Manual .....	2
Description, Features and Benefits .....	3
Key Features and Benefits.....	3
Parts List .....	4
<b>2. Controls and Functions</b> .....	<b>5</b>
PD7170 at a Glance .....	5
PD7170 Rear Panel .....	8
PD7170 Remote Control .....	9
<b>3. Installation</b> .....	<b>13</b>
Remote Control .....	13
Notes on Batteries .....	13
Notes on Remote Control Operation .....	13
Quick Setup .....	15
Installation Considerations .....	16
Installation Type.....	16
Ambient Light .....	17
Throw Distance .....	17
Vertical and Horizontal Position.....	18
Vertical and Horizontal Lens Shift .....	19
Folded Optics .....	20
Other Considerations.....	20
Lens Replacement .....	21

---

Mounting the PD7170 .....	23
Floor Mounting (Upright) .....	23
Ceiling Mounting (Inverted).....	23
Adjusting the Projection Angle.....	23
Connections to the PD7170 .....	23
Connector Panel Access .....	24
Connecting Source Components to the PD7170 .....	25
RS-232 Controller Connection .....	29
Connecting 12-Volt Trigger Output to External Theater Equipment .....	30
Connecting an External IR Receiver.....	30
Connecting to AC Power .....	31
Turning on the Power .....	31
Lens Adjustments .....	31
Focus .....	31
Zoom.....	31
Lens Shift.....	31
Changing the OSD Language .....	32
Adjusting the Picture Orientation .....	33
Rear Projection.....	33
Ceiling Mode.....	33
<b>4. Operation .....</b>	<b>35</b>
Selecting Video Memory .....	35
Selecting an Aspect Ratio .....	35
Selecting An Input Source .....	35
Using Picture-In-Picture (PIP) .....	36
Using the On-Screen Menus .....	37
Main.....	39
Advanced.....	49
System .....	55
Control.....	59
Language .....	61
Service.....	62
<b>5. Maintenance and Troubleshooting .....</b>	<b>65</b>
Lamp Replacement .....	65
Troubleshooting Tips .....	66

---

<b>6. Serial Communications</b> .....	<b>69</b>
RS-232 Connection and Port Configuration .....	69
Serial Command Syntax .....	69
Key Commands .....	69
Operations Commands .....	72
<b>7. Specifications</b> .....	<b>79</b>
PD7170 Specifications .....	79
PD7170 Dimensions .....	82
Supported Timings .....	83

---

**Notes:**

# List Of Figures

---

2-1. PD7170 Front/Side View .....	5
2-2. PD7170 Rear/Bottom/Top View .....	7
2-3. PD7170 Rear Panel .....	8
2-4. PD7170 Remote Control.....	9
3-1. IR Reception Angles .....	14
3-2. Estimating Throw Distance .....	17
3-3. Projector Placement .....	18
3-4. Vertical Lens Shift (Example Only) .....	19
3-5. Horizontal Lens Shift (Example Only).....	19
3-6. Folded Optics.....	20
3-7. HDMI/DVI Source Connections .....	25
3-8. RGB Connections.....	26
3-9. Component Video Connections .....	27
3-10. Composite and S-Video Connections .....	28
3-11. RS-232 Control System Connection .....	29
3-12. 12-Volt Trigger Output Connection .....	30
3-13. External IR Receiver Connection .....	30
4-1. PD7170 OSD Menu Structure .....	38
4-2. PD7170 Main Menu.....	39
4-3. Typical PLUGE Pattern for Adjusting Brightness .....	44
4-4. Typical Gray Bar Pattern for Adjusting Contrast.....	44
4-5. Typical Test Pattern for Adjusting Sharpness .....	45
4-6. Overscan Examples.....	47
4-7. Source Select Sub-Menu.....	48
4-8. PD7170 Advanced Menu .....	49
4-9. RGB Adjust Sub-Menu .....	52
4-10. Fine Sync Sub-Menu .....	53
4-11. PD7170 System Menu .....	55
4-12. Source Enable Sub-Menu .....	56
4-13. PIP and PBP areas for 720p Display.....	57
4-14. PIP Split-Screen Mode .....	58
4-15. PD7170 Control Menu.....	59

4-16. PD7170 Service Menu.....	62
7-1. PD7170 Dimensions .....	82

# Introduction

---

This Owner's Manual describes how to install, set up and operate the Planar PD7170 Home Theater Projector.

Throughout this manual, the Planar PD7170 Home Theater Projector is referred to as the "PD7170."

Planar has prepared this manual to help home theater installers and end users get the most out of the PD7170.

Planar has made every effort to ensure that this manual is accurate as of the date it was printed. However, because of ongoing product improvements and customer feedback, it may require updating from time to time. You can always find the latest version of this and other Planar product manuals on-line, at [www.Planar.com](http://www.Planar.com).

Planar welcomes your comments about this manual. Send them to [info@Planar.com](mailto:info@Planar.com).

**Text Conventions:** The following conventions are used in this manual, in order to clarify the information and instructions provided:

- Remote and built-in keypad button identifiers are set in upper-case bold type; for example, "Press **EXIT** to return to the previous menu."
- Computer input (commands you type) and output (responses that appear on-screen) is shown in monospace (fixed-width) type; for example: "To change the aspect ratio to Letterbox, type `op aspect = 1 <Enter>`."
- All keys with functional names are initial-capped, set in bold type and enclosed in angle brackets. These keys are the following: **<Enter>**, **<Spacebar>**, **<Control>**, **<Esc>** and **<Tab>**.
- **<Enter>** indicates that you may press either the RETURN or ENTER key on your keyboard if it has both keys.

In addition to these conventions, underlining, boldface and/or italics are occasionally used to highlight important information, as in this example:



## Note

A carriage return **must** be used after each command or string.

## 1.1 About This Manual

### ◀ Target Audience

### ◀ If You Have Comments About This Manual...

### ◀ Textual and Graphic Conventions



**Graphic Conventions:** These symbols appear in numerous places throughout the manual, to emphasize points that you must keep in mind to avoid problems with your equipment or injury:



**Tip**

*TIPS highlight time-saving short cuts and helpful guidelines for using certain features.*



**Note**

*NOTES emphasize text with unusual importance or special significance. They also provide supplemental information.*



**Caution**

*CAUTIONS alert users that a given action or omitted action can degrade performance or cause a malfunction.*



**WARNING**

*WARNINGS appear when a given action or omitted action can result in damage to the equipment, or possible non-fatal injury to the user.*



**DANGER!**

*DANGER appears when a given action can cause severe injury or death.*

## 1.2 Using This Manual

Use the following table to locate the specific information you need in this manual.

<b>If you need...</b>	<b>... Turn to page:</b>
Information about obtaining service	iv
General information about the PD7170 Home Theater Projector	3
Installation instructions	13
First-time configuration instructions	32
Advanced configuration instructions	49
Troubleshooting tips	66
Specifications for the PD7170 Home Theater Projector	79

The Planar PD7170 has been engineered for the top quality picture performance and installation flexibility heretofore associated with projectors costing far more.

The PD7170 high-definition, 1280 x 720 native resolution, three-chip DLPTM light engine features state-of-the-art technology for bright, pristine, high-definition images.

The PD7170 is equipped with a precision optics package offering zoom, focus and lens shift controls and a throw range of 1.82:1 to 2.28:1. For even greater installation flexibility, four other lens options are available offering throw distances ranging from 1.52 to 7.09 times the screen width.

The PD7170 has been engineered to comply with Imaging Science Foundation™ (ISF) standards for maximum home theater image quality. Planar's sophisticated parameters for white balance and color gamut control have also been implemented for precise balance of gray scale and color. The PD7170 incorporates proprietary de-interlacing technology that provides exceptional scaling and film-to-video (3:2 pull-down) conversion for the most artifact-free images possible.

Discrete infrared (IR) and RS-232 control make custom installation seamless, while discrete power on/off and source selection accommodate any automation control system.

The PD7170 offers these key features and benefits:

- Native Resolution: 1280 x 720 (16:9 Native Aspect Ratio)
- DLP system using three (3), high-performance Digital Micromirror Device (DMD) chips for increased brightness, allowing for larger screen sizes
- DynamicBlack™ provides for infinitely variable adjustment of the light path through the optics, enabling the perfect balance of black and white levels for any type of video source material
- Picture in Picture function allows you to display two inputs on the screen at the same time
- Two (2), HDMI 1.3 Inputs with High-bandwidth Digital Content Protection (HDCP)
- HDTV Compatible
- Power lens shift (horizontal and vertical)
- Power zoom and focus

---

### 1.3 Description, Features and Benefits

#### ◀ Key Features and Benefits

- Parts List** ➤ Your PD7170 is shipped with the following items. If any items are missing or damaged, please contact your Planar dealer or Planar Customer Service at (866) PLANAR1 (752-6271).
- PD7170 Home Theater Projector with standard Z100 Lens (1.82:1 – 2.28:1 throw ratio; part number 997-5488-00)
  - Remote Control Unit and two (2), AA-size batteries
  - AC Power Cords (North America, Europe, United Kingdom)
  - Source Connection Cables:
    - Component Video, 1.8 meters (5.9 feet)
    - HDMI to HDMI, 2.0 meters (6.6 feet)
  - Warranty information and registration card
  - Cleaning Cloth
  - Clip-on Light Shield
  - Planar PD7170 Installation/Operation Manual (this document)

**Optional Accessories:**

- Ceiling mount kit (part number 997-4214-00)
- Replacement Lamp (part number 997-5353-00)
- Replacement Lenses (refer to page 18 for more information):
  - Z80, 1.52:1 – 1.82:1 throw ratio (part number 997-5487-00)
  - Z200, 2.28:1 – 3.04:1 throw ratio (part number 997-5489-00)
  - Z400, 3.04:1 – 4.56:1 throw ratio (part number 997-5490-00)
  - Z500, 4.56:1 – 7.09:1 throw ratio (part number 997-5491-00)

# Controls and Functions

Figure 2-1 and Figure 2-2 show the key PD7170 components.

## 2.1 PD7170 at a Glance

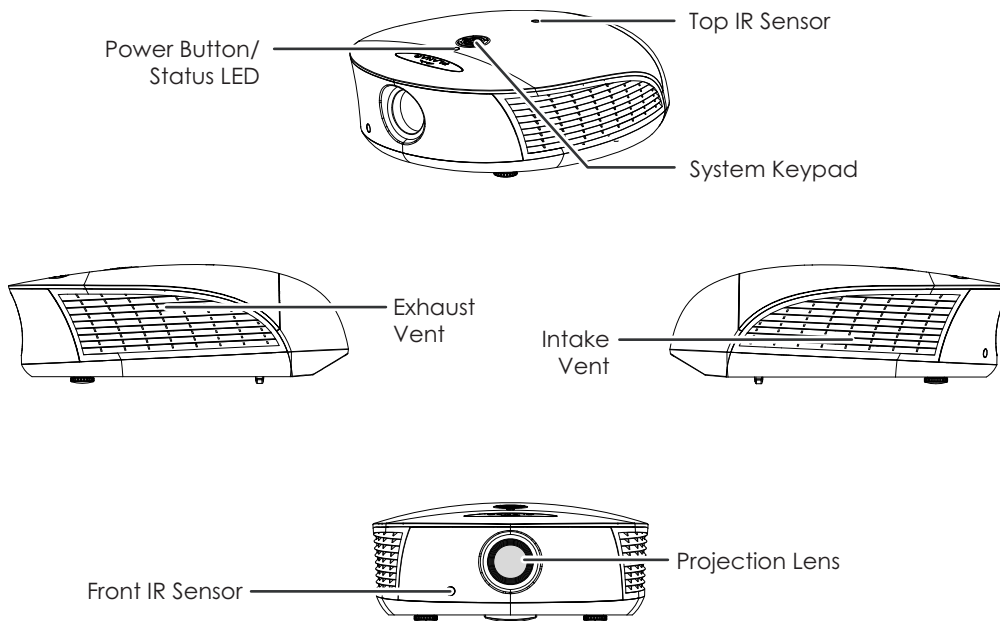

**Figure 2-1. PD7170 Front/Side View**

- **TOP IR SENSOR**  
Receives infrared signals from the remote control unit.
- **SYSTEM KEYPAD**  
Provides an alternative to using the remote control unit to select a source or navigate the on-screen display (OSD) controls.

### SOURCE

Use this button to select a video source.

### Cursor Buttons (▲, ◀, ▼, ▶)

Use these buttons to select items or settings, adjust settings or switch display patterns.

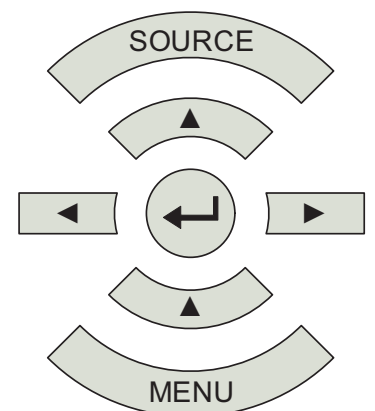

### **ENTER** (↵)

Press to select a highlighted menu item or confirm a changed setting.

When no menu is present on-screen, press **ENTER** to access the motorized lens focus control. Press **ENTER** again to access the motorized lens zoom control. Press **ENTER** yet again to access the motorized lens shift control.

Use the ▲ and ▼ buttons to adjust focus, zoom or vertical lens position. Use the ◀ and ▶ buttons to adjust horizontal lens position.

### **MENU**

Press this button to show or hide the OSD menus.



- **POWER BUTTON/STATUS LED**

Indicates projector status as follows:

- Solid green = AC power present, ready to turn on (lamp not lit)
- Flashing green = lamp is warming up or cooling down; keypad functions not allowed
- Off = Lamp lit, projector functioning normally
- Alternating green/red = Lamp problem (door open, unable to strike, end of life), user intervention likely to fix problem
- Flashing red = Over temperature, user intervention (clear vents, turn on AC) may fix problem
- Solid red = Error that requires servicing (fan fail, Power-on self-test fail etc.)

- **EXHAUST VENT**

Warm air exits the projector through this vent. Ensure that it is not blocked.

- **INTAKE VENT**

Internal fans draw cool air into the projector through this vent.

- **PROJECTION LENS**

The inside of the lens barrel is threaded to accommodate a standard, 72-mm lens filter. For example, with a smaller screen you can install a neutral-density filter to reduce the overall light output.

If needed, a light shield accessory is provided with the lens to minimize stray light emissions. (Use it only when the vertical offset is 50% of the screen height or greater.) The light shield attaches to the end of the lens (or to the filter, if used).

- **FRONT IR SENSOR**

Receives infrared signals from the remote control unit.

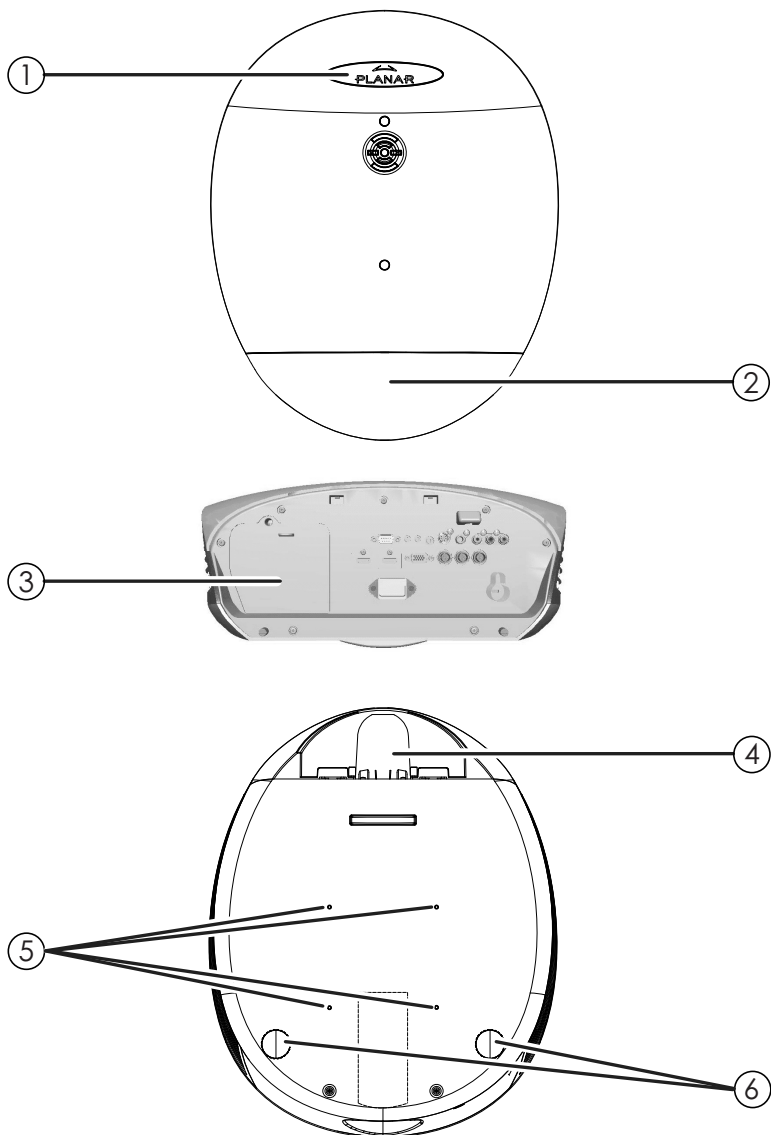
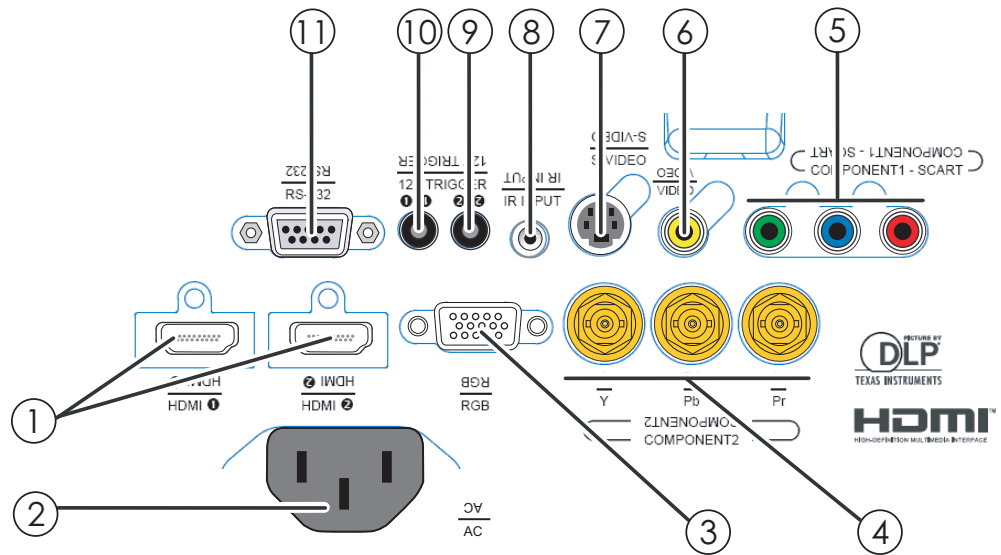

**Figure 2-2. PD7170 Rear/Bottom/Top View**

1. **PLANAR LOGO BADGE**
2. **REAR COVER**  
Remove to access connectors.
3. **LAMP MODULE COVER**  
Remove this cover to access the lamp compartment.
4. **CABLE OPENING**  
Pass cables through this opening.
5. **CEILING MOUNT HOLES**  
Use these to attach the ceiling bracket to the projector.
6. **ADJUSTABLE FEET**  
Use these when the projector is installed in a table-top configuration to level the image and/or adjust the projection angle.

## 2.2 PD7170 Rear Panel

Figure 2-3 shows the PD7170 rear panel.



**Figure 2-3. PD7170 Rear Panel**

1. **HDMI 1 (Digital)  
HDMI 2 (Digital)**  
HDCP-compliant digital video inputs for connecting an HDMI or DVI source.
2. **POWER INPUT (100 to 240 VAC)**  
Connect the PD7170 to power here.
3. **RGB**  
Provides a standard, 15-pin VGA-style connection to either an RGB or component high-definition source, or to a personal computer. The PD7170 automatically detects the input signal resolution.
4. **COMPONENT 2**  
Three BNCs for connecting component (YPbPr) video sources.
5. **COMPONENT 1/SCART (RCA connectors)**  
Standard- or high-definition (480i/480p/576i/576p/720p/1080i/1080p) Component (YPrPb) input for connecting a DVD/HD-DVD/BD player, HD set-top box or other SD/HD source. Also provides RGB input for RGBS sources.
6. **VIDEO**  
Standard composite video input for connecting a VCR, laser disc player or other composite video source. Also provides composite sync input for RGBS sources.

7. **S-VIDEO**  
A standard S-Video input for connecting a DVD player, satellite receiver or Super VHS (S-VHS) VCR.
8. **IR INPUT**  
Wired input from a Niles- or Xantech-compatible, infrared (IR) repeater system.
9. **TRIGGER 2 (3.5-mm, mini phono jack)**  
Provides 12 (+/- 1.5) volt switched output for screen relays with 250mA current capacity and short protection.
10. **TRIGGER 1**  
Provides 12 (+/- 1.5) volt switched output for screen relays with 250mA current capacity and short protection.
11. **RS-232**  
A female, 9-pin D-sub connector for interfacing with a PC or home theater automation/control system.

Figure 2-4 shows the PD7170 remote control, and the paragraphs that follow describe its functionality.

## 2.3 PD7170 Remote Control

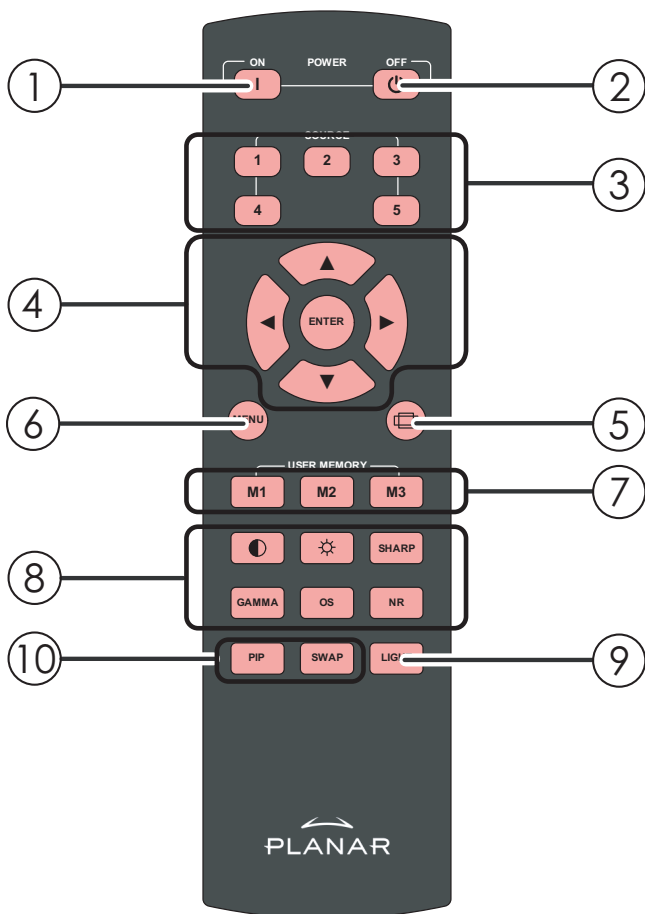

**Figure 2-4. PD7170 Remote Control**



1. **ON**  
Use this button to turn the projector on.
2. **OFF**  
Use this button to turn the projector off.
3. **Source Selection Buttons (1-5):**  
  
Press to select a video source. By default, these buttons are assigned as follows: 1 = HDMI 1; 2 = HDMI 2; 3 = Component 1; 4 = S-Video; 5 = Video. However, you can assign each button to any source you wish.
4. **Cursor Buttons (▲, ◀, ▼, ▶)**  
Use these buttons to select items or settings, adjust settings or switch display patterns.  
  
**ENTER**  
Press to select a highlighted menu item or confirm a changed setting.  
  
When no menu is present on-screen, press **ENTER** to access the motorized lens focus control. Press **ENTER** again to access the motorized lens zoom control. Press **ENTER** yet again to access the motorized lens shift control.  
  
Use the ▲ and ▼ buttons to adjust focus, zoom or vertical lens position. Use the ◀ and ▶ buttons to adjust horizontal lens position.
5. **Aspect Ratio Selection Button**  
Press this button repeatedly to select one of the following aspect ratios:  
  
**16 : 9:** For viewing 16:9 DVDs or HDTV programs in their native aspect ratio.  
**Letterbox:** For viewing LaserDisc movies or non-anamorphic DVDs on a 16:9 screen.  
**4 : 3:** Scales the input signal to fit 4:3 sources in the center of the screen.  
**4:3 Narrow:** Scales the input signal to fit 4:3 sources in the center of the screen when using an anamorphic lens.  
**Native:** Displays source image in its native resolution without re-sizing or overscan.
6. **MENU**  
Press this button to show or hide the OSD controls.
7. **Memory Preset Buttons (M1 / M2 / M3)**  
Press to recall settings for the current input from one of three memory presets. By default, these buttons are assigned as follows: M1 = User Memory 1; M2 = User Memory 2; 3 = ISF Night. However, you can assign each button to any memory preset you wish.

---

## 8. Picture Adjustment Buttons:

**Contrast** 

Press to adjust white level.

**Brightness** 

Press to adjust black level.

**Sharpness (SHARP)**

Press to adjust sharpness.

**Gamma (GAMMA)**

Press to select a gamma curve.

**Overscan (OS)**

Press to select an overscan mode.

**Noise Reduction (NR)**

Press to adjust noise reduction level.

## 9. LIGHT

Press momentarily to activate remote backlighting. Press and hold for 5 to 7 seconds to illuminate the projector rear panel, to facilitate connecting cables in a dark room.

## 10. Picture-In-Picture (PIP) Controls:

**PIP**

Press repeatedly to activate/deactivate PIP mode or select the desired PIP image source.

**SWAP**

Press to swap the PIP image with the active source image.

**Notes:**

# Installation

To install batteries in the remote control:

1. Slide the battery compartment cover in the direction of the arrow to remove it.
2. Install two AA batteries with the correct polarity.
3. Replace the cover.

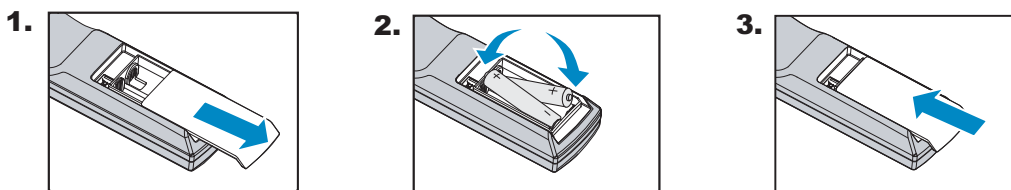

- Make sure that the battery polarities are correct when installing the batteries.
- Do not mix an old battery with a new one or different types of batteries.
- If you will not use the remote control for a long time, remove the batteries to avoid damage from battery leakage.
- In most situations, you can simply point the remote control at the screen which will reflect the IR signal from the remote back toward the IR receiver on the projector. In some cases, however, ambient conditions may prevent this. If so, point the remote control at the projector and try again.
- If the effective range of the remote control decreases, or it stops working, replace the batteries with new ones.
- The remote control may fail to operate if the infrared remote sensor is exposed to bright sunlight or fluorescent lighting.

## 3.1 Remote Control

### ◀ Notes on Batteries

### ◀ Notes on Remote Control Operation

- The projector's front IR receiver has a range of approximately 40 feet (12.19 meters); the top IR receiver has a range of approximately 20 feet (6.10 meters). Figure 3-1 shows the reception angles of the front and top IR receivers.

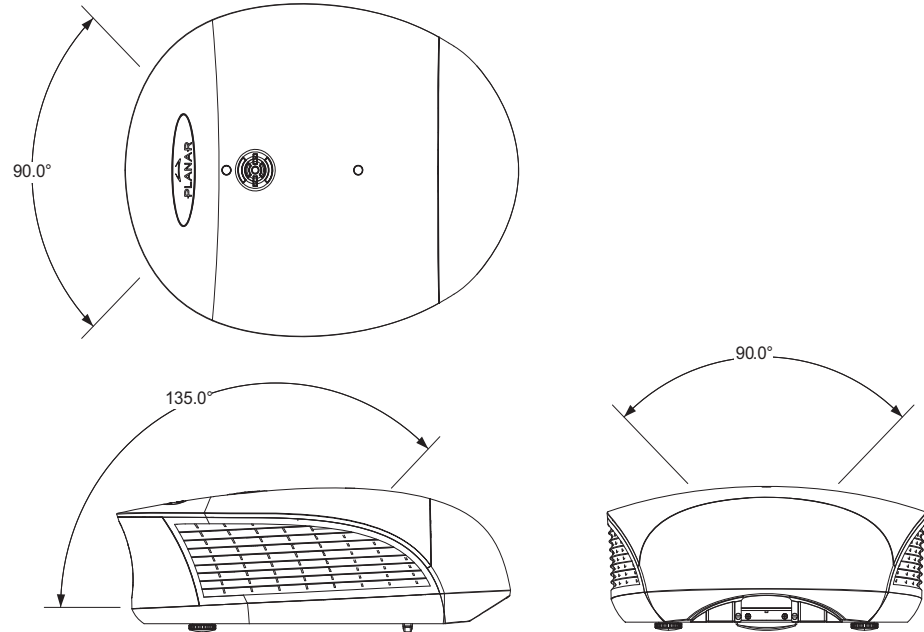

**Figure 3-1. IR Reception Angles**

Table 3-1 gives a quick overview of the PD7170 installation process. The sections following this one provide detailed instructions.

## 3.2 Quick Setup



### Note

*Installation should be performed by a qualified custom video installation specialist.*

**Table 3-1. Installation Overview**

Step	Procedure	For Details, Refer to page...
1	Choose a location for the projector	16
2	Install the projection lens (if standard lens will not be used)	21
3	Mount the projector	23
4	Connect signal sources to the PD7170	25
5	Connect external controller to RS-232 port and/or IR repeater system (optional)	29
6	Connect 12-volt trigger output to retractable screen or other, +12V trigger-activated equipment (optional)	30
7	Apply power to the projector	31
8	Primary lens adjustments: projected image size (zoom), position (shift) and focus	19, 31
9	Change the OSD Language (optional)	32
10	For rear-screen and/or ceiling-mount installations, select the proper picture orientation	33
11	Projector calibration: adjust the following <b>for each input</b> ; save settings when finished: Aspect ratio Brightness Contrast Color level Tint Input position	39

### 3.3 Installation Considerations

Proper installation of your projector will ensure the quality of your display. Whether you are installing a projector temporarily or permanently, you should take the following into account to ensure your projector performs optimally.

**Installation Type** ➤ Choose the installation type that best suits your needs: front or rear screen, floor mount or inverted mount. Table 3-2 compares these various installation methods.

**Table 3-2. Projector Installation Options**

Advantages	Considerations
<b>Front Screen, Floor Mount Installation</b>	
<ul style="list-style-type: none"> <li>• Easy to set up</li> <li>• Can be moved or changed quickly</li> <li>• Easy to access</li> </ul>	<ul style="list-style-type: none"> <li>• Shares floor space with audience</li> </ul>
<b>Front Screen, Inverted Mount (ceiling) Installation</b>	
<ul style="list-style-type: none"> <li>• Does not take up audience space</li> <li>• Projector is unobtrusive</li> <li>• Projector cannot be accidentally moved</li> </ul>	<ul style="list-style-type: none"> <li>• Installation is more permanent</li> <li>• Projector access is more difficult</li> </ul>
<b>Rear Screen, Floor Mount Installation</b>	
<ul style="list-style-type: none"> <li>• Projector is completely hidden</li> <li>• Projector is easily accessed</li> <li>• Usually good ambient light rejection</li> </ul>	<ul style="list-style-type: none"> <li>• Requires separate room</li> <li>• Installation cost is usually higher</li> </ul>
<b>Rear Screen, Inverted Mount (ceiling) Installation</b>	
<ul style="list-style-type: none"> <li>• Projector is completely hidden</li> <li>• Usually good ambient light rejection</li> </ul>	<ul style="list-style-type: none"> <li>• Requires separate room</li> <li>• Installation cost is usually higher</li> </ul>
<b>Rear Screen, Floor Mount with Mirror</b>	
<ul style="list-style-type: none"> <li>• Projector is completely hidden</li> <li>• Usually good ambient light rejection</li> <li>• Requires less space behind screen than other rear screen installations</li> </ul>	<ul style="list-style-type: none"> <li>• Requires separate room</li> <li>• Installation cost is usually higher</li> </ul>

In general, minimize or eliminate light sources directed at the screen. Contrast ratio in your images will be noticeably reduced if light directly strikes the screen, such as when a shaft of light from a window or floodlight falls on the image. Images may then appear washed out and less vibrant.

◀ **Ambient Light**

Throw distance is the distance measured from the front of the projector to the screen. This is an important calculation in any projector installation as it determines whether or not you have enough room to install your projector with a desired screen size and if your image will be the right size for your screen.

◀ **Throw Distance**

You can quickly estimate the throw distance by taking the width of the screen and multiplying it by the lens throw ratio; see Figure 3-2. The result of this calculation tells you roughly how far back the projector should be positioned from the screen in order to project a focused image large enough to fill the screen.

**Estimating Throw Distance**

Throw Distance (TD) =  
Screen Width (w) x Lens Throw Ratio

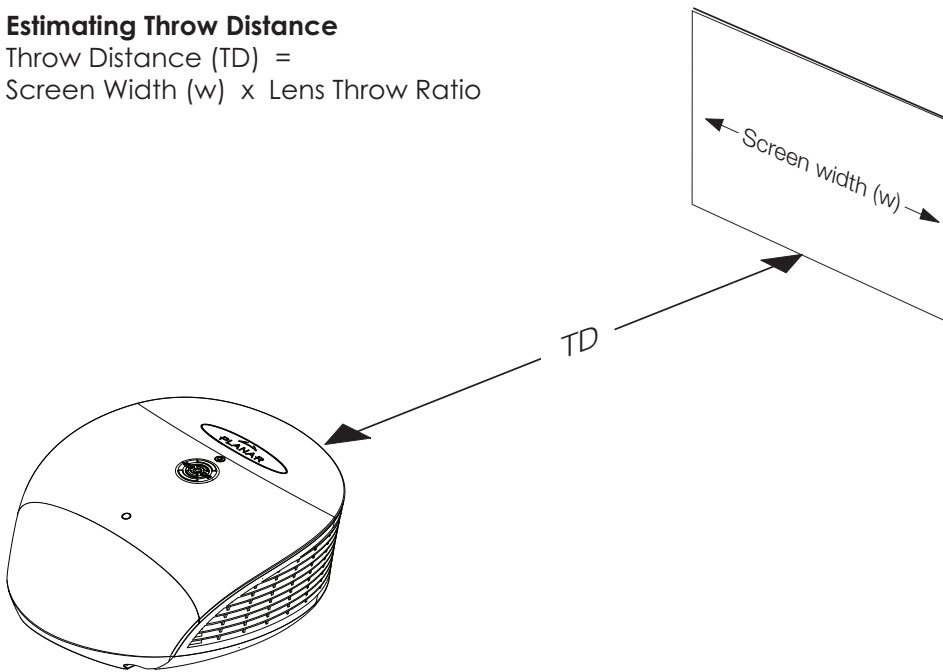

**Figure 3-2. Estimating Throw Distance**



Table 3-3 lists the available lens options for the PD7170 and their associated throw ratios.

**Table 3-3. PD7170 Lens Options and Throw Ratios**

Lens Option	Throw Ratio	Throw Range in inches, with a 96x54-inch (1.78:1) Screen	
		Minimum	Maximum
Z80	1.52 - 1.82	145.92	174.72
Z100 (standard)	1.82 - 2.28	174.72	218.88
Z200	2.28 - 3.04	218.88	291.84
Z400	3.04 - 4.56	291.84	437.76
Z500	4.56 - 7.09	437.76	680.64

**Vertical and Horizontal Position** ➤

Proper placement of the projector relative to the screen will yield a rectangular, perfectly-centered image that completely fills the screen.

Ideally, the projector should be positioned perpendicular to the screen and in such a way that the lens center is aligned with either the top or bottom edge of the screen area, and centered horizontally. See Figure 3-3.

**Ceiling Installation**

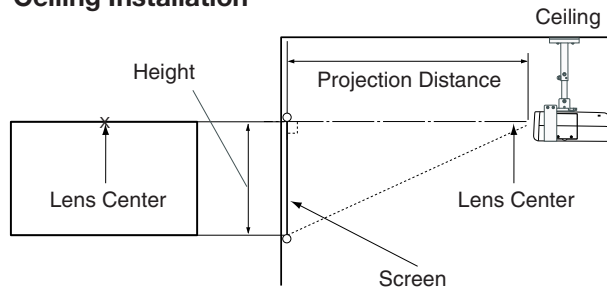

**Floor Installation**

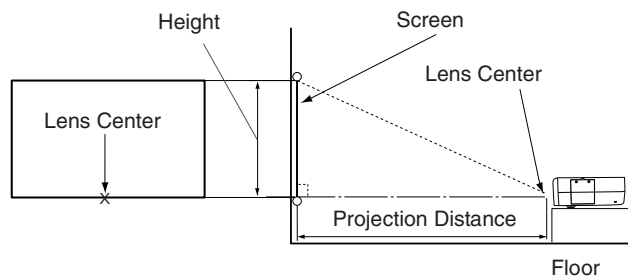

**Figure 3-3. Projector Placement**

You can use the lens shift controls on the projector to center the image on the screen. Lens shift is generally expressed as a percentage of the screen height or width, as shown in Figure 3-4 and Figure 3-5.

◀ **Vertical and Horizontal Lens Shift**

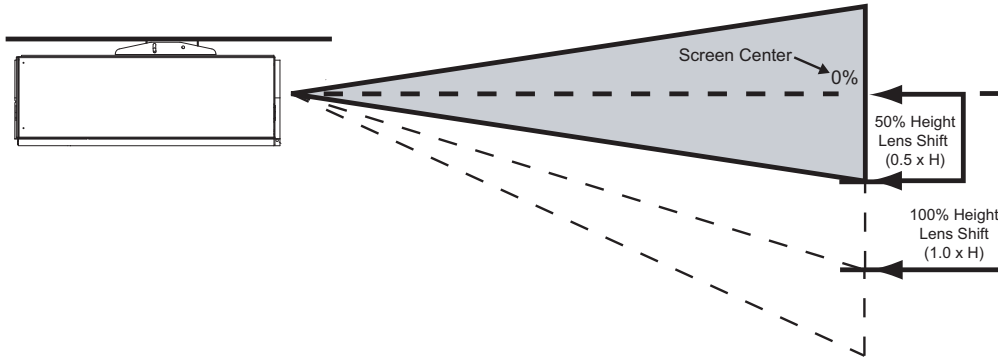

**Note:** This is a general example of lens shift. Lenses vary in their shift capabilities. **No particular lens or projector is used in this example.**

**Figure 3-4. Vertical Lens Shift (Example Only)**

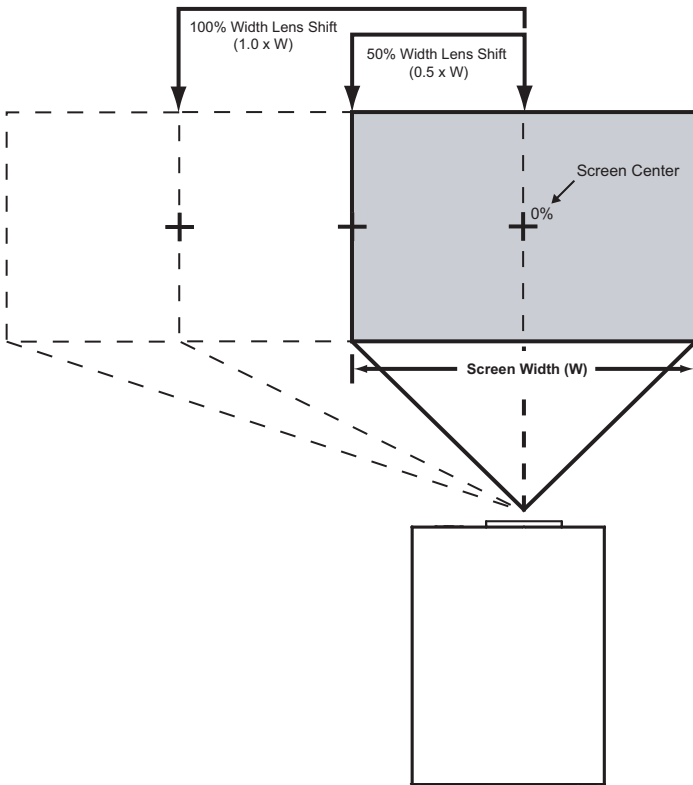

**Note:** This is a general example of lens shift. Lenses vary in their shift capabilities. **No particular lens or projector is used in this example.**

**Figure 3-5. Horizontal Lens Shift (Example Only)**

**Vertical Lens Shift:** The PD7170 provides up to 65% of vertical lens shift up or down. For example, with a 100 x 56 inch (1.78:1) screen, you can shift the image up to 36.40 inches (0.92 meters) above or below the screen center.

**Horizontal Lens Shift:** The PD7170 provides up to 30% of horizontal lens shift left or right. For example, with a 100 x 56 inch (1.78:1) screen, you can shift the image up to 30.00 inches (0.76 meters) left or right of the screen center.



**Note**

1. With no vertical or horizontal lens shift, the lens center and screen center are aligned with each other.
2. Vertical shift limits are percentages of the screen height. Horizontal shift limits are percentages of the screen width.
3. **Vertical lens shift figures are for ceiling mount configurations.** For floor installations (where the projector is upright), reverse the up/down vertical lens shift percentages.

**Folded Optics** ➤ In rear-screen applications where space behind the projector is limited, a mirror may be used to fold the optical path, as shown in Figure 3-6. The position of the projector and mirror must be accurately set. If you are considering this type of installation, contact your dealer for assistance.

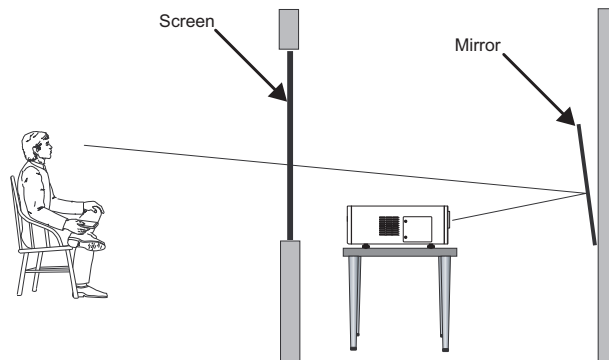

**Figure 3-6. Folded Optics**

- Other Considerations** ➤ Other considerations and tips that can help improve your installation:
- Keep the ambient temperature constant and below 35°C (95°F). Keep the projector away from heating and/or air conditioning vents. Changes in temperature may cause drifts in the projector circuitry, which may affect performance.
  - Keep the projector away from devices that radiate electromagnetic energy such as motors and transformers. Common sources of these include slide projectors, speakers, power amplifiers and elevators.

The PD7170 is shipped with the standard (1.82 – 2.28) projection lens pre-installed. If your installation requires a different lens, proceed as follows to remove the standard lens and replace it with the required one.

### 3.4 Lens Replacement

1. Using a Phillips screwdriver, remove the two screws holding the projector front cover in place.

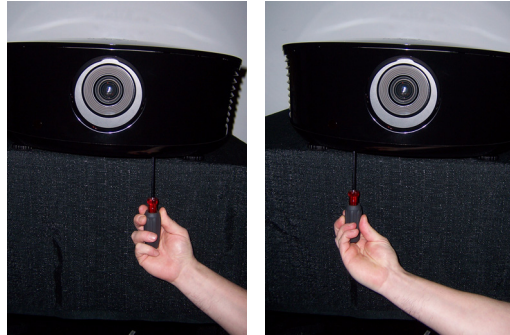

2. Gently pull the cover away from the projector at each side to detach it.

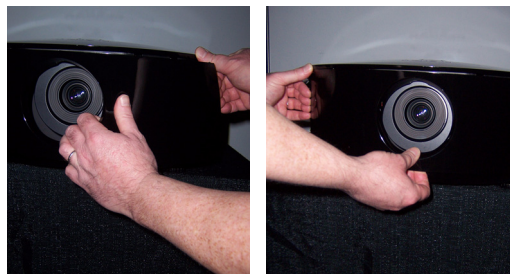

3. Remove the cover and set it aside.



4. Locate the lens release lever, above the lens cavity.



5. Press and hold the lens release button. Then, grasp the lens by the front and rotate it counterclockwise until it stops (approximately 30 degrees).

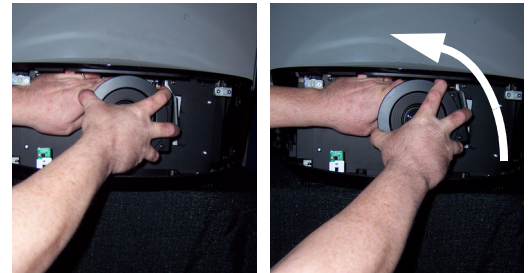

6. Pull the lens straight out to remove it.



7. Remove the trim ring attached to the motor housing on the lens you just removed. To do this, remove the two screws and two metal clips that hold it in place.

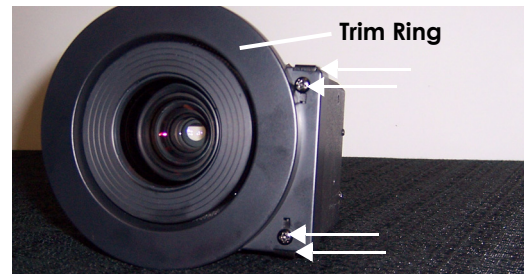

8. Attach the trim ring to the motor housing on the new lens.
9. Note that the lens mount flange has a female socket connector for the lens motor on the right side of the flange. (The lens assembly motor has a male socket connector that mates with this connector.)

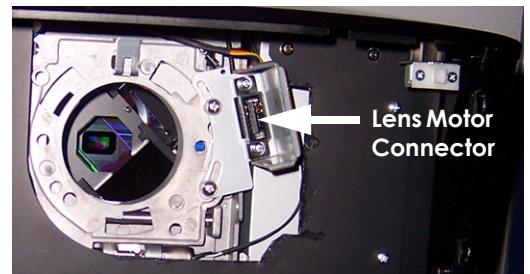

10. Hold the replacement lens assembly with the motor facing to the right. **Carefully** insert the back of the lens assembly into the hole in the lens flange.
11. Slightly rotate the lens assembly counterclockwise to align the motor connectors on the lens and lens flange. Gently push the lens assembly in until it is seated flush against the flange and the motor connectors have seated.
12. Carefully rotate the lens assembly clockwise until it stops and the metal clips at the back of the lens "click" into place.
13. Replace the projector front cover.

There are several methods for mounting the projector. Depending on your chosen installation, one method may be more suitable than another.

In typical front and rear screen installations, the projector can be mounted to a secure and level surface such as a table or cart. Carts are useful when moving a projector during a presentation or from site to site. If possible, lock the wheels when it's in position to prevent it from being moved during a presentation.

For fixed installations, and for those that want the projector out of sight or have a limited space for projector and audience, you can invert the PD7170 and suspend it from the ceiling using a specially-designed ceiling mount fixture.

**Note**

*Use only the Planar-approved ceiling mount kit designed for your projector. Install the mount kit according to the instructions provided with it.*

If the screen is significantly higher or lower than the projector, you can also tilt the projector at a slight angle. In a ceiling installation, you do this by adjusting the ceiling mount.

For a floor installation, turn the adjustable feet at the bottom of the projector to adjust the projection angle.

If you do this, you may need to vertically shift the image to compensate. For detailed instructions, refer to **Lens Adjustments** on page 31.

Proceed as follows to connect the PD7170 to your video sources, external controller(s) – if present – and AC power.

When connecting your equipment:

- Use the correct signal cables for each source.
- Ensure that the cables are securely connected. Tighten the thumbscrews on connectors that have them.

---

**3.5****Mounting the PD7170****◀ Floor Mounting (Upright)****◀ Ceiling Mounting (Inverted)****◀ Adjusting the Projection Angle**

---

**3.6****Connections to the PD7170**

**Connector Panel Access** ➤ Using a flat-blade screwdriver, loosen the four screws holding the rear compartment cover in place.

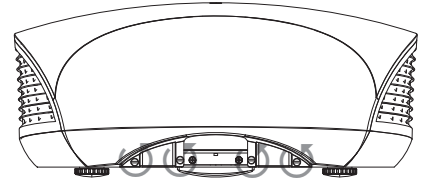

Then, remove the rear compartment cover by tilting it upward.

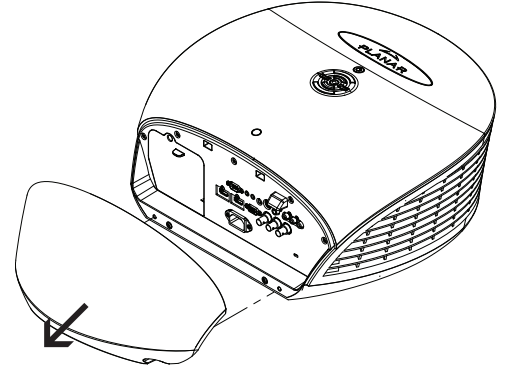

Connect your video sources to the PD7170 as shown and described in the sections that follow.

◀ **Connecting Source Components to the PD7170**

**HDMI/DVI Connections:** See Figure 3-7.



**Tip**

Use the HDMI inputs whenever possible. This ensures the highest video quality because the signal is carried in the digital domain throughout the entire signal path, from source component output into the projector.

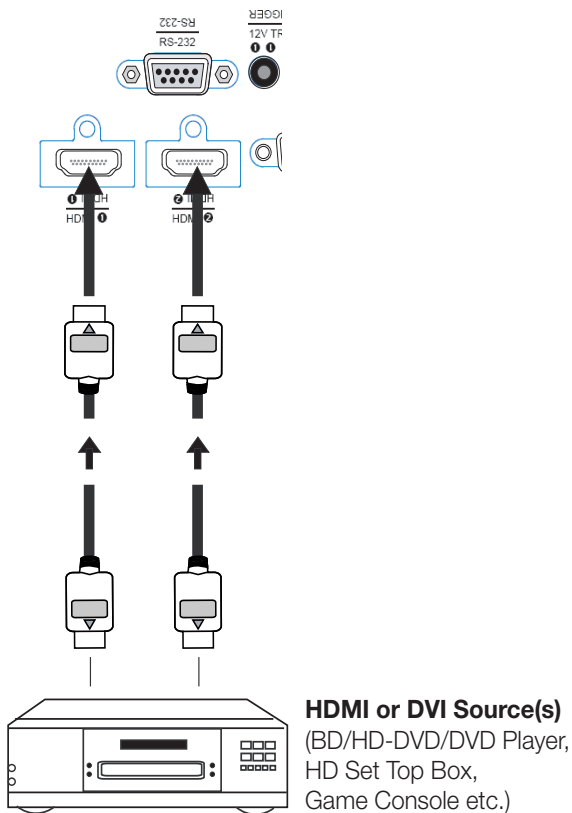

**Figure 3-7. HDMI/DVI Source Connections**



**RGB Connections:** Connect your personal computer or other RGB source to the **RGB** input.

Optionally, if the source outputs RGB with composite sync, connect the green, blue and red outputs to the Y, Pb and Pr terminals on the **COMPONENT 1/SCART** input and the sync output to the **VIDEO** input.

See Figure 3-8.

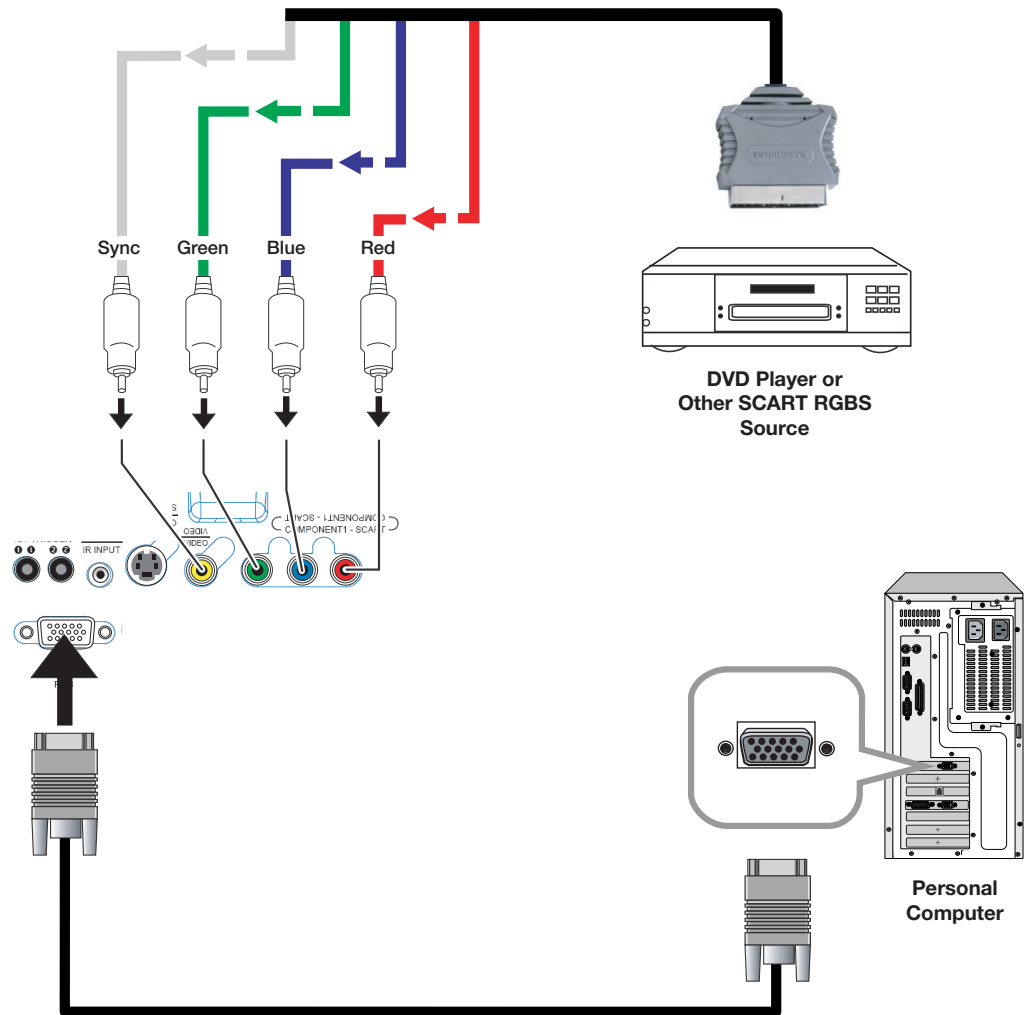
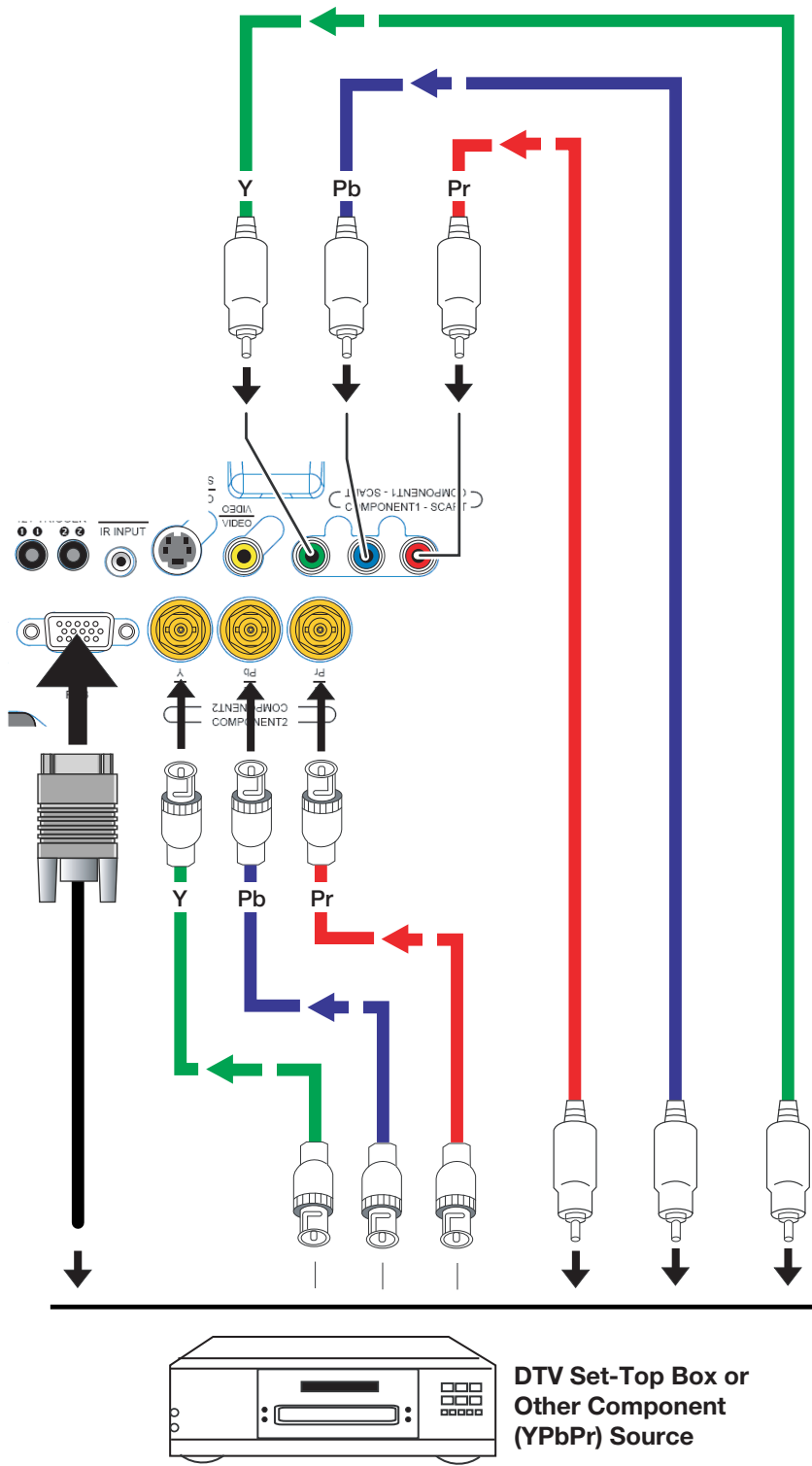

Figure 3-8. RGB Connections

**Component Video Connections:** Connect your component video sources to the **COMPONENT 1/SCART**, **COMPONENT 2** or **RGB** inputs as shown in Figure 3-9.



**Figure 3-9. Component Video Connections**

**Composite/S-Video Connections:** Connect your Composite and S-Video sources to the PD7170 as shown in Figure 3-10.

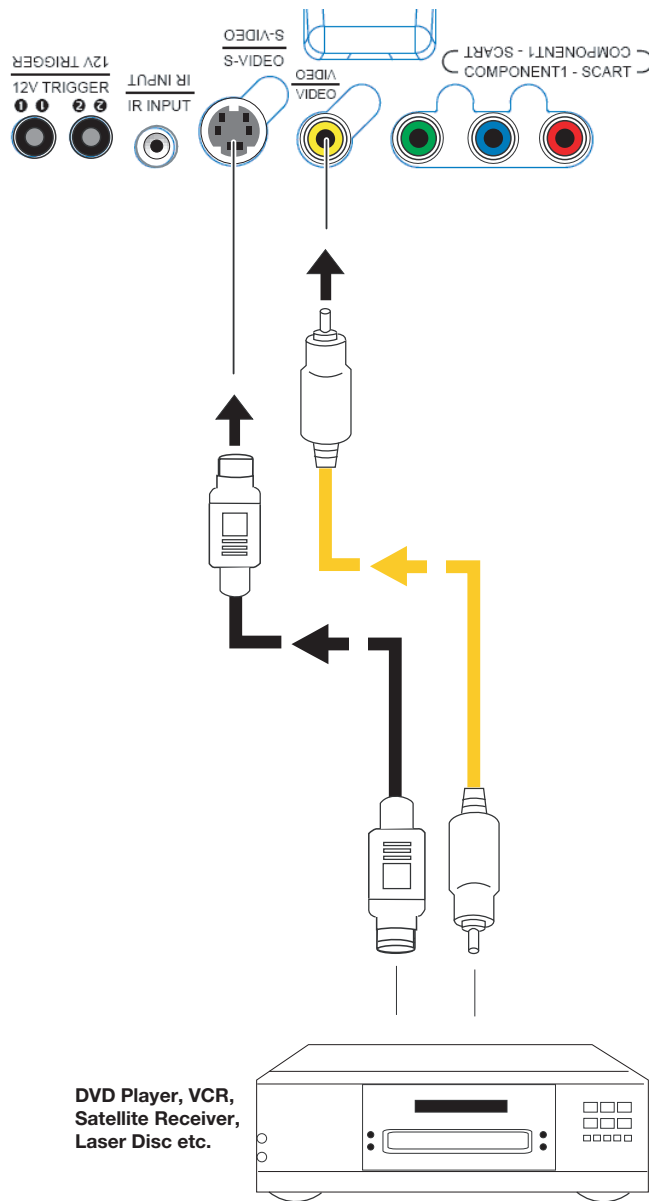
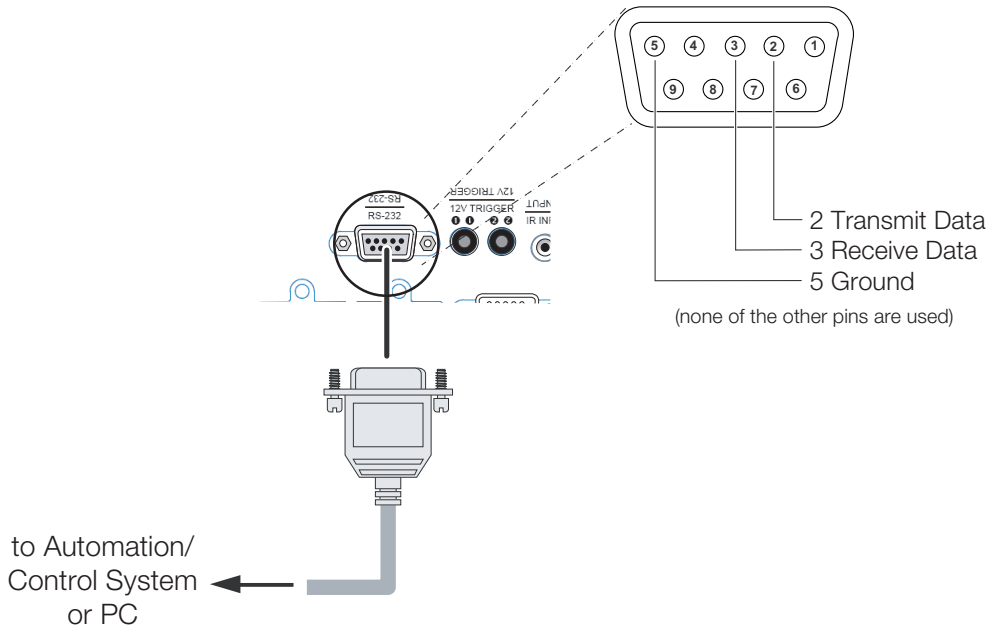

**Figure 3-10. Composite and S-Video Connections**

Connect a PC or home theater control/automation system (if present) to the RS-232 port on the PD7170; see Figure 3-11. Use a standard, 9-pin serial cable, wired straight-through.

◀ **RS-232 Controller Connection**

For more information about using this connection, refer to **Serial Communications** on page 69.



**Figure 3-11. RS-232 Control System Connection**

**Connecting 12-Volt Trigger Output to External Theater Equipment**

If your home theater contains a retractable screen, screen mask or other 12-volt trigger-activated equipment, connect it to the 12-volt trigger output(s) as shown in Figure 3-12.

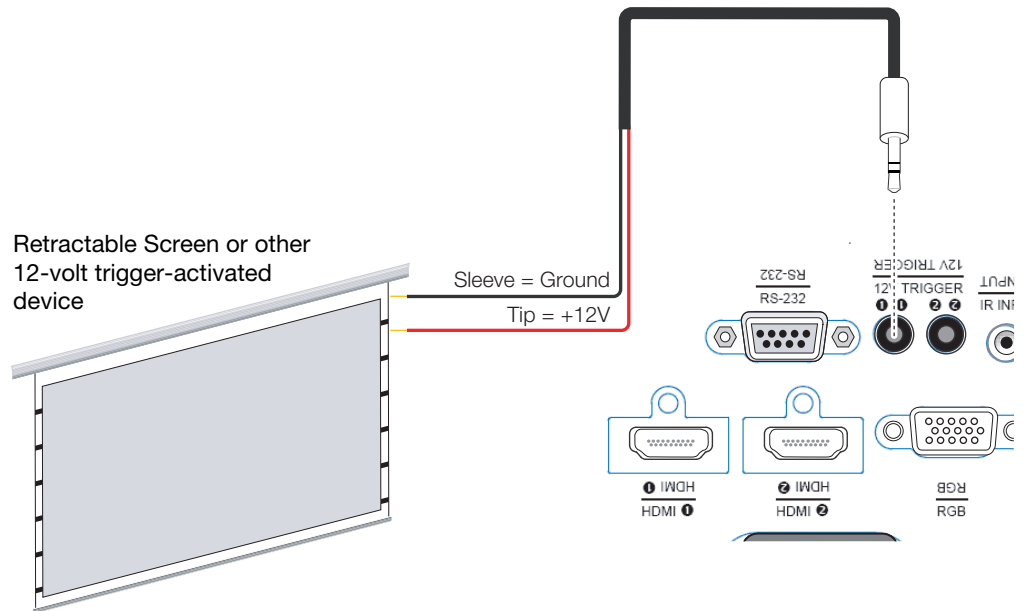

**Figure 3-12. 12-Volt Trigger Output Connection**

**Connecting an External IR Receiver**

If infrared signals from the remote control cannot reach the projector due to excessive distance or obstructions such as walls or cabinet doors, you can connect an external IR repeater system to the IR INPUT on the PD7170 to extend the range of the remote control. See Figure 3-13.

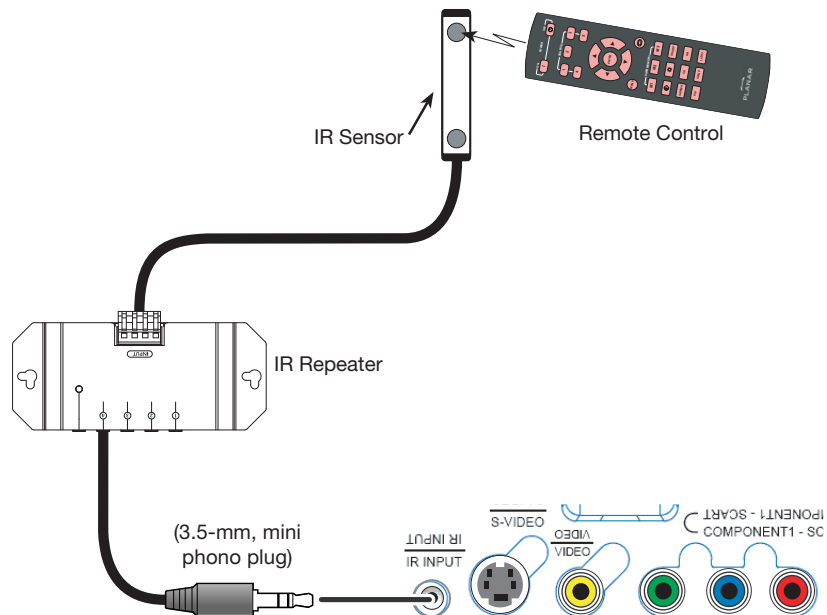

**Figure 3-13. External IR Receiver Connection**

The PD7170 ships with various types of AC power cords. Choose the one that is appropriate to your locale.

Plug the female end of the power cord into the AC receptacle on the rear of the projector (AC 100V ~ 240V); see Figure 2-3. Then, connect the other end to your AC power source.

1. Turn on your source components.
2. Press the **ON**  button on the remote control to turn on the PD7170. The LED flashes green to indicate that it is warming up.
3. When the projector is ready for use, the LED turns off.

The PD7170 gives you a great deal of control over the picture size, position and focus.

To access the motorized lens focus control, do either of the following:

- Press **MENU** on the remote control. Select Control from the Main Menu, then press **▲** or **▼** to highlight Lens Control. Press **◀** or **▶** to highlight Focus and press **ENTER**.
- When no menu is present on-screen, press **ENTER** () on the system keypad or remote control unit.

Then, use the **▲** button to focus the projected image nearer or the **▼** button to focus the projected image farther away.

To access the motorized lens zoom control, do either of the following:

- Press **MENU** on the remote control. Select Control from the Main Menu, then press **▲** or **▼** to highlight Lens Control. Press **◀** or **▶** to highlight Zoom and press **ENTER**.
- When no menu is present on-screen, press **ENTER** () on the system keypad or remote control unit **twice**.

Then, use the **▲** button to make the picture larger (zoom in) or the **▼** button to make the picture smaller (zoom out).

To access the motorized lens shift control, do either of the following:

- Press **MENU** on the remote control. Select Control from the Main Menu, then press **▲** or **▼** to highlight Lens Control. Press **◀** or **▶** to highlight Lens Shift and press **ENTER**.
- When no menu is present on-screen, press **ENTER** () on the system keypad or remote control unit **three times**.

Then, use the **▲** and **▼** buttons to adjust the vertical lens position or the **◀** and **▶** buttons to adjust the horizontal lens position.

## ◀ Connecting to AC Power

## 3.7 Turning on the Power

## 3.8 Lens Adjustments

### ◀ Focus

### ◀ Zoom

### ◀ Lens Shift

**Installing the Optional Stray Light Shield:** For installations that require significant vertical lens shift (50% or more of the screen height), a lens shield is provided with the PD7170 that minimizes stray light around the image.

The light shield attaches to threads at the end of the lens. Or, if you have installed a lens filter, you can attach the light shield to it.

To install or remove the light shield, squeeze the two side "wings" to snap it into place or release it.

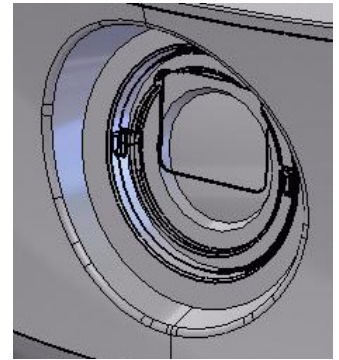

**Caution**

*Do not use the stray light shield unless the amount of vertical lens shift exceeds 50 per cent of the screen height.*

### 3.9 Changing the OSD Language

When you turn on the PD7170 for the first time, the OSD Language Menu appears.

The PD7170 can display the menus in English, French, German, Italian, Spanish, Swedish, Traditional Chinese, Simplified Chinese, Japanese, Korean, Portuguese or Russian.



Press ▲ or ▼ to select a language. Then, press **ENTER** to confirm your selection.

---

If the PD7170 is installed behind the screen, you must change the picture orientation to match the installation method. To do this, press **MENU** on the remote control. Then, select System from the Main Menu.

If the projector is used in a rear-projection application (see Figure 3-6), press ▼ repeatedly to select Rear Projection from the System Menu. Press ◀ or ▶ to set it to **On**.

If the projector is ceiling-mounted, the PD7170 automatically inverts the image. If this automatic inversion is not desired, select Ceiling Mode from the System Menu and set it to **Off**.

---

### 3.10 Adjusting the Picture Orientation

◀ **Rear Projection**

◀ **Ceiling Mode**





**Notes:**

# Operation

Press **M1**, **M2** or **M3** to recall settings from a memory preset. Then, press **ENTER** to confirm your selection. Or, to cancel the operation, press **▶** to select **Cancel** and press **ENTER**.

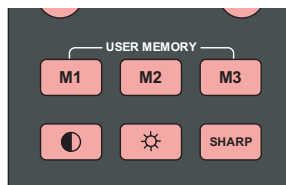
You can assign each of these three buttons to any of four memory presets. For more information, refer to **M1 Key / M2 Key / M3 Key** on page 59.



Press the aspect ratio (  ) button to select the appropriate aspect ratio for the type of program material being viewed. For more information, refer to Table 4-2.

When you turn on the PD7170, it switches to the last selected input and looks for a valid signal.

Use these buttons on the remote control to select an input source directly. You can assign each of these five buttons to any input. The default assignments are: 1 = HDMI 1, 2 = HDMI 2, 3 = Component 1, 4 = S-Video, 5 = Video.

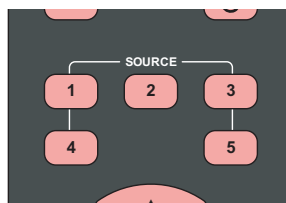

For more information, refer to **1 Key / 2 Key / 3 Key / 4 Key / 5 Key** on page 59.

## 4.1 Selecting Video Memory

## 4.2 Selecting an Aspect Ratio

## 4.3 Selecting An Input Source

## 4.4 Using Picture-In-Picture (PIP)

For PIP purposes, there are three groups of inputs separated by their display modes:



- **Video (SD) group:** Video, S-Video and SCART inputs.
- **Graphic (HD) group:** Component 1, Component 2 and RGB inputs.
- **Digital Video group:** HDMI 1 and HDMI 2 inputs.

PIP shows one input from any of these groups within or beside one input from either of the other two groups.

- Press **PIP** to enable the PIP function. Once enabled, press **PIP** repeatedly to select the desired PIP source or turn PIP off.
- Press **SWAP** to swap the main and PIP images.

For more information, refer to **PIP Position** on page 57.

For each source, Table 4-1 shows which of the other sources are available as a PIP source.

**Table 4-1. Available Main and PIP Source Combinations**

		PIP Input Source							
		VIDEO	S-VIDEO	SCART	COMP 1	COMP 2	RGB	HDMI 2	HDMI 1
Main Input Source	VIDEO	-	-	-	✓	✓	✓	✓	✓
	S-VIDEO	-	-	-	✓	✓	✓	✓	✓
	SCART	-	-	-	✓	✓	✓	✓	✓
	COMP 1	✓	✓	✓	-	-	-	✓	✓
	COMP 2	✓	✓	✓	-	-	-	✓	✓
	RGB	✓	✓	✓	-	-	-	✓	✓
	HDMI 2	✓	✓	✓	✓	✓	✓	-	-
	HDMI 1	✓	✓	✓	✓	✓	✓	-	-

Notes:

1. "✓" means that that source is available as a PIP source with a given main source; "-" means that it is not.
2. Disabled sources (refer to **Source Enable** on page 56) are not available as PIP sources.

- 
1. Press the **MENU** button on the remote control or system keypad to display the Main Menu.
  2. There are six menus. Press ◀ or ▶ to select a sub-menu.
  3. Press ▲ or ▼ to select a sub-menu item.
  4. For each sub-menu item, the currently-selected value appears in white text or is otherwise highlighted. Press ◀ or ▶ to choose a setting for that item, or press **ENTER** to go to another sub-menu.
  5. Press **MENU** to return to the previous menu.
  6. From the Main Menu, press **MENU** to turn off the OSD menu.

The PD7170 OSD menus are arranged hierarchically, as shown in Figure 4-1. Depending on the selected input source and signal characteristics, some menu options may not be available.

---

## 4.5 Using the On-Screen Menus

<b>Main</b>	Aspect Ratio	16:9, 4:3, Letterbox, 4:3 Narrow or Native
	Memory	Recall Memory
		Save Settings
		Save ISF
	Brightness	0 ... 50* ... 100
	Contrast	
	Color Saturation	
	Color Tint	
	Sharpness	
		Sharpness Mode (Simple or Advanced)
		Horizontal Sharpness
		Vertical Sharpness
		Diagonal Sharpness
		Sharpness Overshoot
		Horizontal Texture
		Vertical Texture
		Diagonal Texture
		Texture Overshoot
	Noise Reduction	Noise Reduction
		Noise Reduction Mode (Simple or Advanced)
General Noise Reduction		
Block Artifact Reduction		
Mosquito Noise Reduction		
Overscan	Off, Crop or Zoom	
Source Select	HDMI 1, HDMI 2, RGB, Comp. 1, Comp. 2, Video, S-Video or SCART	
PIP Select	Off, HDMI 1, HDMI 2, RGB, Comp. 1, Comp. 2, Video, S-Video or SCART	
Resync	(press ENTER to execute)	
<b>Advanced</b>	Color Space	Auto, REC709, REC601, RGB-PC or RGB-Video
	Video Standard	Auto, NTSC, PAL or SECAM
	Gamma	CRT, Film, Video, Bright or Graphics
	Color Temperature	5500K, 6500K, 7500K, 9300K or Native
	DLP Frame Rate	Auto, 48 Hz, 50 Hz or 60 Hz
	Color Gamut	Auto, REC709, SMPTE-C, EBU or Native
	DynamicBlack	On or Off
	Adaptive Contrast	On or Off
	RGB Adjust	Red / Green / Blue Offset
		Red / Green / Blue Gain
	Fine Sync	V. Position
		H. Position
		Phase
		Tracking
		Sync Level

<b>System</b>	Source Enable	On or Off for each source	
	PIP Position	Top Left, Top Right, Bottom Left, Bottom Right, Picture-by-Picture or Split Screen	
	Menu Position	Top Left, Top Right, Bottom Left, Bottom Right or Center	
	Translucent Menu	0% (opaque), 25%, 50% or 75%	
	Lamp Power	Economy or Standard	
	Blank Screen	Logo, Black, Blue or White	
	Auto Power Off	On or Off	
	Auto Power On		
	Rear Projection		
	Ceiling Mode	Auto, On or Off	
	Logo Display	On or Off	
	Power On Chime		
	<b>Control</b>	Lens Control	Focus, Zoom, Lens Shift
		1 Key	HDMI 1, HDMI 2, RGB, Comp. 1, Comp. 2, Video, S-Video or SCART
		2 Key	
3 Key			
4 Key			
5 Key			
M1 Key		User Memory 1, User Memory 2, ISF Day or ISF Night	
M2 Key			
M3 Key			
Trigger 1		Lamp, 16:9, Letterbox, 4:3, 4:3 Narrow or RS-232	
Trigger 2			
Change Remote Code	Set 1 or Set 2		
Auto Source	On or Off		
<b>Language</b>	English, French, German, Italian, Spanish, Swedish, Traditional Chinese, Simplified Chinese, Japanese, Korean, Portuguese or Russian		
<b>Service</b>	Model Name	(read-only)	
	Unit Serial Number		
	Software Version		
	Active/PIP Source		
	Pixel Clock		
	Signal Format		
	H/V Refresh Rate		
	Lamp Hours		
	Lamp Hour Reset	Reset? (Yes or No)	
	Factory Reset	Reset Everything? (Yes or No)	
	Blue Only	On or Off	
	Test Patterns	On or Off	
Altitude	Auto or High		

Figure 4-1. PD7170 OSD Menu Structure

The PD7170 Main Menu, shown in Figure 4-2, provides access to the most commonly-used projector functions.

◀ Main



**Note**

1. For best results, Planar recommends that you set DynamicBlack to **Off** before adjusting Brightness, Contrast and other image quality settings in this menu (refer to **DynamicBlack** on page 52). After you have completed the initial calibration, set DynamicBlack to **On** if desired.
2. Image controls only operate on the active source. To adjust the PIP source, switch to the PIP source (thereby making it the active source), adjust the controls and then switch back.

MAIN	ADVANCED	SYSTEM	CONTROL	LANGUAGE	SERVICE
Aspect Ratio	16:9	Letterbox	4:3	4:3-Narrow	Native
Memory				Enter	
Brightness				100	
Contrast				100	
Color Saturation				100	
Color Tint				100	
Sharpness				Enter	
Noise Reduction				Enter	
Overscan		OFF		Crop	Zoom
Source Select				Enter	
PIP Select				Enter	
Resync				Enter	

Menu = Exit
Menu Select ◀▶
Scroll ▲▼

**Figure 4-2. PD7170 Main Menu**

**Aspect Ratio:** To change the aspect ratio (size and shape) of the projected image, press ▲ or ▼ to highlight Aspect Ratio. Use the ◀ or ▶ buttons to select the appropriate aspect ratio for your screen size, installed lens configuration and the type of program material being viewed, then press **ENTER**; refer to Table 4-2.

**Table 4-2. Aspect Ratio Settings**

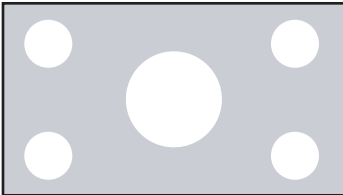
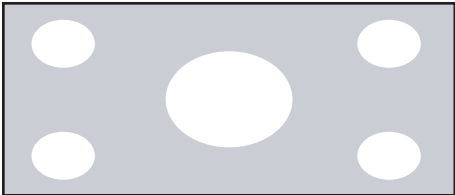
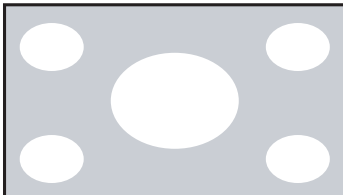
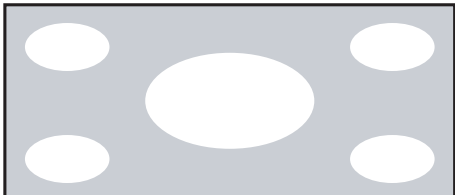
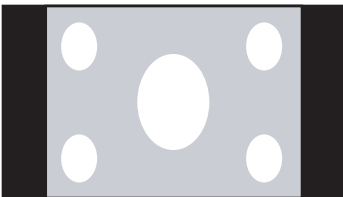
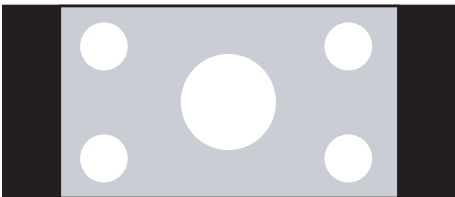
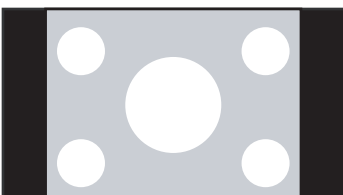
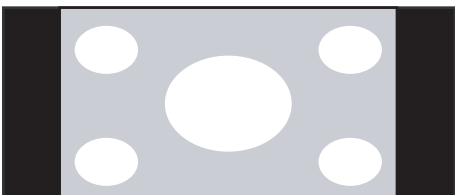
Aspect Ratio Setting	Description	Aspect Ratio of Source Signal	Geometry of Projected Image	
			With Standard Lens (1.78:1 Screen)	With Anamorphic Lens (2.35:1 Screen)
<b>16:9</b>	16:9 linearly scales the source active image horizontally and vertically to fill a 16:9 screen.	16:9		
		4:3		
<b>4:3</b>	4:3 linearly scales the source active image horizontally and vertically to fill a 4:3 screen.	16:9		
		4:3		

**Table 4-2. Aspect Ratio Settings (continued)**

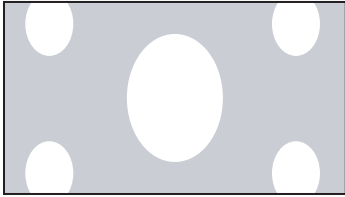
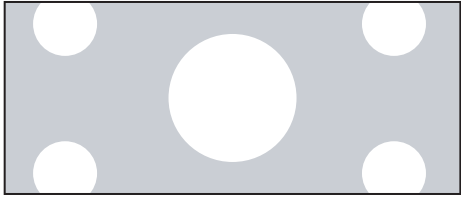
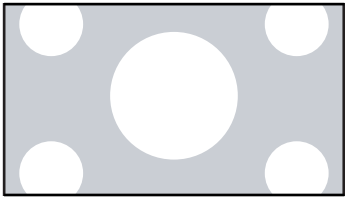
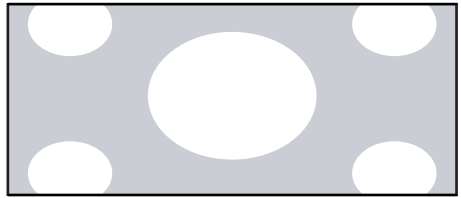
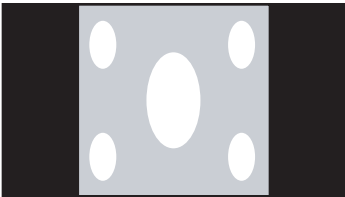
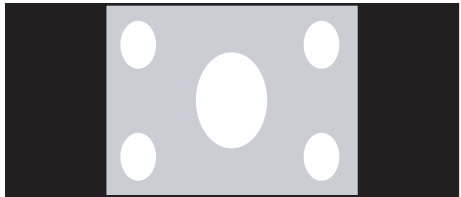
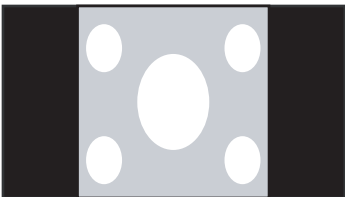
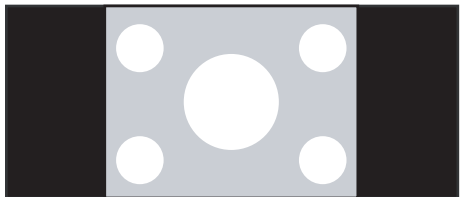
Aspect Ratio Setting	Description	Aspect Ratio of Source Signal	Geometry of Projected Image	
			With Standard Lens (1.78:1 Screen)	With Anamorphic Lens (2.35:1 Screen)
<b>Letterbox</b>	Letterbox mode scales (zooms in on) a 4:3 image linearly (by the same amount on all sides) to fill a 16:9 display, cropping the top and bottom of the image.	16:9		
		4:3		
<b>4:3 Narrow</b>	4:3 Narrow linearly scales the source active image horizontally, so that a 4:3 source has the correct aspect ratio when using an anamorphic lens.	16:9		
		4:3		



**Table 4-2. Aspect Ratio Settings (continued)**

Aspect Ratio Setting	Description	Aspect Ratio of Source Signal	Geometry of Projected Image	
			With Standard Lens (1.78:1 Screen)	With Anamorphic Lens (2.35:1 Screen)
<b>Native</b>	<p>Select Native to display the source signal in its native resolution, centered in the display area with no re-sizing or overscan.</p> <p>With SDTV and EDTV sources, the PD7170 scales the image horizontally to achieve a 16:9 aspect ratio.</p>	16:9		
		4:3		

**Memory:** Select Memory from the Main menu, then press **ENTER** to recall image quality settings previously saved, or to save changed settings in any of four memory locations.

- **Recall Memory:** Select Recall Memory from the Memory menu to recall saved image quality settings. Unless you select **Default** (see below), this control affects all sources, not just the active source.
  - **User Memory 1** and **User Memory 2** contain the factory default settings when the projector is initially turned on.
  - When you recall the **ISF Day** or **ISF Night** memory settings, all settings associated with these stored values are grayed out. This prevents unintended adjustments from being made. To remove this restriction, choose **User Memory 1** or **User Memory 2**.

**ISF Day** and **ISF Night** are grayed out unless these custom settings have already been saved.

- Choose **Default** to restore the factory-default settings for the active source only. The other sources are unaffected.
- **Save Settings:** Select Save Settings from the Memory menu to save any image-related settings you have changed to **User Memory 1** or **User Memory 2**.

The following items are saved (for **all** sources, not just the active source):

- Brightness / Contrast
- Color Saturation / Color Tint
- Sharpness (all settings in sub-menu)
- Noise Reduction (all settings in sub-menu)
- Color Space
- Video Standard
- Gamma
- Color Temperature
- DLP Frame Rate
- Color Gamut
- DynamicBlack
- Adaptive Contrast
- RGB Adjust (all settings in sub-menu)
- Lamp Power
- **Save ISF:** Select Save ISF from the Memory menu to save any image-related settings you have changed to the **ISF Day** or **ISF Night** memory location.



### Note

**You must enter a passcode to access the Save ISF sub-menu.**

The settings that are saved are the same as those saved with the **Save Settings** command (see above).

**Brightness:** On your external test pattern source, select a PLUGE pattern. (PLUGE is an acronym for “Picture Line-Up Generation Equipment.”) Figure 4-3 shows a typical PLUGE pattern.

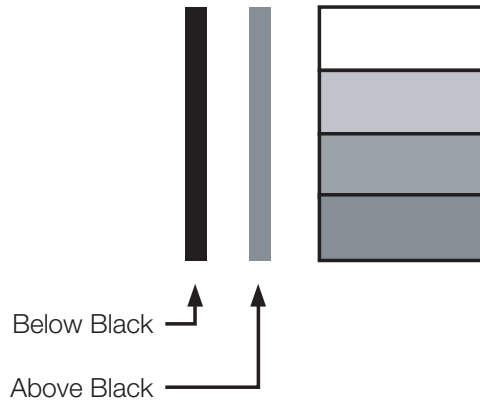

**Figure 4-3. Typical PLUGE Pattern for Adjusting Brightness**

PLUGE patterns vary but generally consist of some combination of black, white and gray areas against a black background. The example above includes two vertical bars and four shaded boxes.

Select Brightness from the Main menu. Use the ◀ or ▶ buttons to adjust the level so that:

- The darkest black bars disappear into the background.
- The dark gray areas are barely visible.
- The lighter gray areas are clearly visible.
- The white areas are a comfortable level of true white.
- The image contains only black, gray and white (no color).

**Contrast:** On your external test pattern source, select a stepped, gray-bar pattern like the one shown in Figure 4-4.



**Figure 4-4. Typical Gray Bar Pattern for Adjusting Contrast**

Select Contrast from the Main menu. Use the ◀ or ▶ buttons to adjust the contrast up until the top two bars become almost the same brightness, then down just until the brightness change between these bars is consistent with the other bars.

**Note**

*Brightness and Contrast controls are interactive. A change to one may require a subtle change to the other in order to achieve the optimum setting.*

**Color Saturation:** To adjust the overall color intensity, select Color Saturation from the Main menu. Decrease this setting if colors are overly saturated; increase it if colors appear muted or washed out.

**Color Tint:** Tint or "hue" is the ratio of red to green in the color portion of the image. To adjust the tint, select Color Tint from the Main menu. Decrease this setting to shift the hue toward red; increase it to shift the hue toward green.

**Note**

*Like the Brightness and Contrast controls, the color and tint controls are interactive. A change to one may require a subtle change to the other in order to achieve the optimum setting.*

**Sharpness:** "Sharpness" is the amount of high-frequency detail in the image. To adjust this, select Sharpness from the Main menu and press **ENTER**. On your external test pattern source, select a pattern like the one shown in Figure 4-5.

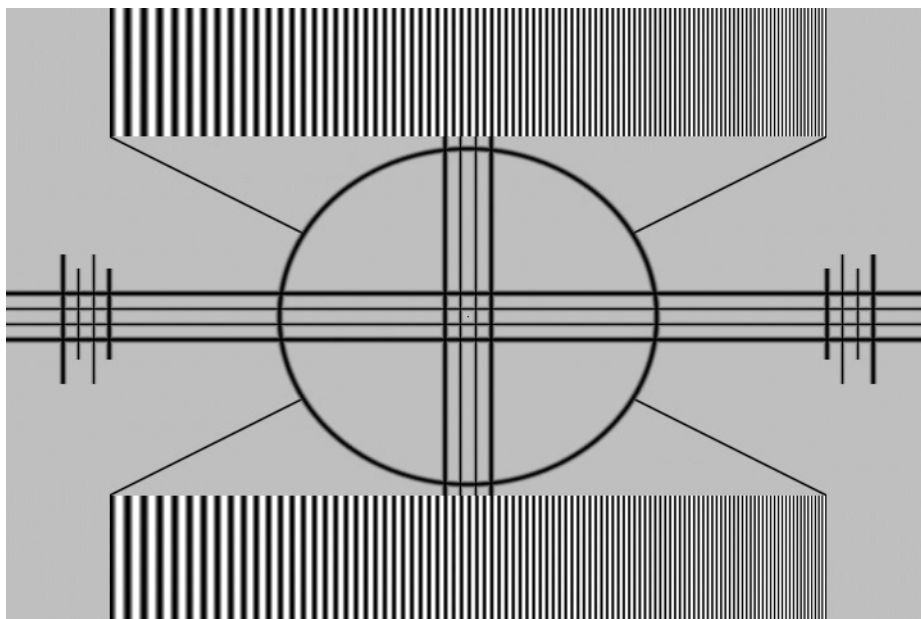

**Figure 4-5. Typical Test Pattern for Adjusting Sharpness**

- **Sharpness (Simple Mode):** Adjust as needed, looking for white edges around the transitions from black to gray and differently-sized lines in the "sweep" patterns at the top and bottom. Lower the sharpness setting to eliminate them.

- **Sharpness Mode:** Sharpness Mode allows or prevents access to the detailed sharpness controls in this menu.

In most cases, **Simple** mode provides a sufficient level of control to produce the best picture from the most popular sources. In Simple mode, only the Sharpness (top-most) slider is adjustable; the others are grayed out.

Choose **Advanced** mode if you need more precise control over sharpness. In Advanced mode, **only** the top slider is grayed out.

- **Horizontal Sharpness / Vertical Sharpness / Diagonal Sharpness:** Use these controls to enhance image detail along horizontal, vertical and diagonal edges respectively.
- **Sharpness Overshoot:** Use the Sharpness Overshoot control to minimize or eliminate rings or shadows on dominant edges that cannot be removed using the “simple” Sharpness control.
- **Horizontal Texture / Vertical Texture / Diagonal Texture / Texture Overshoot:** Use these controls to remove artifacts from textured areas that cannot be removed using the “simple” Sharpness control.
- **Noise Threshold:** The Noise Threshold setting adjusts the frequency below which the Sharpness controls have an effect. Frequencies above the threshold are considered “noise.”

Generally, the higher the setting, the more noticeable the effect of any adjustments will be.

**Noise Reduction:** To apply noise reduction to the source signal, select Noise Reduction from the Main menu and press **ENTER**. Noise Reduction is useful for clearing up noisy images from interlaced SD sources.

- **Noise Reduction (Simple Mode):** Use the ◀ or ▶ button to adjust as desired, keeping in mind that reducing noise (which reduces high frequencies) may also soften the image.
- **Noise Reduction Mode:** Noise Reduction Mode allows or prevents access to the detailed noise reduction controls in this menu.

In most cases, **Simple** mode provides a sufficient level of control to produce the best picture from the most popular sources. In Simple mode, only the Noise Reduction (top-most) slider is adjustable; the others are grayed out.

Choose **Advanced** mode if you need more precise control over noise reduction. In Advanced mode, **only** the top slider is grayed out.

- **General Noise Reduction:** General Noise Reduction is temporal and spatial noise reduction for all types of inputs. The scene is analyzed for differences from frame to frame and reduces those differences that are not determined to be motion.
- **Block Artifact Reduction:** Use this control to reduce or eliminate so-called “block artifacts” in MPEG-compressed video signals (digital broadcasts or DVDs). Set it as needed to minimize distortion within horizontal and vertical block boundaries.
- **Mosquito Noise Reduction:** Use this control to reduce or eliminate so-called “mosquito noise” in MPEG-compressed video signals. Set it as needed to minimize distortion around the edges of moving objects, moving artifacts around edges and/or blotchy noise patterns superimposed over the objects.

**Overscan:** Some television programs are produced based on the assumption that older television sets may not display the outer edges of the broadcast picture area. Overscan effectively hides these inactive, outer edges of the image. Choose one of the following:

- **Off:** This setting leaves the image as-is.
- **Crop:** This setting adds a mask at the left and right edges of the source active image equal to 3% of the displayed horizontal resolution, and at the top and bottom edges equal to 3% of the displayed vertical resolution.
- **Zoom:** This setting adds a factor to the scaling of the source active image so that the vertical and horizontal resolutions are 106% of the size determined by the aspect ratio function. Anything outside of the original image area is removed.



**Note**

When the Aspect Ratio is set to **Native**, set Overscan to **Off** or **Crop**.

Figure 4-6 illustrates the effect of each overscan setting for each aspect ratio.

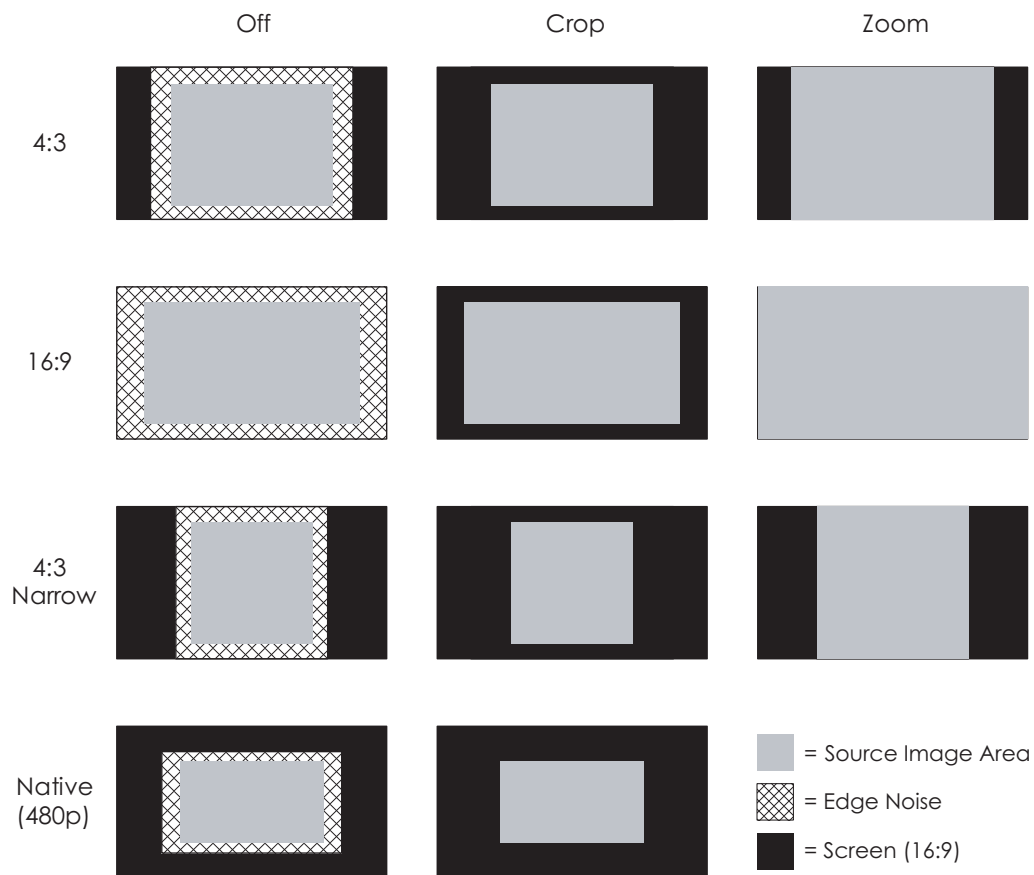

**Figure 4-6. Overscan Examples**

**Source Select:** To select a video source, press ▲ or ▼ to highlight Source Select, then press **ENTER**. This displays the Source Select sub-menu, shown in Figure 4-7.

The default source selection is **HDMI 1**. All sources that are not available per the source enable function (refer to **Source Enable** on page 56) are grayed out.

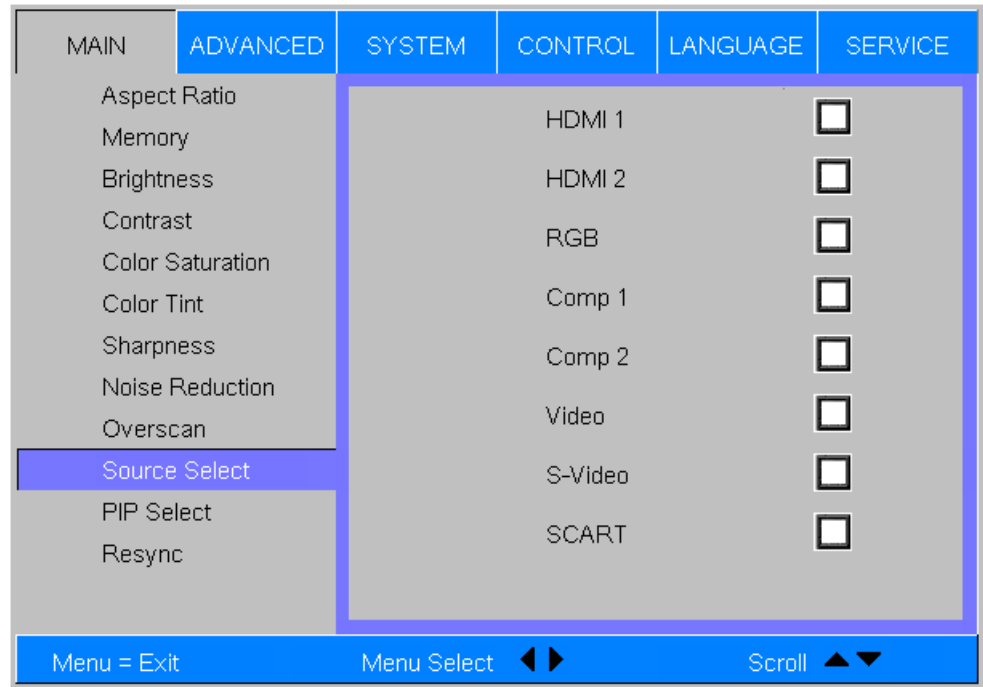

**Figure 4-7. Source Select Sub-Menu**

**PIP Select:** To select a PIP (secondary) video source, press ▲ or ▼ to highlight PIP Select, then press **ENTER**. The default PIP selection is **Off**.

All sources that are not available per the source enable function (refer to **Source Enable** on page 56) are grayed out.

All sources that cannot be used for PIP due to a shared electronic path with the Active source are grayed out. The PIP source is a saved setting for each source, like brightness and contrast.

If for some reason the current PIP source becomes invalid (by disabling it in the source enable menu, for instance), PIP Select automatically resets to **Off**.

**Resync:** If the projected image becomes unstable or degraded, press ▲ or ▼ to highlight Resync, then press **ENTER**. This causes a re-acquisition of the active source and the PIP source, if present. It also changes any Fine Sync settings (described on page 53) for this timing to the default setting.

Use the controls in the Advanced menu, shown in Figure 4-8, to perform advanced image adjustments.

◀ **Advanced**

MAIN	ADVANCED	SYSTEM	CONTROL	LANGUAGE	SERVICE
	Color Space	Auto	REC709	REC601	RGB-PC RGB-Video
	Video Standard	Auto	NTSC	PAL	SECAM
	Gamma	CRT	Film	Video	Bright Graphics
	Color Temperature	5500K	6500K	7500K	9300K Native
	DLP Frame Rate	Auto	48HZ	50HZ	60HZ
	Color Gamut	Auto	REC709	SMPTE-C	EBU Native
	Dynamic Black	ON		OFF	
	Adaptive Contrast	ON		OFF	
	RGB Adjust			Enter	
	Fine Sync			Enter	

Menu = Exit
Menu Select ◀▶
Scroll ▲▼

**Figure 4-8. PD7170 Advanced Menu**

**Color Space:** Select Color Space from the Advanced menu to choose the color space of the source signal for HDMI, RGB, and component connections.

- The default setting, **Auto**, functions as follows:
  - **HDMI:** If the Auxiliary Video Information (AVI) infoframe contains color space and/or range data, the PD7170 uses that information. Otherwise, for RGB sources, the PD7170 uses the **RGB-PC** color space. For component SDTV and EDTV resolutions, **REC601** is used. For other component video resolutions, **REC709** is used.
  - **RGB:** If Hsync or Vsync signals are present, the PD7170 uses the **RGB-PC** color space. Otherwise, **REC601** is used for SDTV and EDTV sources, and **REC709** for all other sources.
  - **Component:** For SDTV and EDTV resolutions, the PD7170 uses the **REC601** color space. For all other resolutions **REC709** is used.

In most cases, the **Auto** setting determines the correct color space to use. If it does not, you can force the PD7170 to use a specific color space. Choose one of the following:

- **REC709** sets the color space matrix to that defined in ITU-R BT.709.
- **REC601** sets the color space matrix to that defined in ITU-R BT.601.
- **RGB-PC** uses RGB color space and sets black at 0,0,0 RGB and white at 255,255,255 RGB, assuming an 8-bit image.



- **RGB-Video** uses RGB color space and sets black at 16,16,16 RGB and white at 235,235,235, assuming an 8-bit image, to correspond to the luminance values defined in digital component standards.

**Video Standard:** Select Video Standard from the Advanced menu to specify the color system for composite video or S-Video input signals.

Different countries use different formats for video signals. Select the appropriate Video Standard for your region:

- **Auto:** The color systems are automatically identified and the format is set accordingly.
- **PAL:** This is the standard used in Europe, Australia and many other parts of the world, typically with a 50Hz frame rate.
- **SECAM:** This is a standard format used mainly in France and Russia.
- **NTSC:** This is the standard format used mainly in the United States and Japan.

**Gamma:** Select Gamma from the Advanced menu to choose a DLP de-gamma curve. Used correctly, the Gamma control can improve contrast while maintaining good details for blacks and whites.

If excess ambient light washes out the image and it becomes difficult or impossible to see details in dark areas, lower the gamma setting to compensate. This improves contrast while maintaining good details for blacks. Conversely, if the image is washed out and unnatural, with excessive detail in black areas, increase the setting.

- **CRT** sets the gamma to 2.5.
- **Film** sets the gamma to 2.2.
- **Video** is similar to Film gamma but differs in dark areas of the image to correspond to the function that video cameras use to create images.
- **Bright** sets the gamma to 2.0.
- **Graphics** should only be used for computer presentations that require increased brightness at the cost of grayscale accuracy.

**Color Temperature:** Color temperature defines the "color of gray;" that is, adjusts the 75% white point to various color points.

To choose a color temperature setting, select Color Temperature from the Advanced menu. Then, press ◀ or ▶ to select 5500K, 6500K, 7500K, 9300K or Native. The default setting, 6500K, is appropriate for most situations. Higher settings produce a "bluer" picture; lower ones impart a reddish hue to the image. Select **Native** to disable white point adjustment of the source signal.

**DLP Frame Rate:** Select DLP Frame Rate from the Advanced menu to choose the output frame rate. You can have the PD7170 automatically determine the optimum frame rate, or you can force it to use a specific frame rate.



**Note**

*If PIP is active, the PD7170 converts the PIP source frame rate to the same frame rate as the main source.*

- The default setting, **Auto**, frame locks to the main source if it has a vertical refresh rate of between 48 and 62Hz. Vertical refresh rates of from 24 to 31Hz are doubled. Frame rates between 31 and 48Hz and greater than 62Hz are converted to 60Hz.
- Select **48Hz** to force the output frame rate to 48Hz. Use this setting to eliminate 2:3 pull-down judder with 60Hz film-based sources.
- **50Hz** and **60Hz** force the output frame rate to 50Hz and 60Hz respectively.

**Color Gamut:** Select Color Gamut from the Advanced menu to select a color gamut (range) that may be different from the default color gamut.

Each setting defines the precise hue of each primary (red, green and blue) and secondary (yellow, cyan and magenta) color component used to generate the millions of colors produced in displays. Changing either or both of these numbers changes the hue of the color and relocates the “triangle” for possible colors. For example, changing the x/y coordinates for red moves the color closer to either orange or violet, which in turn affects all displayed colors having a red component.

- **Auto** automatically chooses the appropriate color gamut:
  - **SMPTE C** for NTSC, 480i and 480p sources.
  - **EBU** for PAL, SECAM, 576i and 576p sources.
  - **REC709** for all other sources.
- **REC709** chooses the REC709 color gamut.
- Select **SMPTE-C** to choose the SMPTE-C color gamut.
- Select **EBU** to choose the EBU color gamut.
- Select **Native** to use REC709 for cyan, magenta, and yellow and uncorrected values for red, green, and blue.

Table 4-3 lists the x- and y-coordinates for each primary and secondary color component.

**Table 4-3. x/y Color Gamut Values**

Primary Color	Color Gamut Settings and Associated x/y Values					
	REC709		SMPTE “C”		EBU	
	x	y	x	y	x	y
Red	0.640	0.330	0.635	0.340	0.640	0.330
Yellow	0.419	0.505	0.421	0.506	0.418	0.502
Green	0.300	0.600	0.305	0.595	0.290	0.600
Cyan	0.225	0.329	0.228	0.326	0.220	0.329

**Table 4-3. x/y Color Gamut Values (continued)**

Primary Color	Color Gamut Settings and Associated x/y Values					
	REC709		SMPTE "C"		EBU	
	x	y	x	y	x	y
Blue	0.150	0.060	0.155	0.070	0.150	0.060
Magenta	0.321	0.154	0.318	0.162	0.328	0.158

**DynamicBlack:** Select DynamicBlack from the Advanced menu to enable (**On**) or disable (**Off**) the DynamicBlack actuator in the optical engine. DynamicBlack uses a dynamic iris that modulates light to the DMD based on the actual content of the video material. Planar recommends that you disable DynamicBlack before adjusting Brightness, Contrast or other image settings.

**Adaptive Contrast:** Adaptive Contrast enhancement expands the light and dark portions of an output image according to the mean luminance of the input image.

**RGB Adjust:** To remove any trace of color from the white areas of the projected image, choose RGB Adjust from the Advanced menu and press **ENTER**. This displays the RGB Adjust sub-menu, shown in Figure 4-9.

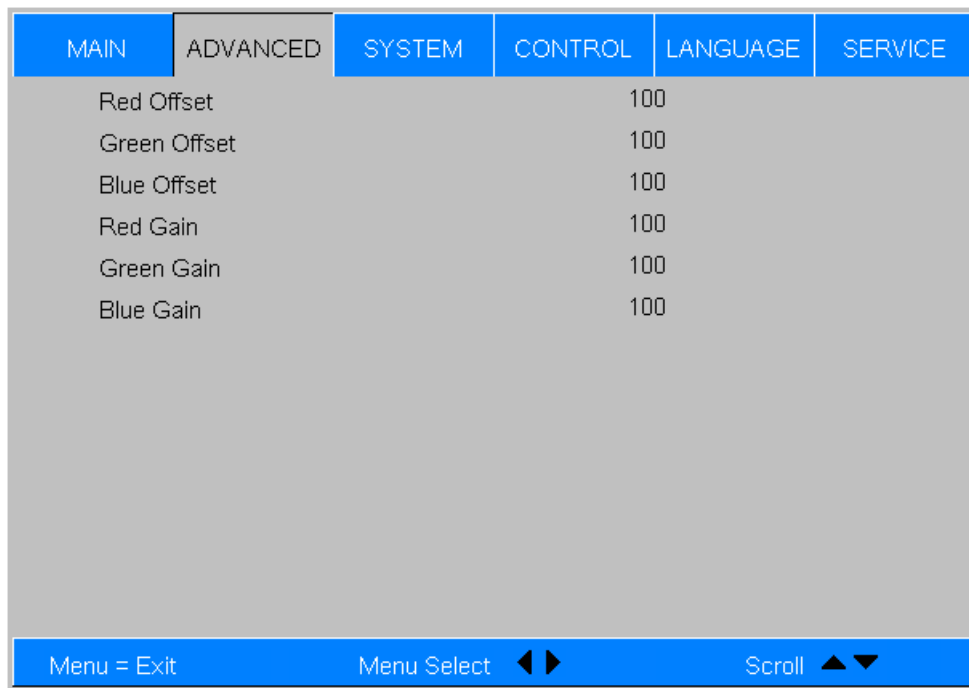

**Figure 4-9. RGB Adjust Sub-Menu**

- **Gain:** Use the Gain controls to correct color imbalances in the bright areas of the image. A good way to do this is to use a test pattern consisting mostly of solid white areas, such as an 80 IRE "window" pattern. If the white areas contain traces of red, green or blue, decrease the Gain for that color.

- **Offset:** Use the Offset controls in the RGB Adjust sub-menu to correct color imbalances in the dark areas of the image. A good way to do this is to use a test pattern consisting mostly of dark gray areas, such as a 30 IRE “window” pattern. If the gray areas contain traces of red, green or blue, decrease the Offset for that color.

The Gain controls increase or decrease the full-scale input range; the Offset controls shift the entire range, resulting in a change in brightness.



**Note**

Generally, higher Gain settings reduce the image contrast; higher Offset settings reduce the image brightness.

**Fine Sync:** To fine-tune the position and other image attributes, choose Fine Sync from the Advanced menu and press **ENTER**. This displays the Fine Sync sub-menu, shown in Figure 4-10.

MAIN	ADVANCED	SYSTEM	CONTROL	LANGUAGE	SERVICE
				V Position	100
				H Position	100
				Phase	100
				Tracking	100
				Sync Level	100

Menu = Exit
Menu Select ◀▶
Scroll ▲▼

**Figure 4-10. Fine Sync Sub-Menu**

- **V Position:** This control adjusts the vertical position of the image within the designated image area, up to 25 per cent of the image height up or down.
- **H Position:** This control adjusts the horizontal position of the image within the designated image area, up to 25 per cent of the image width left or right.
- **Phase (RGB or Component sources):** This control adjusts the phase of the pixel sampling clock relative to the incoming signal. Adjust the phase when an RGB or Component image still shows shimmer or “noise” after Tracking has been optimized.



**Tip**

Adjust the Phase **after** adjusting Tracking (see below). If some shimmer from a video or HDTV source persists, use the Noise Reduction controls (described on page 46) to remove high-frequency noise from the signal.

For best results, use a good test pattern such as a smooth gray consisting of a clear pattern of black and white pixels, or a similar “half on, half off” graphic image. Adjust the slider until the image stabilizes and each pixel is clearly defined. You may notice that you can stabilize the image at more than one point. Use either setting in such cases.

- **Tracking (RGB or Component sources):** Tracking determines the frequency of the pixel sampling clock, indicated by the number of incoming pixels per line, so that all pixels generated by a particular source are sampled.

Steady flickering or several soft vertical stripes or bands across the entire image indicates poor pixel tracking. Proper pixel tracking helps ensure that the image quality is consistent across the screen, that aspect ratio is maintained and that pixel phase (see above) can be optimized.

- **Sync Level (Component sources only):** Select Sync Level to adjust the voltage level of the PD7170 Sync signal detection circuitry.

Sync Level adjustment is occasionally necessary when a DVD player or HDTV source signal drops “below black” (for example, during scenes with explosions or when subtitles are present) and causes the projector to temporarily lose sync. If the Sync Level from the source is persistently too low, the projector won’t sync with the source at all.

The range is from 50 to 256 millivolts (mV) inclusive. The default setting is 240 mV and should rarely require adjustment.

Use the controls in the System menu, shown in Figure 4-11, to adjust the lamp, change the display orientation and perform other, common installation tasks.

◀ **System**

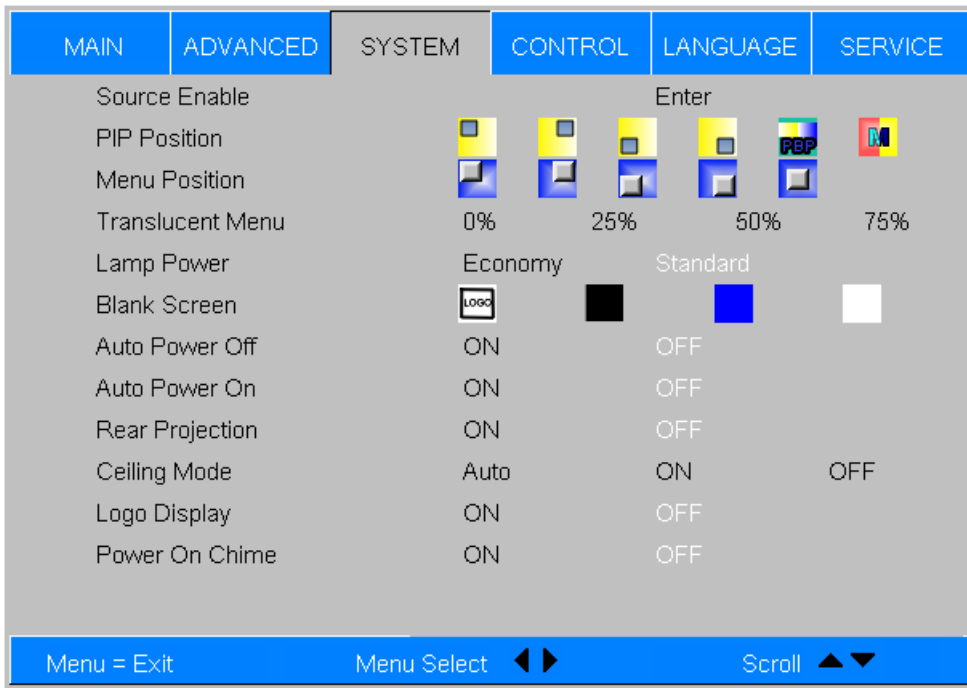

**Figure 4-11. PD7170 System Menu**

**Source Enable:** To enable or disable selection of a source, choose Source Enable from the System menu and press **ENTER**. This displays the Source Enable sub-menu, shown in Figure 4-12.

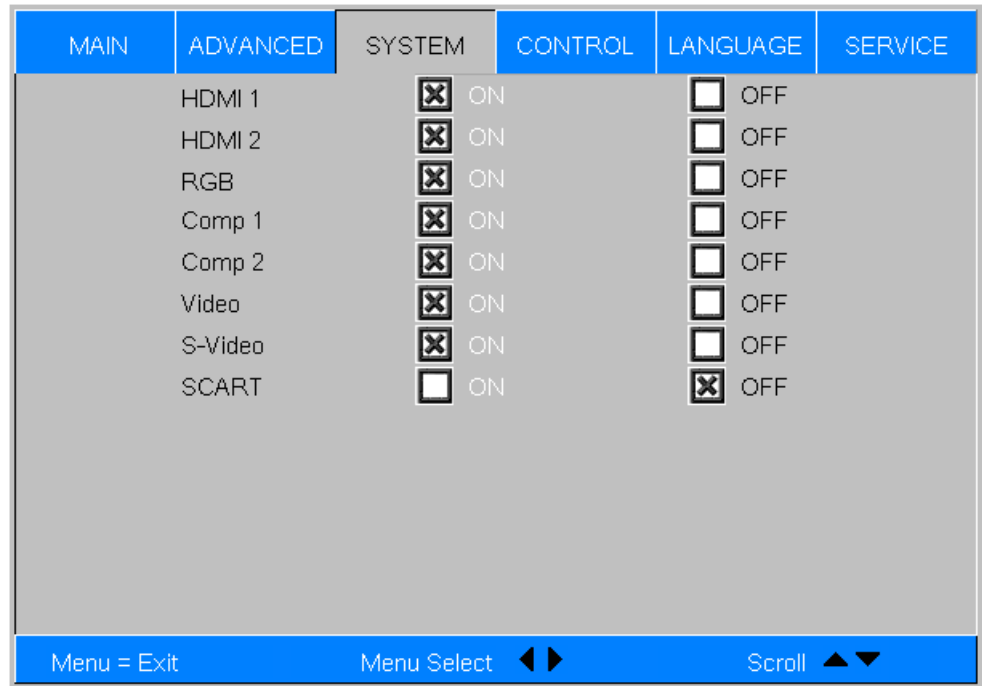

**Figure 4-12. Source Enable Sub-Menu**

- **HDMI 1/HDMI 2:** Enables or disables the HDMI 1 and HDMI 2 sources.
- **RGB:** Enables or disables the RGB source.
- **Comp 1/Comp 2:** Enables or disables the Component 1 and Component 2 sources.
- **Video:** Enables or disables the Composite video source.

 **Note** *If either Component 1 or Video is enabled, SCART must be disabled.*

- **S-Video:** Enables or disables the S-Video source.
- **SCART:** Enables or disables the SCART RGBS source.

 **Note** *If SCART is enabled, both Component 1 and Video must be disabled.*

**PIP Position:** To change the position of the PIP image, choose PIP Position from the System menu; see Figure 4-13. Choose one of the following:

- **Top Left:** This places the PIP source into a 427x240 designated image area at the top left of the screen.
- **Top Right:** This places the PIP source into a 427x240 designated image area at the top right of the screen.
- **Bottom Left:** This places the PIP source into a 427x240 designated image area at the bottom left of the screen-safe area of the DMD.
- **Bottom Right:** This places the PIP source into a 427x240 designated image area at the bottom right of the screen-safe area of the DMD.
- **Picture-By-Picture:** This reduces the designated image area of the Active source to 614x345 and places it next to the PIP source, which is also in a 614x345 image area. These two images are centered on the screen.
- **Split Screen:** This is a special mode in which the active source is also used as the PIP source and placed in a PIP area equal to half the display on the left side. This results in the right half of the image being the active source and the left half is the PIP source. The PD7170 applies the **User Memory 2** settings to the PIP image.

Split-screen mode is useful for viewing “before” and “after” settings for Sharpness, Noise Reduction and other advanced image parameters. See Figure 4-14.

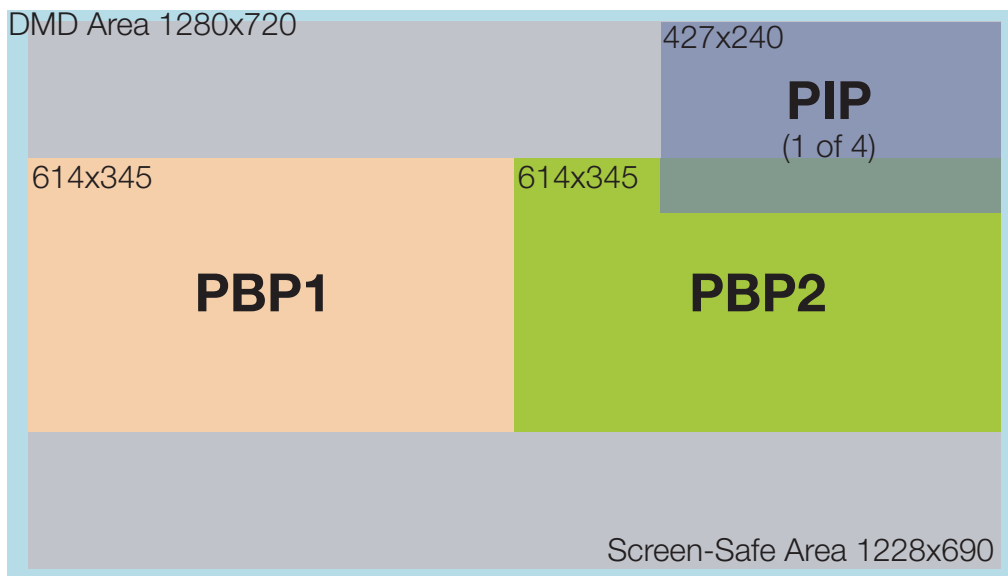

**Figure 4-13. PIP and PBP areas for 720p Display**



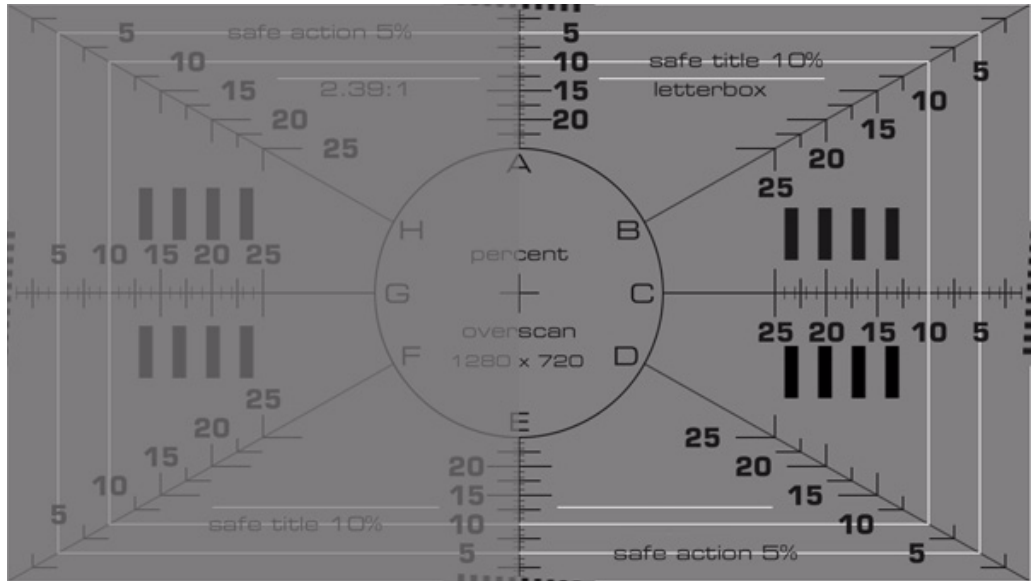

**Figure 4-14. PIP Split-Screen Mode**

**Menu Position:** Select Menu Position from the System menu to change the OSD menu position. The default setting is “” (top left).

**Translucent Menu:** Select Translucent Menu from the System menu to adjust the degree of translucence (show-through) in the menus and message boxes. 0% means that the menus are opaque. The default setting is 25%.

**Lamp Power:** Select Lamp Power from the System menu to adjust the lamp output level. You can choose to run the lamp as bright as possible (260W) or you can choose the default, **Economy** (230W) setting. Generally, lower lamp output prolongs the life of the lamp, but decreases brightness. This setting is per source, not global, so it can be saved like other user settings.

**Blank Screen:** Select Blank Screen from the System menu to choose the color of the blank screen that appears when no source signal is present. The options are **Logo**, **Black**, **Blue** and **White**. The default is **Black**.

**Auto Power Off:** Set Auto Power Off to **On** to have the PD7170 turn itself off after 20 minutes of inactivity (no source signal present).

**Auto Power On:** Setting Auto Power On to **On** causes the projector to automatically power up when AC power is present. If the projector is plugged into a switched AC outlet, this allows the projector to be turned on using a wall switch instead of the remote control unit. If you do not need this capability, set Auto Power On to **Off** (this is the default setting).

**Rear Projection:** This control reverses all images and menus, and is necessary when the projector is used in rear-projection applications. The default is **Off**.

**Ceiling Mode:** This control flips the image so the projector can be used in ceiling mounted installations. The default setting, **Auto**, automatically determines the orientation using an internal sensor.

**Logo Display:** This controls whether or not the Planar logo appears during startup.

**Power On Chime:** This controls the audible chime at startup.

Select Control from the Main Menu to set various options related to control of the projector.

◀ **Control**

MAIN	ADVANCED	SYSTEM	CONTROL	LANGUAGE	SERVICE
Lens Control		Focus	Zoom	Lens Shift	
1 Key			Enter		
2 Key			Enter		
3 Key			Enter		
4 Key			Enter		
5 Key			Enter		
M1 Key		User-1	User-2	ISF-Day	ISF-Night
M2 Key		User-1	User-2	ISF-Day	ISF-Night
M3 Key		User-1	User-2	ISF-Day	ISF-Night
Trigger-1		Lamp	16:9 Letterbox	4:3	4:3-Narrow RS232
Trigger-2		Lamp	16:9 Letterbox	4:3	4:3-Narrow RS232
Change Remote Code			Enter		
Auto Source		ON	OFF		

Menu = Exit
Menu Select ◀▶
Scroll ▲▼

**Figure 4-15. PD7170 Control Menu**

**Lens Control:** Select Lens Control from the Control menu to perform lens adjustments (focus, zoom and lens shift). For detailed instructions, refer to **Lens Adjustments** on page 31.

**1 Key / 2 Key / 3 Key / 4 Key / 5 Key:** These menu items assign the function of the keys numbered 1 through 5 on the remote.

There are eight sources corresponding to the eight connections to the projector. When you assign a source to a numbered key, the projector immediately goes to that source when the key assigned to it is pressed.

If the chosen source is disabled via the Source Enable menu (refer to page 56), this setting has no effect.

**M1 Key / M2 Key / M3 Key:** These menu items assign which memory setting to recall when the M1, M2 or M3 key on the remote is pressed.

**Trigger 1:** Select Trigger 1 from the Control menu to specify when the Trigger 1 port outputs 12 volts. There is a three-second delay before activation to prevent operation while selecting an aspect ratio.

- **Lamp** causes the port to output 12 volts whenever the lamp is on.
- **16:9** causes the port to output 12 volts whenever the 16:9 aspect ratio is chosen.
- **Letterbox** causes the port to output 12 volts whenever the Letterbox aspect ratio is chosen. The output stops if PIP is enabled (PIP source is set to anything other than off).
- **4:3** causes the port to output 12 volts whenever the 4:3 aspect ratio is chosen. The output stops if PIP is enabled (PIP source is set to anything other than off).
- **4:3 Narrow** causes the port to output 12 volts whenever the 4:3 Narrow aspect ratio is chosen. The output stops if PIP is enabled (that is, the PIP source is set to anything other than off).
- **RS232** causes the port to output 12 volts when an RS232 screen trigger 1 "on" command is received and stop when a trigger 1 "off" command is received. The 12 volt output also stops when the projector is turned off.

**Trigger 2:** Select Trigger 2 from the Control menu to configure the Trigger 2 output. Trigger 2 operates identically to Trigger 1.

**Change Remote Code:** To change the remote IR code set to which the PD7170 responds, select Change Remote Code from the Control menu and press **ENTER**. A "Change Remote Code Set?" message box appears. Select **Yes** to confirm the code set change.

You may need to change the code set if other equipment in the theater responds to commands from the PD7170 remote control in ways that are unexpected or undesirable.

When you select a different remote code set on the PD7170, you must re-program the remote control unit to use that same code set. To do this, press and hold the **LIGHT** and **ENTER** buttons simultaneously for approximately five seconds. When the code set has changed, the remote control back-lighting "blinks" to visually confirm the change.

Table 6-1 lists the IR codes associated with each remote control button.

**Auto Source:** This control chooses whether or not to scan for other active sources if the current source is not available. The default setting is **Off**.

Select Language from the Main Menu to change the OSD Language.

◀ **Language**

The PD7170 can display the menus in English, French, German, Italian, Spanish, Swedish, Traditional Chinese, Simplified Chinese, Japanese, Korean, Portuguese or Russian.



Press ▲ or ▼ to select a language. Then, press **ENTER** to confirm your selection.

**Service** ➤ Access the Service Menu, shown in Figure 4-16, to view information that uniquely identifies your projector and indicates its current operational status:

- Model Name
- Unit Serial Number
- Software Version
- Active/PIP Source
- Pixel Clock
- Signal Format
- H/V Refresh Rate
- Lamp Hours (number of lamp hours elapsed since the last reset)

Should you ever need to contact Planar Technical Support, this information will help them answer your questions and/or resolve product performance issues.

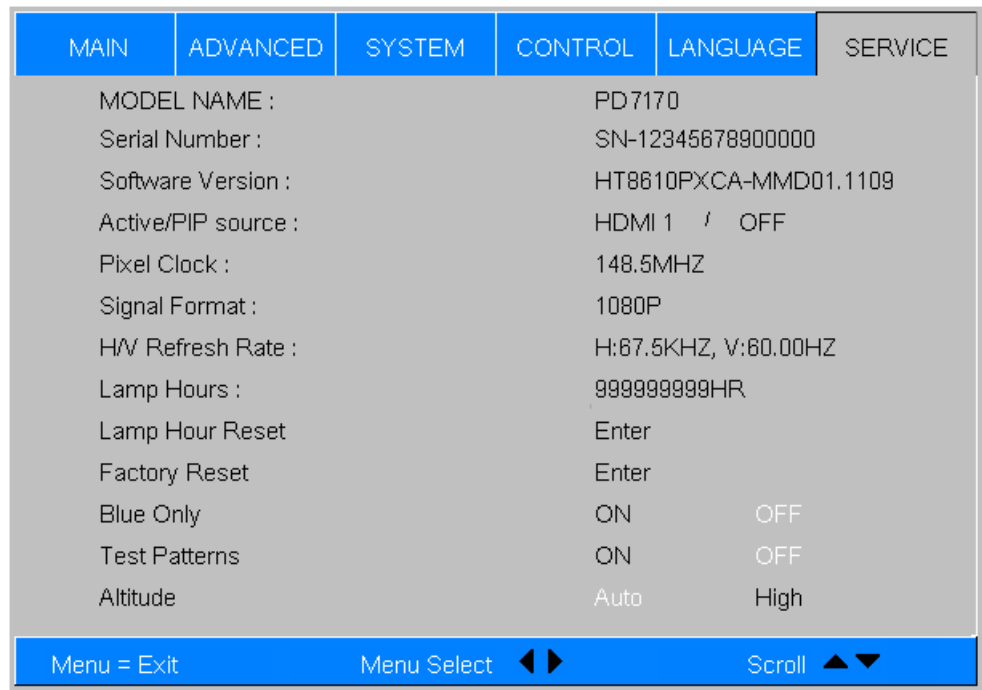

**Figure 4-16. PD7170 Service Menu**

You can also perform various maintenance tasks, such as resetting the lamp hour counter, from this menu.

**Lamp Hour Reset:** When you replace the projector lamp (refer to **Lamp Replacement** on page 65), you should also reset the lamp hour counter. To do this, select Lamp Hour Reset from the Service menu, then press **ENTER**. Press **ENTER** again to confirm the reset. Or, to cancel the operation, press **▶** on the remote to highlight **No**, then press **ENTER**.

**Note**

*Reset the Lamp Hour counter ONLY after you replace the lamp. Otherwise, the reported "Lamp Hours" will be inaccurate.*

**WARNING**

*Do not exceed the recommended lamp life. An old lamp becomes increasingly fragile and prone to sudden failure.*

**Factory Reset:** Select Factory Reset from the Service menu to restore all projector settings – except those listed below – to their factory-default values:

- Lamp Hours
- User Memory 1 / User Memory 2
- ISF Day
- ISF Night
- Model Name / Serial Number
- Language

**Blue Only:** This feature removes all red and green color information from the image, and is useful for color-calibrating the projector or other video components.

**Test Patterns:** The PD7170 has numerous internal test patterns that are useful to technicians for advanced calibration, measurement and fault isolation purposes. To access them, select Test Patterns from the Service menu and set it to **On**.

The available test patterns are:

- White
- Black
- Red
- Green
- Blue
- Cyan
- Magenta
- Yellow
- ANSI Checkerboard
- Horizontal Gray Ramp
- Focus Grid

Press **◀** or **▶** on the remote control unit or built-in keypad to cycle through the test patterns.



**Note**

The OSD menus are not available when in “test pattern” mode.

To turn test patterns off, press any key other than ◀ or ▶ on the remote control unit or built-in keypad.

**Altitude:** Select Altitude from the Service Menu to control the operation of the projector’s cooling fan.

In most cases, the default setting (**Auto**) will maintain the correct operating temperature. If the lamp frequently turns off due to overheating, or in certain high-altitude operating environments, you may need to change this setting to **High**.

# Maintenance and Troubleshooting

The lamp should be replaced when it reaches the end of its life (typically between 2000 and 2500 hours depending on the Lamp Power setting), or sooner if a noticeable degradation in brightness occurs. Contact your Planar dealer to obtain a replacement lamp.

## 5.1 Lamp Replacement

1. Turn off the projector and unplug the power cord. **Allow the projector to cool down for approximately 60 minutes prior to removing the lamp assembly for replacement.**
2. Using a flat-blade screwdriver, loosen the four screws holding the rear compartment cover in place.

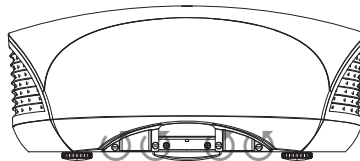

3. Remove the rear compartment cover by tilting it upward.

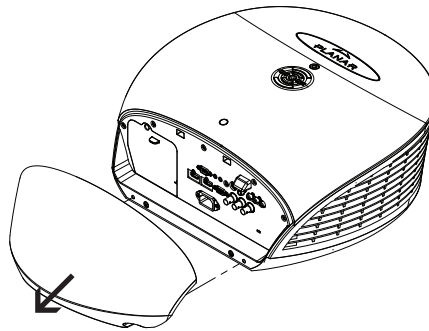

4. Loosen the screw on the lamp cover and pull the lamp cover out.

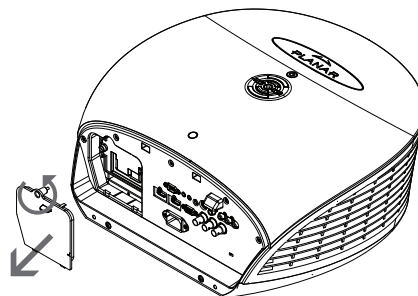

5. Loosen the two screws on the lamp module.

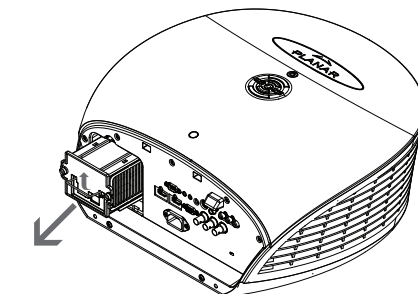

6. Pull the lamp module handle firmly to remove the lamp module.
7. Perform Steps 6 through 2 (in reverse order) to install the new lamp module.
8. Turn on the power and reset the lamp timer.



## 5.2 Troubleshooting Tips

Table 5-1 provides some general guidelines for troubleshooting problems you may encounter with the PD7170. If the suggested solutions fail to resolve the problem or if you encounter an issue not described here, please contact Planar Technical Support.

**Table 5-1. Troubleshooting Chart**

Symptom	Possible Cause(s)	Solution
The projector does not turn on.	<ul style="list-style-type: none"> <li>The PD7170 is not plugged in or the AC outlet is not active.</li> <li>Lamp cover is not securely attached.</li> </ul>	<ul style="list-style-type: none"> <li>Ensure that the PD7170 is plugged in and that the AC outlet is active.</li> <li>Securely attach the lamp cover.</li> </ul>
The projector does not turn back on after it was powered off.	<ul style="list-style-type: none"> <li>The projector will not turn on for two minutes after power-off, to protect the lamp.</li> </ul>	<ul style="list-style-type: none"> <li>Wait until the PD7170 completes its cool-down (POWER LED lights solid green).</li> </ul>
The remote control does not work correctly.	<ul style="list-style-type: none"> <li>The batteries have run out.</li> <li>IR code set mismatch between remote control unit and projector.</li> </ul>	<ul style="list-style-type: none"> <li>Replace the batteries.</li> <li>Press and hold the <b>LIGHT</b> and <b>ENTER</b> remote control buttons simultaneously until the remote control back-lighting "blinks" (approximately five seconds). Then, try again.</li> </ul>
The projector is on and OSD menus appear, but there is no video image on-screen.	<ul style="list-style-type: none"> <li>Incorrect source selection.</li> <li>Source component is not turned on.</li> <li>Source component is connected incorrectly or not at all.</li> </ul>	<ul style="list-style-type: none"> <li>Select the correct source.</li> <li>Turn on the source.</li> <li>Check cable connection from source component to projector.</li> </ul>
A projected image from a DVD is split or otherwise scrambled.	<ul style="list-style-type: none"> <li>DVD player is connected to the Component input and set to progressive scan mode.</li> </ul>	<ul style="list-style-type: none"> <li>Turn off progressive scan on the DVD player.</li> </ul>
Image is blurred.	<ul style="list-style-type: none"> <li>The lens is not correctly focused.</li> </ul>	<ul style="list-style-type: none"> <li>Adjust the focus with the remote control.</li> </ul>
Image is too bright and/or lacks definition in the bright areas of the image.	<ul style="list-style-type: none"> <li>Contrast is set too high.</li> </ul>	<ul style="list-style-type: none"> <li>Lower the contrast setting.</li> </ul>
Image appears "washed out" and/or dark areas appear too bright.	<ul style="list-style-type: none"> <li>Brightness is set too high.</li> </ul>	<ul style="list-style-type: none"> <li>Lower the brightness setting.</li> </ul>

**Table 5-1. Troubleshooting Chart (continued)**

Symptom	Possible Cause(s)	Solution
Colors in the image are swapped; for example, reds appear blue or vice versa.	<ul style="list-style-type: none"> <li>The Red/Pr, Green/Y or Blue/Pb outputs from the source are connected to the wrong inputs on the PD7170.</li> </ul>	<ul style="list-style-type: none"> <li>Ensure that the source outputs are connected to the correct PD7170 input.</li> </ul>
LED is flashing alternating green and red.	<ul style="list-style-type: none"> <li>The lamp cover is open.</li> <li>The lamp has failed or exceeded its usage life.</li> </ul>	<ul style="list-style-type: none"> <li>Close the lamp cover.</li> <li>Replace the lamp with a new one.</li> </ul>
LED is flashing red.	<ul style="list-style-type: none"> <li>PD7170 internal temperature is too high.</li> </ul>	<ul style="list-style-type: none"> <li>Power off the PD7170 and allow it to cool down. Ensure that the intake and exhaust vents are not blocked. Turn the projector back on. If the problem persists, please contact Planar Technical Support for assistance.</li> </ul>
LED lights solid red.	<ul style="list-style-type: none"> <li>Fans are not working properly or power-on self-test has failed.</li> </ul>	<ul style="list-style-type: none"> <li>Please contact Planar Technical Support for assistance.</li> </ul>

**Notes:**

# Serial Communications

To interface the PD7170 with a home theater automation/control system or a PC running terminal emulation software:

1. Connect it to your control system or PC as shown in Figure 3-11.
2. Start a terminal session on your PC using a terminal-emulation program, such as HyperTerminal.
3. Configure the RS-232 controller or PC serial port as follows: 38400 bps, no parity, 8 data bits, 1 stop bit and no flow control.
4. Type **ky** or **op** followed by a command from among those listed in Table 6-1 or Table 6-2 and press **<Enter>**. For example, to change the aspect ratio to Letterbox, type `op aspect = 1<Enter>`.

Serial commands to the PD7170 take the following form:

- Commands are in ASCII format.
- Spaces and tabs can be used to improve readability and are ignored by the projector.
- All commands must end with a carriage return (ASCII hex 0D) to signify that the projector can now read and execute the command.
- Commands are not case-sensitive.

The PD7170 supports two types of commands: key commands and operation commands. Key commands mimic pressing a button on the remote control. Operation commands tell the projector exactly what to do.

All commands start with 2 letters:

**ky** for key commands.

**op** for operations commands.

The syntax for key commands is simple:

**ky <keyname> [CR]**

Some key command examples:

**ky menu [CR]** Bring up or cancel menu display.

**ky mem. sw [CR]** Switch to next user memory.

**ky asp. 16.9 [CR]** Apply 16:9 aspect ratio.

The response from the projector for key commands will be the same command in UPPERCASE.

Input: **ky mem. sw [CR]**

Response: **KY MEM. SW [CR]**











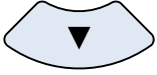

## 6.1 RS-232 Connection and Port Configuration

## 6.2 Serial Command Syntax











### ◀ Key Commands

Table 6-1 lists the serial command key names and IR codes.



**Table 6-1. Serial Command Key Names and IR Codes**

RS232 Keyname	Remote Button	IR Code		Description
		Set 1	Set 2	
pow.on		0x01	0xB7	Turn power on.
src.sw	(none)	0x02	0xB8	Switch to the next source.
pow.off		0x09	0xB9	Turn power off.
menu		0x15	0xBA	Bring up or cancel menu display.
enter		0x17	0xBB	Keypad enter.
cur.down		0x18	0xBC	Keypad down arrow.
cur.up		0x1A	0xBD	Keypad up arrow.
cur.left		0x1D	0xBE	Keypad left arrow.
cur.right		0x1F	0xBF	Keypad right arrow.
bright		0x80	0xC0	Bring up or cancel brightness slider.
contrast		0x81	0xC1	Bring up or cancel contrast slider.
sharp		0x82	0xC2	Bring up or cancel sharpness slider.
nr		0x83	0xC3	Bring up or cancel noise reduction slider.
resync	(none)	0x84	0xC4	Force reacquisition of active and PIP source
gam.sw		0x85	0xC5	Switch to the next gamma.
gam.crt	(none)	0x86	0xC6	Switch to CRT gamma.
gam.film	(none)	0x87	0xC7	Switch to Film gamma.
gam.vide	(none)	0x88	0xC8	Switch to Video gamma.

**Table 6-1. Serial Command Key Names and IR Codes (continued)**

RS232 Keyname	Remote Button	IR Code		Description
		Set 1	Set 2	
gam.brig	(none)	0x89	0xC9	Switch to Bright Room gamma.
gam.pc	(none)	0x8A	0xCA	Switch to PC gamma.
src.1		0x8B	0xCB	Switch the active source to source 1.
src.2		0x8C	0xCC	Switch the active source to source 2.
src.3		0x8D	0xCD	Switch the active source to source 3.
src.4		0x8E	0xCE	Switch the active source to source 4.
src.5		0x8F	0xCF	Switch the active source to source 5.
bla.tog	(none)	0x90	0xD0	Toggles between blank screen and regular display.
bla.on	(none)	0x91	0xD1	Turn blank screen on.
bla.off	(none)	0x92	0xD2	Turn blank screen off.
osc.sw		0x93	0xD3	Switch to the next Overscan mode.
osc.zoom	(none)	0x94	0xD4	Switch to Overscan Zoom.
osc.crop	(none)	0x95	0xD5	Switch to Overscan Crop.
osc.off	(none)	0x96	0xD6	Switch to Overscan Off.
mem.sw	(none)	0x97	0xD7	Switch to the next user memory.
mem.1		0x98	0xD8	Recall user memory associated with the M1 key.
mem.2		0x99	0xD9	Recall user memory associated with the M2 key.
mem.3		0x9A	0xDA	Recall user memory associated with the M3 key.
isf.day	(none)	0x9B	0xDB	Recall ISF Day user memory.
isf.nigh	(none)	0x9C	0xDC	Recall ISF Night user memory.
asp.sw		0x9D	0xDD	Switch to the next aspect ratio.
asp.16.9	(none)	0x9E	0xDE	Apply 16:9 aspect ratio to the active source.
asp.4.3	(none)	0x9F	0xDF	Apply 4:3 aspect ratio to the active source.
asp.lett	(none)	0xA0	0xE0	Apply Letterbox aspect ratio to the active source.

**Table 6-1. Serial Command Key Names and IR Codes (continued)**

RS232 Keyname	Remote Button	IR Code		Description
		Set 1	Set 2	
asp.narr	(none)	0xA1	0xE1	Apply 4:3 Narrow aspect ratio to the active source.
pip.sw		0xA3	0xE3	Switch to next "PIP Select" state.
pip.1	(none)	0xA4	0xE4	Change "PIP Select" to source 1.
pip.2	(none)	0xA5	0xE5	Change "PIP Select" to source 2.
pip.3	(none)	0xA6	0xE6	Change "PIP Select" to source 3.
pip.4	(none)	0xA7	0xE7	Change "PIP Select" to source 4.
pip.5	(none)	0xA8	0xE8	Change "PIP Select" to source 5.
pip.off	(none)	0xA9	0xE9	Change "PIP Select" to off.
pip.swap		0xAA	0xEA	Swap the PIP image with the active source image.
pow.tog	(none)	0xAC	0xEC	Toggles between power on and power off.
lit.tog		0xAD	0xED	Activates remote backlighting only when pressed momentarily. When held for five seconds or more, the IR code for toggling the projector I/O panel light is transmitted.

**Operations Commands** ➤ Operations commands allow more flexible and direct control of the projector. The syntax for operations commands is as follows:

**op** <operation> <command> [CR]

(Precede <operation> and <command> with a space.)

The command type can be one of 5 functions:

Operations Control Commands		
Function	Command	Action on unit
Set	= <value>	Makes the unit take that value.
Get	?	Asks what the current value is.
Increment	+	Adds 1 to the current value.
Decrement	-	Subtracts 1 from the current value.
Execute	(none)	Performs an action such as a reset.

Table 6-2 lists the valid operations commands. For all but Execute functions, the response from the projector is the command and "= <value>" where <value> is the current value or "NA" if the value is not available. For Execute functions the response is the same command. All responses are in UPPERCASE.

Some operations command examples:

Input: **op bright ? [CR]**

Response: **OP BRIGHT = 100 [CR]**

Input: **op bright + [CR]**

Response: **OP BRIGHT = 101 [CR]**

Input: **op bright = 127 [CR]**

Response: **OP BRIGHT = 127 [CR]**

Input: **op bright - [CR]**

Response: **OP BRIGHT = 126 [CR]**

Input: **op resync [CR]**

Response: **OP RESYNC [CR]**

Input: **op sharp.mode = 1 [CR]**

Response: **OP SHARP.MODE = 1 [CR]**

Input: **op sharp.simple = 50 [CR]**

Response: **OP SHARP.SIMPLE = NA [CR]**

Input: **op sharp.simple ? [CR]**

Response: **OP SHARP.SIMPLE = NA [CR]**

The last three commands show what happens when a control is grayed out. In this case, the sharpness mode was set to advanced (value = 1) and then the simple sharpness slider was attempted to be adjusted and queried. The response was "NA" or not available.

**Table 6-2. Serial Commands**

Operation	Commands	Values	Notes
aspect	= ?	0 = 16:9 1 = Letterbox 2 = 4:3 3 = 4:3 Narrow 4 = Native	
memory	= ?	0 = User Memory 1 1 = User Memory 2 2 = ISF Day 3 = ISF Night 4 = Default	? only returns a value if ISF Day or ISF Night is active, otherwise it returns NA
save.mem	=	0 = User Memory 1 1 = User Memory 2	



**Table 6-2. Serial Commands (continued)**

<b>Operation</b>	<b>Commands</b>	<b>Values</b>	<b>Notes</b>
save.isf	=	0 = ISF Day 1 = ISF Night	
bright	= ? + -	0 - 200	
contrast	= ? + -	0 - 200	
saturat	= ? + -	0 - 200	
tint	= ? + -	0 - 200	
sharp.simple	= ? + -	0 - 200	
sharp.mode	= ?	0 = Simple 1 = Advanced	
horiz.sharp	= ? + -	0 - 200	
vert.sharp	= ? + -	0 - 200	
diag.sharp	= ? + -	0 - 200	
sharp.over	= ? + -	0 - 200	
horiz.text	= ? + -	0 - 200	
vert.text	= ? + -	0 - 200	
diag.text	= ? + -	0 - 200	
text.over	= ? + -	0 - 200	
noise.thresh	= ? + -	0 - 200	
nr.simple	= ? + -	0 - 200	
nr.mode	= ?	0 = Simple 1 = Advanced	
nr.general	= ? + -	0 - 200	
block.reduct	= ? + -	0 - 200	
mosq.noise	= ? + -	0 - 200	
overscan	= ?	0 = Off 1 = Crop 2 = Zoom	

**Table 6-2. Serial Commands (continued)**

Operation	Commands	Values	Notes
source.sel	= ?	0 = HDMI 1 1 = HDMI 2 2 = RGB 3 = YPrPb 1 4 = YPrPb 2 5 = S-Video 6 = Video 7 = SCART	
pip.select	= ?	0 = Off 1 = HDMI 1 2 = HDMI 2 3 = RGB 4 = YPrPb 1 5 = YPrPb 2 6 = S-Video 7 = Video 8 = SCART	
resync	(execute)		
color.space	= ?	0 = Auto 1 = REC709 2 = REC601 3 = RGB-PC 4 = RGB-Video	
video.stand	= ?	0 = Auto 1 = NTSC 2 = PAL 3 = SECAM	
gamma	= ?	0 = CRT 1 = Film 2 = Video 3 = Bright 4 = Graphics	
color.temp	= ?	0 = 5500K 1 = 6500K 2 = 7500K 3 = 9300K	
dlp.frame	= ?	0 = Auto 2 = 48 Hz 3 = 50 Hz 4 = 60 Hz	
color.gamut	= ?	0 = Auto 1 = REC709 2 = SMPTE C 3 = EBU 4 = Native	

**Table 6-2. Serial Commands (continued)**

Operation	Commands	Values	Notes
dblack	= ?	0 = Off 1 = On	
focus	+ -		
zoom	+ -		
vert.offset	+ -		
horiz.offset	+ -		
red.off	= ? + -	0-200	
green.off	= ? + -	0-200	
blue.off	= ? + -	0-200	
red.gain	= ? + -	0-200	
green.gain	= ? + -	0-200	
blue.gain	= ? + -	0-200	
vert.pos	= ? + -	0-200	
horiz.pos	= ? + -	0-200	
phase	= ? + -	0-200	
tracking	= ? + -	0-200	
sync.level	= ? + -	0-200	
pip.pos	= ?	0 = Top left 1 = Top right 2 = Bottom left 3 = Bottom right 4 = Picture by picture 5 = Split screen	
lamp.pow	= ?	0 = Economy 1 = Standard	
menu.pos	= ?	0 = Top left 1 = Top right 2 = Bottom left 3 = Bottom right 4 = Center	
trans.menu	= ?	0 = 0% 1 = 25% 2 = 50% 3 = 75%	

**Table 6-2. Serial Commands (continued)**

Operation	Commands	Values	Notes
blank.screen	= ?	0 = Black 1 = Blue 2 = White 3 = Logo	
auto.pow.off	= ?	0 = Off 1 = On	
auto.pow.on	= ?	0 = Off 1 = On	
rear.proj	= ?	0 = Off 1 = On	
ceil.mode	= ?	0 = Off 1 = On 2 = Auto	
logo.disp	= ?	0 = Off 1 = On	
power.chime	= ?	0 = Off 1 = On	
1.key 2.key 3.key 4.key 5.key	= ?	0 = HDMI 1 1 = HDMI 2 2 = RGB 3 = YPrPb 1 4 = YPrPb 2 5 = S-video 6 = Video 7 = SCART	
m1.key m2.key m3.key	= ?	0 = User Memory 1 1 = User Memory 2 2 = ISF Day 3 = ISF Night	
trig.1 trig.2	= ?	0 = Lamp 1 = 16:9 2 = Letterbox 3 = 4:3 4 = 4:3 Narrow 5 = RS232	
remote.set	= ?	0 = Set 1 1 = Set 2	
auto.source	= ?	0 = Off 1 = On	
model.name	?	<string>	
ser.number	?	<string>	
soft.version	?	<string>	

**Table 6-2. Serial Commands (continued)**

Operation	Commands	Values	Notes
act.source pip.source	?	0 = HDMI 1 1 = HDMI 2 2 = RGB 3 = YPrPb 1 4 = YPrPb 2 5 = S-video 6 = Video 7 = SCART	
h.refresh	?	<number>	kHz
v.refresh	?	<number>	Hz
pixel.clock	?	<number>	MHz
signal	?	<string>	
lamp.hours	?	<number>	
total.hours	?	<number>	
environment	?	<string>	temperatures
lamp.reset	(execute)		
fact.reset	(execute)		
blue.only	=	0 = Off 1 = On	
pattern	=	0 = White 1 = Black 2 = Red 3 = Green 4 = Blue 5 = Cyan 6 = Magenta 7 = Yellow 8 = ANSI Checkerboard 9 = Horizontal Gray Ramp 10 = Focus Grid	
language	= ?	0 = English 1 = French 2 = German 3 = Italian 4 = Spanish 5 = Swedish 6 = Chinese-Simplified 7 = Chinese-Traditional 8 = Japanese 9 = Korean 10 = Portuguese 11 = Russian	OSD language only

# Specifications

Table 7-1 lists the PD7170 specifications.

**Table 7-1. PD7170 Specifications**

## 7.1 PD7170 Specifications

<b>Signal Compatibility</b>	
<b>Video Support:</b>	HDMI and DVI with HDCP for digital video, Component and RGB HDTV (1080p, 1080i, 720p), Component and RGB EDTV (576p, 480p), Component, Composite and S-Video SDTV (576i, 480i), RGB SCART with adapter, NTSC/NTSC 4.43, PAL (B,G)/(D,K)/I/M/N, SECAM
<b>Computer Support:</b>	Digital and Analog up to 1920x1080 @ 48Hz, Macintosh®
<b>Communication:</b>	RS-232, IR remote, on-board keypad
<b>Connectivity</b>	
<b>(2) HDMI V1.3 with HDCP:</b>	HDTV RGB and Component, EDTV, SDTV, HDMI (High Definition Multimedia Interface) with HDCP (High Bandwidth Digital Content Protection), DVI via adapter (not included)
<b>(1) Component (3 x RCA, gold):</b>	HDTV, EDTV, SDTV SCART RGBS via component and composite inputs (adapter not included)
<b>(1) Component (3 x BNC, 75 ohm):</b>	HDTV, EDTV, SDTV
<b>(1) RGB (HD15):</b>	HDTV, RGBHV, YUV, EDTV
<b>(1) S-Video (4-pin mini-DIN):</b>	SDTV
<b>(1) Composite (RCA, gold):</b>	SDTV
<b>(2) 3.5mm mini jack:</b>	12V (+/-1.5V) screen trigger (250mA)
<b>(1) 9 pin D-sub:</b>	RS-232 for discrete commands and software upgrades <b>Communication Parameters:</b> 38400 bps, no parity, 8 data bits, 1 stop bit, no flow control
<b>(1) 3.5mm mini jack:</b>	IR input for Niles/Xantech compatible IR repeater systems <b>Communication Protocol:</b> Conforms to NEC standard IR protocol, 38-kHz carrier frequency, custom code = 0x06F9

**Table 7-1. PD7170 Specifications (continued)**

	<b>Performance</b>
<b>Microdisplay:</b>	Texas Instruments DLP® 1280x720 DMD (x 3)
<b>Native Resolution:</b>	1280 x 720 (921,600 pixels)
<b>Aspect Ratios:</b>	Native (Pixel-to-Pixel), 16:9, Letterbox, 4:3, 4:3 Narrow, Letterbox (Anamorphic lens compatible)
<b>Projection Lens (Standard):</b>	F/3.5, 25.5~32.0mm focal length
<b>Throw Ratios:</b>	Refer to Table 3-3
<b>Vertical Lens Shift Range:</b>	Up to 65% of screen height above or below lens center (130% of one half of the screen height)
<b>Horizontal Lens Shift Range:</b>	Up to 30% of screen width left or right of lens center (60% of one half of the screen width)
<b>Video Lumens:</b>	2,000 ANSI lumens (average) calibrated at D65
<b>Sequential Contrast – DynamicBlack On:</b>	20,000:1 typical
<b>Cooling Performance:</b>	High efficiency adaptive voltage side-to-side cooling with low system acoustic noise level and low light pollution cabinet
<b>Projection Modes:</b>	Front, Rear, Ceiling (front/rear)
<b>Lamp:</b>	User replaceable, 230/260W HPM (selectable), 2500 hour lifetime at 230W setting
<b>Video Processing:</b>	Planar customized Gennum GF9450 with 10 bit independent dual channel image processing, true 1080i deinterlacing, MPEG artifact reduction (block and mosquito noise), latest motion adaptive processing, 3D noise reduction, detail enhancement, rich color processing and noise reduction, less than one frame latency
<b>Calibration:</b>	Full RGB gain/offset control (White Balance), Gamma, Contrast, Color Temperature, Brightness

**Table 7-1. PD7170 Specifications (continued)**

<b>General</b>	
<b>Dimensions:</b>	25.3" (643mm) L x 20.4" (519mm) W x 8.9" (225mm) H (see Figure 7-1)
<b>Weight (without lens):</b>	40.8 lbs. (18.50 kg)
<b>Operating Temperature:</b>	50°F to 95°F (10°C to 35°C)
<b>Operating Altitude:</b>	Sea Level - 10,000 feet (3,048m)
<b>Operating Humidity:</b>	0% to 85% non-condensing
<b>Universal Power Supply:</b>	100V - 240V at 50-60Hz (auto-ranging), true soft power
<b>Power Consumption:</b>	400 Watts (1365.2 BTUs/hour)
<b>Regulatory:</b>	FCC Part 15 Class B, CE Class B, UL, cUL, CB, RoHS, WEEE, local conformances as required
<b>Menu Languages:</b>	English, French, Italian, German, Spanish, Swedish, Traditional Chinese, Simplified Chinese, Japanese, Korean, Portuguese, Russian
<b>Limited Warranty:</b>	Projector: Two (2) years parts and labor from the date of delivery to the end user. Lamp: 1000 hours or six (6) months, whichever comes first.
<b>Specifications are subject to change without notice.</b>	



## 7.2 PD7170 Dimensions

Figure 7-1 shows the PD7170 dimensions, in millimeters.

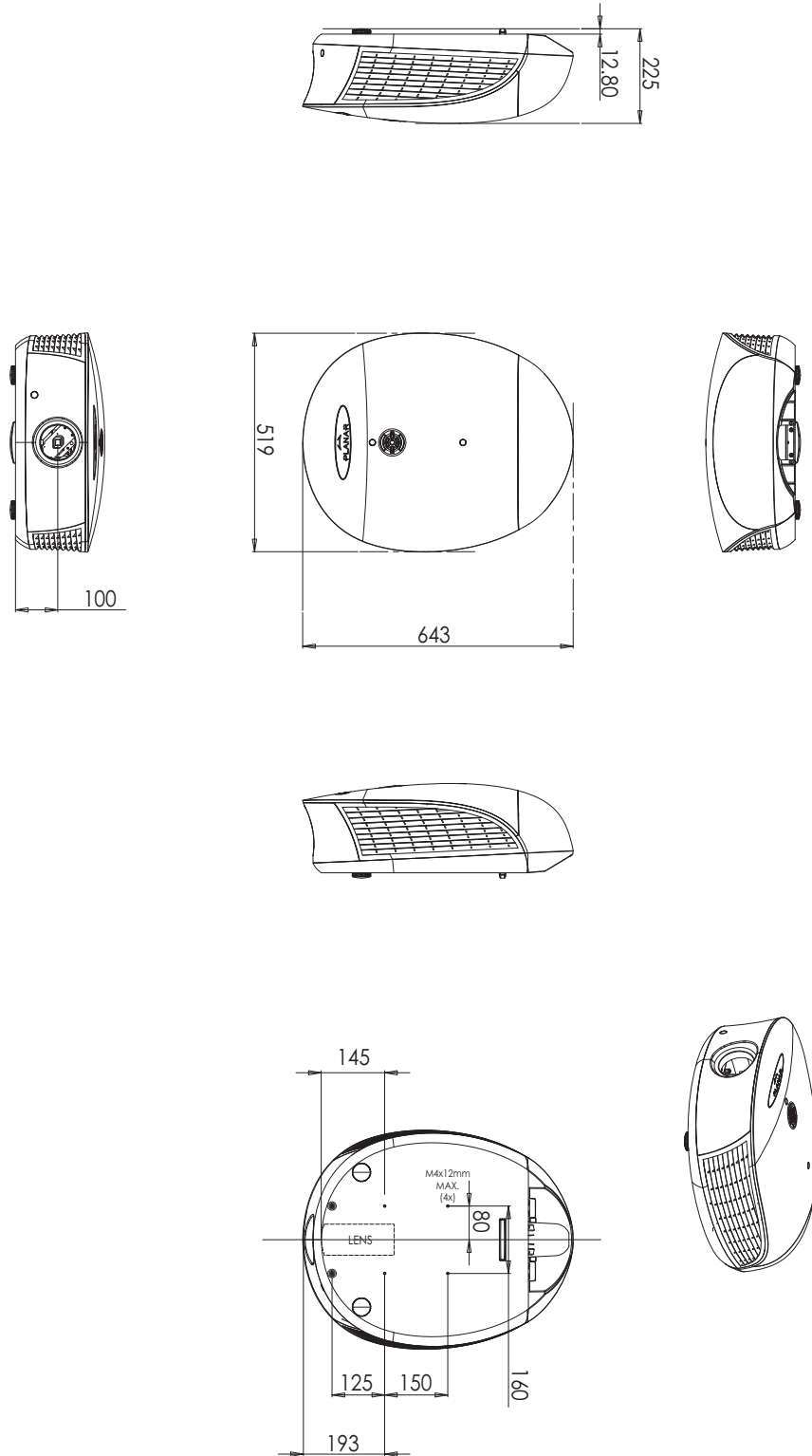

Figure 7-1. PD7170 Dimensions

Table 7-2 lists the signal types supported by each input on the PD7170.

## 7.3 Supported Timings

**Table 7-2. Supported Signal Timings by Input**

Format	Resolution	Refresh Rate (Hz)	Horizontal Frequency (kHz)	Pixel Frequency (MHz)	Supported? (√ = Yes, – = No)			
					RGB	Component 1 Component 2	HDMI 1 HDMI 2	Composite S-Video
640x480	640x480	60.00	31.469	25.175	√	–	√	–
		66.59	35.892	29.862	√	–	√	–
		75.00	37.500	31.500	√	–	√	–
		85.00	43.269	36.000	√	–	√	–
800x600	800x600	60.00	37.879	40.000	√	–	√	–
		75.00	46.875	49.500	√	–	√	–
		85.00	53.674	56.250	√	–	√	–
832x624	832x624	74.54	52.849	60.036	√	–	√	–
848x480	848x480	48.00	25.270	27.089	√	–	√	–
		60.00	31.020	33.750	√	–	√	–
1024x768	1024x768	60.00	48.363	65.000	√	–	√	–
		75.00	60.023	78.750	√	–	√	–
		85.00	68.677	94.500	√	–	√	–
1280x720	1280x720	47.95	37.833	64.769	√	–	√	–
1280x1024	1280x1024	60.00	63.981	108.000	√	–	√	–
		75.00	79.976	135.000	√	–	√	–
		85.00	91.146	157.500	√	–	√	–
1600x1200	1600x1200	60.00	75.000	162.000	√	–	√	–
1680x1050	1680x1050	59.94	69.830	164.240	√	–	√	–
1920x1080	1920x1080	47.95	56.821	150.007	√	–	√	–
480/60i	720x487	59.94	15.734	13.500	–	√	√	√
480/60p	720x483	59.94	31.469	27.000	√	√	√	–
576/50i	720x576	50.00	15.625	14.750	–	√	√	√
576/50p	720x576	50.00	31.250	29.000	√	√	√	–
720/50p	1280x720	50.00	37.500	75.250	√	√	√	–
720/60p	1280x720	60.00	45.000	74.250	√	√	√	–
1080/50i	1920x1080	50.00	28.125/31.250	74.250/72.000	√	√	√	–
1080/60i	1920x1080	59.94/60.00	33.716/33.750	74.175/74.250	√	√	√	–
1080/24p	1920x1080	23.98/24.00	26.978/27.000	74.175/74.250	√	√	√	–

**Table 7-2. Supported Signal Timings by Input (continued)**

Format	Resolution	Refresh Rate (Hz)	Horizontal Frequency (kHz)	Pixel Frequency (MHz)	Supported? (√ = Yes, – = No)			
					RGB	Component 1 Component 2	HDMI 1 HDMI 2	Composite S-Video
1080/50p	1920x1080	50.00	56.250	148.500	√	√	√	–
1080/60p	1920x1080	59.94/60.00	67.433/67.500	148.350/148.500	√	√	√	–
NTSC 3.58	–	59.94/60.00	15.734/15.750	3.580	–	–	–	√
NTSC 4.43	–	59.94/60.00	15.734/15.750	4.430	–	–	–	√
PAL-B/G	–	50.00	15.625	4.430	–	–	–	√
PAL-M	–	59.94/60.00	15.734/15.750	3.580	–	–	–	√
PAL-N	–	50.00	15.625	3.580	–	–	–	√
PAL-60	–	59.94/60.00	15.734/15.750	4.430	–	–	–	√
SECAM	–	50.00	13.500	4.250/4.410	–	–	–	√



Part No. 020-0882-01 rev. A  
May 2008