

myprojectorlamps.com

**The most trusted, dependable name
in projector lamp sales.**



<http://www.myprojectorlamps.com>



<http://www.myprojectorlamps.ca>



<http://www.myprojectorlamps.eu>

The following projector manual has not been modified or altered in any way.

User guide

ProScreen PXG10 multimedia projector

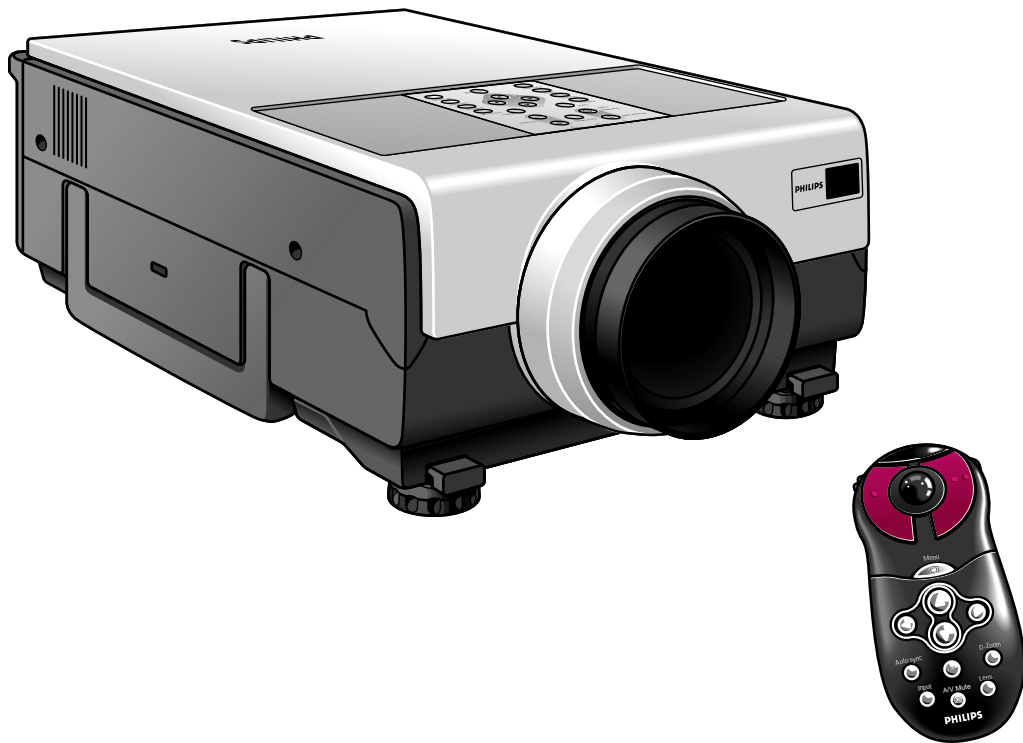

Let's make things better.

IMPORTANT NOTE FOR USERS IN THE U.S.A.

The responsible party of this multi media projector is the following:

Philips Consumer Electronics Company
One Philips Drive
Knoxville, TN 37914
Telephone (1888) 873-4672

WARNING:

TO REDUCE THE RISK OF FIRE OR
ELECTRIC SHOCK, DO NOT EXPOSE THIS
PRODUCT TO RAIN OR MOISTURE.



This "bolt of lightning" indicates uninsulated material within your unit that may cause an electric shock. For the safety of everyone in your household, please do not remove product covering.



The "exclamation point" calls attention to features for which you should read the enclosed literature closely to prevent operating and maintenance problems.

1. IMPORTANT SAFEGUARDS



CAUTION: Please read all of these instructions before you operate your projector. Save these instructions for future reference.

English

Electric energy can perform many useful functions.

This projector has been engineered and manufactured to meet applicable safety standards. IMPROPER USE CAN RESULT IN POTENTIAL ELECTRICAL SHOCK OR FIRE HAZARDS. In order not to defeat the safeguards incorporated into this projector, observe the following basic rules for its installation, use and servicing.

1. Unplug the projector from the wall outlet before cleaning or lamp replacement.
2. Do not use liquid cleaners or aerosol cleaners. Use a soft dry cloth to clean the projector unit. If the unit is very dirty, wet a cloth with neutral detergent, squeeze it tight, wipe the unit with it, and finish by wiping with a dry cloth. Do not use a chemical duster or polisher-cleaner because it can adversely affect the unit and peel the paint.
3. Do not use attachments not recommended by PHILIPS, as they may cause hazards.
4. Do not use the projector near water- for example, near a bathtub, washbowl, kitchen sink, or laundry tub, in a wet basement, near a swimming pool, etc. Never spill liquid into the projector.
5. Do not place the projector on an unstable cart, stand, or table. The projector may fall, which may cause serious injury to a child or an adult and/or serious damage to the unit. Use only with a cart or stand recommended by its manufacturer as being suitable for use with a projector.
6. Ceiling, wall or shelf mounting should be done with a mounting kit approved by the manufacturer for use with a projector and should follow the manufacturer's instructions.
7. Projector equipment and cart combinations should be moved with care. Quick stops, excessive force, and uneven surfaces may cause the equipment and cart combination to overturn.
8. Slots and openings in the sides and bottom of the cabinet are provided for ventilation. To ensure reliable operation of the projector and to protect it from overheating, these openings must not be blocked or covered. These openings should never be covered with cloth or other material. The bottom opening should not be blocked by placing the projector on a bed, sofa, rug, or other similar surface. The projector should not be placed near or over a radiator or heating vent. The projector should not be placed in a built-in installation such as a bookcase unless proper ventilation is provided.
9. The projector should be operated only from the type of power source indicated on the back of the projector or in the specifications and with the appropriate mains lead. If you are not sure of the type of power supplied to your business or the right type of mains lead, consult your projector dealer or local power company.
10. Do not allow anything to rest on the power cord. Do not place the projector where the cord will be walked on.
11. Follow all warnings and instructions marked on the projector.
12. As a safety feature, this projector is equipped with mains lead with a 3-pin grounded plug (for USA-versions only) or a 2-pin grounded plug (for European versions only). The 3-pin/2-pin grounded plug will fit only into a grounding type power outlet. If the plug does not fit, use an adapter that is properly grounded or have an electrician install a grounded type outlet. Do not attempt to modify this AC plug.
13. For added protection of the projector during a lightning storm, or when it is left unattended or not in use for long periods of time, unplug it from the wall outlet and disconnect any cable systems. This will prevent damage to the projector due to lightning and power-line surges.
14. Do not overload wall outlets and extension cords with too many products, because this can cause a fire or electric shock.
15. Never push objects of any kind into the projector through cabinet slots as they may touch dangerous voltage points or short cut parts, which could result in a fire or electric shock.
16. Do not attempt to service the projector yourself other than maintenance issues presented in chapter 'ADDITIONAL INFORMATION/Maintenance'. Opening or removing covers may expose you to dangerous voltage or other hazards. Refer all servicing to qualified service personnel.
17. Unplug the projector from the wall outlet and refer servicing to qualified service personnel under the following conditions:
 - A. When the power cord or plug is damaged or frayed.
 - B. If liquid has been spilled into the projector.
 - C. If the projector has been exposed to rain or water.
 - D. If the projector does not operate normally when you follow the operating instructions. Adjust only those controls that are covered by the operating instructions; improper adjustment of other controls may cause damage and will often require extensive work by a qualified technician to restore the projector to normal operation.
 - E. If the projector has been dropped or the cabinet has been damaged.
 - F. When the projector exhibits a distinct change in performance – (this indicates a need for service).
18. Upon completion of any service or repairs to the projector, ask the service technician to perform a routine safety check to check that the projector is in safe operating condition.
19. When replacement parts are required, be sure the service technician has used replacement parts specified by the manufacturer that have the same characteristics as the original parts. Unauthorized substitutions may result in fire, electric shock, or other hazards.
20. It is recommended to clean the air filter after every 100 lamp hours. The projector may become too hot if the filter is not cleaned when required.
21. If the lens becomes dirty or smudged, clean it with a clean, dampened cloth. Never touch the lens with your fingers.
22. Do not look directly into the aperture and lens while operating the projector as this may damage your eyes.

2. INTRODUCTION

TABLE OF CONTENTS

1. IMPORTANT SAFEGUARDS	1
2. INTRODUCTION	2
3. THINGS YOU SHOULD KNOW	3
4. PROJECTOR FEATURES	5
5. FUNCTIONAL OVERVIEW	6
Controls	6
Remote Control	7
Connections	7
6. SET UP	8-9
Positioning the projector and screen	8
Mains supply	8
Adjusting the vertical and horizontal angle of the projector	8
Lens adjustment	9
Moving the projector	9
Inserting the batteries in remote control	9
7. INSTALLATION	10-13
Video/computer cables and adapter	10
Connecting to a computer	11
Connecting to video equipment	12
Connecting to audio equipment	13
Connecting to remote control mouse receiver	13
8. OPERATION	14-18
Preparation	14
Using the remote control	14
Graphical User Interface	15
Language selection	15
Picture control	16-18
Data mode / Video mode input signal	16
Data mode display	17
Data mode / Video mode display	18
Audio control	18
Personal Preferences	18-19
Other settings	19-24
9. ADDITIONAL INFORMATION	25-27
Connecting RS-232C Port	25
Maintenance	25-27
10. TROUBLESHOOTING	28
ILLUSTRATIONS	4

INTRODUCTION

The supplied CD-ROM contains operating instructions in English, German, French, Spanish, Portuguese, Italian and Dutch. Carefully read through the operation instructions before operating the LCD-projector.

PACKAGING CONTENTS

Please confirm that the following items are packed in the projector box. They are provided to help you use or set up your projector.

- ProScreen PXG 10
- Lens cap
- Power cord (2x); USA version plus Continental Europe version
- Computer audio cable
- Computer VGA cable
- DIN-D-sub RS-232C cable
- RCA Audio Video Cable
- BNC-RCA adapters (3x)
- S-Video Cable
- Scart - RCA adapter
- Remote control plus AA size batteries (3x)
- USB mouse receiver
- User guide; CD-ROM plus Quick Reference Card
- Extra air filter
- Registration card

3. THINGS YOU SHOULD KNOW

Note:

This equipment has been tested to comply with the limits for a class A digital device in accordance with Part 15 of the FCC Rules as well as the European CE marking.

Operation is subject to the following two conditions:

- 1.** *This device may not cause harmful interference, and*
- 2.** *This device must accept any interference received, including interference that may cause undesired operation.*

These limits are designed to provide reasonable protection against harmful interference when the equipment is operated in a commercial environment.

This equipment generates, uses, and can radiate radio frequency energy and, if not installed and used in accordance with the user's guide, may cause harmful interference to radio communications.

Operation of this equipment in a residential area is likely to cause harmful interference in which case the user will be required to correct the interference at his own expense.

If this equipment does cause harmful interference to radio or television reception, which can be determined by turning the equipment off and on, the user is encouraged to try to correct the interference by one or more of the following measures:

- Reorientate or relocate the receiving antenna.
- Increase the distance between the equipment and receiver.
- Connect the equipment into an outlet on a circuit different from that to which the receiver is connected.
- Consult the dealer or an experienced radio/TV technician for help.

FCC WARNING:

To assure continued compliance, use only the provided grounded power supply cord and shielded interface cables when connecting this device to a computer. Also, any unauthorized changes or modifications to this equipment could void the user's authority to operate this device.

Note:

SAVE ENERGY! To save energy, please put the projector in the STANDBY position if you are not going to use the projector for more than 15 minutes.

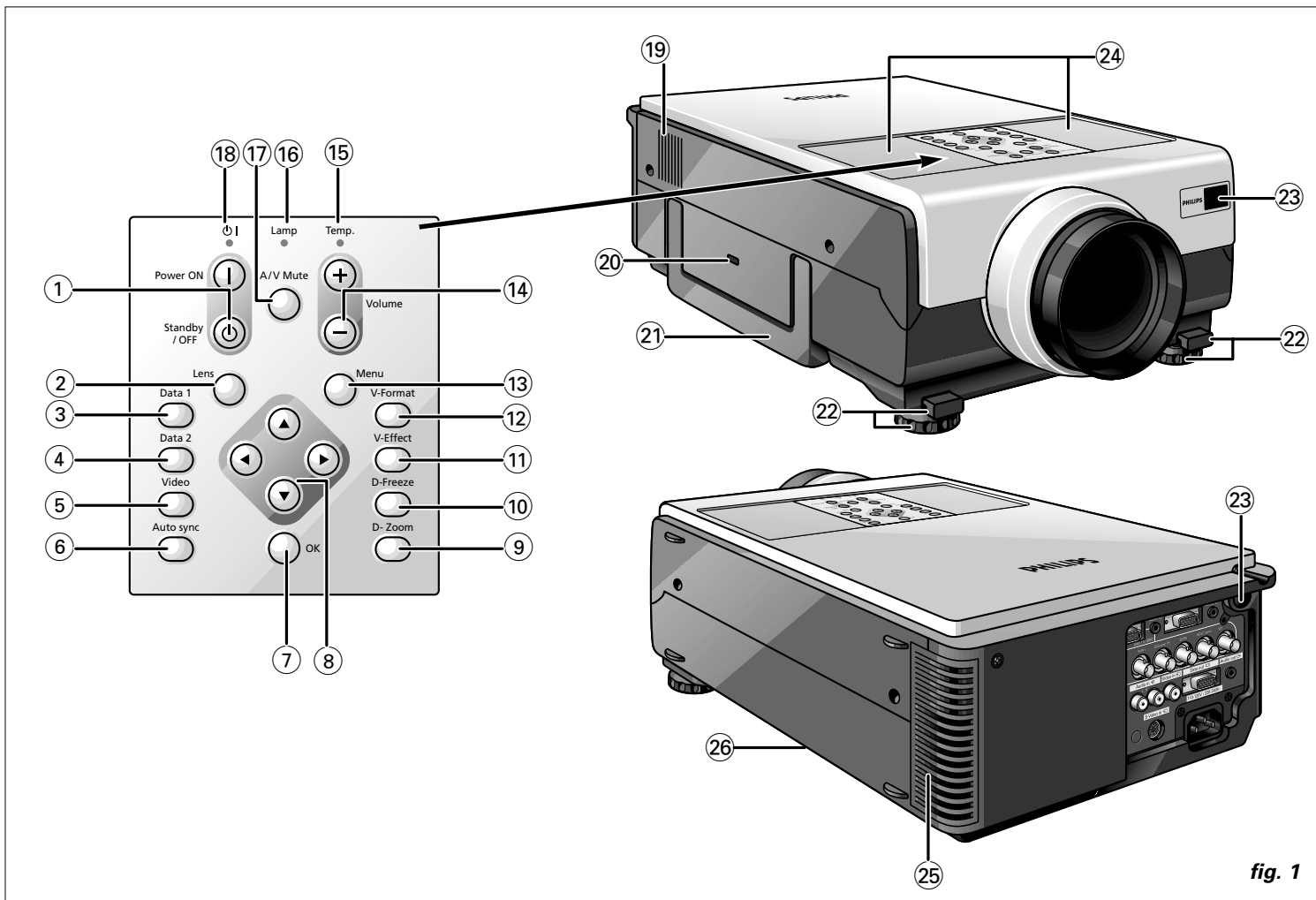

fig. 1

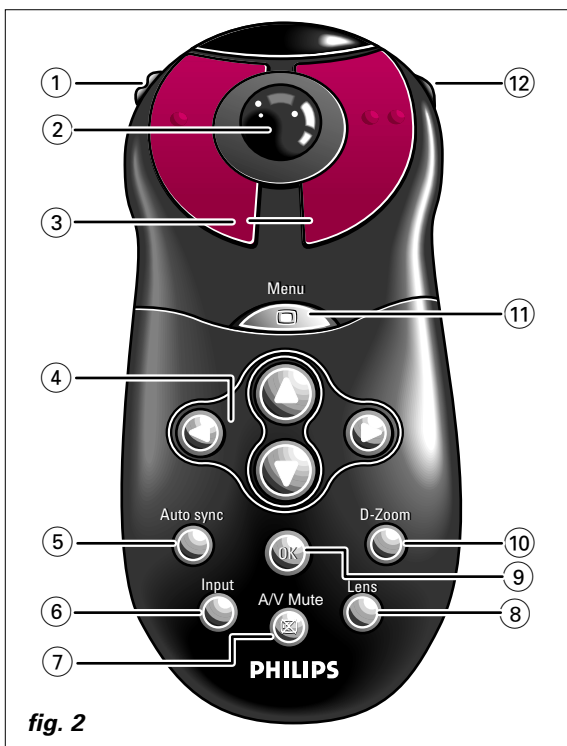

fig. 2

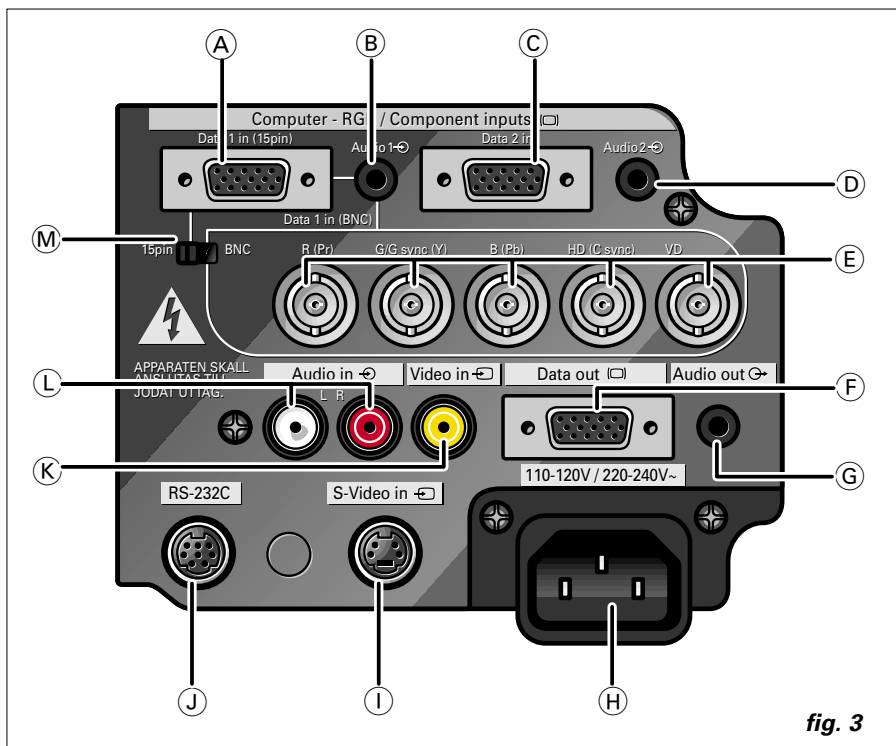

fig. 3

4. PROJECTOR FEATURES

1. **ADVANCED COMPATIBILITY WITH HIGH-END WORKSTATIONS AND PCS**

Compatible with up to 130 Hz vertical refresh rate, Sync on Green and Composite Sync signals for use with a wide variety of high-end PCs and Workstations. (Page 11)

2. **FOR USE WITH DTV***

Allows projection of DTV images and 16:9 wide-screen images when connected to a DTV decoder or similar video systems. (Page 12)

3. **BNC TERMINALS FOR COMPONENT AND RGB INPUT**

Equipped with BNC terminals for connection to a DTV decoder, DVD player and similar video systems for higher quality images. An RCA adapter can also be used with the BNC terminals. (Page 12)

4. **3-D Y/C DIGITAL COMB FILTER**

Provides high quality images with minimal dot crawl and cross colour noise.

5. **POWER ZOOM AND FOCUS FUNCTION**

Features a 130% power zoom function that allows you to easily adjust the screen size with the remote control. Use these functions when adjusting the projection distance to achieve a 102 to 762 cm (40 to 300 inches) screen size. (Page 9)

6. **DIGITAL KEYSTONE CORRECTION**

Digitally adjusts an image that is projected at an angle while maintaining image quality and brightness. (Page 9)

7. **EASY-TO-USE GRAPHICAL USER INTERFACE (GUI)**

A multi-colour, icon based menu system allows for simple image adjustments. (Page 15)

8. **USER-FRIENDLY DESIGN**

The two-colour design along with an intuitive Graphical User Interface (GUI) makes this projector very easy to set up and adjust.

9. **AUTO SYNC TECHNOLOGY FOR AUTOMATIC IMAGE PERFECTION**

Automatically makes any necessary adjustments for perfectly synced computer images. (Page 17)

10. **INTELLIGENT COMPRESSION AND EXPANSION**

By using intelligent resizing technology, this projector can display higher and lower resolution images in detail without compromising quality.

11. **XGA RESOLUTION FOR HIGH RESOLUTION PRESENTATIONS**

With XGA (1,024 x 768) resolution, this projector can display very detailed presentation information.

12. **UXGA COMPATIBLE**

UXGA (1,600 x 1,200) resolution images are intelligently resized to 1,024 x 768 for full-screen or default presentations.

* DTV is the umbrella term used to describe the new digital television system in the united states.

CAUTIONS CONCERNING THE SETUP OF THE PROJECTOR

For minimal servicing and to maintain high image quality, PHILIPS recommends that this projector be installed in an area free from humidity, dust and cigarettesmoke. If the projector is used in these environments, the lens and filter will need to be cleaned (or the filter replaced) more often, and internal cleaning may become necessary. As long as the projector is regularly cleaned, use in these environments will not reduce the overall operation life of the unit. Internal cleaning should only be performed by a Philips Authorised LCD Projector Dealer or Service Centre.

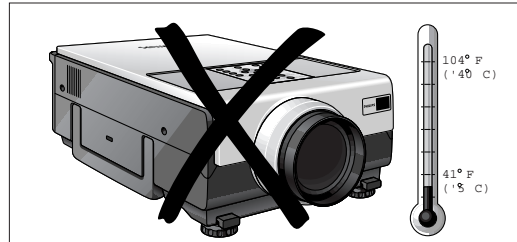

NOTES ON OPERATION

- The exhaust vent, the lamp cage cover and adjacent areas may be extremely hot during projector operation. To prevent injury, do not touch these areas until they have sufficiently cooled.
- Allow at least 10 cm (4 inches) of space between the cooling fan (exhaust vent) and the nearest wall or obstruction.
- If the cooling fan becomes obstructed, a protection device will automatically turn off the projector lamp. This does not indicate a malfunction. Remove the projector power cord from the wall outlet and wait at least 10 minutes. Then turn on the power by plugging the power cord back in. This will return the projector to the normal operating condition.

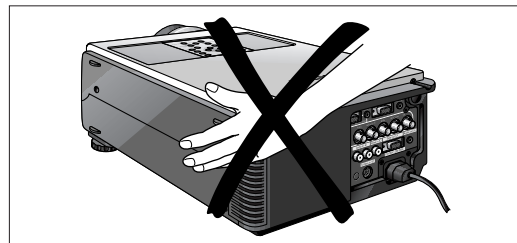

TEMPERATURE MONITOR FUNCTION

If the projector starts to overheat due to setup problems or a dirty air filter, "TEMP." and "X" will flash in the lower-left corner of the picture. If the temperature continues to rise, the lamp will turn off, the Temperature warning indicator (Temp.) on the projector will flash, and after a 90-second cooling-off period the power will shut off. Refer to "Lamp / Maintenance Indicators" on pages 25-27 for details.





Note:

The cooling fan regulates the internal temperature, and its performance is automatically controlled. The sound of the fan may change during projector operation due to changes in the fan speed.

CONTROLS

On projector (fig. 1)

- ① **Power ON** 
For switching the projector in power on.
- Standby/OFF** 
For switching the projector in standby mode.
- ② **Lens**
For selecting the optical lens adjustments Zoom and Focus and the electronic Keystone correction. The button toggles between the Zoom-, Focus- and Keystone function.
- ③ **Data-1 button**
For selecting the Data 1 signal as the current projection source.
- ④ **Data-2 button**
For selecting the Data2 signal as the current projection source.
- ⑤ **Video button**
For selecting the video signal or S-video signal as the current projection source.
- ⑥ **Auto sync**
For activating the Auto sync operation in Data mode.
- ⑦ **OK**
For action confirmation in the menu when the menu is on the screen (activated)
- ⑧ **Cursor Control**
When the menu is active the Cursor Control buttons control the menu cursor. The cursor control, by means of the local keyboard, works with up/down and left/right button operation.
- ⑨ **D-Zoom**
For addressing the D-Zoom function. The button toggles between the digital magnification factors, x1, x2, x3, x4, x6 and x8.
- ⑩ **D-Freeze button**
Digital Freeze function: to instantly freeze a moving image.
- ⑪ **V-Effect button**
Digital Video Effect correction: to enhance image quality.
- ⑫ **V-Format button**
Allows to modify or customise the picture display mode.
- ⑬ **Menu**
For activating and de-activating the OSD Menu
- ⑭ **Volume buttons (+/-)**
To adjust audio volume level.
- ⑮ **Temperature warning indicator (Temp.)**
Flashes when the temperature of the projector is too high
- ⑯ **Lamp replacement indicator (Lamp)**
Lights to indicate the status of the lamp;
Green: lamp is ready
Flashing green: warming up
Red: change the lamp
- ⑰ **Audio / Video - Mute**
For muting the sound of the projector (or an externally connected sound amplifier) and for muting the picture.
- ⑱ **Power indicator** 
Lights up red when the projector enters standby mode.
Lights up green when the projector is turned on.
- ⑲ **Cooling fan**
Intake of air for ventilation.
- ⑳ **Kensington Security Standard connector**
Slit for inserting an optional locking device (Kensington lock).
- ㉑ **Carrying handle**
- ㉒ **Foot releases/height adjustment**
For adjusting the height and vertical angle of the projector.
- ㉓ **Remote control sensors**
Receive the signals from the remote control.
- ㉔ **Speakers**
- ㉕ **Cooling fan**
Exhaust of air for ventilation.
- ㉖ **Air filter/Cooling fan**

On remote control (fig. 2)

① On / Off switch $\text{\textcircled{I}}$ / $\text{\textcircled{O}}$

For switching the remote control as well as the projector on and off.

Note:

The remote control will always use some power, even when not in use. The remote control unit will automatically switch off when not used for 30 minutes.

② Tracking Ball

For manipulating the mouse cursor on the connected computer.

Notes:

- The Tracking Ball only functions when the provided USB Mouse Receiver is connected to the USB port of a PC or an Apple Macintosh computer.
- The minimum system requirements for the USB Mouse receiver are Windows 98 and/or Windows NT 5.0 or higher.
- A cursor control requires the presence of data signal.

③ Mouse left and Mouse Right (-/--)

The mouse left/right buttons (-/--) on the remote control function as the left and right mouse buttons of your PC, only in case the provided USB Mouse receiver properly is connected to the PC.

④ Cursor Control

To operate and navigate through the activated menu via up/down and the left/right cursor buttons

⑤ Auto sync

For activating the Auto sync operation in Data mode.

⑥ Input

For selecting in sequence the Data or Video signal as the current projection source. The button toggles between Data 1, Data 2 or Video signal.

⑦ Audio / Video - Mute

For muting the sound of the projector (or an externally connected sound amplifier) and for muting the picture.

⑧ Lens

For selecting the optical lens adjustments Zoom and Focus and the electronic Keystone correction. The button toggles between the Zoom-, Focus- and Keystone function.

⑨ OK

For action confirmation in the menu when the menu is on the screen (activated)

⑩ D-Zoom

For addressing the D-Zoom function. The button toggles between the digital magnification factors, x1, x2, x3, x4, x6 and x8.

⑪ Menu

For activating and de-activating the OSD Menu

⑫ Back light

For switching on the button illumination. The back-light will switch off automatically after 5 seconds.

CONNECTIONS (fig. 3)

A Data 1 in (15 pin)

Input socket for connecting to the Data out terminal of a computer.

B Audio 1 in (3.5 mm stereo minijack)

Input socket for connecting to the Audio out terminal of a computer or any other audio equipment.

C Data 2 in (15 pin)

Input socket for connecting to the Data OUT terminal of a computer.

D Audio 2 in (3.5 mm stereo minijack)

Input socket for connecting to the Audio out terminal of a computer or any other audio equipment.

E Data 1 in (BNC) (R (Pr), G/G sync (Y), B (Pb), HD (C sync), VD)

Input sockets for connecting Data 1 BNC connection.

F Data out (15 pin)

Output socket for connecting to the Data in terminal of another data projector or data monitor.

G Audio out (3.5 mm stereo minijack)

Output socket for connecting to the Line Input sockets of an amplifier or stereo system.

H AC socket

For connecting the projector to the mains.

I S-Video in (4 pin mini DIN)

Input socket for connecting to any other Audio Video equipment equipped with a S-Video output socket.

J RS-232C port (9-pin mini-DIN)

For connecting a computer to the projector with a RS-232C cable (optional). The computer can be used in this way to control the projector.

K Video in (RCA)

Input socket for connecting to any other Audio Video equipment equipped with a Video output socket. (PAL, NTSC, SECAM).

L Audio in L/R (RCA)

Input sockets for connection to the AUDIO OUT sockets of a video recorder (S-VHS, PAL, NTSC, SECAM).

M 15 pin/BNC switch

To switch between 15 pin or BNC Data 1 input.

6. SET UP

POSITIONING THE PROJECTOR AND SCREEN

Position the projector perpendicular to the screen with all feet flat and level to achieve an optimal image. Move the projector forward or backward if the edges of the image are distorted.

- The projector lens should be centred in the middle of the screen. If the lens centre is not perpendicular to the screen, the image will be distorted, making viewing difficult.
- Position the screen so that it is not in direct sunlight or room light. Light falling directly onto the screen washes out colours, making viewing difficult. Close the curtains and dim the lights when setting up the screen in a sunny or bright room.
- A polarising screen cannot be used with this projector.
- Place the projector at the required distance from the screen according to the desired picture size (see the table below).
- Optional wide and telephoto lenses from Philips are available for specialised application. Please see your local Philips Authorised LCD Projector Dealer for details on the optional lenses.

Standard mode (4:3)

Image size (diag.)		Projection distance				Distance lens center to bottom of image	
		Tele zoom		Wide zoom			
mtrs	inch	mtrs	inch	mtrs	inch	cm	inch
1,02	40	1,40	55	1,90	75	3,10	1,22
1,52	60	2,20	87	2,90	114	4,60	1,81
1,83	72	2,60	102	3,40	134	5,50	2,17
2,13	84	3,10	122	4,00	157	6,40	2,52
2,54	100	3,70	146	4,90	193	7,60	2,99
3,81	150	5,60	220	7,20	283	11,40	4,49
5,08	200	7,40	291	9,80	386	15,20	5,98
7,62	300	11,00	433	14,30	563	22,90	9,02

Wide mode (16:9)

Image size (diag.)		Projection distance				Distance lens center to bottom of image	
		Tele zoom		Wide zoom			
mtrs	inch	mtrs	inch	mtrs	inch	cm	inch
1,02	40	1,50	59	2,00	79	-5,00	-1,97
1,52	60	2,40	94	3,10	122	-7,50	-2,95
1,83	72	2,80	110	3,70	146	-9,00	-3,54
2,13	84	3,30	130	4,30	169	-10,50	-4,13
2,34	92	3,70	146	4,80	189	-11,50	-4,53
2,54	100	4,00	157	5,20	205	-12,50	-4,92
2,69	106	4,30	169	5,60	220	-13,20	-5,20
3,38	133	5,40	213	7,00	276	-16,60	-6,54
3,81	150	6,10	240	7,90	311	-18,70	-7,36
5,08	200	8,10	319	10,50	413	-24,90	-9,80
7,62	300	12,0	472	15,60	614	-37,40	-14,72

Notes:

- Tolerances $\pm 3\%$ in above mentioned values.
- Values with a minus (-) sign indicate the distance of the lens centre below the bottom of the screen.

MAINS SUPPLY

1. Insert the mains lead into the projector's Power socket and connect it to the wall socket.

Note:

The Power indicator lights up red, the projector is now in the Power/Standby mode.

2. Remove the lens cap.

3. Press Power On.

- The power indicator lights up green and the flashing green Lamp indicator shows that the lamp is warming up. Wait until the indicator stops flashing before operating the projector. The image shown is the Philips start-up screen (default setting).
- If the power is turned off and then immediately turned on again, it may take a short while before the lamp turns on.
- After the projector is unpacked and turned on for the first time, a slight odour may be emitted from the exhaust vent. This odour will soon disappear with use.

When the power is on, the Lamp indicator lights indicating the status of the lamp.

Green: lamp is ready.

Flashing green: warming up.

Red: change the lamp.

4. To switch off the mains supply completely, pull the mains plug out of the wall socket.

Note:

Before disconnecting the mains lead, make sure that the cooling fan has stopped (about 2 minutes after the projector has been switched off).

ADJUSTING THE VERTICAL AND HORIZONTAL ANGLE OF THE PROJECTOR

Using the adjustment feet

- Press foot releases.
- Adjust height of projector and remove hands from foot releases.
- Rotate feet to make fine adjustments.

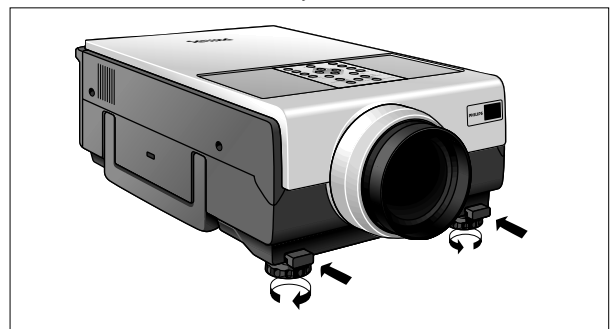

- The projector is adjustable up to approximately 5° from the standard position.

- When the height of the projector is adjusted, the image may become distorted (keystoned), depending on the relative positions of the projector and the screen. (See 'Lens adjustment').



Keystoned Image

CAUTION!

- Do not press the foot releases when the adjustment feet are extended without firmly holding the projector.
- Do not hold the lens when lifting or lowering the projector.
- When lowering the projector, be careful not to get your fingers caught in the area between the adjustment feet and the projector.

6. SET UP

LENS ADJUSTMENT

Focus, Zoom and electronic Keystone

1. Press Lens to select mode.
 - Each time Lens is pressed, the screen changes in the following order.



2. Press OK to display test pattern.

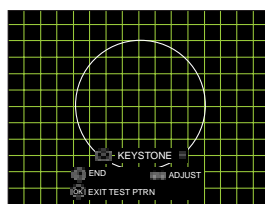

3. Press ◀, ▶, ▲ or ▼ to make adjustments.
4. Press Lens until normal screen appears.

Note:

- The On Screen Displays will automatically disappear when no changes have been made within 30 seconds.
- Straight lines and the edges of the displayed image may appear jagged, when adjusting the KEYSTONE setting.
- Do not touch the lens when adjusting the focus or zoom.

CAUTION!

When all required adjustments have been made, switch off the projector before making any other connections (see 'Installation').

MOVING THE PROJECTOR

1. Press the Standby/OFF button to switch off the projector. The standby indicator lights up red.
2. Wait until the cooling fan has stopped (about 2 minutes after the projector has been switched off) and disconnect the mains lead and all other cables.
3. Put the lens cap back in place to prevent dust, dirt or other contamination from harming or damaging the front of the projector lens when moving the projector.
4. When transporting the projector, carry it by the carrying handle on the side.

CAUTION!

Do not lift or carry the projector by the lens or the lens cap as this may damage the lens.

INSERTING THE BATTERIES IN THE REMOTE CONTROL

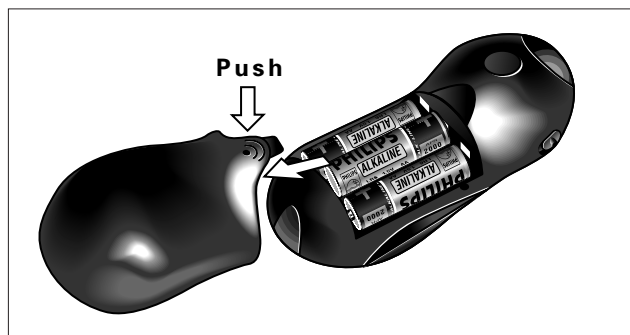

1. Press in and downward on the arrow to remove the battery cover.
2. Insert three AA size batteries for the remote control, making sure their polarities match the (+) and (-) marks inside the battery compartment.
3. Insert the side tabs of the battery cover into their slots and press the cover in until it is properly seated.

CAUTION!

Do not mix old and new batteries (also never mix alkaline and manganese batteries).









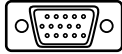
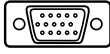

7. INSTALLATION

Video/computer cables and adapter

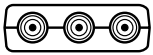
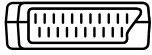
English

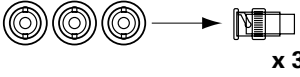
VIDEO/COMPUTER CABLES AND ADAPTER

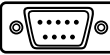
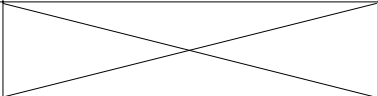
These accessories are supplied for connecting the projector to computer/Audiovisual equipment. The numbers in the left-hand column correspond with the numbers in the connection diagrams on the following pages.

No.	CABLE/ADAPTER	CONNECTIONS	
		Projector side	Computer/AV products side
1	Computer VGA Cable	Mini D-Sub 15P (male) 	 Mini D-Sub 15P (male)
2	RCA Audio Video Cable	RCA pin (male) x 3 	 RCA pin (male) x 3
3	Computer Audio Cable	3.5 mm stereo minijack 	 3.5 mm stereo minijack
4	Scart/RCA-AV Adapter		
5	S-Video Cable	Mini Din 4P (male) 	 Mini Din 4P (male)
6	BNC-RCA adapters (3x)	 x 3	 x 3
7	DIN-D-sub RS-232C cable	Mini Din 8P (male) 	 Mini D-Sub 9P (male)
8	USB mouse receiver		 USB connector 4P (female)

- Optional cables and adapter:**
- Computer cable Mini D sub (15 pin) BNC connectors (5x)
 - Programmable VGA/MAC adapter
 - RS-232C cable for external projector control: Mini D sub (9 pin female on both sides)
 - Computer audio cable 3,5 mm stereo minijack to RCA pin (2x)

CONNECTING TO A COMPUTER

General

- The data input (Data 1 and 2) is suitable for both Apple Macintosh computers (Power Book and Power Mac) as well as for IBM compatible PCs.
- The data output of IBM compatible PCs can be connected directly to the projector using standard computer VGA cable.
- Apple Macintosh computers may need a conversion plug (optional) added to the standard computer VGA cable.
- The figures in brackets **(1)** correspond to the figures in the diagram on page 10, the characters in brackets **(A)** correspond to the characters in **fig. 3** on page 4.
- **Caution:** Always switch off the projector and computer before making any connections!
After making all connections, turn the projector on first. The computer should always be turned on last.

Connecting an IBM-PC or a Macintosh computer using the standard 15 pin input connector (Data 1 and Data 2)

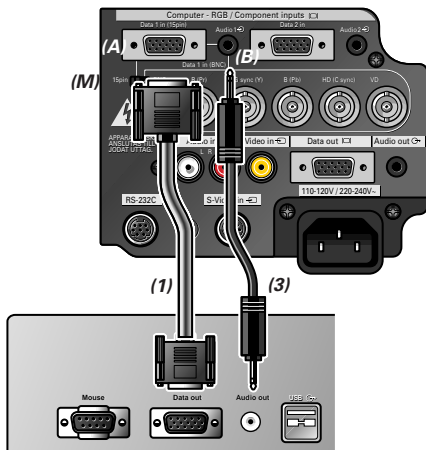

When connecting this projector to a computer, select "Computer/RGB" for "Signal Type" on the GUI "Options" menu. (See page 23.)

1. To use the Standard 15-pin connector, slide the 15 pin/BNC switch **(M)** on the rear terminals to the 15 pin position.
2. Connect one end of the supplied computer cable **(1)** to the Computer-RGB Input Data 1 **(A)** or 2 port on the projector.
3. Connect the other end to the Monitor output port on the computer. Secure the connectors by tightening the thumb screws.
4. To use the built-in audio system, connect one end of the supplied computer audio cable **(3)** to the Audio 1 **(B)** or 2 terminal on the projector.
5. Connect the other end to the Audio output terminal on the computer.

Notes:

- A Macintosh adapter may be required for use with some Macintosh computers. Contact your nearest Philips Authorised LCD Projector Dealer or Service Centre.
- Audio Input 1 accepts Data 1 port input, Audio Input 2 accepts Data 2 port input.
- A 3.5 mm minijack to RCA audio cable adapter may be necessary.
- When connecting the projector to a compatible computer other than an IBM-PC (VGA/SVGA/XGA/SXGA/UXGA) or Macintosh (i.e. Workstation), a separate cable may be needed. Please contact your dealer for more information.
- Connecting computers other than the recommended types may result in damage to the projector, the computer, or both.

"Plug and Play" function (when connecting to a 15 pin terminal)

- This projector is compatible with VESA-standard DDC 1/DDC 2B. The projector and a VESA DDC compatible computer will communicate their setting requirements, allowing for quick and easy setup.
- Before using the "Plug and Play" function, be sure to turn on the projector first and the connected computer last.
- The DDC, Plug and Play function of this projector operates only when used in conjunction with a VESA DDC compatible computer.

Connecting to an external RGB switcher or other compatible computers using the BNC input connectors (Data 1)

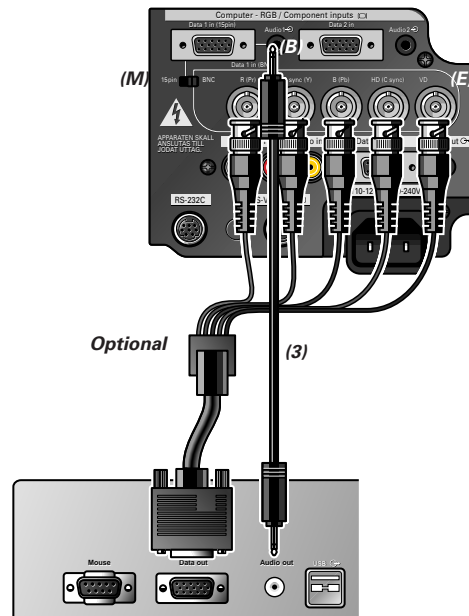

When connecting this projector to a computer, select "Computer/RGB" for "Signal Type" on the GUI options menu. (See page 23.)

1. To use the 5 BNC connectors, slide the 15 pin/BNC switch **(M)** on the rear terminals to the BNC position.
2. Connect each BNC connector to the corresponding BNC Input 1 terminal **(E)** on the projector.
3. Connect the R (Pr), G/G sync (Y), B (Pb), HD (C sync) and VD cables to the correct input terminals on the projector and an RGB switcher **(optional)** connected to the computer, or connect a 5 BNC cable **(optional)** directly from the input terminals on the projector to the computer.
4. To use the built-in audio system, connect one end of the supplied computer audio cable **(3)** to the Audio Input 1 terminal **(B)** on the projector.
5. Connect the other end to the Audio output terminal on the computer or external audio system.

Notes:

- This projector uses a 5 BNC computer input to prevent deterioration of image quality.
- A 3.5 mm minijack to RCA audio cable adapter may be necessary.
- When connecting the projector to a compatible computer other than an IBM-PC (VGA/SVGA/XGA/SXGA/UXGA) or Macintosh (i.e. Workstation), a separate cable may be needed. Please contact your dealer for more information.
- Connecting computers other than the recommended types may result in damage to the projector, the computer, or both.

CONNECTING TO VIDEO EQUIPMENT

General

- The figures in brackets **(1)** correspond to the figures in the diagram on page 10.
- The characters in brackets **(A)** correspond to characters in **fig. 3** on page 4.
- **Caution:** Always turn off the projector while connecting to video equipment, in order to protect both the projector and the equipment being connected.

VCR, Laser disc, other audiovisual equipment using standard video input

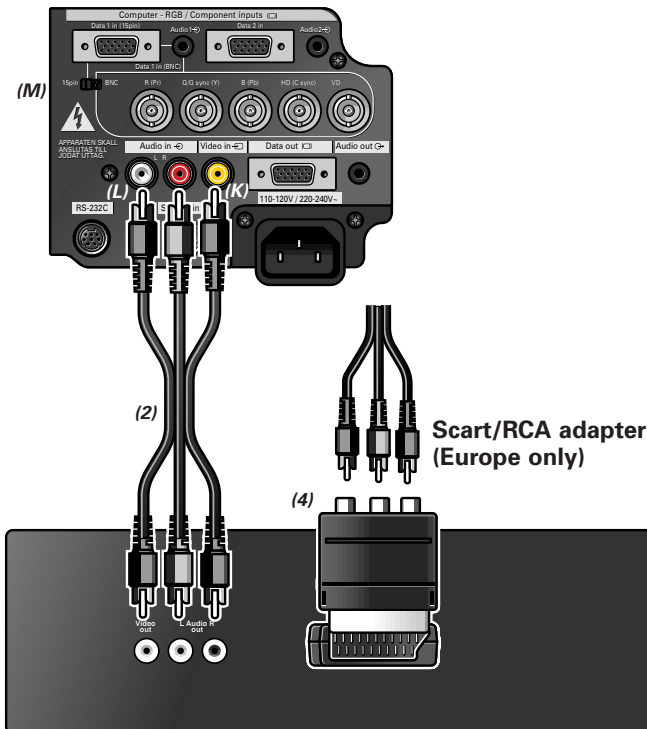

1. Connect the yellow RCA connector **(K)** to the corresponding yellow Video Input terminal on the projector and the Video output terminal on the video source.
2. To use the built-in audio system, connect the red and white RCA connectors to the corresponding red and white Audio Input terminals on the projector **(L)** and the Audio output terminals on the video source.

In case your VCR, Laser Disc player, video camera or TV is equipped with a Scart connector:

1. Connect the Scart/RCA Audio Video adapter supplied **(4)** to the Scart connector of the VCR, Laser Disc player, video camera or TV.
2. Plug the video/audio connection cable **(2)** supplied into both the adapter and the Video in **(K)** and Audio in(L/R) sockets **(L)** of the projector.

In case your Audiovisual equipment is equipped with a S-Video connector:

The S-Video Input terminal uses a video signal system in which the picture is separated into a color and a luminance signal to realize a higher-quality image.

1. Plug the S-Video connection cable supplied **(5)** into the Audiovisual equipment and the S-Video in socket **(I)** of the projector.
2. Plug an audio connection cable **(optional)** or the video/audio connection cable **(2)** supplied into both the Audio in L/R sockets **(L)** of the projector and the Audio out L/R sockets of the Audiovisual equipment.
Insert the white plug into the L socket and the red plug into the R socket.

Note:

If your video equipment does not have an S-video output terminal, use the Composite video output terminal.

DVD, DTV, other component video equipment using 5 BNC input

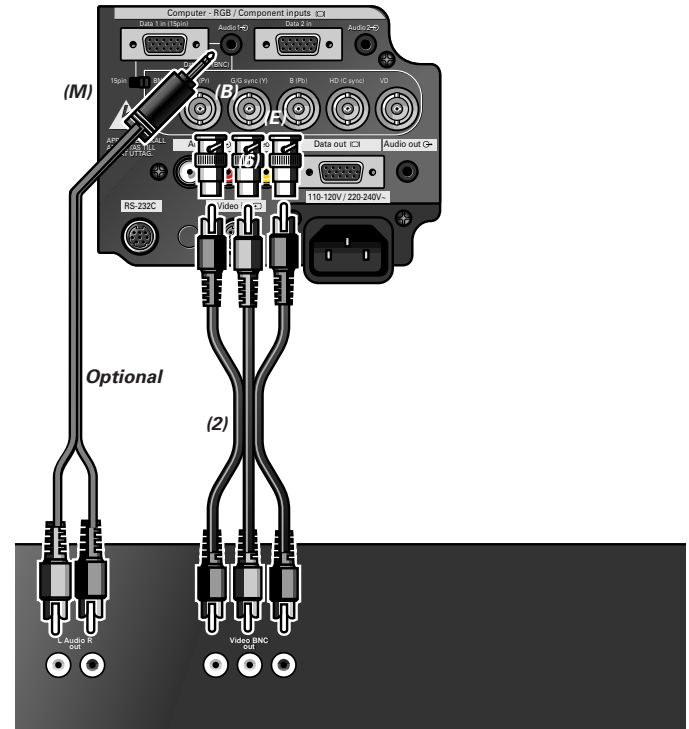

1. To use the 5 BNC connector, slide the 15 pin/BNC switch **(M)** on the rear terminals to the BNC position. Connect each BNC connector to the corresponding BNC Input 1 terminals **(E)** on the projector. (BNC-RCA adapters **(6)** are included for use with RCA type cables and sources.)
2. Connect the other end of the cable **(2)** to the corresponding terminals of a DVD player or DTV decoder.
3. To use the built-in audio system, connect one end of the computer audio cable **(optional)** to Audio Input 1 terminal **(B)** on the projector. Connect the other end to the Audio output terminal on the video source.

When connecting the projector to a DVD player or a DTV decoder equipped with Component video outputs, select "Component" for "Signal Type" in the GUI "Options" menu (see page 23).

Note:

After the use of "Component", when connecting to a computer again, select "Computer/RGB" for "Signal Type" in the GUI menu (see page 23).

CONNECTING TO AUDIO EQUIPMENT/THE REMOTE CONTROL MOUSE RECEIVER

General

- The figures in brackets **(1)** correspond to the figures in the diagram on page 10.
- The characters in brackets **(A)** correspond to characters in **fig. 3** on page 4.

CONNECTING TO AUDIO EQUIPMENT

CAUTION!

Always turn off the projector while connecting to audio components, in order to protect both the projector and the components being connected. By using external audio components, the volume can be amplified for better sound.

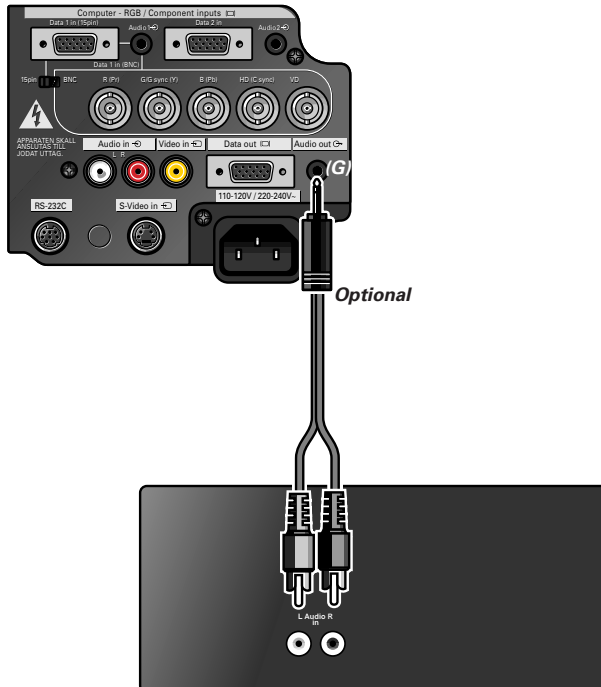

- Connect the Audio in L/R sockets of an amplifier or stereo system to the Audio out socket **(G)** of the projector. For this, use an audio connection cable **(optional)**.

CONNECTING THE REMOTE CONTROL MOUSE RECEIVER

When the RS-232C port on the projector is connected to a computer with an RS-232C cable (cross type, sold separately), the computer can be used to control the projector and check the status of the projector. See page 25 for details.

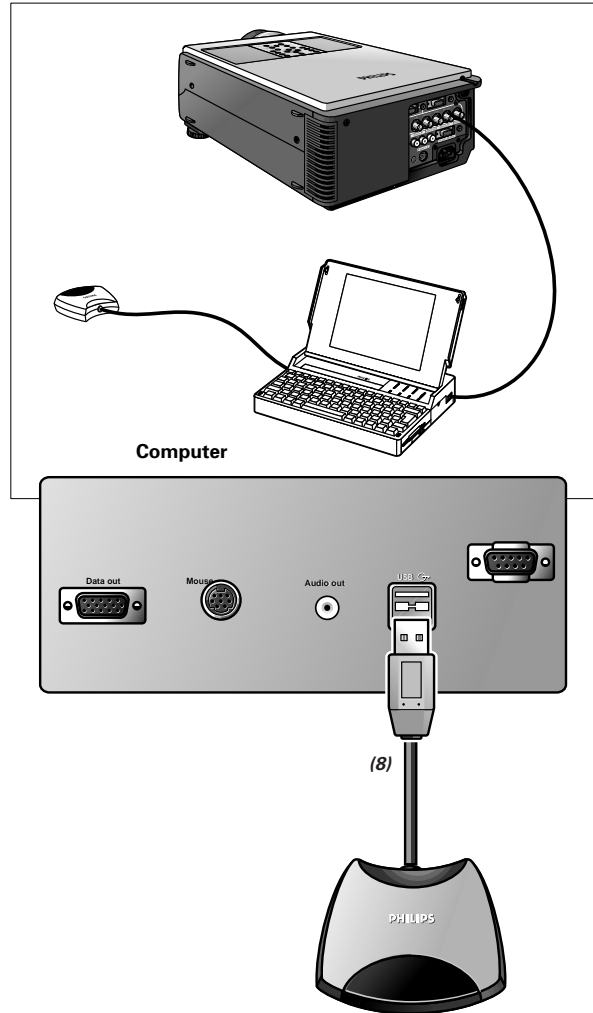

- Connect the supplied USB mouse receiver to the corresponding USB terminal on the PC.

CAUTION!

- The minimum system requirements for the USB mouse receiver are Windows 98 and/or Windows NT 5.0 or higher.

PREPARATION

Turning on/off the power

1. Make the necessary connections before proceeding.
Connect the power cord to a wall outlet.
The Power indicator lights up red and the projector enters standby mode.
2. Press Power ON.
The power indicator lights up green and the flashing green Lamp indicator shows that the lamp is warming up. Wait until the indicator stops flashing before operating the projector.
If the power is turned off and then immediately turned on again, it may take a short while before the lamp turns on.

Notes:

- If the bottom filter cover is not securely installed, the Power indicator flashes in red.
- After the projector is unpacked and turned on for the first time, a slight odour may be emitted from the exhaust vent. This odour will soon disappear with use.

Remarks:

- 1) When the power is on, the Lamp indicator (Lamp) indicates the status of the lamp.
Green: lamp is ready.
Flashing green: warming up.
Red: change the lamp.
- 2) After the picture is displaying, the warming-up indicator "WARMING UP, PLEASE WAIT" is shown
3. Press the button of the desired input mode. Data 1, Data 2, Video.
On the remote control press the Input button to select the desired input mode (Data 1, Data 2, Video).
Press Input again to change the mode. Example:



- When no signal is being received, "NO SIGNAL" will be displayed. When a signal that the projector is not preset to receive is being received, "NOT REG." will be displayed.
- 4. Press Volume to adjust the volume. (on the local keyboard only)



5. Press A/V Mute to temporarily turn off the sound and picture.



Press A/V Mute again to turn the sound and picture back on.

6. Press Standby/OFF for switching off the projector.

Notes:

- Wait until the cooling fan stops (about 2 minutes after the projector has been switched off) before disconnecting the power cord.
- The power can be turned on again by pressing Power ON. When the power is turned on, the Power indicator and the Lamp indicator light green.

USING THE REMOTE CONTROL (FIG 2)

The remote control has the following two functions:

- Projector control
- Wireless mouse
- Slide the remote control power ON/OFF switch into the ON position for switching the projector and the Remote Control unit to on.
- The remote control can be used to control the projector within the ranges shown below.
- The USB mouse receiver can be used with the remote control to control the mouse functions of a connected computer within the ranges shown below.

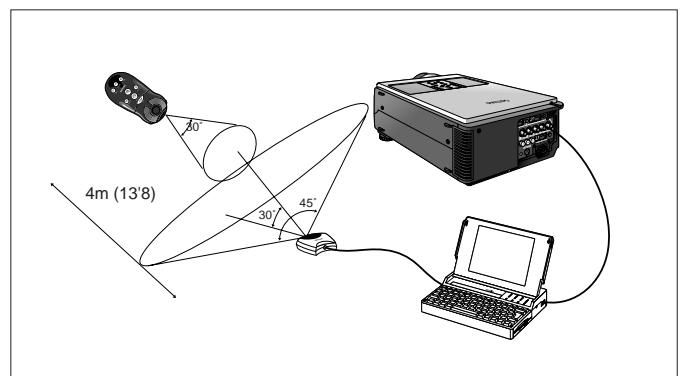
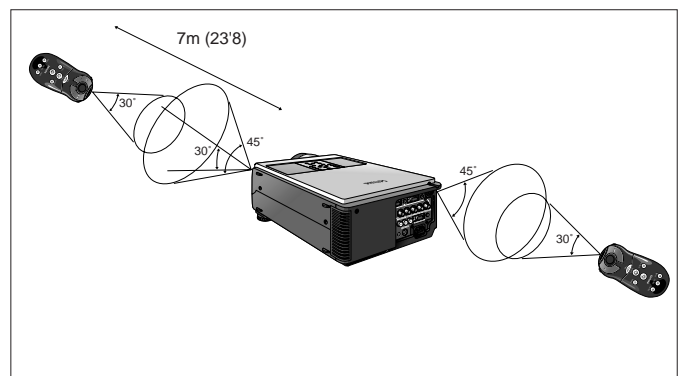

Using the remote control in a dark room

- Press BACKLIGHT, and the buttons will light up.

Notes:

- Be sure the supplied USB mouse receiver is connected to your computer.
- The wireless mouse may not operate correctly if your computer serial port is not correctly set up. Refer to the computer's operation manual for details of setting up/installing the mouse driver.
- For one-button mouse systems, use either the LEFT-CLICK or RIGHT-CLICK button.

USING THE GUI (GRAPHICAL USER INTERFACE) MENU SCREENS

This projector has two sets of menu screens (Data/Video) that allow you to adjust the image and various projector settings. These menu screens can be operated from the projector or the remote control with the following buttons.

Note:

The On Screen Displays will automatically disappear when no changes have been made within 30 seconds.

DATA MODE MENU CONTROL

1. Press Menu to display the Data mode menu bar.

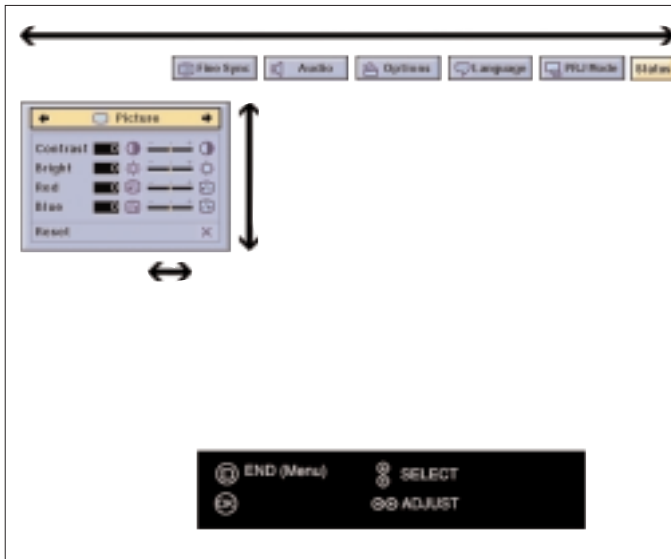

2. Press < / > to select an adjustment menu on the menu bar.
3. Press Δ / ▽ to select a specific adjustment item.
4. To display a single adjustment item, press OK after selecting the item. Only the menu bar and the selected adjustment item will appear.
5. Press < / > to adjust the item.
6. Press Menu to exit from the GUI.

VIDEO MODE MENU CONTROL

1. Press Menu to display the Video mode menu bar.

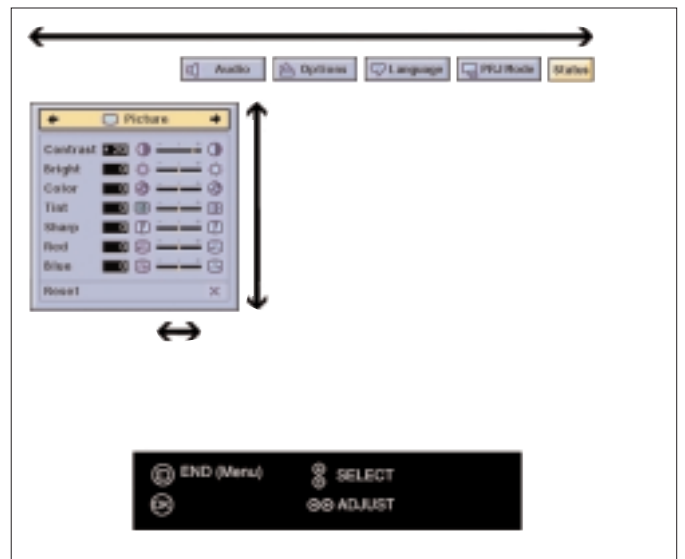

2. Press < / > to select an adjustment menu on the menu bar.
3. Press Δ / ▽ to select a specific adjustment item.
4. To display a single adjustment item, press OK after selecting the item. Only the menu bar and the selected adjustment item will appear.
5. Press < / > to adjust the item.
6. Press Menu to exit from the GUI.

LANGUAGE SELECTION

English is the default setting language for the On-screen Display. It can be changed to German, Spanish, Dutch, French, Italian, Swedish or Portuguese.

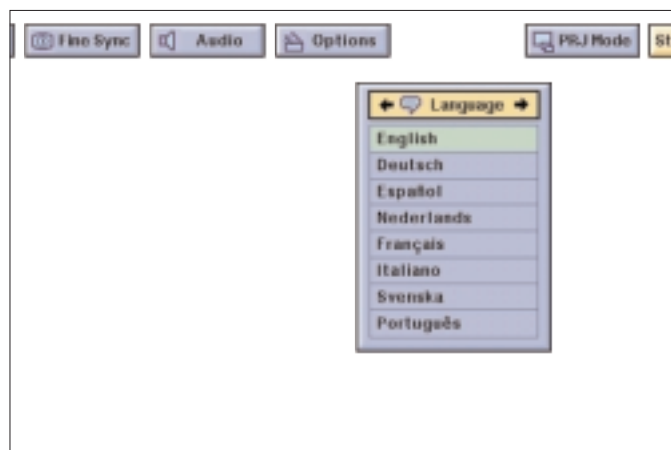

1. Press Menu.
 - The menu bar appears on the screen.
2. Press < / > to select "Language".
3. Press Δ / ▽ to select the desired language.
4. Press OK to save the setting. The On-Screen Display is now programmed to display in the language selected.
5. To exit from the GUI, press Menu.

PICTURE CONTROL

- The projector's picture is set to standard specifications at the factory. However, you can adjust the image to suit your own preferences by using the Data or Video ADJUST feature.
- The projector will store the last used settings for every source. So when you switch from one source to another, the settings of the source switched from will be stored and the settings of the source switched to will be recalled.
- When the projector is switched off and on again the settings for the selected source will be recalled again.
- Three memory modes allow you to adjust and save up to three sets of settings (see 'Personal Preferences').

DATA MODE INPUT SIGNAL

Data mode input selection

Ordinarily, the type of input signal is detected and the correct resolution mode is automatically selected. However, for some signals, "Special Modes" on the "Fine Sync" menu screen may need to be changed to match the computer display mode.

1. Press Menu.
2. Press ◀ / ▶ to select "Fine Sync".
3. Press ▲ / ▼ to select "Special Modes".

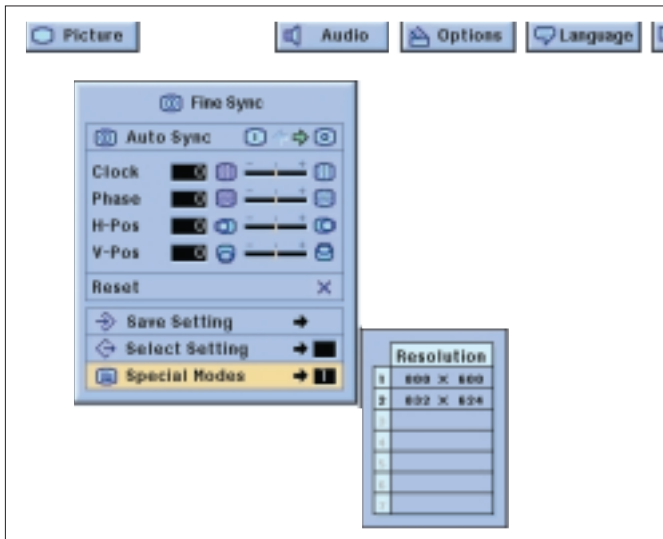

4. Press OK to move into the Special Modes.
5. Press ▼ to select the optimal resolution mode.
6. Press OK to save the setting.
7. To exit from the GUI, press Menu.

Notes:

- Avoid displaying computer patterns which repeat every other line (horizontal stripes). (Flickering may occur, making the image hard to see.)
- When inputting DTV 480P signals, select "480P" in step 4 above.

VIDEO MODE INPUT SIGNAL

Video mode system selection

The video input system mode is preset to "Auto"; however, it can be changed to a specific system mode, if the selected system mode is not compatible with the connected audiovisual equipment.

1. Press Menu.
2. Press ◀ / ▶ to select "Options".
3. Press ▲ / ▼ to select "Video System", and then press OK.

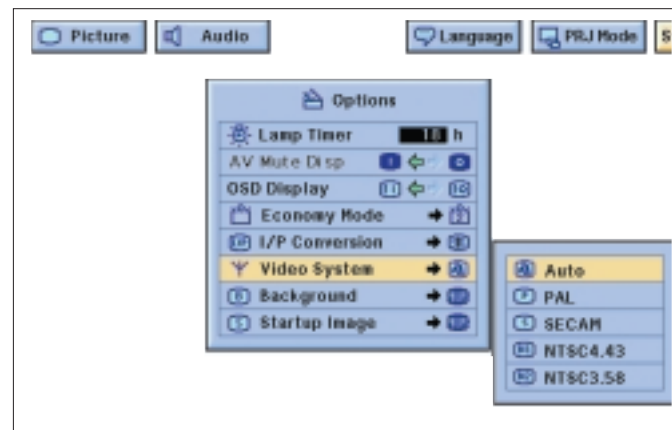

4. Press ▼ to select the desired video system mode.
5. Press OK to save the setting.
6. To exit from the GUI, press Menu.

DATA MODE DISPLAY

Data display Fine Sync adjustments

When displaying computer patterns which are very detailed (tiling, vertical stripes, etc.), interference may occur between the LCD pixels, causing flickering, vertical stripes, or contrast irregularities in portions of the screen. Should this occur, adjust "Clock," "Phase," "H-Pos" and "V-Pos" for optimum computer image (Fine Sync adjustment).

1. Select the desired computer input mode by pressing either Data 1 or Data 2 at the projector local keyboard or toggling the Input button on the Remote Control unit.
2. Press Menu. Menu bar and "Picture" menu screen appear. GUI operation guide is also displayed.

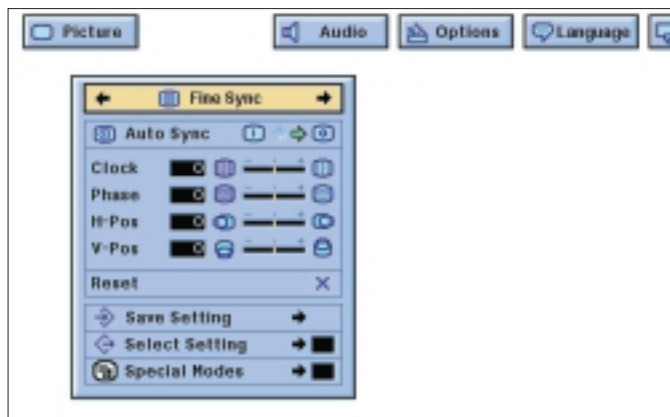

3. Press \triangleleft / \triangleright to select "Fine Sync".
4. Press \triangle / ∇ to select a specific adjustment item.

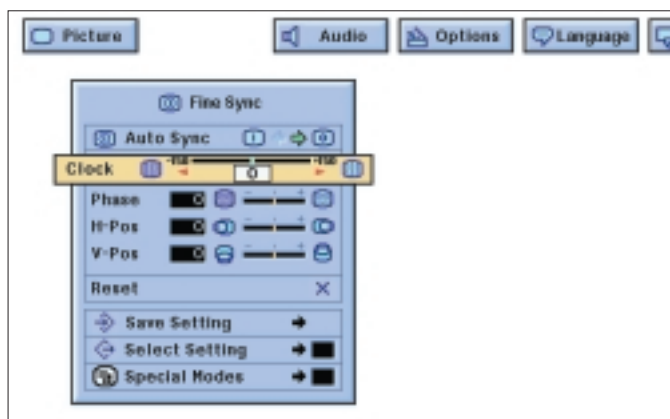

5. Press \triangleleft / \triangleright to move the "1" mark of the selected adjustment item to the desired setting.
6. To exit from the GUI, press Menu.

Note:

To reset all adjustment items, select "Reset" on the "Fine Sync" menu screen and press OK.

Auto Sync Adjustment

- Used to automatically adjust a computer image.
- Auto Sync adjustment can be made manually by pressing Auto sync (either on local keyboard and remote control), or automatically by setting "Auto Sync" to "ON" in the projector's GUI menu.

When "Auto Sync" is set to "ON":

- The sync adjustment is automatically made each time the projector is turned on while connected to a computer or the input selection is changed.
- The Auto Sync adjustment setting previously made is cleared when the projector's setting is changed.

1. Press Menu.
2. Press \triangleleft / \triangleright to select "Fine Sync".
3. Press \triangle / ∇ to select "Auto Sync".
4. Press \triangleleft / \triangleright to select "ON".
5. To exit from the GUI, press Menu.

- Automatic adjustments can be made by pressing Auto sync.
- When the optimum image cannot be achieved with Auto Sync adjustment, use manual adjustments. (See "Data display Fine Sync adjustment").

During Auto Sync adjustment, the On-Screen Display changes:

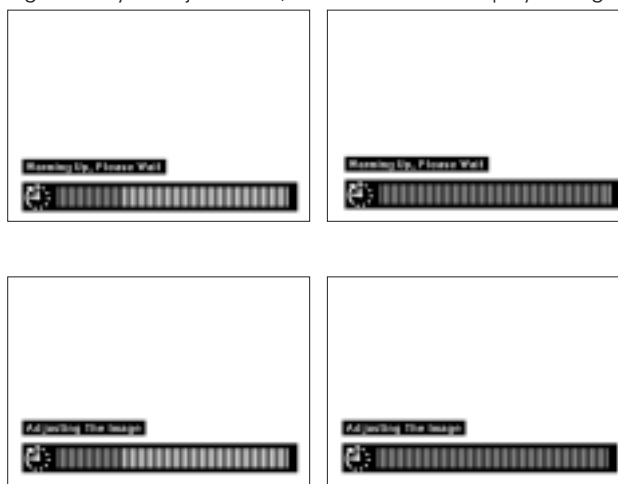

Note:

Auto Sync adjustment may take some time to complete, depending on the image of the computer connected to the projector.

Auto Sync Display Function

Normally, an image is not superimposed during Auto Sync adjustment. You can, however, choose to superimpose a background image during Auto Sync adjustment.

1. Press Menu.
2. Press \triangleleft / \triangleright to select "Options"
3. Press \triangle / ∇ to select "Auto Sync Disp"

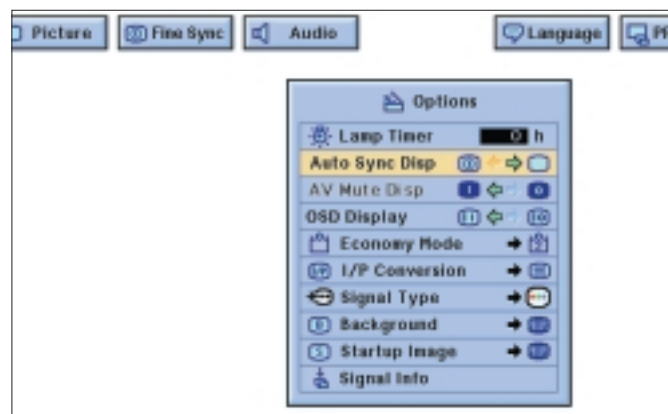

4. Press \triangleleft / \triangleright to select "☐" to superimpose a background image or "Ⓚ" to remove the background image during Auto Sync adjustment.
5. To exit from the GUI, press Menu.

DATA / VIDEO MODE DISPLAY

Picture display adjustments

For video signal input, the following adjustments can be made:

- **Contrast** - adjusts the overall contrast intensity;
- **Bright** - adjusts the picture brightness;
- **Color** - adjusts the colour saturation of the projected image;
- **Tint** - for more purplish/greenish skin tones (NTSC only);
- **Sharpness** - adjusts the overall picture sharpness;
- **Red** - for weaker/stronger red images;
- **Blue** - for weaker/stronger blue images;
- **Reset** - all image adjustment items are returned to the factory preset settings.

Note:

"Color", "Tint" and "Sharpness" do not appear for Computer/RGB input in Data mode.

1. Press Menu.
- Menu bar and "Picture" menu screen appear. GUI operation guide is also displayed.
2. Press Δ / ∇ to select a specific adjustment item.



3. Press \leftarrow / \rightarrow to move the mark of the selected adjustment item to the desired setting.

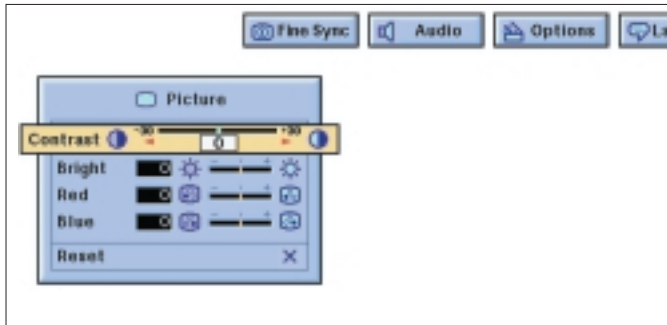

4. To exit from the GUI, press Menu.

Notes:

- To reset all adjustment items, select "Reset" on the "Picture" menu screen and press OK.
- The adjustments can be stored separately in the "Data 1", "Data 2" and "Video" modes.
- For Component input in Data mode, "Sharpness" is adjustable only when a DVD player is connected.

AUDIO CONTROL

This projector's audio is factory preset to standard settings. However, you can adjust it to suit your own preferences by adjusting the following audio settings.

- **Balance** - adjusts audio level of left and right speaker;
- **Treble** - adjusts the high tones;
- **Bass** - adjusts the bass tones;
- **Reset** - All audio adjustment items are returned to the factory preset settings.

1. Press Menu. Menu bar and "Picture" menu screen appear. GUI operation guide is also displayed.

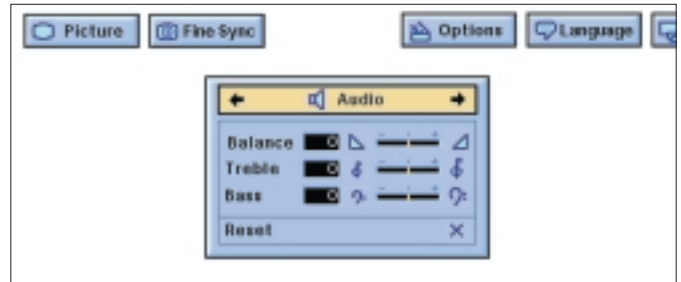

2. Press \leftarrow / \rightarrow to select "Audio".
3. Press Δ / ∇ to select a specific adjustment item.

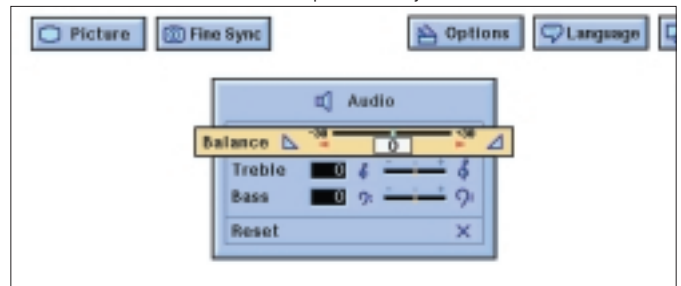

4. Press \leftarrow / \rightarrow to move the mark of the selected adjustment item to the desired setting.
5. To exit from the GUI, press Menu.

Notes:

- To reset all adjustment items, select "Reset" on the "Audio" menu screen and press OK.
- The volume can also be adjusted with the "-" Volume "+" buttons on the projector.

PERSONAL PREFERENCES

This projector allows you to store up to seven adjustment settings for use with various computers. Once these settings are stored, they can be easily selected each time you connect the computer to the projector.

Saving/changing the adjustment setting

1. Press Menu.
2. Press \leftarrow / \rightarrow to select "Fine Sync".

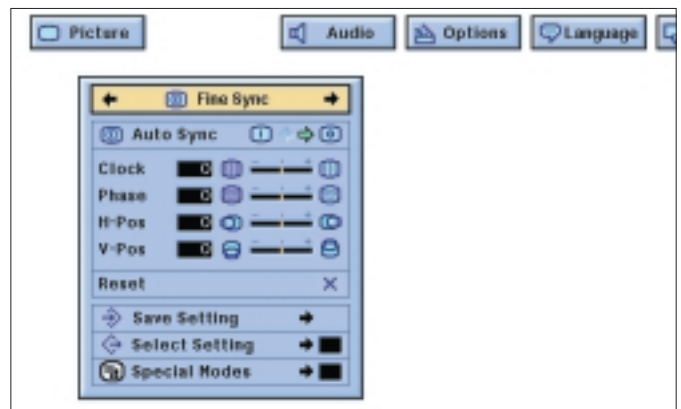

3. Press Δ / ∇ to select "Save Setting," and then press OK.

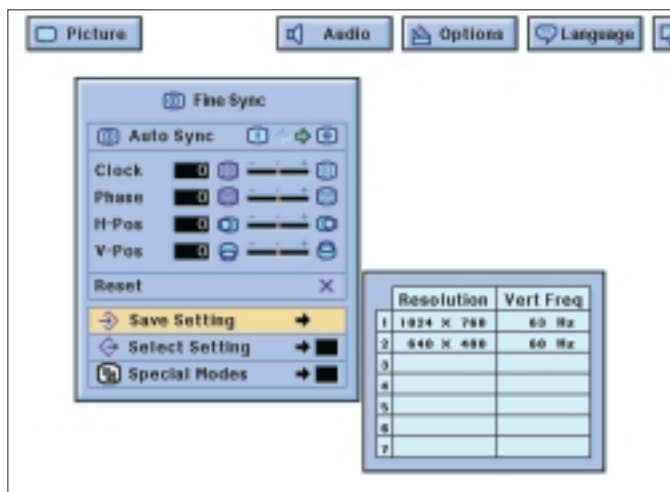

4. Press Δ / ∇ to select the desired memory location of the setting.

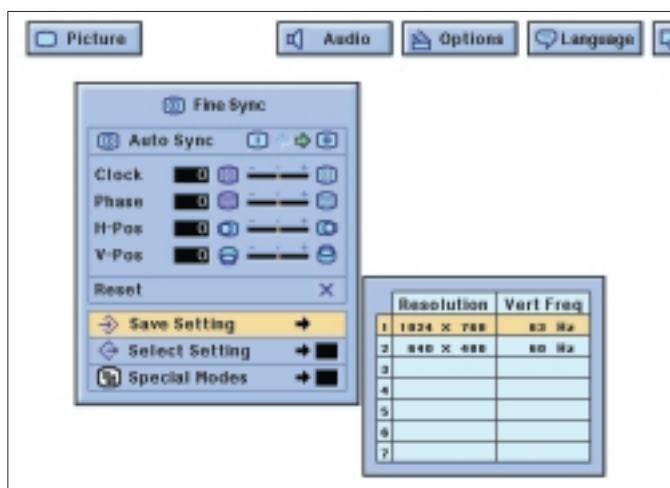

5. Press OK to save the setting.

6. To exit from the GUI, press Menu.

Selecting a saved setting

1. Press Menu.
2. Press \triangleleft / \triangleright to select "Fine Sync".
3. Press Δ / ∇ to select "Select Setting," and then press \triangleright .
4. Press Δ / ∇ to select the desired memory setting.
5. Press OK to select the setting.
6. To exit from the GUI, press Menu.

Notes:

- If the memory position has not been set, the resolution and frequency will not be displayed.
- When selecting the stored adjustment setting with "Select Setting," the computer system should match the stored setting.

OTHER SETTINGS

Reverse/Invert Image Function

This projector is equipped with a reverse/invert image function which allows you to reverse or invert the projected image for various applications.

Front

Normal image

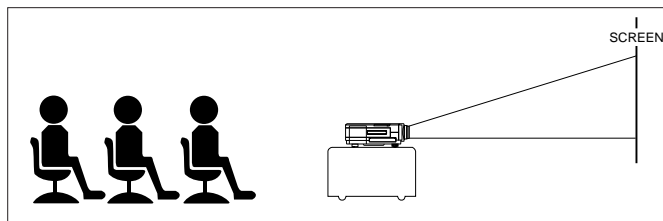

Ceiling+Front

Inverted image

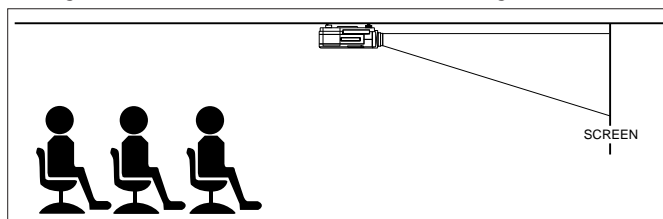

Rear

Reversed image

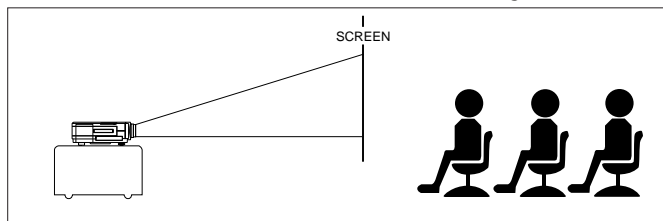

Ceiling+Rear

Reversed and inverted image

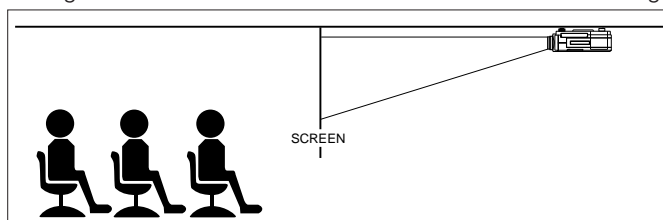

1. Press Menu.
2. Press \triangleleft / \triangleright to select "PRJ Mode".



3. Press Δ / ∇ to select the desired projection mode.
4. Press OK to save the setting.
5. To exit from the GUI, press Menu.

Projection using a mirror

- Place a mirror (normal flat type) in front of the lens.
- The image reflected from the mirror is projected onto the screen.
- Optimal image quality is produced with the projector positioned perpendicular to the screen with all feet flat and level.

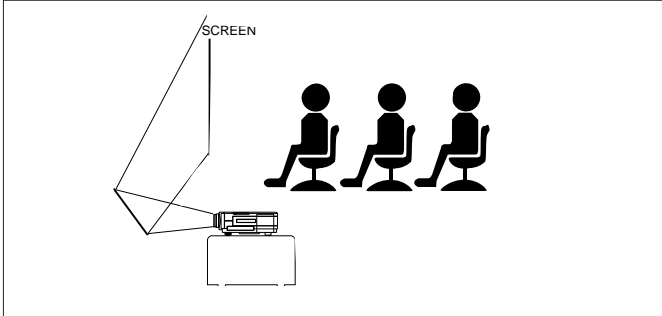

CAUTION!

When using a mirror, be sure to carefully position both the projector and the mirror so the light does not shine into the eyes of the audience.

Ceiling-mount Setup

- It is recommended that you use the optional ceiling-mount bracket for this installation.
- Before mounting the projector, contact your nearest Authorised LCD Projector Dealer or Service Centre to obtain the recommended ceiling-mount bracket (sold separately).
- When the projector is in the inverted position, use the upper edge of the screen as the base line.
- Use the projector's menu system to select the appropriate projection mode.

Digital Freeze function (D-Freeze) (on projector keyboard only)

This function allows you to instantly freeze a moving image. This is useful when you want to display a still image from a computer or video, giving you more time to explain the image to the audience. You can also use this function to display a still image from a computer while you make preparations for the next computer images to be presented.

1. Press D-Freeze to freeze the image.
2. Press D-Freeze again to return to the moving image.



Digital image magnification (D-Zoom)

This function allows you to magnify a specific portion of an image. This is useful when you want to display a detailed portion of the image.

1. Press D-Zoom. Each time D-Zoom is pressed, the image will be magnified.
2. When the image is magnified, you can pan and scan around the image by using Δ , ∇ , \triangleleft or \triangleright .

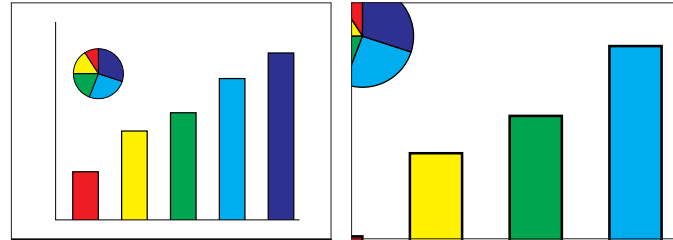

- Each time D-Zoom is pressed, image magnification toggles as shown below.

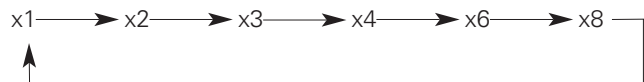

- If the input signal is changed during digital image magnification, the image will return to 1. The input signal is changed:
 - when Data 1, Data 2 or Video is pressed on the projector, or Input on the remote control,
 - when the input signal is interrupted, or
 - when the input resolution and refresh rate changes.

Digital Video Effect correction (V-Effect) (on projector keyboard only)

- V-effect is an image quality enhancement function that offers a richer image by brightening the darker portions of the image without altering the brightness of the brighter portions.
- Two V-effect settings are available to allow for differences in the images played and in the brightness of the room.
- When you are watching images with frequent, dark scenes, such as a film or concert, or when you are watching images in a bright room, this feature makes the dark scenes easier to see and gives the impression of greater depth in the image.

V-Effect Modes

Selected Mode	V-effect
V-Effect off	Standard picture without Video Effect correction.
V-Effect on	Gives greater depth to darker portions of image.

- Press V-Effect. Each time V-Effect is pressed, the V-effect level toggles as shown below.



Picture display mode

This function allows you to modify or customise the picture display mode to enhance the input image. Depending on the input signal, you can choose NORMAL, WIDE, DOT BY DOT, DOT BY DOT (WIDE), or FIT TO SCREEN image.

- Each time V-FORMAT is pressed, the picture mode changes as shown below.

Mode Input signal	DTV		COMPUTER SXGA
	4:3 480 P	16:9 720 P	
NORMAL	1024x768	1024x576	960x768
WIDE	1024x576	–	1024x768
DOT BY DOT	640x480	1280x720	1280x1024
DOT BY DOT (WIDE)	853x480	–	–

Notes:

- "FIT TO SCREEN" is displayed only when SXGA signals that are not in 4:3 aspect ratio are input.
- DOT BY DOT mode displays images in their native resolution and not expanded to fit the LCD resolution.

NORMAL	WIDE	DOT BY DOT	DOT BY DOT (WIDE)
For DTV decoder RGB signal in 4:3 aspect ratio			
For DTV decoder RGB signal in 16:9 aspect ratio			
For COMPUTER/RGB signal in 4:3 aspect ratio			

AV Mute Function

This function can be used for muting the sound of the projector (or an external connected sound amplifier) and for muting the picture.

Press A/V Mute.

- "AV Mute" is displayed on the screen.



To return to the original projected image, press A/V Mute again.

Turning off the On-Screen Display (OSD)

The On-screen Display ("AV Mute") that appears during mute screen can be turned off. When "AV Mute Disp" is set to "☐" in the GUI menu, "AV Mute" will not be displayed during function.

1. Press Menu.
2. Press ◀ / ▶ to select "Options".

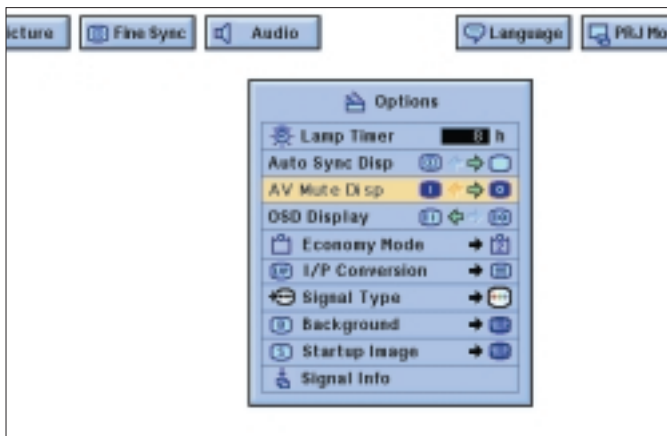

3. Press ▲ / ▼ to select "AV Mute Disp".
4. Press ◀ / ▶ to select "☐" to turn on or "☑" to turn off the function.
5. To exit from the GUI, press Menu.

On-Screen Display Override Function

This function allows you to turn off the on-screen messages that appear during "input select". Once "OSD Display" is set to "☐" in the GUI menu, the on-screen messages will not appear when Data 1, Data 2 or Video are pressed on the projector or Input on the remote control.

1. Press Menu.
2. Press ◀ / ▶ to select "Options".
3. Press ▲ / ▼ to select "OSD Display".



4. Press ◀ / ▶ to select "☐" to turn on or "☑" to turn off the On-Screen Display.
5. To exit from the GUI, press Menu.

Economy mode

This function allows you to reduce the power consumption when the projector is off.

Economy Modes

Selected mode	Automatic Power	RS232C/Monitor out
Shutoff		
Mode 1	ON	OFF
Mode 2	ON	ON
Mode 3	OFF	OFF
Mode 4	OFF	ON

Note:

The projector is factory preset to Mode 2.

1. Press Menu.
2. Press ◀ / ▶ to select "Options".

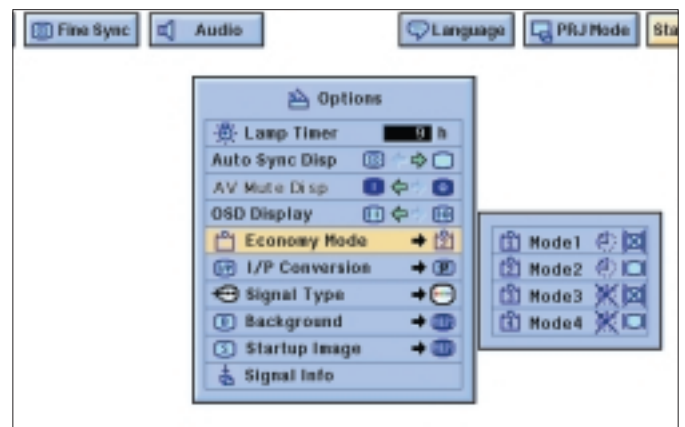

3. Press ▲ / ▼ to select "Economy Mode", and then press ▶.
4. Press ▲ / ▼ to select the desired mode.
5. Press OK to save the setting.
6. To exit from the GUI, press Menu.

Automatic Power Shutoff Function

When no input signal is detected for more than 15 minutes, the projector will automatically shut off. The on-screen message on the left will appear five minutes before the power is automatically turned off.



Interlaced (I)/Progressive (P) conversion

This function allows you to select either an interlaced display or a progressive display of a video signal. The progressive display projects a smooth video image.

1. Press Menu.
2. Press ◀ / ▶ to select "Options".

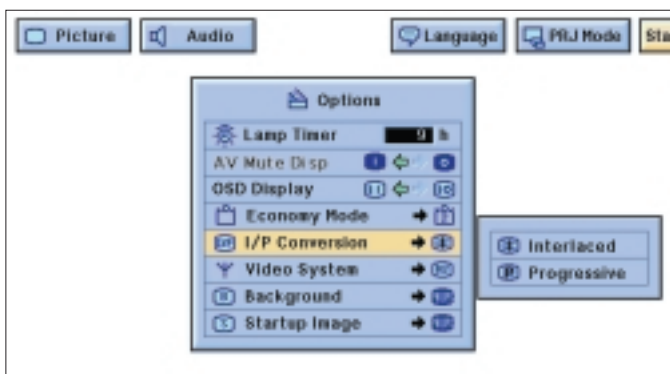

3. Press ▲ / ▼ to select "I/P Conversion," and then press ▶.
4. Press ▲ / ▼ to select "Interlaced" or "Progressive."
5. Press OK to save the setting.
6. To exit from the GUI, press Menu.

Checking the Lamp Usage Time

This function allows you to check the accumulated lamp usage time.

1. Press Menu.
2. Press ◀ / ▶ to select "Options." The lamp usage time will be displayed.

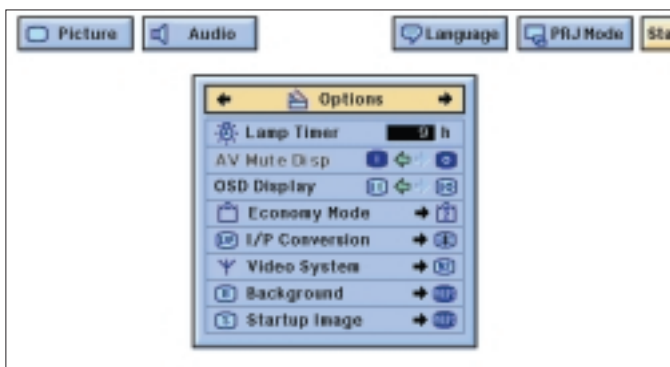

- It is recommended that the lamp be replaced after approximately 2,000 hours of usage. See page 25 for details.

Selecting signal type (Data 1 only)

This function allows you to select the input signal type.

1. Press Menu.
2. Press ◀ / ▶ to select "Options".
3. Press ▲ / ▼ to select "Signal Type," and then press ▶.

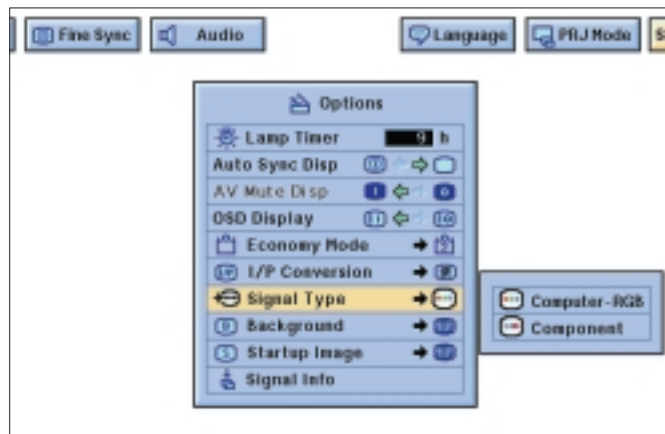

4. Press ▲ / ▼ to select "Computer/RGB" or "Component."
5. Press OK to save the setting.
6. To exit from the GUI, press Menu.

Checking the Input Signal

1. Press Menu.
2. Press ◀ / ▶ to select "Options".
3. Press ▲ / ▼ to select "Signal Info" to display the current input signal.

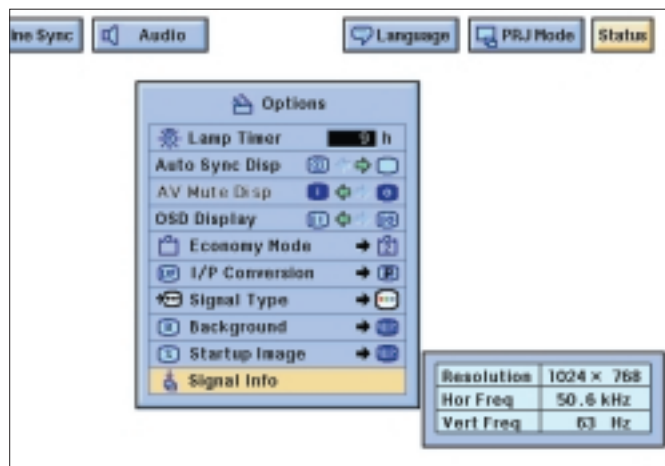

4. To exit from the GUI, press Menu.

Note:

In Video mode, the resolution and frequency settings will not be displayed. This function allows you to check the current input signal information.

Setting a Background Image

This function allows you to select the image displayed when no signal is being sent to the projector.

Description of Background Images

Selected item	Background image
Philips	PHILIPS default image
Blue	Blue screen
None	Black screen

1. Press Menu.
2. Press ◀ / ▶ to select "Options".
3. Press ▲ / ▼ to select "Background", and then press ▶.

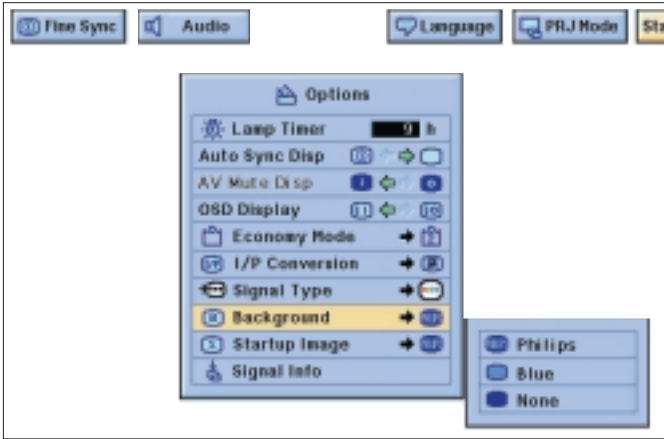

4. Press ▲ / ▼ to select the background image you want to display on the screen.
5. Press OK to save the setting.
6. To exit from the GUI, press Menu.

Selecting a Startup Image

– This function allows you to specify the image to be displayed upon the projector's startup.

Description of Startup Images

Selected item	Background image
Philips	PHILIPS default image
None	Black screen

1. Press Menu.
2. Press ◀ / ▶ to select "Options".
3. Press ▲ / ▼ to select "Startup Image", and then press ▶.

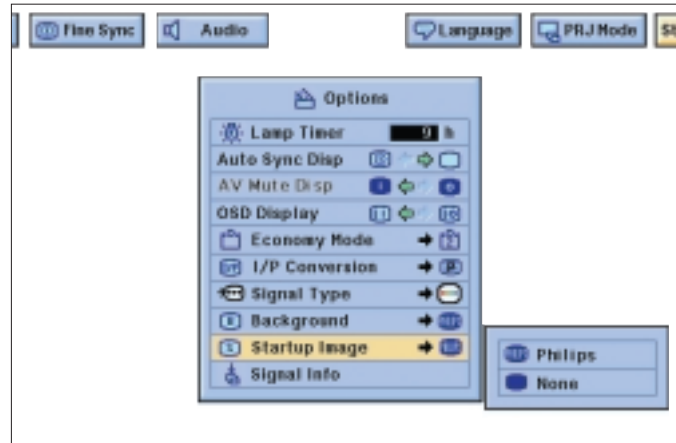

4. Press ▲ / ▼ to select the startup image you want to display on the screen.
5. Press OK to save the setting.
6. To exit from the GUI, press Menu.

STATUS FUNCTION

This function can be used to display all the adjusted settings on the screen simultaneously.

1. Press Menu.
2. Press ◀ / ▶ to select "Status".

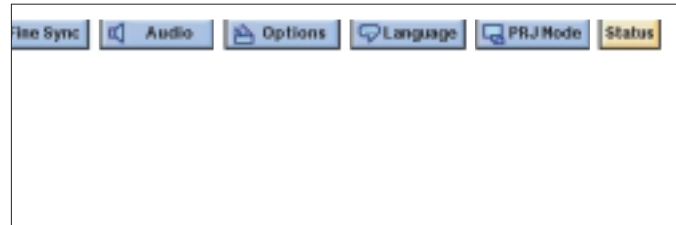

3. Press OK to display all the adjusted settings.

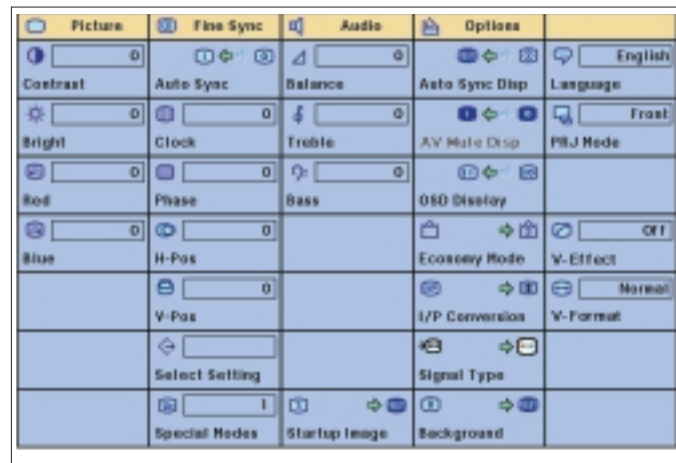

4. To exit from the GUI, press Menu.

9. ADDITIONAL INFORMATION Connecting RS-232C port/Maintenance

CONNECTING RS-232C PORT

When the RS-232C port on the projector is connected to a computer with an RS-232C cable (cross type, sold separately), the computer can be used to control the projector and check the status of the projector.

1. Connect the supplied DIN-D-sub RS-232C cable to the RS-232C port on the projector.
2. Connect a RS-232C cable (sold separately) to the other end of DIN-D-sub RS-232C cable and to the serial port on the computer. See page 13 for details.

CAUTION!

- Do not connect or remove RS-232C cable to or from the computer while it is on. This may damage your computer.
- The wireless mouse or RS-232C function may not operate if your computer port is not correctly set up. Please refer to the operation manual of the computer for details on setting up/installing the correct mouse driver.
- A Macintosh adapter may be required for use with some Macintosh computers. Contact your nearest Philips Authorised LCD Projector Dealer or Service Centre.
- For more details on specification of the use of the RS-232C please contact your nearest Philips Authorised LCD projector Dealer or Service Centre.

AIR FILTER MAINTENANCE

- This projector is equipped with two air filters to ensure the optimal operating condition of the projector.
- The air filters should be cleaned every 100 hours of use. Clean the filters more often when the projector is used in a dusty or smoky location.
- Have your nearest Philips Authorised LCD Projector Dealer or Service Centre exchange the filter when it is no longer possible to clean it.

Cleaning and replacing the bottom air filter

1. Unplug the power cord.
2. Remove the bottom filter cover.
 - Turn over the projector. Press the tab and lift open the filter cover in the direction of the arrow.

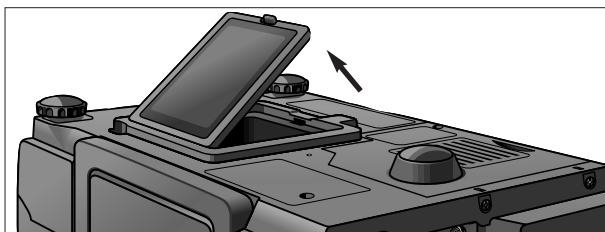
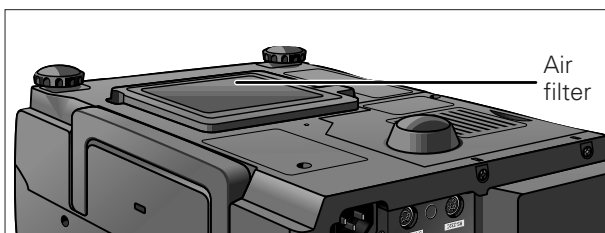

3. Remove the air filter.
 - Grasp the air filter between your fingers and lift it out of the filter cover.

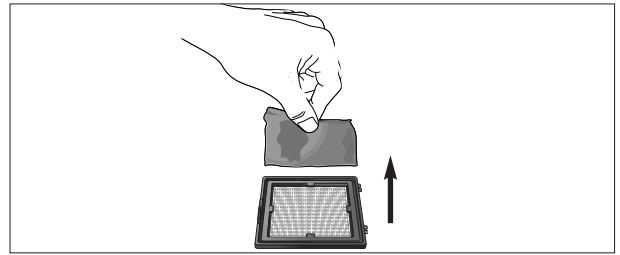

4. Clean the air filter. Clean the dust off the air filter and cover with a vacuum cleaner extension hose.

5. Replace the air filter. Place the air filter underneath the tabs on the filter frame.

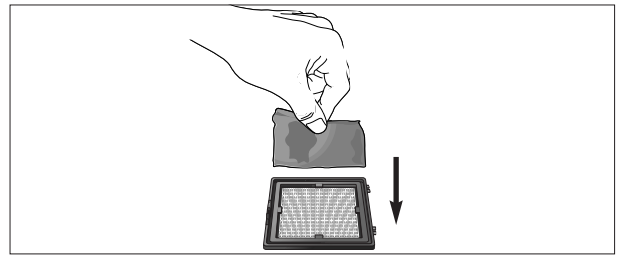

6. Replace the filter cover. Insert the tab on the end of the filter cover into the filter cover opening and press the filter cover into position.

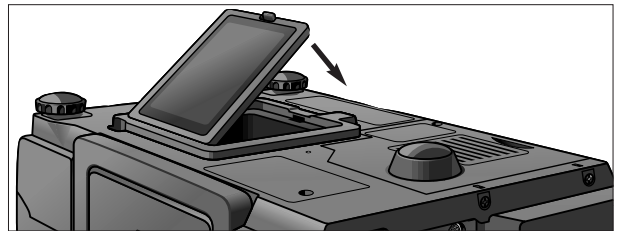

Note:

Be sure the filter cover is securely installed. The power will not turn on unless it is correctly installed.

Cleaning the side air filter (not removable)

If dust or dirt has collected inside the air filter, clean the filter with a vacuum cleaner extension hose.

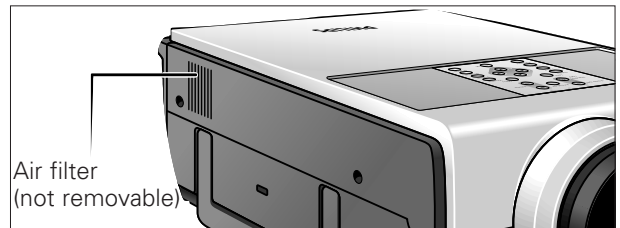

Note:

The side air filter cannot be removed.

LAMP MAINTENANCE

Lamp/Maintenance Indicators

- The warning lights on the projector indicate problems inside the projector.
- There are two warning lights: a temperature warning indicator (Temp.) which warns that the projector is too hot, and a Lamp indicator (Lamp) which lets you know when to change the lamp.
- If a problem occurs, either the Temperature warning indicator or the Lamp indicator will light up red. After turning off the power, follow the procedures given in the next table.

Maintenance Indicator	Condition	Problem	Possible Solution
TEMP. WARNING indicator (Temp)	The internal temperature is abnormally high.	• Blocked air intake.	• Relocate the projector to an area with proper ventilation.
		• Clogged air filter.	• Clean the filter. (see page 25.)
		• Cooling fan breakdown. • Internal circuit failure.	• Take the projector to your nearest Authorized Philips Industrial LCD Products Dealer or Service Center for repair.
LAMP indicator (Lamp)	The lamp does not light up	• Burnt-out lamp. • Lamp circuit failure.	• Carefully replace the lamp. (See page 26.) • Take the projector to your nearest Authorized Philips Industrial LCD Products Dealer or Service Center for repair.
POWER INDICATOR ⓪ / ⓪	The POWER indicator flashes in red when the projector is on.	• The bottom filter cover is open.	• Securely install the bottom filter cover.

Notes:

- If the Temperature warning indicator lights up, follow the above possible solutions and then wait until the projector has cooled down completely before turning the power back on. (At least 5 minutes.)
- If the power is turned off and then turned on again, as during a brief rest, the Lamp indicator may be triggered, preventing the power from going on. Should this occur, take the power cord out of the wall outlet and put it back in again.

Lamp (LCA 3110; 8670 931 10009)

The lamp in this projector operates for approximately 2000 cumulative hours, depending on the usage environment. It is recommended that the lamp be replaced after 1900 cumulative hours of use or when you notice a significant deterioration of the picture and colour quality. The lamp usage time can be checked with the On-screen Display (see page 23).

CAUTION!

- Intense light hazard. Do not attempt to look into the aperture and lens while the projector is operating.
- As the usage environment can vary significantly, the projector lamp may not operate for 2000 hours.

Replacing the lamp

1. Unplug the power cord.
 - Press Power OFF. Wait until the cooling fan stops.
2. Disconnect the powercord
 - Disconnect the mains lead and all the other cables.
3. Slide the lamp cage cover out.
 - Turn over the projector and unfasten the user service screw that secures the lamp cage cover. Then slide the cover in the direction of the arrow.

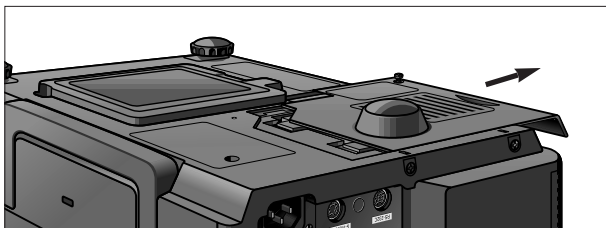

4. Remove the lamp cage.

- Remove the securing screws from the lamp cage. Hold the lamp cage by the handle and pull it towards you.

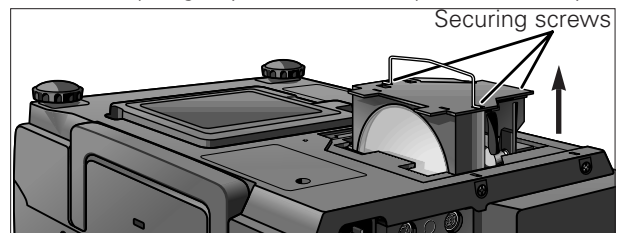

5. Replace the lamp cage (after changing the lamp).

- Press the lamp cage firmly into the lamp cage compartment. Fasten the securing screws.

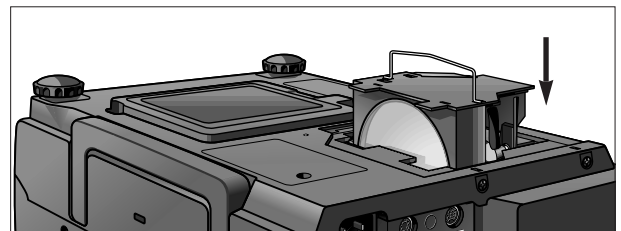

6. Slide the lamp cage cover in.

- Slide the lamp cage cover in the direction of the arrow. Then fasten the user service screw.

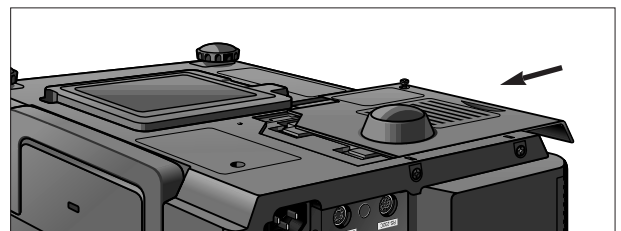

CAUTION!

- Do not remove the lamp cage directly after operation of the projector. The lamp may be extremely hot. Wait at least one hour after the power cord is disconnected to allow the surface of the lamp cage to fully cool before removing the lamp cage.
- Be sure to remove the lamp cage by the handle. Be sure not to touch the glass surface of the lamp cage or the inside of the projector.

CAUTION!

- To avoid injury to yourself and damage to the lamp, be sure to carefully follow the steps below.
- Before or after replacing the lamp, be sure to clean the air filters. See page 25 for cleaning the air filters.

Resetting the lamp timer

1. Connect the power cord.
 - Plug the power cord into the AC socket of the projector.
2. While pressing ∇ , \triangleright and OK on the projector, press Power ON on the projector.
 - 'Lamp 0000H' is displayed, indicating that the lamp timer is reset.



KENSINGTON LOCK

This projector has a Kensington Security Standard slot for use with a Kensington Micro Saver Security System. Refer to the information that came with the system for instructions on how to use it to secure the projector.

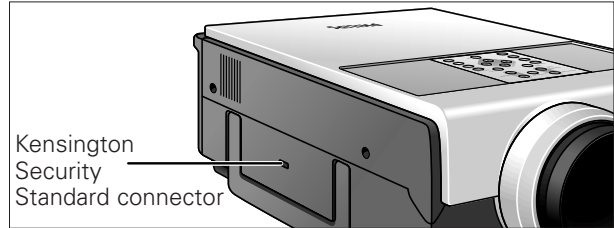

10. TROUBLESHOOTING

If a fault occurs, first check the points listed below before taking the projector for repair. If you are unable to remedy a problem by following these hints, consult your dealer or service organisation.

WARNING

Under no circumstances should you try to repair the projector yourself as this could invalidate the warranty.

PROBLEM

- CHECK

NO PICTURE AND NO SOUND.

- Projector power cord is not plugged into the wall outlet.
- The bottom filter cover is not securely installed.
- Selected input is wrong. (See pages 14)
- Cables improperly connected to rear panel of the projector. (See pages 11-13)
- Remote control batteries have run down. (See page 9)

SOUND IS HEARD BUT NO PICTURE APPEARS

- Cables improperly connected to rear panel of the projector. (See pages 11-13)
- "Contrast" and "Bright" adjustments are set to minimum position. (See page 18)
- On-screen Display ("AV-MUTE") is turned off and AV-Mute function is turned on, creating a black image. (See page 22)

PICTURE APPEARS BUT NO SOUND IS HEARD

- Cables improperly connected to rear panel of the projector. (See pages 11-13)
- Volume is set to minimum. (See page 14)

COLOUR IS FADED OR POOR

- "Color" and "Tint" adjustments are not correct. (See page 18)

COLOUR IS DISTORTED (EXCEPT FOR VIDEO MODE)

- Change the input signal type. (See page 14)

PICTURE IS BLURRED

- Adjust the focus. (See page 9)
- Projection distance is too long or too short to allow for proper focus. (See page 8)

PICTURE NOISE APPEARS

- Adjust the phase setting. (See page 17)
- Noise may appear when used with certain computers.

480P IMAGES DO NOT APPEAR

- Set the resolution mode to 480P. (See page 16)

AN UNUSUAL SOUND IS OCCASIONALLY HEARD FROM THE CABINET

- If the picture is normal, the sound is due to cabinet shrinkage caused by temperature changes. This will not affect operation or performance.

MAINTENANCE INDICATOR LIGHTS UP

- Refer to "Lamp/Maintenance Indicators" on page 25.

LENS COMES OFF

- Align the mark on the lens with the corresponding mark on the projector, push the lens firmly in place, and rotate to the right.