

## Operating Instructions Functional Manual

DLP™ Projector Commercial Use

---

Model No. **PT-DW640U**  
**PT-DW640UL**  
**PT-DX610U**  
**PT-DX610UL**

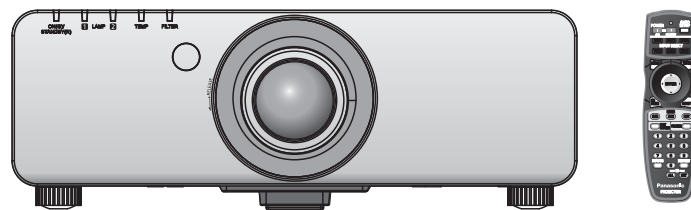

Thank you for purchasing this Panasonic product.

- This manual is common to all the models regardless of suffixes of the Model No.
  - S: Silver model, the standard zoom lens supplied    LS: Silver model, the lens sold separately
  - K: Black model, the standard zoom lens supplied    LK: Black model, the lens sold separately
- Before operating this product, please read the instructions carefully and save this manual for future use.
- Before using your projector, be sure to read “Read this first!” (➔ pages 2 to 8).

## Read this first!

**WARNING:** TO REDUCE THE RISK OF FIRE OR ELECTRIC SHOCK, DONOT EXPOSE THIS PRODUCT TO RAIN OR MOISTURE.



**WARNING**  
RISK OF ELECTRIC  
SHOCK.DO NOT OPEN



AVERTISSEMENT : RISQUE DE CHOC ÉLECTRIQUE.  
NE PAS OUVRIR.  
WARNUNG: ZUR VERMEIDUNG EINES ELEKTRISCHEN  
SCHLAGES GERÄT NICHT ÖFFNEN.

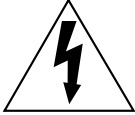

The lightning flash with arrowhead symbol, within an equilateral triangle, is intended to alert the user to the presence of uninsulated “dangerous voltage” within the product’s enclosure that may be of sufficient magnitude to constitute a risk of electric shock to persons.



The exclamation point within an equilateral triangle is intended to alert the user to the presence of important operating and maintenance (servicing) instructions in the literature accompanying the product.

**CAUTION:** This equipment is equipped with a three-pin grounding-type power plug. Do not remove the grounding pin on the power plug. This plug will only fit a grounding-type power outlet. This is a safety feature. If you are unable to insert the plug into the outlet, contact an electrician. Do not defeat the purpose of the grounding plug.

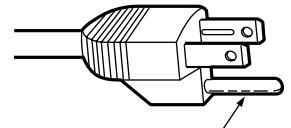

Do not remove

**CAUTION:** To assure continued compliance, follow the attached installation instructions, which include using the provided power cord and shielded interface cables when connecting to computer or peripheral device. If you use serial port to connect PC for external control of projector, you must use a commercial RS-232C serial interface cable with ferrite core. Any unauthorized changes or modifications to this equipment will void the user’s authority to operate.

## FCC NOTICE (USA)

### Verification

Model Number: PT-DW640US / PT-DW640UK / PT-DW640ULS / PT-DW640ULK /  
PT-DX610US / PT-DX610UK / PT-DX610ULS / PT-DX610ULK

Trade Name: Panasonic

Responsible Party: Panasonic Corporation of North America

Address: One Panasonic Way, Secaucus, NJ 07094

Telephone number: (877)803-8492

E-mail: [projectorsupport@us.panasonic.com](mailto:projectorsupport@us.panasonic.com)

This device complies with Part 15 of the FCC Rules.

Operation is subject to the following two conditions:

(1) This device may not cause harmful interference, and (2) this device must accept any interference received, including interference that may cause undesired operation.

To assure continued compliance, follow the attached installation instructions and do not make any unauthorized modifications.

### CAUTION:

This equipment has been tested and found to comply with the limits for a Class A digital device, pursuant to part 15 of the FCC Rules. These limits are designed to provide reasonable protection against harmful interference when the equipment is operated in a commercial environment. This equipment generates, uses, and can radiate radio frequency energy and, if not installed and used in accordance with the instruction manual, may cause harmful interference to radio communications. Operation of this equipment in a residential area is likely to cause harmful interference in which case the user will be required to correct the interference at his own expense.

## NOTIFICATION (Canada)

This class A digital apparatus complies with Canadian ICES-003.

### WARNING:

- Not for use in a computer room as defined in the Standard for the Protection of Electronic Computer/Data Processing Equipment, ANSI/NFPA 75.
- For permanently connected equipment, a readily accessible disconnect device shall be incorporated in the building installation wiring.
- For pluggable equipment, the socket-outlet shall be installed near the equipment and shall be easily accessible.

### NOTICE (USA only):

- This product has a High Intensity Discharge (HID) lamp that contains mercury. Disposal may be regulated in your community due to environmental considerations. For disposal or recycling information, please visit Panasonic website: <http://www.panasonic.com/environmental> or call 1-888-769-0149.

## For USA-California Only

This product contains a CR Coin Cell Lithium Battery which contains Perchlorate Material – special handling may apply.

See [www.dtsc.ca.gov/hazardouswaste/perchlorate](http://www.dtsc.ca.gov/hazardouswaste/perchlorate)

## **WARNING:**

### **■ POWER**

**The wall outlet or the circuit breaker shall be installed near the equipment and shall be easily accessible when problems occur. If the following problems occur, cut off the power supply immediately.**

Continued use of the projector in these conditions will result in fire or electric shock.

- If foreign objects or water get inside the projector, cut off the power supply.
- If the projector is dropped or the cabinet is broken, cut off the power supply.
- If you notice smoke, strange smells or noise coming from the projector, cut off the power supply.

Please contact an Authorized Service Center for repairs, and do not attempt to repair the projector yourself.

**During a thunderstorm, do not touch the projector or the cable.**

Electric shocks can result.

**Do not do anything that might damage the power cord or the power plug.**

If the power cord is used while damaged, electric shocks, short-circuits or fire will result.

- Do not damage the power cord, make any modifications to it, place it near any hot objects, bend it excessively, twist it, pull it, place heavy objects on top of it or wrap it into a bundle.

Ask an Authorized Service Center to carry out any repairs to the power cord that might be necessary.

**Completely insert the power plug into the wall outlet and the power connector into the projector terminal.**

If the plug is not inserted correctly, electric shocks or overheating will result.

- Do not use plugs which are damaged or wall outlets which are coming loose from the wall.

**Do not use anything other than the provided power cord.**

Failure to observe this will result in fire or electric shocks. Please note that if you do not use the provided power cord to ground the device on the side of the outlet, this may result in electric shocks.

**Clean the power plug regularly to prevent it from becoming covered in dust.**

Failure to observe this will cause a fire.

- If dust builds up on the power plug, the resulting humidity can damage the insulation.

Pull the power plug out from the wall outlet and wipe it with a dry cloth regularly.

**Do not handle the power plug and power connector with wet hands.**

Failure to observe this will result in electric shocks.

**Do not overload the wall outlet.**

If the power supply is overloaded (ex., by using too many adapters), overheating may occur and fire will result.

### **■ ON USE/INSTALLATION**

**Do not place the projector on soft materials such as carpets or sponge mats.**

Doing so will cause the projector to overheat, which can cause burns, fire or damage to the projector.

**Do not set up the projector in humid or dusty places or in places where the projector may come into contact with oily smoke or steam, ex. a bathroom.**

Using the projector under such conditions will result in fire, electric shocks or deterioration of components.

Deterioration of components (such as ceiling mount brackets) may cause the projector which is mounted on the ceiling to fall down.

**Do not install this projector in a place which is not strong enough to take the full weight of the projector or on top of a surface which is sloped or unstable.**

Failure to observe this will cause projector to fall down or tip over the projector, and severe injury or damage could result.

**WARNING:**

**Do not cover the air intake/exhaust ports or place anything within 500 mm (20") of them.**

Doing so will cause the projector to overheat, which can cause fire or damage to the projector.

- Do not place the projector in narrow, badly ventilated places.
- Do not place the projector on cloth or papers, as these materials could be drawn into the air inlet port.

**Do not place your hands or other objects close to the air exhaust port.**

Doing so will cause burns or damage your hands or other objects.

- Heated air comes out of the air exhaust port. Do not place your hands or face, or objects which cannot withstand heat close to this port.

**Do not look at or place your skin into the light emitted from the lens while the projector is being used.**

Doing so can cause burns or loss of sight.

- Strong light is emitted from the projector's lens. Do not look at or place your hands directly into this light.
- Be especially careful not to let young children look into the lens. In addition, turn off the power and disconnect the power plug when you are away from the projector.

**Never attempt to remodel or disassemble the projector.**

High voltages can cause fire or electric shocks.

- For any inspection, adjustment and repair work, please contact an Authorized Service Center.

**Do not project an image with the lens cover attached.**

Doing so can cause fire.

**Do not allow metal objects, flammable objects, or liquids to enter inside of the projector. Do not allow the projector to get wet.**

Doing so may cause short circuits or overheating, and result in fire, electric shock, or malfunction of the projector.

- Do not place containers of liquid or metal objects near the projector.
- If liquid enters inside of the projector, consult your dealer.
- Particular attention must be paid to children.

**Use the ceiling mount bracket specified by Panasonic.**

Using the ceiling mount bracket other than the specified one will result in falling accidents.

- Attach the supplied safety cable to the ceiling mount bracket to prevent the projector from falling down.

**Installation work (such as ceiling mount bracket) should only be carried out by a qualified technician.**

If installation is not carried out and secured correctly it can cause injury or accidents, such as electric shocks.

- Do not use anything other than an authorized ceiling mount bracket.
- Be sure to use the provided accessory wire with an eye bolt as an extra safety measure to prevent the projector from falling down. (Install in a different location to the ceiling mount bracket.)

## **WARNING:**

### **■ ACCESSORIES**

#### **Do not use or handle the batteries improperly, and refer to the following.**

Failure to observe this will cause burns, batteries to leak, overheat, explode or catch fire.

- Use AA/R6 batteries.
- Do not use unspecified batteries.
- Do not use chargeable batteries.
- Do not disassemble dry cell batteries.
- Do not heat the batteries or place them into water or fire.
- Do not allow the + and – terminals of the batteries to come into contact with metallic objects such as necklaces or hairpins.
- Do not store or carry batteries together with metallic objects.
- Store the batteries in a plastic bag and keep them away from metallic objects.
- Make sure the polarities (+ and –) are correct when inserting the batteries.
- Do not use a new battery together with an old battery or mix different types of batteries.
- Do not use batteries with the outer cover peeling away or removed.

#### **If the battery fluid leaks, do not touch it with bare hands, and take the following measures if necessary.**

- Battery fluid on your skin or clothing could result in skin inflammation or injury.  
Rinse with clean water and seek medical advice immediately.
- Battery fluid coming in contact with your eyes could result in loss of sight.  
In this case, do not rub your eyes. Rinse with clean water and seek medical advice immediately.

#### **Do not disassemble the lamp unit.**

Doing so can cause electric shocks, burns, or injury.

#### **Lamp replacement**

The lamp has high internal pressure. If improperly handled, an explosion and severe injury or accidents will result.

- The lamp can easily explode if struck against hard objects or dropped.
- Before replacing the lamp, be sure to turn the power off and to disconnect the power plug from the wall outlet.  
Electric shocks or explosions can result if this is not done.
- When replacing the lamp, turn the power off and allow it to cool for at least one hour before handling it otherwise it can cause burns.

#### **Do not use the supplied power cord with devices other than this projector.**

- Using the supplied power cord with devices other than this projector may cause short circuits or overheating, and result in electric shock or fire.

#### **Remove the depleted batteries from the remote control promptly.**

- Leaving them in the unit may result in fluid leakage, overheating, or explosion of the batteries.

## **CAUTION:**

### **■ POWER**

#### **When disconnecting the power cord, be sure to hold the power plug and power connector.**

If the power cord itself is pulled, the lead will become damaged, and fire, short-circuits or serious electric shocks will result.

#### **When not using the projector for an extended period of time, disconnect the power plug from the wall outlet.**

Failure to do so may result in fire or electric shock.

#### **Disconnect the power plug from the wall outlet before carrying out any cleaning and replacing the unit.**

Failure to do so may result in electric shock.

## **CAUTION:**

### **■ ON USE/INSTALLATION**

#### **Do not place heavy objects on top of the projector.**

Failure to observe this will cause the projector to become unbalanced and fall, which could result in damage or injury. The projector will be damaged or deformed.

#### **Do not put your weight on this projector.**

You could fall or the projector could break, and injury will result.

- Be especially careful not to let young children stand or sit on the projector.

#### **Do not place the projector in extremely hot locations.**

Doing so will cause the outer casing or internal components to deteriorate, or result in fire.

- Take particular care in locations exposed to direct sunlight or near stoves.

#### **Do not place your hands in the openings beside the optical lens, while shifting the lens.**

Failure to observe this could cause injury.

#### **Do not stand in front of the lens while the projector is being used.**

Doing so can cause damage and burns to clothing.

- Strong light is emitted from the projector's lens.

#### **Do not place objects in front of the lens while the projector is being used.**

Doing so can cause damage to the object and can cause the set to malfunction.

- Strong light is emitted from the projector's lens.

#### **Always disconnect all cables before moving the projector.**

Moving the projector with cables still attached can damage the cables, which will cause fire or electric shocks to occur.

### **■ ACCESSORIES**

#### **Do not use the old lamp unit.**

If used it could cause lamp explosion.

#### **If the lamp has broken, ventilate the room immediately. Do not touch or bring your face close to the broken pieces.**

Failure to observe this will cause the user to absorb the gas which was released when the lamp broke and which contains nearly the same amount of mercury as fluorescent lamps, and the broken pieces will cause injury.

- If you believe that you have absorbed the gas or that the gas has got into your eyes or mouth, seek medical advice immediately.
- Ask your dealer about replacing the lamp unit and check the inside of the projector.

#### **Do not attach the air filter unit while it is wet.**

Doing so may result in electric shock or malfunctions.

- After you clean the air filter units, dry them thoroughly before reattaching them.

#### **Do not touch the fan with your fingers or any other parts of your body when changing the lamp unit.**

Doing so can cause injury.

#### **Ask your dealer about cleaning inside the projector once a year.**

Continuous use while dust is accumulated inside the projector may result in fire.

- For cleaning fee, ask your dealer.

#### **When not using the projector for an extended period of time, remove the batteries from the remote control.**

Failure to observe this will cause the batteries to leak, overheat, catch fire or explode, which may result in fire or contamination of surrounding area.

## Brazil Only Brasil Apenas

### ■ Manuseio de baterias usadas



#### BRASIL

Após o uso, as pilhas e /ou baterias poderão ser entregues ao estabelecimento comercial ou rede de assistência técnica autorizada.

Cobrir os terminais positivo (+) e negativo (-) com uma fita isolante adesiva, antes de depositar numa caixa destinada para o recolhimento. O contato entre partes metálicas pode causar vazamentos, gerar calor, romper a blindagem e produzir fogo.

Não desmonte, não remova o invólucro, nem amasse a bateria. O gás liberado pela bateria pode irritar a garganta, danificar o lacre do invólucro ou o vazamento provocar calor, ruptura da blindagem e produzir fogo devido ao curto circuito dos terminais.

Não incinere nem aqueça as baterias, elas não podem ficar expostas a temperaturas superiores a 100 °C (212 °F). O gás liberado pela bateria pode irritar a garganta, danificar o lacre do invólucro ou o vazamento provocar calor, ruptura da blindagem e produzir fogo devido ao curto circuito dos terminais provocado internamente.

Evite o contato com o líquido que vazar das baterias. Caso isto ocorra, lave bem a parte afetada com bastante água. Caso haja irritação, consulte um médico.

### ■ Remoção das baterias

1. Pressione a guia e levante a tampa.

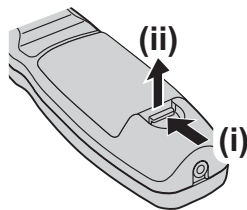

2. Remova as baterias.

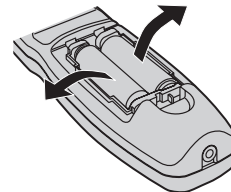



---

## ■ Trademarks

- Microsoft®, Windows®, Windows Vista®, and Internet Explorer® are the registered trademarks or trademarks of Microsoft Corporation in the United States and/or other countries.
- Mac, Mac OS, Mac OSX, and Safari are the trademarks of Apple Inc. registered in the United States and other countries.
- PJLink™ is a trademark or pending trademark in Japan, the United States, and other countries and regions.
- HDMI, the HDMI logo and High-Definition Multimedia Interface are trademarks or registered trademarks of HDMI Licensing LLC.
- VGA and XGA are trademarks of International Business Machines Corporation.
- SVGA is a registered trademark of the Video Electronics Standards Association.
- RoomView, Crestron RoomView, Crestron Connected, and Fusion RV are trademarks of Crestron Electronics, Inc.
- The font used in the on-screen displays is a Ricoh bitmap font, which is manufactured and sold by Ricoh Company, Ltd.
- Adobe Flash Player is either a trademark or registered trademark of Adobe Systems Incorporated in the United States and/or other countries.
- Other names, company names or product names used in these operating instructions are the trademarks or registered trademarks of their respective holders.  
Please note that the operating instructions do not include the ® and TM symbols.

## ■ Illustrations in these operating instructions

- Note that illustrations of the projector and screens may differ from the ones you actually see.

## ■ Page references

- In these instructions, references to pages are indicated as: (➡ page 00).

## ■ Term

- In these instructions, the “Wireless/wired remote control unit” accessories are referred to as the “Remote control”.

---

## Features of the Projector

---

### High luminance & High color reproducibility

---

- ▶ The unique optical and lamp drive systems achieve a high luminance and high color reproducibility while saving power.

---

### Easy setup and improved serviceability

---

- ▶ Extensive lineup of optional lenses allow more flexible setup of the projector.

---

### Improved cost performance in maintenance fee

---

- ▶ The long life filter reduces maintenance costs.

---

## Quick Steps

For details, see the corresponding pages.

1. **Set up the projector.**  
(⇒ page 26)



2. **Attach the projection lens.**  
(⇒ page 35)



3. **Connect with other devices.**  
(⇒ page 37)



4. **Connect the power cord.**  
(⇒ page 41)



5. **Switch on the projector.**  
(⇒ page 42)



6. **Make initial settings.\***  
(⇒ page 19)



7. **Select the input signal.**  
(⇒ page 45)



8. **Adjust the image.**  
(⇒ page 45)

\* These are the steps to be taken when you switch on the power for the first time after purchasing the projector.

# Contents

Be sure to read “Read this first!”. (➔ pages 2 to 8)

## Read this first! ..... 2

### Chapter 1 Preparation

<b>Precautions for use</b> .....	<b>14</b>
Cautions when transporting.....	14
Cautions when installing.....	14
Security .....	15
Disposal.....	16
Cautions on use .....	16
Software information regarding this product.....	16
Accessories .....	17
Optional accessories .....	18
<b>Start-up display</b> .....	<b>19</b>
Initial setting (display language) .....	19
Initial setting (projector setup) .....	19
<b>About your projector</b> .....	<b>20</b>
Remote control .....	20
Projector body .....	21
<b>Using the remote control</b> .....	<b>23</b>
Inserting and removing the batteries .....	23
Setting Remote control ID numbers .....	23
Connecting to the projector with a cable .....	24

### Chapter 2 Getting Started

<b>Setting up</b> .....	<b>26</b>
Projection method .....	26
Parts for ceiling mount (optional).....	26
Screen size and throw distance .....	27
Adjusting adjustable feet .....	34
<b>Removing/attaching the projection lens</b> .....	<b>35</b>
Removing the projection lens .....	35
Attaching the projection lens .....	35
<b>Connections</b> .....	<b>37</b>
Before connecting to the projector .....	37
Connecting example: AV equipment .....	38
Connecting example: Computers .....	38

### Chapter 3 Basic Operation

<b>Switching on/off the projector</b> .....	<b>41</b>
Connecting the power cord .....	41
Power indicator.....	42
Switching on the projector .....	42
Making adjustments and selections .....	43
Switching off the projector .....	43
Direct power off function.....	44

<b>Projecting</b> .....	<b>45</b>
Selecting the input signal .....	45
Adjusting the focus, zoom, and shift.....	45
Moving the lens to the home position .....	46
Adjustment range by the lens position shift (optical shift).....	46
<b>Remote control operation</b> .....	<b>47</b>
Using the shutter function.....	47
Using the on-screen display function .....	47
Switching the input .....	48
Using the status function .....	48
Using the automatic setup function .....	48
Using the function button.....	49
Displaying the internal test pattern .....	49
Changing the picture aspect ratio.....	49

### Chapter 4 Settings

<b>Menu navigation</b> .....	<b>51</b>
Navigating through the menu .....	51
Main menu.....	52
Sub-menu.....	52
<b>[PICTURE] menu</b> .....	<b>55</b>
[PICTURE MODE].....	55
[CONTRAST].....	55
[BRIGHTNESS].....	55
[COLOR].....	56
[TINT] .....	56
[COLOR TEMPERATURE].....	56
[WHITE GAIN] .....	57
[SYSTEM DAYLIGHT VIEW].....	57
[SHARPNESS] .....	58
[NOISE REDUCTION].....	58
[AI].....	58
[SYSTEM SELECTOR] .....	59
<b>[POSITION] menu</b> .....	<b>60</b>
[SHIFT] .....	60
[ASPECT] .....	60
[ZOOM].....	61
[CLOCK PHASE].....	62
[KEystone].....	63
<b>[ADVANCED MENU] menu</b> .....	<b>64</b>
[DIGITAL CINEMA REALITY] .....	64
[BLANKING] .....	64
[INPUT RESOLUTION] .....	65
[CLAMP POSITION].....	65
[EDGE BLENDING].....	65
[RASTER POSITION].....	66

## Contents

<b>[DISPLAY LANGUAGE] menu</b> .....	<b>67</b>	<b>[SECURITY] menu</b> .....	<b>89</b>
Changing the display language .....	67	[SECURITY PASSWORD].....	89
<b>[DISPLAY OPTION] menu</b> .....	<b>68</b>	[SECURITY PASSWORD CHANGE] .....	89
[COLOR MATCHING].....	68	[DISPLAY SETTING].....	89
[COLOR CORRECTION] .....	69	[TEXT CHANGE] .....	90
[CONTRAST MODE].....	69	[MENU LOCK].....	90
[SCREEN SETTING].....	69	[MENU LOCK PASSWORD] .....	90
[AUTO SIGNAL] .....	70	[CONTROL DEVICE SETUP].....	90
[AUTO SETUP].....	70	<b>[NETWORK] menu</b> .....	<b>92</b>
[RGB IN].....	70	[NETWORK SETUP] .....	92
[DVI-D IN].....	70	[NETWORK CONTROL] .....	92
[HDMI IN].....	71	[NETWORK STATUS] .....	93
[ON-SCREEN DISPLAY].....	71	Network connections .....	93
[BACK COLOR].....	72	Accessing from the Web browser.....	94
[STARTUP LOGO].....	72		
[SHUTTER SETTING].....	73	<b>Chapter 5 Maintenance</b>	
[FREEZE] .....	73	<b>Lamp/Temperature/Filter indicators</b> .....	<b>110</b>
[SIDE BY SIDE] (PT-DW640U only).....	73	Managing the indicated problems .....	110
[CUT OFF].....	74	<b>Maintenance/replacement</b> .....	<b>112</b>
<b>[PROJECTOR SETUP] menu</b> .....	<b>75</b>	Before maintaining/replacing the unit.....	112
[PROJECTOR ID].....	75	Maintenance.....	112
[PROJECTION METHOD].....	75	Replacing the unit.....	113
[COOLING CONDITION].....	76	<b>Troubleshooting</b> .....	<b>116</b>
[HIGH ALTITUDE MODE].....	76		
[LAMP SELECT].....	76	<b>Chapter 6 Appendix</b>	
[LAMP RELAY] .....	77	<b>Technical information</b> .....	<b>118</b>
[LAMP POWER] .....	77	PJLink protocol.....	118
[STANDBY MODE].....	78	Control commands via LAN.....	119
[SCHEDULE].....	78	<SERIAL IN>/<SERIAL OUT> terminal.....	121
[STARTUP INPUT SELECT] .....	79	<REMOTE 2 IN> terminal .....	124
[RS-232C].....	80	Two window display combination list (PT- DW640U only).....	125
[REMOTE2 MODE] .....	81	Menu lock password.....	125
[STATUS].....	81	List of compatible signals .....	125
[NO SIGNAL SHUT-OFF].....	82	<b>Specifications</b> .....	<b>127</b>
[FUNCTION BUTTON] .....	82	<b>Dimensions</b> .....	<b>129</b>
[DATE AND TIME] .....	83	<b>Ceiling mount bracket safeguards</b> .....	<b>130</b>
[SAVE ALL USER DATA].....	83	<b>Index</b> .....	<b>131</b>
[LOAD ALL USER DATA] .....	84		
[INITIALIZE].....	84		
[SERVICE PASSWORD].....	84		
<b>[TEST PATTERN] menu</b> .....	<b>85</b>		
[TEST PATTERN].....	85		
<b>[SIGNAL LIST] menu</b> .....	<b>86</b>		
Registering a signal to the list .....	86		
Renaming the registered data .....	86		
Deleting the registered data .....	86		
Protecting the registered data .....	87		
Expanding signal lock-in range .....	87		
Managing the sub memory list .....	87		

# Chapter 1 Preparation

---

This chapter describes things you need to know or check before using the projector.

# Precautions for use

## Cautions when transporting

- The projection lens is susceptible to effects from vibration or impact. Make sure to remove the projection lens when transporting. Also, use a protection cover or the like to prevent dust from affecting the projection lens or the set.
- When transporting the projector, hold it securely by its bottom and avoid excessive vibration and impacts. They may damage the internal parts and result in malfunctions.
- Do not transport the projector with the adjustable feet extended. Doing so may damage the adjustable feet.

## Cautions when installing

### ■ Always attach the projection lens cover after attaching the projection lens.

If the cover is not attached, dust will accumulate inside and may cause malfunctions.

### ■ Do not set up the projector outdoors.

The projector is designed for indoor use only.

### ■ Do not set up the projector in the following locations.

- Places where vibration and impacts occur such as in a car or vehicle: Doing so may cause damage to internal parts or malfunction.
- Near the exhaust of an air conditioner: Depending on the conditions of use, the screen may fluctuate in rare cases due to the hot air from the air exhaust port or the heated or cooled air. Make sure that the exhaust from the projector or other equipment, or the air from the air conditioner does not blow toward the front of the projector.
- Near lights (studio lamps, etc.) and other locations of great temperature fluctuation ("Operating environment" (➔ page 128)): Doing so may shorten the life of the lamp or result in deformation of the outer case and malfunctions.
- Near high-voltage power lines or near motors: Doing so may interfere with the operation of the projector.
- Place where there is high-power laser equipment: Directing a laser beam onto the lens surface causes damage to the DLP chips.

### ■ Be sure to ask a specialized technician or your dealer when installing the product to a ceiling.

If the product is to be installed hanging from the ceiling, purchase an optional Ceiling Mount Attachment.

Model No.: ET-PKD56H (for high ceilings), ET-PKD55S (for low ceilings)

### ■ Lens focus

The high clarity projection lens is thermally affected by the light from the light source, making the focus unstable in the period just after switching on the power. Wait at least 30 minutes with the image projected before adjusting the lens focus.

### ■ Make sure to set [HIGH ALTITUDE MODE] to [ON] when using the projector at elevations of 1 400 m (4 593 ft) or higher and lower than 2 700 m (8 858 ft) above sea level.

Doing so may shorten the life of the internal parts and result in malfunctions.

### ■ Make sure to set [HIGH ALTITUDE MODE] to [OFF] when using the projector at elevations lower than 1 400 m (4 593 ft) above sea level.

Doing so may shorten the life of the internal parts and result in malfunctions.

### ■ Do not install the projector at elevations of 2 700 m (8 858 ft) or higher above sea level.

Doing so may shorten the life of the internal parts and result in malfunctions.

### ■ Do not use the projector tilted to the right or left

Using the projector at a vertical angle that exceeds 15° may reduce product life or result in malfunction.

### ■ When installing and using the projector at an angle that exceeds 30° vertically, set [COOLING CONDITION] (➔ page 76).

Failure to observe this will result in malfunctions or shorten the life of the lamp or other components.

### ■ Cautions when setting up the projector

- To install and use the projector via a method that does not use the adjustable feet in a floor standing installation, fix the projector using the five screw holes for ceiling mounting (Fig. 1).  
(Screw diameter: M6, tapping depth inside the set: 12 mm (15/32"), torque: 4 ± 0.5 N·m)

- Use the adjustable feet only for the floor standing installation and for adjusting the angle. Using it for other purposes may damage the set.

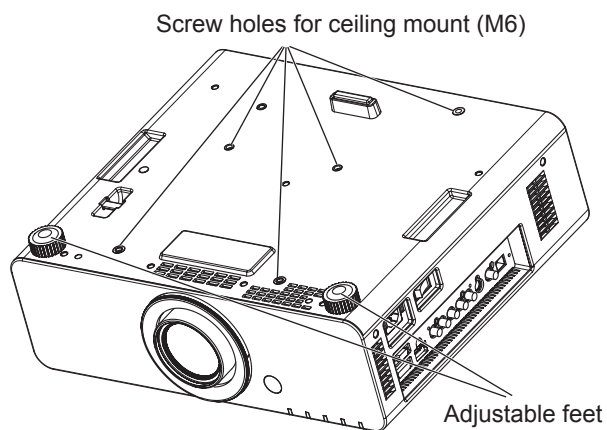
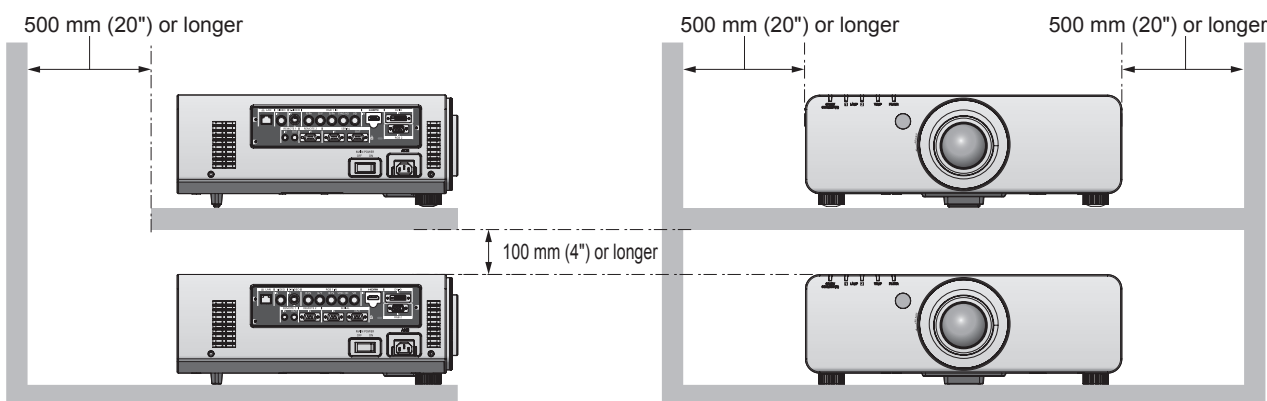
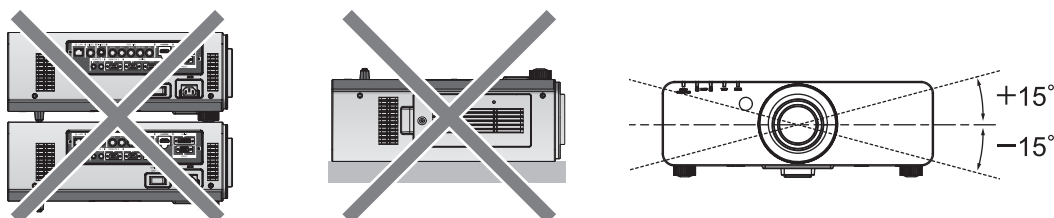

Fig. 1 The positions of screw holes for ceiling mount and adjustable feet

- Do not stack projectors on top of each other.
- Do not hold the projector by the top surface.
- Do not use the projector tilted at an angle that exceeds  $\pm 15^\circ$  from the horizontal plane.
- Do not block the ventilation ports (intake and exhaust) of the projector.
- Prevent hot and cool air from the air conditioning system from blowing directly to the ventilation ports (intake and exhaust) of the projector.



- Do not install the projector in a confined space.  
When it is necessary to install the projector in a confined space, install the air conditioning or ventilation separately. Exhaust heat may accumulate when the ventilation is not enough, triggering the protection circuit of the projector.
- Make a clearance of at least 20 mm (0.8") between the projector bottom and setting surface by inserting spacers (metallic) etc. between them.

## Security

When using this product, take safety measures against the following incidents.

- Personal information being leaked via this product
  - Unauthorized operation of this product by a malicious third party
  - Interfering or stopping of this product by a malicious third party
- Take sufficient security measures. (➡ pages 89, 104)
- Make your password difficult to guess as much as possible.
  - Change your password periodically.
  - Panasonic Corporation or its affiliate companies will never ask for your password directly. Do not divulge your password in case you receive such inquiries.
  - The connecting network must be secured by a firewall, etc.
  - Set a password for the web control and restrict the users who can log in.

## Disposal

To dispose of the product, ask your local authorities or dealer for correct methods of disposal.

The lamp contains mercury. When disposing of used lamp units, contact your local authorities or dealer for correct methods of disposal.

## Cautions on use

### ■ To get a good picture quality

In order to view a beautiful image in higher contrast, prepare an appropriate environment. Draw curtains or blinds over windows and turn off any lights near the screen to prevent outside light or light from indoor lamps from shining onto the screen.

### ■ Do not touch the surface of the projection lens with your bare hands.

If the surface of the projection lens becomes dirty from fingerprints or anything else, this will be magnified and projected onto the screen. Please put the lens cover (accessory) on the projector when you do not use it.

### ■ DLP chips

- The DLP chips are precision-made. Note that in rare cases, pixels of high precision could be missing or always lit. Note that such phenomena does not indicate malfunction. This is not a malfunction.
- Directing a high-power laser beam onto the lens surface can damage the DLP chips.

### ■ Do not move the projector while it is operating or subject it to vibration or impact.

Doing so may shorten the service life of its internal components.

### ■ Lamp

The luminous source of the projector is a high-pressure mercury lamp.

A high-pressure mercury lamp has the following characteristics.

- The luminance of the lamp will decrease by duration of usage.
- The lamp may burst with a loud sound or have its service life shortened because of shock, chipping, or degradation due to cumulative operating time.
- The lamp life varies greatly depending on individual differences and usage conditions. In particular, frequently switching the power on/off accelerates lamp deterioration and greatly affects lamp life.
- Continuous use for one week or longer accelerates lamp deterioration. Lamp relay function (➔ page 77) can be used to reduce deterioration caused by continuous use.
- In rare cases, the lamps burst shortly after projection starts.
- The risk of bursting increases when the lamp is used beyond its replacement cycle. Make sure to replace the lamp unit regularly. ("When to replace the lamp unit" (➔ page 114), "Replacing the lamp unit" (➔ page 114))
- If the lamp bursts, gas contained inside of the lamp is released in a form of smoke.
- It is recommended that you store replacement lamp units for contingency.

### ■ About connections to computer or peripheral device

- To assure continued compliance, follow the attached installation instructions, which include using the provided power cord and shielded interface cables when connecting to computer or peripheral device.
- Use a commercial DVI-D cable with a ferrite core.

## Software information regarding this product

© Panasonic Corporation 2012

This product incorporates the following software.

(1) The software which is developed independently by or for Panasonic Corporation

(2) The software which is licensed under the GNU GENERAL PUBLIC LICENSE

(3) The software which is licensed under the GNU LESSER GENERAL PUBLIC LICENSE

For the license conditions of software categorized as (2) and (3), refer to the provisions of the Software license (GNU GENERAL PUBLIC LICENSE and GNU LESSER GENERAL PUBLIC LICENSE) in the supplied CD-ROM. (Those provisions are written in the original (English) because they have been stipulated by third parties.)

If you have any questions regarding the software, contact (sav.pj.gpl.pavc@ml.jp.panasonic.com) by E-mail.



## Accessories

Make sure that the following accessories are provided with your projector. Numbers enclosed in < > show the number of accessories.

**Wireless/wired remote control unit <1>**  
(N2QAYB000784)



**Lens cover <1>**  
(TKKL5244)

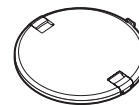

(for models with attached lenses only)

**Power cord <1>**  
(K2CG3YY00075)

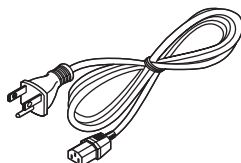

**CD-ROM <1>**  
(TXFQB02VLH4)

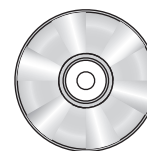

**Projection lens cover <1>**  
(TKPB35101)



**Power cord secure lock <1>**  
(TTRA0182)

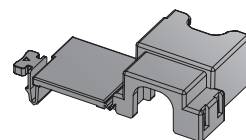

**AA/R6 battery <2>**

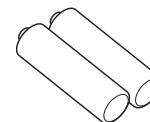

(For remote control unit)

### Attention

- After unpacking the projector, discard the power cord cap and packaging material properly.
- For missing accessories, consult your dealer.
- Store small parts in an appropriate manner, and keep them away from small children.

### Note

- The model numbers of accessories and optional components are subject to change without notice.

### Contents of the supplied CD-ROM

The contents of the supplied CD-ROM are as follows.

Instruction/list (PDF)	Operating Instructions - Functional Manual	
	Multi Projector Monitoring & Control Software Operation Manual	
	Logo Transfer Software Operating Manual	
	List of Compatible Projector Models	This is a list of projectors that are compatible with the software contained in the CD-ROM and their restrictions.
	Software license	(GNU GENERAL PUBLIC LICENSE, GNU LESSER GENERAL PUBLIC LICENSE)
Software	Multi Projector Monitoring & Control Software (Windows)	This software allows you to monitor and control multiple projectors connected to the LAN.
	Logo Transfer Software (Windows)	This software allows you to create original images, such as company logos to be displayed when projection starts, and transfer them to the projector.

## Optional accessories

Optional accessories (product name)	Model No.
Projection lens	ET-DLE055 (fixed-focus lens), ET-DLE080 (ultra short-focus zoom lens), ET-DLE150 (short-focus zoom lens), ET-DLE250 (medium-focus zoom lens), ET-DLE350 (long-focus zoom lens), ET-DLE450 (ultra long-focus zoom lens)
Ceiling mount bracket	ET-PKD56H (for high ceilings), ET-PKD55S (for low ceilings)
Replacement lamp unit	ET-LAD60A (1 pc), ET-LAD60AW (2 pcs)
Replacement filter unit	ET-EMF300

# Start-up display

The initial setting screen is displayed when the projector is switched on for the first time after purchase as well as when [INITIALIZE] – [ALL USER DATA] (➔ page 84) is executed. Set them in accordance with circumstances.

In other occasions, you can change the settings by menu operations.

## Note

- When the projector is used for the first time, you may be required to adjust the focus, zoom, and shift to display the menu screen clearly. Refer to “Adjusting the focus, zoom, and shift” (➔ page 45) for details.

## Initial setting (display language)

Select the language to show on the screen. (➔ page 67)

1) Press ▲▼ to select the display language.

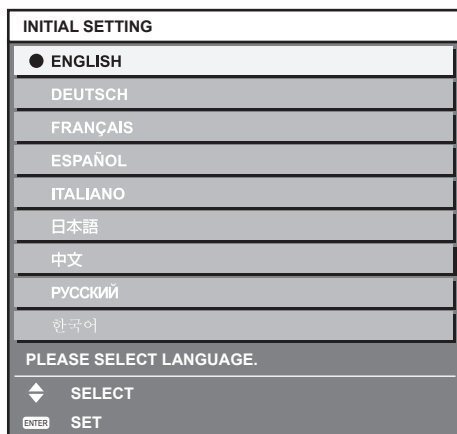

2) Press the <ENTER> button to proceed to the initial setting.

## Initial setting (projector setup)

Set each item.

1) Press ▲▼ to select an item.

2) Press ◀▶ to switch the setting.

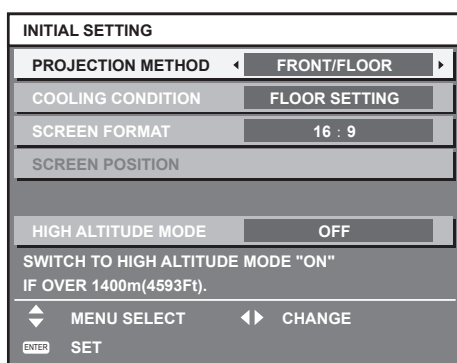

- Refer to the following pages for details.
  - [PROJECTION METHOD] (➔ page 75)
  - [COOLING CONDITION] (➔ page 76)
  - [SCREEN FORMAT] (➔ page 69)
  - [SCREEN POSITION] (➔ page 69)
  - [HIGH ALTITUDE MODE] (➔ page 76)

3) Press the <ENTER> button.

- Confirm the setting value to complete the initial setting.

## Note

- If you press the <MENU> button in the initial setting (projector setup) screen, you can go back to the initial setting (display language) screen.

# About your projector

## Remote control

### Front

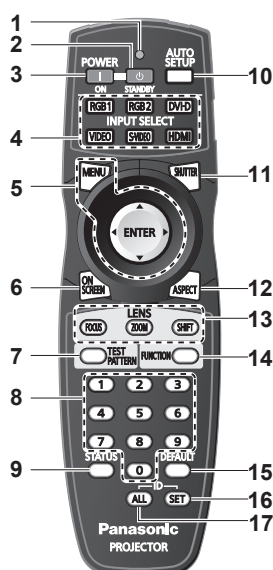

### Top

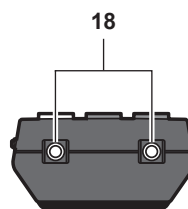

### Bottom

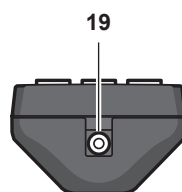

- 1 **Remote control indicator**  
Flashes if any button in the remote control is pressed.
- 2 **Power standby <P> button**  
Sets the projector to the standby mode when the <MAIN POWER> switch on the projector is set to <ON>.
- 3 **Power on <I> button**  
Starts projection when the <MAIN POWER> switch on the projector is set to <ON> and the power is switched off (standby mode).
- 4 **Input selection (<RGB1>, <RGB2>, <DVI-D>, <VIDEO>, <S-VIDEO>, <HDMI>) buttons**  
Switches the input signal to project. (➔ page 48)
- 5 **<MENU> button/<ENTER> button/▲▼▶ buttons**  
Used to operate the menu screen. (➔ page 51)
- 6 **<ON SCREEN> button**  
Switches the on-screen display function on (displayed)/off (hidden). (➔ page 47)
- 7 **<TEST PATTERN> button**  
Displays the test pattern. (➔ page 49)
- 8 **Number (<0> - <9>) buttons**  
Used when the system uses multiple projectors.  
Used to input ID numbers or passwords.
- 9 **<STATUS> button**  
Displays the projector information.
- 10 **<AUTO SETUP> button**  
Automatically adjusts the image display position while projecting the image.  
[PROGRESS] is displayed on the screen while the image is adjusted automatically. (➔ page 48)
- 11 **<SHUTTER> button**  
Use to temporarily turn off the image. (➔ page 47)
- 12 **<ASPECT> button**  
Switches the aspect ratio of the image. (➔ page 49)
- 13 **Lens (<FOCUS>, <ZOOM>, <SHIFT>) buttons**  
Adjusts the projection lens. (➔ pages 43, 45)
- 14 **<FUNCTION> button**  
You can assign a frequently used operation as a shortcut button. (➔ page 49)
- 15 **<DEFAULT> button**  
Resets the content of the sub-menu to the factory default. (➔ page 51)
- 16 **<ID SET> button**  
Sets the ID number of the remote control when a system uses multiple projectors. (➔ page 23)
- 17 **<ID ALL> button**  
Use to simultaneously control all the projectors with one remote control when a system uses multiple projectors. (➔ page 23)
- 18 **Remote control signal transmitter**
- 19 **Remote control wired terminal**  
Connecting to the projector with a cable (➔ page 24)

### Attention

- Do not drop the remote control.
- Avoid contact with liquids or moisture.
- Do not attempt to modify or disassemble the remote control.

### Note

- The remote control can be used within a distance of about 30 m (98'5") if pointed directly at the remote control receiver. The remote control can control at angles of up to  $\pm 15^\circ$  vertically and  $\pm 30^\circ$  horizontally, but the effective control range may be reduced.
- If there are any obstacles between the remote control and the remote control signal receiver, the remote control may not operate properly.
- The signal will be reflected off the screen. However, the operating range may be limited from light reflection loss due to the screen material.
- If the remote control signal receiver directly receives strong light, such as fluorescent light, the remote control may not operate properly. Use it in a place distant from the light source.
- The power indicator <ON (G)/STANDBY (R)> will flash if the projector receives a remote control signal.

## Projector body

### ■ Front

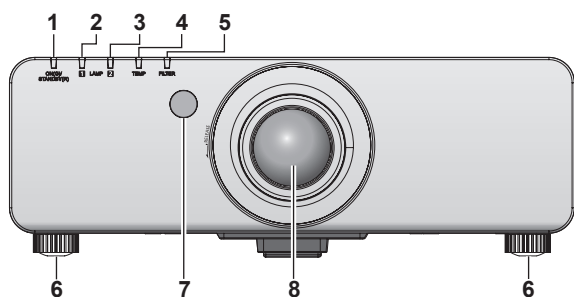

### ■ Rear

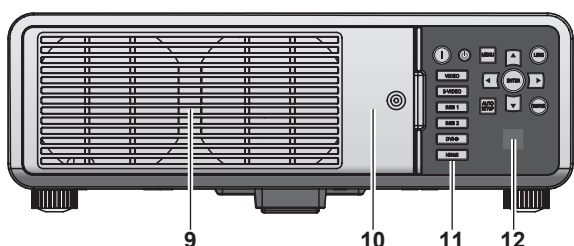

### ■ Side

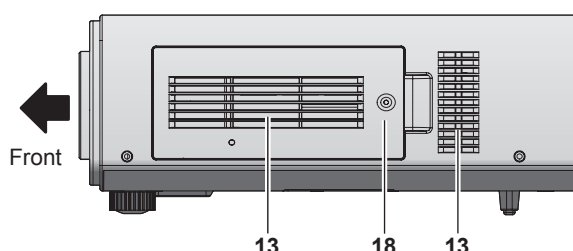
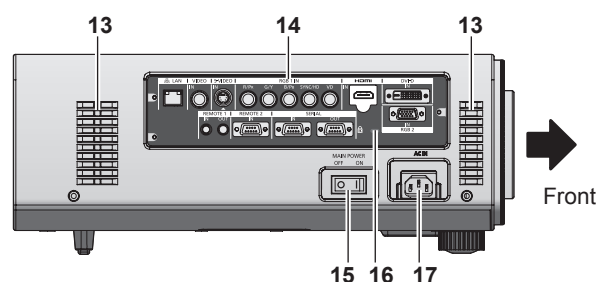

### ■ Bottom

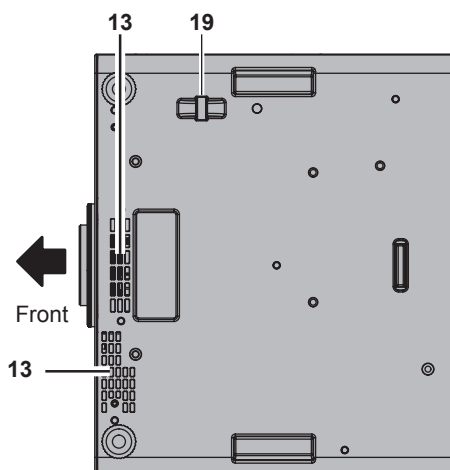

- 8 **Projection lens**  
(for models with attached lenses only)
- 9 **Air exhaust port**
- 10 **Lamp unit cover** (⇒ page 114)
- 11 **Control panel** (⇒ page 22)
- 12 **Remote control signal receiver (rear)**
- 13 **Air intake port**
- 14 **Connecting terminals** (⇒ page 22)
- 15 **<MAIN POWER> switch**  
Turns on/off the main power.
- 16 **Security slot**  
This security slot is compatible with the Kensington security cables.
- 17 **<AC IN> terminal**  
Connect the supplied power cord.
- 18 **Air filter cover**  
The air filter unit is inside. (⇒ page 112)
- 19 **Burglar hook port**  
You can attach a commercial burglar prevention cable.

## Warning

**Keep your hands and other objects away from the air exhaust port.**

- Keep your hands and face away.
- Do not insert your fingers.
- Keep heat-sensitive objects away.

Heated air from the air outlet port can cause burns, injury, or deformations.

- 1 **Power indicator <ON (G)/STANDBY (R)>**  
Displays the status of the power.
- 2 **Lamp indicator <LAMP1>**  
Displays the status of lamp 1.
- 3 **Lamp indicator <LAMP2>**  
Displays the status of lamp 2.
- 4 **Temperature indicator <TEMP>**  
Displays the internal temperature status.
- 5 **Filter indicator <FILTER>**  
Displays the status of the air filter unit.
- 6 **Adjustable feet**  
Adjusts the projection angle.
- 7 **Remote control signal receiver (front)**

## ■ Control panel

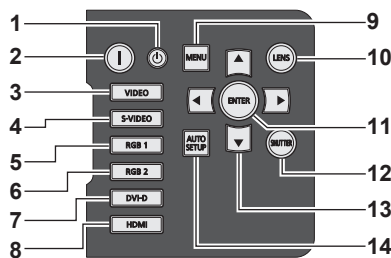

- |   |  |
|---|--|
| <p><b>1 Power standby &lt;⏻&gt; button</b><br/>Sets the projector to the standby mode when the &lt;MAIN POWER&gt; switch on the projector is set to &lt;ON&gt;.</p> <p><b>2 Power on &lt; &gt; button</b><br/>Starts projection when the &lt;MAIN POWER&gt; switch on the projector is set to &lt;ON&gt; when the power is switched off (standby mode).</p> <p><b>3 &lt;VIDEO&gt; button</b><br/>Switches to VIDEO input.</p> <p><b>4 &lt;S-VIDEO&gt; button</b><br/>Switches to S-VIDEO input.</p> <p><b>5 &lt;RGB1&gt; button</b><br/>Switches to RGB1 input.</p> <p><b>6 &lt;RGB2&gt; button</b><br/>Switches to RGB2 input.</p> <p><b>7 &lt;DVI-D&gt; button</b><br/>Switches to DVI-D input.</p> <p><b>8 &lt;HDMI&gt; button</b><br/>Switches to HDMI input.</p> | <p><b>9 &lt;MENU&gt; button</b><br/>Displays and erases the main menu.<br/>Returns to the previous screen when a sub-menu is displayed. (➡ page 51)<br/>If you press the &lt;MENU&gt; button on the control panel for at least three seconds while the on-screen indication is off, the on-screen display is turned on.</p> <p><b>10 &lt;LENS&gt; button</b><br/>Adjusts the focus, zoom, and shift (position) of the lens.</p> <p><b>11 &lt;ENTER&gt; button</b><br/>Determines and executes an item in the menu screen.</p> <p><b>12 &lt;SHUTTER&gt; button</b><br/>Use to temporarily turn off the image. (➡ page 47)</p> <p><b>13 ▲▼◀▶ selection buttons</b><br/>Use to select items in the menu screen, change settings, and adjust levels.<br/>It is also used to enter [SECURITY] passwords.</p> <p><b>14 &lt;AUTO SETUP&gt; button</b><br/>Automatically adjusts the image display position while projecting the image.<br/>[PROGRESS] is displayed on the screen while the image is adjusted automatically. (➡ page 48)</p> |
|---|--|

## ■ Connecting terminals

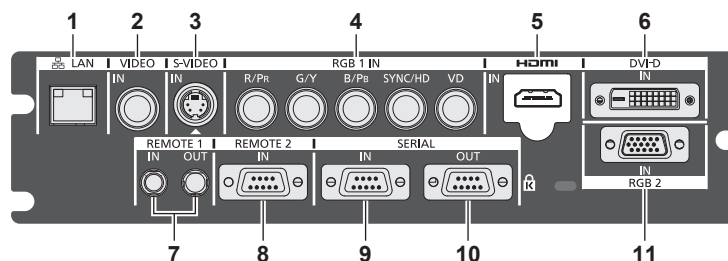

- |   |   |
|---|---|
| <p><b>1 &lt;LAN&gt; terminal</b><br/>This is a terminal to connect to the network.<br/>Used for control and monitoring. Image input through network connections is not possible.</p> <p><b>2 &lt;VIDEO IN&gt; terminal</b><br/>This is a terminal to input video signals.</p> <p><b>3 &lt;S-VIDEO IN&gt; terminal</b><br/>This is a terminal to input S video signals.</p> <p><b>4 &lt;RGB 1 IN&gt; (&lt;R/P<sub>R</sub>&gt;, &lt;G/Y&gt;, &lt;B/P<sub>B</sub>&gt;, &lt;SYNC/HD&gt;, &lt;VD&gt;) terminal</b><br/>This is a terminal to input RGB signals or YC<sub>B</sub>C<sub>R</sub>/YP<sub>B</sub>P<sub>R</sub> signals.</p> <p><b>5 &lt;HDMI IN&gt; terminal</b><br/>This is a terminal to input HDMI signals.</p> <p><b>6 &lt;DVI-D IN&gt; terminal</b><br/>This is a terminal to input DVI-D signals.</p> | <p><b>7 &lt;REMOTE 1 IN&gt; terminal / &lt;REMOTE 1 OUT&gt; terminal</b><br/>These are the terminals to connect the remote control for serial control when the system uses multiple projectors.</p> <p><b>8 &lt;REMOTE 2 IN&gt; terminal</b><br/>This is a terminal to remotely control the projector using the external control circuit.</p> <p><b>9 &lt;SERIAL IN&gt; terminal</b><br/>This is a RS-232C compatible terminal to externally control the projector by connecting a computer.</p> <p><b>10 &lt;SERIAL OUT&gt; terminal</b><br/>This is a terminal to output the signal connected to the &lt;SERIAL IN&gt; terminal.</p> <p><b>11 &lt;RGB 2 IN&gt; terminal</b><br/>This is a terminal to input RGB signals or YC<sub>B</sub>C<sub>R</sub>/YP<sub>B</sub>P<sub>R</sub> signals.</p> |
|---|---|

### Attention

- When a LAN cable is directly connected to the projector, the network connection must be made indoors.

# Using the remote control

## Inserting and removing the batteries

1) Open the cover.

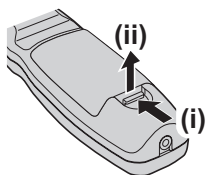

2) Insert the batteries and close the cover (insert the **+** side first).

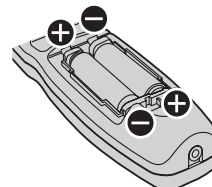

- When removing the batteries, perform the steps in reverse order.

## Setting Remote control ID numbers

When you use the system with multiple projectors, you can operate all the projectors simultaneously or each projector individually using single remote control, if a unique ID number is assigned to each projector.

After setting the ID number of the projector, set the same ID number on the remote control.

**The factory default ID number of the projector is set to [ALL]. When using a single projector, press the <ID ALL> button on the remote control. Also, you can control a projector if you press the <ID ALL> button on the remote control even if you do not know the projector ID.**

### How to set

1) Press the <ID SET> button on the remote control.

2) Within five seconds, press the two-digit ID number set on the projector using the number (<0> - <9>) buttons.

- If you press the <ID ALL> button, you can operate the projectors regardless of the setting of the projector's ID number.

### Attention

- Since the ID number of the remote control can be set without the projector, do not press the <ID SET> button carelessly. If the <ID SET> button is pressed and no number (<0> - <9>) buttons are pressed within the next five seconds, the ID number returns to its original value before the <ID SET> button was pressed.
- The ID number set on the remote control will be stored unless it is set again. However, it will be erased if the remote control is left with dead batteries. Set the same ID number again when the batteries are replaced.

### Note

- Set the ID number of the projector from the [PROJECTOR SETUP] menu → [PROJECTOR ID] (➡ page 75).

## Connecting to the projector with a cable

When you use the system with multiple projectors, configure the units as in the following figure. Use a commercial M3 stereo mini jack cable and connect the other devices to the <REMOTE 1 IN>/<REMOTE 1 OUT> terminals of the projector.

The remote control is effective even in places where an obstacle stands in the light path or where devices are susceptible to outside light.

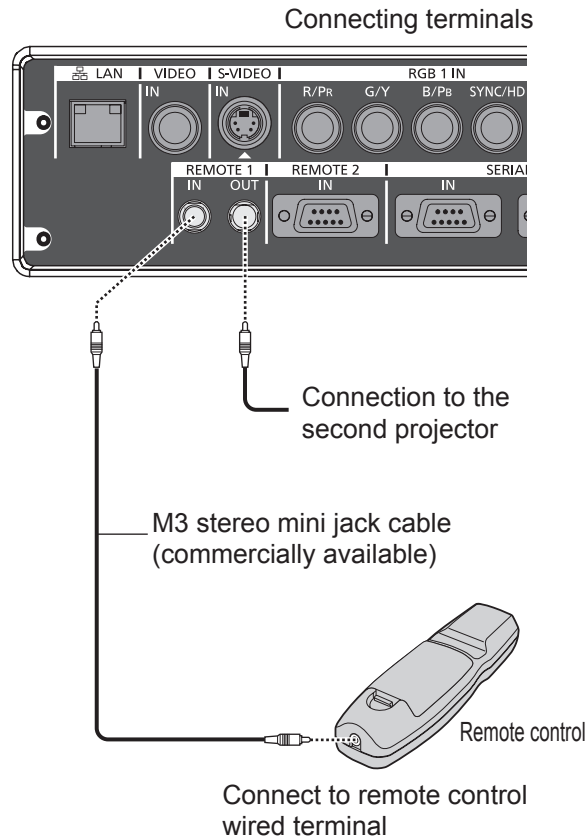

### Attention

- Use a cable that is 15 m (49'2") or shorter, with 2 core shield. The remote control may not operate when the length of the cable exceeds 15 m (49'2") or when the shielding of the cable is inadequate.



# Chapter 2 **Getting Started**

---

This chapter describes about things you need to do before using the projector such as the setup and connections.

# Setting up

## Projection method

You can use the projector with any of the following four projection methods. Select the appropriate method depending on the environment.

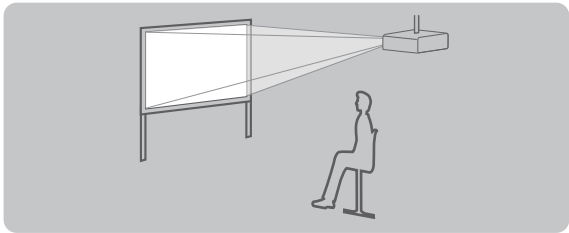
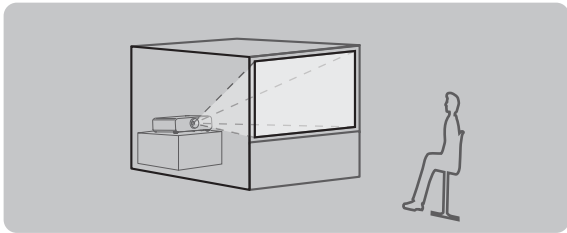
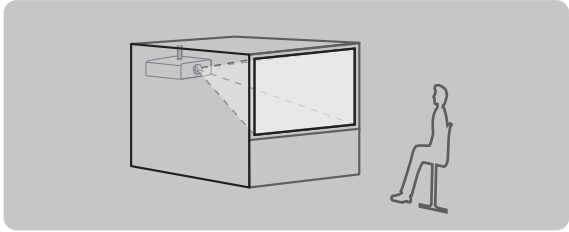
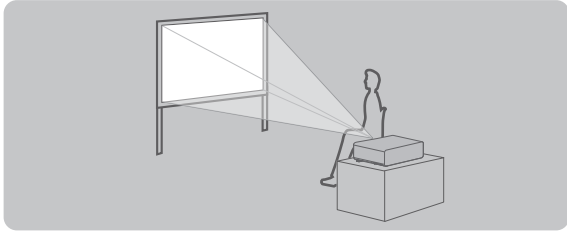
<b>Mounting on the ceiling and projecting forward</b> 		<b>Setting on a desk/floor and projecting from rear</b> (Using the translucent screen) 	
<b>Menu item*</b>	<b>Method</b>	<b>Menu item*</b>	<b>Method</b>
[PROJECTION METHOD]	[FRONT/CEILING]	[PROJECTION METHOD]	[REAR/FLOOR]
[COOLING CONDITION]	[CEILING SETTING]	[COOLING CONDITION]	[FLOOR SETTING]
<b>Mounting on the ceiling and projecting from rear</b> (Using the translucent screen) 		<b>Setting on a desk/floor and projecting forward</b> 	
<b>Menu item*</b>	<b>Method</b>	<b>Menu item*</b>	<b>Method</b>
[PROJECTION METHOD]	[REAR/CEILING]	[PROJECTION METHOD]	[FRONT/FLOOR]
[COOLING CONDITION]	[CEILING SETTING]	[COOLING CONDITION]	[FLOOR SETTING]

\* For menu item details, refer to the [PROJECTOR SETUP] menu → [PROJECTION METHOD] (➔ page 75) and [COOLING CONDITION] (➔ page 76).

## Parts for ceiling mount (optional)

You can install the projector on the ceiling using the optional ceiling mount bracket (ET-PKD56H: for high ceilings, or ET-PKD55S: for low ceilings).

- Use only the ceiling mount brackets specified for this projector.
- Refer to the installation manual for the ceiling mount bracket when installing the bracket and the projector.

### Attention

- To ensure projector performance and security, installation of the ceiling mount bracket must be carried out by your dealer or a qualified technician.

## Screen size and throw distance

Refer to the following figures and table describing projection distances to install the projector. Image size and image position can be adjusted in accordance with the screen size and screen position.

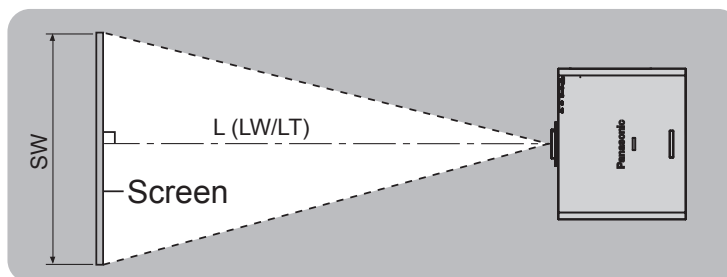
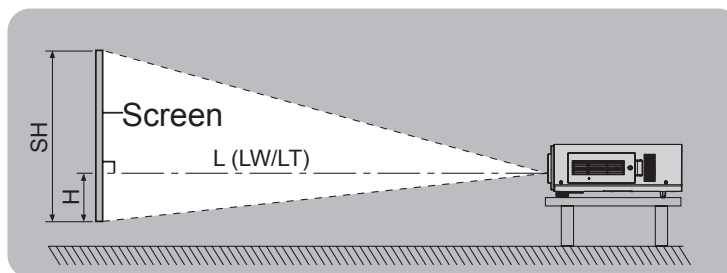
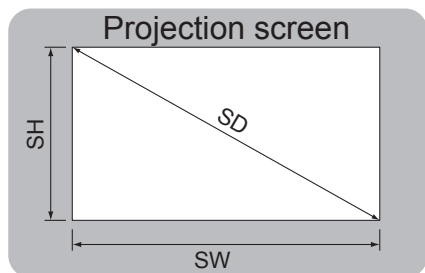

L (LW/LT)*	Projection distance (m)
SH	Image height (m)
SW	Image width (m)
H	Distance (m) from the lens center to the bottom edge of the image
SD	Image diagonal size (m)

\* LW: Minimum projection distance when the zoom lens is used  
 LT: Maximum projection distance when the zoom lens is used

### Attention

- Before setting up, read "Precautions for use" (➡ pages 14 to 18).
- Do not use the projector and the high-powered laser equipment in the same room.  
 Hitting of a laser beam on to the lens can damage the DLP chips.

## Projection distance per projection lens

## For PT-DW640U

## ■ When the screen aspect is 16:10 (unit: m)

(The dimensions of the following table contain slight error.)

Lens type			Standard zoom lens		Optional lens						
					Fixed-focus lens	Ultra-short focus zoom lens	Short focus zoom lens	Medium focus zoom lens			
Projection lens Model No.			—		ET-DLE055	ET-DLE080	ET-DLE150		ET-DLE250		
Throw ratio*1			1.8 – 2.4:1		0.8:1	0.8 – 1.0:1		1.4 – 2.0:1		2.4 – 3.8:1	
Projection screen size			Projection distance (L)								
Screen diagonal (SD)	Height (SH)	Width (SW)	Min.	Max.	Fixed	Min.	Max.	Min.	Max.	Min.	Max.
1.27 (50")	0.673	1.077	1.92	2.56	0.87	0.87	1.09	1.45	2.12	2.54	4.06
1.52 (60")	0.808	1.292	2.32	3.08	1.06	1.05	1.32	1.75	2.55	3.07	4.89
1.78 (70")	0.942	1.508	2.72	3.61	1.24	1.23	1.54	2.05	2.98	3.59	5.72
2.03 (80")	1.077	1.723	3.11	4.13	1.42	1.42	1.77	2.35	3.42	4.12	6.55
2.29 (90")	1.212	1.939	3.51	4.65	1.61	1.60	2.00	2.65	3.85	4.64	7.38
2.54 (100")	1.346	2.154	3.91	5.18	1.79	1.78	2.22	2.95	4.28	5.16	8.20
3.05 (120")	1.615	2.585	4.70	6.23	2.16	2.15	2.68	3.55	5.15	6.21	9.86
3.81 (150")	2.019	3.231	5.90	7.80	2.71	2.70	3.36	4.45	6.45	7.79	12.35
5.08 (200")	2.692	4.308	7.88	10.42	3.63	3.61	4.49	5.95	8.61	10.41	16.49
6.35 (250")	3.365	5.385	9.87	13.04	—	4.53	5.62	7.45	10.78	13.03	20.63
7.62 (300")	4.039	6.462	11.86	15.66	—	5.45	6.76	8.95	12.95	15.65	24.77
8.89 (350")	4.712	7.539	13.85	18.28	—	6.36	7.89	10.46	15.11	18.28	28.91
10.16 (400")	5.385	8.616	15.83	20.90	—	7.28	9.02	11.96	17.28	20.90	33.05
12.7 (500")	6.731	10.770	19.81	26.15	—	9.11	11.29	14.96	21.61	26.14	41.34
15.24 (600")	8.077	12.923	23.78	31.39	—	10.94	13.55	17.96	25.94	31.39	49.62

Lens type			Optional lens				Height position (H)*2	
			Long focus zoom lens		Ultra-long focus zoom lens			
Projection lens Model No.			ET-DLE350		ET-DLE450		Standard zoom lens/ ET-DLE080/ ET-DLE150/ ET-DLE250/ ET-DLE350/ ET-DLE450	ET-DLE055 (Fixed)
Throw ratio*1			3.8 – 5.7:1		5.6 – 9.0:1			
Projection screen size			Projection distance (L)					
Screen diagonal (SD)	Height (SH)	Width (SW)	Min.	Max.	Min.	Max.		
1.27 (50")	0.673	1.077	4.00	6.11	5.96	9.59	–0.07 - 0.34	0.34
1.52 (60")	0.808	1.292	4.83	7.36	7.21	11.57	–0.08 - 0.40	0.40
1.78 (70")	0.942	1.508	5.65	8.61	8.46	13.55	–0.09 - 0.47	0.47
2.03 (80")	1.077	1.723	6.48	9.86	9.71	15.53	–0.11 - 0.54	0.54
2.29 (90")	1.212	1.939	7.31	11.11	10.96	17.51	–0.12 - 0.61	0.61
2.54 (100")	1.346	2.154	8.13	12.36	12.21	19.49	–0.13 - 0.67	0.67
3.05 (120")	1.615	2.585	9.79	14.86	14.72	23.45	–0.16 - 0.81	0.81
3.81 (150")	2.019	3.231	12.27	18.61	18.47	29.38	–0.20 - 1.01	1.01
5.08 (200")	2.692	4.308	16.40	24.85	24.73	39.28	–0.27 - 1.35	1.35
6.35 (250")	3.365	5.385	20.53	31.10	30.99	49.17	–0.34 - 1.68	—
7.62 (300")	4.039	6.462	24.67	37.34	37.25	59.06	–0.40 - 2.02	—
8.89 (350")	4.712	7.539	28.80	43.59	43.51	68.96	–0.47 - 2.36	—
10.16 (400")	5.385	8.616	32.94	49.84	49.76	78.85	–0.54 - 2.69	—
12.7 (500")	6.731	10.770	41.20	62.33	62.28	98.64	–0.67 - 3.37	—
15.24 (600")	8.077	12.923	49.47	74.82	74.80	118.42	–0.81 - 4.04	—

\*1 The throw ratio is based on the value during projection onto a 2.03-m (80") screen size.

\*2 The height position (H) is SH/2 because lens shift cannot be used when a fixed-focus lens (Model No.:ET-DLE055) is attached.

■ When the screen aspect is 16:9 (unit: m)

(The dimensions of the following table contain slight error.)

Lens type			Standard zoom lens		Optional lens						
					Fixed-focus lens	Ultra-short focus zoom lens	Short focus zoom lens	Medium focus zoom lens			
Projection lens Model No.			—		ET-DLE055	ET-DLE080	ET-DLE150		ET-DLE250		
Throw ratio <sup>*1</sup>			1.8 – 2.4:1		0.8:1	0.8 – 1.0:1		1.4 – 2.0:1		2.4 – 3.8:1	
Projection screen size			Projection distance (L)								
Screen diagonal (SD)	Height (SH)	Width (SW)	Min.	Max.	Fixed	Min.	Max.	Min.	Max.	Min.	Max.
1.27 (50")	0.623	1.107	1.98	2.63	0.90	0.89	1.12	1.49	2.18	2.62	4.18
1.52 (60")	0.747	1.328	2.39	3.17	1.09	1.08	1.35	1.80	2.62	3.15	5.03
1.78 (70")	0.872	1.550	2.79	3.71	1.27	1.27	1.59	2.11	3.07	3.69	5.88
2.03 (80")	0.996	1.771	3.20	4.25	1.46	1.46	1.82	2.42	3.51	4.23	6.73
2.29 (90")	1.121	1.992	3.61	4.78	1.65	1.65	2.05	2.72	3.96	4.77	7.58
2.54 (100")	1.245	2.214	4.02	5.32	1.84	1.83	2.29	3.03	4.40	5.31	8.43
3.05 (120")	1.494	2.657	4.84	6.40	2.22	2.21	2.75	3.65	5.29	6.39	10.14
3.81 (150")	1.868	3.321	6.06	8.02	2.79	2.78	3.45	4.58	6.63	8.01	12.69
5.08 (200")	2.491	4.428	8.10	10.71	3.73	3.72	4.61	6.12	8.86	10.70	16.95
6.35 (250")	3.113	5.535	10.15	13.40	—	4.66	5.78	7.66	11.08	13.40	21.21
7.62 (300")	3.736	6.641	12.19	16.10	—	5.60	6.94	9.21	13.31	16.09	25.46
8.89 (350")	4.358	7.748	14.23	18.79	—	6.54	8.11	10.75	15.53	18.79	29.72
10.16 (400")	4.981	8.855	16.27	21.49	—	7.48	9.27	12.29	17.76	21.48	33.98
12.7 (500")	6.226	11.069	20.36	26.87	—	9.36	11.60	15.38	22.21	26.87	42.49
15.24 (600")	7.472	13.283	24.44	32.26	—	11.24	13.93	18.46	26.66	32.26	51.00

Lens type			Optional lens				Height position (H) <sup>*2</sup>	
			Long focus zoom lens		Ultra-long focus zoom lens			
Projection lens Model No.			ET-DLE350		ET-DLE450		Standard zoom lens/ ET-DLE080/ ET-DLE150/ ET-DLE250/ ET-DLE350/ ET-DLE450	ET-DLE055 (Fixed)
Throw ratio <sup>*1</sup>			3.8 – 5.7:1		5.6 – 9.0:1			
Projection screen size			Projection distance (L)					
Screen diagonal (SD)	Height (SH)	Width (SW)	Min.	Max.	Min.	Max.		
1.27 (50")	0.623	1.107	4.11	6.29	6.13	9.87	-0.14 - 0.31	0.31
1.52 (60")	0.747	1.328	4.96	7.57	7.42	11.90	-0.16 - 0.37	0.37
1.78 (70")	0.872	1.550	5.81	8.85	8.70	13.94	-0.19 - 0.44	0.44
2.03 (80")	0.996	1.771	6.66	10.14	9.99	15.97	-0.22 - 0.50	0.50
2.29 (90")	1.121	1.992	7.51	11.42	11.28	18.00	-0.25 - 0.56	0.56
2.54 (100")	1.245	2.214	8.36	12.71	12.56	20.04	-0.27 - 0.62	0.62
3.05 (120")	1.494	2.657	10.06	15.27	15.14	24.11	-0.33 - 0.75	0.75
3.81 (150")	1.868	3.321	12.61	19.13	18.99	30.21	-0.41 - 0.93	0.93
5.08 (200")	2.491	4.428	16.86	25.55	25.43	40.38	-0.55 - 1.25	1.25
6.35 (250")	3.113	5.535	21.11	31.97	31.86	50.54	-0.68 - 1.56	—
7.62 (300")	3.736	6.641	25.36	38.39	38.29	60.71	-0.82 - 1.87	—
8.89 (350")	4.358	7.748	29.61	44.81	44.72	70.88	-0.96 - 2.18	—
10.16 (400")	4.981	8.855	33.86	51.23	51.16	81.05	-1.10 - 2.49	—
12.7 (500")	6.226	11.069	42.35	64.07	64.02	101.39	-1.37 - 3.11	—
15.24 (600")	7.472	13.283	50.85	76.91	76.88	121.73	-1.64 - 3.74	—

\*1 The throw ratio is based on the value during projection onto a 2.03-m (80") screen size.

\*2 The height position (H) is SH/2 because lens shift cannot be used when a fixed-focus lens (Model No.:ET-DLE055) is attached.

■ When the screen aspect is 4:3 (unit: m)

(The dimensions of the following table contain slight error.)

Lens type			Standard zoom lens		Optional lens						
					Fixed-focus lens	Ultra-short focus zoom lens	Short focus zoom lens		Medium focus zoom lens		
Projection lens Model No.			—		ET-DLE055	ET-DLE080	ET-DLE150		ET-DLE250		
Throw ratio*1			2.2 – 2.9:1		1.0:1	1.0 – 1.2:1		1.6 – 2.4:1		2.9 – 4.6:1	
Projection screen size			Projection distance (L)								
Screen diagonal (SD)	Height (SH)	Width (SW)	Min.	Max.	Fixed	Min.	Max.	Min.	Max.	Min.	Max.
1.27 (50")	0.762	1.016	2.18	2.90	0.99	0.99	1.24	1.65	2.40	2.89	4.61
1.52 (60")	0.914	1.219	2.63	3.50	1.20	1.20	1.50	1.99	2.89	3.48	5.55
1.78 (70")	1.067	1.422	3.08	4.09	1.41	1.40	1.75	2.33	3.38	4.08	6.48
2.03 (80")	1.219	1.626	3.53	4.68	1.62	1.61	2.01	2.67	3.87	4.67	7.42
2.29 (90")	1.372	1.829	3.98	5.28	1.82	1.82	2.26	3.00	4.36	5.26	8.36
2.54 (100")	1.524	2.032	4.43	5.87	2.03	2.03	2.52	3.34	4.85	5.86	9.30
3.05 (120")	1.829	2.438	5.33	7.06	2.45	2.44	3.03	4.02	5.83	7.04	11.17
3.81 (150")	2.286	3.048	6.68	8.84	3.07	3.06	3.80	5.04	7.31	8.82	13.98
5.08 (200")	3.048	4.064	8.93	11.80	4.11	4.10	5.09	6.74	9.76	11.79	18.67
6.35 (250")	3.810	5.080	11.18	14.77	—	5.13	6.37	8.44	12.21	14.76	23.36
7.62 (300")	4.572	6.096	13.43	17.73	—	6.17	7.65	10.14	14.66	17.73	28.05
8.89 (350")	5.334	7.112	15.68	20.70	—	7.21	8.93	11.84	17.11	20.70	32.74
10.16 (400")	6.096	8.128	17.93	23.67	—	8.24	10.22	13.54	19.56	23.67	37.42
12.7 (500")	7.620	10.160	22.43	29.60	—	10.31	12.78	16.94	24.47	29.60	46.80
15.24 (600")	9.144	12.192	26.92	35.53	—	12.39	15.35	20.34	29.37	35.54	56.17

Lens type			Optional lens				Height position (H)*2	
			Long focus zoom lens		Ultra-long focus zoom lens			
Projection lens Model No.			ET-DLE350		ET-DLE450		Standard zoom lens/ ET-DLE080/ ET-DLE150/ ET-DLE250/ ET-DLE350/ ET-DLE450	ET-DLE055 (Fixed)
Throw ratio*1			4.5 – 6.9:1		6.8 – 10.8:1			
Projection screen size			Projection distance (L)					
Screen diagonal (SD)	Height (SH)	Width (SW)	Min.	Max.	Min.	Max.		
1.27 (50")	0.762	1.016	4.54	6.94	6.78	10.90	-0.08 - 0.38	0.38
1.52 (60")	0.914	1.219	5.48	8.35	8.20	13.14	-0.09 - 0.46	0.46
1.78 (70")	1.067	1.422	6.42	9.76	9.61	15.38	-0.11 - 0.53	0.53
2.03 (80")	1.219	1.626	7.35	11.18	11.03	17.62	-0.12 - 0.61	0.61
2.29 (90")	1.372	1.829	8.29	12.59	12.45	19.86	-0.14 - 0.69	0.69
2.54 (100")	1.524	2.032	9.22	14.01	13.87	22.10	-0.15 - 0.76	0.76
3.05 (120")	1.829	2.438	11.09	16.83	16.70	26.58	-0.18 - 0.91	0.91
3.81 (150")	2.286	3.048	13.90	21.08	20.95	33.30	-0.23 - 1.14	1.14
5.08 (200")	3.048	4.064	18.58	28.15	28.03	44.49	-0.30 - 1.52	1.52
6.35 (250")	3.810	5.080	23.26	35.22	35.12	55.69	-0.38 - 1.91	—
7.62 (300")	4.572	6.096	27.94	42.29	42.20	66.89	-0.46 - 2.29	—
8.89 (350")	5.334	7.112	32.62	49.36	49.28	78.09	-0.53 - 2.67	—
10.16 (400")	6.096	8.128	37.30	56.43	56.37	89.29	-0.61 - 3.05	—
12.7 (500")	7.620	10.160	46.65	70.57	70.53	111.68	-0.76 - 3.81	—
15.24 (600")	9.144	12.192	56.01	84.71	84.70	134.08	-0.91 - 4.57	—

\*1 The throw ratio is based on the value during projection onto a 2.03-m (80") screen size.

\*2 The height position (H) is SH/2 because lens shift cannot be used when a fixed-focus lens (Model No.:ET-DLE055) is attached.

## For PT-DX610U

## ■ When the screen aspect is 4:3 (unit: m)

(The dimensions of the following table contain slight error.)

Lens type			Standard zoom lens		Optional lens						
					Fixed-focus lens	Ultra-short focus zoom lens	Short focus zoom lens	Medium focus zoom lens			
Projection lens Model No.			—		ET-DLE055	ET-DLE080	ET-DLE150		ET-DLE250		
Throw ratio <sup>*1</sup>			1.8 – 2.4:1		0.8:1	0.8 – 1.0:1		1.3 – 2.0:1		2.4 – 3.7:1	
Projection screen size			Projection distance (L)								
Screen diagonal (SD)	Height (SH)	Width (SW)	Min.	Max.	Fixed	Min.	Max.	Min.	Max.	Min.	Max.
1.27 (50")	0.762	1.016	1.79	2.38	0.81	0.81	1.01	1.34	1.97	2.36	3.78
1.52 (60")	0.914	1.219	2.16	2.86	0.98	0.98	1.22	1.62	2.37	2.85	4.55
1.78 (70")	1.067	1.422	2.53	3.35	1.15	1.15	1.43	1.90	2.77	3.34	5.32
2.03 (80")	1.219	1.626	2.90	3.84	1.32	1.32	1.64	2.18	3.18	3.83	6.09
2.29 (90")	1.372	1.829	3.27	4.33	1.49	1.49	1.85	2.46	3.58	4.31	6.86
2.54 (100")	1.524	2.032	3.64	4.82	1.66	1.66	2.07	2.74	3.98	4.80	7.63
3.05 (120")	1.829	2.438	4.38	5.79	2.01	2.00	2.49	3.30	4.79	5.78	9.17
3.81 (150")	2.286	3.048	5.49	7.26	2.52	2.51	3.12	4.14	6.00	7.24	11.49
5.08 (200")	3.048	4.064	7.34	9.70	3.38	3.36	4.18	5.54	8.02	9.69	15.34
6.35 (250")	3.810	5.080	9.19	12.14	—	4.21	5.23	6.94	10.03	12.13	19.20
7.62 (300")	4.572	6.096	11.04	14.58	—	5.07	6.29	8.33	12.05	14.57	23.06
8.89 (350")	5.334	7.112	12.89	17.02	—	5.92	7.34	9.73	14.07	17.01	26.91
10.16 (400")	6.096	8.128	14.74	19.46	—	6.77	8.40	11.13	16.08	19.45	30.77
12.7 (500")	7.620	10.160	18.44	24.34	—	8.48	10.51	13.92	20.12	24.33	38.48
15.24 (600")	9.144	12.192	22.14	29.22	—	10.18	12.62	16.72	24.15	29.22	46.19

Lens type			Optional lens				Height position (H) <sup>*2</sup>		
			Long focus zoom lens		Ultra-long focus zoom lens		Standard zoom lens/ ET-DLE150/ ET-DLE250/ ET-DLE350/ ET-DLE450	ET-DLE080	ET-DLE055 (Fixed)
Projection lens Model No.			ET-DLE350		ET-DLE450				
Throw ratio <sup>*1</sup>			3.7 – 5.6:1		5.5 – 8.9:1				
Projection screen size			Projection distance (L)						
Screen diagonal (SD)	Height (SH)	Width (SW)	Min.	Max.	Min.	Max.			
1.27 (50")	0.762	1.016	3.71	5.68	5.52	8.91	0 - 0.38	0.04 - 0.38	0.38
1.52 (60")	0.914	1.219	4.48	6.84	6.69	10.75	0 - 0.46	0.05 - 0.46	0.46
1.78 (70")	1.067	1.422	5.25	8.01	7.86	12.60	0 - 0.53	0.05 - 0.53	0.53
2.03 (80")	1.219	1.626	6.02	9.17	9.02	14.44	0 - 0.61	0.06 - 0.61	0.61
2.29 (90")	1.372	1.829	6.79	10.33	10.19	16.28	0 - 0.69	0.07 - 0.69	0.69
2.54 (100")	1.524	2.032	7.56	11.50	11.35	18.12	0 - 0.76	0.08 - 0.76	0.76
3.05 (120")	1.829	2.438	9.10	13.82	13.68	21.81	0 - 0.91	0.09 - 0.91	0.91
3.81 (150")	2.286	3.048	11.41	17.31	17.18	27.33	0 - 1.14	0.11 - 1.14	1.14
5.08 (200")	3.048	4.064	15.26	23.13	23.00	36.54	0 - 1.52	0.15 - 1.52	1.52
6.35 (250")	3.810	5.080	19.11	28.94	28.83	45.75	0 - 1.91	0.19 - 1.91	—
7.62 (300")	4.572	6.096	22.96	34.76	34.66	54.97	0 - 2.29	0.23 - 2.29	—
8.89 (350")	5.334	7.112	26.80	40.57	40.48	64.18	0 - 2.67	0.27 - 2.67	—
10.16 (400")	6.096	8.128	30.65	46.39	46.31	73.39	0 - 3.05	0.30 - 3.05	—
12.7 (500")	7.620	10.160	38.35	58.02	57.96	91.81	0 - 3.81	0.38 - 3.81	—
15.24 (600")	9.144	12.192	46.05	69.65	69.61	110.23	0 - 4.57	0.46 - 4.57	—

\*1 The throw ratio is based on the value during projection onto a 2.03-m (80") screen size.

\*2 The height position (H) is SH/2 because lens shift cannot be used when a fixed-focus lens (Model No.:ET-DLE055) is attached.

■ When the screen aspect is 16:9 (unit: m)

(The dimensions of the following table contain slight error.)

Lens type			Standard zoom lens		Optional lens						
					Fixed-focus lens	Ultra-short focus zoom lens	Short focus zoom lens		Medium focus zoom lens		
Projection lens Model No.			—		ET-DLE055	ET-DLE080		ET-DLE150		ET-DLE250	
Throw ratio <sup>*1</sup>			1.8 – 2.4:1		0.8:1	0.8 – 1.0:1		1.3 – 2.0:1		2.4 – 3.8:1	
Projection screen size			Projection distance (L)								
Screen diagonal (SD)	Height (SH)	Width (SW)	Min.	Max.	Fixed	Min.	Max.	Min.	Max.	Min.	Max.
1.27 (50")	0.623	1.107	1.95	2.59	0.88	0.88	1.11	1.47	2.15	2.58	4.12
1.52 (60")	0.747	1.328	2.35	3.13	1.07	1.07	1.34	1.77	2.59	3.11	4.96
1.78 (70")	0.872	1.550	2.76	3.66	1.26	1.25	1.57	2.08	3.03	3.64	5.80
2.03 (80")	0.996	1.771	3.16	4.19	1.44	1.44	1.79	2.38	3.47	4.18	6.64
2.29 (90")	1.121	1.992	3.56	4.72	1.63	1.62	2.02	2.69	3.90	4.71	7.48
2.54 (100")	1.245	2.214	3.97	5.25	1.82	1.81	2.25	2.99	4.34	5.24	8.32
3.05 (120")	1.494	2.657	4.77	6.32	2.19	2.18	2.71	3.60	5.22	6.30	10.00
3.81 (150")	1.868	3.321	5.98	7.91	2.75	2.74	3.40	4.51	6.54	7.90	12.52
5.08 (200")	2.491	4.428	8.00	10.57	3.68	3.67	4.55	6.04	8.74	10.56	16.72
6.35 (250")	3.113	5.535	10.01	13.23	—	4.60	5.70	7.56	10.93	13.22	20.93
7.62 (300")	3.736	6.641	12.03	15.89	—	5.52	6.85	9.08	13.13	15.88	25.13
8.89 (350")	4.358	7.748	14.04	18.54	—	6.45	8.00	10.61	15.33	18.54	29.33
10.16 (400")	4.981	8.855	16.06	21.20	—	7.38	9.15	12.13	17.53	21.20	33.53
12.7 (500")	6.226	11.069	20.09	26.52	—	9.24	11.45	15.17	21.92	26.52	41.93
15.24 (600")	7.472	13.283	24.12	31.84	—	11.10	13.75	18.22	26.31	31.84	50.33

Lens type			Optional lens				Height position (H) <sup>*2</sup>		
			Long focus zoom lens		Ultra-long focus zoom lens				
Projection lens Model No.			ET-DLE350		ET-DLE450		Standard zoom lens/ ET-DLE150/ ET-DLE250/ ET-DLE350/ ET-DLE450	ET-DLE080	ET-DLE055 (Fixed)
Throw ratio <sup>*1</sup>			3.7 – 5.6:1		5.6 – 8.9:1				
Projection screen size			Projection distance (L)						
Screen diagonal (SD)	Height (SH)	Width (SW)	Min.	Max.	Min.	Max.			
1.27 (50")	0.623	1.107	4.06	6.20	6.05	9.74	–0.21 - 0.31	–0.16 - 0.31	0.31
1.52 (60")	0.747	1.328	4.90	7.47	7.32	11.74	–0.25 - 0.37	–0.19 - 0.37	0.37
1.78 (70")	0.872	1.550	5.73	8.74	8.58	13.75	–0.29 - 0.44	–0.23 - 0.44	0.44
2.03 (80")	0.996	1.771	6.57	10.00	9.85	15.76	–0.33 - 0.50	–0.26 - 0.50	0.50
2.29 (90")	1.121	1.992	7.41	11.27	11.12	17.76	–0.37 - 0.56	–0.29 - 0.56	0.56
2.54 (100")	1.245	2.214	8.25	12.54	12.39	19.77	–0.41 - 0.62	–0.32 - 0.62	0.62
3.05 (120")	1.494	2.657	9.93	15.07	14.93	23.78	–0.49 - 0.75	–0.39 - 0.75	0.75
3.81 (150")	1.868	3.321	12.44	18.87	18.74	29.81	–0.62 - 0.93	–0.49 - 0.93	0.93
5.08 (200")	2.491	4.428	16.64	25.21	25.09	39.84	–0.82 - 1.25	–0.65 - 1.25	1.25
6.35 (250")	3.113	5.535	20.83	31.54	31.44	49.88	–1.03 - 1.56	–0.81 - 1.56	—
7.62 (300")	3.736	6.641	25.02	37.88	37.78	59.91	–1.23 - 1.87	–0.97 - 1.87	—
8.89 (350")	4.358	7.748	29.22	44.22	44.13	69.95	–1.44 - 2.18	–1.13 - 2.18	—
10.16 (400")	4.981	8.855	33.41	50.55	50.48	79.98	–1.64 - 2.49	–1.30 - 2.49	—
12.7 (500")	6.226	11.069	41.79	63.22	63.17	100.05	–2.05 - 3.11	–1.62 - 3.11	—
15.24 (600")	7.472	13.283	50.18	75.89	75.87	120.12	–2.47 - 3.74	–1.94 - 3.74	—

\*1 The throw ratio is based on the value during projection onto a 2.03-m (80") screen size.

\*2 The height position (H) is SH/2 because lens shift cannot be used when a fixed-focus lens (Model No.:ET-DLE055) is attached.



**Projection distance formulas by projection lens**

To use a screen size not listed in this manual, check the screen size SD and use the following formula to calculate projection distance. The unit of the calculation result is m.

**For PT-DW640U**

Lens type	Projection lens Model No.	Aspect ratio	Projection distance (L) formula	
Standard zoom lens	—	16:10	Min. (LW)	$L = 1.5630 \times SD (m) - 0.0650$
			Max. (LT)	$L = 2.0630 \times SD (m) - 0.0638$
		16:9	Min. (LW)	$L = 1.6063 \times SD (m) - 0.0650$
			Max. (LT)	$L = 2.1220 \times SD (m) - 0.0638$
		4:3	Min. (LW)	$L = 1.7717 \times SD (m) - 0.0650$
			Max. (LT)	$L = 2.3346 \times SD (m) - 0.0638$
Fixed-focus lens	ET-DLE055	16:10	—	$L = 0.7244 \times SD (m) - 0.0476$
		16:9	—	$L = 0.7441 \times SD (m) - 0.0476$
		4:3	—	$L = 0.8189 \times SD (m) - 0.0476$
Ultra-short focus zoom lens	ET-DLE080	16:10	Min. (LW)	$L = 0.7205 \times SD (m) - 0.0471$
			Max. (LT)	$L = 0.8937 \times SD (m) - 0.0442$
		16:9	Min. (LW)	$L = 0.7402 \times SD (m) - 0.0471$
			Max. (LT)	$L = 0.9173 \times SD (m) - 0.0442$
		4:3	Min. (LW)	$L = 0.8150 \times SD (m) - 0.0471$
			Max. (LT)	$L = 1.0118 \times SD (m) - 0.0442$
Short focus zoom lens	ET-DLE150	16:10	Min. (LW)	$L = 1.1811 \times SD (m) - 0.0540$
			Max. (LT)	$L = 1.7047 \times SD (m) - 0.0498$
		16:9	Min. (LW)	$L = 1.2165 \times SD (m) - 0.0540$
			Max. (LT)	$L = 1.7520 \times SD (m) - 0.0498$
		4:3	Min. (LW)	$L = 1.3386 \times SD (m) - 0.0540$
			Max. (LT)	$L = 1.9291 \times SD (m) - 0.0498$
Medium focus zoom lens	ET-DLE250	16:10	Min. (LW)	$L = 2.0630 \times SD (m) - 0.0800$
			Max. (LT)	$L = 3.2598 \times SD (m) - 0.0792$
		16:9	Min. (LW)	$L = 2.1220 \times SD (m) - 0.0800$
			Max. (LT)	$L = 3.3504 \times SD (m) - 0.0792$
		4:3	Min. (LW)	$L = 2.3386 \times SD (m) - 0.0800$
			Max. (LT)	$L = 3.6929 \times SD (m) - 0.0792$
Long focus zoom lens	ET-DLE350	16:10	Min. (LW)	$L = 3.2559 \times SD (m) - 0.1351$
			Max. (LT)	$L = 4.9173 \times SD (m) - 0.1346$
		16:9	Min. (LW)	$L = 3.3465 \times SD (m) - 0.1351$
			Max. (LT)	$L = 5.0551 \times SD (m) - 0.1346$
		4:3	Min. (LW)	$L = 3.6850 \times SD (m) - 0.1351$
			Max. (LT)	$L = 5.5669 \times SD (m) - 0.1346$
Ultra-long focus zoom lens	ET-DLE450	16:10	Min. (LW)	$L = 4.9291 \times SD (m) - 0.3017$
			Max. (LT)	$L = 7.7913 \times SD (m) - 0.2991$
		16:9	Min. (LW)	$L = 5.0630 \times SD (m) - 0.3017$
			Max. (LT)	$L = 8.0079 \times SD (m) - 0.2991$
		4:3	Min. (LW)	$L = 5.5787 \times SD (m) - 0.3017$
			Max. (LT)	$L = 8.8189 \times SD (m) - 0.2991$

**For PT-DX610U**

Lens type	Projection lens Model No.	Aspect ratio	Projection distance (L) formula	
Standard zoom lens	—	4:3	Min. (LW)	$L = 1.4567 \times SD (m) - 0.0650$
			Max. (LT)	$L = 1.9213 \times SD (m) - 0.0638$
		16:9	Min. (LW)	$L = 1.5866 \times SD (m) - 0.0650$
			Max. (LT)	$L = 2.0945 \times SD (m) - 0.0638$
Fixed-focus lens	ET-DLE055	4:3	—	$L = 0.6732 \times SD (m) - 0.0476$
		16:9	—	$L = 0.7323 \times SD (m) - 0.0476$

Lens type	Projection lens Model No.	Aspect ratio	Projection distance (L) formula	
Ultra-short focus zoom lens	ET-DLE080	4:3	Min. (LW)	$L = 0.6693 \times SD (m) - 0.0471$
			Max. (LT)	$L = 0.8307 \times SD (m) - 0.0442$
		16:9	Min. (LW)	$L = 0.7323 \times SD (m) - 0.0471$
			Max. (LT)	$L = 0.9055 \times SD (m) - 0.0442$
Short focus zoom lens	ET-DLE150	4:3	Min. (LW)	$L = 1.1024 \times SD (m) - 0.0540$
			Max. (LT)	$L = 1.5866 \times SD (m) - 0.0498$
		16:9	Min. (LW)	$L = 1.2008 \times SD (m) - 0.0540$
			Max. (LT)	$L = 1.7283 \times SD (m) - 0.0498$
Medium focus zoom lens	ET-DLE250	4:3	Min. (LW)	$L = 1.9213 \times SD (m) - 0.0800$
			Max. (LT)	$L = 3.0354 \times SD (m) - 0.0792$
		16:9	Min. (LW)	$L = 2.0945 \times SD (m) - 0.0800$
			Max. (LT)	$L = 3.3071 \times SD (m) - 0.0792$
Long focus zoom lens	ET-DLE350	4:3	Min. (LW)	$L = 3.0315 \times SD (m) - 0.1351$
			Max. (LT)	$L = 4.5787 \times SD (m) - 0.1346$
		16:9	Min. (LW)	$L = 3.3031 \times SD (m) - 0.1351$
			Max. (LT)	$L = 4.9882 \times SD (m) - 0.1346$
Ultra-long focus zoom lens	ET-DLE450	4:3	Min. (LW)	$L = 4.5866 \times SD (m) - 0.3017$
			Max. (LT)	$L = 7.2520 \times SD (m) - 0.2991$
		16:9	Min. (LW)	$L = 5.0000 \times SD (m) - 0.3017$
			Max. (LT)	$L = 7.9016 \times SD (m) - 0.2991$

## Adjusting adjustable feet

Install the projector on a flat surface so that the front of the projector is parallel to the screen surface and the projection screen is rectangular. If the screen is tilted downward, the projection screen can be adjusted to be rectangular by adjusting the adjustable feet. The adjustable feet can also be used to adjust the projector to be level when it is tilted in a horizontal direction.

Extend the adjustable feet by rotating in the direction shown in the figure and retract by rotating in the opposite direction.

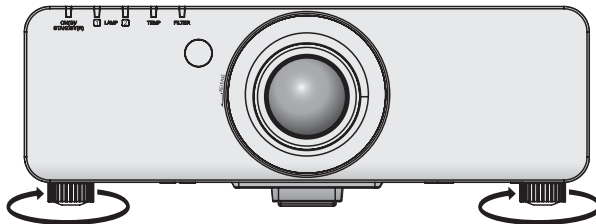

### Adjustable amount

Front adjustable feet: 30 mm (1-3/16")

### Attention

- Hot air is expelled from the air exhaust port when the lamp is on. Do not touch the air exhaust port directly when adjusting the adjustable feet. (➔ page 21)

## Removing/attaching the projection lens

Attach and remove the projection lens in the same way as a standard zoom lens and optional accessories. Move the projection lens to the home position before replacing or removing the lens (➔ page 46).

### Attention

- Replace the projection lens after turning off the power of the projector.
- Do not touch the lens signal receiver. Dust or dirt may cause defective contact.
- Do not touch the lens surface with bare hands.
- Before attaching the projection lens, remove the lens cover attached to the projection lens.
- The procedure to remove/attach a projection lens cover differs for the ultra-short focus zoom lens (ET-DLE080). Refer to the user manual provided with ET-DLE080 for details.

### Removing the projection lens

Remove the projection lens in the following procedure.

- 1) Turn the projection lens cover counterclockwise to remove.

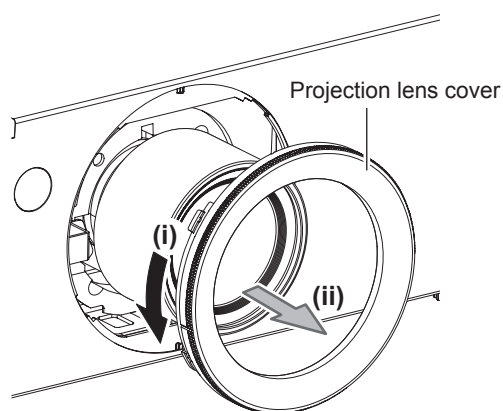

- 2) While pressing the lens release button, turn the projection lens counterclockwise until it stops. Remove the projection lens.

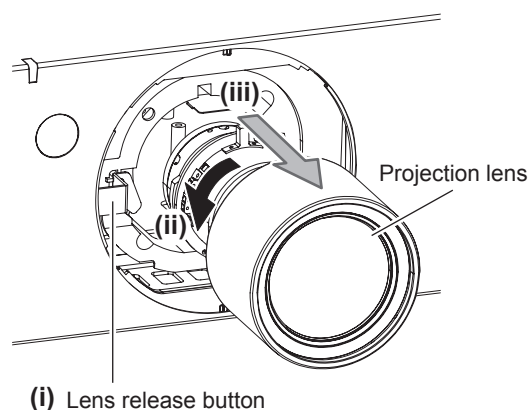

### Attention

- Store the removed lens where it will be free from vibration and impact.

### Attaching the projection lens

Attach the projection lens in the following procedure.

- 1) Remove the projection lens cover and insert fully by aligning the projection lens guide with the projector guide grooves.
- 2) Turn the projection lens clockwise until it clicks.

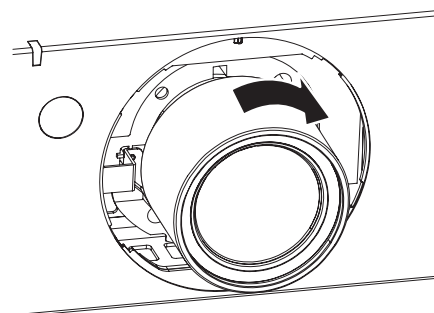
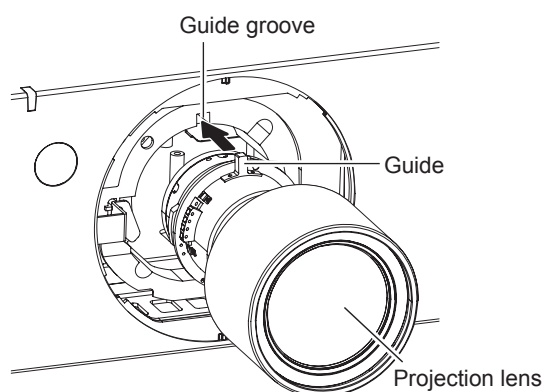

- 3) Attach the projection lens cover aligning the marking (groove \*1) with the tip of the arrow on the projector (\*2), and secure the projection lens cover by turning it until groove \*1 aligns with the \*3  marking.

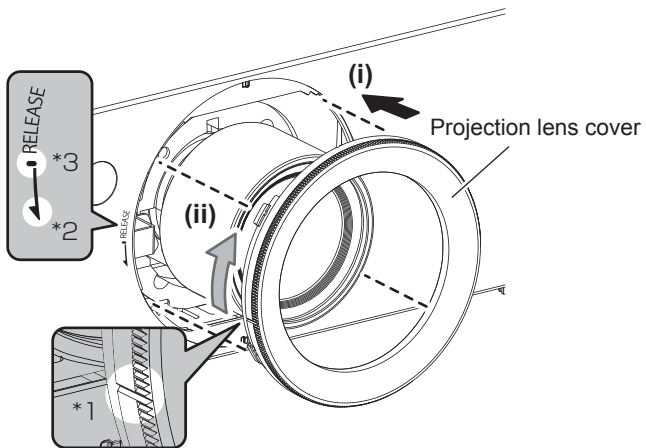

---

### Attention

- Turn the projection lens counterclockwise to confirm that it does not come out.

# Connections

## Before connecting to the projector

- Before connecting, carefully read the operating instructions for the external device to be connected.
- Turn off the power of all devices before connecting cables.
- Acquire any connection cable necessary to connect the external device to the system that is either not supplied with the device or not available as an option.
- Video signals containing too much jitter may cause the images on the screen to randomly wobble or wafture. In this case, a time base corrector (TBC) must be connected.
- The projector accepts video signals, S video signals, analog RGB signals (synchronous signals are TTL level), and digital signals.
- Some computer models are not compatible with the projector.
- Use a cable compensator when you connect devices to the projector using long cables. Otherwise the image may not display properly.
- Refer to “List of compatible signals” (➔ page 125) for the types of video signals that can be used with the projector.

## <S-VIDEO IN> terminal pin assignments and signal names

Pin No.	Signal name
(1)	Ground (luminance signal)
(2)	Ground (color signal)
(3)	Luminance signal
(4)	Color signal

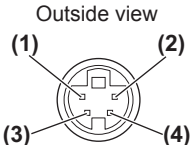

Outside view

## <RGB 2 IN> terminal pin assignments and signal names

Pin No.	Signal name
(1)	R/P <sub>R</sub>
(2)	G/Y
(3)	B/P <sub>B</sub>
(12)	DDC data
(13)	SYNC/HD
(14)	VD
(15)	DDC clock

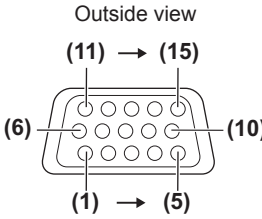

Outside view

(4) and (9) are not used.  
(5) - (8), (10), and (11) are GND terminals.

## <DVI-D IN> terminal pin assignments and signal names

Pin No.	Signal name	Pin No.	Signal name
(1)	T.M.D.S data 2-	(13)	—
(2)	T.M.D.S data 2+	(14)	+5 V
(3)	T.M.D.S data 2/4 shield	(15)	GND
(4)	—	(16)	Hot plug detection
(5)	—	(17)	T.M.D.S data 0-
(6)	DDC clock	(18)	T.M.D.S data 0+
(7)	DDC data	(19)	T.M.D.S data 0/5 shield
(8)	—	(20)	—
(9)	T.M.D.S data 1-	(21)	—
(10)	T.M.D.S data 1+	(22)	T.M.D.S clock shield
(11)	T.M.D.S data 1/3 shield	(23)	T.M.D.S clock+
(12)	—	(24)	T.M.D.S clock-

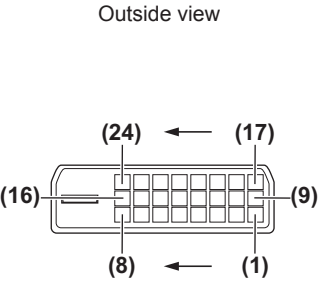

Outside view

## <HDMI IN> terminal pin assignments and signal names

Pin No.	Signal name	Pin No.	Signal name
(1)	T.M.D.S data 2+	(11)	T.M.D.S clock shield
(2)	T.M.D.S data 2 shield	(12)	T.M.D.S clock-
(3)	T.M.D.S data 2-	(13)	CEC
(4)	T.M.D.S data 1+	(14)	—
(5)	T.M.D.S data 1 shield	(15)	SCL
(6)	T.M.D.S data 1-	(16)	SDA
(7)	T.M.D.S data 0+	(17)	DDC/CEC GND
(8)	T.M.D.S data 0 shield	(18)	+5 V
(9)	T.M.D.S data 0-	(19)	Hot plug detection
(10)	T.M.D.S clock+		

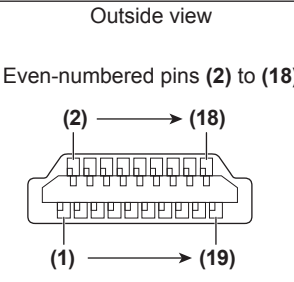

Outside view

Even-numbered pins (2) to (18)

Odd-numbered pins (1) to (19)

## Connecting example: AV equipment

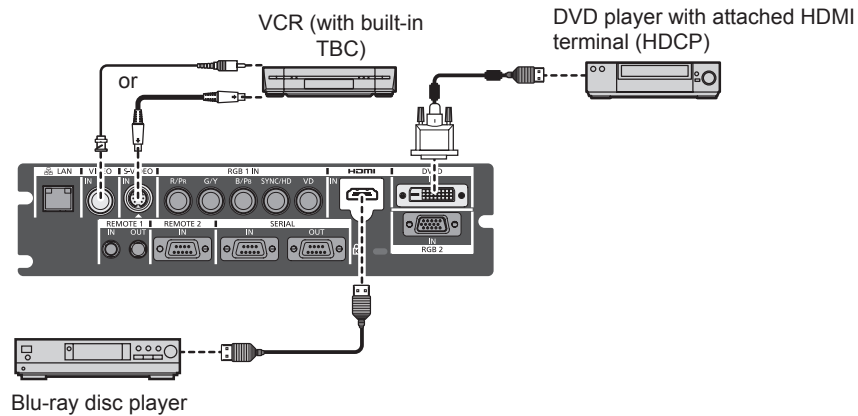

### Attention

- Always use one of the following when connecting a VCR.
  - A VCR with built-in time base corrector (TBC)
  - A time base corrector (TBC) between the projector and the VCR
- If nonstandard burst signals are connected, the image may be distorted. In such case, connect the time base corrector (TBC) between the projector and the VCR.
- Use a commercial HDMI/DVI cable with a ferrite core.

### Note

- The <DVI-D IN> terminal can be connected to HDMI- or DVI-D-compliant devices. However, images may not appear or may not be displayed properly on some devices. (➔ page 70)
- Use an HDMI cable that conforms to HDMI standards such as an HDMI High Speed cable. If a cable that does not meet HDMI standards is used, video may be interrupted or may not be displayed.
- The <HDMI IN> terminal of the projector can be connected to an external device with a DVI-D terminal by using an HDMI/DVI conversion cable, but some devices may not project the image properly or function properly.
- When the DVI-D signal is input, EDID setting may be required depending on the connected device (➔ page 70).
- The projector does not support VIERA Link (HDMI).

## Connecting example: Computers

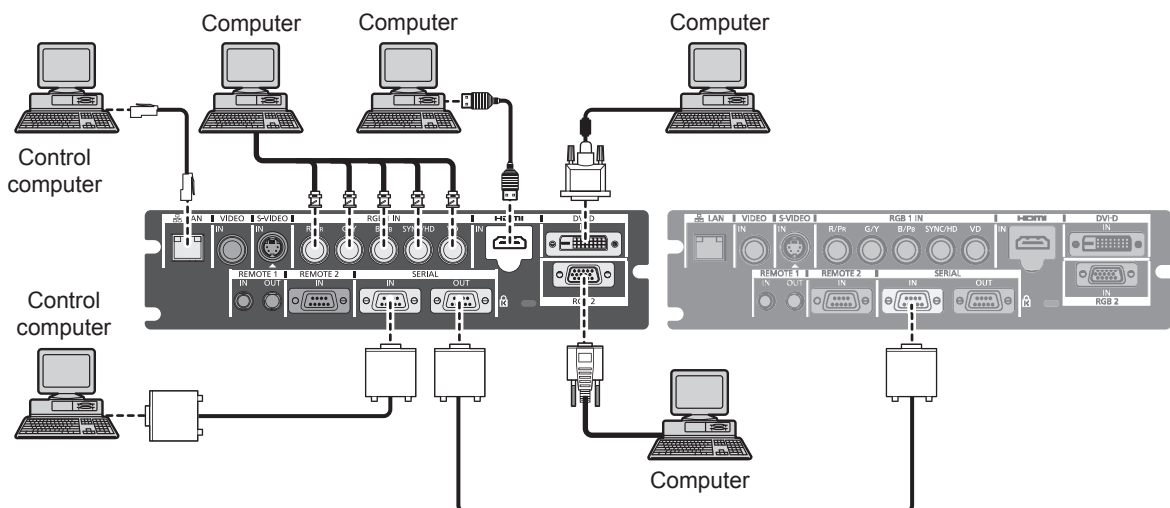

### Attention

- When connecting the projector to a computer or an external device, use the power cord supplied with each device and commercially available shielded cables.
- Use a commercial DVI-D cable with a ferrite core.

### Note

- Use an HDMI cable that conforms to HDMI standards such as an HDMI High Speed cable. If a cable that does not meet HDMI standards is used, video may be interrupted or may not be displayed.

- The <HDMI IN> terminal of the projector can be connected to an external device with a DVI-D terminal by using an HDMI/DVI conversion cable, but some devices may not project the image properly or function properly.
- The <DVI-D IN> terminal supports single link only.
- For signals that the projector can project, refer to “List of compatible signals” (➔ page 125).
- If you operate the projector using the computer with the resume feature (last memory), you may have to reset the resume feature to operate the projector.
- When the SYNC ON GREEN signal is input, do not enter sync signals to the <SYNC/HD> terminal or the <VD> terminal.
- When the DVI-D signal is input, EDID setting may be required depending on the connected device (➔ page 70).

# Chapter 3 Basic Operation

---

This chapter describes basic operations to start with.



# Switching on/off the projector

## Connecting the power cord

Make sure that the supplied power cord cover is securely fixed to the projector to prevent removal of the power cord.

Confirm that the <MAIN POWER> switch is on the <OFF> side before connecting the power cord.

For details of power cord handling, refer to “Read this first!” (➔ pages 2 to 8).

## Attaching

- 1) Check the shapes of the <AC IN> terminal and the power cord connector and insert the plug securely in the correct direction.

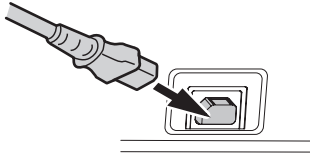

- 3) Push in the tab of the power cord secure lock until it clicks.

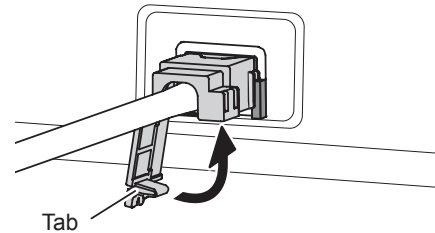

- 2) Attach the power cord secure lock along with the guide on the <AC IN> terminal.

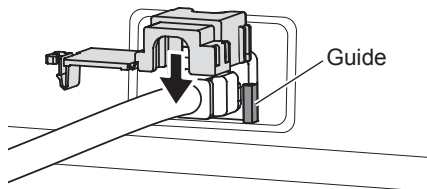

## Removing

- 1) Confirm that the <MAIN POWER> switch of the projector is at the <OFF> side, and unplug the power plug from the outlet.

- 2) Press down the tab of the power cord secure lock to remove.

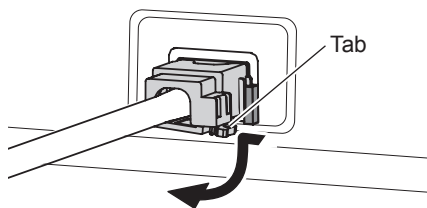

- 4) Remove the power cord connector from the projector <AC IN> terminal.

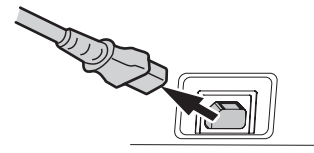

- 3) Remove the power cord secure lock from the projector in the direction of the <AC IN> terminal guide.

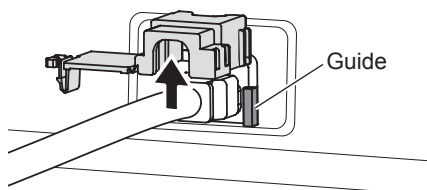

## Power indicator

Displays the status of the power. Check the <ON (G)/STANDBY (R)> status of the power indicator before operating the projector.

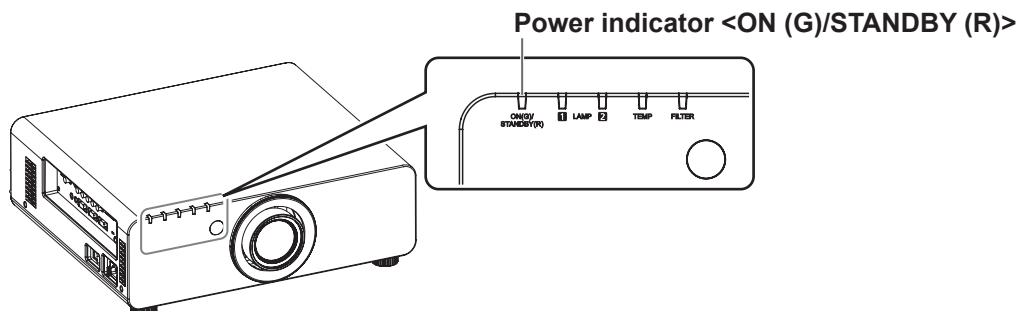

Indicator status		Status
No illumination or flashing		The main power is switched off.
Red	Lit	The power is switched off. (Standby mode.) Projection will start if the power on < > button is pressed. • The projector may not operate when the lamp indicators <LAMP1>/<LAMP2> or temperature indicator <TEMP> is flashing. (➔ page 110)
Green	Lit	Projecting.
Orange	Lit	The projector is preparing to switch off the power. The power is switched off after a while. (Changes to the standby mode.)

### Note

- When the power indicator <ON (G)/STANDBY (R)> lamp is lit in orange, the fan is turning and the projector is cooling.
- The projector consumes power even in standby mode (power indicator <ON (G)/STANDBY (R)> is lit in red). Refer to “Power consumption” (➔ page 127) for the power consumption.
- The power indicator <ON (G)/STANDBY (R)> will flash in green if a remote control signal is received.
- The power indicator <ON (G)/STANDBY (R)> will flash slowly in green while the shutter is closed. (➔ page 47)
- If the power indicator <ON (G)/STANDBY (R)> is flashing in red, consult your dealer.

## Switching on the projector

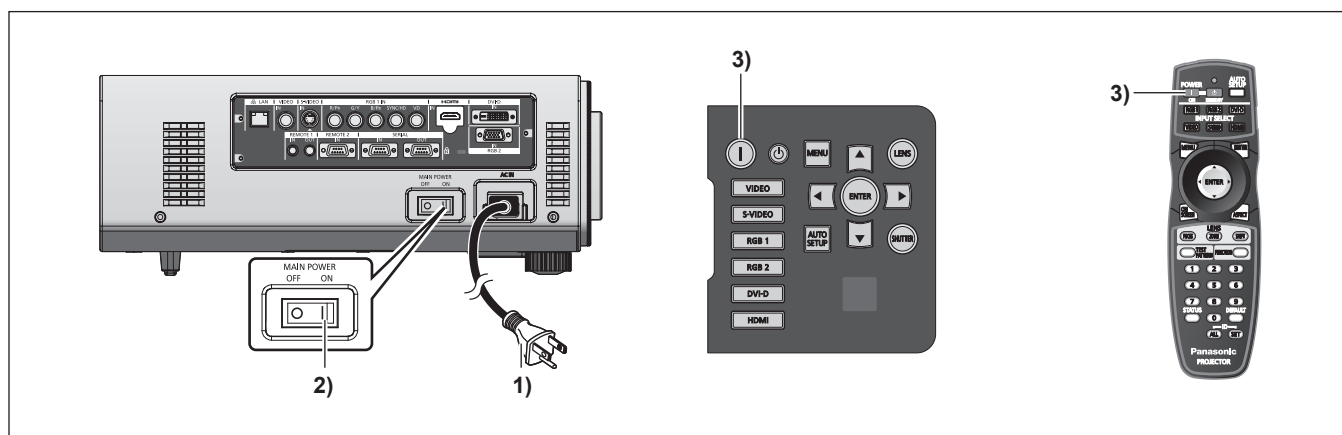

To use a projection lens that is an optional accessory, attach the lens before switching on the projector. (➔ page 35)

Remove the lens cover first.

### 1) Connect the power plug to an outlet.

- (AC 120 V 50 Hz/60 Hz)

### 2) Press the <ON> side of the <MAIN POWER> switch to turn on the power.

- The power indicator <ON (G)/STANDBY (R)> will light in red, and the projector will enter the standby mode.

### 3) Press the power on <|> button.

- The power indicator <ON (G)/STANDBY (R)> will light in green and the image will soon be projected on the screen.

### Note

- If the projector is switched on at about 0 °C (32 °F), a warm-up period of approximately five minutes may be necessary until a projection is displayed.

The temperature indicator <TEMP> is lit during the warm-up period. When the warm-up is completed, the temperature indicator <TEMP> turns off and the projection starts. Refer to “Managing the indicated problems” (➔ page 110) for the indicator status.

- If the operating environment temperature is low and warm-up takes more than 5 minutes, the projector will judge that a problem has occurred and the power will automatically be set to stand-by. If this happens, increase the operating environment temperature to 0 °C (32 °F) or higher, turn off the main power, and then turn on the power again.
- If the [PROJECTOR SETUP] menu → [STANDBY MODE] (➔ page 78) is set to [ECO], there may be a time lag of approximately 10 seconds between turning on the power and starting projection compared to when the setting is [NORMAL].
- If the <MAIN POWER> switch was turned <OFF> during projection the last time that the direct power off function was used, and the <MAIN POWER> switch is turned <ON> while the main power plug connected to the outlet, the power indicator <ON (G)/STANDBY (R)> will light in green and the image will soon be projected on the screen.

### Making adjustments and selections

It is recommended that images are projected continuously for at least 30 minutes before the focus is adjusted.

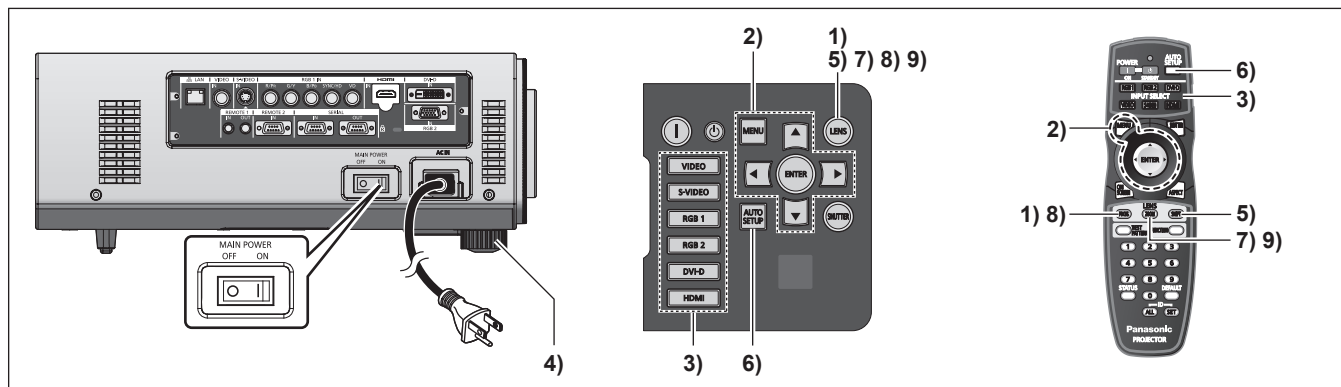

- 1) Press the <FOCUS> button to roughly adjust the focus of the image. (➔ page 45)
- 2) Set the projection method using [PROJECTION METHOD] (➔ page 75) and [COOLING CONDITION] (➔ page 76) on the menu.
  - Refer to “Navigating through the menu” (➔ page 51) for the operation of the menu.
- 3) Press the input selection (<RGB1>, <RGB2>, <DVI-D>, <VIDEO>, <S-VIDEO>, <HDMI>) buttons to select the input signal. (➔ page 48)
- 4) Adjust the front, back and sideway tilt of the projector with the adjustable feet. (➔ page 34)
- 5) Press the <SHIFT> button to adjust the position of the image. (➔ page 45)
- 6) If the input signal is an RGB input signal, press the <AUTO SETUP> button. (➔ page 48)
- 7) Press the <ZOOM> button to adjust the size of the image to match the screen. (➔ page 45)
- 8) Press the <FOCUS> button again to adjust the focus.
- 9) Press the <ZOOM> button again to adjust the zoom and the size of the image to match the screen.

### Switching off the projector

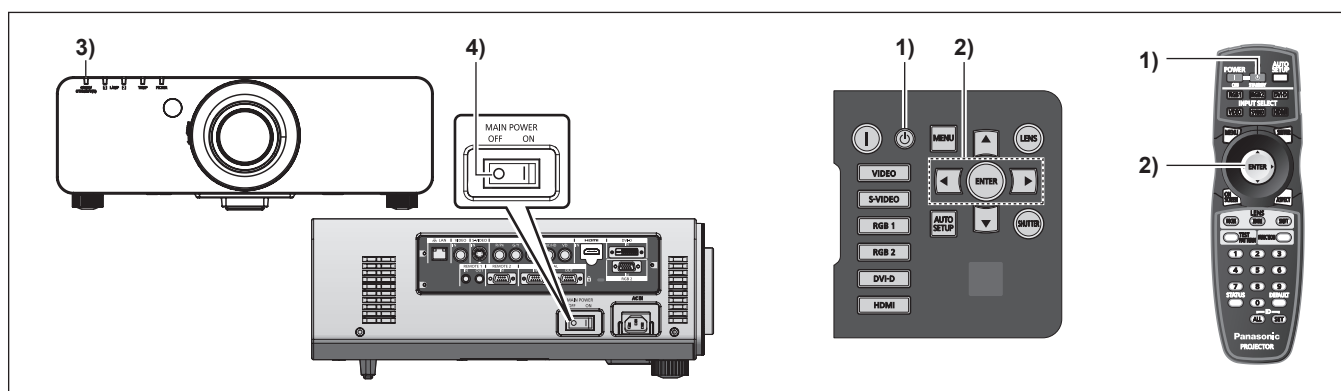

- 1) Press the power standby <⏻> button.
  - The [POWER OFF(STANDBY)] confirmation screen is displayed.
- 2) Use ◀▶ to select [OK], and press the <ENTER> button.  
(Or press the power standby <⏻> button again.)
  - Projection of the image will stop, and the power indicator <ON (G)/STANDBY (R)> on the projector lights in orange. (The fan keeps running.)

- 3) Wait until the power indicator <ON(G)/STANDBY (R)> of the projector lights in red (and the fan stops) for approximately 170 seconds.
- 4) Press the <OFF> side of the <MAIN POWER> switch to turn off the power.

---

#### Note

---

- **Do not turn on the power and project images immediately after turning the projector off.**  
Turning on the power while the lamp is still hot may shorten the lamp life.
- The lamp indicators will not light on for about 75 seconds after the projector is switched off and the luminous lamp cooling has started even if the power is switched. The indicators may not light when the power is switched on even after this time. In such a case, turn the power on again after the power indicator <ON (G)/STANDBY (R)> lights in red.
- **The projector consumes power when the main power of the projector is on, even if the power standby <⏻> button is pressed and the power is switched off.**  
When [STANDBY MODE] (➔ page 78) on the menu is set to [ECO], the power consumption during standby can be conserved.

---

#### Direct power off function

---

Even if the <MAIN POWER> switch is <OFF> during projection or immediately after the luminous lamp is turned off, the electricity stored in the room will drive the fan and cool the luminous lamp. When mounting on the ceiling or other environment where the projector <MAIN POWER> switch cannot easily be turned <OFF>, the power can be shut down directly from the power breaker. This method is safe in the event of a blackout or if the power cord is removed directly after the projector is switched off.

---

#### Note

---

- If the power was shut down directly from the power circuit breaker during projection the last time that the projector was used, the power indicator <ON (G)/STANDBY (R)> will light in green a while after the power circuit breaker is turned on and then transitions to image projection.
- It may take more time than usual to project the next time that the power is turned on if direct power off is used to cool.
- When packing for shipment or storage, ensure that the fan is stopped.

# Projecting

Check the projection lens attachment (➔ page 35), external device connection (➔ page 37) and power cord connection (➔ page 41), and then switch on the power (➔ page 42) to start projecting. Select the video for projection, and adjust appearance of the projected image.

## Selecting the input signal

Select an input signal.

- 1) Press the input selection (<RGB1>, <RGB2>, <DVI-D>, <VIDEO>, <S-VIDEO>, <HDMI>) buttons on the control panel or the remote control.

- The image of the signal being input in the selected terminal is projected.

### Attention

- Images may not be projected properly depending on the external device, or the blu-ray disc or DVD disc, to be played back. Set [PICTURE] → [SYSTEM SELECTOR] (➔ page 59) on the menu.
- Confirm the aspect ratio of the projection screen and the image, and switch to an optimum aspect ratio from [POSITION] → [ASPECT] (➔ page 60) in the menu.

## Adjusting the focus, zoom, and shift

If the projected image or the position is not correct though the positioning of the projector and the screen is correctly installed, adjust the focus, zoom, and shift.

### At the projector

- 1) Press the <LENS> button on the control panel.
  - 2) Select each item and use ▲▼◀▶ to adjust it.
- The setup screen will change each time you press the button.

### Adjustable contents

[FOCUS]	Adjusts focus.
[ZOOM]	Adjusts zoom.
[SHIFT]	Adjusts shift.

### Using the remote control

- 1) Press the lens (<FOCUS>, <ZOOM>, <SHIFT>) buttons on the remote control.
- 2) Select each item and use ▲▼◀▶ to adjust it.

### Adjustable items

Operation	Item	Details
Press the <FOCUS> button.	[FOCUS]	Adjusts focus.
Press the <ZOOM> button.	[ZOOM]	Adjusts zoom.
Press the <SHIFT> button.	[SHIFT]	Adjusts shift.

### Note

- The zoom adjustment menu is displayed even when a projection lens without zoom function is attached, but it will not operate.
- Use the fixed-focus lens (ET-DLE055) with the lens position on the home position. (➔ page 46)
- The adjustment can be performed faster by pressing and holding ▲▼◀▶ for at least three seconds.
- It is recommended that images are projected continuously for at least 30 minutes before the focus is adjusted.
- Only [FOCUS] is shown in yellow so that the displayed menu item can be recognized by color (even when the projector is not focused and displayed characters are unreadable). (Factory default)  
The [FOCUS] color depends on the [OSD DESIGN] (➔ page 72) settings in the menu.

## Moving the lens to the home position

Perform the following procedure to move the lens to the home position.

- 1) Press the <LENS> button on the control panel or the <SHIFT> button on the remote control for at least three seconds.
- 2) While the [HOME POSITION] menu is displayed (for approximately five seconds), press the <ENTER> button.



- [PROGRESS] is displayed in the menu screen, and the lens returns to the home position.

### Attention

- The home position of the lens is the lens position when the lens is being replaced or when the projector is being stored, and it is not the optical center of the screen.

## Adjustment range by the lens position shift (optical shift)

Perform the lens position shift within the adjustment range.

The focus may change when the lens position is shifted out of the adjustment range. This is because the movement of the lens is restricted to protect the optical parts. Projection position can be adjusted with the optical axis shift based on the standard projection position in the range shown in the following figures.

Lens type	Zoom lens	
	Standard zoom lens, ET-DLE150, ET-DLE250, ET-DLE350, ET-DLE450	ET-DLE080
PT-DX610U		
PT-DW640U		

\* The numerical values in the diagrams above represent a case in which the projector is set on a desk/floor.

### Note

- When the fixed-focus lens (ET-DLE055) is attached, shift adjustment cannot be performed.

# Remote control operation



## Using the shutter function

If the projector is not used for a certain period of time during the meeting intermission, for example, it is possible to turn off the image temporarily.



**button**

### 1) Press the <SHUTTER> button.

- The image disappears.
- This operation can be also performed using the <SHUTTER> button on the control panel.

### 2) Press the <SHUTTER> button again.

- The image is displayed.

#### Note

- The power indicator <ON (G)/STANDBY (R)> will flash slowly in green while the shutter is closed.

## Using the on-screen display function

Turn off the on-screen display function (no display) when you do not wish the viewers to see the on-screen display, such as the menu or the input terminal name.



**button**

### 1) Press the <ON SCREEN> button.

- The on-screen display disappears.

### 2) Press the <ON SCREEN> button again.

- The on-screen display appears.

#### Note

- If you press the <MENU> button on the control panel for at least three seconds while the on-screen indication is off, the on-screen display is turned on.

## Switching the input

The input for projection can be switched.



### 1) Press the input selection (<RGB1>, <RGB2>, <DVI-D>, <VIDEO>, <S-VIDEO>, and <HDMI>) buttons.

- This operation can be also performed by pressing the input selection (<RGB1>, <RGB2>, <DVI-D>, <VIDEO>, <S-VIDEO>, and <HDMI>) buttons on the control panel.

### ■ Switching the input items

<RGB1>	Switches to RGB1 input.
<RGB2>	Switches to RGB2 input.
<DVI-D>	Switches to DVI-D input.
<VIDEO>	Switches to VIDEO input.
<S-VIDEO>	Switches to S-VIDEO input.
<HDMI>	Switches to HDMI input.

## Using the status function

You can display the status of the projector.



### 1) Press the <STATUS> button.

- The [STATUS] screen is displayed.

STATUS		1/4
INPUT	RGB2	
SIGNAL NAME	SXGA60+-A1	
SIGNAL FREQUENCY	65.22kHz/59.99Hz	
PROJECTOR RUNTIME	1h	
LAMP1	11h / ON /	
LAMP2	1h / ON /	
INTAKE AIR TEMP.	31°C / 87° F	
OPTICS MODULE TEMP.	27°C / 80° F	
AROUND LAMP TEMP.	31°C / 87° F	

### Note

- This can also be displayed from the [PROJECTOR SETUP] menu → [STATUS] (➔ page 81).

## Using the automatic setup function

The automatic setup function can be used to automatically adjust the resolution, clock phase, and picture position when analog RGB signals consisting of bitmap images such as computer signals are being input, or to automatically adjust the picture position when DVI-D/HDMI signals are input. Supplying images with bright white borders at the edges and high-contrast black and white characters is recommended when the system is in automatic adjustment mode.

Avoid supplying images that include halftones or gradation, such as photographs and computer graphics.





### 1) Press the <AUTO SETUP> button.

- [COMPLETE] is displayed when it has completed without any problem.
- This operation can be also performed using the <AUTO SETUP> button on the control panel.

#### Note

- The CLOCK PHASE may shift even if it has completed without any incident. In such cases, adjust with the [POSITION] menu → [CLOCK PHASE] (➔ page 62).
- If an image with blurred edges or a dark image is input, [INCOMPLETE] may appear or adjustment may not be performed properly even if [COMPLETE] appears. In this case, adjust the settings in [ADVANCED MENU] → [INPUT RESOLUTION] (➔ page 65), [POSITION] → [CLOCK PHASE] (➔ page 62), [SHIFT] (➔ page 60) in the menu.
- Adjust special signals according to the [DISPLAY OPTION] → [AUTO SETUP] (➔ page 70) in the menu.
- Automatic adjustment may not work depending on the model of the computer.
- Automatic adjustment may not work for a synchronization signal of C-SY or SYNC ON GREEN.
- Images may be disrupted for a few seconds during automatic adjustment, but it is not a malfunction.
- Adjustment is required for each input signal.
- Automatic adjustment can be canceled by pressing the <MENU> button during the automatic adjustment operation.
- If automatic setup function is performed while moving images are being input, the adjustment may not be performed properly even for an RGB signal for which automatic setup can be used. [INCOMPLETE] may appear, or adjustment may not be finished properly even if [COMPLETE] appears.

### Using the function button

[DISABLE], [SUB MEMORY], [SYSTEM SELECTOR], [SYSTEM DAYLIGHT VIEW], [FREEZE], or [SIDE BY SIDE] operations can be assigned to the <FUNCTION> button on the remote control so that it can be used as an easy shortcut button.

#### FUNCTION button

### 1) Press the <FUNCTION> button.

#### Note

- [SIDE BY SIDE] can be set only with PT-DW640U.
- The [PROJECTOR SETUP] → [FUNCTION BUTTON] (➔ page 82) in the menu performs function assignment.

### Displaying the internal test pattern

The projector has nine types of internal test patterns to check the condition of the set. To display test patterns, perform the following steps.

#### TEST PATTERN button

### 1) Press the <TEST PATTERN> button.

### 2) Use ◀▶ to select a test pattern.

#### Note

- You can also use [TEST PATTERN] (➔ page 85) in the menu to perform settings.
- Settings of position, size, and other factors will not be reflected in test patterns. Make sure to display the input signal before performing various adjustments.

### Changing the picture aspect ratio

You can toggle through aspect ratios to select the one that is appropriate for the input signal.

#### ASPECT button

### 1) Press the <ASPECT> button.

- The setting will change each time you press the button. Refer to “[ASPECT]” (➔ page 60) for details.

# Chapter 4 Settings

---

This chapter describes the settings and adjustments you can make using the on-screen menu.

# Menu navigation

The on-screen menu (Menu) is used to perform various settings and adjustments of the projector.

## Navigating through the menu

### Operating procedure



button

#### 1) Press the <MENU> button on the remote control or the control panel.

- The [MAIN MENU] screen is displayed.

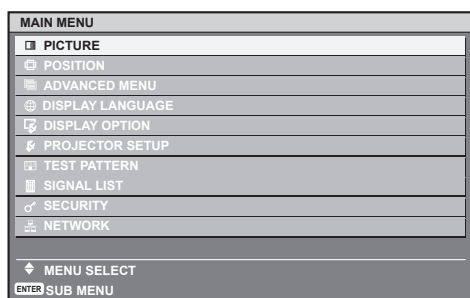

#### 2) Press ▲▼ to select an item from the main menu.

- The selected item is highlighted in yellow.

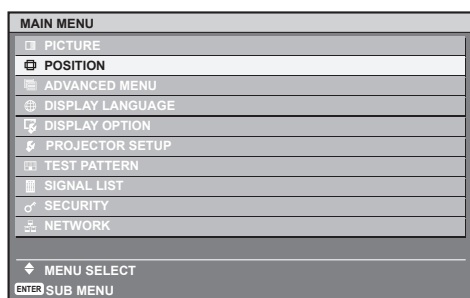

#### 3) Press the <ENTER> button.

- The sub-menu items of the selected main menu are displayed.

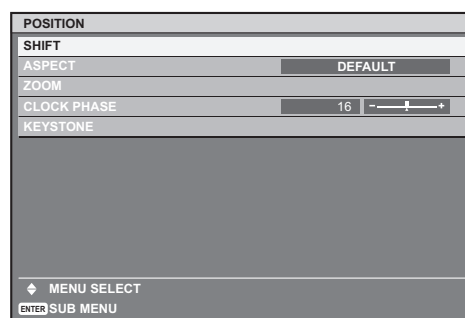

#### 4) Press ▲▼ to select a sub-menu, and press ◀▶ or the <ENTER> button to change or adjust settings.

- For some items, press ◀▶ to display an individual adjustment screen with a bar scale as shown in the following diagram.



### Note

- Pressing the <MENU> button when the menu screen is displayed returns to the previous menu.
- Some items may not be adjusted or used for certain signal formats to be input to the projector. The menu items that cannot be adjusted or used are shown in black characters, and they cannot be selected.
- Some items can be adjusted even if signals are not input.
- Individual adjustment screen is cleared automatically if no operation is performed for approximately five seconds.
- For menu items, refer to "Main menu" (➔ page 52) and "Sub-menu" (➔ pages 52 to 54).
- The cursor color depends on the [OSD DESIGN] (➔ page 72) settings on the menu. The selected item is displayed with the yellow cursor by default.

### To reset to the factory default

If the <DEFAULT> button on the remote control is pressed, the values adjusted in the menu items will be restored to the factory default settings.

DEFAULT



button

## 1) Press the <DEFAULT> button on the remote control.



### Note



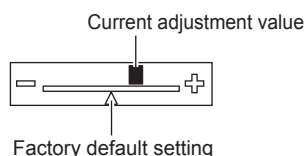







- You cannot reset all the settings to the factory default at once.
- To reset all the settings adjusted in the sub-menu item to the factory default at a time, perform initialization from the [PROJECTOR SETUP] menu → [INITIALIZE] (➔ page 84).
- Some menu items cannot be reset by pressing the <DEFAULT> button. Adjust each item manually.
- The triangular mark under the bar scale in the individual adjustment screen indicates the factory default setting. The position of the triangular mark varies by the selected input signals.



## Main menu

The following 10 items are in the main menu.

When a main menu item is selected, the screen changes to a sub-menu selection screen.

Main menu item		Page
	[PICTURE]	52
	[POSITION]	53
	[ADVANCED MENU]	53
	[DISPLAY LANGUAGE]	53
	[DISPLAY OPTION]	53
	[PROJECTOR SETUP]	54
	[TEST PATTERN]	54
	[SIGNAL LIST]	54
	[SECURITY]	54
	[NETWORK]	54

## Sub-menu

The sub-menu of the selected main menu item is displayed, and you can set and adjust items in the sub-menu.

### [PICTURE]

Sub-menu item	Factory default	Page
[PICTURE MODE]	[STANDARD]*	55
[CONTRAST]	[0]	55
[BRIGHTNESS]	[0]	55
[COLOR]	[0]	56
[TINT]	[0]	56
[COLOR TEMPERATURE]	[DEFAULT]	56
[WHITE GAIN]	[10]	57

Sub-menu item	Factory default	Page
[SYSTEM DAYLIGHT VIEW]	[OFF]*	57
[SHARPNESS]	[6]	58
[NOISE REDUCTION]	[1]*	58
[AI]	[ON]	58
[SYSTEM SELECTOR]	[YPbPr]*	59

\* Depends on the signal input.

### Note

- The factory default settings may vary depending on the picture mode.

## [POSITION]

Sub-menu item	Factory default	Page
[SHIFT]	—	60
[ASPECT]	[DEFAULT]*	60
[ZOOM]	—	61
[CLOCK PHASE]	[16]	62
[KEYSTONE]	—	63

\* Depends on the signal input.

## [ADVANCED MENU]

Sub-menu item	Factory default	Page
[DIGITAL CINEMA REALITY]	[AUTO]*	64
[BLANKING]	—	64
[INPUT RESOLUTION]	—	65
[CLAMP POSITION]	[24]*	65
[EDGE BLENDING]	[OFF]	65
[RASTER POSITION]	—	66

\* Depends on the signal input.

## [DISPLAY LANGUAGE]

Details (➔ page 67)

## [DISPLAY OPTION]

Sub-menu item	Factory default	Page
[COLOR MATCHING]	[OFF]	68
[COLOR CORRECTION]	[OFF]	69
[CONTRAST MODE]	[NORMAL]	69
[SCREEN SETTING]	—	69
[AUTO SIGNAL]	[OFF]	70
[AUTO SETUP]	—	70
[RGB IN]	—	70
[DVI-D IN]	—	70
[HDMI IN]	—	71
[ON-SCREEN DISPLAY]	—	71
[BACK COLOR]	[BLUE]	72
[STARTUP LOGO]	[DEFAULT LOGO]	72
[SHUTTER SETTING]	—	73
[FREEZE]	—	73
[SIDE BY SIDE]*	—	73
[CUT OFF]	—	74

\* Only for PT-DW640U.

**[PROJECTOR SETUP]** 

Sub-menu item	Factory default	Page
[PROJECTOR ID]	[ALL]	75
[PROJECTION METHOD]	[FRONT/FLOOR]	75
[COOLING CONDITION]	[FLOOR SETTING]	76
[HIGH ALTITUDE MODE]	[OFF]	76
[LAMP SELECT]	[DUAL]	76
[LAMP RELAY]	[OFF]	77
[LAMP POWER]	[NORMAL]	77
[STANDBY MODE]	[NORMAL]	78
[SCHEDULE]	[OFF]	78
[STARTUP INPUT SELECT]	[LAST USED]	79
[RS-232C]	—	80
[REMOTE2 MODE]	[DEFAULT]	81
[STATUS]	—	81
[NO SIGNAL SHUT-OFF]	[DISABLE]	82
[FUNCTION BUTTON]	—	82
[DATE AND TIME]	—	83
[SAVE ALL USER DATA]	—	83
[LOAD ALL USER DATA]	—	84
[INITIALIZE]	—	84
[SERVICE PASSWORD]	—	84

**[TEST PATTERN]** 

Details (➔ page 85)

**[SIGNAL LIST]** 

Details (➔ page 86)

**[SECURITY]** 

Sub-menu item	Factory default	Page
[SECURITY PASSWORD]	[OFF]	89
[SECURITY PASSWORD CHANGE]	—	89
[DISPLAY SETTING]	[OFF]	89
[TEXT CHANGE]	—	90
[MENU LOCK]	[OFF]	90
[MENU LOCK PASSWORD]	—	90
[CONTROL DEVICE SETUP]	—	90

**[NETWORK]** 

Sub-menu item	Factory default	Page
[NETWORK SETUP]	—	92
[NETWORK CONTROL]	—	92
[NETWORK STATUS]	—	93

**Note**

- Some items may not be adjusted or used for certain signal formats to be input to the projector.  
The menu items that cannot be adjusted or used are shown in black characters, and they cannot be selected.
- Sub-menu items and factory default settings differ depending on the selected input terminal.

## [PICTURE] menu

Select [PICTURE] from the main menu, and select the item from the sub-menu.  
Refer to “Navigating through the menu” (➔ page 51) for the operation of the menu screen.

- After selecting the item, press ▲▼◀▶ to adjust.

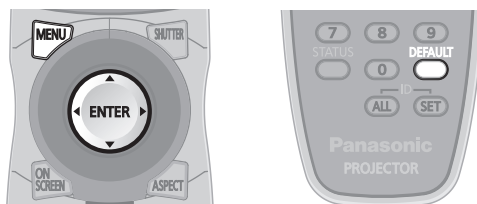

### [PICTURE MODE]

You can switch to the desired picture mode suitable for the image source and the environment in which the projector is used.

- Press ▲▼ to select [PICTURE MODE].
- Press ◀▶ or the <ENTER> button.
  - The [PICTURE MODE] individual adjustment screen is displayed.
- Press ▶◀ to switch [PICTURE MODE].
  - The setting will change among [STANDARD], [CINEMA], [NATURAL], [REC709], [DICOM SIM.], [DYNAMIC] and [GRAPHIC] each time you press the button.

#### ■ [PICTURE MODE]

[STANDARD]	The picture becomes suitable for moving images in general.
[CINEMA]	The picture becomes suitable for movie sources.
[NATURAL]	The picture is sRGB compliant.
[REC709]*	The picture is REC709 compliant.
[DICOM SIM.]*	The picture becomes similar to that of DICOM Part14 Grayscale Standard.
[DYNAMIC]	The light output is maximized for use in bright areas.
[GRAPHIC]	The picture becomes suitable for input to the personal computer.

\* Use the factory default for the settings other than [PICTURE MODE].

#### Note

- The factory default picture mode is [GRAPHIC] for still image input signals and [STANDARD] for movie based input signals.
- DICOM is an abbreviation for “Digital Imaging and Communication in Medicine” and is a standard for medical imaging devices. Although the DICOM name is used, the projector is not a medical device, and should not be used for purposes such as diagnosis of display images.

### [CONTRAST]

You can adjust the contrast of the colors.

- Press ▲▼ to select [CONTRAST].
- Press ▶◀ or the <ENTER> button.
  - The [CONTRAST] individual adjustment screen is displayed.
- Press ◀▶ to adjust the level.

#### ■ Operations and adjustment range

Operation	Adjustment	Range
Press ▶.	Brightens the screen and makes the color of image deeper.	-31 - +31
Press ◀.	Darkens the screen and makes the color of image lighter.	

#### Attention

- Adjust [BRIGHTNESS] first when you need to adjust the black level.

### [BRIGHTNESS]

You can adjust the dark (black) part of the projected image.

- Press ▲▼ to select [BRIGHTNESS].
- Press ▶◀ or the <ENTER> button.
  - The [BRIGHTNESS] individual adjustment screen is displayed.

3) Press ◀▶ to adjust the level.

### ■ Operations and adjustment range

Operation	Adjustment	Range
Press ▶.	Increases the brightness of the dark (black) parts of the screen.	-31 - +31
Press ◀.	Reduces the brightness of the dark (black) parts of the screen.	

## [COLOR]

You can adjust the color saturation of the projected image.

1) Press ▲▼ to select [COLOR].

2) Press ◀▶ or the <ENTER> button.

- The [COLOR] individual adjustment screen is displayed.

3) Press ◀▶ to adjust the level.

### ■ Operations and adjustment range

Operation	Adjustment	Range
Press ▶.	Deepens colors.	-31 - +31
Press ◀.	Weakens colors.	

## [TINT]

You can adjust the skin tone in the projected image.

1) Press ▲▼ to select [TINT].

2) Press ◀▶ or the <ENTER> button.

- The [TINT] individual adjustment screen is displayed.

3) Press ◀▶ to adjust the level.

### ■ Operations and adjustment range

Operation	Adjustment	Range
Press ▶.	Adjusts skin tone toward greenish color.	-31 - +31
Press ◀.	Adjusts skin tone toward reddish purple.	

## [COLOR TEMPERATURE]

You can switch the color temperature if the white areas of the projected image are bluish or reddish.

### To adjust with color temperature

1) Press ▲▼ to select [COLOR TEMPERATURE].

3) Press ◀▶ to switch [COLOR TEMPERATURE].

2) Press ◀▶ or the <ENTER> button.

- The [COLOR TEMPERATURE] individual adjustment screen is displayed.

- The setting will change among [DEFAULT], [USER], [MIDDLE] and [HIGH] each time you press the button.
- When [COLOR MATCHING] (➔ page 68) adjustment is set to other than [OFF], [COLOR TEMPERATURE] is fixed to [USER].

### ■ [COLOR TEMPERATURE]

[DEFAULT]	Factory default setting.
[USER]	Adjusts white balance as desired. Refer to "To adjust desired white balance" for details.
[MIDDLE]	Select so that images become natural.
[HIGH]	

### To adjust desired white balance

1) Press ▲▼ to select [COLOR TEMPERATURE].

3) Press ◀▶ to select [USER].

2) Press ◀▶ or the <ENTER> button.

4) Press the <ENTER> button.

- The [COLOR TEMPERATURE] individual adjustment screen is displayed.

- The [COLOR TEMPERATURE] screen is displayed.

5) Press ▲▼ to select [WHITE BALANCE].



- 6) Press the <ENTER> button.
  - The [WHITE BALANCE] screen is displayed.
- 7) Press ▲▼ to select [WHITE BALANCE HIGH] or [WHITE BALANCE LOW].
- 8) Press the <ENTER> button.
  - The [WHITE BALANCE HIGH] screen or the [WHITE BALANCE LOW] screen is displayed.
- 9) Press ▲▼ to select [RED], [GREEN], or [BLUE].
- 10) Press ◀▶ to adjust the level.

### ■ Adjustment details

Item	Operation	Adjustment	Range
[RED]	Press ▶.	Deepens red.	[WHITE BALANCE HIGH]: 0 - +255 (factory default is +255) [WHITE BALANCE LOW]: 0 - +63 (factory default is +32)
	Press ◀.	Weakens red.	
[GREEN]	Press ▶.	Deepens green.	
	Press ◀.	Weakens green.	
[BLUE]	Press ▶.	Deepens blue.	
	Press ◀.	Weakens blue.	

### Note

- Adjust [COLOR TEMPERATURE] correctly. All colors will not be displayed properly unless adequate adjustment is made. If the adjustment does not look suitable, you can press the <DEFAULT> button on the remote control to return the setting for the selected item only to the factory default setting.
- The setting of [COLOR TEMPERATURE] is not reflected in internal test patterns (➔ page 85). Make sure to set [COLOR TEMPERATURE] while projecting input signal.

### To change the [USER] name

Select the language to show on the screen. (➔ page 67)

- 1) Press ▲▼ to select [COLOR TEMPERATURE].
- 2) Press ◀▶ or the <ENTER> button.
  - The [COLOR TEMPERATURE] individual adjustment screen is displayed.
- 3) Press ◀▶ to select [USER].
- 4) Press the <ENTER> button.
  - The [COLOR TEMPERATURE] screen is displayed.
- 5) Press ▲▼ to select [COLOR TEMPERATURE NAME CHANGE].
- 6) Press the <ENTER> button.
  - The [COLOR TEMPERATURE NAME CHANGE] screen is displayed.
- 7) Press ▲▼◀▶ to select the text, and press the <ENTER> button to enter the text.
- 8) Press ▲▼◀▶ to select [OK], and press the <ENTER> button.
  - The name set to color temperature is changed.

### Note

- When a name is changed, display of [USER] on the menu is also changed.

### [WHITE GAIN]

You can adjust the brightness of white areas of the image.

- 1) Press ▲▼ to select [WHITE GAIN].
- 2) Press ◀▶ or the <ENTER> button.
  - The [WHITE GAIN] individual adjustment screen is displayed.
- 3) Press ◀▶ to adjust the level.

### ■ Operations and adjustment range

Operation	Adjustment	Range
Press ▶.	Increases the luminance of white.	0 - +10
Press ◀.	Image becomes more natural.	

### [SYSTEM DAYLIGHT VIEW]

You can correct the image to the optimal vividness even if it is projected under a bright light.

- 1) Press ▲▼ to select [SYSTEM DAYLIGHT VIEW].

**2) Press ◀▶ or the <ENTER> button.**

- The [SYSTEM DAYLIGHT VIEW] individual adjustment screen is displayed.

**3) Press ◀▶ to switch [SYSTEM DAYLIGHT VIEW].**

- The setting will change among [OFF], [1], [2] and [3] each time you press the button.

■ [SYSTEM DAYLIGHT VIEW]

[OFF]	No correction.
[1]	Corrects the image to weaken vividness.
[2]	Corrects the image to medium vividness.
[3]	Corrects the image to high vividness.

**[SHARPNESS]**

You can adjust the sharpness of the projected image.

**1) Press ▲▼ to select [SHARPNESS].**

**2) Press ◀▶ or the <ENTER> button.**

- The [SHARPNESS] individual adjustment screen is displayed.

**3) Press ◀▶ to adjust the level.**

■ Operations and adjustment range

Operation	Adjustment	Range
Press ▶.	Contours become sharper.	0 - +15
Press ◀.	Contours become softer.	

**Note**

- If you press ▶ while the adjustment value is [+15], the value will become [0]. If you press ◀ while the adjustment value is [0], the value will become [+15].

**[NOISE REDUCTION]**

You can reduce noises when the input image is degraded and noise is occurring in the image signal.

**1) Press ▲▼ to select [NOISE REDUCTION].**

**3) Press ◀▶ to switch [NOISE REDUCTION].**

**2) Press ◀▶ or the <ENTER> button.**

- The [NOISE REDUCTION] individual adjustment screen is displayed.

- The setting will change among [1], [2], [3] and [OFF] each time you press the button.

■ [NOISE REDUCTION]

[1]	Corrects the noise to low level.
[2]	Corrects the noise to medium level.
[3]	Corrects the noise to high level.
[OFF]	No correction.

**Attention**

- When this is set for an input signal with less noise, the image may look different from what it originally was. In such case, set it to [OFF].

**[AI]**

You can perform gradation control appropriate for an image to project it with optimal contrast.

**1) Press ▲▼ to select [AI].**

**3) Press ◀▶ to switch [AI].**

**2) Press ◀▶ or the <ENTER> button.**

- The [AI] individual adjustment screen is displayed.

- The setting will change between [ON] and [OFF] each time you press the button.

■ [AI]

[ON]	Enables AI correction.
[OFF]	Disables AI correction.

**[SYSTEM SELECTOR]**

The projector will automatically detect the input signal, but you can set the system method manually when an unstable signal is input. Set the system method matching the input signal.

- 1) Press ▲▼ to select [SYSTEM SELECTOR].
- 2) Press the <ENTER> button.
- 3) Press ▲▼ to select a system format.
- 4) Press the <ENTER> button.

**■ Available system formats**

Terminals	System format	
<VIDEO IN> terminal, <S-VIDEO IN> terminal	Select [AUTO], [NTSC], [NTSC4.43], [PAL], [PAL-M], [PAL-N], [SECAM], or [PAL60]. Set it to [AUTO] normally. (Setting [AUTO] will automatically select [NTSC], [NTSC4.43], [PAL], [PAL-M], [PAL-N], [SECAM], or [PAL60].) Switch the setting to the signal method for the TV used. NTSC signal method is used in Japan.	
<RGB 1 IN> terminal, <RGB 2 IN> terminal	<b>480i, 576i, or 576p signal</b>	Select [RGB] or [YCbCr].
	<b>VGA60 or 480p signal</b>	Select [VGA60], [480p], or [480pRGB].
	<b>Other movie based signals</b>	Select [RGB] or [YPbPr].
<DVI-D IN> terminal	<b>480p or 576p signal</b>	Select [RGB] or [YCbCr].
	<b>Other movie based signals</b>	Select [RGB] or [YPbPr].
<HDMI IN> terminal	<b>480p or 576p signal</b>	Select [AUTO], [RGB], or [YCbCr].
	<b>Other movie based signals</b>	Select [AUTO], [RGB], or [YPbPr].

**Note**

- Refer to “List of compatible signals” (➔ page 125) for compatible signals.
- This may not function properly for some external devices that are connected.

## [POSITION] menu

Select [POSITION] from the main menu, and select the item from the sub-menu.  
Refer to “Navigating through the menu” (➔ page 51) for the operation of the menu screen.

- After selecting the item, press ▲▼◀▶ to adjust.

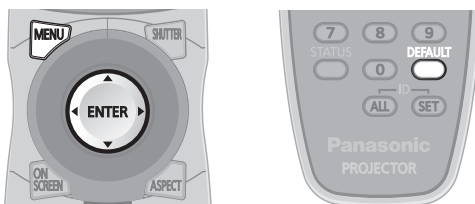

### [SHIFT]

You can move the image position vertically or horizontally if the image position projected on the screen is shifted even when the relative position of the projector and the screen is installed correctly.

- Press ▲▼ to select [SHIFT].
- Press the <ENTER> button.
  - The [SHIFT] screen is displayed.
- Press ▲▼◀▶ to adjust the position.

#### ■ Adjustment details

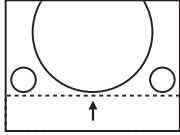
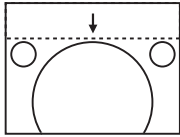
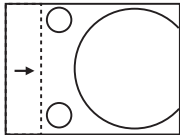
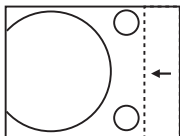
Orientation	Operation	Adjustment	
Vertical (up and down) adjustment	Press ▲.	The picture position moves up.	
	Press ▼.	The picture position moves down.	
Horizontal (right and left) adjustment	Press ▶.	The picture position moves to the right.	
	Press ◀.	The picture position moves to the left.	

### [ASPECT]

You can switch the aspect ratio of the image.

The aspect ratio is switched within the screen range selected in [SCREEN SETTING]. Set [SCREEN SETTING] first. (➔ page 69)

- Press ▲▼ to select [ASPECT].
- Press ◀▶ or the <ENTER> button.
  - The [ASPECT] individual adjustment screen is displayed.
- Press ◀▶ to switch [ASPECT].
  - The setting will change among [DEFAULT]<sup>\*1</sup>, [VID AUTO]<sup>\*2</sup>, [AUTO]<sup>\*3</sup>, [S1 AUTO]<sup>\*4</sup>, [VID AUTO(PRI.)]<sup>\*5</sup>, [THROUGH], [16:9], [4:3], [H FIT], [V FIT], and [HV FIT] each time you press the button.
  - \*1 Not during VIDEO/S-VIDEO (NTSC)/RGB (480i, 480p) signal input
  - \*2 Only during VIDEO/S-VIDEO (NTSC) signal input
  - \*3 Only during RGB (480i, 480p) signal input
  - \*4 Only during S-VIDEO (NTSC) signal input
  - \*5 This is the factory default setting during S-VIDEO (NTSC) input. The settings will rotate from [VID AUTO(PRI.)].

## ■ [ASPECT]

[DEFAULT]	Pictures are displayed without changing the aspect ratio of the input signals.
[VID AUTO]	The projector identifies the video ID (VID) embedded in the image signals and displays the image by automatically switching the screen sizes between 4:3 and 16:9. This function is effective for VIDEO/S-VIDEO (NTSC) signals.
[S1 AUTO]	The projector identifies the S1 signal, and displays the image by automatically switching the screen sizes between 4:3 and 16:9. This function is effective for S-VIDEO (NTSC) signals.
[VID AUTO(PRI.)]	The projector identifies the video ID (VID) embedded in image signals and S1 signals, and displays the image by automatically switching the screen sizes between 4:3 and 16:9 in accordance with VID if it detects VID, or S1 signal if it does not detect VID. This function is effective for S-VIDEO (NTSC) signals.
[AUTO]	The projector identifies the video ID (VID) embedded in the image signals and displays the image by automatically switching the screen sizes between 4:3 and 16:9. This function is effective for 480i/480p signals.
[THROUGH]	Pictures are displayed without changing the resolution of the input signals.
[16:9]	When standard signals <sup>*1</sup> are input, the pictures are displayed with the aspect ratio converted to 16:9. When wide-screen signals <sup>*2</sup> are input, the pictures are displayed without changing the aspect ratio.
[4:3]	When standard signals <sup>*1</sup> are input, the pictures are displayed without changing the aspect ratio. When wide-screen signals <sup>*2</sup> are input, if [4:3] is selected with [SCREEN FORMAT], the pictures are displayed with the aspect ratio converted to 4:3. When [SCREEN FORMAT] is other than [4:3], the picture size is reduced without changing the aspect ratio so that the pictures will fit in the 4:3 screen.
[H FIT]	The pictures are displayed using the entire width of the screen range selected with [SCREEN FORMAT]. When signals have the aspect ratio vertically longer than the aspect ratio of the screen selected with [SCREEN FORMAT], the pictures are displayed with the top and bottom parts cut off.
[V FIT]	The pictures are displayed using the entire height of the screen range selected with [SCREEN FORMAT]. When signals have the aspect ratio horizontally longer than the aspect ratio of the screen selected with [SCREEN FORMAT], the pictures are displayed with the right and left parts cut off.
[HV FIT]	The pictures are displayed in the entire screen range selected with [SCREEN FORMAT]. When the aspect ratio of the input signals differs from that of the screen range, the pictures are displayed with the aspect ratio converted to that of the screen selected with [SCREEN FORMAT].

\*1 Standard signals are input signals with an aspect ratio of 4:3 or 5:4.

\*2 Wide-screen signals are input signals with an aspect ratio of 16:10, 16:9, 15:9 or 15:10.

### Note

- Some size modes are not available for certain types of input signals. [DEFAULT] cannot be selected for NTSC signals.
- If an aspect ratio which is different from the aspect ratio for the input signals is selected, the pictures will appear differently from the originals. Be careful of this when selecting the aspect ratio.
- If using this projector in places such as cafes or hotels to display programs for a commercial purpose or for public presentation, note that adjusting the aspect ratio or using the zoom function to change the screen pictures may be an infringement of the rights of the original copyright owner for that program under copyright protection laws. Take care when using a function of the projector such as the aspect ratio adjustment and zoom function.
- If conventional (normal) 4:3 pictures which are not wide-screen pictures are displayed on a wide screen, the edges of the pictures may not be visible or they may become distorted. Such pictures should be viewed with an aspect ratio of 4:3 in the original format intended by the creator of the pictures.

## [ZOOM]

You can adjust the size of the projected image.

### When [ASPECT] is set to other than [DEFAULT] or [THROUGH]

- 1) Press ▲▼ to select [ZOOM].
- 2) Press the <ENTER> button.
  - The [ZOOM] screen is displayed.
- 3) Press ▲▼ to select [INTERLOCKED].
- 4) Press ◀▶ to switch [INTERLOCKED].
- 5) Press ▲▼ to select [VERTICAL] or [HORIZONTAL].
  - Select [BOTH] when [ON] is selected.
- 6) Press ◀▶ to adjust.

## ■ [INTERLOCKED]

[OFF]	[VERTICAL]	Set the [VERTICAL] and [HORIZONTAL] zoom ratio.
	[HORIZONTAL]	
[ON]	[BOTH]	Use [BOTH] to set zoom ratio. Horizontal and vertical can be expanded by units of 1.0 time.

**Note**

- When [ASPECT] is set to [THROUGH], [ZOOM] is not displayed.

**When [ASPECT] is set to [DEFAULT]**

- 1) Press ▲▼ to select [ZOOM].
- 2) Press the <ENTER> button.
  - The [ZOOM] screen is displayed.
- 3) Press ▲▼ to select [MODE].
- 4) Press ◀▶ to switch [MODE].
- 5) Press ▲▼ to select [INTERLOCKED].
- 6) Press ◀▶ to switch [INTERLOCKED].
- 7) Press ▲▼ to select [VERTICAL] or [HORIZONTAL].
  - Select [BOTH] when [ON] is selected.
- 8) Press ◀▶ to adjust.

**■ [MODE]**

[INTERNAL]	Enlarges the size within the aspect range set with [SCREEN FORMAT].
[FULL]	Enlarges the size to the entire display area set with [SCREEN FORMAT].

**■ [INTERLOCKED]**

[OFF]	[VERTICAL]	Set the [VERTICAL] and [HORIZONTAL] zoom ratio.
	[HORIZONTAL]	
[ON]	[BOTH]	Use [BOTH] to set zoom ratio. Horizontal and vertical can be expanded by units of 1.0 time.

**Note**

- When [ASPECT] is set to other than [DEFAULT], [MODE] is not displayed.

**[CLOCK PHASE]**

You can adjust to achieve an optimal image when there is a flickering image or smeared outlines.

- 1) Press ▲▼ to select [CLOCK PHASE].
- 2) Press ◀▶ or the <ENTER> button.
  - The [CLOCK PHASE] individual adjustment screen is displayed.
- 3) Press ◀▶ to adjust.
  - Adjustment value will change between 0 and +31. Adjust so that the amount of interference is at a minimum.

**Note**

- Optimal value may not be achieved if the output from the input computer is unstable.
- Optimal value may not be achieved when there is a shift in the total dot numbers.
- [CLOCK PHASE] can be adjusted only when a signal is input to the <RGB 1 IN> terminal or the <RGB 2 IN> terminal.
- [CLOCK PHASE] cannot be adjusted when a digital signal is input.
- If you press ▶ while the adjustment value is [+31], the value will become [0]. If you press ◀ while the adjustment value is [0], the value will become [+31].

**[KEYSTONE]**

You can correct the trapezoidal distortion that occurs when the projector is installed tilted or when the screen is tilted.

- 1) Press ▲▼ to select [KEYSTONE].
- 2) Press the <ENTER> button.
  - The [KEYSTONE] screen is displayed.
- 3) Press ▲▼ to select the item to adjust.
- 4) Press ◀▶ to adjust.

**■ Adjustment details**

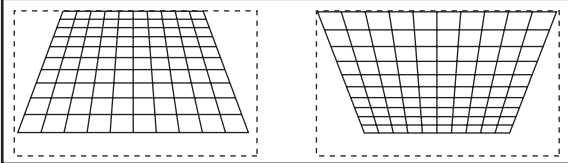
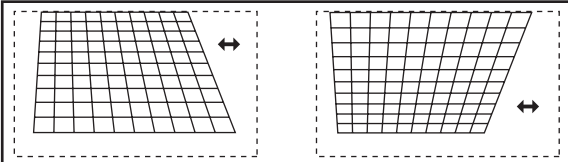
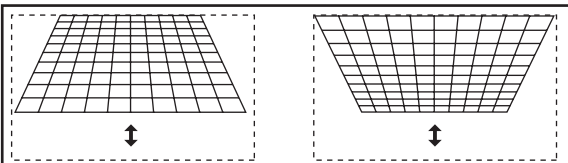
<b>[KEYSTONE]</b>	
<b>[SUB KEYSTONE]</b>	
<b>[LINEARITY]</b>	

**Note**

- The menu or logo may run off the screen when various adjustments are performed with [KEYSTONE].
- Various adjustments with [KEYSTONE] are possible to correct up to  $\pm 40^\circ$  for the tilt in vertical direction. However, the picture quality will degrade and it will get harder to focus with more correction. Install the projector so the correction will be as small as possible. ( $\pm 30^\circ$  when using fixed-focus lens (ET-DLE055), or super short focus zoom lens (ET-DLE080).)
- Image size will also change when [KEYSTONE] is used to perform adjustments.
- Trapezoidal distortion may occur depending on the lens shift position.
- Aspect ratio of the image size may shift depending on the correction or lens zoom value.

## [ADVANCED MENU] menu

Select [ADVANCED MENU] from the main menu, and select the item from the sub-menu. Refer to “Navigating through the menu” (▶ page 51) for the operation of the menu screen.

- After selecting the item, press ▲▼◀▶ to adjust.

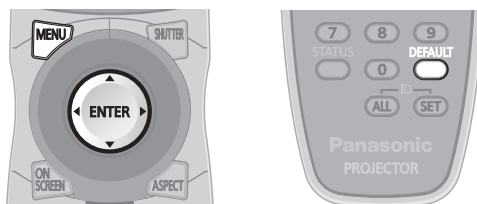

### [DIGITAL CINEMA REALITY]

You can increase the vertical resolution and enhance the picture quality by performing the cinema processing when the PAL (or the SECAM) 576i signal, the NTSC 480i, 1080/50i, and 1080/60i signals are input.

1) Press ▲▼ to select [DIGITAL CINEMA REALITY].

2) Press ◀▶ to switch [DIGITAL CINEMA REALITY].

- The setting will change among [AUTO], [OFF] and [25p FIXED]<sup>\*1</sup>/[30p FIXED]<sup>\*2</sup> each time you press the button.

\*1 Only during 576i, 1080/50i signal input

\*2 Only during 480i, 1080/60i signal input

#### ■ [DIGITAL CINEMA REALITY]

[AUTO]	Performs automatic detection and cinema processing. (Factory default)
[OFF]	Unforced cinema processing.
[25p FIXED]	Forced cinema processing (2:2 pulldown) is performed when a 576i or 1080/50i signal is input.
[30p FIXED]	Forced cinema processing (2:2 pulldown) is performed when a 480i or 1080/60i signal is input.

#### Note

- When a signal other than a 2:2 pulled-down signal is set to [25p FIXED] or [30p FIXED] in [DIGITAL CINEMA REALITY], picture quality deteriorates. (Vertical resolution will degrade.)

### [BLANKING]

The blanking width is adjusted when there are noise at the edge of the screen or the image is slightly running out from the screen when an image from the VCR or other devices are projected.

1) Press ▲▼ to select [BLANKING].

3) Press ▲▼ to select an adjustment item.

2) Press the <ENTER> button.

4) Press ◀▶ to adjust the blanking.

- The [BLANKING] adjustment screen is displayed.

#### ■ Adjustment details

Blanking correction	Item	Operation	Adjustment	Range	
Top of the screen	[UPPER]	Press ◀.	The blanking zone moves upward.		PT-DW640U: 0 to 399 PT-DX610U: 0 to 383
		Press ▶.	The blanking zone moves downward.		
Bottom of the screen	[LOWER]	Press ◀.	The blanking zone moves upward.		
		Press ▶.	The blanking zone moves downward.		

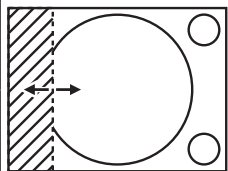
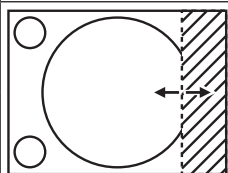

Blanking correction	Item	Operation	Adjustment	Range	
Left side of the screen	[LEFT]	Press ►.	The blanking zone moves to the right.		PT-DW640U: 0 to 639 PT-DX610U: 0 to 511
		Press ◀.	The blanking zone moves to the left.		
Right side of the screen	[RIGHT]	Press ►.	The blanking zone moves to the right.		
		Press ◀.	The blanking zone moves to the left.		

## [INPUT RESOLUTION]

You can adjust to achieve an optimal image when there is a flickering image or smeared outlines.

- 1) Press ▲▼ to select [INPUT RESOLUTION].
- 2) Press the <ENTER> button.
  - The [INPUT RESOLUTION] screen is displayed.
- 3) Press ▲▼ to select [TOTAL DOTS], [DISPLAY DOTS], [TOTAL LINES], or [DISPLAY LINES], then press ◀▶ to adjust it.
  - Values corresponding to the input signal are displayed automatically for each item. Change the displayed values and adjust to the optimal image viewing the screen when there is a vertical banding or missing in the screen.

### Note

- Previously mentioned vertical banding will not occur with all white signal input.
- The image may be disrupted while performing the adjustment, but it is not a malfunction.
- [INPUT RESOLUTION] can be adjusted only when an RGB signal is input to the <RGB 1 IN> terminal or the <RGB 2 IN> terminal.
- Certain signals may not be adjustable.

## [CLAMP POSITION]

You can adjust the optimal point when the black part of the image is blunt or it has turned green.

- 1) Press ▲▼ to select [CLAMP POSITION].
- 2) Press ◀▶ to adjust.

### ■ Adjustment details

Status	Rough guide for optimal value	Range
The black part is blunt.	The point where bluntness of the black part improves the most is the optimal value.	1 - 255
The black part is green.	The point where the green part becomes black, and the bluntness improves is the optimal value.	

### Note

- [CLAMP POSITION] can be adjusted only when a signal is input to the <RGB 1 IN> terminal or the <RGB 2 IN> terminal.
- Certain signals may not be adjustable.

## [EDGE BLENDING]

The edge blending function allows multiple projector images to be seamlessly overlapped by using the inclination of the brightness at the overlapped area.

- 1) Press ▲▼ to select [EDGE BLENDING].
- 2) Press ◀▶ to switch [EDGE BLENDING].
  - The setting will change between [ON] and [OFF] each time you press the button.
  - To adjust edge blending, proceed to Step 3).
- 3) Press the <ENTER> button when [ON] is selected.
  - The [EDGE BLENDING] screen is displayed.
- 4) Press ▲▼ to specify the location to be corrected.
  - When joining at top: Set [UPPER] to [ON].
  - When joining at bottom: Set [LOWER] to [ON].
  - When joining at left: Set [LEFT] to [ON].
  - When joining at right: Set [RIGHT] to [ON].
- 5) Press ◀▶ to switch between [ON] and [OFF].
  - To adjust edge blending without displaying the adjustment marker, proceed to Step 8).
- 6) Press ▲▼ to select [MARKER].

7) Press ◀▶ to switch [ON].

- A marker for image position adjustment is displayed.

8) Press ▲▼ to select [START] or [WIDTH], then press ◀▶ to adjust starting point and correction width.

- The green line is the starting point of edge blending adjusted with [START]. The red line is the ending point of edge blending adjusted with [WIDTH]. The position where the red and green lines overlap for the sets to join will be the optimal point.

Make sure to set the correction width for the sets to join as the same value. Optimal joining is not possible with the sets with different correction widths.

The optimal point is the point at which these lines overlap.

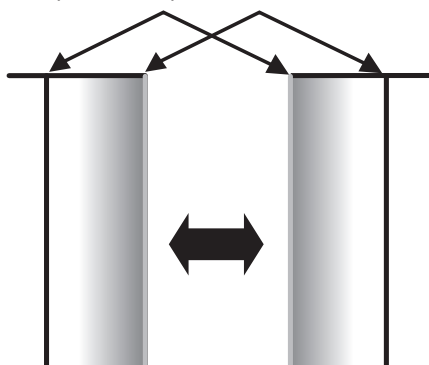

9) Press ▲▼ to select [GAMMA].

10) Press ◀▶ to switch [GAMMA].

- The setting will change among [2.2], [1.8], and [2.0] each time you press the button.

11) Press ▲▼ to select [BRIGHT ADJUST].

12) Press the <ENTER> button.

- The [BRIGHT ADJUST] screen is displayed.

13) Press ▲▼ to select [BRIGHT INSIDE].

14) Press the <ENTER> button.

- The [BRIGHT INSIDE] individual adjustment screen is displayed.
- If [INTERLOCKED] is set to [OFF], [RED], [GREEN], and [BLUE] can be adjusted individually.

15) Press ▲▼ to select an item, then press ◀▶ to adjust it.

- Once the adjustment is completed, press the <MENU> button to return to the [BRIGHT ADJUST] screen.

16) Press ▲▼ to select [UPPER], [LOWER], [LEFT], or [RIGHT] from [OUTSIDE AREA].

17) Press ◀▶ to set the region (width) of the [BRIGHT INSIDE] adjustment.

18) Press ▲▼ to select [BRIGHT OUTSIDE].

19) Press the <ENTER> button.

- The [BRIGHT OUTSIDE] individual adjustment screen is displayed.
- If [INTERLOCKED] is set to [OFF], [RED], [GREEN], and [BLUE] can be adjusted individually.

20) Press ▲▼ to select an item, then press ◀▶ to adjust it.

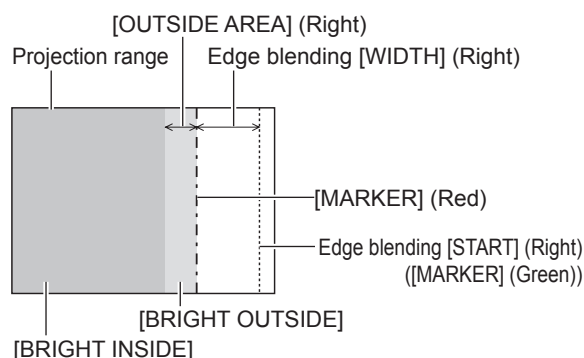

■ [EDGE BLENDING]

[OFF]	Sets the edge blending function to off.
[ON]	Use the setting value of the internal distortion of the set for the inclination of the edge blending area.

■ [GAMMA]

[2.2]	The screen becomes darker as the value increases. Set this item according to the condition of the joined part.
[1.8]	
[2.0]	

Note

- [BRIGHT ADJUST] is a function that makes the increased brightness in black level of the overlapping image area difficult to notice when [EDGE BLENDING] is used to configure multiple screens. The optimal point of the correction is set by adjusting [BRIGHT INSIDE] so the black level of the overlapping image area will be the same level as the non-overlapping area. If the bordering part of the part where the image is overlapping and the non-overlapping part gets brighter after adjusting [BRIGHT INSIDE], adjust the width of the top, bottom, left, or right. Adjust [BRIGHT OUTSIDE] when the width adjustment makes only the border area darker.
- The joining part may look discontinuous depending on the position you are looking from when a screen with high gain or rear screen is used.

[RASTER POSITION]

This will allow the position of the image to move within the display area arbitrarily when the input image is not using the whole display area.

1) Press ▲▼ to select [RASTER POSITION].

3) Press ▲▼◀▶ to adjust the position.

2) Press the <ENTER> button.

- The [RASTER POSITION] screen is displayed.

## [DISPLAY LANGUAGE] menu

- Select [DISPLAY LANGUAGE] from the main menu, and display the sub-menu.  
Refer to “Navigating through the menu” (➔ page 51) for the operation of the menu screen.
- Press ▲▼ to select a language, and press the <ENTER> button to set.

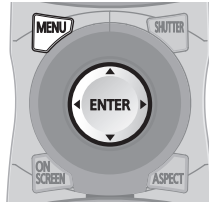

### Changing the display language

You can select the language of the on-screen display.

DISPLAY LANGUAGE	
●	ENGLISH
	DEUTSCH
	FRANÇAIS
	ESPAÑOL
	ITALIANO
	日本語
	中文
	РУССКИЙ
	한국어

- Various menus, settings, adjustment screens, control button names, etc., are displayed in the selected language.
- The language can be changed to English, German, French, Spanish, Italian, Japanese, Chinese, Russian, and Korean.

#### Note

- The on-screen display language of the projector is set to English by default, and also when [ALL USER DATA] (➔ page 84) is executed from [INITIALIZE].

## [DISPLAY OPTION] menu

Select [DISPLAY OPTION] from the main menu, and select the item from the sub-menu. Refer to “Navigating through the menu” (➔ page 51) for the operation of the menu screen.

- After selecting the item, press ▲▼◀▶ to set.

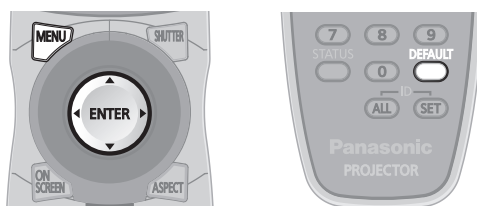

### [COLOR MATCHING]

You can correct the color difference between the sets when multiple sets are to be used simultaneously.

#### To adjust the color matching as desired

- 1) Press ▲▼ to select [COLOR MATCHING].
- 2) Press ◀▶ to switch [COLOR MATCHING].
  - The setting will change among [OFF], [3COLORS], [7COLORS] and [MEASURED] each time you press the button.
- 3) Select [3COLORS] or [7COLORS], and press the <ENTER> button.
  - The [3COLORS] or [7COLORS] screen is displayed.
- 4) Press ▲▼ to select [RED], [GREEN] or [BLUE] ([RED], [GREEN], [BLUE], [CYAN], [MAGENTA], [YELLOW], or [WHITE] for [7COLORS]).
- 5) Press the <ENTER> button.
  - The [3COLORS:RED], [3COLORS:GREEN], [3COLORS:BLUE], or [3COLORS:WHITE] screen is displayed. In the case of [7COLORS], the [7COLORS:RED], [7COLORS:GREEN], [7COLORS:BLUE], [7COLORS:CYAN], [7COLORS:MAGENTA], [7COLORS:YELLOW], or [7COLORS:WHITE] screen is displayed.
- 6) Press ▲▼ to select [RED], [GREEN], or [BLUE].
  - If [WHITE] is selected from [3COLORS], only [GAIN] can be adjusted.
- 7) Press ◀▶ to adjust.
  - Adjustment value will change between 0° and 2.048.
  - \* The lower limit differs depending on the color to be adjusted.

#### ■ [COLOR MATCHING]

[OFF]	Color matching adjustment is not carried out.
[3COLORS]	The three colors [RED], [GREEN], and [BLUE] can be adjusted.
[7COLORS]	The seven colors [RED], [GREEN], [BLUE], [CYAN], [MAGENTA], [YELLOW], and [WHITE] can be adjusted.
[MEASURED]	Refer to “To adjust the color matching using a colorimeter” (➔ page 68) for details about this mode.

#### Note

- Operation when correcting the adjustment color  
 When the correction color same as the adjustment color is changed: The luminance of the adjustment color changes.  
 When correction color red is changed: Red is added to or subtracted from the adjustment color.  
 When correction color green is changed: Green is added to or subtracted from the adjustment color.  
 When correction color blue is changed: Blue is added to or subtracted from the adjustment color.
- This adjustment should be carried out by a person who is familiar with the projector or by a service person because a high level of skill is required to make a successful adjustment.
- Pressing the <DEFAULT> button will restore the factory default settings for all items.
- When [COLOR MATCHING] is set to other than [OFF], [AI] and [COLOR CORRECTION] are fixed to [OFF], and [COLOR TEMPERATURE] is fixed to [USER]. (However, [WHITE BALANCE HIGH] cannot be adjusted.)

#### To adjust the color matching using a colorimeter

Use a colorimeter that can measure chromaticity coordinates and luminance to change the colors [RED], [GREEN], [BLUE], [CYAN], [MAGENTA], [YELLOW], and [WHITE] to desired colors.

- 1) Press ▲▼ to select [COLOR MATCHING].
- 2) Press ◀▶ to select [MEASURED].
- 3) Press the <ENTER> button.
  - The [MEASURED MODE] screen is displayed.
- 4) Press ▲▼ to select [MEASURED DATA].

- 5) Press the <ENTER> button.
  - The [MEASURED DATA] screen is displayed.
- 6) Measure the current luminance (Y) and the chromaticity coordinates (x, y) using the colorimeter.
- 7) Press ▲▼ to select a color, then press ◀▶ to adjust the value.
- 8) Once all the input is completed, press the <MENU> button.
  - The [MEASURED MODE] screen is displayed.
- 9) Press ▲▼ to select [TARGET DATA].
- 10) Press the <ENTER> button.
  - The [TARGET DATA] screen is displayed.
- 11) Press ▲▼ to select a color, and press ◀▶ to input coordinates for desired colors.
- 12) Once all the input is completed, press the <MENU> button.

#### Note

- Colors are not displayed properly when target data is a color outside the region of this projector.
- Set the [AUTO TESTPATTERN] to [ON] to automatically display a test pattern for use in adjusting the selected adjustment colors.
- When using a colorimeter or similar instrument to measure measurement data, measure the colors displayed with [AUTO TESTPATTERN].
- A difference in the color coordinates of target data and measurement values obtained from an instrument may occur for certain instruments and measurement environments used.

### [COLOR CORRECTION]

Colors can be adjusted and registered for each input signal format.

- 1) Press ▲▼ to select [COLOR CORRECTION].
- 2) Press ◀▶ to switch [COLOR CORRECTION].

#### ■ [COLOR CORRECTION]

[OFF]	Standard setting
[USER]	For each of the four signal formats, VIDEO, S-VIDEO, RGB, and YC <sub>B</sub> C <sub>R</sub> /YP <sub>B</sub> P <sub>R</sub> , six colors including red, green, blue, cyan, magenta, and yellow can be adjusted and registered. Press the <ENTER> button to set details. The adjustment range is between -30 and +30.

### [CONTRAST MODE]

There are two modes. Set according to the operating environment.

- 1) Press ▲▼ to select [CONTRAST MODE].
- 2) Press ◀▶ to switch [CONTRAST MODE].

#### ■ [CONTRAST MODE]

[NORMAL]	Maximizes brightness.
[HIGH]	Maximizes contrast.

### [SCREEN SETTING]

Set the screen size.

When changing the aspect of a projected image, correct to the optimum image position for the set screen. Set as necessary for the screen in use.

- 1) Press ▲▼ to select [SCREEN SETTING].
- 2) Press the <ENTER> button.
  - The [SCREEN SETTING] screen is displayed.
- 3) Press ◀▶ to switch [SCREEN FORMAT].
  - The setting will change between [16:10] and [16:9] for PT-DW640U, or [4:3] and [16:9] for PT-DX610U.
- 4) Press ▲▼ to select [SCREEN POSITION].
- 5) Press ◀▶ to adjust [SCREEN POSITION].

#### ■ [SCREEN FORMAT]

PT-DW640U	[16:10]	[SCREEN POSITION]	Cannot be adjusted.
	[16:9]		Vertical position can be adjusted between -40 and 40.
PT-DX610U	[4:3]		Cannot be adjusted.
	[16:9]		Vertical position can be adjusted between -96 and 96.

## [AUTO SIGNAL]

Set automatic execution of auto setup.

The screen display position or signal level can be adjusted automatically without pressing the <AUTO SETUP> button on the remote control on each occasion if you input unregistered signals frequently at meetings, etc.

- 1) Press ▲▼ to select [AUTO SIGNAL].
- 2) Press ◀▶ to switch [AUTO SIGNAL].
  - The setting will change between [OFF] and [ON] each time you press the button.

### ■ [AUTO SIGNAL]

[OFF]	Set input auto setup to off.
[ON]	Auto setup is automatically executed when images are changed to unregistered signals during projection.

## [AUTO SETUP]

You can set when adjusting a special signal or horizontally long (16:9, etc.) signal.

- 1) Press ▲▼ to select [AUTO SETUP].
- 2) Press the <ENTER> button.
  - The [AUTO SETUP] screen is displayed.
- 3) Press ◀▶ to switch [MODE].
  - The setting will change among [DEFAULT], [WIDE], and [USER] each time you press the button.
  - When [DEFAULT] or [WIDE] is selected, proceed to Step 6).
  - When [USER] is selected, proceed to Step 4).
- 4) Press ▲▼ to select [DISPLAY DOTS], and press ◀▶ to adjust [DISPLAY DOTS] to the horizontal resolution of the signal source.
- 5) Press ▲▼ to select [MODE].
- 6) Press the <ENTER> button.
  - Automatic adjustment is executed. [PROGRESS] is displayed while automatically adjusting. When complete, the system returns to the [AUTO SETUP] screen.

### ■ [MODE]

[DEFAULT]	Select when receiving a signal whose image aspect is 4:3 or 5:4. (Supported resolutions are 640 x 400, 640 x 480, 800 x 600, 832 x 624, 1 024 x 768, 1 152 x 864, 1 152 x 870, 1 280 x 960, 1 280 x 1 024, 1 600 x 1 200, and 1 400 x 1 050.)
[WIDE]	Select when receiving a signal whose image aspect is wide-screen. (Supported resolutions are 1 280 x 720, 1 280 x 800, 1 440 x 900, 1 680 x 1 050, 1 920 x 1 080, and 1 920 x 1 200.)
[USER]	Select when receiving a signal with a special horizontal resolution (number of display dots).

## [RGB IN]

Set to match the signal to input to the <RGB 1 IN> terminal.

- 1) Press ▲▼ to select [RGB IN].
- 2) Press the <ENTER> button.
  - The [RGB IN] screen is displayed.
- 3) Press ▲▼ to select [RGB1 SYNC SLICE LEVEL] or [RGB2 SYNC SLICE LEVEL].
- 4) Press ◀▶ to switch between [RGB1 SYNC SLICE LEVEL] and [RGB2 SYNC SLICE LEVEL].
  - The setting will change between [LOW] and [HIGH] each time you press the button.

### ■ [RGB1 SYNC SLICE LEVEL] and [RGB2 SYNC SLICE LEVEL]

[LOW]	Set the slice level to [LOW].
[HIGH]	Set the slice level to [HIGH].

## [DVI-D IN]

Switch the setting when the external equipment is connected to the <DVI-D IN> terminal of the projector and the image is not projected correctly.

- 1) Press ▲▼ to select [DVI-D IN].
- 2) Press the <ENTER> button.
  - The [DVI-D IN] screen is displayed.
- 3) Press ▲▼ to select [DVI EDID].
- 4) Press ◀▶ to switch [DVI EDID].
  - The setting will change among [EDID3], [EDID1], and [EDID2:PC] each time you press the button.
- 5) Press ▲▼ to select [DVI SIGNAL LEVEL].

**6) Press ◀▶ to switch [DVI SIGNAL LEVEL].**

- The setting will change between [0-255:PC] and [16-235] each time you press the button.

■ [DVI EDID]

[EDID3]	Switch between fine settings for a moving image and for a still image.
[EDID1]	Select mainly when an external device that outputs movie-type image signals (such as a blu-ray disk player) is connected to the <DVI-D IN> terminal.
[EDID2:PC]	Select mainly when an external device that outputs still image-type signals (such as a computer) is connected to the <DVI-D IN> terminal.

■ [DVI SIGNAL LEVEL]

[0-255:PC]	Select when an external device (such as a computer) is connected via DVI terminal output.
[16-235]	Select when an external device (such as a blu-ray disc player) is connected via HDMI terminal output by use of a conversion cable or similar cable.

**Note**

- The optimal setting is different depending on the output setting of the connected external equipment. Refer to the instruction manual of the external equipment regarding the output of the external equipment.
- The data for Plug and play will change when the setting is changed. Refer to “List of compatible signals” (➔ page 125) for a resolution that supports plug and play.

**[HDMI IN]**

Switch the setting when the projector is connected to an external device via an HDMI cable and the image is not projected correctly.

**1) Press ▲▼ to select [HDMI IN].**

**2) Press the <ENTER> button.**

- The [HDMI IN] screen is displayed.

**3) Press ◀▶ to switch [HDMI SIGNAL LEVEL].**

- The setting will change between [64-940] and [0-1023] each time you press the button.

■ [HDMI SIGNAL LEVEL]

[64-940]	Select when the HDMI terminal of an external device (such as a blu-ray disc player) is connected to the <HDMI IN> terminal.
[0-1023]	Select when the DVI-D terminal output of an external device (such as a computer) is connected to the <HDMI IN> terminal via a conversion cable or similar cable. Select also when the HDMI terminal output of a computer or other device is connected to the <HDMI IN> terminal.

**Note**

- The optimal setting is different depending on the output setting of the connected external equipment. Refer to the instruction manual of the external equipment regarding the output of the external equipment.
- The HDMI signal level is displayed per each 30 bits of input.

**[ON-SCREEN DISPLAY]**

Set the on-screen display.

**1) Press ▲▼ to select [ON-SCREEN DISPLAY].**

**2) Press the <ENTER> button.**

- The [ON-SCREEN DISPLAY] screen is displayed.

**3) Press ▲▼ to select [OSD POSITION], [OSD DESIGN], [OSD MEMORY], [INPUT GUIDE], or [WARNING MESSAGE], then press ◀▶ to adjust it.**

- [2] - [9], [1] in [OSD POSITION], [1] - [6] in [OSD DESIGN], [ON]/[OFF] in [OSD MEMORY], [INPUT GUIDE], and [WARNING MESSAGE] will change each time you press the button.

## ■ [ON-SCREEN DISPLAY]

[OSD POSITION]	[2]	Set the position of the menu screen (OSD) to the center left of the screen.
	[3]	Set the position of the menu screen (OSD) to the bottom left of the screen.
	[4]	Set the position of the menu screen (OSD) to the top center of the screen.
	[5]	Set the position of the menu screen (OSD) to the center of the screen.
	[6]	Set the position of the menu screen (OSD) to the bottom center of the screen.
	[7]	Set the position of the menu screen (OSD) to the top right of the screen.
	[8]	Set the position of the menu screen (OSD) to the center right of the screen.
	[9]	Set the position of the menu screen (OSD) to the bottom right of the screen.
	[1]	Set the position of the menu screen (OSD) to the top left of the screen.
[OSD DESIGN]	[1]	Set the color of the menu screen (OSD) to yellow.
	[2]	Set the color of the menu screen (OSD) to blue.
	[3]	Set the color of the menu screen (OSD) to white.
	[4]	Set the color of the menu screen (OSD) to green.
	[5]	Set the color of the menu screen (OSD) to pink.
	[6]	Set the color of the menu screen (OSD) to brown.
[OSD MEMORY]	[ON]	Set hold for the position of the menu screen (OSD) cursor.
	[OFF]	
[INPUT GUIDE]	[ON]	Set display of the input terminal name currently selected in the position set by the [OSD POSITION].
	[OFF]	
[WARNING MESSAGE]	[ON]	You can set the display/hide of the warning message.
	[OFF]	

### Note

- Even if [OSD MEMORY] is set to [ON], the cursor position will not be held when the <MAIN POWER> switch of the projector body is turned <OFF>.

## [BACK COLOR]

Set the color of the projected image when there is no signal input.

1) Press ▲▼ to select [BACK COLOR].

2) Press ◀▶ to switch [BACK COLOR].

- The setting will change among [BLUE], [BLACK], [DEFAULT LOGO] and [USER LOGO] each time you press the button.

## ■ [BACK COLOR]

[BLUE]	The entire projection area appears blue.
[BLACK]	The entire projection area appears black.
[DEFAULT LOGO]	The Panasonic logo is projected.
[USER LOGO]	The picture registered by the user is projected.

### Note

- To create the image for [USER LOGO], "Logo Transfer Software" included in the supplied CD-ROM is required.

## [STARTUP LOGO]

Set the logo display when the power is turned on.

1) Press ▲▼ to select [STARTUP LOGO].

2) Press ◀▶ to switch [STARTUP LOGO].

- The setting will change among [DEFAULT LOGO], [USER LOGO], and [NONE] each time you press the button.

## ■ [STARTUP LOGO]

[DEFAULT LOGO]	The Panasonic logo is projected.
[USER LOGO]	The picture registered by the user is projected.
[NONE]	No startup logo is projected.



**Note**

- The startup logo will disappear in approximately 15 seconds.
- To create the image for [USER LOGO], "Logo Transfer Software" included in the supplied CD-ROM is required.

**[SHUTTER SETTING]**

Set the opening and closing status of the shutter for when projection begins by switching on the projector, and for when the projector is switched off.

**To set [STARTUP]**

- 1) Press **▲▼** to select [SHUTTER SETTING].
- 2) Press the **<ENTER>** button.
  - The [SHUTTER SETTING] screen is displayed.
- 3) Press **▲▼** to select [STARTUP].
- 4) Press **◀▶** to switch.
  - The setting will change between [OPEN] and [CLOSE] each time you press the button.

**■ [STARTUP]**

[OPEN]	Projection begins with the shutter open when the power is turned on.
[CLOSE]	Projection begins with the shutter closed when the power is turned on.

**To set [SHUT-OFF]**

- 1) Press **▲▼** to select [SHUTTER SETTING].
- 2) Press the **<ENTER>** button.
  - The [SHUTTER SETTING] screen is displayed.
- 3) Press **▲▼** to select [SHUT-OFF].
- 4) Press **◀▶** to switch.
  - The setting will change among [KEEP CURRENT STATE], [CLOSE], and [OPEN] each time you press the button.

**■ [SHUT-OFF]**

[KEEP CURRENT STATE]	Enters standby with the opening and closing status of the shutter same as before switching off the projector.
[CLOSE]	Enters standby with the shutter closed.
[OPEN]	Enters standby with the shutter open.

**Note**

- It is recommended that you set the projector to enter standby with the shutter closed when you remove the projection lens for transport of the set, etc. so that dust will not enter.
- When switching off the projector, the [POWER OFF(STANDBY)] confirmation screen appears regardless of the opening and closing status of the shutter at that moment.

**[FREEZE]**

The projected image is paused temporarily regardless of the playback of the external equipment.

- 1) Press **▲▼** to select [FREEZE].
- 2) Press the **<ENTER>** button.
  - Press the **<MENU>** button to release.

**[SIDE BY SIDE] (PT-DW640U only)**

Displays two different input signals simultaneously.

- 1) Press **▲▼** to select [SIDE BY SIDE].
- 2) Press the **<ENTER>** button.
  - Displays the side-by-side screen.
- 3) Press the **<MENU>** button.
  - The [SUB INPUT SELECT] screen is displayed.
- 4) Press **▲▼** to select the image to display on the Input B side.
  - Press **▲▼** to select an image to display on the right side of the screen (Input B).
- 5) Press the **<ENTER>** button.

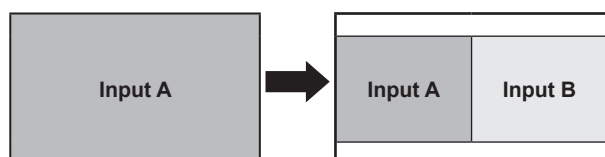

- 3) Press the **<MENU>** button.
  - The [SUB INPUT SELECT] screen is displayed.

## ■ Setting the two window display

[VIDEO]	Displays images of [VIDEO] input on the right screen (Input B).
[S-VIDEO]	Displays images of [S-VIDEO] input on the right screen (Input B).
[RGB1]	Displays images of [RGB1] input on the right screen (Input B).
[RGB2]	Displays images of [RGB2] input on the right screen (Input B).
[DVI-D]	Displays images of [DVI-D] input on the right screen (Input B).
[HDMI]	Displays images of [HDMI] input on the right screen (Input B).
[OFF]	Cancels the two window display.

### Note

- [FREEZE] is set on the Input A side.
- During the two window display, menu items cannot be adjusted or set.
- The value of the Input A side is applied to the [PICTURE] setting. (For [CONTRAST], [BRIGHTNESS], [COLOR], [TINT], and [SHARPNESS], respective values of both Input A and B are applied.)
- The two window display maintains the aspect ratio selected with the <ASPECT> button on the remote control or the setting of [ASPECT].
- The two window display may not be available depending on the combination of input signals.  
Refer to "Two window display combination list (PT-DW640U only)" (➔ page 125) for details.

## [CUT OFF]

Each red, green and blue color component can be removed.

- 1) Press ▲▼ to select [CUT OFF].
- 2) Press the <ENTER> button.
  - The [CUT OFF] screen is displayed.
- 3) Press ▲▼ to select [RED], [GREEN], or [BLUE].
- 4) Press ◀▶ to switch.
  - The setting will change between [OFF] and [ON] each time you press the button.

## ■ [RED], [GREEN], and [BLUE]

[OFF]	Disables cutoff.
[ON]	Enables cutoff.

### Note

- When input is switched or a signal is switched, the cutoff setting returns to its original setting ([OFF]).

## [PROJECTOR SETUP] menu

Select [PROJECTOR SETUP] from the main menu, and select the item from the sub-menu. Refer to “Navigating through the menu” (➔ page 51) for the operation of the menu screen.

- After selecting the item, press ▲▼◀▶ to set.

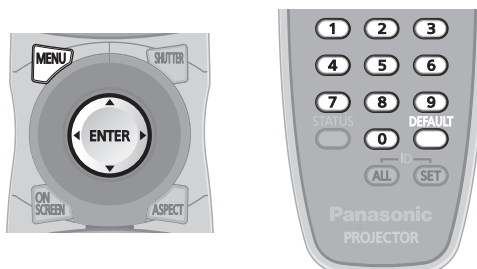

### [PROJECTOR ID]

The projector has an ID number setting function that can be used when multiple projectors are used side by side to enable simultaneous control or individual control via one remote control.

1) Press ▲▼ to select [PROJECTOR ID].

2) Press ◀▶ to switch [PROJECTOR ID].

- The setting will change among [ALL] and [1] to [64] each time you press the button.

#### ■ [PROJECTOR ID]

[ALL]	Set to control without specifying an ID number.
[1] - [64]	Set to control specifying an ID number for individual control.

#### Note

- The ID number can be set to [ALL], or from [1] to [64].
- To specify an ID number for individual control, the ID number of a remote control must match the ID number of the projector.
- When the ID number is set to [ALL], the projector will operate regardless of the ID number specified during remote control or computer control.  
If multiple projectors are set up side by side with IDs set to [ALL], they cannot be controlled separately from the projectors with other ID numbers.
- Refer to “Setting Remote control ID numbers” (➔ page 23) regarding the method to set the ID number on the remote control.

### [PROJECTION METHOD]

Set the projection method in accordance with the installation status of the projector.

Change the projection method if the screen display is upside down or inverted.

1) Press ▲▼ to select [PROJECTION METHOD].

3) Press ▲▼ to select a projection method.

2) Press the <ENTER> button.

4) Press the <ENTER> button.

- The [PROJECTION METHOD] screen is displayed.

5) When the confirmation is displayed, select [OK] or [CANCEL], and press the <ENTER> button.

#### ■ Available projection methods

[FRONT/FLOOR]	When installing on the desk, etc., in front of the screen
[FRONT/CEILING]	When installing using the ceiling mount bracket (optional accessories) in front of the screen
[REAR/FLOOR]	When installing on the desk, etc., behind the screen (using a translucent screen)
[REAR/CEILING]	When installing using the ceiling mount bracket (optional accessories) behind the screen (using a translucent screen)

#### Attention

- When [PROJECTION METHOD] is changed, confirm that [COOLING CONDITION] (➔ page 76) is set correctly.

## [COOLING CONDITION]

Change the fan control depending on the direction of projection.

Set [COOLING CONDITION] correctly in accordance with the direction of projection referring to the following figure. It may shorten the life of the lamp if used in incorrect setting.

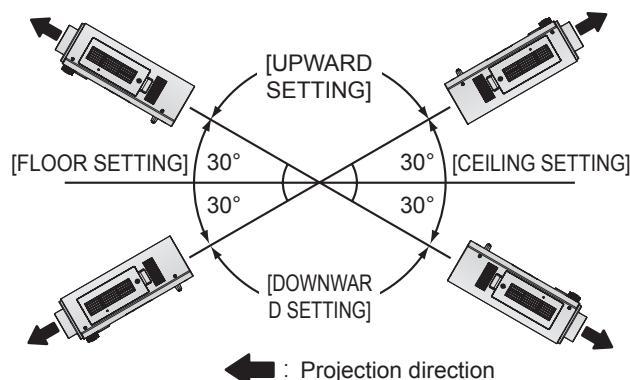

- 1) Press ▲▼ to select [COOLING CONDITION].
- 2) Press the <ENTER> button.
  - The [COOLING CONDITION] screen is displayed.
- 3) Press ▲▼ to select a cooling condition.
- 4) Press the <ENTER> button.
- 5) When the confirmation is displayed, select [OK] or [CANCEL], and press the <ENTER> button.

## [HIGH ALTITUDE MODE]

Set to [ON] to use the projector at 1 400 m (4 593 ft) to 2 700 m (8 858 ft) elevations.

- 1) Press ▲▼ to select [HIGH ALTITUDE MODE].
- 2) Press ◀▶ to switch [HIGH ALTITUDE MODE].
  - The setting will change between [OFF] and [ON].
- 3) When the confirmation is displayed, select [OK] or [CANCEL], and press the <ENTER> button.

### ■ [HIGH ALTITUDE MODE]

[OFF]	When using at a place lower than 1 400 m (4 593 ft) above sea level
[ON]	When using at a high altitude (1 400 m (4 593 ft) or higher and lower than 2 700 m (8 858 ft) above sea level)

### Note

- The speed of the fan increases and the operation sound becomes louder when set to [ON].

## [LAMP SELECT]

Switch between brightness of two lamps and that of single lamp from the two luminous lamps built into the projector body according to the use condition or purpose. When [SINGLE] is set, the lamp to be turned on is automatically selected based on the cumulative operating time of lamps.

- 1) Press ▲▼ to select [LAMP SELECT].
- 2) Press ◀▶ to switch [LAMP SELECT].
  - The setting will change among [DUAL], [SINGLE], [LAMP1] and [LAMP2] each time you press the button.
- 3) Press the <ENTER> button.

### ■ [LAMP SELECT]

[DUAL]	Two lamps will light.
[SINGLE]	Single lamp will light. (The lamp with shorter cumulative operating time is selected automatically.)
[LAMP1]	Lamp 1 will light.
[LAMP2]	Lamp 2 will light.

### Note

- When [SINGLE], [LAMP1], or [LAMP2] is selected, if the lamp does not light or the cumulative operating time exceeds 2 500 hours (when [LAMP POWER] is set to [NORMAL]), the other lamp will light. When [DUAL] is selected, if either lamp does not light or the cumulative

operating time of either of them exceeds 2 500 hours (when [LAMP POWER] is set to [NORMAL]), only the other lamp will light. However, if both lamps do not light, or the cumulative operating time of both of them exceeds 2 500 hours (when [LAMP POWER] is set to [NORMAL]), the projector will go into standby.

- The font colors of the items indicate the status.  
Green → Current setting  
Yellow → Current setting (when there is a lamp that cannot turn on or failed to turn on)  
Red → Lamp that has failed to turn on  
White → Any other status
- Repeatedly switching in a short time will increase the speed of the lamp replacement cycle.

## [LAMP RELAY]

The lamp to be turned on can be automatically switched by specifying the day of the week and time.

The degradation of the lamp due to continuous usage can be reduced by automatically switching the lamp to be turned on when using the projector continuously for 1 week or more.

- 1) Press ▲▼ to select [LAMP RELAY].
- 2) Press ◀▶ to switch [LAMP RELAY].
  - The setting will change among [OFF], [24H], and [1WEEK] each time you press the button.
- 3) Press ▲▼ to select [TIME].
- 4) Press the <ENTER> button.
  - Enters adjustment mode (the display is blinking).
- 5) Press ◀▶ to select [HOUR] or [MINUTE], and then press ▲▼ to adjust it.
  - Hours only can be adjusted with one hour increments when [HOUR] is selected and minutes only can be adjusted with one minute increments between 00 and 59 when [MINUTE] is selected.
- 6) Press the <ENTER> button.
  - The adjusted time is established.
- 7) Press ▲▼ to select [DAY OF THE WEEK].
- 8) Press ◀▶ to switch [DAY OF THE WEEK].
  - The setting will change among [SUNDAY], [MONDAY], [TUESDAY], [WEDNESDAY], [THURSDAY], [FRIDAY] and [SATURDAY] each time you press the button.

### ■ [LAMP RELAY]

[OFF]	Disables lamp relay.
[24H]	Switches lamps on a day-to-day basis.
[1WEEK]	Switches lamps on a week-to-week basis.

### ■ [DAY OF THE WEEK]

[SUNDAY]	The lamp to be turned on will be switched automatically on the set day of the week.
[MONDAY]	
[TUESDAY]	
[WEDNESDAY]	
[THURSDAY]	
[FRIDAY]	
[SATURDAY]	

#### Note

- The [LAMP RELAY] function is enabled when [DUAL] or [SINGLE] is selected in [LAMP SELECT].
- Only a single lamp lights for four hours from the preset time when [DUAL] is selected in [LAMP SELECT].
- The operating time will be the local time. (➔ page 83)
- Use the number (<0> to <9>) buttons on the remote control to directly enter the time.

## [LAMP POWER]

Switch lamp brightness according to the operating environment or purpose of the projector.

- 1) Press ▲▼ to select [LAMP POWER].
- 2) Press ◀▶ to switch [LAMP POWER].
  - The setting will change between [NORMAL] and [ECO] each time you press the button.

### ■ [LAMP POWER]

[NORMAL]	Set when high luminance is required.
----------	--------------------------------------

[ECO]	Set when high luminance is not required.
-------	--

### Note

- When [ECO] is set, the power consumption and operation sound can be reduced while the lamp life can be increased.

## [STANDBY MODE]

Set the power consumption during the standby.

1) Press ▲▼ to select [STANDBY MODE].

2) Press ◀▶ to switch [STANDBY MODE].

- The setting will change between [NORMAL] and [ECO] each time you press the button.

### ■ [STANDBY MODE]

[NORMAL]	Normally use this setting.
[ECO]	Use this setting to reduce power consumption during standby.

### Note

- When set to [ECO], network functions and <SERIAL OUT> terminal are not available during standby. Also, some RS-232C commands are not available. When set to [NORMAL], network functions and <SERIAL OUT> terminal are available during standby.
- If set to [ECO], there may be a time lag of approximately 10 seconds between turning on the power and starting projection compared to when the setting is [NORMAL].

## [SCHEDULE]

Set the command execution schedule for each day of the week.

### Enabling/disabling the schedule function

1) Press ▲▼ to select [SCHEDULE].

2) Press ◀▶ to switch [SCHEDULE].

- The setting will change between [OFF] and [ON] each time you press the button.

### ■ [SCHEDULE]

[OFF]	Disables the schedule function.
[ON]	Enables the schedule function. Refer to “How to assign a program” (▶ page 78) or “How to set a program” (▶ page 78) in regard to how to set the schedule.

### Note

- When [SCHEDULE] is set to [ON], the [STANDBY MODE] setting is forcibly switched to [NORMAL], and the setting cannot be changed. Even if [SCHEDULE] is then set to [OFF] when in this state, the setting of [STANDBY MODE] remains at [NORMAL].

### How to assign a program

1) Press ▲▼ to select [SCHEDULE].

2) Press ◀▶ to select [ON], and press the <ENTER> button.

- The [SCHEDULE] screen is displayed.

3) Select and assign program to each day of week.

- Press ▲▼ to select the day of week, and press ◀▶ to select a program number.
- You can set the program from No.1 to No.7. “- -” indicates that the program number has not been set yet.

### How to set a program

You can set up to 16 commands to each program.

1) Press ▲▼ to select [SCHEDULE].

2) Press ◀▶ to select [ON], and press the <ENTER> button.

- The [SCHEDULE] screen is displayed.

3) Press ▲▼ to select [PROGRAM EDIT].

4) Press ◀▶ to select a program number and then press the <ENTER> button.

5) Press ▲▼ to select a command number and press the <ENTER> button.

- You can change the page using ◀▶.

6) Press ▲▼ to select [TIME], and press the <ENTER> button.

- 7) Press ◀▶ to select hour and minute, and press ▲▼ or the number (<0> to <9>) buttons to set a time, and press the <ENTER> button.
- 8) Press ▲▼ to select [COMMAND].
- 9) Press ◀▶ to switch [COMMAND].
- The setting will change among [POWER ON], [STANDBY], [SHUTTER]<sup>\*1</sup>, [INPUT]<sup>\*1</sup>, [LAMP SELECT]<sup>\*1</sup>, [LAMP POWER]<sup>\*1</sup> and [SIDE BY SIDE]<sup>\*1\*2</sup> each time you press the button.
- \*1 The details set in step 11) are displayed.  
\*2 Only for PT-DW640U
- 10) Press the <ENTER> button.
- The [COMMAND] detailed screen is displayed.
- 11) Press ▲▼ to select a command.
- [OPEN]/[CLOSE] in [SHUTTER], [RGB1]/[RGB2]/[VIDEO]/[S-VIDEO]/[DVI-D]/[HDMI] in [INPUT], [DUAL]/[SINGLE] in [LAMP SELECT], [NORMAL]/[ECO] in [LAMP POWER], and [OFF]/[ON] in [SIDE BY SIDE] will change each time you press ◀▶.
- 12) Press the <ENTER> button.
- The command is fixed and ● is displayed at the left of the selected command.
  - After the command is fixed, press the <MENU> button to close the detailed setting menu.
- 13) Press ▲▼ to select [STORE], and press the <ENTER> button.

## ■ [COMMAND]

[POWER ON]	—	Turns the power on.
[STANDBY]	—	Enters standby.
[SHUTTER]	[OPEN]	Opens the shutter.
	[CLOSE]	Closes the shutter.
[INPUT]	[RGB1]	Switches the input to RGB1.
	[RGB2]	Switches the input to RGB2.
	[VIDEO]	Switches the input to VIDEO.
	[S-VIDEO]	Switches the input to S-VIDEO.
	[DVI-D]	Switches the input to DVI-D.
	[HDMI]	Switches the input to HDMI.
[LAMP SELECT]	[DUAL]	Turns on both lamps.
	[SINGLE]	Turns on one lamp. (The lamp is automatically selected which has shorter cumulative operating time.)
[LAMP POWER]	[NORMAL]	Sets the high luminance of the lamp.
	[ECO]	Sets lower luminance of the lamp than [NORMAL].
[SIDE BY SIDE]*	[OFF]	Displays the side-by-side screen.
	[ON]	Cancels the side-by-side screen.

\* Only for PT-DW640U

## Note

- If you try to register a setting that would cause the lamp to flash for a short time, an error message will be displayed on the screen. Set the time and command again.
- To delete a command already set, press the <DEFAULT> button on the Step 5) screen, or select [DELETE] on the Step 6) screen and press the <ENTER> button.
- If multiple commands have been set for the same time, they are executed in chronological order starting from the smallest command number.
- The operating time will be the local time. (➔ page 83)
- If an operation is executed with the remote control or control panel of the projector or with a control command before the command set in [SCHEDULE] is executed, the command set with this function may not be executed.

## [STARTUP INPUT SELECT]

Set the input signal to be projected when the projector is switched on.

- 1) Press ▲▼ to select [STARTUP INPUT SELECT].
- 2) Press ◀▶ to switch [STARTUP INPUT SELECT].
- The setting will change among [LAST USED], [RGB1], [RGB2], [VIDEO], [S-VIDEO], [DVI-D] and [HDMI] each time you press the button.

## ■ [STARTUP INPUT SELECT]

[LAST USED]	Keeps the input selected last.
[RGB1]	Sets the input to be projected when the projector is switched on to RGB1.
[RGB2]	Sets the input to be projected when the projector is switched on to RGB2.
[VIDEO]	Sets the input to be projected when the projector is switched on to VIDEO.

[S-VIDEO]	Sets the input to be projected when the projector is switched on to S-VIDEO.
[DVI-D]	Sets the input to be projected when the projector is switched on to DVI-D.
[HDMI]	Sets the input to be projected when the projector is switched on to HDMI.

## [RS-232C]

Set the communication conditions of the <SERIAL IN>/<SERIAL OUT> terminal.

### To set the communication condition of the <SERIAL IN> terminal

- 1) Press ▲▼ to select [RS-232C].
- 2) Press the <ENTER> button.
  - The [RS-232C] screen is displayed.
- 3) Press ▲▼ to select [(IN) BAUDRATE].
- 4) Press ◀▶ to switch [(IN) BAUDRATE].
  - The setting will change among [9600], [19200], and [38400] each time you press the button.
- 5) Press ▲▼ to select [(IN) PARITY].
- 6) Press ◀▶ to switch [(IN) PARITY].
  - The setting will change among [NONE], [EVEN], and [ODD] each time you press the button.

#### ■ [(IN) BAUDRATE]

[9600]	Select the proper speed.
[19200]	
[38400]	

#### ■ [(IN) PARITY]

[NONE]	Select the parity condition.
[EVEN]	
[ODD]	

### To set the communication condition of the <SERIAL OUT> terminal

- 1) Press ▲▼ to select [RS-232C].
- 2) Press the <ENTER> button.
  - The [RS-232C] screen is displayed.
- 3) Press ▲▼ to select [(OUT) BAUDRATE].
- 4) Press ◀▶ to switch [(OUT) BAUDRATE].
  - The setting will change among [9600], [19200], and [38400] each time you press the button.
- 5) Press ▲▼ to select [(OUT) PARITY].
- 6) Press ◀▶ to switch [(OUT) PARITY].
  - The setting will change among [NONE], [EVEN], and [ODD] each time you press the button.

#### ■ [(OUT) BAUDRATE]

[9600]	Select the proper speed.
[19200]	
[38400]	

#### ■ [(OUT) PARITY]

[NONE]	Select the parity condition.
[EVEN]	
[ODD]	

### To set the response

- 1) Press ▲▼ to select [RS-232C].
- 2) Press the <ENTER> button.
  - The [RS-232C] screen is displayed.
- 3) Press ▲▼ to select [RESPONSE(ID ALL)].
- 4) Press ◀▶ to switch [RESPONSE(ID ALL)].
  - The setting will change between [ON] and [OFF] each time you press the button.
- 5) Press ▲▼ to select [GROUP].



**6) Press ◀▶ to switch [GROUP].**

- The setting will change among [A] to [Z] each time you press the button.

**8) Press ◀▶ to switch [RESPONSE(ID GROUP)].**

- The setting will change between [ON] and [OFF] each time you press the button.

**7) Press ▲▼ to select [RESPONSE(ID GROUP)].**

■ [RESPONSE(ID ALL)]

[ON]	Returns the response when the ID setting is ALL.
[OFF]	Does not return the response when the ID setting is ALL.

■ [GROUP]

[A] - [Z]	Controls multiple projectors simultaneously by sending the ID of RS-232C. Set the group from [A] to [Z]. The projector responds when the ID of RS-232C matches the setting.
-----------	---

■ [RESPONSE(ID GROUP)]

[ON]	Returns the response when the ID setting is GROUP.
[OFF]	Does not return the response when the ID setting is GROUP.

**Note**

- Refer to “<SERIAL IN>/<SERIAL OUT> terminal” (➔ page 121).

**[REMOTE2 MODE]**

You can set the <REMOTE 2 IN> terminal.

**1) Press ▲▼ to select [REMOTE2 MODE].**

**3) Press the <ENTER> button.**

**2) Press ◀▶ to switch [REMOTE2 MODE].**

**4) Press ▲▼ to select any from [PIN2] to [PIN8] and press ◀▶ to switch the setting.**

- The setting will change between [DEFAULT] and [USER] each time you press the button.
- When [USER] is selected, proceed to Step 3).

- [PIN1] and [PIN9] cannot be changed.

■ [REMOTE2 MODE]

[DEFAULT]	The pin assignment of the <REMOTE 2 IN> terminal is used by the factory default setting of the projector. (➔ page 124)
[USER]	The pin assignment of the <REMOTE 2 IN> terminal is used by the setting changed from the factory default setting of the projector.

**[STATUS]**

Displays the status of the projector.

**1) Press ▲▼ to select [STATUS].**

**3) Press ◀▶ to switch the pages.**

**2) Press the <ENTER> button.**

- The [STATUS] screen is displayed.

- The page will change each time you press the button.

■ Contents to be displayed

[INPUT]	Displays the input terminal currently selected.
[SIGNAL NAME]	Displays the input signal name.
[SIGNAL FREQUENCY]	Displays the frequency of the input signal.
[PROJECTOR RUNTIME]	Displays the operation times of the projector.
[LAMP1]*	Displays the hours used of lamp 1.
[LAMP2]*	Displays the hours used of lamp 2.
[INTAKE AIR TEMP.]	Displays the status of the air intake temperature of the projector.
[OPTICS MODULE TEMP.]	Displays the status of the internal temperature of the projector.
[AROUND LAMP TEMP.]	Displays the status of the temperature around the lamps of the projector.
[PROJECTOR TYPE]	Displays the type of the projector.
[SERIAL NUMBER]	Displays the serial number of the projector.
[LAMP UNIT MODEL NO.]	Displays the model no. of the lamp unit.

[LAMP1 SERIAL NUMBER]	Displays the serial number of the lamp 1.	
[LAMP2 SERIAL NUMBER]	Displays the serial number of the lamp 2.	
[MAIN VERSION]	Displays the main version of the firmware of the projector.	
[SUB VERSION]	Displays the sub version of the firmware of the projector.	
[NETWORK VERSION]	Displays the network version of the projector.	
[ON COUNT]	[POWER ON TIMES]	Displays the number of times the power is turned on.
	[LAMP1 ON]	Displays the number of times lamp 1 has been turned on.
	[LAMP2 ON]	Displays the number of times lamp 2 has been turned on.
	[SHUTTER]	Displays the number of times the shutter function has been used.
[LAMP1]	Displays the details of cumulative operating time.	
[LAMP2]	Displays the details of cumulative operating time.	
[NUMBER OF ENTRY SIGNAL]	Displays the number of registered signals.	
[REMOTE2 STATUS]	Displays the control status of the REMOTE2.	
[SIGNAL INFORMATION]	[MEMORY NO.]	Displays the memory number of the input signal.
	[INPUT]	Displays the input terminal currently selected.
	[SIGNAL NAME]	Displays the input signal name.
	[SIGNAL FREQUENCY]	Displays the frequency of the input signal.
	[SYNC.STATE]	Displays the synch polarity of the input signal.
	[V.SYNC WIDTH]	Displays the vertical sync signal pulse width of the input signal.
	[SCAN TYPE]	Displays the scan type of the input signal.
	[TOTAL DOTS]	Displays the total dot count of the input signal.
	[DISPLAY DOTS]	Displays the number of input signal display dots.
	[TOTAL LINES]	Displays the total line count of the input signal.
	[DISPLAY LINES]	Displays the number of input signal display lines.
[SAMPLING]	Displays the sampling information of the input signal.	

\* Displays the actual time for the hours used of lamp.  
To calculate a rough guide for lamp replacement, convert as follows:

Lamp replacement time =  
Cumulative operating time when [LAMP POWER] is set to [NORMAL] + (Cumulative operating time when [LAMP POWER] is set to [ECO] x 5/6)

## Note

- The content of status can be sent via E-mail by pressing the <ENTER> button while displaying the status.
- Some items in [SIGNAL INFORMATION] may be displayed and others not displayed, depending on the signal being input.
- The “lighting time” and “usage time” of the lamp displayed in [STATUS] may differ from the actual time if the lamp unit that has been used on other models than this projector (PT-DW640U/PT-DX610U) is attached and used on the projector, or if the lamp unit that has been used on this projector (PT-DW640U/PT-DX610U) is attached and used on other projector models.

## [NO SIGNAL SHUT-OFF]

You can set the power of the projector automatically to standby if there is no input signal by the specified time.

- 1) Press ▲▼ to select [NO SIGNAL SHUT-OFF].
- 2) Press ◀▶ to switch [NO SIGNAL SHUT-OFF].

### ■ [NO SIGNAL SHUT-OFF]

[DISABLE]	Disables the No signal shut-off function.
[10MIN.] - [90MIN.]	Allows you to set in ten minutes intervals.

## [FUNCTION BUTTON]

Set the functions of the <FUNCTION> button on the remote control.

- 1) Press ▲▼ to select [FUNCTION BUTTON].
- 2) Press the <ENTER> button.
  - The [FUNCTION BUTTON] screen is displayed.
- 3) Press ▲▼ to select a function.
- 4) Press the <ENTER> button.

### ■ Available functions

[DISABLE]	Disables the <FUNCTION> button.
-----------	---------------------------------

[SUB MEMORY]	Switches the sub memory. (➔ page 87)
[SYSTEM SELECTOR]	Switches the [SYSTEM SELECTOR] setting. (➔ page 59)
[SYSTEM DAYLIGHT VIEW]	Switches the [SYSTEM DAYLIGHT VIEW] setting. (➔ page 57)
[FREEZE]	Temporarily freezes video to be a still image. (➔ page 73)
[SIDE BY SIDE]*	Switches to the two window display. (➔ page 73)

\* Only for PT-DW640U

## [DATE AND TIME]

Set the time zone, date, and time of the built-in clock of the projector.

### To set time zone

- 1) Press ▲▼ to select [DATE AND TIME].
- 2) Press the <ENTER> button.
  - The [DATE AND TIME] screen is displayed.
- 3) Press ▲▼ to select [TIME ZONE].
- 4) Press ◀▶ to switch [TIME ZONE].

### To set the date and time manually

- 1) Press ▲▼ to select [DATE AND TIME].
- 2) Press the <ENTER> button.
  - The [DATE AND TIME] screen is displayed.
- 3) Press ▲▼ to select [ADJUST CLOCK].
- 4) Press the <ENTER> button.
  - The [ADJUST CLOCK] screen is displayed.
- 5) Press ▲▼ to select an item, and press ◀▶ to set the local date and time.
- 6) Press ▲▼ to select [APPLY], and press the <ENTER> button.
  - The setting of the time will be completed.

### To set the date and time automatically

- 1) Press ▲▼ to select [DATE AND TIME].
- 2) Press the <ENTER> button.
  - The [DATE AND TIME] screen is displayed.
- 3) Press ▲▼ to select [ADJUST CLOCK].
- 4) Press the <ENTER> button.
  - The [ADJUST CLOCK] screen is displayed.
- 5) Press ▲▼ to select [NTP SYNCHRONIZATION], and press ◀▶ to change the setting to [ON].
  - The setting will change between [ON] and [OFF] each time you press the button.
- 6) Press ▲▼ to select [APPLY], and press the <ENTER> button.
  - The setting of the time will be completed.

### ■ [NTP SYNCHRONIZATION]

[ON]	Enables [NTP SYNCHRONIZATION].
[OFF]	Disables [NTP SYNCHRONIZATION].

#### Note

- To set the date and time automatically, the projector must be connected to the network.
- If synchronization with the NTP server fails just after [NTP SYNCHRONIZATION] is turned [ON], or if [NTP SYNCHRONIZATION] is turned [ON] while the NTP server is not set, [NTP SYNCHRONIZATION] will return to [OFF].
- Access the projector via a web browser to set the NTP server. Refer to “[Adjust clock] page” (➔ page 99) for details.

## [SAVE ALL USER DATA]

Save the various setting values as a backup in the built-in memory of the projector.

- 1) Press ▲▼ to select [SAVE ALL USER DATA].
- 2) Press the <ENTER> button.
  - The [SECURITY PASSWORD] screen is displayed.
- 3) Enter a security password and press the <ENTER> button.
- 4) When the confirmation is displayed, select [OK] or [CANCEL], and press the <ENTER> button.
  - [PROGRESS] is displayed while saving data.

**Note**

- The image setting registered in [USER LOGO] is not saved.

**[LOAD ALL USER DATA]**

Load the various setting values saved as a backup in the built-in memory of the projector.

- 1) Press ▲▼ to select [LOAD ALL USER DATA].
- 2) Press the <ENTER> button.
  - The [SECURITY PASSWORD] screen is displayed.
- 3) Enter a security password and press the <ENTER> button.
- 4) When the confirmation is displayed, select [OK] or [CANCEL], and press the <ENTER> button.

**Note**

- The projector will go into the standby status to reflect the setting values when [LOAD ALL USER DATA] is executed.

**[INITIALIZE]**

Return various setting values to their factory default settings.

- 1) Press ▲▼ to select [INITIALIZE].
- 2) Press the <ENTER> button.
  - The [SECURITY PASSWORD] screen is displayed.
- 3) Enter a security password and press the <ENTER> button.
  - The [INITIALIZE] screen is displayed.
- 4) Press ▲▼ to select an item to initialize.
- 5) Press the <ENTER> button.
- 6) When the confirmation is displayed, select [OK] or [CANCEL], and press the <ENTER> button.

**■ Items that can be initialized**

[ALL USER DATA]	All setting items including [ENTRY SIGNAL], [NETWORK SETUP], [E-mail set up], and [USER LOGO] are returned to factory default values. The projector will go into the standby status to reflect the setting values.
[ENTRY SIGNAL]	Deletes all the setting values saved for each input signal. To delete only a part of a registered signal, perform the procedure described in "Deleting the registered data" (➔ page 86).
[NETWORK/E-MAIL]	Returns [NETWORK SETUP] and [E-mail set up] to factory default settings.
[LOGO IMAGE]	Deletes the image registered in [USER LOGO].

**[SERVICE PASSWORD]**

Used by a service person.

## [TEST PATTERN] menu

Select [TEST PATTERN] from the main menu.

Refer to “Navigating through the menu” (➔ page 51) for the operation of the menu screen.

- Press ◀▶ to switch.

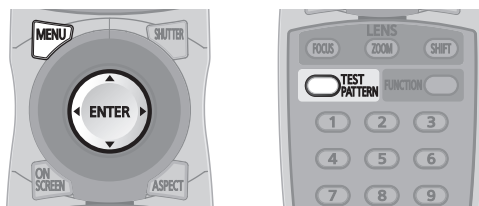

### [TEST PATTERN]

Displays the test pattern built-in to the projector.

Settings of position, size, and other factors will not be reflected in test patterns. Make sure to display the input signal before performing various adjustments.

#### 1) Press ◀▶ to switch [TEST PATTERN].

- The setting will change among “Menu screen + Focus”, “Menu screen + Entry screen\*”, “Menu screen + All white”, “Menu screen + All black”, “Menu screen + Flag”, “Menu screen + Flag (inversion)”, “Menu screen + Window”, “Menu screen + Window (inversion)”, “Menu screen + Color bar (vertical)”, and “Menu screen + Color bar (horizontal)” each time you press the button.

\* The test pattern built-in to the projector is not being displayed.

#### ■ [TEST PATTERN]

Menu screen + Focus	Displays a test pattern with the menu screen. Select a test pattern so that it is easy to make various adjustments.
Menu screen + Entry screen	
Menu screen + All white	
Menu screen + All black	
Menu screen + Flag	
Menu screen + Flag (inversion)	
Menu screen + Window	
Menu screen + Window (inversion)	
Menu screen + Color bar (vertical)	
Menu screen + Color bar (horizontal)	

#### Note

- Press the <ON SCREEN> button on the remote control while the test pattern is displayed to hide the menu screen.

## [SIGNAL LIST] menu

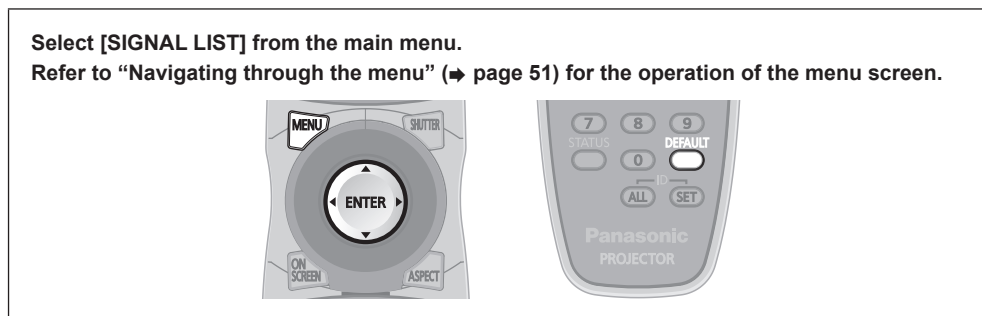

### ■ Registered signal status

- A name can be set for each sub memory (➔ page 87).
- Memory number:

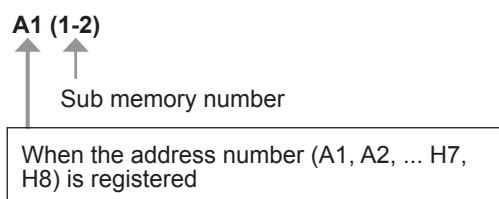

### Registering a signal to the list

After a new signal is input and the <MENU> button on the remote control or the control panel is pressed, the registration is completed and the [MAIN MENU] screen is displayed.

#### Note

- Up to 96 signals, including sub memories, can be registered to the projector.
- There are 12 pages (eight memories of A through L, with eight memories possible on each page) for memory numbers, and it is registered to the lowest number that is available. If there is no available memory number it will be overwritten from the oldest signal.
- The names to be registered are automatically determined by the input signals and memory numbers.
- If a menu is being displayed, the new signals will be registered at the instant they are input.

### Renaming the registered data

Registered signals can be renamed.

- 1) Press ▲▼◀▶ to select the signal for which details are to be displayed.
- 2) Press the <ENTER> button.
  - The [REGISTERED SIGNAL STATUS] screen is displayed.
  - The memory number, input terminal, input signal name, frequency, synchronization signal, etc., are displayed.
  - Press the <MENU> button to return to the [REGISTERED SIGNAL LIST] screen.
- 3) Press the <ENTER> button.
  - The [REGISTERED SIGNAL SETUP] screen is displayed.
- 4) Press ▲▼ to select [SIGNAL NAME CHANGE].
- 5) Press the <ENTER> button.
  - The [SIGNAL NAME CHANGE] screen is displayed.
- 6) Press ▲▼◀▶ to select the text, and press the <ENTER> button to enter the text.
- 7) After the name is changed, press ▲▼◀▶ to select [OK], and press the <ENTER> button.
  - The registration is completed and it will return to the [REGISTERED SIGNAL SETUP] screen.
  - When pressing ▲▼◀▶ to select [CANCEL] and pressing the <ENTER> button, the changed signal name will not be registered and an automatically registered signal name will be used.

### Deleting the registered data

Registered signals can be deleted.

- 1) Press ▲▼◀▶ to select the signal to delete.
- 2) Press the <DEFAULT> button.
  - The [ENTRY SIGNAL DELETE] screen is displayed.
  - To cancel the deletion, press the <MENU> button to return to the [REGISTERED SIGNAL LIST] screen.
- 3) Press the <ENTER> button.
  - The selected signal will be deleted.

**Note**

- A signal can also be deleted from [ENTRY SIGNAL DELETE] on the [REGISTERED SIGNAL SETUP] screen.

**Protecting the registered data**

Registered signals can be protected.

- 1) Press ▲▼◀▶ to select the signal to protect.
- 2) Press the <ENTER> button.
  - The [REGISTERED SIGNAL STATUS] screen is displayed.
- 3) Press the <ENTER> button.
  - The [REGISTERED SIGNAL SETUP] screen is displayed.
- 4) Press ▲▼ to select [LOCK].
- 5) Press ◀▶ to switch [LOCK].
  - The setting will change between [OFF] and [ON] each time you press the button.

**■ [LOCK]**

[OFF]	The signal is not protected.
[ON]	The signal is protected.

**Note**

- When [LOCK] is set to [ON], signal delete, image adjustment and auto setup are not available. To perform these operations, set [LOCK] to [OFF].
- A signal can be registered to sub memory even if it is protected.
- Even a protected signal will be deleted if [INITIALIZE] is executed.

**Expanding signal lock-in range**

Signal lock-in range can be expanded.

- 1) Press ▲▼◀▶ to select the signal to set.
- 2) Press the <ENTER> button.
  - The [REGISTERED SIGNAL STATUS] screen is displayed.
- 3) Press the <ENTER> button.
  - The [REGISTERED SIGNAL SETUP] screen is displayed.
- 4) Press ▲▼ to select [LOCK-IN RANGE].
- 5) Press ◀▶ to switch [LOCK-IN RANGE].
  - The setting will change between [NARROW] and [WIDE] each time you press the button.

**■ [LOCK-IN RANGE]**

[NARROW]	Select in most cases.
[WIDE]	Widens the lock-in range.

**Note**

- Switch the range that determines that a signal to be input is the same signal that is already registered.
- To prioritize the determination that it is the same signal that is already registered, set to the [WIDE] setting.
- Use in cases such as when the synchronizing frequency of a signal to be input has changed slightly, or multiple signal lists are registered.
- Can only be used when a signal is input from the <RGB 1 IN> terminal, <RGB 2 IN> terminal, <DVI-D IN> terminal, or <HDMI IN> terminal.
- When [WIDE] is set, the image may appear distorted because a signal is determined to be the same signal even if a synchronizing frequency changes slightly.
- When a signal to be input corresponds to the signal set in [WIDE], a registered signal with a high memory number receives priority.  
Example: A signal to be input that corresponds to memory numbers A2, A4 and B1 will be determined to be B1.
- When a registration signal is deleted, the settings are also deleted.
- In an environment where multiple types of signals are input to the same terminal, signals are sometimes not determined correctly when settings are set to [WIDE].

**Managing the sub memory list**

The projector has a sub memory function that can register the multiple image adjustment data, even if it is recognized as the same signal by the frequency or format of the synchronization signal source.

Use this function when you need to adjust the picture quality such as switching of the aspect ratio or white balance by the same synchronization signal source. The sub memory includes all the data that can be adjusted for each signal, such as the screen aspect ratio and data adjusted in the [PICTURE] item ([CONTRAST], [BRIGHTNESS], etc.).

**To register the current settings to the list**

- 1) Press ◀▶ on the normal screen (when the menu is not displayed).
  - The sub memory registration screen is displayed if the sub memory is not registered. Proceed to Step 3).
  - A list of sub memories registered to the signal currently input is displayed.
  - When [SUB MEMORY] is selected with [PROJECTOR SETUP] → [FUNCTION BUTTON] on the menu, the <FUNCTION> button can be used instead of ◀▶.
- 2) Press ▲▼◀▶ to select the sub memory number to register in [SUB MEMORY LIST].
- 3) Press the <ENTER> button.
  - The [SIGNAL NAME CHANGE] screen is displayed.
- 4) Press ▲▼◀▶ to select [OK], and press the <ENTER> button.
  - To rename the registered data, follow the procedure in Steps 4) and 5) in "Renaming the registered data" (➔ page 86).

**To switch to the sub memory list**

- 1) Press ◀▶ on the normal screen (when the menu is not displayed).
  - A list of sub memories registered to the signal currently input is displayed.
- 2) Press ▲▼◀▶ to select the signal to switch in [SUB MEMORY LIST].
- 3) Press the <ENTER> button.
  - This switches to the signal selected in Step 2).

**To delete the sub memory data**

- 1) Press ◀▶ on the normal screen (when the menu is not displayed).
  - The [SUB MEMORY LIST] screen is displayed.
- 2) Press ▲▼◀▶ to select the sub memory to delete, and press the <DEFAULT> button.
  - The [ENTRY SIGNAL DELETE] screen is displayed.
  - To cancel the deletion, press the <MENU> button to return to the [SUB MEMORY LIST] screen.
- 3) Press the <ENTER> button.
  - The selected sub memory will be deleted.



## [SECURITY] menu

Select [SECURITY] from the main menu, and select the item from the sub-menu.  
Refer to “Navigating through the menu” (➔ page 51) for the operation of the menu screen.

- When the projector is used for the first time  
Initial password: Press ▲▶▼◀▲▶▼◀ in order, and press the <ENTER> button.
- After selecting the item, press ▲▶◀▶ to set.

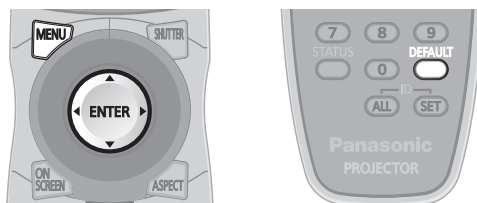

### Attention

- When you select the [SECURITY] from the main menu and press the <ENTER> button, entering a password is required. Enter the set password and then continue operations of the [SECURITY] menu.
- When the password has been changed previously, enter the changed password, and press the <ENTER> button.

### Note

- The entered password is displayed with \* mark on the screen.

## [SECURITY PASSWORD]

The [SECURITY PASSWORD] screen is displayed when the power is turned on. When the entered password is incorrect, the operation will be restricted to the power standby <⏻> button, the <SHUTTER> button, and the <LENS> (<FOCUS>, <ZOOM>, and <SHIFT>) buttons.

- 1) Press ▲▼ to select [SECURITY PASSWORD].
- 2) Press ◀▶ to switch [SECURITY PASSWORD].
  - The setting will change between [OFF] and [ON] each time you press the button.

### ■ [SECURITY PASSWORD]

[OFF]	Disables the security password entry.
[ON]	Enables the security password entry.

### Note

- The [SECURITY PASSWORD] setting is set to [OFF] at the time of purchase or when all the user data has been initialized.
- Change the password periodically that is hard to guess.
- The security password will be enabled after setting [SECURITY PASSWORD] to [ON] and turning the <MAIN POWER> switch to <OFF>.

## [SECURITY PASSWORD CHANGE]

Change the security password.

- 1) Press ▲▼ to select [SECURITY PASSWORD CHANGE].
- 2) Press the <ENTER> button.
  - The [SECURITY PASSWORD CHANGE] screen is displayed.
- 3) Press ▲▶▼◀▶ and the number (<0> to <9>) buttons to set the password.
  - Up to eight button operations can be set.
- 4) Press the <ENTER> button.
- 5) Re-enter the password for the confirmation.
- 6) Press the <ENTER> button.

### Note

- The entered password is displayed with \* mark on the screen.
- An error message is displayed on the screen when the entered password is incorrect. Re-enter the correct password.

## [DISPLAY SETTING]

Overlap the security message (text or image) over the projecting image.

- 1) Press ▲▼ to select [DISPLAY SETTING].

**2) Press ◀▶ to switch [DISPLAY SETTING].**

- The setting will change among [OFF], [TEXT], and [USER LOGO] each time you press the button.

**■ [DISPLAY SETTING]**

[OFF]	The text display is disabled.
[TEXT]	The text display is enabled.
[USER LOGO]	The picture registered by the user is projected.

**Note**

- To create the image for [USER LOGO], "Logo Transfer Software" included in the supplied CD-ROM is required.

**[TEXT CHANGE]**

Change the text displayed when the text display is enabled by selecting [TEXT] in [DISPLAY SETTING].

**1) Press ▲▼ to select [TEXT CHANGE].****2) Press the <ENTER> button.**

- The [TEXT CHANGE] screen is displayed.

**3) Press ▲▼◀▶ to select the text, and press the <ENTER> button to enter the text.**

- Maximum 22 characters can be input.

**4) Press ▲▼◀▶ to select [OK], and press the <ENTER> button.**

- The text is changed.

**[MENU LOCK]**

Display the menu with the <MENU> button, and set whether to enable menu operations.

**1) Press ▲▼ to select [MENU LOCK].****2) Press ◀▶ to switch [MENU LOCK].**

- The setting will change between [OFF] and [ON] each time you press the button.

**■ [MENU LOCK]**

[OFF]	Cancels the lock on menu operations.
[ON]	Locks menu operations.

**Note**

- After setting [MENU LOCK] to [ON], if the wrong password is input, the <MENU> button cannot be operated.
- At the time of purchase or after [ALL USER DATA] initialization, [MENU LOCK] is set to [OFF].
- The lock release is maintained until the projector enters standby.

**[MENU LOCK PASSWORD]**

Change the menu lock password.

**1) Press ▲▼ to select [MENU LOCK PASSWORD].****2) Press the <ENTER> button.**

- The [MENU LOCK PASSWORD] screen is displayed.

**3) Press ▲▼◀▶ to select the text, and press the <ENTER> button to enter the text.**

- Maximum 16 characters can be input.

**4) Press ▲▼◀▶ to select [OK] and press the <ENTER> button.**

- To cancel, select [CANCEL].

**Attention**

- The initial password when used for the first time or after initializing all the user data is "AAAA".
- Change the password periodically that is hard to guess.

**[CONTROL DEVICE SETUP]**

Enable/disable the button operations on the control panel and the remote control.

**1) Press ▲▼ to select [CONTROL DEVICE SETUP].****2) Press the <ENTER> button.**

- The [CONTROL DEVICE SETUP] screen is displayed.

- 3) Press ▲▼ to select [CONTROL PANEL] or [REMOTE CONTROL].
- 4) Press the <ENTER> button.
  - The [CONTROL PANEL] screen or the [REMOTE CONTROL] screen is displayed.
- 5) Press ▲▼ to select an item, and press the <ENTER> button.
- 6) When the confirmation is displayed, select [OK] or [CANCEL], and press the <ENTER> button.

#### ■ [CONTROL PANEL] and [REMOTE CONTROL]

- You can set the limitation on the control from the control panel and remote control.

[ENABLE]	Enables all button operations on the projector body and remote control.
[DISABLE]	Disables all button operations on the projector body and remote control.

#### Note

- When a button operation is performed on the device set to [DISABLE], the [SECURITY PASSWORD] screen is displayed. Enter the security password.
- The [SECURITY PASSWORD] screen will disappear when the <MENU> button is pressed, or when there is no operation for approximately ten seconds.
- If the operations of both [CONTROL PANEL] and [REMOTE CONTROL] are set to [DISABLE], the projector cannot be turned off (cannot enter standby).
- When the setting has completed, the menu screen will disappear. To operate continuously, press the <MENU> button to display the main menu.

## [NETWORK] menu

Select [NETWORK] from the main menu, and select the item from the sub-menu.  
Refer to “Navigating through the menu” (➔ page 51) for the operation of the menu screen.

- After selecting the item, press ▲▼◀▶ to set.

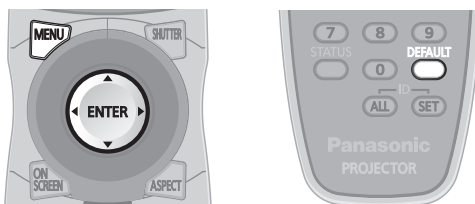

### [NETWORK SETUP]

Perform the initial setting of the network before using the network function.

- 1) Press ▲▼ to select [NETWORK SETUP].
- 2) Press the <ENTER> button.
  - The [NETWORK SETUP] screen is displayed.
- 3) Press ▲▼ to select an item, and change the settings according to the operation instructions of the menu.
- 4) Press ▲▼ to select [STORE], and press the <ENTER> button.
- 5) When the confirmation is displayed, select [OK] or [CANCEL], and press the <ENTER> button.

#### ■ [NETWORK SETUP]

[PROJECTOR NAME]	Change the setting when using a DHCP server.
[DHCP]	Set the item to [ON] when using a DHCP server to automatically acquire the IP address. Set to [OFF] when not using a DHCP server.
[IP ADDRESS]	Enter the IP address when not using a DHCP server.
[SUBNET MASK]	Enter the subnet mask when not using a DHCP server.
[DEFAULT GATEWAY]	Enter the default gateway address when not using a DHCP server.
[STORE]	Save the current network settings.

#### Note

- When using a DHCP server, confirm that the DHCP server is running.
- Consult your network administrator regarding the IP address, subnet mask, and default gateway.

### [NETWORK CONTROL]

Set up the control method of the network.

- 1) Press ▲▼ to select [NETWORK CONTROL].
- 2) Press the <ENTER> button.
  - The [NETWORK CONTROL] screen is displayed.
- 3) Press ▲▼ to select an item, then press ◀▶ to change the setting.
- 4) Press ▲▼ to select [STORE], and press the <ENTER> button.
- 5) When the confirmation is displayed, select [OK] or [CANCEL], and press the <ENTER> button.

## ■ [NETWORK CONTROL]

[WEB CONTROL]	Set to [ON] to control with the Web browser.
[PJLink CONTROL]	Set to [ON] to control with the PJLink protocol.
[COMMAND CONTROL]	Set to [ON] to control with the <SERIAL IN>/<SERIAL OUT> terminal control command format (➔ page 123). Refer to "Control commands via LAN" (➔ page 119).
[COMMAND PORT]	Set the port number used for command control.
[CRESTRON RoomView]	Set to [ON] to control with RoomView of Crestron.
[AMX D.D.]	Set to [ON] to control with the controller of AMX.
[STORE]	Save the current network control settings.

## [NETWORK STATUS]

Displays the status of the projector network.

1) Press ▲▼ to select [NETWORK STATUS].

2) Press the <ENTER> button.

- The [NETWORK STATUS] screen is displayed.

## Network connections

The projector has a network function, and the following operations are available from the computer using the Web control.

- Setting and adjustment of the projector
- Display of the projector status
- Sending of E-mail messages when there is a problem with the projector

"Crestron RoomView" is a system of Crestron Electronics, Inc. that manages and controls devices on multiple systems connected to a network collectively with a computer.

The projector supports the following application software of Crestron Electronics, Inc.

– RoomView Express

– Fusion RV

– RoomView Server Edition

- For details of "Crestron RoomView", refer to the website of Crestron Electronics, Inc. (English only)

URL <http://www.crestron.com>

For the download of "RoomView Express", also refer to the website of Crestron Electronics, Inc. (English only)

URL <http://www.crestron.com/getroomview>

### Attention

- Connect the LAN to indoor devices.

### Note

- A LAN cable is required to use the network function.

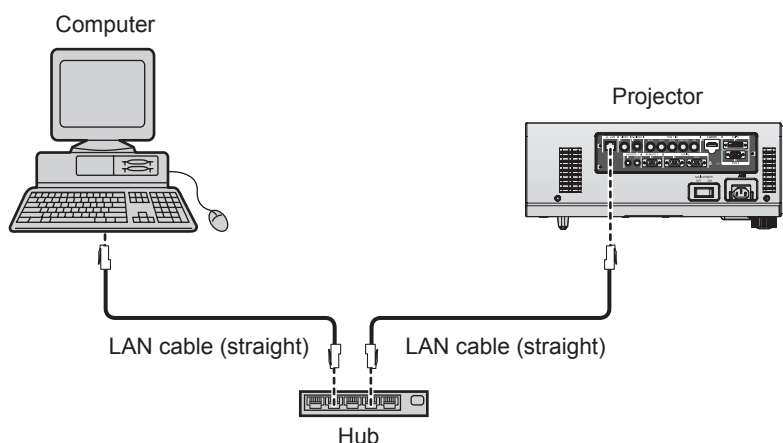

- A Web browser is required to use this function. Confirm that the Web browser can be used beforehand.  
Compatible OS: Windows XP/Windows Vista/Windows 7, Mac OS X v10.4/v10.5/v10.6/v10.7  
Compatible browser: Internet Explorer 7.0/8.0/9.0, Safari 4.0/5.0 (Mac OS)
- Communication with an E-mail server is required to use the E-mail function. Confirm that the E-mail can be used beforehand.
- Use a LAN cable that is straight-through and compatible with category 5 or higher.
- Use a LAN cable of 100 m (328'1") or shorter length.

## Name and function of network function parts

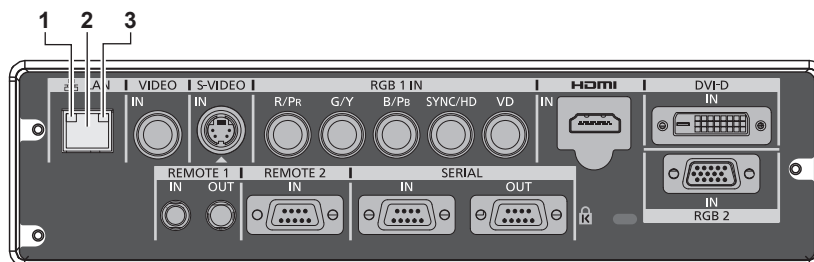

- |  |   |
|--|---|
| <p><b>1 LAN10/100 lamp (yellow)</b><br/>Lights on when connected to the 100BASE-TX.</p> <p><b>2 &lt;LAN&gt; terminal (10BASE-T/100BASE-TX)</b><br/>Used to connect the LAN cable here.</p> | <p><b>3 LAN LINK/ACT lamp (green)</b><br/>Lights on when connected.<br/>Flashes when transmitting/receiving data.</p> |
|--|---|

## Accessing from the Web browser

- 1) Start up the Web browser on the computer.
- 2) Enter the IP address set on the projector into the URL entry field of the Web browser.
- 3) Enter the user name and the password.
  - The factory default setting of the user name is user1 (user rights)/admin1 (administrator rights) and the password is panasonic (lower case).
- 4) Click OK.
  - The [Projector status] page is displayed.

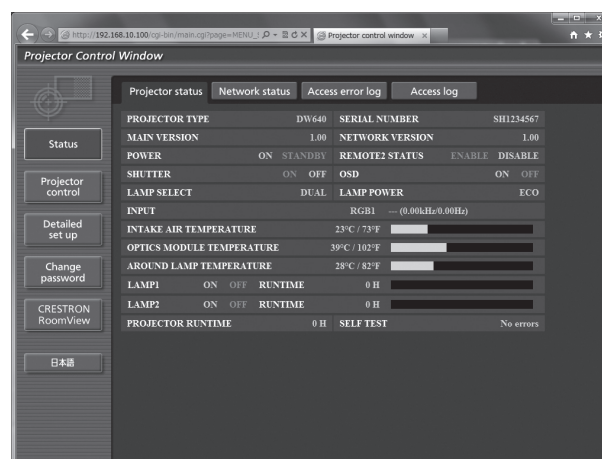
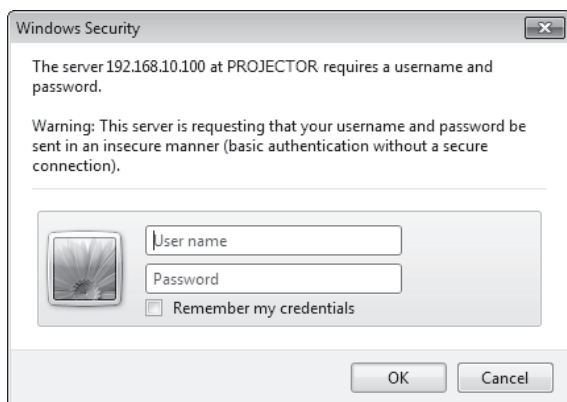

## Note

- If you use a Web browser to control the projector, set [WEB CONTROL] to [ON] in [NETWORK CONTROL] (➡ page 92).
- Do not perform setting or control simultaneously by starting up multiple Web browsers. Do not set or control the projector from multiple computers.
- Change the password first. (➡ page 104)
- The administrator rights allows to use all functions. The user rights allow use of [Projector status] (➡ page 95), confirmation of the error information page (➡ page 96), [Network status] (➡ page 97), [Basic control] (➡ page 98), and [Change password] (➡ page 104) only.
- Access will be locked for few minutes when an incorrect password is entered three times consecutively.

Descriptions of items

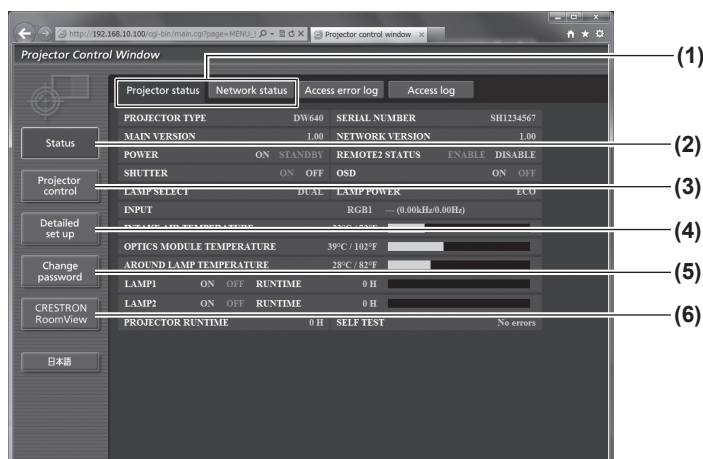

- |   |  |
|---|--|
| <p>1 <b>Page tab</b><br/>Switches pages by clicking it.</p> <p>2 <b>[Status]</b><br/>The status of the projector is displayed by clicking this item.</p> <p>3 <b>[Projector control]</b><br/>The [Projector control] page is displayed by clicking this item.</p> | <p>4 <b>[Detailed set up]</b><br/>The [Detailed set up] page is displayed by clicking this item.</p> <p>5 <b>[Change password]</b><br/>The [Change password] page is displayed by clicking this item.</p> <p>6 <b>[CRESTRON RoomView]</b><br/>The control page of RoomView is displayed by clicking this item.</p> |
|---|--|

**[Projector status] page**

Click [Status] → [Projector status].  
Displays the status of the projector for the following items.

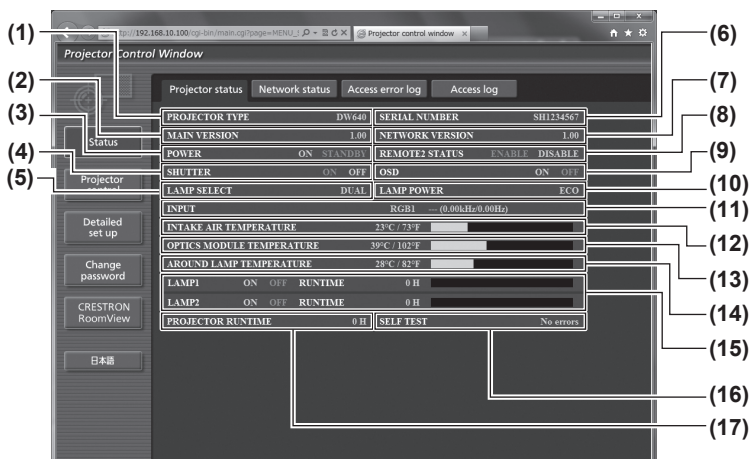

- |   |  |
|---|--|
| <p>1 <b>[PROJECTOR TYPE]</b><br/>Displays the type of the projector.</p> <p>2 <b>[MAIN VERSION]</b><br/>Displays the firmware version of the projector.</p> <p>3 <b>[POWER]</b><br/>Displays the status of the power.</p> <p>4 <b>[SHUTTER]</b><br/>Displays the status of the projector.</p> <p>5 <b>[LAMP SELECT]</b><br/>Displays the setting status of [LAMP SELECT] (➡ page 76).</p> <p>6 <b>[SERIAL NUMBER]</b><br/>Displays the serial number of the projector.</p> <p>7 <b>[NETWORK VERSION]</b><br/>Displays the version of the firmware of the network.</p> <p>8 <b>[REMOTE2 STATUS]</b><br/>Displays the control status of the &lt;REMOTE 2 IN&gt; terminal.</p> <p>9 <b>[OSD]</b><br/>Displays the status of the on-screen display.</p> <p>10 <b>[LAMP POWER]</b><br/>Displays the setting status of [LAMP POWER] (➡ page 77).</p> <p>11 <b>[INPUT]</b><br/>Displays the status of the input selection.</p> | <p>12 <b>[INTAKE AIR TEMPERATURE]</b><br/>Displays the status of the air intake temperature of the projector.</p> <p>13 <b>[OPTICS MODULE TEMPERATURE]</b><br/>Displays the status of the internal temperature of the projector.</p> <p>14 <b>[AROUND LAMP TEMPERATURE]</b><br/>Displays the status of the temperature around the lamp of the projector.</p> <p>15 <b>[LAMP1][LAMP2][RUNTIME]</b><br/>Displays the status and the cumulative operating time (converted value) of the lamp.</p> <p>16 <b>[SELF TEST]</b><br/>Displays the self-diagnosis information.</p> <p>17 <b>[PROJECTOR RUNTIME]</b><br/>Displays the operation times of the projector.</p> |
|---|--|

**Error information page**

When [Error (Detail)] is displayed in the self-diagnosis display of the [Projector status] screen, click it to display the error details.

- The projector may go into the standby status to protect the projector depending on the contents of the error.

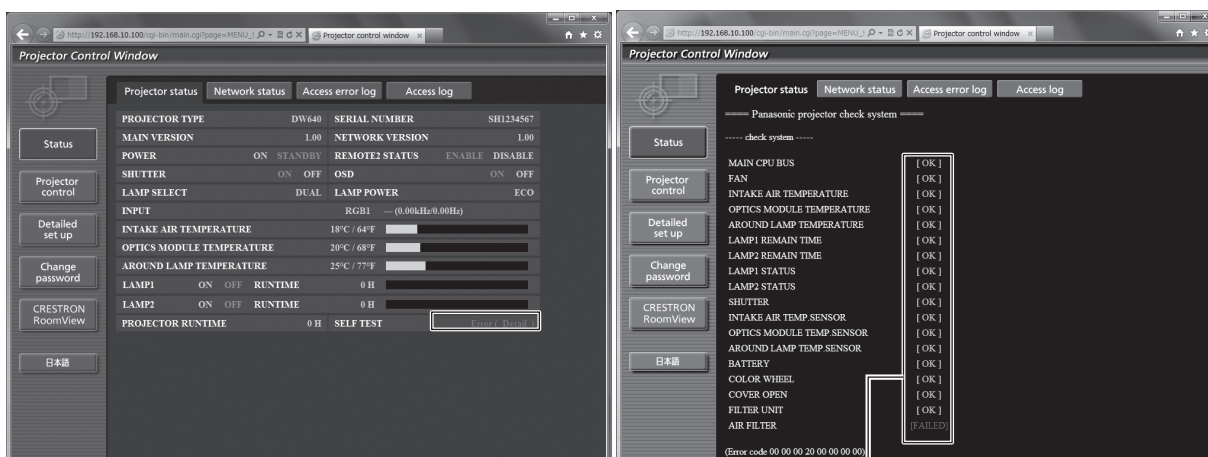

[OK]: operating properly  
 [FAILED]: a problem occurred  
 [WARNING]: warning

**■ Problem occurrence [FAILED]**

Parameter	Description
[MAIN CPU BUS]	There is a problem with the microcomputer circuitry. Consult your dealer.
[FAN]	There is a problem with the fan or the fan drive circuit. Consult your dealer.
[INTAKE AIR TEMPERATURE]	The air intake temperature is too high. It may be used in an operating environment where the temperature is high, such as near a heating appliance.
[OPTICS MODULE TEMPERATURE]	The temperature inside the projector is high. It may be used in an operating environment where the temperature is high, such as near a heating appliance.
[AROUND LAMP TEMPERATURE]	The temperature around the lamp is high. The air exhaust port may be blocked.
[LAMP1 REMAIN TIME]	The usage time of the lamp has exceeded the specified time, and it is time to replace the lamp.
[LAMP2 REMAIN TIME]	
[LAMP1 STATUS]	The lamp has failed to turn on. Wait a while until the luminous lamp cools off, and then turn on the power.
[LAMP2 STATUS]	
[SHUTTER]	There is a problem with the shutter circuitry. Consult your dealer.
[INTAKE AIR TEMP.SENSOR]	There is a problem with the sensor used to detect intake air temperature. Consult your dealer.
[OPTICS MODULE TEMP.SENSOR]	There is a problem with the sensor used to detect temperature inside the projector. Consult your dealer.
[AROUND LAMP TEMP.SENSOR]	There is a problem with the sensor used to detect exhaust air temperature. Consult your dealer.
[BATTERY]	Battery replacement is required. Consult your dealer.
[COLOR WHEEL]	There is a problem with the color wheel or the color wheel drive circuit. Consult your dealer.
[COVER OPEN]	The lamp unit cover is not attached properly. Check the installation of the lamp unit cover. (➡ page 114)
[FILTER UNIT]	The air filter unit is not attached. Check the connection of the air filter unit. (➡ page 113)
[AIR FILTER]	There are too much dust accumulated in the air filter unit. Turn the <MAIN POWER> switch <OFF> (➡ page 43), and clean the air filter. (➡ page 112)



### [Network status] page

Click [Status] → [Network status].

The current network setting status is displayed.

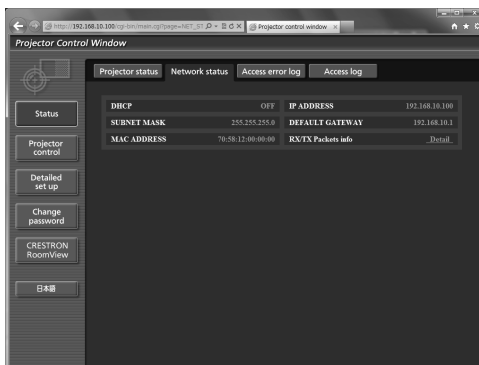

### [Access error log] page

Click [Status] → [Access error log].

The error log on the WEB server is displayed such as access to the pages that do not exist or access with unauthorized user names or passwords.

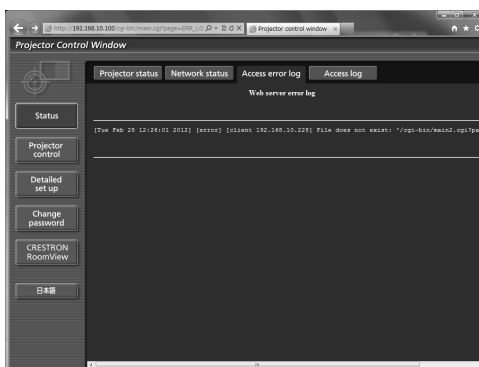

### [Access log] page

Click [Status] → [Access log].

The log such as user name accessed to the WEB control page, accessed IP address, and accessed time is displayed.

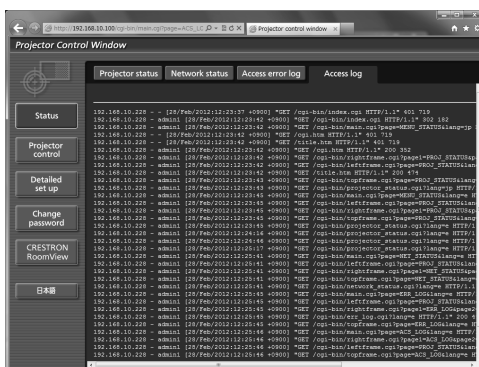

### Note

- [Access error log]/[Access log] will display the recent few thousand accesses/requests. May be unable to display all information when many accesses/requests are made at one time.
- When [Access error log]/[Access log] exceeds a certain amount, old information will be erased.
- Confirm [Access error log]/[Access log] periodically.

**[Basic control] page**

Click [Projector control] → [Basic control].

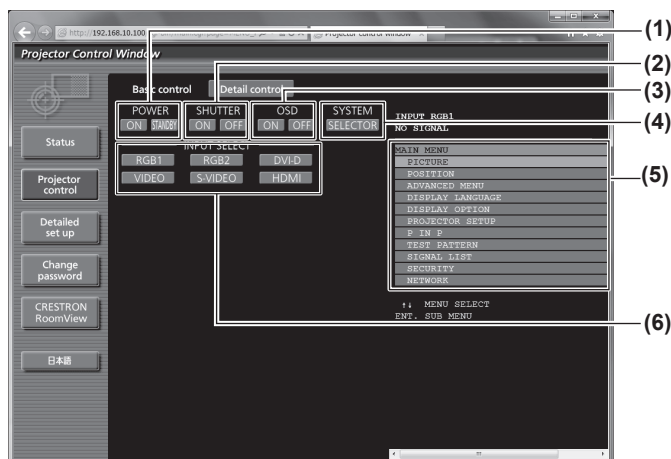

- |   |   |
|---|---|
| <p>1 <b>[POWER]</b><br/>Switches the power on/off.</p> <p>2 <b>[SHUTTER]</b><br/>Switches between use or not use of the shutter function.</p> <p>3 <b>[OSD]</b><br/>Switches between on (display)/off (no display) of the on-screen display function.</p> | <p>4 <b>[SYSTEM]</b><br/>Switches the system method.</p> <p>5 <b>On-screen display of the projector</b><br/>Displays the same content as the on-screen display of the projector. The settings of the menu can be checked or changed. This is displayed even when the on-screen display function is set to off (hide).</p> <p>6 <b>[INPUT SELECT]</b><br/>Switches the input signal.</p> |
|---|---|

**[Detail control] page**

Click [Projector control] → [Detail control].

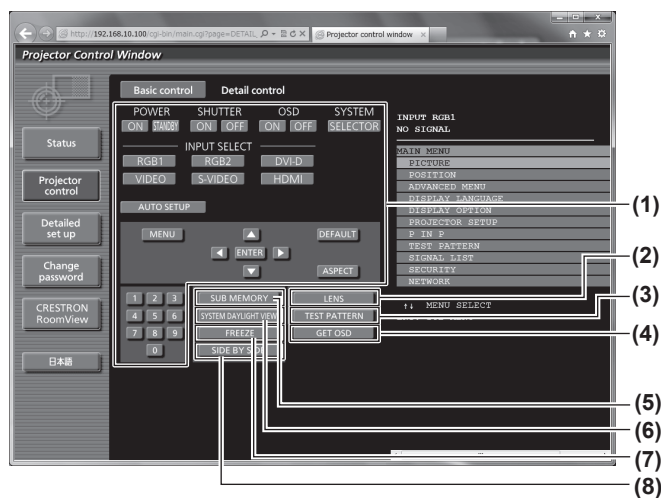

- |  |  |
|--|--|
| <p>1 <b>Control of the projector</b><br/>The projector is controlled by clicking the buttons in the same way as the buttons on the remote control. After the projector is controlled, the on-screen display of the projector on the right side of the control page is updated.</p> <p>2 <b>[LENS]</b><br/>Adjusts the projection lens.</p> <p>3 <b>[TEST PATTERN]</b><br/>Displays the test pattern.</p> | <p>4 <b>[GET OSD]</b><br/>Updates the on-screen display of the projector at the right of the control page.</p> <p>5 <b>[SUB MEMORY]</b><br/>Switches the sub memory.</p> <p>6 <b>[SYSTEM DAYLIGHT VIEW]</b><br/>Switches to system daylight view settings.</p> <p>7 <b>[FREEZE]</b><br/>Temporarily pauses the image.</p> <p>8 <b>[SIDE BY SIDE] (only for PT-DW640U)</b><br/>Displays two different input signals simultaneously.</p> |
|--|--|

**[Network config] page**

Click [Detailed set up] → [Network config].

- Click [Network config] to display the [CAUTION!] screen.
- The current settings are displayed by pressing the [Next] button.

- The following setting change screen is displayed by pressing the [Change] button.

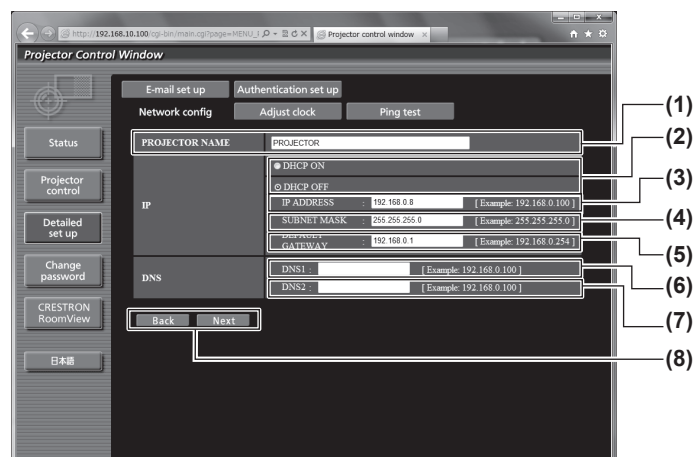

- [PROJECTOR NAME]**  
Enter the name of the projector. Also enter the host name if it is required when using a DHCP server, etc.
- [DHCP ON]/[DHCP OFF]**  
To enable the DHCP client function, set to [DHCP ON].
- [IP ADDRESS]**  
Enter the IP address when not using a DHCP server.
- [SUBNET MASK]**  
Enter the subnet mask when not using a DHCP server.
- [DEFAULT GATEWAY]**  
Enter the default gateway address when not using a DHCP server.
- [DNS1]**  
Enter the DNS1 server address.  
Permissible characters for the entry of DNS1 server address (primary):  
Numbers (0 to 9), period (.)  
(Example: 192.168.0.253)
- [DNS2]**  
Enter the DNS2 server address.  
Permissible characters for the entry of DNS2 server address (secondary):  
Numbers (0 to 9), period (.)  
(Example: 192.168.0.254)
- [Back]/[Next]**  
Click the [Back] button to return to the original screen. The current settings are displayed by pressing the [Next] button. Click the [Submit] button to update the settings.

### Note

- When you use the “Forward” and “Back” functions of your browser, a warning message “Page has Expired” may appear. In that case, click [Network config] again since the following operation will not be guaranteed.

### [Adjust clock] page

Click [Detailed set up] → [Adjust clock].

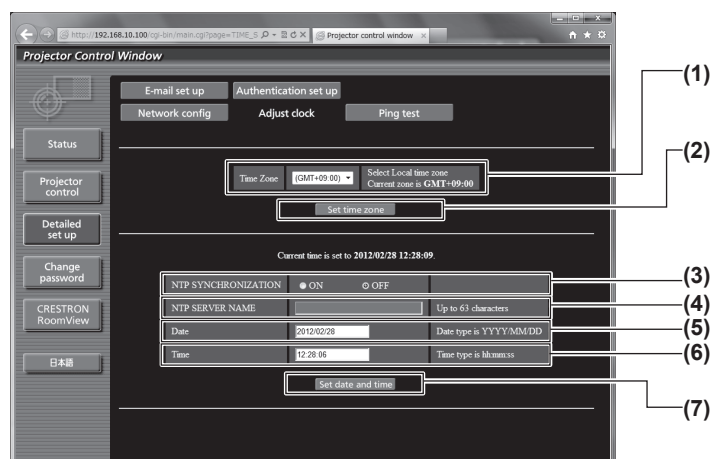

- [Time Zone]**  
Select the time zone.
- [Set time zone]**  
Updates the time zone setting.
- [NTP SYNCHRONIZATION]**  
Set to [ON] to adjust the date and time automatically.
- [NTP SERVER NAME]**  
Enter the IP address or server name of the NTP server when you set to adjust the date and time manually.  
(To enter the server name, the setup of the DNS server is required.)
- [Date]**  
Enter the date to be changed.
- [Time]**  
Enter the time to be changed.
- [Set date and time]**  
Updates the date and time settings.

**Note**

- The replacement of the battery inside the projector is required when the time goes out of alignment right after correcting the time. Please consult your dealer.

**[Ping test] page**

You can check whether the network is connected to the E-mail server, POP server, DNS server, etc.  
Click [Detailed set up] → [Ping test].

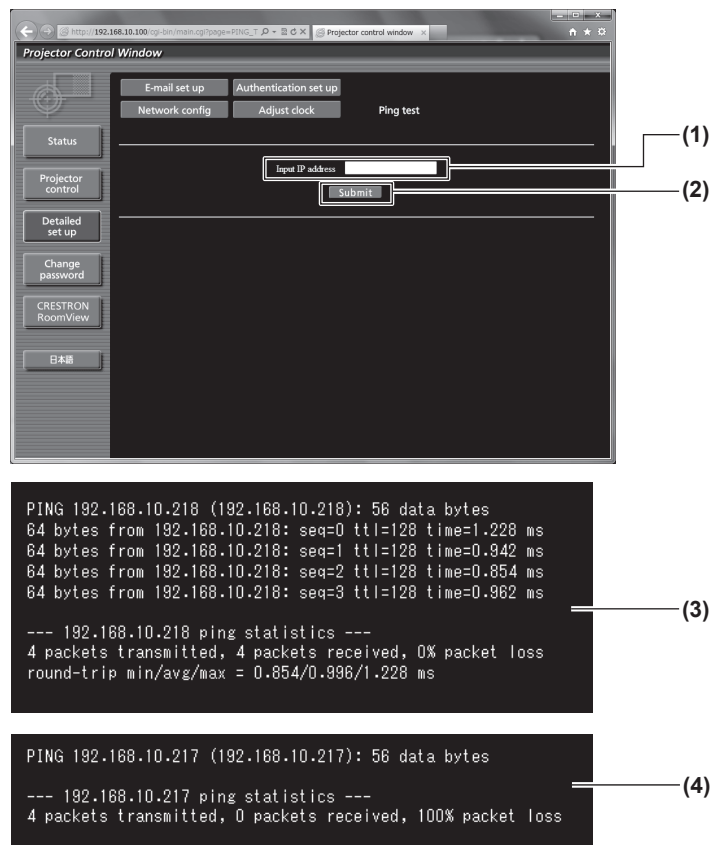

- |  |  |
|--|--|
| <p><b>1 [Input IP address]</b><br/>Enter the IP address of the server to be tested.</p> <p><b>2 [Submit]</b><br/>Executes the connection test.</p> | <p><b>3 Example of display when the connection has succeeded</b></p> <p><b>4 Example of display when the connection has failed</b></p> |
|--|--|

[E-mail set up] page

You can send E-mail to an E-mail address (maximum two addresses) set in advance when a problem occurs or the cumulative operating time of a lamp reaches a set value.

Click [Detailed set up] → [E-mail set up].

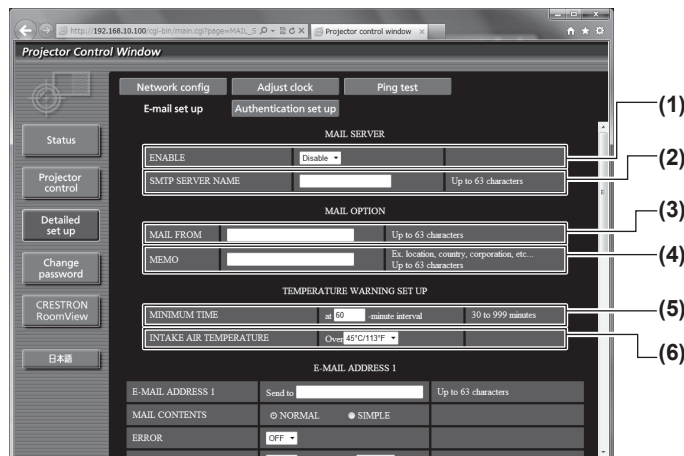

- 1 **[ENABLE]**  
Select [Enable] to use the E-mail function.
- 2 **[SMTP SERVER NAME]**  
Enter the IP address or the server name of the E-mail server (SMTP). To enter the server name, the setup of the DNS server is required.
- 3 **[MAIL FROM]**  
Enter the E-mail address of the projector. (Up to 63 characters in single byte)
- 4 **[MEMO]**  
You can enter information such as the location of the projector that notifies the sender of the E-mail. (Up to 63 characters in single byte)
- 5 **[MINIMUM TIME]**  
Change the minimum interval for the temperature warning mail. The default value is 60 minutes. In this case, another E-mail will not be sent for 60 minutes after sending the temperature warning mail even if it reaches the warning temperature.
- 6 **[INTAKE AIR TEMPERATURE]**  
Change the temperature setting for the temperature warning mail. A temperature warning mail is sent when the temperature exceeds this value.

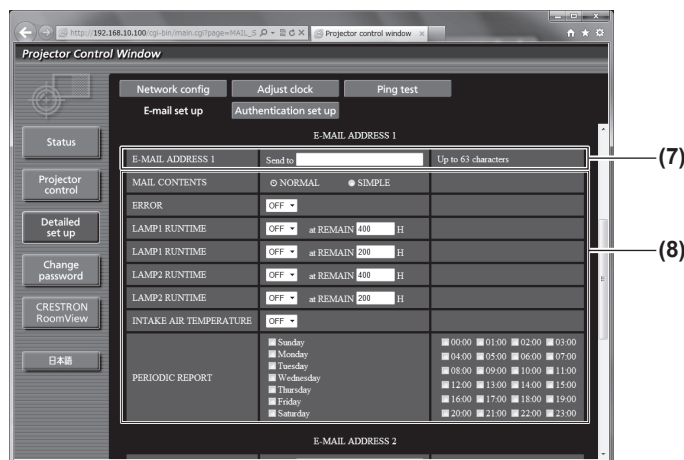

- 7 **[E-MAIL ADDRESS 1]**  
Enter the E-mail address to be sent.
  - 8 **Settings of the conditions to send E-mail**  
Select the conditions to send E-mail.  
**[MAIL CONTENTS]:**  
Select either [NORMAL] or [SIMPLE].  
**[ERROR]:**  
An E-mail message is sent when an error occurred in the self-diagnosis.  
**[LAMP1 RUNTIME]:**  
An E-mail message is sent when the remaining lamp on time for the lamp 1 has reached the value set at the right field.  
**[LAMP2 RUNTIME]:**  
An E-mail message is sent when the remaining lamp on time for the lamp 2 has reached the value set at the right field.  
**[INTAKE AIR TEMPERATURE]:**  
An E-mail message is sent when the air intake temperature has reached the value set at the above field.
- [PERIODIC REPORT]:**  
Place a check mark on this when E-mail is to be sent periodically. It will be sent on the days and time with the check mark.

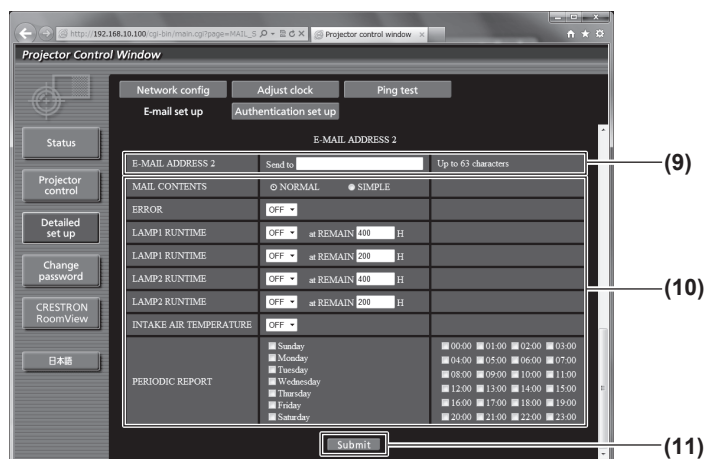

**9 [E-MAIL ADDRESS 2]**

Enter the E-mail address to be sent when two E-mail addresses are to be used.  
Leave it blank when two E-mail addresses are not to be used.

**10 Settings of the conditions to send E-mail**

Select the conditions to send E-mail to the second E-mail address.

**[MAIL CONTENTS]:**

Select either [NORMAL] or [SIMPLE].

**[ERROR]:**

An E-mail message is sent when an error occurred in the self-diagnosis.

**[LAMP1 RUNTIME]:**

An E-mail message is sent when the remaining lamp on time for the lamp 1 has reached the value set at the right field.

**[LAMP2 RUNTIME]:**

An E-mail message is sent when the remaining lamp on time for the lamp 2 has reached the value set at the right field.

**[INTAKE AIR TEMPERATURE]:**

An E-mail message is sent when the air intake temperature has reached the value set at the above field.

**[PERIODIC REPORT]:**

Place a check mark on this to send E-mail to the second E-mail address periodically. It will be sent on the days and time with the check mark.

**11 [Submit]**

Update the settings.

**[Authentication set up] page**

You can set the authentication items when POP authentication or SMTP authentication is necessary to send an E-mail message. Click [Detailed set up] → [Authentication set up].

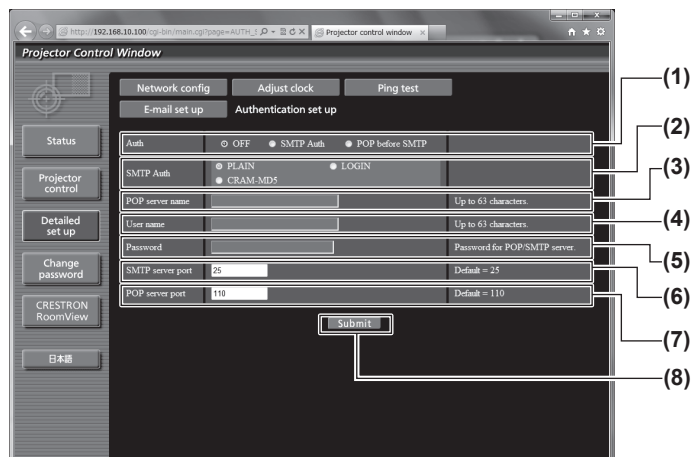

**1 [Auth]**

Select the authentication method specified by your Internet service provider.

**2 [SMTP Auth]**

Set when the SMTP authentication is selected.

**3 [POP server name]**

Enter the POP server name.

Allowed characters:

Alphanumerics (A to Z, a to z, 0 to 9)

Minus sign (-) and period (.)

**4 [User name]**

Enter the user name for the POP server or the SMTP server.

**5 [Password]**

Enter the password for the POP server or the SMTP server.

**6 [SMTP server port]**

Enter the port number of the SMTP server.  
(Normally 25)

**7 [POP server port]**

Enter the port number of the POP server.  
(Normally 110)

**8 [Submit]**

Update the settings.

## Contents of mail sent

## Example of E-mail sent when E-mail is set

The following E-mail is sent when the E-mail settings have been established.

```

=== Panasonic projector report(CONFIGURE) ===
Projector Type   : DW640
Serial No       : SH1234567

---- E-mail setup data ----
TEMPERATURE WARNING SETUP
MINIMUM TIME    at [ 60] minutes interval
INTAKE AIR TEMPERATURE Over [ 45 degC / 113 degF]

ERROR          [ OFF ]
LAMP1 RUNTIME  [ OFF ] at REMAIN [ 400] H
LAMP1 RUNTIME  [ OFF ] at REMAIN [ 200] H
LAMP2 RUNTIME  [ OFF ] at REMAIN [ 400] H
LAMP2 RUNTIME  [ OFF ] at REMAIN [ 200] H
INTAKE AIR TEMPERATURE [ OFF ]
PERIODIC REPORT
Sunday [ OFF ] Monday [ OFF ] Tuesday [ OFF ] Wednesday [ OFF ]
Thursday [ OFF ] Friday [ OFF ] Saturday [ OFF ]

00:00 [ OFF ] 01:00 [ OFF ] 02:00 [ OFF ] 03:00 [ OFF ]
04:00 [ OFF ] 05:00 [ OFF ] 06:00 [ OFF ] 07:00 [ OFF ]
08:00 [ OFF ] 09:00 [ OFF ] 10:00 [ OFF ] 11:00 [ OFF ]
12:00 [ OFF ] 13:00 [ OFF ] 14:00 [ OFF ] 15:00 [ OFF ]
16:00 [ OFF ] 17:00 [ OFF ] 18:00 [ OFF ] 19:00 [ OFF ]
20:00 [ OFF ] 21:00 [ OFF ] 22:00 [ OFF ] 23:00 [ OFF ]

---- check system ----
MAIN CPU BUS      [ OK ]
FAN               [ OK ]
INTAKE AIR TEMPERATURE [ OK ]
OPTICS MODULE TEMPERATURE [ OK ]
AROUND LAMP TEMPERATURE [ OK ]
LAMP1 REMAIN TIME [ OK ]
LAMP2 REMAIN TIME [ OK ]
LAMP1 STATUS     [ OK ]
LAMP2 STATUS     [ OK ]
SHUTTER          [ OK ]
INTAKE AIR TEMP.SENSOR [ OK ]
OPTICS MODULE TEMP.SENSOR [ OK ]
AROUND LAMP TEMP.SENSOR [ OK ]
BATTERY          [ OK ]
COLOR WHEEL      [ OK ]
COVER OPEN       [ OK ]
FILTER UNIT      [ OK ]
AIR FILTER       [ OK ]
(Error code 00 00 00 00 00 00 00)

Intake air temperature : 26 degC / 78 degF
Optics module temperature : 39 degC / 102 degF
Around lamp temperature : 30 degC / 86 degF
PROJECTOR RUNTIME 1 H
POWER ON          1 times
LAMP1 ON          1 times
LAMP1 ECO         0 H
LAMP1 NORMAL     0 H
LAMP1 REMAIN     2499 H
LAMP2 ON          1 times
LAMP2 ECO         0 H
LAMP2 NORMAL     1 H
LAMP2 REMAIN     2499 H

----- Current status -----
MAIN VERSION      1.00
NETWORK VERSION   1.00
SUB VERSION       1.00
LAMP STATUS      LAMP1=ON LAMP2=ON
INPUT SIGNAL     RGB1 ---
                  0.00kHz / 0.00Hz
REMOTE2 STATUS   DISABLE

---- Wired Network configuration ----
DHCP Client      OFF
IP address       192.168.10.100
MAC address      70:58:12:00:00:00

Wed Jan 18 11:42:37 2012

---- Memo ----

```

Example of the E-mail sent for an error

The following E-mail is sent when an error has occurred.

```

=== Panasonic projector report(CONFIGURE) ===
Projector Type      : DW640
Serial No          : SH1234567

----- check system -----
MAIN CPU BUS       [ OK ]
FAN                [ OK ]
INTAKE AIR TEMPERATURE [ OK ]
OPTICS MODULE TEMPERATURE [ OK ]
AROUND LAMP TEMPERATURE [ OK ]
LAMP1 REMAIN TIME  [ OK ]
LAMP2 REMAIN TIME  [ OK ]
LAMP1 STATUS       [ OK ]
LAMP2 STATUS       [ OK ]
SHUTTER            [ OK ]
INTAKE AIR TEMP.SENSOR [ OK ]
OPTICS MODULE TEMP.SENSOR [ OK ]
AROUND LAMP TEMP.SENSOR [ OK ]
BATTERY            [ OK ]
COLOR WHEEL        [ OK ]
COVER OPEN         [ OK ]
FILTER UNIT        [ FAILED ]
AIR FILTER          [ OK ]
(Error code 04 00 00 00 00 00 00)

Intake air temperature : 26 degC / 78 degF
Optics module temperature : 39 degC / 102 degF
Around lamp temperature : 30 degC / 86 degF
PROJECTOR RUNTIME      1 H
POWER ON                1 times
LAMP1 ON                1 times
LAMP1 ECO                0 H
LAMP1 NORMAL            0 H
LAMP1 REMAIN            2499 H
LAMP2 ON                1 times
LAMP2 ECO                0 H
LAMP2 NORMAL            1 H
LAMP2 REMAIN            2499 H

----- Current status -----
MAIN VERSION            1.00
NETWORK VERSION         1.00
SUB VERSION             1.00
LAMP STATUS             LAMP1=ON LAMP2=ON
INPUT SIGNAL            RGB1 ---
                        0.00kHz / 0.00Hz
REMOTE2 STATUS          DISABLE

----- Wired Network configuration -----
DHCP Client             OFF
IP address               192.168.10.100
MAC address              70:58:12:00:00:00

Wed Jan 18 11:42:37 2012

----- Memo -----
    
```

User name [Change password] page

Click [Change password].

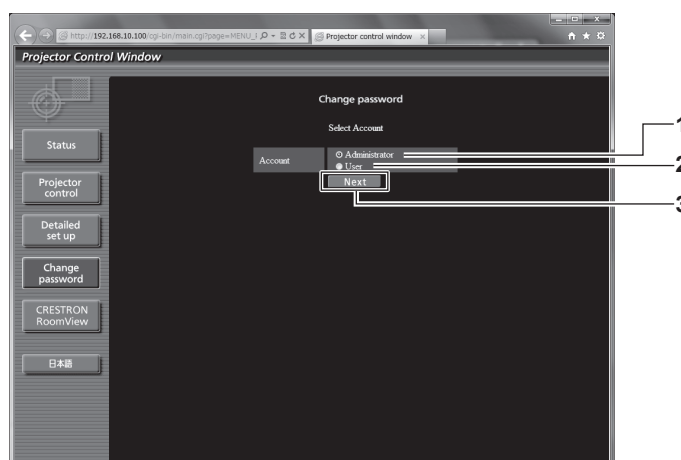

- 1 **[Administrator]**  
Used to change the setting of the [Administrator].
- 2 **[User]**  
Used to change the setting of the [User].
- 3 **[Next]**  
Used to change the setting of the password.



**[Administrator] account**

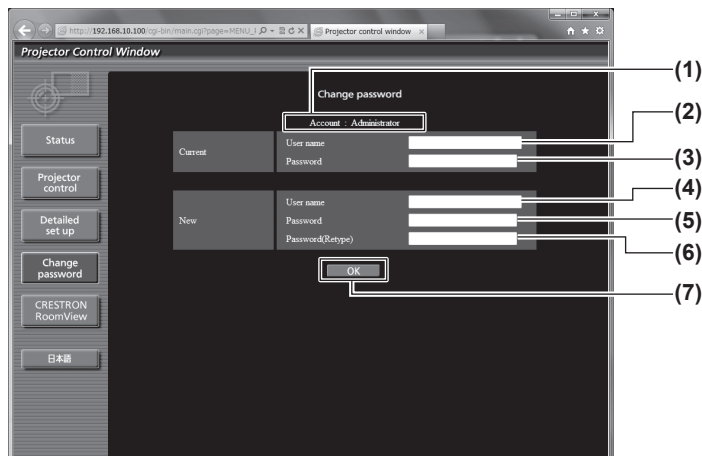

- |  |  |
|--|--|
| <p>1 <b>[Account]</b><br/>Displays the account to change.</p> <p>2 <b>[Current][User name]</b><br/>Enter the user name before the change.</p> <p>3 <b>[Current][Password]</b><br/>Enter the current password.</p> <p>4 <b>[New][User name]</b><br/>Enter the desired new user name. (Up to 16 characters in single byte)</p> | <p>5 <b>[New][Password]</b><br/>Enter the desired new password. (Up to 16 characters in single byte)</p> <p>6 <b>[New][Password(Retype)]</b><br/>Enter the desired new password again.</p> <p>7 <b>[OK]</b><br/>Determines the change of password.</p> |
|--|--|

**[User] account**

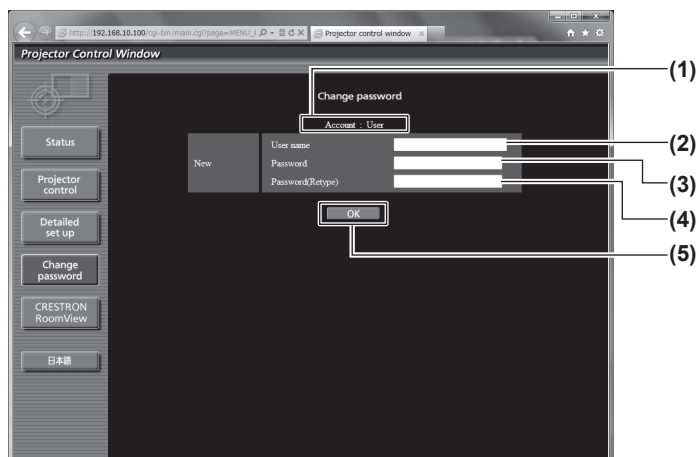

- |   |
|---|
| <p>1 <b>[Account]</b><br/>Displays the account to change.</p> <p>2 <b>[New][User name]</b><br/>Enter the desired new user name. (Up to 16 characters in single byte)</p> <p>3 <b>[New][Password]</b><br/>Enter the desired new password. (Up to 16 characters in single byte)</p> <p>4 <b>[New][Password(Retype)]</b><br/>Enter the desired new password again.</p> <p>5 <b>[OK]</b><br/>Determines the change of password.</p> |
|---|

**[Change password] (For user rights)**

Only the change of password is enabled under the user rights.

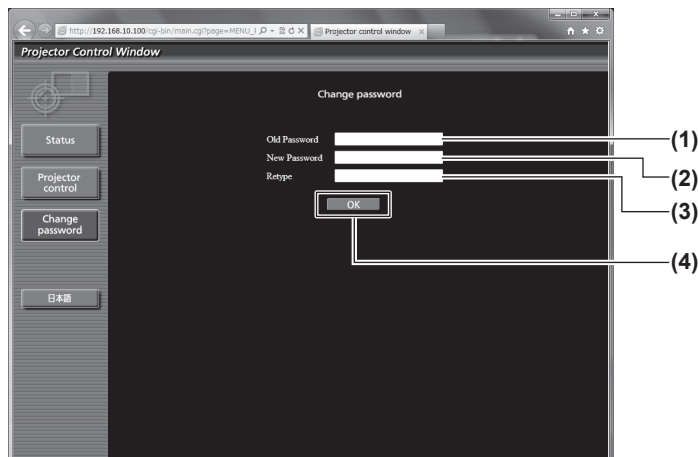

- |  |  |
|--|--|
| <p><b>1 [Old Password]</b><br/>Enter the current password.</p> <p><b>2 [New Password]</b><br/>Enter the desired new password. (Up to 16 characters in single byte)</p> | <p><b>3 [Retype]</b><br/>Enter the desired new password again.</p> <p><b>4 [OK]</b><br/>Determines the change of password.</p> |
|--|--|

**Note**

- To change the account of the administrator, you must enter the [Current] [User name] and [Password].

**[CRESTRON RoomView] page**

The projector can be monitored and/or controlled with RoomView.

To start the RoomView control page from the Web control screen, you need to access with the administrator rights. (For user rights, the [CRESTRON RoomView] button is not displayed on the Web control screen.)

The control page of RoomView is displayed by clicking [CRESTRON RoomView].

It is not displayed if Adobe Flash Player is not installed on the computer used, or the browser used does not support Flash. In that case, click [Back] on the control page to go back to the previous page.

**Control page**



- |  |  |
|--|--|
| <p><b>1 [Tools][Info][Help]</b><br/>Tabs for selecting the setting, information, or help page of the projector.</p> <p><b>2 [POWER]</b><br/>Switches the power on/off.</p> <p><b>3 [SHUTTER]</b><br/>Switches between use or not use of the shutter function.</p> <p><b>4 [Input Select]</b><br/>Controls input selection.<br/>Not available when the power of the projector is turned off.</p> <p><b>5 Menu screen control buttons</b><br/>Navigates the menu screen.</p> | <p><b>6 Freeze/Picture quality adjustment</b><br/>Controls items related to freeze/picture quality.</p> <p><b>7 [Back]</b><br/>Performs return to the previous page.</p> |
|--|--|

[Tools] page

Click [Tools] on the control page.

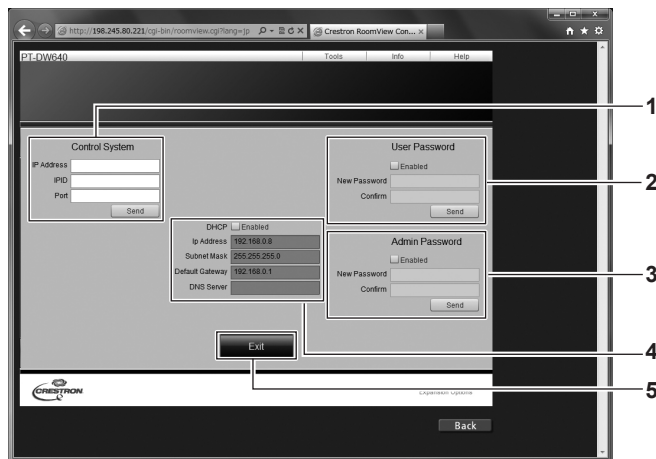

- |   |   |
|---|---|
| <ul style="list-style-type: none"> <li>1 <b>[Control System]</b><br/>Set the information required for communicating with the controller to be connected with the projector.</li> <li>2 <b>[User Password]</b><br/>Set the user rights password for the RoomView control page.</li> <li>3 <b>[Admin Password]</b><br/>Set the administrator rights password for the RoomView control page.</li> <li>4 <b>Network Status</b><br/>Displays the settings of wired LAN.</li> </ul> | <ul style="list-style-type: none"> <li><b>[DHCP]</b><br/>Displays the current setting.</li> <li><b>[Ip Address]</b><br/>Displays the current setting.</li> <li><b>[Subnet Mask]</b><br/>Displays the current setting.</li> <li><b>[Default Gateway]</b><br/>Displays the current setting.</li> <li><b>[DNS Server]</b><br/>Displays the current setting.</li> <li>5 <b>[Exit]</b><br/>Returns to the control page.</li> </ul> |
|---|---|

[Info] page

Click [Info] on the control page.

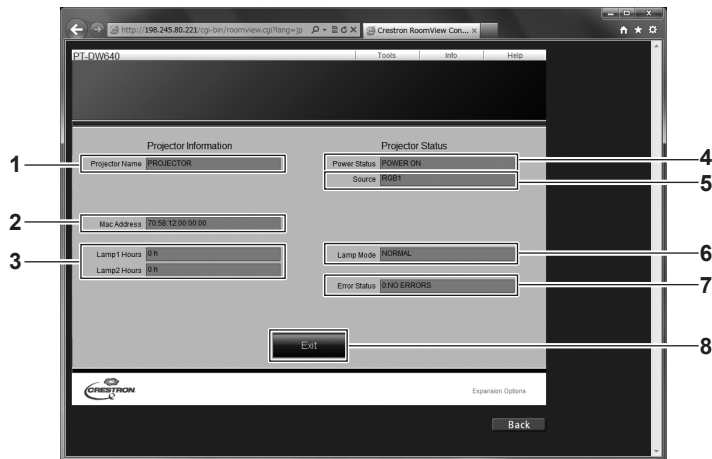

- 1 **[Projector Name]**  
Displays the projector name.
- 2 **[Mac Address]**  
Displays the MAC address.
- 3 **[Lamp Hours]**  
Displays the cumulative operating time (converted value) of the lamps.
- 4 **[Power Status]**  
Displays the status of the power.
- 5 **[Source]**  
Displays the selected image input.
- 6 **[Lamp Mode]**  
Displays the lamp mode.
- 7 **[Error Status]**  
Displays the error status.
- 8 **[Exit]**  
Returns to the control page.

### [Help] page

Click [Help] on the control page.

The [Help Desk] window is displayed.



- 1 [Help Desk]**  
Messages can be sent to or received from an administrator who uses Crestron RoomView.

# Chapter 5 Maintenance

---

This chapter describes inspection when there are problems, and maintenance methods.

# Lamp/Temperature/Filter indicators

## Managing the indicated problems

If a problem should occur inside the projector, the lamp indicators <LAMP1>/<LAMP2>/ the temperature indicator <TEMP> and the filter indicator <FILTER> will inform you by lighting or flashing.

Check the status of the indicators and manage the indicated problems as follows.

### Attention

- When switching off the projector to deal with problems, make sure to follow the procedure in “Switching off the projector” (➔ page 43).
- Check the status of the power supply with the power indicator <ON (G)/STANDBY (R)> (➔ page 42).

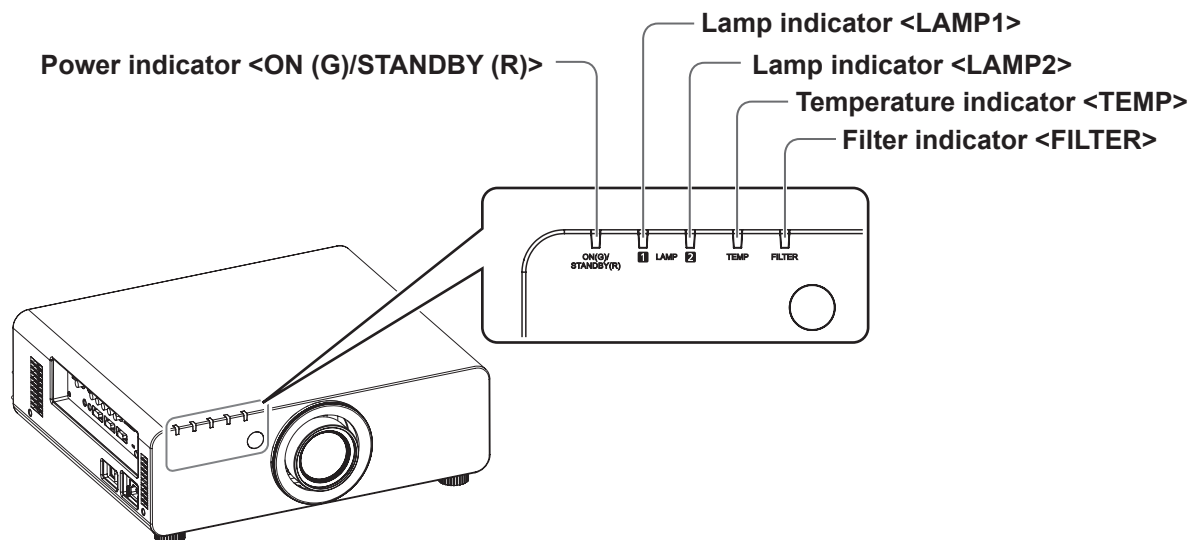

## Lamp indicators <LAMP1>/<LAMP2>

Indicator status	Lighting in red	Flashing in red (1 time)	Flashing in red (3 times)	
<b>Status</b>	Time to replace the lamp unit.	The lamp unit is not attached.	A problem is detected in the lamp or the power supply for the lamp.	
<b>Cause</b>	<ul style="list-style-type: none"> <li>• Was [REPLACE LAMP] displayed when you turned on the power of the projector?</li> <li>• This indicator lights up when the cumulative operating time of the lamp unit has reached 2 300 hours (when [LAMP POWER] is set to [NORMAL]).</li> </ul>	<ul style="list-style-type: none"> <li>• Is the lamp unit attached?</li> </ul>	<ul style="list-style-type: none"> <li>• Have you turned on the power again immediately after turning it off?</li> </ul>	<ul style="list-style-type: none"> <li>• Some error has arisen in the lamp circuit. Check for fluctuation (or drop) in the source voltage.</li> </ul>
<b>Solution</b>	<ul style="list-style-type: none"> <li>• Replace the lamp unit.</li> </ul>	<ul style="list-style-type: none"> <li>• Install the lamp case if the lamp unit is not installed.</li> <li>• If the indicator is still blinking in red even though the lamp unit is not installed, consult your dealer.</li> </ul>	<ul style="list-style-type: none"> <li>• Wait a while until the luminous lamp cools off, and then turn on the power.</li> </ul>	<ul style="list-style-type: none"> <li>• Turn the &lt;MAIN POWER&gt; switch &lt;OFF&gt;(➔ page 43), and consult your dealer.</li> </ul>

### Note

- If lamp indicator <LAMP1>/<LAMP2> is still lit or flashing after the preceding measures are taken, ask your dealer to repair the unit.

### Temperature indicator <TEMP>

Indicator status	Lighting in red		Flashing in red (1 time)	Flashing in red (3 times)
<b>Status</b>	Warm-up status	Internal temperature is high (warning)	Internal temperature is high (standby warning)	The cooling fan has stopped.
<b>Cause</b>	<ul style="list-style-type: none"> <li>• Did you turn on the power when the room temperature was about 0 °C (32 °F)?</li> </ul>	<ul style="list-style-type: none"> <li>• Is the air intake/exhaust port blocked?</li> <li>• Is the room temperature high?</li> <li>• Is the filter indicator &lt;FILTER&gt; not lit?</li> </ul>		—
<b>Solution</b>	<ul style="list-style-type: none"> <li>• Wait at least five minutes in the current status.</li> <li>• Install the unit in a location with an ambient temperature of 0 °C (32 °F) to 45 °C (113 °F)*.</li> </ul>	<ul style="list-style-type: none"> <li>• Remove any objects that are blocking the air intake/exhaust port.</li> <li>• Set up the projector in a location with an ambient temperature of 0 °C (32 °F) to 45 °C (113 °F)*, and a humidity of 20 % to 80 % (no condensation).</li> <li>• Clean the air filter unit or replace it. (➔ pages 112, 113)</li> </ul>		<ul style="list-style-type: none"> <li>• Turn the &lt;MAIN POWER&gt; switch &lt;OFF&gt;(➔ page 43), and consult your dealer.</li> </ul>

\* When using the projector at high altitudes (1 400 m (4 593 ft) – 2 700 m (8 858 ft) above sea level), the operating environment temperature will be 5 °C (41 °F) lower than the maximum limit.

#### Note

- If the temperature indicator <TEMP> is still lit or flashing after taking the preceding measures, ask your dealer to repair the unit.

### Filter indicator <FILTER>

Indicator status	Lighting in red			Flashing in red
<b>Status</b>	The filter is clogged. The temperature inside or outside the projector is abnormally high.			The air filter unit is not attached.
<b>Cause</b>	<ul style="list-style-type: none"> <li>• Is the air filter unit dirty?</li> </ul>	<ul style="list-style-type: none"> <li>• Is the air intake/exhaust port blocked?</li> </ul>	<ul style="list-style-type: none"> <li>• Is [HIGH ALTITUDE MODE] set correctly?</li> </ul>	<ul style="list-style-type: none"> <li>• Is the air filter unit attached?</li> </ul>
<b>Solution</b>	<ul style="list-style-type: none"> <li>• Clean the air filter unit or replace it. (➔ pages 112, 113)</li> </ul>	<ul style="list-style-type: none"> <li>• Remove any objects that are blocking the air intake/exhaust port.</li> </ul>	<ul style="list-style-type: none"> <li>• When using the projector at elevations 1 400 m (4 593 ft) – 2 700 m (8 858 ft) above sea level, set [HIGH ALTITUDE MODE] (➔ page 76) to [ON].</li> <li>• Do not use the projector at high elevations 2 700 m (8 858 ft) or higher above sea level.</li> </ul>	<ul style="list-style-type: none"> <li>• Attach the air filter unit.</li> </ul>

#### Note

- If the filter indicator <FILTER> is still lit or flashing after taking the preceding measures, ask your dealer to repair the unit.
- If the air filter unit is not installed when the power is turned on, the filter indicator <FILTER> will flash in red and the power will switch off 10 minutes later.
- If the filter is clogged, only one lamp may light even when [LAMP SELECT] is set to [DUAL]. Cleaning the air filter unit or replacing it with a new one will turn off the indicator.

# Maintenance/replacement

## Before maintaining/replacing the unit

- Make sure to turn off the power before maintaining or replacing the unit. (➔ pages 41, 43)
- When switching off the projector, make sure to follow the procedures in “Switching off the projector” (➔ page 43).

## Maintenance

### Outer case

Wipe off dirt and dust with a soft, dry cloth.

- If the dirt is persistent, soak the cloth with water and wring it thoroughly before wiping. Dry off the projector with a dry cloth.
- Do not use benzene, thinner, rubbing alcohol, other solvents, or household cleaners. Doing so may deteriorate the outer case.
- When using chemically treated dust cloths, follow the instructions written on its packaging.

### Front surface of the lens

Wipe off dirt and dust from the front surface of the lens with a soft clean cloth.

- Do not use a cloth that is fluffy, dusty, or soaked with oil/water.
- Since the lens is fragile, do not use excessive force when wiping the lens.

### Attention

- The lens is made of glass. Impacts or excessive force when wiping may scratch its surface. Please handle with care.

### Air filter unit

Perform maintenance of the air filter unit in the following cases.

- The air filter is clogged with dust, causing the filter replacement message to appear on the screen and the filter indicator <FILTER> to light in red.

### Pulling out the air filter unit

#### 1) Remove the air filter cover.

- Use a Phillips screwdriver to turn the air filter cover screw counterclockwise until it turns freely, and then remove the air filter cover.

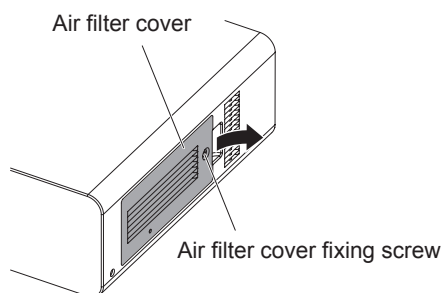

#### 2) Pull out the air filter unit.

- Grasp the air filter unit tabs and remove the air filter unit from the projector body.

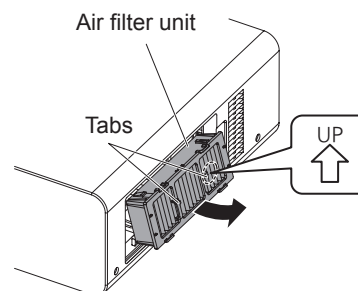

### Attention

- After pulling out the air filter unit, remove any large foreign objects or dust present in the air filter unit compartment and the air intake port of the projector body.

### Cleaning the air filter unit

First pull out the air filter in the procedure described in “Pulling out the air filter unit”.

#### 1) Clean the air filter unit.

- Soak the air filter unit in cold or warm water and then lightly rinse it.
  - Do not use cleaning tools such as brushes.
  - When rinsing, hold the frame of the air filter unit without putting strong pressure on the filter unit.
- Rinse the unit two to three times using fresh water each time.
  - Insufficient rinsing may result in odors.

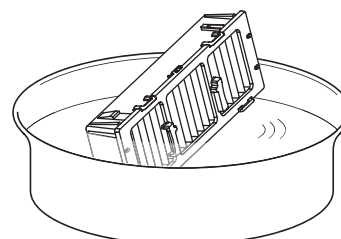



## 2) Dry the air filter unit.

- Let the unit naturally dry off in a well-ventilated place where there is little dust and the unit is protected from direct sunlight.
- Do not dry using drying devices such as dryers.
- When the air filter unit is dry, proceed to the procedure described in “Attaching the air filter unit” (➔ page 113).

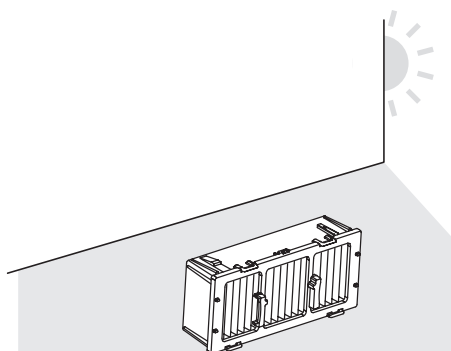

## Attaching the air filter unit

### 1) Attach the air filter unit to the projector.

- The top and bottom of the air filter unit are different. (Make sure of the direction of the arrow (➔).)
- Attach in reverse order of Step 2) in “Pulling out the air filter unit” (➔ page 112).

### 2) Attach the air filter cover to the projector and use a Phillips screwdriver to tighten the air filter cover screw.

- Attach in reverse order of Step 1) in “Pulling out the air filter unit” (➔ page 112).

### Attention

- After washing the air filter unit, dry it thoroughly before attaching it back to the projector. Attaching a wet unit will cause an electric shock or malfunction.
- Do not disassemble the air filter unit.

### Note

- Make sure that the air filter unit is properly attached before using the projector. If not properly attached, the projector will suck in dirt and dust which causes malfunction and the power to switch off 10 minutes later. (The time remaining until the power switches off is displayed in 1-minute increments.)
- Replace the air filter unit with a replacement filter unit (ET-EMF300) if it is damaged or if the dirt does not come off even after washing.
- Air filter replacement is recommended after cleaning the unit two times.
- The dust-proof properties may be reduced after each cleaning.

## Replacing the unit

### Air filter unit

If dirt does not come off even if the unit is maintained, it is time for the unit to be replaced.

The replacement filter unit (Model No.: ET-EMF300) is an optional accessory. To purchase the product, consult your dealer.

## Replacing the air filter unit

### Attention

- Make sure to turn off the power before replacing the air filter unit.
- When replacing the unit, make sure that the projector is stable. Perform the replacement in a safe place where the projector will not be damaged even if you drop the air filter unit.

### 1) Pull out the air filter unit.

- Refer to “Pulling out the air filter unit” (➔ page 112).

### 2) Attach the replacement filter unit optional accessory (Model No.: ET-EMF300) to the projector body.

- The top and bottom of the air filter unit are different. (Make sure of the direction of the arrow (➔).)
- Refer to “Attaching the air filter unit” (➔ page 113).

### Attention

- When switching on the projector, make sure that the air filter unit is installed. If not properly attached, the projector will suck in dirt and dust which causes malfunction and the power to switch off 10 minutes later. (The time remaining until the power switches off is displayed in 1-minute increments.)

**Note**

- The replacement cycle of the air filter unit varies greatly depending on the usage environment.

**Lamp unit**

The lamp unit is a consumable component. Check the lamp usage time in [PROJECTOR SETUP] [STATUS] (➔ page 81) in the menu and change the lamp periodically.

It is recommended that you request a qualified technician to replace the lamp unit. Consult your dealer.

Consult your dealer to purchase a replacement lamp unit (Model No.: ET-LAD60A (1 bulb), ET-LAD60AW (2 bulbs)).

**Warning**

- **Replace the lamp unit after the lamp has cooled (after waiting at least one hour).**  
The high internal temperature of the cover will cause burns.

**Notes on the replacement of the lamp unit**

- Since the luminous lamp is made of glass, it may burst if dropped or hit with a hard object.  
Please handle with care.
- A Phillips screwdriver is necessary when replacing the lamp unit.
- Make sure you hold the lamp unit by its handles during replacement.
- The lamp may burst. Replace the lamp unit carefully so that the broken pieces of the lamp glass will not scatter. If the projector is mounted to the ceiling, do not make the replacement directly beneath the lamp unit or put your face near it.
- The lamp contains mercury. When disposing of used lamp units, contact your local authorities or dealer for correct methods of disposal.

**Attention**

- Use only specified lamp units.

**Note**

- The model numbers of accessories and optional components are subject to change without notice.

**When to replace the lamp unit**

The lamp unit is a consumable component. Since its brightness gradually decreases over time, it is necessary to replace it regularly. The estimated duration before replacement is 2 500 hours. However, this may be shortened depending on individual lamp characteristics, usage conditions, and the installation environment. Therefore, it is strongly recommended that a replacement lamp unit be prepared. If the lamp is not replaced after 2 500 hours of use, a malfunction will occur and the projector will automatically switch off after approximately ten minutes.

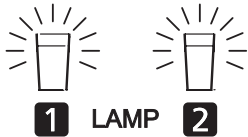
	On-screen display	Lamp indicator
		
<b>Over 2 300 hours</b>	The message is displayed for 30 seconds. Pressing any button on the control panel or remote control within 30 seconds will clear the message.	Lights in red even during the standby mode. (Only the corresponding lamp lights)
<b>Over 2 500 hours</b>	The message remains displayed until you press a button.	

**Note**

- The 2 500 hour usage period is a rough estimate and is not guaranteed.

**Replacing the lamp unit**

**Attention**

- When the projector is mounted on the ceiling, do not perform tasks while your face is near the lamp unit.
- Make sure to attach the lamp unit and lamp unit cover properly.
- If the lamp unit is not installed properly, remove it and then attach it again. Pushing it in forcibly may break the connector.

- 1) Follow the procedures described in “Switching off the projector” (⇒ page 43) to set the <MAIN POWER> switch to <OFF>, disconnect the power plug from the power outlet, and wait at least one hour, and then check if the lamp unit has cooled down.

**2) Remove the lamp unit cover.**

- i) Use a Phillips screwdriver to loosen the lamp unit cover fixing screw (one screw) until it turns freely, and then open the lamp unit cover in the direction of the arrow.
- ii) Hold the lamp unit cover securely and slide it towards the control button side, and then pull it from the rear of the set to remove.

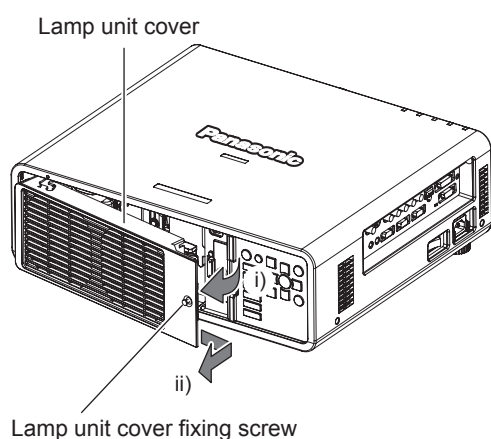

- 3) Use a Philips screwdriver to remove the lamp unit fixing screws (three screws each), and then holding the handles, pull out the lamp unit from the projector.

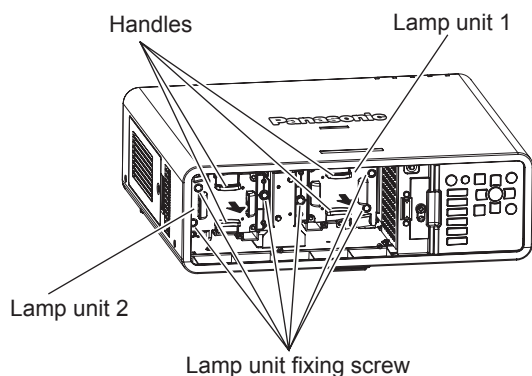

- 4) Carefully push the new lamp unit into the projector.
- 5) Use a Phillips screwdriver to firmly tighten the lamp unit fixing screws (three screws each).

**6) Attach the lamp unit cover.**

- i) Attach the lamp unit cover while aligning the (a) and (b) marks (○ and △).
- ii) Slide the lamp unit cover in the direction of the arrow to insert the front end and then firmly tighten the lamp unit cover fixing screws.
  - Attach so that the connector of the lamp unit cover is firmly inserted into the fan power supply connector.

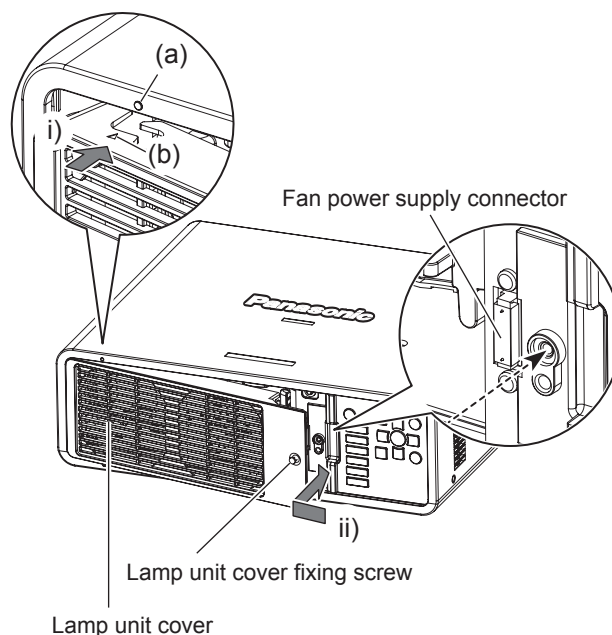

**Note**

- When you place the new lamp unit, the projector resets the total usage time of the lamp unit automatically.

# Troubleshooting

Review the following points. For details, see the corresponding pages.

Problems	Points to be checked	Page
<b>Power does not turn on.</b>	• Is the power plug firmly inserted into the outlet?	—
	• Is the <MAIN POWER> switch turned <OFF>?	43
	• Is the wall outlet supplying electricity?	—
	• Have the circuit breakers tripped?	—
	• Is the temperature indicator <TEMP> or the lamp indicator <LAMP1>/<LAMP2> lit or flashing? • Is the lamp unit cover securely installed?	110, 111 114
<b>No image appears.</b>	• Are connections to external devices correctly performed?	37
	• Is the input selection setting correct?	48, 79
	• Is the [BRIGHTNESS] adjustment setting at a minimum?	55
	• Is the external device that is connected to the projector working properly?	—
	• Is the shutter function in use?	47
	• If the power indicator <ON (G)/STANDBY (R)> is flashing in red, consult your dealer.	—
<b>The picture is fuzzy.</b>	• Is the lens focus set correctly?	45
	• Is the projection distance appropriate?	27
	• Is the lens dirty?	16
	• Is the projector installed perpendicular to the screen?	—
<b>The color is pale or grayish.</b>	• Is the [COLOR] or [TINT] adjusted correctly?	56
	• Is the external device connected to the projector adjusted correctly?	37
	• Is the RGB cable damaged?	—
<b>The remote control does not respond.</b>	• Are the batteries depleted?	—
	• Is the polarity of the batteries set correctly?	23
	• Are there any obstructions between the remote control and the projector's remote control signal receiver?	20
	• Is the remote control being used beyond its effective operation range?	20
	• Are other forms of light, such as fluorescent light, affecting the projection?	20
	• Is the [REMOTE CONTROL] setting in [CONTROL DEVICE SETUP] set to [DISABLE]?	90
	• Is the <REMOTE 2 IN> terminal used for contact control?	124
	• Is the ID number setting operation correct?	23
<b>The menu screen does not appear.</b>	• Is the on-screen display function turned off (hidden)?	22, 47
<b>The buttons on the control panel do not operate.</b>	• Is the [CONTROL PANEL] setting in [CONTROL DEVICE SETUP] set to [DISABLE]?	90
	• Is the <REMOTE 2 IN> terminal used for contact control?	124
<b>The image does not display correctly.</b>	• Is the [SYSTEM SELECTOR] selection set correctly?	59
	• Is there a problem with the video tape or other image sources?	—
	• Is a signal which is not compatible with the projector being input?	125
<b>Image from a computer does not appear.</b>	• Is the cable too long? (Use D-Sub cables that are 10 m (32'10") or shorter.)	—
	• Is the external video output of the laptop computer set correctly? Ex.: The external output settings may be switched by pressing the "Fn"+"F3" or "Fn"+"F10" keys simultaneously. Since the method varies depending on the computer type, refer to the user manual provided with your computer.)	—
<b>Image from a computer's DVI-D output does not appear.</b>	• Is the [DVI-D IN] setting set to [EDID3]/[EDID2:PC]?	70
	• The graphics accelerator driver of the computer may need to be updated to the latest version.	—
	• The computer may need to be restarted after performing [DVI-D IN] settings.	70
<b>Video from HDMI compatible device does not appear or it appears jumbled.</b>	• Is the HDMI cable connected securely?	37
	• Turn the power of the projector and the external device on and off.	—
	• Is a signal which is not compatible with the projector being input?	125

## Attention

- If problems persist even after checking the preceding points, consult your dealer.

# Chapter 6 Appendix

---

This chapter describes specifications and after-sales service for the projector.

# Technical information

## PJLink protocol

The network function of this projector supports the PJLink class 1, and the PJLink protocol can be used to perform projector setting and projector status query operations from a computer.

### Control commands

The following table lists the PJLink protocol commands that can be used to control the projector.

Command	Control details	Notes
POWR	Power supply control	Parameters 0 = Standby 1 = Power on
POWR?	Power supply status query	Parameters 0 = Standby 1 = Power on 2 = Cool-down in progress 3 = Warm-up in progress
INPT	Input selection	Parameters 11=RGB1 12=RGB2 21=VIDEO 22=S-VIDEO 31=DVI-D 32=HDMI
INPT?	Input selection query	
AVMT	Shutter control	Parameters 30 = shutter function off (picture mute canceled) 31 = shutter function on (picture mute)
AVMT?	Shutter status query	
ERST?	Error status query	Parameters 1st byte: Indicates fan errors, range 0 - 2 2nd byte: Indicates lamp errors, range 0 - 2 3rd byte: Indicates temperature errors, range 0 - 2 4th byte: Indicates cover open errors, range 0 - 2 5th byte: Indicates filter errors, range 0 - 2 6th byte: Indicates other errors, range 0 - 2 Definitions for each value from 0 to 2 are as follows 0 = No error is detected 1 = Warning 2 = Error
LAMP?	Lamp status query	Parameters 1st digits (1 - 5 digits): Lamp 1 cumulative operating time 2nd digits: 0 = Lamp 1 off, 1 = Lamp 1 on 3rd digits (0 - 5 digits): Lamp 2 cumulative operating time 4th digits: 0 = Lamp 2 off, 1 = Lamp 2 on
INST?	Input selection list query	Parameters are returned with the following values. "11 12 21 22 31 32"
NAME?	Projector name query	Returns the name set in [PROJECTOR NAME] of [NETWORK SETUP].
INF1?	Manufacturer name query	Returns "Panasonic".
INF2?	Model name query	Returns "DW640" or "DX610".
INF0?	Other information queries	Returns information such as version number.
CLSS?	Class information query	Returns "1".

### PJLink security authentication

The password used for PJLink is the same as that of the password set for Web control.

When using the projector without security authentication, do not set a password for Web control.

- For specifications regarding PJLink, refer to the Japan Business Machine and Information System Industries Association website.  
URL <http://pjlink.jbmia.or.jp/english/>

## Control commands via LAN

### When WEB control administrator rights password is set (Protect mode)

#### Connection method

#### 1) Obtain the IP address and port number (Initial set value = 1024) of the projector and request for a connection to the projector.

- You can obtain both the IP address and the port number from the menu screen of the projector.

<b>IP address</b>	Obtain from the main menu → [NETWORK] → [NETWORK STATUS].
<b>Port number</b>	Obtain from the main menu → [NETWORK] → [NETWORK CONTROL] → [COMMAND PORT].

#### 2) Check the response from the projector.

##### ■ Response data

Data section	Blank	Mode	Blank	Random number section	Termination symbol
"NTCONTROL" (ASCII string)	' '	'1'	' '	"zzzzzzzz" (ASCII code hexadecimal number)	(CR) 0x0d
9 bytes	1 byte	1 byte	1 byte	8 bytes	1 byte

- Mode: 1 = Protect mode

#### 3) Generate a 32-byte hash value from the following data using MD5 algorithm.

##### ■ "xxxxxx:yyyyy:zzzzzzzz"

<b>xxxxxx</b>	Administrator rights user name for Web control (default user name is "admin1")
<b>yyyyy</b>	Password of above administrator rights user (default password is "panasonic")
<b>zzzzzzzz</b>	8-byte random number obtained in Step 2)

#### Command transmission method

Transmit using the following command formats.

##### ■ Transmitted data

Header			Data section	Termination symbol
Hash value (Refer to the preceding "Connection method")	'0' 0x30	'0' 0x30	Control command (ASCII string)	(CR) 0x0d
32 bytes	1 byte	1 byte	Undefined length	1 byte

##### ■ Received data

Header		Data section	Termination symbol
'0' 0x30	'0' 0x30	Control command (ASCII string)	(CR) 0x0d
1 byte	1 byte	Undefined length	1 byte

## ■ Error response

Error message		Termination symbol
"ERR1"	Undefined control command	(CR) 0x0d
"ERR2"	Out of parameter range	
"ERR3"	Busy state or no-acceptable period	
"ERR4"	Timeout or no-acceptable period	
"ERR5"	Wrong data length	
"ERRA"	Password mismatch	
4 bytes		1 byte

## When WEB control administrator rights password is not set (Non-protect mode)

### Connection method

#### 1) Obtain the IP address and port number (Initial set value = 1024) of the projector and request for a connection to the projector.

- You can obtain both the IP address and the port number from the menu screen of the projector.

<b>IP address</b>	Obtain from the main menu → [NETWORK] → [NETWORK STATUS].
<b>Port number</b>	Obtain from the main menu → [NETWORK] → [NETWORK CONTROL] → [COMMAND PORT].

#### 2) Check the response from the projector.

### ■ Response data

Data section	Blank	Mode	Termination symbol
"NTCONTROL" (ASCII string)	' '	'0'	(CR)
9 bytes	0x20	0x30	0x0d
-----		-----	
9 bytes	1 byte	1 byte	1 byte

- Mode: 0 = Non-protect mode

### Command transmission method

Transmit using the following command formats.

### ■ Transmitted data

Header		Data section	Termination symbol
'0'	'0'	Control command	(CR)
0x30	0x30	(ASCII string)	0x0d
-----		-----	
1 byte	1 byte	Undefined length	1 byte

### ■ Received data

Header		Data section	Termination symbol
'0'	'0'	Control command	(CR)
0x30	0x30	(ASCII string)	0x0d
-----		-----	
1 byte	1 byte	Undefined length	1 byte



■ Error response

Error message		Termination symbol
"ERR1"	Undefined control command	(CR) 0x0d
"ERR2"	Out of parameter range	
"ERR3"	Busy state or no-acceptable period	
"ERR4"	Timeout or no-acceptable period	
"ERR5"	Wrong data length	
"ERRA"	Password mismatch	
4 bytes		1 byte

<SERIAL IN>/<SERIAL OUT> terminal

The <SERIAL IN>/<SERIAL OUT> terminal of the projector conforms with RS-232C so that the projector can be connected to and controlled from a computer.

Connection

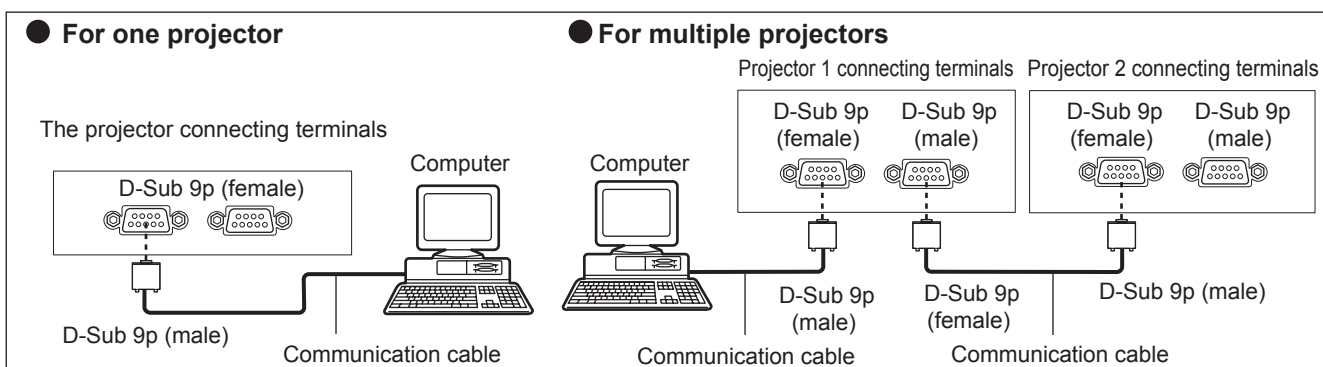

Pin assignments and signal names

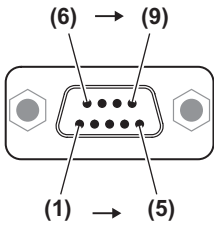
<b>D-Sub 9-pin (female)</b> Outside view 	Pin No.	Signal name	Details
	(1)	—	NC
	(2)	TXD	Transmitted data
	(3)	RXD	Received data
	(4)	—	Connected internally
	(5)	GND	Earth
	(6)	—	NC
	(7)	CTS	Connected internally
	(8)	RTS	
	(9)	—	NC

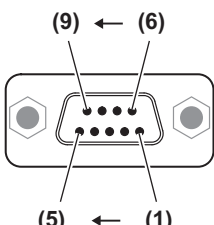
<b>D-Sub 9-pin (male)</b> Outside view 	Pin No.	Signal name	Details
	(1)	—	NC
	(2)	RXD	Received data
	(3)	TXD	Transmitted data
	(4)	—	NC
	(5)	GND	Earth
	(6)	—	NC
	(7)	RTS	Connected internally
	(8)	CTS	
	(9)	—	NC

Communication conditions (Factory default settings)

Signal level	RS-232C-compliant
--------------	-------------------

<b>Sync. method</b>	Asynchronous
<b>Baud rate</b>	9 600 bps
<b>Parity</b>	None
<b>Character length</b>	8 bit
<b>Stop bit</b>	1 bit
<b>X parameter</b>	None
<b>S parameter</b>	None

### Basic format

Transmission from the computer starts with STX, then the ID, command, parameter, and ETX are sent in this order. Add parameters according to the details of control.

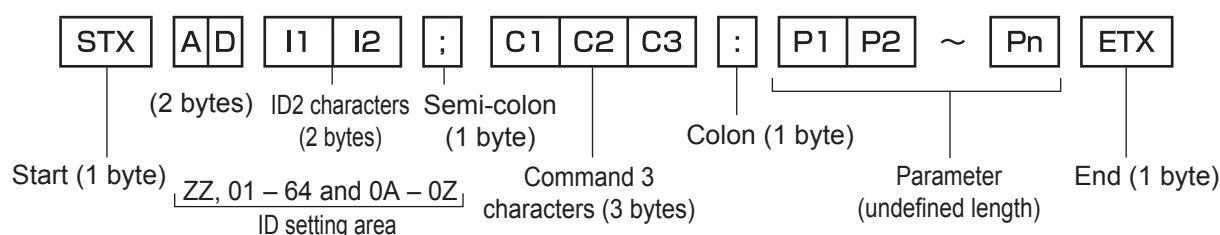

### Attention

- If a command is transmitted after the lamp starts illuminating, there may be a delay in response or the command may not be executed. Try sending or receiving any command after 60 seconds.
- When transmitting multiple commands, be sure to wait until 0.5 seconds has elapsed after receiving the response from the projector before sending the next command. When transmitting a command which does not need a parameter, a colon (:) is not necessary.

### Note

- If a command cannot be executed, an “ER401” response is sent from the projector to the computer.
- If an invalid parameter is sent, an “ER402” response is sent from the projector to the computer.
- ID transmission in RS-232C supports ZZ (ALL) and 01 to 64, as well as 0A to 0Z groups.
- If a command is sent with a specified ID, a response will be sent to the computer only in the following cases.
  - It matches the projector ID
  - ID setting is set to ALL and [RESPONSE(ID ALL)] is [ON]
  - ID setting is set to GROUP and [RESPONSE(ID GROUP)] is [ON]
- STX and ETX are character codes. STX shown in hexadecimal is 02, and ETX shown in hexadecimal is 03.

### When multiple projectors are controlled

#### When multiple projectors are all controlled

When controlling multiple projectors together via RS-232C, perform the following settings.

- 1) Set a different ID for each projector.
- 2) Set [RESPONSE(ID ALL)] to [ON] in only one projector.
- 3) Set [RESPONSE(ID ALL)] to [OFF] for all other projectors set in Step 2).

#### When multiple projectors are all controlled by group unit

When controlling multiple projectors by group unit via RS-232C, perform the following settings.

- 1) Set a different ID for each projector.
- 2) Set [RESPONSE(ID GROUP)] to [ON] in only one projector.
- 3) Set [RESPONSE(ID GROUP)] to [OFF] for all other projectors set in Step 2).

### Note

- There will be no response if 2 or more projectors have [RESPONSE(ID ALL)] set to [ON].
- There will be no response if 2 or more projectors of the same group have [RESPONSE(ID GROUP)] set to [ON].
- When setting multiple groups, set [RESPONSE(ID ALL)] to [ON] in only one projector in each group.

## Cable specifications

<When connected to a computer>

Projector (<SERIAL IN> terminal)	1	NC	NC	1	Computer (DTE specifications)
	2			2	
	3			3	
	4	NC	NC	4	
	5			5	
	6	NC	NC	6	
	7			7	
	8			8	
	9	NC	NC	9	

<When connected multiple projectors>

Projector 1 (<SERIAL OUT> terminal)	1	NC	NC	1	Projector 2 (<SERIAL IN> terminal)
	2			2	
	3			3	
	4	NC	NC	4	
	5			5	
	6	NC	NC	6	
	7			7	
	8			8	
	9	NC	NC	9	

## Control commands

The following table lists the commands that can be used to control the projector using a computer.

### ■ Projector control command

Command	Details	Remarks (parameters)
PON	Power on	To check if the power is on, use the "Power query" command.
POF	Power standby	
QPW	Power query	000 = Standby 001 = Power on
IIS	Switching the input signal	VID = VIDEO SVD = S-VIDEO RG1 = RGB1 RG2 = RGB2 DVI = DVI-D HD1 = HDMI
QSL	Query for active lamp selection	0 = Dual 1 = Single* 2 = Lamp1 3 = Lamp2
LPM	Lamp mode	0 = Dual 1 = Single* 2 = Only Lamp1 on 3 = Only Lamp2 on
OLP	Lamp power	0 = Normal 1 = ECO

\* Use either lamp 1 or lamp 2 whichever has the shortest cumulative operating time.

## <REMOTE 2 IN> terminal

It is possible to control the projector remotely (by external contact) from a control panel located away from the projector where remote control signals cannot reach. Use the <REMOTE 2 IN> terminal on the connecting terminals of the projector to connect to the control panel.

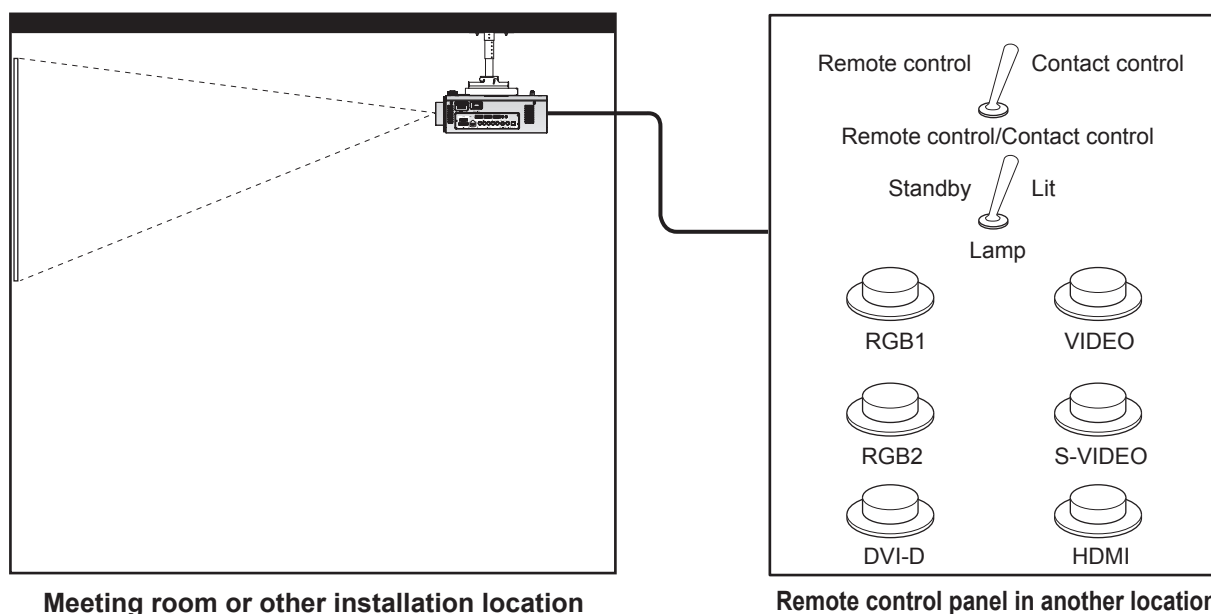

## Pin assignments and signal names

D-Sub 9-pin (Outside view)	Pin No.	Signal name	Open (H)	Short (L)
		(1)	GND	—
(2)		POWER	OFF	ON
(3)		RGB1	Other	RGB1
(4)		RGB2	Other	RGB2
(5)		VIDEO	Other	VIDEO
(6)		S-VIDEO	Other	S-VIDEO
(7)		DVI-D	Other	DVI-D
(8)		SHUTTER	OFF	ON
(9)		RST/SET	Controlled by remote control	Controlled by external contact

### Attention

- When controlling, make sure to short-circuit pins (1) and (9).
- When pins (1) and (9) are short-circuited, the following buttons on the control panel and the remote control cannot be used. The power on <|> button, the power standby <⏻> button, the <SHUTTER> button, and the RS-232C commands and network functions corresponding to these functions cannot be used either.
- When pins (1) and (9) are short-circuited, do not short-circuit any pins from (3) to (7) with pin (1). The following buttons on the control panel and the remote control cannot be used. The power on <|> button, the power standby <⏻> button, <RGB1> button, <RGB2> button, <DVI-D> button, <VIDEO> button, <S-VIDEO> button, <HDMI> button, <SHUTTER> button, and the RS-232C commands and network functions corresponding to these functions cannot be used either.

### Note

- For pin (2) to pin (8) settings, you can make changes if you set [REMOTE2 MODE] to [USER] (➔ page 81).

## Two window display combination list (PT-DW640U only)

Input A Input B	RGB1 Still image	RGB1 Movie	RGB2 Still image	RGB2 Movie	VIDEO	S-VIDEO	DVI-D Still image	DVI-D Movie	HDMI Still image	HDMI Movie
RGB1 Still image	—	—	✓	✓	✓	✓	✓	✓	✓	✓
RGB1 Movie	—	—	✓	—	—	—	✓	—	✓	—
RGB2 Still image	✓	✓	—	—	✓	✓	✓	✓	✓	✓
RGB2 Movie	✓	—	—	—	—	—	✓	—	✓	—
VIDEO	✓	—	✓	—	—	—	✓	—	✓	—
S-VIDEO	✓	—	✓	—	—	—	✓	—	✓	—
DVI-D Still image	✓	✓	✓	✓	✓	✓	—	—	—	—
DVI-D Movie	✓	—	✓	—	—	—	—	—	—	—
HDMI Still image	✓	✓	✓	✓	✓	✓	—	—	—	—
HDMI Movie	✓	—	✓	—	—	—	—	—	—	—

✓: Two window display combination is possible

—: Two window display combination is not possible

Signals handled as “movie”:

- 480i, 576i, 480p, 576p, 1080/60i, 1080/50i, 1080/60p, 1080/50p, 1080/24sF, 1080/30p, 1080/25p, 1080/24p, 720/60p, 720/50p, NTSC, PAL, SECAM, NTSC4.43, PAL-M, PAL-N, PAL60

## Menu lock password

To initialize your password, consult your distributor.

## List of compatible signals

The following table specifies the types of signals compatible with the projector.

- Signals that show formats are as follows.

- V: Video
- S: S video
- D: DVI-D
- R: RGB
- Y: Y<sub>C</sub>B<sub>C</sub>R/Y<sub>P</sub>B<sub>P</sub>R
- H: HDMI

Mode	Resolution (Dots)	Scanning frequency		Dots clock frequency (MHz)	Format	Plug and play <sup>3</sup>				
		Horizontal (kHz)	Vertical (Hz)			RGB2	DVI-D EDID1	DVI-D EDID2	DVI-D EDID3	HDMI
NTSC/NTSC4.43/ PAL-M/PAL60	720 x 480i	15.7	59.9	—	V/S	—	—	—	—	—
PAL/PAL-N/SECAM	720 x 576i	15.6	50.0	—	V/S	—	—	—	—	—
525i (480i)	720 x 480i	15.7	59.9	13.5	R/Y	—	—	—	—	—
625i (576i)	720 x 576i	15.6	50.0	13.5	R/Y	—	—	—	—	—
525p (480p)	720 x 483	31.5	59.9	27.0	R/Y/H/D	—	✓	—	✓	✓
625p (576p)	720 x 576	31.3	50.0	27.0	R/Y/H/D	—	✓	—	✓	✓
750 (720)/60p	1 280 x 720	45.0	60.0	74.3	R/Y/H/D	—	✓	—	✓	✓
750 (720)/50p	1 280 x 720	37.5	50.0	74.3	R/Y/H/D	—	✓	—	✓	✓
1125 (1080)/60i <sup>1</sup>	1 920 x 1 080i	33.8	60.0	74.3	R/Y/H/D	—	✓	—	✓	✓
1125 (1080)/50i	1 920 x 1 080i	28.1	50.0	74.3	R/Y/H/D	—	✓	—	✓	✓
1125 (1080)/24p	1 920 x 1 080	27.0	24.0	74.3	R/Y/H/D	—	✓	—	✓	✓
1125 (1080)/24sF	1 920 x 1 080i	27.0	24.0	74.3	R/Y/H/D	—	—	—	—	—
1125 (1080)/25p	1 920 x 1 080	28.1	25.0	74.3	R/Y/H/D	—	✓	—	✓	—
1125 (1080)/30p	1 920 x 1 080	33.8	30.0	74.3	R/Y/H/D	—	—	—	—	—

## Chapter 6 Appendix — Technical information

Mode	Resolution (Dots)	Scanning frequency		Dots clock frequency (MHz)	Format	Plug and play <sup>3</sup>					
		Horizontal (kHz)	Vertical (Hz)			RGB2	DVI-D EDID1	DVI-D EDID2	DVI-D EDID3	HDMI	
1125 (1080)/60p	1 920 x 1 080	67.5	60.0	148.5	R/Y/H/D	—	✓	—	✓	✓	
1125 (1080)/50p	1 920 x 1 080	56.3	50.0	148.5	R/Y/H/D	—	✓	—	✓	✓	
VESA400	640 x 400	37.9	85.1	31.5	R/H/D	—	—	—	—	—	
VGA	640 x 400	31.5	70.1	25.2	R/H/D	—	—	—	—	—	
	640 x 480	31.5	59.9	25.2	R/H/D	✓	✓	✓	✓	✓	
	640 x 480	35.0	66.7	30.2	R/H/D	—	—	—	—	—	
	640 x 480	37.9	72.8	31.5	R/H/D	✓	—	✓	✓	✓	
	640 x 480	37.5	75.0	31.5	R/H/D	✓	—	✓	✓	✓	
SVGA	640 x 480	43.3	85.0	36.0	R/H/D	—	—	—	—	—	
	800 x 600	35.2	56.3	36.0	R/H/D	✓	—	✓	✓	✓	
	800 x 600	37.9	60.3	40.0	R/H/D	✓	—	✓	✓	✓	
	800 x 600	48.1	72.2	50.0	R/H/D	✓	—	✓	✓	✓	
	800 x 600	46.9	75.0	49.5	R/H/D	✓	—	✓	✓	✓	
MAC16	800 x 600	53.7	85.1	56.3	R/H/D	—	—	—	—	—	
	832 x 624	49.7	74.6	57.3	R/H/D	✓	—	✓	✓	✓	
	XGA	1 024 x 768	39.6	50.0	51.9	R/H/D	—	—	—	—	—
		1 024 x 768	48.4	60.0	65.0	R/H/D	✓	—	✓	✓	✓
		1 024 x 768	56.5	70.1	75.0	R/H/D	✓	—	✓	✓	✓
1 024 x 768		60.0	75.0	78.8	R/H/D	✓	—	✓	✓	✓	
MXGA	1 024 x 768	65.5	81.6	86.0	R/H/D	—	—	—	—	—	
	1 024 x 768	68.7	85.0	94.5	R/H/D	—	—	—	—	—	
	1 024 x 768	80.0	100.0	105.0	R/H/D	—	—	—	—	—	
	1 024 x 768	99.0	119.8	137.8	R/H/D	—	—	—	—	—	
MAC21	1 152 x 864	64.0	70.0	94.2	R/H/D	—	—	—	—	—	
	1 152 x 864	67.5	74.9	108.0	R/H/D	—	—	—	—	—	
	1 152 x 864	77.1	85.0	119.7	R/H/D	—	—	—	—	—	
1280 x 768	1 152 x 870	68.7	75.1	100.0	R/H/D	✓	—	✓	✓	✓	
	1 280 x 768	39.6	49.9	65.3	R/H/D	—	—	—	—	—	
1280 x 800	1 280 x 768	47.8	59.9	79.5	R/H/D	—	—	—	—	—	
	1 280 x 800	41.3	50.0	68.0	R/H/D	—	—	—	—	—	
MSXGA	1 280 x 800	49.7	59.8	83.5	R/H/D	✓ <sup>4</sup>	—	✓ <sup>4</sup>	✓ <sup>4</sup>	✓ <sup>4</sup>	
	1 280 x 960	60.0	60.0	108.0	R/H/D	—	—	—	—	—	
SXGA	1 280 x 1 024	64.0	60.0	108.0	R/H/D	✓	—	✓	✓	✓	
	1 280 x 1 024	80.0	75.0	135.0	R/H/D	✓	—	✓	✓	✓	
	1 280 x 1 024	91.1	85.0	157.5	R/H/D	—	—	—	—	—	
SXGA+	1 400 x 1 050	65.2	60.0	122.6	R/H/D	✓	—	✓	✓	✓	
	1 400 x 1 050	82.2	75.0	155.9	R/H/D	—	—	—	—	—	
WXGA+	1 440 x 900	55.9	59.9	106.5	R/H/D	—	—	—	—	—	
UXGA	1 600 x 1 200	75.0	60.0	162.0	R/H/D	✓	—	✓	✓	✓	
WSXGA+	1 680 x 1 050	65.3	60.0	146.3	R/H/D	—	—	—	—	—	
1920 x 1080	1 920 x 1 080 <sup>2</sup>	66.6	59.9	138.5	R/H/D	—	—	—	—	—	
WUXGA	1 920 x 1 200 <sup>2</sup>	74.0	60.0	154.0	R/H/D	✓	—	✓	—	—	

\*1 When a 1125 (1035)/60i signal was input, it is displayed as a 1125 (1080)/60i signal.

\*2 VESA CVT-RB (Reduced Blanking) compatible

\*3 Signals with a ✓ in the Plug and play columns are signals described in the projector's EDID (extended display identification data). If a signal has no ✓ in the Plug and play columns but has an entry in the Format column, it can be input. For signals without a ✓ in the Plug and play columns, there may be instances where resolution cannot be selected in the computer even though the projector supports them.

\*4 Only for PT-DW640U

### Note

- The number of display dots for PT-DW640U is 1 280 x 800, and that for PT-DX610U is 1 024 x 768. A signal with a different resolution is converted to the number of display dots and displayed.
- The "i" at the end of the resolution indicates an interlaced signal.
- When interlaced signals are connected, flickering may occur on the projected image.

# Specifications

The following table describes the specifications of the projector.

Model No.		PT-DW640U	PT-DW640UL	PT-DX610U	PT-DX610UL	
Power supply		AC 120 V 50 Hz/60 Hz				
Power consumption		710 W (6.8 A)				
		(0.2 W when [STANDBY MODE] is set to [ECO], and 6 W when set to [NORMAL])				
DLP chips	Panel size	16.5 mm (0.65") (aspect ratio 16:10)		17.8 mm (0.7") (aspect ratio 4:3)		
	Display method	1-unit DLP chips, DLP type				
	Number of pixels	1 024 000 pixels (1 280 x 800 dots)		786 432 pixels (1 024 x 768 dots)		
Lens	Power zoom	1.8 to 2.4:1	Optional	1.8 to 2.4:1	Optional	
	Power focus	F = 1.7 to 2.0 f = 25.6 mm to 33.8 mm		F = 1.7 to 2.0 f = 25.6 mm to 33.8 mm		
Luminous lamp		280 W UHM lamp x 2				
Light output		6 000 lm ** (ANSI)		6 500 lm ** (ANSI)		
Contrast ratio		2 000:1 (when [CONTRAST MODE] is [HIGH])				
Supported scanning frequency	For video signals (including S video)	Horizontal: 15.75 kHz/15.63 kHz, Vertical: 50 Hz/60 Hz				
	For RGB signals	Horizontal: 15 kHz to 91 kHz, Vertical: 50 Hz to 85 Hz PIAS (Panasonic Intelligent Auto Scanning) system				
		Dot clock frequency 162 MHz or less				
	For YC <sub>B</sub> C <sub>R</sub> /YP <sub>B</sub> P <sub>R</sub> signals	<ul style="list-style-type: none"> <li>• 525i (480i) Horizontal: 15.75 kHz, Vertical: 60 Hz</li> <li>• 525p (480p) Horizontal: 31.5 kHz, Vertical: 60 Hz</li> <li>• 750 (720)/60p Horizontal: 45 kHz, Vertical: 60 Hz</li> <li>• 1125 (1035)/60i Horizontal: 33.75 kHz, Vertical: 60 Hz</li> <li>• 1125 (1080)/50i Horizontal: 28.13 kHz, Vertical: 50 Hz</li> <li>• 1125 (1080)/24sF Horizontal: 27 kHz, Vertical: 48 Hz</li> <li>• 1125 (1080)/30p Horizontal: 33.75 kHz, Vertical: 30 Hz</li> <li>• 1125 (1080)/50p Horizontal: 56.25 kHz, Vertical: 50 Hz</li> </ul>	<ul style="list-style-type: none"> <li>• 625i (576i) Horizontal: 15.63 kHz, Vertical: 50 Hz</li> <li>• 625p (576p) Horizontal: 31.25 kHz, Vertical: 50 Hz</li> <li>• 750 (720)/50p Horizontal: 37.5 kHz, Vertical: 50 Hz</li> <li>• 1125 (1080)/60i Horizontal: 33.75 kHz, Vertical: 60 Hz</li> <li>• 1125 (1080)/24p Horizontal: 27 kHz, Vertical: 24 Hz</li> <li>• 1125 (1080)/25p Horizontal: 28.13 kHz, Vertical: 25 Hz</li> <li>• 1125 (1080)/60p Horizontal: 67.5 kHz, Vertical: 60 Hz</li> </ul>			
		• The SYNC/HD and VD terminals do not support 3 value SYNC.				
		For DVI-D signal	525p (480p), 625p (576p), 750 (720)/60p, 750 (720)/50p, 1125 (1080)/60i, 1125 (1080)/50i, 1125 (1080)/24p, 1125 (1080)/24sF, 1125 (1080)/25p, 1125 (1080)/30p, 1125 (1080)/60p, 1125 (1080)/50p			
		For HDMI signal	<ul style="list-style-type: none"> <li>• Displayable resolution: VGA to WUXGA (non-interlaced) WUXGA signal supports only VESA CVT-RB (Reduced Blanking) signal.</li> <li>• Dot clock frequency: 25 MHz to 162 MHz</li> </ul>			
525p (480p), 625p (576p), 750 (720)/60p, 750 (720)/50p, 1125 (1080)/60i, 1125 (1080)/50i, 1125 (1080)/24p, 1125 (1080)/24sF, 1125 (1080)/25p, 1125 (1080)/30p, 1125 (1080)/60p, 1125 (1080)/50p						
Color system	7 standards (NTSC/NTSC4.43/PAL/PAL-N/PAL-M/SECAM/PAL60)					
Projection screen size	1.27 m (50") - 15.24 m (600") <sup>2</sup>					
Screen aspect ratio	16:10		4:3			
Projection method	[FRONT/CEILING], [FRONT/FLOOR], [REAR/CEILING], [REAR/FLOOR]					

\*1 Value for the supplied standard zoom lens. The value varies depending on the lens. Measurement, measuring conditions and method of notation all comply with ISO21118 international standards.

\*2 The size is maximum 5.08 m (200") when ET-DLE055 lens is used.

## Chapter 6 Appendix — Specifications

Model No.		PT-DW640U	PT-DW640UL	PT-DX610U	PT-DX610UL
Terminals	<RGB 1 IN> terminal	1 set (BNC x 5) <b>RGB signals</b> 0.7 V [p-p] 75 Ω (SYNC ON GREEN: 1.0 V [p-p] 75 Ω) SYNC/HD TTL high impedance, automatic positive/negative polarity compatible VD TTL high impedance, automatic positive/negative polarity compatible <b>YPbPr signal</b> Y: 1.0 V [p-p] including synchronization signal, PbPr: 0.7 V [p-p] 75 Ω			
	<RGB 2 IN> terminal	1 set, high-density D-Sub 15p (female) <b>RGB signals</b> 0.7 V [p-p] 75 Ω (SYNC ON GREEN: 1.0 V [p-p] 75 Ω) SYNC/HD TTL high impedance, automatic positive/negative polarity compatible VD TTL high impedance, automatic positive/negative polarity compatible <b>YPbPr signal</b> Y: 1.0 V [p-p] including synchronization signal, PbPr: 0.7 V [p-p] 75 Ω			
	<DVI-D IN> terminal	1 set, DVI-D 24 p single link, DVI 1.0 compatible, HDCP compliant			
	<HDMI IN> terminal	1 set, HDMI 19 pin, HDCP compliant			
	<VIDEO IN> terminal	1 set, BNC 1.0 V [p-p] 75 Ω			
	<S-VIDEO IN> terminal	1 set, Mini DIN 4 p Y 1.0 V [p-p], C 0.286 V [p-p] 75 Ω S1 signal compatible			
	<SERIAL IN>/<SERIAL OUT> terminal	D-Sub 9 p, each set, RS-232C compatible, for computer control			
	<REMOTE 1 IN>/<REMOTE 1 OUT> terminal	M3 stereo mini jack, 1 set each for remote control (wired)/for projector serial control			
	<REMOTE 2 IN> terminal	1 set D-Sub 9 p (female) for contact control			
<LAN> terminal	1 set, (for RJ-45 network connection, PJLink compatible, 10Base-T/100Base-TX)				
<b>Power cable length</b>		3.0 m (118-1/8")			
<b>Outer case</b>		Molded plastic			
<b>Dimensions</b>		Width: 498 mm (19-19/32") Height: 175 mm (6-7/8") (with minimum feet length) Depth: 440 mm (17-5/16") (including the standard zoom lens)	Width: 498 mm (19-19/32") Height: 175 mm (6-7/8") (with minimum feet length) Depth: 432 mm (17") (including the lens cover)	Width: 498 mm (19-19/32") Height: 175 mm (6-7/8") (with minimum feet length) Depth: 440 mm (17-5/16") (including the standard zoom lens)	Width: 498 mm (19-19/32") Height: 175 mm (6-7/8") (with minimum feet length) Depth: 432 mm (17") (including the lens cover)
<b>Weight</b>		Approx 16.0 kg (35.3 lbs.) <sup>*3</sup> (including the standard zoom lens)	Approx 15.1 kg (33.3 lbs.) <sup>*3</sup>	Approx 16.0 kg (35.3 lbs.) <sup>*3</sup> (including the standard zoom lens)	Approx 15.1 kg (33.3 lbs.) <sup>*3</sup>
<b>Operating environment</b>		Operating environment temperature <sup>*4</sup> : 0 °C (32 °F) to 45 °C (113 °F) Operating environment humidity: 20 % to 80 % (no condensation)			
<b>Remote control</b>	<b>Power supply</b>	DC 3 V (AA/R6 battery x 2)			
	<b>Operating range</b>	Within 30 m (98'5") (when operated directly in front of signal receiver)			
	<b>Weight</b>	134 g (4.7 ozs.) (including batteries)			
	<b>Dimensions</b>	Width: 51 mm (2") Height: 176 mm (6-15/16") Depth: 22.7 mm (29/32")			

<sup>\*3</sup> Average value. Weight varies for each product.

<sup>\*4</sup> When using the projector at high altitudes (1 400 m (4 593 ft) – 2 700 m (8 858 ft) above sea level), the operating environment temperature will be 5 °C (41 °F) lower than the maximum limit.

### Note

- The model numbers of accessories and optional components are subject to change without notice.



# Dimensions

Units: mm

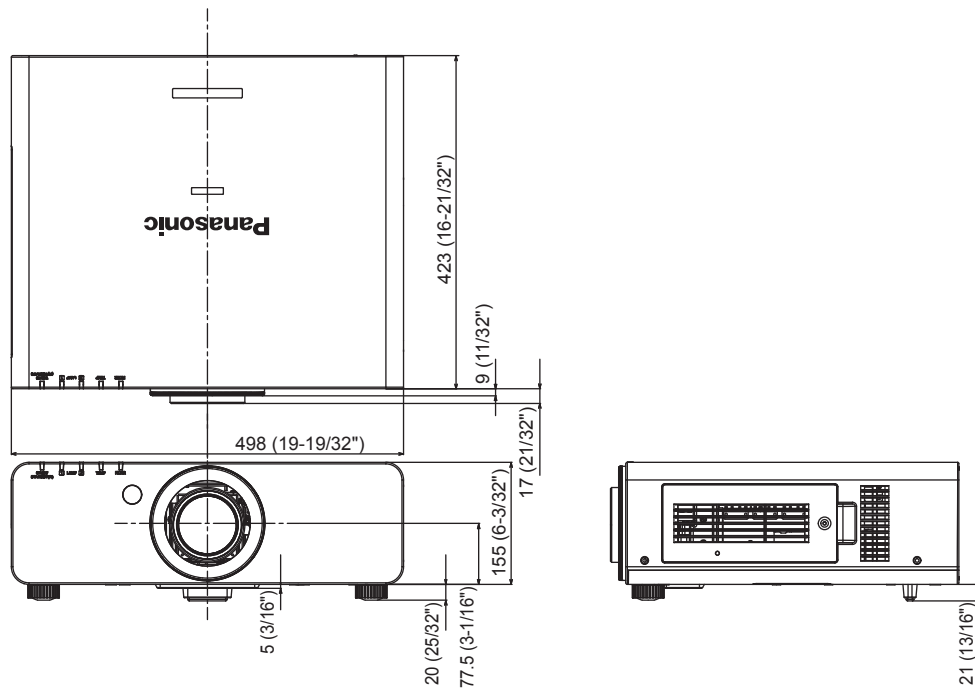

- \* The above shows the dimensions with the standard zoom lens attached.
- \* Actual dimensions may differ depending on the product.

# Ceiling mount bracket safeguards

- When installing the projector to a ceiling, be sure to use the specified ceiling mount bracket (ET-PKD56H: for high ceilings, ET-PKD55S: for low ceilings).
- When installing the projector, attach the drop-prevention set included with the ceiling mount bracket to the projector.  
If you need the special drop-prevention set (Product No.: TTRA0214), consult your dealer.
- Request for a qualified technician to do the installation.
- Takes no responsibility for any damage to the projector resulting from use of a ceiling mount bracket not manufactured by Panasonic or the inappropriate choice of location for installation, even if the warranty period of the projector has not expired.
- Unused products must be removed promptly by a qualified technician.
- Use a torque screwdriver or Allen torque wrench to tighten bolts to their specified tightening torques. Do not use tools such as electric screwdrivers or impact screwdrivers.
- For details, read the installation manual that comes with the ceiling mount bracket.
- The model numbers of accessories and optional components are subject to change without notice.

Bottom view

Model No. of ceiling mount bracket: ET-PKD56H (for high ceilings)

ET-PKD55S (for low ceilings)

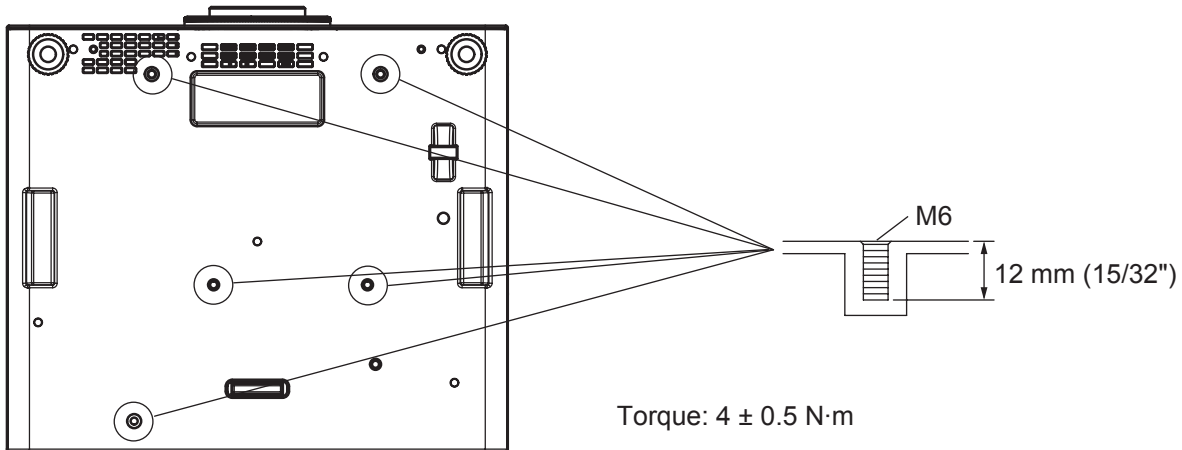

## Index

- A**
- Accessories ..... 17
  - <AC IN> terminal ..... 21
  - Adjusting adjustable feet ..... 34
  - [ADVANCED MENU] ..... 53, 64
  - [AI] ..... 58
  - Air filter unit ..... 112
  - Air filter unit compartment ..... 112
  - [ASPECT] ..... 60
  - <ASPECT> button
    - Remote control ..... 20, 49
  - Aspect function ..... 49
  - [AUTO SETUP] ..... 70
  - <AUTO SETUP> button
    - Projector body ..... 22, 48
    - Remote control ..... 20, 48
  - Auto setup function ..... 48
  - [AUTO SIGNAL] ..... 70
- B**
- [BACK COLOR] ..... 72
  - [BLANKING] ..... 64
  - [BRIGHTNESS] ..... 55
- C**
- Cautions on use ..... 16
  - Cautions when installing ..... 14
  - Cautions when transporting ..... 14
  - Ceiling mount bracket ..... 130
  - Ceiling mount bracket safeguards ..... 130
  - [CLAMP POSITION] ..... 65
  - [CLOCK PHASE] ..... 62
  - [COLOR] ..... 56
  - [COLOR CORRECTION] ..... 69
  - [COLOR MATCHING] ..... 68
  - [COLOR TEMPERATURE] ..... 56
  - Connecting the power cord ..... 41
  - Connection ..... 37
  - [CONTRAST] ..... 55
  - [CONTRAST MODE] ..... 69
  - [CONTROL DEVICE SETUP] ..... 90
  - [COOLING CONDITION] ..... 76
  - CRESTRON RoomView ..... 93, 106
  - [CUT OFF] ..... 74
- D**
- [DATE AND TIME] ..... 83
  - <DEFAULT> button
    - Remote control ..... 20, 51
  - Deleting the registered data ..... 86
  - [DIGITAL CINEMA REALITY] ..... 64
  - Dimensions ..... 129
  - Direct Power Off Function ..... 44
  - Display language ..... 53, 67
  - [DISPLAY OPTION] ..... 53, 68
  - [DISPLAY SETTING] ..... 89
  - Disposal ..... 16
  - <DVI-D> button
    - Projector body ..... 22, 48
    - Remote control ..... 20, 48
  - [DVI-D IN] ..... 70
- E**
- [EDGE BLENDING] ..... 65
  - <ENTER> button
    - Projector body ..... 22
    - Remote control ..... 20
  - Expanding signal lock-in range ..... 87
- F**
- Filter indicator ..... 111
  - <FOCUS> button
    - Remote control ..... 20, 45
  - [FREEZE] ..... 73
  - Function button ..... 49, 82
  - <FUNCTION> button
    - Remote control ..... 20, 49
- H**
- <HDMI> button
    - Projector body ..... 22
    - Remote control ..... 20, 48
  - [HDMI IN] ..... 71
  - [HIGH ALTITUDE MODE] ..... 76
- I**
- <ID ALL> button
    - Remote control ..... 20, 23
  - <ID SET> button
    - Remote control ..... 20, 23
  - [INITIALIZE] ..... 84
- Initial setting ..... 19
- [INPUT RESOLUTION] ..... 65
- Installation precautions ..... 14
- K**
- [KEYSTONE] ..... 63
- L**
- Lamp indicator ..... 110
  - [LAMP POWER] ..... 77
  - [LAMP RELAY] ..... 77
  - [LAMP SELECT] ..... 76
  - Lamp unit cover ..... 21
  - <LENS> button
    - Projector body ..... 22, 45
  - List of compatible signals ..... 125
  - [LOAD ALL USER DATA] ..... 84
- M**
- Main menu ..... 52
  - Main power switch ..... 21, 42
  - Maintenance ..... 112
  - Managing the sub memory list ..... 87
  - <MENU> button
    - Projector body ..... 22, 51
    - Remote control ..... 20, 51
  - Menu item ..... 52
  - [MENU LOCK] ..... 90
  - [MENU LOCK PASSWORD] ..... 90
- N**
- Navigating through the menu ..... 51
  - [NETWORK] ..... 54, 92
  - Network connections ..... 93
  - [NETWORK CONTROL] ..... 92
  - [NETWORK SETUP] ..... 92
  - [NETWORK STATUS] ..... 93
  - [NOISE REDUCTION] ..... 58
  - [NO SIGNAL SHUT-OFF] ..... 82
- O**
- <ON SCREEN> button
    - Remote control ..... 20, 47
  - [ON-SCREEN DISPLAY] ..... 71
  - On-screen menu ..... 51
  - Optional accessories ..... 18
- P**
- [PICTURE] ..... 52, 55
  - [PICTURE MODE] ..... 55
  - [POSITION] ..... 53, 60
  - Power cord ..... 41
  - Power indicator ..... 42
  - Power on button
    - Projector body ..... 22
  - Power standby button
    - Projector body ..... 22
    - Remote control ..... 20
  - Precautions for Use ..... 14
  - Projecting ..... 45
  - [PROJECTION METHOD] ..... 26, 75
  - [PROJECTOR ID] ..... 75
  - [PROJECTOR SETUP] ..... 54, 75
  - Protecting the registered data ..... 87
- R**
- [RASTER POSITION] ..... 66
  - Registering a signal to the list ..... 86
  - <REMOTE 1 IN> terminal ..... 24
  - <REMOTE 1 OUT> terminal ..... 24
  - <REMOTE 2 IN> terminal ..... 124
  - [REMOTE2 MODE] ..... 81
  - Remote control ..... 20
  - Remote control operations ..... 47
  - Removing/attaching the projection lens ..... 35
  - Renaming the registered data ..... 86
  - Replacing the air filter unit ..... 113
  - Replacing the lamp unit ..... 114
  - Replacing the unit ..... 113
  - Resetting to the factory default ..... 51
  - <RGB1> button
    - Projector body ..... 22, 48
    - Remote control ..... 48
  - <RGB2> button
    - Projector body ..... 22, 48
    - Remote control ..... 20, 48
  - [RGB IN] ..... 70
  - RoomView ..... 106
  - [RS-232C] ..... 80, 121
- S**
- [SAVE ALL USER DATA] ..... 83
  - [SCHEDULE] ..... 78
  - [SCREEN SETTING] ..... 69
  - Security ..... 15
  - [SECURITY] ..... 54, 89
  - [SECURITY PASSWORD] ..... 89
  - [SECURITY PASSWORD CHANGE] ..... 89
  - Selecting the input signal ..... 45
  - <SERIAL IN> terminal ..... 121
  - <SERIAL OUT> terminal ..... 121
  - [SERVICE PASSWORD] ..... 84
  - Setting remote control ID numbers ..... 23
  - Setting up ..... 26
  - [SHARPNESS] ..... 58
  - [SHIFT] ..... 60
  - <SHIFT> button
    - Remote control ..... 20, 45
  - <SHUTTER> button
    - Projector body ..... 22, 47
    - Remote control ..... 20, 47
  - [SHUTTER SETTING] ..... 73
  - [SIDE BY SIDE] ..... 73, 125
  - [SIGNAL LIST] ..... 54, 86
  - Specifications ..... 127
  - [STANDBY MODE] ..... 78
  - [STARTUP INPUT SELECT] ..... 79
  - [STARTUP LOGO] ..... 72
  - [STATUS] ..... 81
  - <STATUS> button
    - Remote control ..... 20, 48
  - <S-VIDEO> button
    - Projector body ..... 22, 48
    - Remote control ..... 20, 48
  - Switching off the projector ..... 43
  - Switching the input signal ..... 48
  - Switch on the projector ..... 42
  - [SYSTEM DAYLIGHT VIEW] ..... 57
  - [SYSTEM SELECTOR] ..... 59
- T**
- Temperature indicator ..... 111
  - [TEST PATTERN] ..... 54, 85
  - <TEST PATTERN> button
    - Remote control ..... 20, 49
  - [TEXT CHANGE] ..... 90
  - [TINT] ..... 56
  - Troubleshooting ..... 116
- V**
- <VIDEO> button
    - Projector body ..... 22, 48
    - Remote control ..... 20, 48
- W**
- [WHITE GAIN] ..... 57
- Z**
- [ZOOM] ..... 61
  - <ZOOM> button
    - Remote control ..... 45

## Information on Disposal in other Countries outside the European Union



These symbols are only valid in the European Union.  
If you wish to discard this product, please contact your local authorities or dealer and ask for the correct method of disposal.



EU



## Environment care information for users in China



This symbol is only valid in China.

---

# Panasonic Corporation

Web Site : <http://panasonic.net/avc/projector/>

© Panasonic Corporation 2012

---

## Panasonic System Communications Company of North America

One Panasonic Way 2F-13, Secaucus, NJ 07094

TEL: (877) 803 - 8492

## Panasonic Canada Inc.

5770 Ambler Drive, Mississauga, Ontario L4W 2T3

TEL: (905) 624 - 5010