

Operating Instructions Functional Manual

DLP™ Based Projector Commercial Use

Model No. PT-DZ570U
PT-DW530U
PT-DX500U

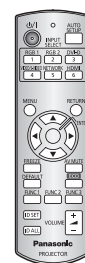
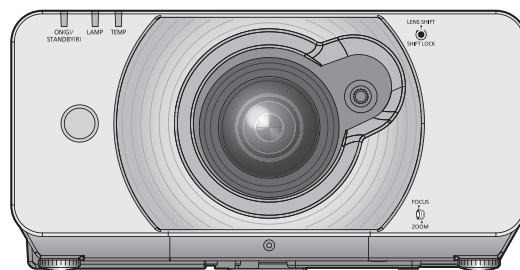

Thank you for purchasing a Panasonic Projector.

- Before operating this product, please read the instructions carefully and save this manual for future use.
- Before using your projector, be sure to read “Precautions with regard to safety” (➡ pages 8 to 16).

Important Safety Notice

Dear Panasonic Customer:

The following information should be read and understood as it provides details, which will enable you to operate the projector in a manner which is both safe to you and your environment, and conforms to legal requirements regarding the use of projectors. Before connecting, operating or adjusting this projector, please read these instructions completely and save this booklet with the projector for future reference. We hope it will help you to get the most out of your new product, and that you will be pleased with your Panasonic DLP™ Based projector. The serial number of your product may be found on its bottom. You should note it in the space provided below and retain this booklet in case service is required.

Model number: PT-DZ570U/PT-DW530U/PT-DX500U

Serial number:

WARNING: TO REDUCE THE RISK OF FIRE OR ELECTRIC SHOCK, DONOT EXPOSE THIS PRODUCT TO RAIN OR MOISTURE.

Power Supply: This Projector is designed to operate on 100 V - 240 V, 50 Hz/60 Hz AC, house current only.

CAUTION: The AC power cord which is supplied with the projector as an accessory can only be used for power supplies up to 125 V, 7 A. If you need to use higher voltages or currents than this, you will need to obtain a separate 250 V power cord. If you use the accessory cord in such situations, fire may result.



The lightning flash with arrowhead symbol, within an equilateral triangle, is intended to alert the user to the presence of uninsulated "dangerous voltage" within the product's enclosure that may be of sufficient magnitude to constitute a risk of electric shock to persons.



The exclamation point within an equilateral triangle is intended to alert the user to the presence of important operating and maintenance (servicing) instructions in the literature accompanying the product.

CAUTION: This equipment is equipped with a three-pin grounding-type power plug. Do not remove the grounding pin on the power plug. This plug will only fit a grounding-type power outlet. This is a safety feature. If you are unable to insert the plug into the outlet, contact an electrician. Do not defeat the purpose of the grounding plug.

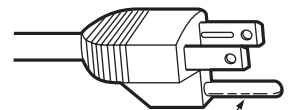

Do not remove

Pursuant to at the directive 2004/108/EC, article 9 (2)
Panasonic Testing Center
Panasonic Service Europe, a division of Panasonic Marketing Europe GmbH
Winsbergring 15, 22525 Hamburg, F.R. Germany

NOTICE:

- This product has a High Intensity Discharge (HID) lamp that contains mercury. Dispose may be regulated in your community due to environmental considerations. For disposal or recycling information, please contact your local authorities, or the Electronic Industries Alliance: <http://www.eiae.org>

WARNING:

This equipment has been tested and found to comply with the limits for a Class B digital device, pursuant to Part 15 of the FCC Rules. These limits are designed to provide reasonable protection against harmful interference in a residential installation. This equipment generates, uses and can radiate radio frequency energy and, if not installed and used in accordance with the instructions, may cause harmful interference to radio communications. However, there is no guarantee that interference will not occur in a particular installation. If this equipment does cause harmful interference to radio or television reception, which can be determined by turning the equipment off and on, the user is encouraged to try to correct the interference by one or more of the following measures:

- Reorient or relocate the receiving antenna.
- Increase the separation between the equipment and receiver.
- Connect the equipment into an outlet on a circuit different from that to which the receiver is connected.
- Consult the dealer or an experienced radio/TV technician for help.

FCC CAUTION: To assure continued compliance, follow the attached installation instructions and use only shielded interface cables when connecting to computer and/or peripheral devices. Any changes or modifications not expressly approved by Panasonic Corp. of North America could void the user's authority to operate this device.

WARNING:

- Not for use in a computer room as defined in the Standard for the Protection of Electronic Computer/Data Processing Equipment, ANSI/NFPA 75.
- For permanently connected equipment, a readily accessible disconnect device shall be incorporated in the building installation wiring.
- For pluggable equipment, the socket-outlet shall be installed near the equipment and shall be easily accessible.

Declaration of Conformity

Model Number: PT-DZ570U/PT-DW530U/PT-DX500U
Trade Name: **Panasonic**
Responsible party: Panasonic Solutions Company
Address: 3 Panasonic Way, Secaucus, NJ 07094
Telephone number: (877) 803 - 8492
E-mail: projectorsupport@us.panasonic.com

This device complies with Part 15 of the FCC Rules. Operation is subject to the following two conditions: (1) This device may not cause harmful interference, and (2) this device must accept any interference received, including interference that may cause undesired operation.

Information on Disposal in other Countries outside the European



These symbols are only valid in the European Union.

If you wish to discard this product, please contact your local authorities or dealer and ask for the correct method of disposal.



Environment care information for users in China



This symbol is only valid in China.

Easy setup and improved serviceability

- ▶ The dual-time zoom lens and the lens shift allow more flexible setup of the projector.
- ▶ New lighting system with excellent dust resistance reduces the needs to replace filters as often (only the accessory filter is used during lamp replacement). The service requirements are minimized.

Improved color reproducibility and fine display

- ▶ The lamp boost function and WUXGA model are installed to improve color reproducibility and fine display.

Energy saving in the ECO mode

- ▶ The lamp power is optimized to reduce power consumption according to the installation environment of the projector, input signal status, and image muting.
(If [AUTO POWER SAVE] is turned [ON] from [ECO MANAGEMENT])

Quick steps

For details, see the corresponding pages.

1. **Set up your projector.**
(➡ page 22)



2. **Connect with other devices.**
(➡ page 28)



3. **Connect the power cord.**
(➡ page 31)



4. **Start projecting.**
(➡ page 32)



5. **Select the input signal.**
(➡ page 34)



6. **Adjust the image.**
(➡ page 34)

Contents

Be sure to read "Precautions with regard to safety". (→ pages 8 to 16)

Important Information

Important Safety Notice	2
Precautions with regard to safety	8
WARNING.....	8
CAUTION.....	11
Cautions when transporting	11
Cautions when installing	12
Security	14
Cautions on use	14
Cleaning and maintenance	15
Disposal	15
Accessories.....	16
Start-up display	17

Preparation

About Your Projector	18
Remote control.....	18
Projector body.....	19
Setting projector ID number to remote control.....	21

Getting Started

Setting up	22
Projection method.....	22
Screen size and throw distance	23
Front leg adjusters and throwing angle.....	27
Connections	28
Before connection to the projector.....	28
Connecting example	
AV equipment.....	29
Computers.....	30

Basic Operation

Powering ON/OFF	31
Connecting the power cord	31
Powering up the projector	32
Making adjustment and selection.....	32
Powering off the projector	33
Direct power off function	33

Projecting	34
Selecting the input signal.....	34
How to adjust the focus, zoom and shift	34
Adjustment range after lens position (optical shift).....	35

Basic operations using the remote control	36
Using the AV MUTE function.....	36
Capturing an image.....	36
Switching the input signal	36
Automatic adjustment	37
Using the function buttons	37
Using ECO button.....	37
Controlling the volume of the speaker	38

Settings

Menu Navigation	39
Navigating through the menu.....	39
MAIN MENU	40
SUB MENU	40
PICTURE menu	42
PICTURE MODE	42
CONTRAST	42
BRIGHTNESS.....	43
COLOR	43
TINT	43
COLOR TEMPERATURE	43
WHITE GAIN.....	44
SHARPNESS.....	45
NOISE REDUCTION	45
AI	45
DAYLIGHT VIEW	45
SYSTEM SELECTOR.....	46
To display pictures complying with the sRGB standard	46
POSITION menu	47
SHIFT.....	47
ASPECT.....	47
ZOOM	48
CLOCK PHASE	49

Important Information

Preparation

Getting Started

Basic Operation

Settings

Maintenance

Appendix

Contents

Important Information	KEYSTONE (PT-DZ570U only)	49	AUDIO SETTING	66
	ADVANCED MENU	50	STATUS	67
	DIGITAL CINEMA REALITY	50	DATE AND TIME	67
	BLANKING	50	SAVE ALL USER DATA	68
	INPUT RESOLUTION	51	LOAD ALL USER DATA	68
	CLAMP POSITION	51	INITIALIZE	69
	FRAME RESPONSE	51	SERVICE PASSWORD	69
	RASTER POSITION	51	TEST PATTERN menu	70
	DISPLAY LANGUAGE menu	52	TEST PATTERN	70
	Changing the display language	52	SIGNAL LIST menu	71
DISPLAY OPTION menu	53	Registering a signal to the list	71	
COLOR MATCHING	53	Renaming a registered data	71	
COLOR CORRECTION	54	Deleting a registered data	71	
SCREEN SETTING	54	SECURITY menu	72	
WAVEFORM MONITOR (PT-DZ570U only)	55	SECURITY PASSWORD	72	
AUTO SIGNAL	55	SECURITY PASSWORD CHANGE	72	
AUTO SETUP	56	DISPLAY SETTING	73	
RGB IN (Only RGB input)	57	TEXT CHANGE	73	
DVI-D IN	57	MENU LOCK	73	
HDMI IN	57	MENU LOCK PASSWORD	73	
ON-SCREEN DISPLAY	58	CONTROL DEVICE SETUP	74	
CLOSED CAPTION SETTING (for NTSC, 525i (480i) input only)	58			
BACK COLOR	59			
STARTUP LOGO	59			
Managing the sub memory list	59			
FREEZE	60			
SIDE BY SIDE (PT-DZ570U and PT-DW530U only)	60			
PROJECTOR SETUP menu	62			
PROJECTOR ID	62			
INSTALLATION	62			
COOLING CONDITION	62			
HIGH ALTITUDE MODE	63			
LAMP POWER	63			
ECO MANAGEMENT	63			
SCHEDULE	64			
RS-232C	65			
REMOTE MODE	66			
FUNCTION BUTTON	66			
		Maintenance		
		Monitor Lamp indicators	75	
		Managing the indicated problems	75	
		Replacement	77	
		Before replacing the unit	77	
		Replacing the unit	77	
		Troubleshooting	80	
		Appendix		
		Technical Information	82	
		Serial terminal	82	
		REMOTE IN terminal	85	
		Two window display combination list (PT-DZ570U/PT-DW530U)	86	
		Restoring the MENU LOCK PASSWORD to default	86	
		List of compatible signals	87	

Specifications	89
Dimensions	91
About brand	91
Ceiling mount bracket safeguards.....	92
Attachment procedure.....	92
Cautions on Wireless LAN Module	
Installation.....	93
Procedure	93
Index	94

Important
Information

Preparation

Getting Started

Basic Operation

Settings

Maintenance

Appendix

Precautions with regard to safety

WARNING

■ POWER

The wall outlet or the circuit breaker shall be installed near the equipment and shall be easily accessible when problems occur. If the following problems occur, cut off the power supply immediately.

Continued use of the projector in these conditions will result in fire or electric shock.

- If foreign objects or water get inside the projector, cut off the power supply.
- If the projector is dropped or the cabinet is broken, cut off the power supply.
- If you notice smoke, strange smells or noise coming from the projector, cut off the power supply.

Please contact an Authorized Service Center for repairs, and do not attempt to repair the projector yourself.

During a thunderstorm, do not touch the projector or the cable.

Electric shocks can result.

Do not do anything that might damage the power cord or the power plug.

If the power cord is used while damaged, electric shocks, short-circuits or fire will result.

- Do not damage the power cord, make any modifications to it, place it near any hot objects, bend it excessively, twist it, pull it, place heavy objects on top of it or wrap it into a bundle.

Ask an Authorized Service Center to carry out any repairs to the power cord that might be necessary.

Insert the power plug securely into the wall outlet.

If the plug is not inserted correctly, electric shocks or overheating will result.

- Do not use anything other than the provided power cord.
- Do not use the provided power cord for other electrical equipment.
- Do not use plugs which are damaged or wall outlets which are coming loose from the wall.

Clean the power plug regularly to prevent it from becoming covered in dust.

Failure to observe this will cause a fire.

- If dust builds up on the power plug, the resulting humidity can damage the insulation.
 - If not using the projector for an extended period of time, pull the power plug out from the wall outlet.
- Pull the power plug out from the wall outlet and wipe it with a dry cloth regularly.

Do not handle the power plug with wet hands.

Failure to observe this will result in electric shocks.

Do not overload the wall outlet.

If the power supply is overloaded (ex., by using too many adapters), overheating may occur and fire will result.

■ ON USE/INSTALLATION

Do not place liquid containers on top of the projector.

If water spills onto the projector or gets inside it, fire or electric shocks will result.

If any water gets inside the projector, contact an Authorized Service Center.

Do not place the projector on soft materials such as carpets or sponge mats.

Doing so will cause the projector to overheat, which can cause burns, fire or damage to the projector.

Do not set up the projector in humid or dusty places or in places where the projector may come into contact with oily smoke or steam, ex. a bathroom.

Using the projector under such conditions will result in fire, electric shocks or components deterioration.

Components deterioration (such as ceiling mount brackets) may cause the projector which is mounted on the ceiling to fall down.

Do not install this projector in a place which is not strong enough to take the full weight of the projector or on top of a surface which is sloped or unstable.

Failure to observe this will cause projector to fall down or tip over the projector, and severe injury or damage could result.

Do not place another projector or other heavy objects on top of the projector.

Failure to observe this will cause the projector to become unbalanced and fall, which could result in damage or injury. The projector will be damaged or deformed.

Installation work (such as ceiling suspension) should only be carried out by a qualified technician.

If installation is not carried out and secured correctly it can cause injury or accidents, such as electric shocks.

- Do not use anything other than an authorized ceiling mount bracket.
- Be sure to use the provided accessory wire with an eye bolt as an extra safety measure to prevent the projector from falling down. (Install in a different location to the ceiling mount bracket)

Do not cover the air inlet port or the air outlet port.

Doing so will cause the projector to overheat, which can cause fire or damage to the projector.

- Do not place the projector in narrow, badly ventilated places such as closets or bookshelves.
- Do not place the projector on cloth or papers, as these materials could be drawn into the air inlet port.

Do not place your hands or other objects close to the air outlet port.

Doing so will cause burns or damage your hands or other objects.

- Heated air comes out of the air outlet port. Do not place your hands or face, or objects which cannot withstand heat close to this port.

Do not look and place your skin into the lights emitted from the lens while the projector is being used.

Doing so can cause burns or loss of sight.

- Strong light is emitted from the projector's lens. Do not look or place your hands directly into this light.
- Be especially careful not to let young children look into the lens. In addition, turn off the power and disconnect the power plug when you are away from the projector.

Do not insert any foreign objects into the projector.

Doing so will cause fire or electric shocks.

- Do not insert any metal objects or flammable objects into the projector or drop them onto the projector.

Never attempt to remodel or disassemble the projector.

High voltages can cause fire or electric shocks.

- For any inspection, adjustment and repair work, please contact an Authorized Service Center.

Do not project an image with the lens cover attached.

Doing so can cause fire.

When replacing the lamp, do not touch the fan with your finger or another part of your body.

If you do so, you may get hurt.

■ ACCESSORIES

Do not use or handle the batteries improperly, and refer to the following.

Failure to observe this will cause burns, batteries to leak, overheat, explode or catch fire.

- Do not use unspecified batteries.
- Use manganese batteries but not rechargeable batteries.
- Do not disassemble dry cell batteries.
- Do not heat the batteries or place them into water or fire.
- Do not allow the + and – terminals of the batteries to come into contact with metallic objects such as necklaces or hairpins.
- Do not store batteries together with metallic objects.
- Store the batteries in a plastic bag and keep them away from metallic objects.
- Make sure the polarities (+ and –) are correct when inserting the batteries.
- Do not use a new battery together with an old battery or mix different types of batteries.
- Do not use batteries with the outer cover peeling away or removed.
- Remove the empty batteries from the remote control at once.
- Insulate the battery using tape or something similar before disposal.

Precautions with regard to safety

Do not allow children to reach the AA/R6/LR6 batteries.

- The battery can cause personal injury if swallowed.
- If swallowed, seek medical advice immediately.

If the battery fluid leaks, do not touch it with bare hands, and take the following measures if necessary.

- Battery fluid on your skin or clothing could result in skin inflammation or injury.
Rinse with clean water and seek medical advice immediately.
- Battery fluid coming in contact with your eyes could result in loss of sight.
In this case, do not rub your eyes. Rinse with clean water and seek medical advice immediately.

Do not disassemble the lamp unit.

If the lamp breaks, it could cause injury.

Lamp replacement

The lamp has high internal pressure. If improperly handled, an explosion and severe injury or accidents will result.

- Replacement of the lamp should be carried out by a qualified technician.
- The lamp can easily explode if struck against hard objects or dropped.
- Before replacing the lamp, be sure to disconnect the power plug from the wall outlet.
Electric shocks or explosions can result if this is not done.
- When replacing the lamp, allow it to cool for at least one hour before handling it otherwise it can cause burns.

Do not allow infants or pets to touch the remote control unit.

- Keep the remote control unit out of the reach of infants and pets after using it.

Keep the attached screws and plain washers away from babies and infants.

- If a baby swallows a screw by accident, it may be affected badly.
- If a baby seems to have swallowed a screw, consult the doctor immediately.

CAUTION

■ POWER

When disconnecting the power cord, be sure to hold the power plug and power connector.

If the power cord itself is pulled, the lead will become damaged, and fire, short-circuits or serious electric shocks will result.

When not using the projector for an extended period of time, disconnect the power plug from the wall outlet and remove the batteries from the remote control.

Disconnect the power plug from the wall outlet before carrying out any cleaning.

Electric shocks can result if this is not done.

■ ON USE/INSTALLATION

Do not put your weight on this projector.

You could fall or the projector could break, and injury will result.

- Be especially careful not to let young children stand or sit on the projector.

Do not place the projector in extremely hot locations.

Doing so will cause the outer casing or internal components to deteriorate, or result in fire.

- Take particular care in locations exposed to direct sunlight or near stoves.

Always disconnect all cables before moving the projector.

Moving the projector with cables still attached can damage the cables, which will cause fire or electric shocks to occur.

■ ACCESSORIES

Do not use the old lamp unit.

If used it could cause lamp explosion.

If the lamp has broken, ventilate the room immediately. Do not touch or bring your face close to the broken pieces.

Failure to observe this will cause the user to absorb the gas which was released when the lamp broke and which contains nearly the same amount of mercury as fluorescent lamps, and the broken pieces will cause injury.

- If you believe that you have absorbed the gas or that the gas has got into your eyes or mouth, seek medical advice immediately.
- Ask your dealer about replacing the lamp unit and check the inside of the projector.

Cautions when transporting

Please take care to keep them away from vibration and impacts, both the projector and the lens are precision-made and easily susceptible to damage.

When transporting the projector, the leg adjusters must be housed and do not hold them. Please securely hold only its bottom and none of its other parts or surfaces as this will result in malfunctions.

Precautions with regard to safety

Cautions when installing

■ Do not use under the following conditions.

- **Do not set up the projector outdoors.**
The projector is designed for indoor use only.
- **Avoid setting up in places which are subject to vibration or shocks.**
If the projector is installed in a place where vibrations are transmitted or mounted in a car or a vessel, vibrations or impacts will result in damage to the internal parts, causing failure. Install the product in a place free from vibrations and impacts.
- **Avoid setting up in places which are subject to sudden temperature changes, such as near an air conditioner or lighting equipment.**
Failure to observe this will result in malfunctions or the lamp life will be shortened.
See "■ TEMP indicator" on page 76.
- **Avoid setting up in places which are near high-voltage power lines or near motors.**
The product will be exposed to interference if it is installed in the vicinity of high-voltage electrical power lines or power sources.
- **Do not install the projector at elevations higher than 2 700 m (8 858 ft) above sea level.**
If using this projector at high elevations 1 400 - 2 700 m (4 593 - 8 858 ft) above sea level, set [HIGH ALTITUDE MODE] to [ON].
If using this projector at elevations lower than 1 400 m (4 593 ft) above sea level, set [HIGH ALTITUDE MODE] to [OFF].
Failure to observe this will result in malfunctions or the lamp life or life of other components will be shortened.
- **When installing and using the projector at an angle that exceeds 30° vertically, set [COOLING CONDITION].**
Failure to observe this will result in malfunctions or the lamp life or other components will be shortened.

■ Lens Focus

Do not adjust the lens focus in the initial period after switching the projector on. The high clarity projector lens is thermally affected by the light from the light source, making the focus unstable in the period just after switching on. Please allow a warm-up time of at least 30 minutes before adjusting the lens focus.

■ Be sure to ask a specialized technician when installing the product to a ceiling.

If the product is to be installed hanging from the ceiling, purchase an optional Ceiling Mount Attachment (For high ceilings: Model No. ET-PKD110H, For low ceilings: Model No. ET-PKD110S). Please call a specialized technician or contact an Authorized Service Center for installation.

■ Cautions when setting the projectors 1

- When installing and using the projector with a method other than floor standing installing using adjustable feet, fix it with the 4 ceiling mounting screws (shown in the figure).
(Screw diameter: M4, Tapping depth inside set: 7 mm)
- When installing the projector with a method other than floor standing installing, do not adjust its angle with the adjustable feet. Doing so can break the set.

Ceiling mounting screws (M4)

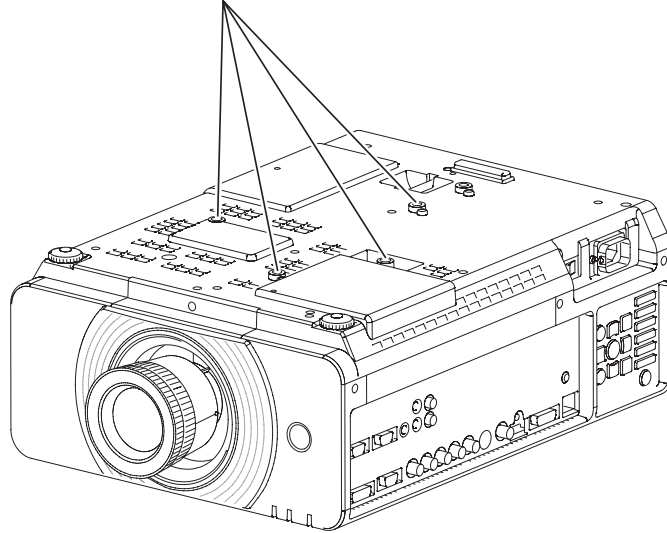

Precautions with regard to safety

■ Cautions when setting the projectors 2

- Make a clearance of at least 5 mm between the projector bottom and setting surface by inserting spacers (metallic) etc. between them.
- Do not stack the projectors without using frame or shelf.
- Do not cover the ventilation openings or place anything within 50 cm (20") of them as this may cause damage or injury.
- Avoid heating or cooling air of the air conditioning systems directly blow on to the projector ventilation openings.
- You can tilt the projector within ± 15 degrees horizontally.

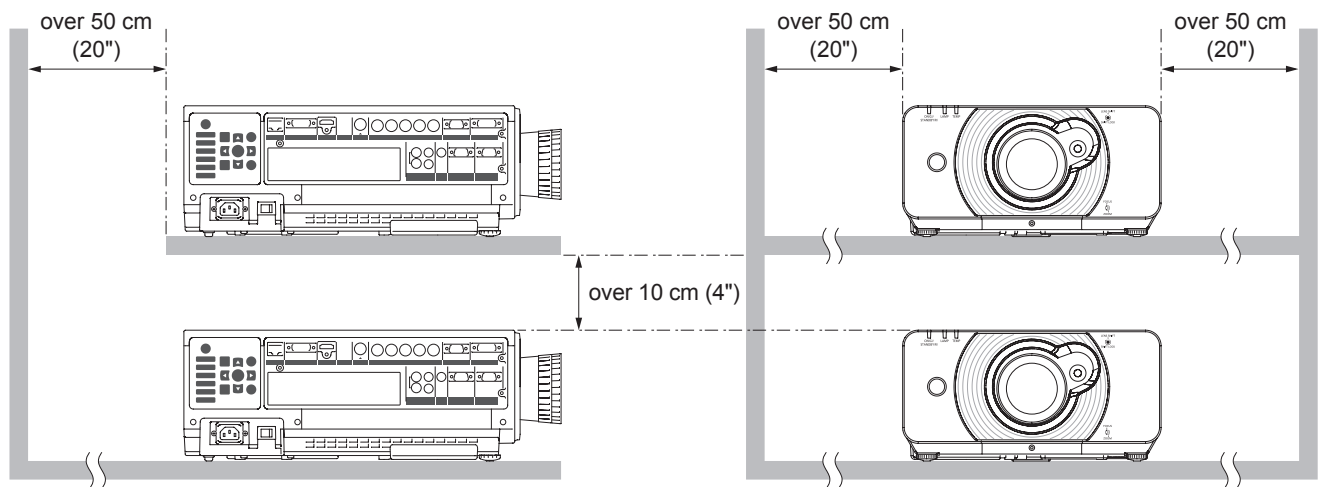
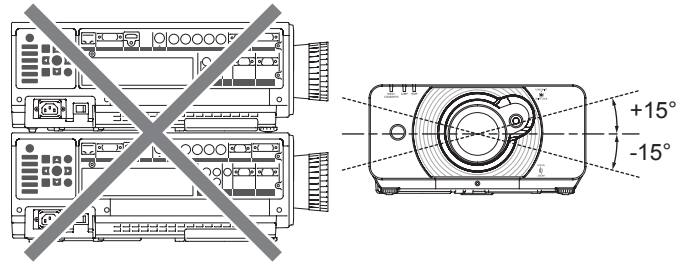

- When placing the projector in confined space, a ventilation or air conditioning system must be equipped, and keep enough ventilation space on the rear and both sides of the projector.

Security

■ Take safety measures against following incidents.

- Personal information being leaked via this product.
- Unauthorized operation of this product by a malicious third party.
- Interfering or stopping of this product by a malicious third party.

■ Security instruction

- The connecting network must be secured by firewall or others.
- Change your password regularly.
- Do not use a password that is simple to guess.
- Panasonic and its affiliate companies would never directly inquire about your password.
- Do not share your password with the general public.
- Set a password, and place restrictions on the users who can log in.

Cautions on use

■ In order to get the picture quality

- Draw curtains or blinds over windows and turn off any lights near the screen to prevent outside light or light from indoor lamps from shining onto the screen.
- Depending on where the projector is used, air exhaust vents or the warm air from air conditioning can cause a shimmering effect on the screen. For this reason, take care not to shield the air exhaust vents and consider the direction of the air flowing from air conditioning.

■ Do not touch the surface of the projector lens with your bare hand.

If the surface of the lens becomes dirty from fingerprints or anything else, this will be magnified and projected onto the screen. Please put the lens cover on the projector when you do not use it.

■ Do not move the projector while it is operating or subject it to vibration or impact.

The service life of its internal components will be shortened.

■ The projector has a high pressure mercury lamp that is characterized as follows:

- The brightness of the lamp will decrease over time.
- The lamp may explode or shorten the lamp life by shocks or chipping damage.
- In rare cases, it may burst shortly after the first use.
- The possibility of its bursting increases when the lamp is used beyond the replacement time.
- If the lamp bursts, gas inside the lamp is released in the form of smoke.
- The life of a mercury lamp varies according to the individual difference or conditions of use.
- In particular, turning the power on and off frequently and/or repeatedly as well as continuous use for 22 hours will greatly affect the life cycle. Provide a lamp for replacement in advance.
- Lamp deterioration accelerates when used continuously for 22 hours or more.

■ Connection to external device

When connecting the projector to a computer or external device, use the power cord supplied with the corresponding device and a commercially available shielded interface cable.

■ Optical components

It may be necessary to replace the optical components such as DLP chips and Polarizing plates in less than 1 year if using the projector in a high temperature environment or in a very dusty, oily smoke or tobacco smoke environment. For more details, please contact your dealer.

■ DLP chips

The DLP chips are precision-made. Note that in rare cases, pixels of high precision could be missing or always lit, but this is not a malfunction. Please take note that directing a laser beam onto the lens surface can damage the DMD element.

Cleaning and maintenance

■ Ask an Authorized Service Center to clean the inside of the projector at least two years.

If dust is left to build up inside the projector without being cleaned out, it can result in fire or problems with operation. It is a good idea to clean the inside of the projector before the season when humid weather arrives. Ask your nearest Authorized Service Center to clean the projector when required.

Please discuss with the Authorized Service Center regarding cleaning costs.

- **Be sure to remove the power plug from the wall outlet before cleaning.**
- **Use soft and dry cloth to clean the cabinet.**

Use a soft cloth moistened in warm water to clean away oil. Do not use solvents such as benzene, thinner, and alcohol, detergents for kitchens, or a chemical cloth. If using such solvents, the outer case will become deformed, and the paint may peel off.

- **Do not clean the lens surface with fuzzy or dusty cloths.**

If dust adheres to the lens, it will be magnified and projected on the screen. Use a soft and clean cloth to wipe off dust.



Disposal

When discarding this product, please contact your local authorities or dealer and ask for the correct method of disposal.

Precautions with regard to safety

Accessories

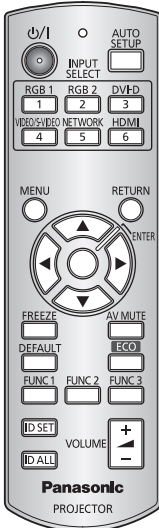
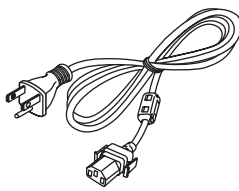
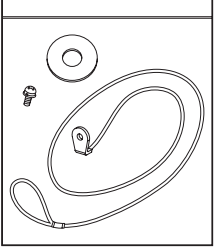
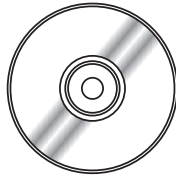
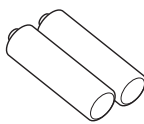
Make sure the following accessories are provided with your projector.

Remote control (x1) (N2QAYB000566)	Power cord (x1) (TXFSX02RPKZ)	Drop-prevention bracket (x1) (TTRA0244)	
			
	CD-ROM (x1) (TXFQB02VKN9)	AA/R6/LR6 batteries for remote control (x2)	Lens cover (x1) (TKKL5519)
			

Options	Model No.
Ceiling bracket	For high ceiling : ET-PKD110H, For low ceiling : ET-PKD110S
Replacement Lamp Unit	ET-LAD60A (1 bulb), ET-LAD60AW (2 bulbs)
Wireless LAN Module	ET-WM200U

Attention

- After unpacking the projector, discard the power cord cap and packaging material properly.
- For lost accessories, consult your dealer.
- The part numbers of accessories and separately sold components are subject to change without notice.
- Store small parts in an appropriate manner, and keep them away from young children.

Start-up display

The LANGUAGE and INITIAL SETTING menu will be displayed when the projector is turned on for the first time or after it has been initialized. (➔page 69)
Navigate the DISPLAY OPTION menu to set the menus in accordance to its application and environment settings.

Note

- When the projector is turned on for the first time, you may be required to adjust the “zoom ring” and “focus ring” (➔page 19) on the top of the projector body to make the menu screen clearer.
For details, see POSITION THE IMAGE. (➔page 34))

LANGUAGE

- 1) Press ▲▼ to select the desired language.

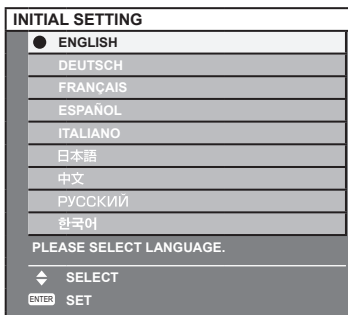

- 2) Press <ENTER> to proceed to INITIAL SETTING menu.

INITIAL SETTING

- 1) Press ▲▼ to select the desired menu.
- 2) Press ◀▶ to change the settings in the menu.

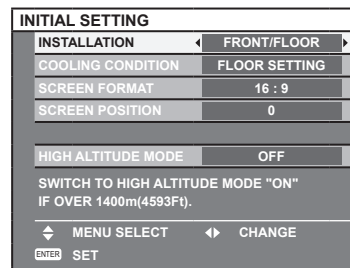

- [INSTALLATION] (➔page 62)
- [COOLING CONDITION] (➔page 62)
- [SCREEN FORMAT] (➔page 54)
- [SCREEN POSITION] (➔page 54)
- [HIGH ALTITUDE MODE] (➔page 63)

Note

- To return to LANGUAGE menu, press [RETURN] in INITIAL SETTING menu.

About Your Projector

Remote control

Top view

Remote control signal emitters

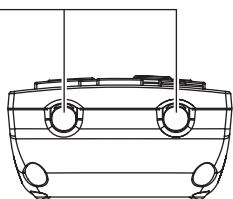

Installing/removing batteries

Press the tab and lift up the cover.

Insert the batteries according to the polarity diagram indicated inside. (insert the \ominus side first).

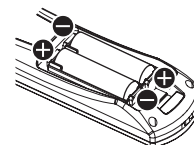
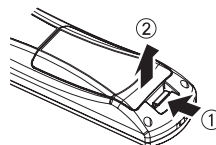

Remove the batteries in the reverse order to setting.

Front view

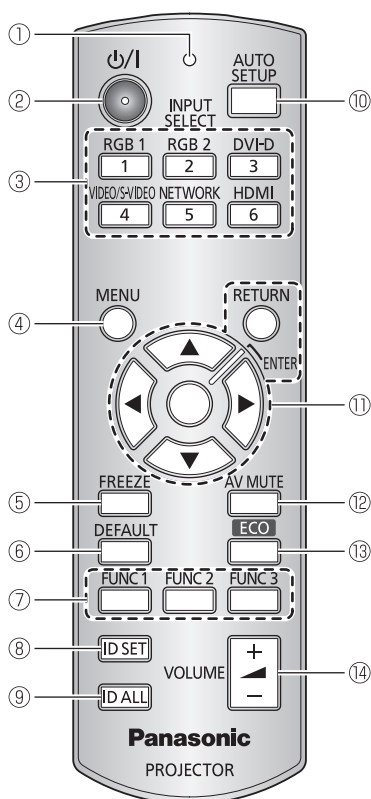

- ① **Remote control indicator**
Flashes by pressing any buttons
- ② Switch between stand-by mode and projection mode.
- ③ These buttons select the RGB1, RGB2, DVI-D, VIDEO, S-VIDEO and HDMI terminals. (➔page 36)
- ④ Displays and clears the main menu, and returns to the previous menu when the menu is displayed.(➔page 39)
- ⑤ Capture the projected image as a frozen picture. (➔page 36)
- ⑥ Restores the default factory setting. (➔page 39)
- ⑦ Assign the frequently use functions from options for shortcut. (➔page 37)
- ⑧ Specifies the ID of the remote control. (➔page 21)
- ⑨ Makes the remote control available to control any ID projectors. (➔page 21)
- ⑩ Pressing this button while projecting an image automatically corrects the picture positioning on the screen. While the auto setup feature is active, a message "PROGRESS" appears on the screen. (➔page 37)
- ⑪ Navigate through the menu items with \blacktriangle \blacktriangledown \blacktriangleleft \blacktriangleright , and activate them with the <ENTER> button. (➔page 39)
- ⑫ Turn off the projection temporarily. (➔page 36)
- ⑬ Opens [ECO MANAGEMENT] menu. (➔page 37)
- ⑭ Control to adjust the volume of the speaker. (➔page 38)

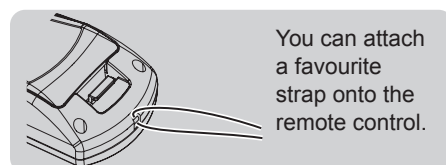

You can attach a favourite strap onto the remote control.

Attention

- Do not drop the remote control.
- Avoid contact with liquids or moisture.
- Do not attempt to modify or disassemble the remote control.
- Do not let strong light shine onto the signal receptor. The remote control may malfunction under strong light such as fluorescent.

Note

- The remote control can be used within a distance of about 30 m if pointed directly at the remote control receiver. The remote control can control at angles of up to $\pm 15^\circ$ vertically and $\pm 30^\circ$ horizontally, but the effective control range may be reduced.
- If there are any obstacles between the remote control and the remote control signal receptor, the remote control may not operate correctly.
The signal will be reflected off the screen. The operating range may differ due to the screen material.
- When the projector receives a signal from the remote control, the Power indicator will flash.

Projector body

Front view

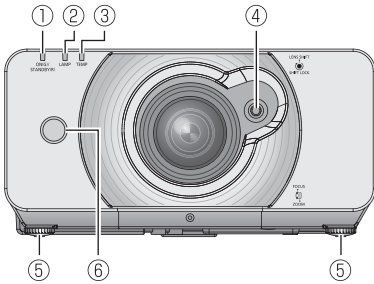

Rear view

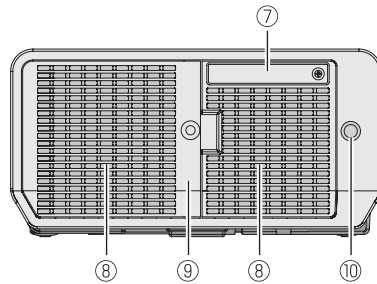

Top view

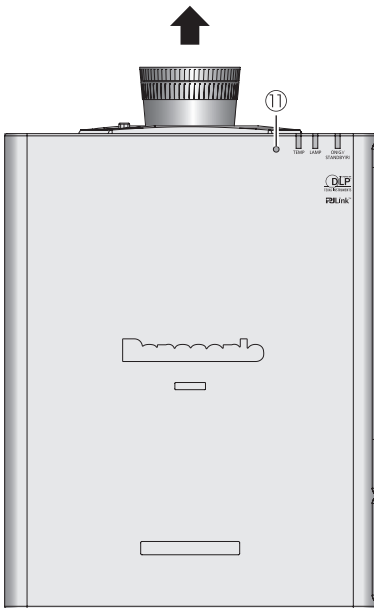

Bottom view

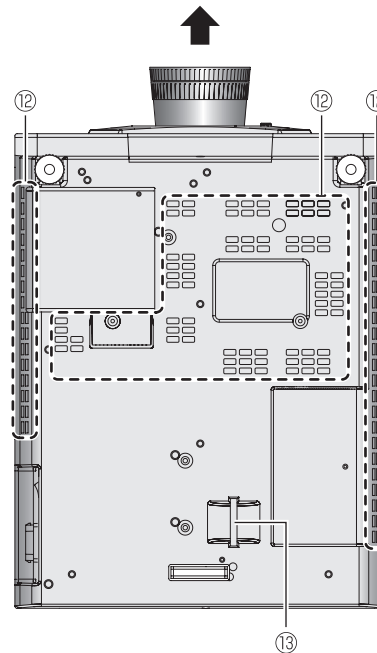

Side views

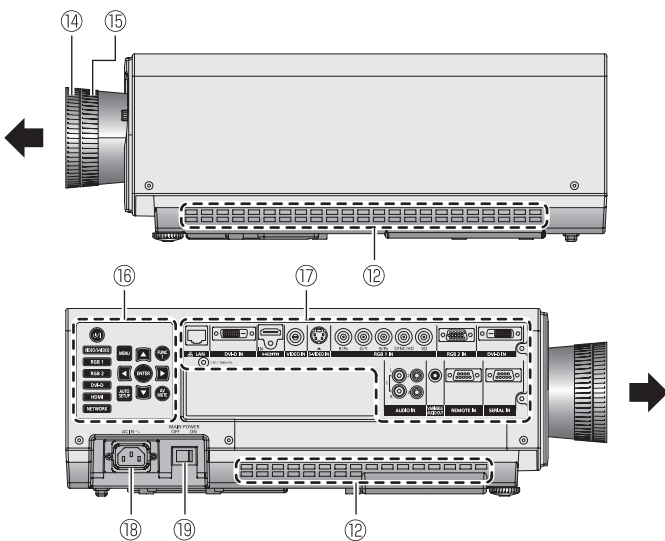

- ① **Power indicator (STANDBY(R) / ON(G))**
Indicates the power supply status
- ② **Lamp indicator (LAMP)**
Indicates the lamp unit status.
- ③ **Temperature indicator (TEMP)**
Indicates the temperature status.
- ④ **Lens shift lever**
- ⑤ **Front leg adjusters**
Screw up/down to adjust the projection angle.
- ⑥ **Remote control signal receptor**
- ⑦ **Wireless LAN module cover**
Remove the cover when you connect the optional Wireless LAN Module (Sold separately: ET-WM200U) to the projector. (➔page 93)
- ⑧ **Air exhaust port**
- ⑨ **Lamp unit compartment (➔page 78)**
- ⑩ **Remote control signal receptor**
- ⑪ **Ambient Luminance Sensor (ALS)**
- ⑫ **Air intake port**
- ⑬ **Burglar hook port**
Attach a commercial burglar prevention cable.
- ⑭ **Focus ring**
Adjust the focus.
- ⑮ **Zoom ring**
Adjust the projection size.
- ⑯ **CONTROL PANEL**
- ⑰ **Terminals on side**
- ⑱ **AC IN terminal**
Connect the power cord to supply electronic power to the projector
- ⑲ **<MAIN POWER> switch**
Switch the projector on/off.

Attention

- Keep your hands and other objects away from the air outlet port.
- Keep your hand and face away.
 - Keep heat-sensitive articles away.
 - Inserting your finger may result in injury.
- Heated air from the air outlet port can cause burns or deformations.

About Your Projector

CONTROL PANEL

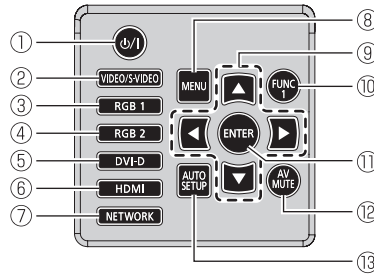

- ① **<POWER ON> button**
Switch between stand-by mode and projection mode.
- ② Switches to **VIDEO** or **S-VIDEO** input.
- ③ Switches to **RGB1** input.
- ④ Switches to **RGB2** input.
- ⑤ Switches to **DVI-D** input.
- ⑥ Switches to **HDMI** input.
- ⑦ Switches to **NETWORK** input.
- ⑧ **<MENU> button**
Displays and clears the main menu, and returns to the previous menu when the menu is displayed.
If you hold it down for at least 3 seconds while the on-screen indication is [OFF], the [OFF] state is canceled. (➡ page 39)
- ⑨ **▲▼◀▶ button**
Use these buttons to select menu items, change settings, adjust levels, and to enter the [SECURITY] password.
- ⑩ **<FUNCTION1> button**
Assign the frequently use functions from options for shortcut.
- ⑪ **<ENTER> button**
Press to activate a menu selection or to initiate a function.
- ⑫ **<AV MUTE> button**
Turn off the projection temporarily. (➡ page 36)
- ⑬ **<AUTO SETUP> button**
Pressing this button while projecting an image automatically corrects the picture positioning on the screen. While the auto setup feature is active, a message "PROGRESS" appears on the screen. (➡ page 37)

Terminals on side

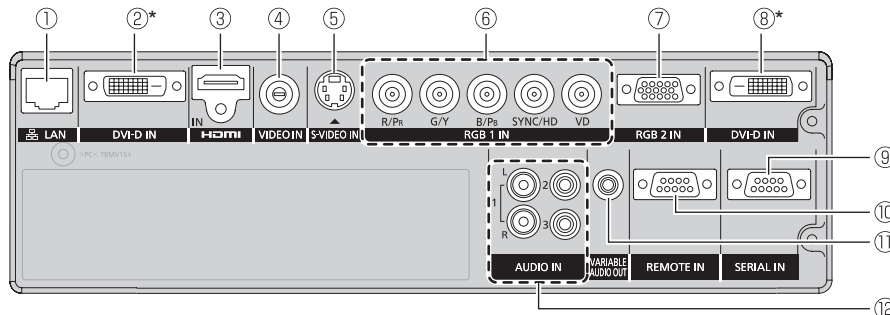

- ① **LAN**
Connect a LAN cable for network connection.
- ② **DVI-D IN**
Connect a single link DVI-D signals.
- ③ **HDMI IN**
Connect a HDMI signals.
- ④ **VIDEO IN**
Connect a VIDEO signals.
- ⑤ **S-VIDEO IN**
Connect an S-VIDEO signals.
- ⑥ **RGB (YP_BP_R)1 IN**
Connect an RGB or YP_BP_R signals.
- ⑦ **RGB2 IN**
Connect an RGB or YP_BP_R signals.
- ⑧ **DVI-D IN (PT-DZ570U/PT-DW530U)**
Connect a single link DVI-D signals.
- ⑨ **SERIAL IN**
Connect an RS-232C cable from/to a computer.
- ⑩ **REMOTE IN**
Connect a cable from an external control circuit.
- ⑪ **VARIABLE AUDIO OUT**
Connect an audio cable for outputting audio signals to the connected equipment.
- ⑫ **AUDIO IN 1-3**
Connect audio cables for inputting audio signal corresponding to VIDEO IN, S-VIDEO IN.

Attention

- Do not touch the LAN terminal with your bare hands or body, as body parts may have charged static electricity. Failure to do so may cause malfunctions.
Do not touch the metallic parts of LAN terminal and cable.
- Please connect the LAN to indoor devices only.

Setting projector ID number to remote control

Each projector can be assigned a unique ID number, and the handheld remote's number must be set to match the intended projector.

The ID number of the projector is set to "ALL" on shipping, and use the ID ALL button of the remote control when using only a single projector.

- 1) Press <ID SET> button, and the projector (s) will display it's current ID number onscreen. Within 5 seconds, use the numeric keys (1-6) to match the Remote's ID number with that of the desired projector.**

Attention

- Do not press <ID SET> button accidentally or carelessly because the ID number on the remote control can be set even when no projector is around.
- If you do not enter the 1 digit ID number within 5 seconds after <ID SET> button has been pressed, the ID will remain at the number that was set before <ID SET> button was pressed.
- Your specified ID number is stored in the remote control unit unless another one is specified later. However, the stored ID will be erased if the batteries of the remote control are left exhausted. When the batteries are replaced, set the same ID number again.

Note

- Refer to "PROJECTOR ID" of "PROJECTOR SETUP menu" (➡page 62).

Setting up

Projection method

You can use the projector with any of the following 4 projection methods. To set the desired method in the projector.

■ Mounting on the ceiling and projecting from front

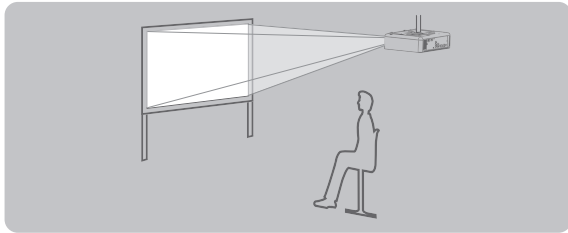

Menu *	Method
INSTALLATION	FRONT/CEILING
COOLING CONDITION	CEILING SETTING

■ Setting on a desk/floor and projecting from rear

(Using translucent screen)

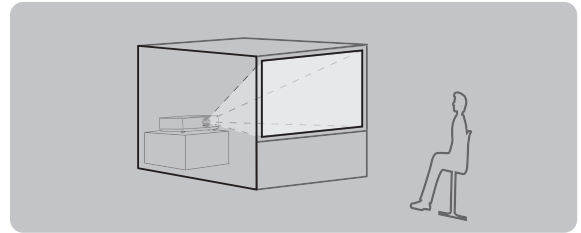

Menu *	Method
INSTALLATION	REAR/FLOOR
COOLING CONDITION	FLOOR SETTING

■ Mounting on the ceiling and projecting from rear

(Using translucent screen)

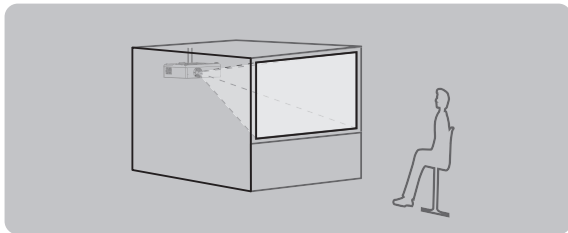

Menu *	Method
INSTALLATION	REAR/CEILING
COOLING CONDITION	CEILING SETTING

■ Setting on a desk/floor and projecting from front

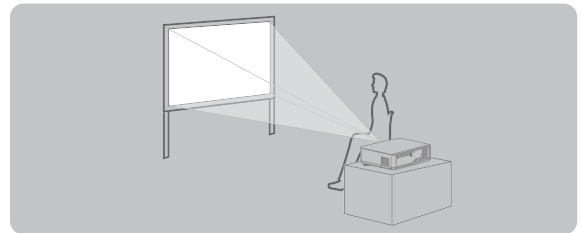

Menu *	Method
INSTALLATION	FRONT/FLOOR
COOLING CONDITION	FLOOR SETTING

*: Refer to "INSTALLATION" of "PROJECTOR SETUP menu" and "COOLING CONDITION" (➡ pages 62, 62) for details.

Screen size and throw distance

When planning the projector and screen geometry, refer to the figures below and the information on the following pages for reference. After the projector is roughly positioned, picture size and vertical picture positioning can be finely adjusted with the powered zoom lens and lens shifting mechanism.

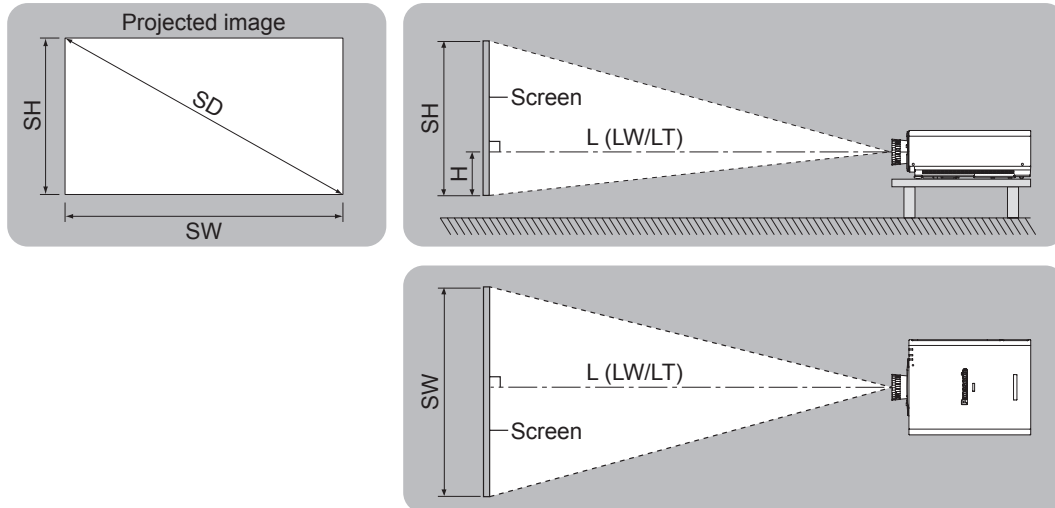

L (LW/LT) *	Projection distance (m)
SH	Height of the projection area (m)
SW	Width of the projection area (m)
SD	Diagonal length of the projection area (m)

*: LW : Minimum distance
 LT : Maximum distance

Attention

- Before installing, please read "Precautions with regard to safety" (➔ pages 8 to 16)
- Special care should be used when DLP projectors are used in the same room as high power laser equipment. Direct or indirect hitting of a laser beam on to the lens can severely damage the Digital Mirror Devices™ in which case there is a loss of warranty.

■ Projection distance for PT-DZ570U

(All measurements below are approximate and may differ slightly from the actual measurements.)

Projection size	For 4:3 aspect ratio		For 16:9 aspect ratio		For 16:10 aspect ratio	
	Minimum distance (LW)	Maximum distance (LT)	Minimum distance (LW)	Maximum distance (LT)	Minimum distance (LW)	Maximum distance (LT)
1.02 m (40")	1.40 m (4.59')	2.85 m (9.35')	1.26 m (4.13')	2.58 m (8.46')	1.23 m (4.04')	2.51 m (8.23')
1.27 m (50")	1.76 m (5.77')	3.57 m (11.71')	1.59 m (5.22')	3.24 m (10.63')	1.55 m (5.09')	3.15 m (10.33')
1.52 m (60")	2.12 m (6.96')	4.30 m (14.11')	1.92 m (6.30')	3.90 m (12.80')	1.87 m (6.14')	3.79 m (12.43')
1.78 m (70")	2.48 m (8.14')	5.02 m (16.47')	2.25 m (7.38')	4.55 m (14.93')	2.19 m (7.19')	4.43 m (14.53')
2.03 m (80")	2.85 m (9.35')	5.74 m (18.83')	2.58 m (8.46')	5.21 m (17.09')	2.51 m (8.23')	5.07 m (16.63')
2.29 m (90")	3.21 m (10.53')	6.46 m (21.19')	2.91 m (9.55')	5.86 m (19.23')	2.83 m (9.28')	5.70 m (18.70')
2.54 m (100")	3.57 m (11.71')	7.19 m (23.59')	3.24 m (10.63')	6.52 m (21.39')	3.15 m (10.33')	6.34 m (20.80')
3.05 m (120")	4.30 m (14.11')	8.63 m (28.31')	3.89 m (12.76')	7.83 m (25.69')	3.79 m (12.43')	7.62 m (25.00')
3.81 m (150")	5.38 m (17.65')	10.80 m (35.43')	4.88 m (16.01')	9.80 m (32.15')	4.75 m (15.58')	9.53 m (31.27')
5.08 m (200")	7.20 m (23.62')	14.41 m (47.28')	6.53 m (21.42')	13.08 m (42.91')	6.35 m (20.83')	12.73 m (41.77')
6.35 m (250")	9.01 m (29.56')	18.03 m (59.15')	8.17 m (26.80')	16.36 m (53.67')	7.95 m (26.08')	15.92 m (52.23')
7.62 m (300")	10.82 m (35.50')	21.64 m (71.00')	9.82 m (32.22')	19.64 m (64.44')	9.55 m (31.33')	19.11 m (62.70')

Any other projection distance can be obtained according to the screen dimensions (size) using the following calculations.

The distance is shown in units of meters. (The calculated distance may contain a certain error.)

If the screen dimensions are written as "SD",

	For 4:3 aspect ratio	For 16:9 aspect ratio	For 16:10 aspect ratio
Screen height (SH)	= SD (m) × 0.0152	= SD (m) × 0.0125	= SD (m) × 0.0135
Screen width (SW)	= SD (m) × 0.0203	= SD (m) × 0.0221	= SD (m) × 0.0215
Minimum distance (LW)	= 1.4252 × SD (m) – 0.0546	= 1.2953 × SD (m) – 0.0546	= 1.2598 × SD (m) – 0.0546
Maximum distance (LT)	= 2.8465 × SD (m) – 0.0408	= 2.5827 × SD (m) – 0.0408	= 2.5118 × SD (m) – 0.0408

■ Projection distance for PT-DW530U

(All measurements below are approximate and may differ slightly from the actual measurements.)

Projection size	For 4:3 aspect ratio		For 16:9 aspect ratio		For 16:10 aspect ratio	
	Minimum distance (LW)	Maximum distance (LT)	Minimum distance (LW)	Maximum distance (LT)	Minimum distance (LW)	Maximum distance (LT)
1.02 m (40")	1.47 m (4.82')	2.99 m (9.81')	1.33 m (4.36')	2.71 m (8.89')	1.29 m (4.23')	2.64 m (8.66')
1.27 m (50")	1.85 m (6.07')	3.75 m (12.30')	1.67 m (5.48')	3.40 m (11.15')	1.63 m (5.35')	3.31 m (10.86')
1.52 m (60")	2.23 m (7.32')	4.51 m (14.80')	2.02 m (6.63')	4.09 m (13.42')	1.96 m (6.43')	3.98 m (13.06')
1.78 m (70")	2.61 m (8.56')	5.27 m (17.29')	2.36 m (7.74')	4.78 m (15.68')	2.30 m (7.55')	4.65 m (15.26')
2.03 m (80")	2.99 m (9.81')	6.03 m (19.78')	2.71 m (8.89')	5.47 m (17.95')	2.64 m (8.66')	5.32 m (17.45')
2.29 m (90")	3.37 m (11.06')	6.79 m (22.28')	3.06 m (10.04')	6.16 m (20.21')	2.97 m (9.74')	5.99 m (19.65')
2.54 m (100")	3.75 m (12.30')	7.55 m (24.77')	3.40 m (11.15')	6.85 m (22.47')	3.31 m (10.86')	6.66 m (21.85')
3.05 m (120")	4.51 m (14.80')	9.06 m (29.72')	4.09 m (13.42')	8.23 m (27.00')	3.98 m (13.06')	8.00 m (26.25')
3.81 m (150")	5.65 m (18.54')	11.34 m (37.20')	5.13 m (16.83')	10.29 m (33.76')	4.99 m (16.37')	10.01 m (32.84')
5.08 m (200")	7.56 m (24.80')	15.13 m (49.64')	6.86 m (22.51')	13.74 m (45.08')	6.67 m (21.88')	13.36 m (43.83')
6.35 m (250")	9.46 m (31.04')	18.93 m (62.11')	8.58 m (28.15')	17.18 m (56.36')	8.35 m (27.40')	16.72 m (54.86')
7.62 m (300")	11.36 m (37.27')	22.72 m (74.54')	10.31 m (33.83')	20.63 m (67.68')	10.03 m (32.91')	20.07 m (65.85')

Any other projection distance can be obtained according to the screen dimensions (size) using the following calculations.

The distance is shown in units of meters. (The calculated distance may contain a certain error.)

If the screen dimensions are written as "SD",

	For 4:3 aspect ratio	For 16:9 aspect ratio	For 16:10 aspect ratio
Screen height (SH)	= SD (m) × 0.0152	= SD (m) × 0.0125	= SD (m) × 0.0135
Screen width (SW)	= SD (m) × 0.0203	= SD (m) × 0.0221	= SD (m) × 0.0215
Minimum distance (LW)	= 1.5000 × SD (m) – 0.0546	= 1.3622 × SD (m) – 0.0546	= 1.3228 × SD (m) – 0.0546
Maximum distance (LT)	= 2.9882 × SD (m) – 0.0408	= 2.7126 × SD (m) – 0.0408	= 2.6378 × SD (m) – 0.0408

Setting up

■ Projection distance for PT-DX500U

(All measurements below are approximate and may differ slightly from the actual measurements.)

Projection size Screen diagonal (SD)	For 4:3 aspect ratio		For 16:9 aspect ratio	
	Minimum distance (LW)	Maximum distance (LT)	Minimum distance (LW)	Maximum distance (LT)
1.02 m (40")	1.20 m (3.94')	2.46 m (8.07')	1.31 m (4.30')	2.68 m (4.30')
1.27 m (50")	1.51 m (4.95')	3.08 m (10.10')	1.65 m (5.41')	3.36 m (5.41')
1.52 m (60")	1.82 m (5.97')	3.70 m (12.14')	1.99 m (6.53')	4.04 m (6.53')
1.78 m (70")	2.14 m (7.02')	4.33 m (14.21')	2.33 m (7.64')	4.72 m (7.64')
2.03 m (80")	2.45 m (8.04')	4.95 m (16.24')	2.67 m (8.76')	5.40 m (8.76')
2.29 m (90")	2.76 m (9.06')	5.58 m (18.31')	3.01 m (9.88')	6.08 m (9.88')
2.54 m (100")	3.08 m (10.10')	6.20 m (20.34')	3.36 m (11.02')	6.76 m (11.02')
3.05 m (120")	3.70 m (12.14')	7.45 m (24.44')	4.04 m (13.25')	8.12 m (13.25')
3.81 m (150")	4.64 m (15.22')	9.32 m (30.58')	5.06 m (16.60')	10.16 m (16.60')
5.08 m (200")	6.21 m (20.37')	12.44 m (40.81')	6.77 m (22.21')	13.56 m (22.21')
6.35 m (250")	7.77 m (25.49')	15.56 m (51.05')	8.47 m (27.79')	16.95 m (27.79')
7.62 m (300")	9.34 m (30.64')	18.68 m (61.29')	10.18 m (33.40')	20.35 m (33.40')

Any other projection distance can be obtained according to the screen dimensions (size) using the following calculations.

The distance is shown in units of meters. (The calculated distance may contain a certain error.)

If the screen dimensions are written as "SD",

	For 4:3 aspect ratio	For 16:9 aspect ratio
Screen height (SH)	= SD (m) × 0.0152	= SD (m) × 0.0125
Screen width (SW)	= SD (m) × 0.0203	= SD (m) × 0.0221
Minimum distance (LW)	= 1.2332 × SD (m) – 0.0546	= 1.3425 × SD (m) – 0.0546
Maximum distance (LT)	= 2.4567 × SD (m) – 0.0408	= 2.6771 × SD (m) – 0.0408

Front leg adjusters and throwing angle

You can screw up/down the front leg adjusters to control the angle of the projector for adjusting the throwing angle.

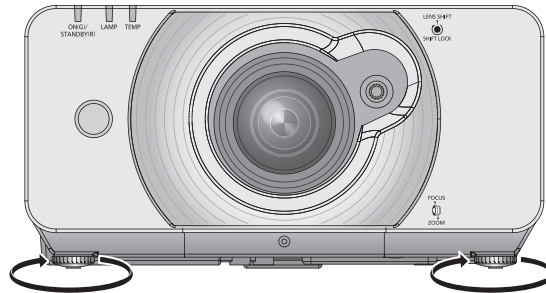

Adjustable range
Front adjuster leg : 20 mm

Attention

- Heated air comes out of the air exhaust port. Do not touch the air exhaust port directly.

Connections

Before connection to the projector

- Read carefully the instruction manual for the device to be connected.
- Turning off the power switch of the devices before connecting cables.
- If any connection cable is not supplied with the device, or if no optional cable is available for connection of the device, prepare a necessary system connection cable to suit the device.
- Video signals containing too much jitter may cause the images on the screen to randomly wobble or wafture. In this case, a time base corrector (TBC) must be connected.
- The projector accepts the following signals: VIDEO, S-VIDEO, analogue-RGB (with TTL sync. Level) and digital signal.
- Some computer models are not compatible with the projector.
- When using long cables to connect with each of equipment to the projector, there is a possibility that the image will not be output correctly unless a compensator is used.

Pin assignments and signal names of <S-VIDEO IN> terminal

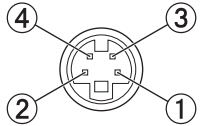
Outside view	Pin No.	Signal names
	①	GND (luminance signal)
	②	GND (color signal)
	③	Luminance signal
	④	Color signal

Pin assignments and signal names of <RGB2 IN> terminal

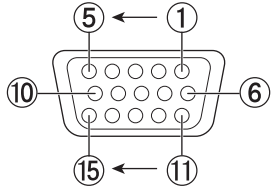
Outside view	Pin No.	Signal names
	①	R/P _R
	②	G/G · SYNC/Y
	③	B/P _B
	⑫	DDC data
	⑬	HD/SYNC
	⑭	VD
	⑮	DDC clock
	④, ⑨	Not assigned
	⑤ - ⑧, ⑩, ⑪	GND terminals

④, ⑨ : Not assigned
⑤ - ⑧, ⑩, ⑪ : GND terminals

Pin assignments and signal names of <HDMI IN> terminal

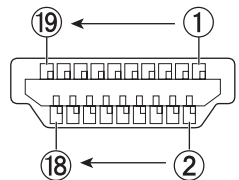
Outside view	Pin No.	Signal names	Pin No.	Signal names
<p>Odd-numbered pins ① to ⑮</p>  <p>Even-numbered pins ② to ⑱</p>	①	T.M.D.S data 2+	②	T.M.D.S data 2 shield
	③	T.M.D.S data 2-	④	T.M.D.S data 1+
	⑤	T.M.D.S data 1 shield	⑥	T.M.D.S data 1-
	⑦	T.M.D.S data 0+	⑧	T.M.D.S data 0 shield
	⑨	T.M.D.S data 0-	⑩	T.M.D.S clock +
	⑪	T.M.D.S clock shield	⑫	T.M.D.S clock -
	⑬	CEC	⑭	—
	⑮	SCL	⑯	SDA
	⑰	DDC/CEC GND	⑱	+5V
	⑲	Hot plug detection		

Pin assignments and signal names of <DVI-D IN> terminal

Outside view	Pin No.	Signal names	Pin No.	Signal names
	①	T.M.D.S data 2-	⑬	—
	②	T.M.D.S data 2+	⑭	+5V
	③	T.M.D.S data 2/4 shield	⑮	GND
	④	—	⑯	Hot plug detection
	⑤	—	⑰	T.M.D.S data 0-
	⑥	DDC clock	⑱	T.M.D.S data 0+
	⑦	DDC data	⑲	T.M.D.S data 0/5 shield
	⑧	—	⑳	—
	⑨	T.M.D.S data 1-	㉑	—
	⑩	T.M.D.S data 1+	㉒	T.M.D.S clock shield
	⑪	T.M.D.S data 1/3 shield	㉓	T.M.D.S clock +
	⑫	—	㉔	T.M.D.S clock -

*: The PT-DX500U has the same DVI-D input terminal with the 180-degree rotated pin layout.

Connecting example : AV equipment

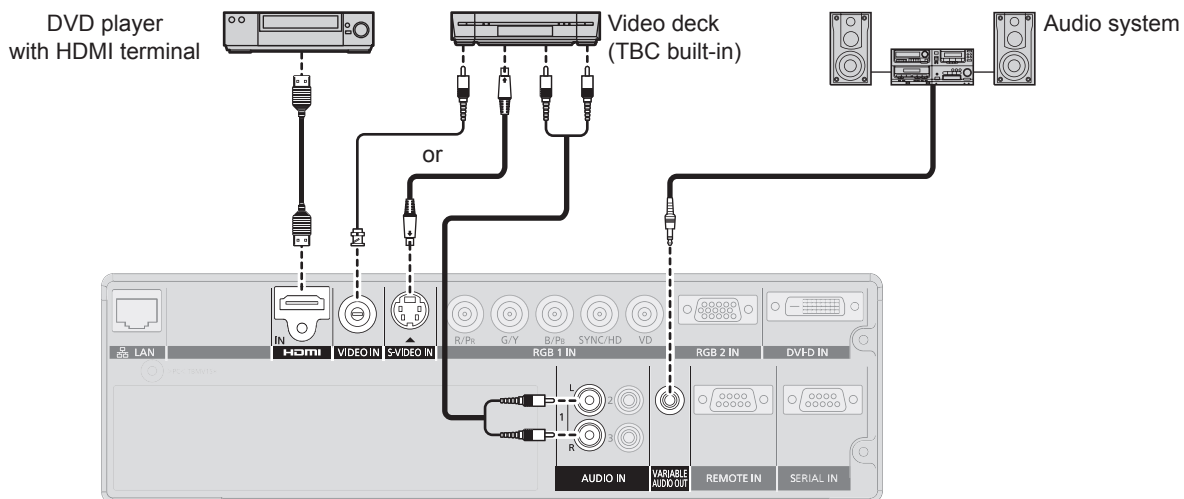

Attention

- When connecting with a video deck, be sure to use the one with a built-in time base corrector (TBC) or use a TBC between the projector and the video deck.
- If nonstandard burst signals are connected, the image may be distorted. If this is the case, connect a TBC between the projector and the video deck.

Note

- When using an HDMI cable, check that it is compliant with the HDMI standard. Using a cable that is not compliant with the HDMI standard may result in problems such as the image cutting out or not appearing. When connecting the 1 080p signal using HDMI, use a cable compliant with 1 080p signal.
- The HDMI terminal supports voice signals having 48 kHz, 44.1kHz and 32kHz linear PCM sampling frequencies only. For the supported video signals, see "List of compatible signals." (➡page 87)
- It is possible to connect the HDMI input terminal with an external device having a DVI terminal using an HDMI/DVI conversion cable, but with some devices the images may not appear or other problems may occur. (➡page 57)
- It is possible to connect the DVI-D input terminal with an HDMI- or DVI-D compliant device, but with some devices the images may not appear or other problems may be encountered in operation. (➡page 57)

Connections

Connecting example : Computers

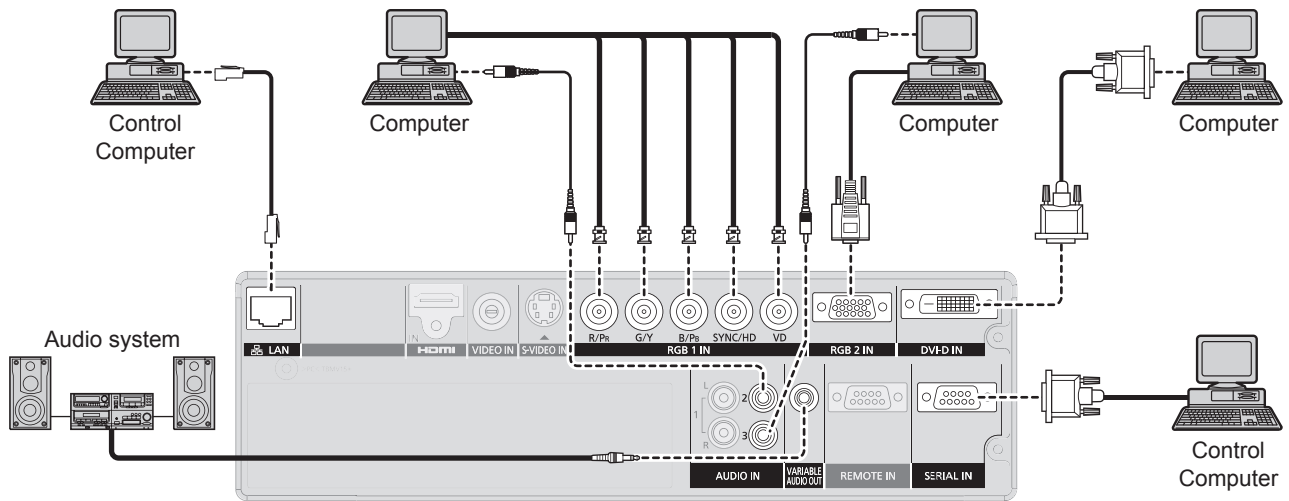

Note

- The DVI-D signal input terminal supports only a single link.
- For the specifications of the RGB signals that can be applied from the PC, refer to “List of compatible signals”. (➡page 87)
- If your computer has the resume feature (last memory), the computer may not function properly until the resume capability is disabled.
- When the SYNC ON GREEN signal is input, do not input sync signals to the SYNC/HD and VD terminals.
- When using the DVI-D input, EDID settings may be required for the connected device. (➡page 57)
- When using an HDMI cable, check that it is compliant with the HDMI standard. Using a cable that is not compliant with the HDMI standard may result in problems such as the image cutting out or not appearing. When connecting the 1 080p signal using HDMI, use a cable compliant with 1 080p signal.
- It is possible to connect the HDMI input terminal with an external device having a DVI terminal using an HDMI/DVI conversion cable, but with some devices the images may not appear or other problems may occur. (➡page 57)

Powering ON/OFF

Connecting the power cord

Be sure to insert the attached power cord securely to its base to prevent it from coming off.
Before connecting the power cord, confirm that the MAIN POWER switch is in the “○” (OFF) position.

■ Installation

Insert the plug securely until its right and left claw click.

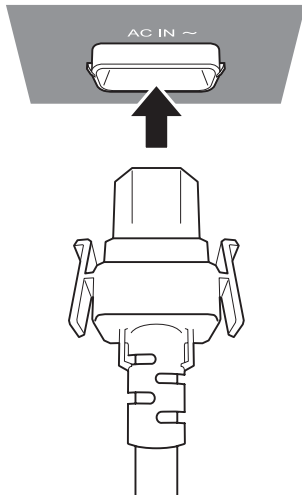

■ Removal

Remove the power cord from the electrical outlet while pressing the knobs on its sides.

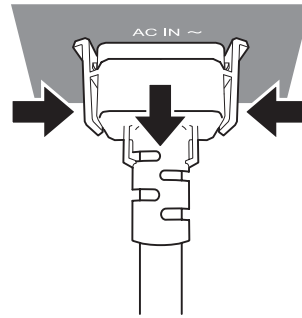

Powering ON/OFF

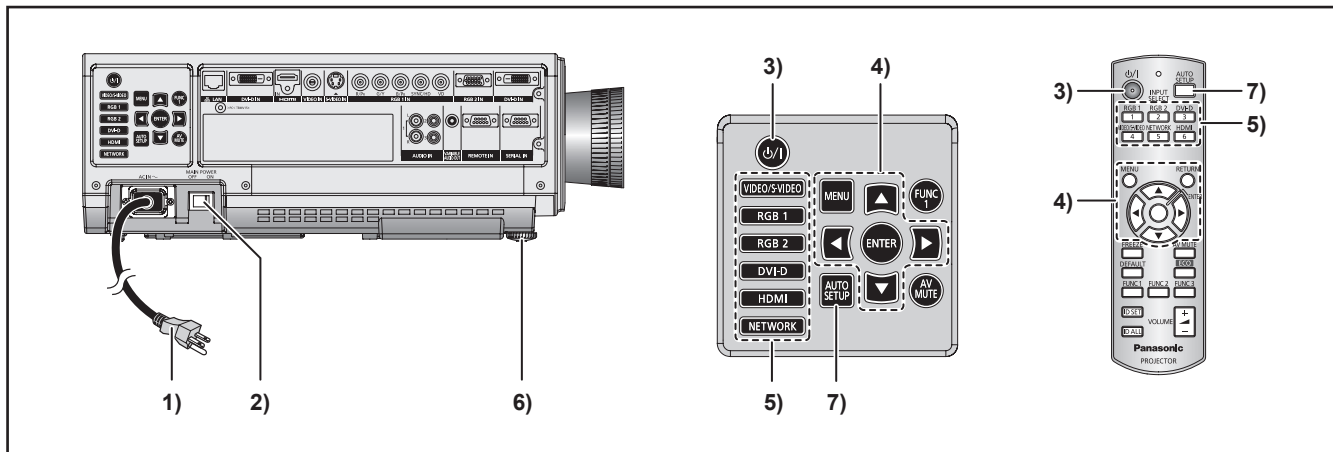

Powering up the projector

- 1) **Connect the supplied power cable.**
(AC100-120 V 50-60 Hz)
- 2) **Press the [|] marked side of the MAIN POWER switch to turn on the power.**
The POWER indicator lamp on the projector will flash in red. After a short period, the indicator will illuminate and the projector will enter standby mode.
- 3) **Press POWER ON.**
[Power indicator] lamp illuminates in green and soon the image is projected on the screen.

Note

- If the projector is powered up at about 0 °C, a warm-up period of approximately 5 minutes may be necessary to start projection. <TEMP> indicator lamp lights up during the warm-up period. When the warm-up is completed, <TEMP> indicator lamp turns off and the image is projected on the screen.
- If the temperature of the operating environment is low and warm-up takes more than 5 minutes, the projector will judge that a problem has occurred and the power will be turned off automatically. If this happens, increase the temperature around the projector so that it is 0 °C or higher, and then turn on the MAIN POWER switch and the POWER ON (|) switch once more.
- With [ECO] setting in [Standby mode] (▶page 64), When switch on the projector, projection will start about 10 seconds late.
- If the filter is not installed, the power is turned off automatically after 10 minutes.
- If projection was stopped last time by using the DIRECT POWER OFF function, it can be started by setting the MAIN POWER switch to the " I " (ON) position.
- When you power up the projector or switch the signal input, a high-frequency driving noise may be heard. This is not a failure.

Making adjustment and selection

It is recommended that the images are projected continuously for at least 30 minutes before the focus is adjusted.

- 4) **Turn the focus ring, roughly adjust the focus of the lens. (▶page 34)**
- 5) **Select and set the projection scheme of [INSTALLATION] and [COOLING CONDITION] settings in [PROJECTOR SETUP] menu.**
- 6) **Select the input signal by pressing <INPUT SELECT> button (<RGB1>, <RGB2>, <HDMI>, <VIDEO>, <S-VIDEO>).**
- 7) **Adjust the tilt of the main unit in front and rear or right and left.**
- 8) **Press <SHIFT> button to adjust the position of the projection.**
- 9) **Press <AUTO SETUP> button if the input signal is RGB signal.**
- 10) **Zoom the lens so the image fills the screen.**
- 11) **Readjust the focus.**
- 12) **Readjust the zoom so that the image size fits in the screen.**

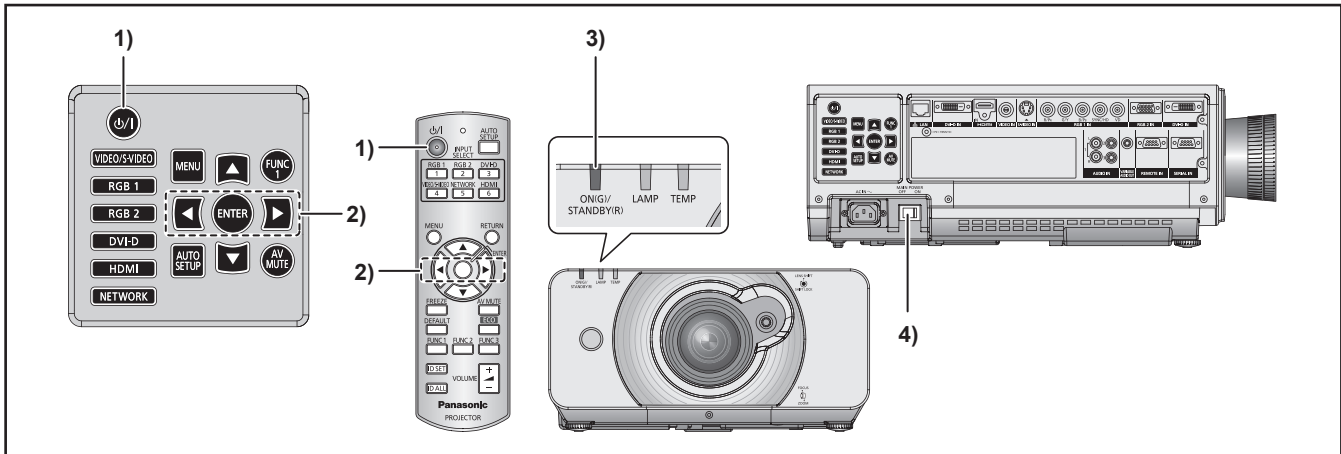

Powering off the projector

- 1) Press **POWER STANDBY** (⏻).
- 2) Press **◀▶** to select [OK] and press **(ENTER)**.
(or press **POWER STANDBY** (⏻) again.)
The projection of the image stops, and [Power indicator] lamp of the main unit lights up orange. (The cooling fan keeps running.)
- 3) **Wait until the power indicator lamp of the main unit turns to red (i.e., until the cooling fan stops).**
- 4) Press the **[O]** marked side of the **(MAIN POWER)** switch to remove all power from the projector.

Note

- In the cooling state after the power is turned off, the lamp will not light up even if the power is turned on. To light up the lamp, turn on the power supply again when the lamp has been cooled sufficiently. Failure to observe this may shorten the lamp life.
- The projector consumes approximately 6 W (120 V mode) power.
(STANDBY MODE: [NORMAL])

Direct power off function

The power supplied internally causes the cooling fan to continue operating and cool off in the event that the power has failed or even after the power cord is accidentally disconnected immediately after the power has been turned off.

Note

- When the lamp has been cooled by the direct power off function, it sometimes takes longer than usual for the lamp to light up again.
- While the cooling fan is operating, do not place the projector inside a box or bag.
- If projection was stopped by using the **DIRECT POWER OFF** function, it can be started by setting the **MAIN POWER** switch to the "I" (ON) position.

Projecting

Check the connections of the peripheral devices, installation of the projection lens (➔page 28), and connection of the power cord (➔page 31) and switch on the power (➔page 32) to start the projector. Select the input signal and adjust the image.

Selecting the input signal

Select an input signal.

The image selected with <INPUT SELECT> button is projected. (➔page 36)

Attention

- Images may not be projected properly depending on the connected device and DVD, video tape, etc. to be played. Select a system format that is suitable for the input signal using the [SYSTEM SELECTOR] in the [PICTURE] menu (➔page 46).
- Check the aspect ratios of the screen and the image and select the optimum aspect ratio using [ASPECT] in the [PICTURE] menu (➔page 47).

How to adjust the focus, zoom and shift

1) Adjust the projected image with the lens shift lever.

See “Lens shift and positioning” on page 35.

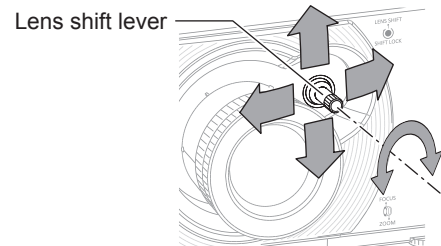

2) Adjust the focus and the projected image size.

Turn the focus lever and zoom lever to adjust the image.

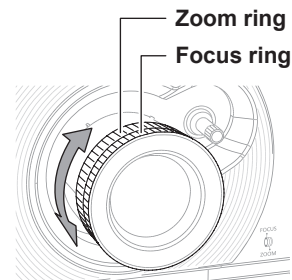

You can confirm the adjusted effect with the TEST PATTERN in OPTION menu. See “TEST PATTERN” on page 70.

Note

- Do not touch the air exhaust port as this may cause burns or injury.
- If keystone distortion occurs, see “KEYSTONE” on page 49.
- If you adjust the focus, you may need to adjust the size of the image by moving the zoom lever again.
- It is recommended that the images are projected continuously for at least 30 minutes before the focus is adjusted.

Adjustment range after lens position (optical shift)

Do not move the lens beyond the bounds of the shift range as this may cause a change in the focus. This limitation is to protect the parts of the projector.

Using the standard projection position as the reference, the optical axis shift function makes it possible to adjust the projection position in the ranges shown in the figures below.

<p>PT-DZ570U</p>	<p>Projected screen height, V</p> <p>Projected screen width, H</p> <p>Standard projection position</p>
<p>PT-DW530U</p>	<p>Projected screen height, V</p> <p>Projected screen width, H</p> <p>Standard projection position</p>
<p>PT-DX500U</p>	<p>Projected screen height, V</p> <p>Projected screen width, H</p> <p>Standard projection position</p>

Basic operations using the remote control

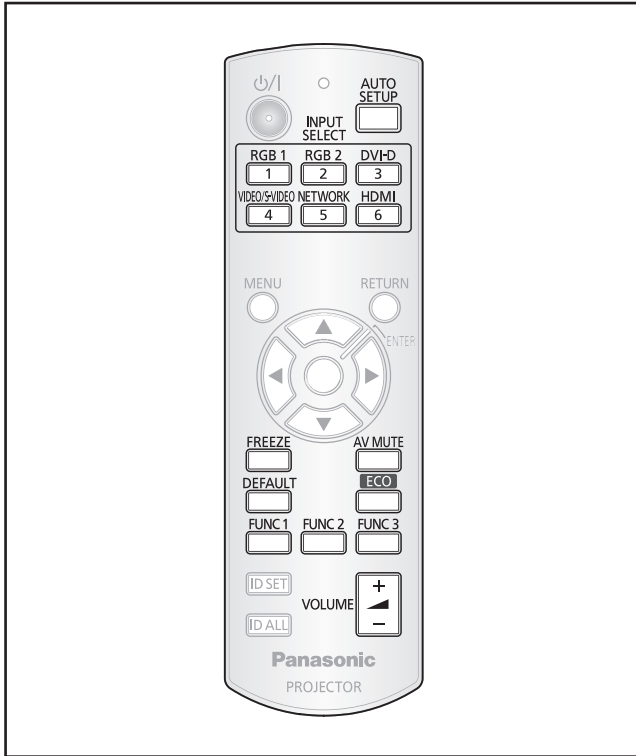

Switching the input signal

You can use the remote control to switch the signals that are being input and projected.

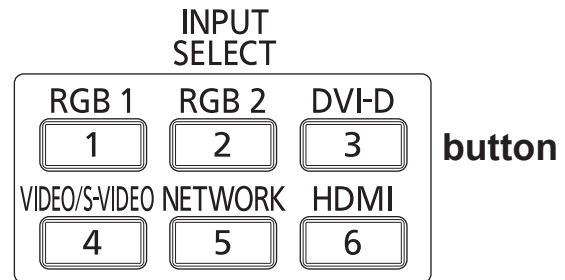

Press <INPUT SELECT> button on the remote control or the main unit.

RGB1	Switches to RGB1 input.
RGB2	Switches to RGB2 input.
DVI-D	Switches to DVI-D input.
VIDEO/ S-VIDEO	Switches to VIDEO or S-VIDEO input. If either of the inputs has already been selected, the input switches to the other.
NETWORK	Switches to NETWORK input.
HDMI	Switches to HDMI input.

Using the AV MUTE function

If the projector is not used for a certain period of time during the meeting intermission, for example, a AV MUTE mode is available that allows the user to hide images temporarily.



1) Press <AV MUTE> button on the remote control or the main unit.

- The projected light is blocked by the internal shutter.

2) Press <AV MUTE> button again.

- Projection resumes.

Note

- The power indicator will flash while the AV MUTE function is being used.

Capturing an image

You can freeze the projected image and stop the sound temporarily, regardless of the playing condition of the connected device.



Press the <FREEZE> button again to escape.

Automatic adjustment

The automatic setup function can be used to automatically adjust the resolution, clock phase and picture position when analog RGB signals consisting of bitmap images such as computer signals are being input, or to automatically adjust the picture position when DVI-D/HDMI signals are being input.

It is recommended to supply images with a bright white frame at the outermost periphery containing characters etc. that are clear in white and black contrast when the system is in automatic adjustment mode.

Avoid supplying images that involve halftones or gradation such as photographs and computer graphics.



Press <AUTO SETUP> button on the remote control or the main unit.

- A message [COMPLETE] appears if adjustment is ended normally.

Note

- [CLOCK PHASE] may have been shifted even when the adjustment ended normally. In this case, manually adjust the [CLOCK PHASE]. Refer to "CLOCK PHASE" of "POSITION menu" (➔page 49) for details.
- If an image with blurred edges or a dark image is input, [INCOMPLETE] may appear or adjustment may not be performed properly even if [COMPLETE] appears. In this case, manually adjust the items of "INPUT RESOLUTION" of "ADVANCED MENU" (➔page 51), "SHIFT" and "CLOCK PHASE" of "POSITION menu" (➔pages 47, 49).
- For specific signals, adjustment should be made according to "AUTO SETUP" of "DISPLAY OPTION menu" (➔page 56).
- [AUTO SETUP] may not be available depending on the machine type of the personal computer.
- Automatic adjustment may not be available for synchronization signal of C-SYNC and G-SYNC.
- Image may be distorted for several seconds during automatic adjustment. This is not a malfunction.
- For every supplied signal, adjustment is required.
- Automatic adjustment can be canceled by pressing <MENU> button during the course of automatic adjustment.
- Even for an RGB signal for which automatic setup is possible, if automatic setup is performed while moving images are being input, [INCOMPLETE] may appear, or adjustment may not be performed properly even if [COMPLETE] appears.

Using the function buttons

Three function buttons (<FUNCTION1 to 3>) on the remote control and the <FUNCTION1> button on the projector can be assigned to any frequent operations. They can be used as a useful shortcut button.



- 1) Press any of the <FUNCTION1 to 3> buttons on the remote control or the <FUNCTION1> button on the projector.
- 2) Press <MENU> button on the remote control or the projector to select a menu option (Main Menu, Submenu or Advanced Menu).
 - For the on-screen menu selection, see "On-screen menu". (➔page 39)
- 3) Hold down any of the <FUNCTION1 to 3> buttons on the remote control or the <FUNCTION1> button on the projector more than 3 seconds.

Note

- For details, see "FUNCTION BUTTON" of "PROJECTOR SETUP". (➔page 66)

Using ECO button

Displays [ECO MANAGEMENT] menu.



Press <ECO> button on the remote control.

Note

- For details, see "ECO MANAGEMENT" of "PROJECTOR SETUP". (➔page 63)

Basic operations using the remote control

Controlling the volume of the speaker

You can control the volume of output sound.

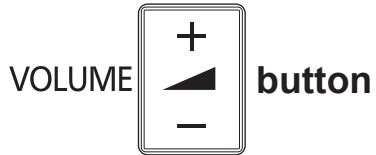

Press <VOLUME> button on the remote control.

+ button	increases the volume
- button	decreases the volume

Menu Navigation

Menus are extensively used for configuring, adjusting or reconfiguring the projector.

Navigating through the menu

Operating procedure

1) Press <MENU> button.

[MAIN MENU] appears on the screen.

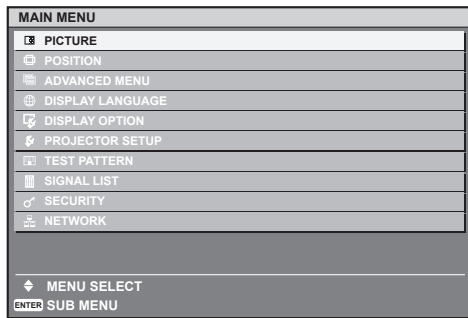

2) Press ▲ ▼ to select the desired item.

The selected item is highlighted in orange.

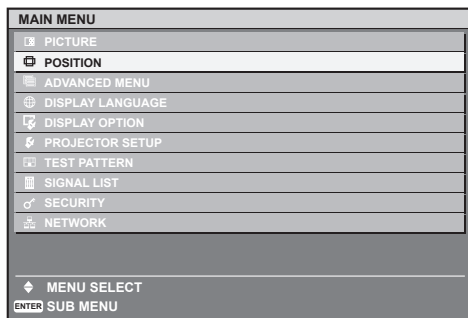

3) Press <ENTER> button to establish your selection.

The submenu for the selected option will now open.

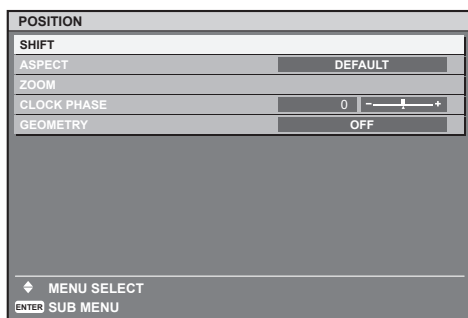

4) Press ▲ ▼ button to highlight the desired adjustment item, then press ◀ ▶ to change or adjust the parameter value.

For some items, an individual adjustment screen containing a bar scale will appear as shown in the diagram below when ◀ ▶ is pressed.



Note

- Press <MENU> button to return to the previous menu.
- Some menu items may not be valid for certain signal formats applied to the projector. The menu items that cannot be adjusted or used are shown in gray characters, and they cannot be selected.
- If no button is pressed for approx. 5 seconds while the individual adjustment screen is displayed, the screen will return to the previous page.

Resetting to the factory default

If an adjustment item is selected and <DEFAULT> button is pressed, the adjustment value will return to the factory default setting.

Press **DEFAULT**



Note

- You cannot reset all the settings at a time to the factory default settings. To reset all the settings to the factory defaults, refer to "INITIALIZE" of "PROJECTOR SETUP menu" (➔ 69 page).
- Some menu items are not available to reset by pressing <DEFAULT> button. Adjust each menu item manually.
- The triangle mark under the bar indicates factory default setting and the square indicates the current setting. The triangle mark position varies by the selected input signals.

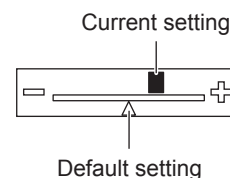











Menu Navigation

MAIN MENU

The main menu consists of the following 11 menu items.

When a main menu item is selected, the screen changes to a sub-menu selection screen.

	PICTURE
	POSITION
	ADVANCED MENU
	DISPLAY LANGUAGE
	DISPLAY OPTION
	PROJECTOR SETUP
	TEST PATTERN
	SIGNAL LIST
	SECURITY
	NETWORK

SUB MENU

The sub-menu screen of the selected main menu appears, and you can set and adjust the various items in the sub-menu.

PICTURE []

Sub-menu item	Default	Page
PICTURE MODE	STANDARD *	42
CONTRAST	0	42
BRIGHTNESS	0	43
COLOR	0	43
TINT	0	43
COLOR TEMPERATURE	DEFAULT	43
WHITE GAIN	+10	44
SHARPNESS	6	45
NOISE REDUCTION	2	45
AI	ON	45
DAYLIGHT VIEW	AUTO	45
SYSTEM SELECTOR	YPbPr *1	46

Note

- The factory default values may vary depending on the PICTURE MODE.

POSITION []

Sub-menu item	Default	Page
SHIFT	—	47
ASPECT	AUTO *1	47
ZOOM	—	48
CLOCK PHASE	16	49
KEystone	—	49

ADVANCED MENU []

Sub-menu item	Default	Page
DIGITAL CINEMA REALITY	AUTO *1	50
BLANKING	—	50
INPUT RESOLUTION	—	51
CLAMP POSITION	24 *4	51
FRAME RESPONSE	NORMAL	51
RASTER POSITION	—	51

■ DISPLAY LANGUAGE []

Details (➔page 52)

■ DISPLAY OPTION []

Sub-menu item	Default	Page
COLOR MATCHING	OFF	53
COLOR CORRECTION	OFF	54
SCREEN SETTING *2	—	54
WAVEFORM MONITOR *4	OFF	55
AUTO SIGNAL	OFF	55
AUTO SETUP	—	56
RGB IN	—	57
DVI-D IN	—	57
HDMI IN	—	57
ON-SCREEN DISPLAY	—	58
CLOSED CAPTION SETTING	OFF	58
BACK COLOR	BLUE	59
STARTUP LOGO	LOGO2	59
SUB MEMORY LIST	—	59
FREEZE	—	60
SIDE BY SIDE *2	—	60

■ PROJECTOR SETUP []

Sub-menu item	Default	Page
PROJECTOR ID	ALL	62
PROJECTION METHOD	FRONT/ FLOOR	62
COOLING CONDITION	FLOOR SETTING	62
HIGH ALTITUDE MODE	OFF	63
LAMP POWER	NORMAL	63
ECO MANAGEMENT	—	63
SCHEDULE	OFF	64
RS-232C	—	65
REMOTE MODE	DEFAULT	66
FUNCTION BUTTON	—	66
AUDIO SETTING	—	66
STATUS	—	67
DATE AND TIME	—	67
SAVE ALL USER DATA	—	68
LOAD ALL USER DATA	—	68
INITIALIZE	—	69
SERVICE PASSWORD	—	69

■ TEST PATTERN []

Details (➔page 70)

■ SIGNAL LIST []

Details (➔page 71)

■ SECURITY []

Sub-menu item	Default	Page
SECURITY PASSWORD	OFF	72
SECURITY PASSWORD CHANGE	—	72
DISPLAY SETTING	OFF	73
TEXT CHANGE	—	73
MENU LOCK	OFF	73
MENU LOCK PASSWORD	—	73
CONTROL DEVICE SETUP	—	74

■ NETWORK []

Sub-menu item	Default
PROJECTOR NAME	NAME1234
WIRED LAN	—
WIRELESS LAN	—
NETWORK CONTROL	—
NETWORK PASSWORD	ON
NETWORK PASSWORD CHANGE	—
LIVE MODE CUT IN	ON
COMPUTER SEARCH	—
MULTI-LIVE	—
NETWORK STATUS	—

Note

- Some default settings vary by the selected input signal.
- Sub-menu items vary according to the selected input signal.

*1 : Some default settings vary by the selected input signal.

*2 : PT-DZ570U/PT-DW530U only

*3 : PT-DX500U only

*4 : PT-DZ570U only

PICTURE menu

- See “Navigating through the menu” (➡page 39).
- See “MAIN MENU” and “SUB MENU” (➡page 40).

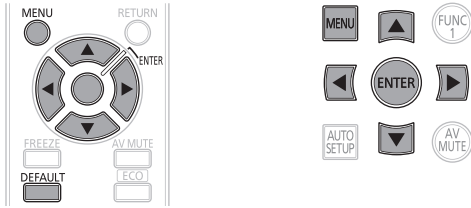

PICTURE MODE

The user can switch to the desired picture mode suitable for the image source and the environment in which this projector is used.

- 1) Press ▲▼ to select [PICTURE MODE].
- 2) Press ◀▶ to switch [PICTURE MODE].
 - The setting will change as follows each time ◀▶ is pressed.



STANDARD	The picture becomes suitable for moving images in general.
CINEMA	The picture becomes suitable for movie sources.
NATURAL	The picture complies with sRGB.
DICOM SIM.	The picture becomes similar to DICOM Part14 gray scale.
REC709	The picture complies with ITU-R BT.709 Standard.
DYNAMIC	The light output is maximized for use in bright areas.
GRAPHIC	The picture becomes suitable for input from the personal computer.
USER	You can set your favorite picture mode.

Note

- Factory defaults are [GRAPHIC] for RGB system and [STANDARD] for moving images.
- DICOM is an abbreviation for “Digital Imaging and Communication in Medicine”, which is a standard for medical imaging devices. Although the name “DICOM” is used, this projector is not a medical device. Accordingly, do not use the projected images for medical diagnosis or similar usage.
- When <ENTER> button is pressed while a [PICTURE MODE] other than [USER] is selected, the setting is saved and will be used as the preset value next time a signal is inputted. At this time, all the data except [SYSTEM SELECTOR] in the [PICTURE] menu are saved.

CONTRAST

You can adjust the contrast of the projected image.

- 1) Press ▲▼ to select [CONTRAST].
- 2) Press ◀▶ or <ENTER> button.
 - The [CONTRAST] individual adjustment screen will be displayed.
- 3) Press ◀▶ to adjust the level.

Operation	Adjustment	Adjustment range
Press ▶.	Raises the picture brightness and the picture becomes clearer.	Maximum value 31
Press ◀.	Lowens the picture brightness and weakens the picture.	Minimum value -31

Attention

- Adjust the BRIGHTNESS in advance if necessary.

BRIGHTNESS

You can adjust the brightness of the projected image.

- 1) Press ▲▼ to select [BRIGHTNESS].
- 2) Press ◀▶ or <ENTER> button.
 - The [BRIGHTNESS] individual adjustment screen will be displayed.
- 3) Press ◀▶ to adjust the level.

Operation	Adjustment	Adjustment range
Press ▶.	Increases the brightness of the dark (black) parts of the screen.	Maximum value 31
Press ◀.	Reduces the brightness of the dark (black) parts of the screen.	Minimum value -31

COLOR

You can adjust the color saturation of the projected image.

- 1) Press ▲▼ to select [COLOR].
- 2) Press ◀▶ or <ENTER> button.
 - The [COLOR] individual adjustment screen will be displayed.
- 3) Press ◀▶ to adjust the level.

Operation	Adjustment	Adjustment range
Press ▶.	Deepens colors.	Maximum value 31
Press ◀.	Weakens colors.	Minimum value -31

TINT

You can adjust the skin tone in the projected image.

- 1) Press ▲▼ to select [TINT].
- 2) Press ◀▶ or <ENTER> button.
 - The [TINT] individual adjustment screen will be displayed.
- 3) Press ◀▶ to adjust the level.

Operation	Adjustment	Adjustment range
Press ▶.	Adjusts skin tone toward greenish color.	Maximum value 31
Press ◀.	Adjusts skin tone toward reddish-purple.	Minimum value -31

COLOR TEMPERATURE

You can adjust the white balance of the projected image.

- 1) Press ▲▼ to select [COLOR TEMPERATURE].
- 2) Press ◀▶ or <ENTER> button.
 - The [COLOR TEMPERATURE] individual adjustment screen will be displayed.
- 3) Press ◀▶ to switch [COLOR TEMPERATURE].
 - The setting will change as follows each time ◀▶ is pressed.

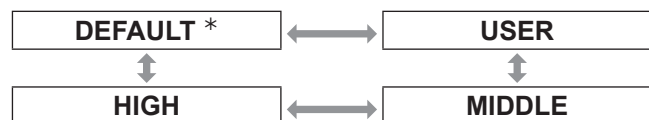

*: [DEFAULT] cannot be selected when the [PICTURE MODE] has been set to [DICOM SIM.].

Note

- When any setting other than [OFF] has been selected for [COLOR MATCHING] (➔page 53), the [COLOR TEMPERATURE] setting is fixed to [USER1].

■ To further adjust toward the desired white balance

- 4) Select [USER] in Step 3).
- 5) Press <ENTER> button.
 - The [COLOR TEMPERATURE] screen will be displayed.
- 6) Press ▲▼ to select [WHITE BALANCE].

PICTURE menu

- 7) Press **<ENTER>** button.
 - The [WHITE BALANCE] screen will be displayed.
- 8) Press **▲▼** to select [WHITE BALANCE HIGH] or [WHITE BALANCE LOW].
- 9) Press **<ENTER>** button.
 - The [WHITE BALANCE HIGH (or LOW)] screen will be displayed.
- 10) Press **▲▼** to select [RED], [GREEN] or [BLUE].
- 11) Press **◀▶** to adjust the level.

Item	Operation	Adjustment	Adjustment range
RED	Press ▶ .	Deepens red.	Maximum value HIGH : 255 LOW : 127
	Press ◀ .	Weakens red.	
GREEN	Press ▶ .	Deepens green.	Minimum value HIGH : 0 LOW : -127
	Press ◀ .	Weakens green.	
BLUE	Press ▶ .	Deepens blue.	Default HIGH : 255 LOW : 0
	Press ◀ .	Weakens blue.	

Note

- All colors will not be displayed properly unless adequate adjustment is made. If the adjustment does not look suitable, you can press **<DEFAULT>** button to return the setting for the selected item only to the factory default setting.
- The [COLOR TEMPERATURE] cannot be adjusted for the internal test pattern (▶page 70). Be sure to project the input signal when adjusting the [COLOR TEMPERATURE].

Changing the name of [USER]

1. Select [USER] in step 3).
2. Press **<ENTER>** button.
 - The [COLOR TEMPERATURE] screen will be displayed.
3. Press **▲▼** to select [COLOR TEMPERATURE NAME CHANGE].
4. Press **<ENTER>** button.
 - The [COLOR TEMPERATURE NAME CHANGE] screen will be displayed.

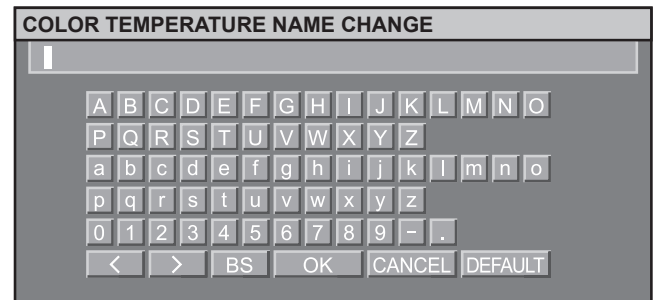

- 5) Press **▲▼◀▶** to select characters and press **<ENTER>** button to input them.
6. Press **▲▼◀▶** to select [OK], and press **<ENTER>** button.
 - The color temperature setting name is changed.

WHITE GAIN

Adjusts the brightness of a white image.

- 1) Press **▲▼** to select [WHITE GAIN]
- 2) Press **◀▶** or **<ENTER>** button.
 - The [WHITE GAIN] control screen is displayed.
- 3) Press **◀▶** to adjust the brightness level.

Operation	Adjustment	Adjustment range
Press ▶ button.	Increases the image brightness.	Maximum value: 10
Press ◀ button.	Displays the natural image.	Minimum value: 0

SHARPNESS

This adjusts the sharpness of the pictures.

- 1) Press ▲▼ to select [SHARPNESS].
- 2) Press ◀▶ or <ENTER> button.
 - The [SHARPNESS] individual adjustment screen will be displayed.
- 3) Press ◀▶ to adjust the level.

Operation	Adjustment	Adjustment range
Press ▶.	Contours become sharper.	0 - 15
Press ◀.	Contours become softer.	

NOISE REDUCTION

This can be used to adjust pictures if they contain interference as a result of poor quality of the input signal.

- 1) Press ▲▼ to select [NOISE REDUCTION].
- 2) Press ◀▶ or <ENTER> button.
 - The [NOISE REDUCTION] individual adjustment screen will be displayed.
- 3) Press ◀▶ to switch [NOISE REDUCTION].
 - The setting will change as follows each time ◀▶ is pressed.

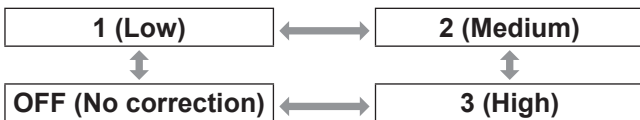

Attention

- [NOISE REDUCTION] is set active when the selected input signal has less noise. Applying noise reduction may affect the image quality, if so, set to [OFF].

AI

Gray scale control is exercised to suit the images, and optimal images with a clear contrast are projected.

- 1) Press ▲▼ to select [AI].
- 2) Press ◀▶ to switch [AI].
 - The setting will change as follows each time ◀▶ is pressed.



ON	AI compensation is enabled.
OFF	AI compensation is disabled.

DAYLIGHT VIEW

This corrects images so that they appear vivid when projected under bright lighting.

- 1) Press ▲▼ to select [DAYLIGHT VIEW].
- 2) Press ◀▶ or <ENTER> button.
 - The [DAYLIGHT VIEW] individual adjustment screen will be displayed.
- 3) Press ◀▶ to switch [DAYLIGHT VIEW].
 - The setting will change as follows each time ◀▶ is pressed.

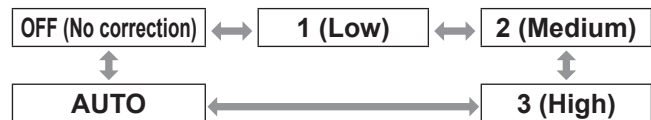

SYSTEM SELECTOR

This enables the projector to automatically recognize input signals. Furthermore, if unstable signals are input, the system format can be selected manually.

- 1) Press **▲ ▼** to select **[SYSTEM SELECTOR]**.
- 2) Press **<ENTER>** button.
- 3) Press **▲ ▼** to switch **[SYSTEM SELECTOR]**.
- 4) Press **<ENTER>** button.

VIDEO/S-VIDEO terminal input signal

Select from AUTO, NTSC, NTSC4.43, PAL, PAL-M, PAL-N, SECAM, and PAL60.

Attention

- [AUTO] mode is selected by default.
- When the projector is not working properly in [AUTO] mode, change the setting according to each SYSTEM SELECTOR type.

Note

- [AUTO] automatically selects from NTSC, NTSC4.43, PAL, PAL-M, PAL-N, SECAM, and PAL60.

RGB1/RGB2 terminal input signal

- 480i, 576i, 576p signals
Select from RGB and YC_BCR.
- VGA60, 480p signals
Select from VGA60, 480p, and 480pRGB.
- Other signals
Select from RGB and YP_BPR.

Note

- Refer to "List of compatible signals" (➔page 87) for available signals.

DVI-D terminal input signal

- 480p, 576p signals
Select from RGB and YC_BCR.
- Other signals
Select from RGB and YP_BPR.

Note

- Refer to "List of compatible signals" (➔page 87) for available signals.
- Malfunction may occur or other problems could be encountered with some equipment.

HDMI terminal input signal

- 480p, 576p signals
Select from Auto, RGB, and YC_BCR.
- Other signals
Select from Auto, RGB, and YP_BPR

Note

- Refer to "List of compatible signals" (➔page 87) for available signals.
- Malfunction may occur or other problems could be encountered with some equipment.

To display pictures complying with the sRGB standard

sRGB is the international color reproduction standard (IEC61966-2-1) established by IEC (International Electrotechnical Commission).

To reproduce colors more faithfully in compliance with the sRGB standard, perform the following setting procedure.

- 1) Set **[COLOR MATCHING]**, **[COLOR COLLECTION]** adjustment to **[OFF]**.
 - Refer to "COLOR MATCHING" (➔page 53).
 - Refer to "COLOR COLLECTION" (➔page 54).
- 2) Display the **[PICTURE]** screen.
 - Refer to "PICTURE menu" (➔page 42).
- 3) Press **▲ ▼** to select **[PICTURE MODE]**.
- 4) Press **◀ ▶** to select **[NATURAL]**.
- 5) Press **▲ ▼** to select **[COLOR]**.
- 6) Press **<DEFAULT>** button on the remote control to restore the factory default.
- 7) Follow the same procedure (steps 5-6) to restore the factory default for **[TINT]**, **[COLOR TEMPERATURE]** and **[GAMMA]**.

Note

- sRGB is only enable when RGB signals are being input.

POSITION menu

- See “Navigating through the menu” (➔page 39).
- See “MAIN MENU” and “SUB MENU” (➔page 40).

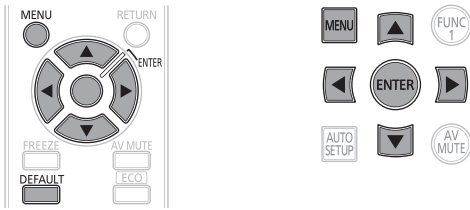

SHIFT

This function allows the user to adjust the raster position vertically or horizontally if the position of the image projected on the screen is displaced even when the projector is properly aligned with the screen, and the internal test patterns are correctly framed.

- 1) Press ▲▼ to select [SHIFT].
- 2) Press <ENTER> button.
 - The [SHIFT] screen will be displayed.
- 3) Press ▲▼◀▶ to adjust the position.

■ For vertical (up and down) adjustment

Operation	Adjustment
Press ▲.	The picture position moves up.
Press ▼.	The picture position moves down.

■ For horizontal (right and left) adjustment

Operation	Adjustment
Press ▶.	The picture position moves to the right.
Press ◀.	The picture position moves to the left.

ASPECT

This changes the aspect ratio of the projected image. This changes the aspect ratio for the screen range selected with [SCREEN SETTING]. Set [SCREEN SETTING] first. (➔page 54)

- 1) Press ▲▼ to select [ASPECT].
- 2) Press ◀▶ or <ENTER> button.
 - The [ASPECT] individual adjustment screen will be displayed.
- 3) Press ◀▶ to switch [ASPECT].
 - The setting will change as follows each time ◀▶ is pressed.

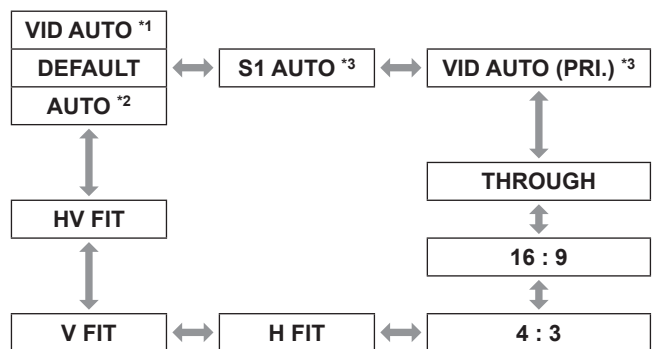

- *1 : VIDEO/S-VIDEO (NTSC) only
- *2 : RGB1/RGB2 (480i, 480p) only
- *3 : S-VIDEO (NTSC) only

■ DEFAULT

Pictures are displayed without changing the aspect ratio of the input signals.

■ VID AUTO

The projector identifies the video ID (VID) embedded in the picture signals and displays the picture by automatically switching the screen sizes between 4 : 3 and 16 : 9. This function is effective for the NTSC signal input.

■ AUTO

The projector identifies the video ID (VID) embedded in the picture signals and displays the picture by automatically switching the screen sizes between 4 : 3 and 16 : 9. This function is effective for the 480i/480p signal input.

■ S1 AUTO

The projector identifies the S1 signal and displays the picture by automatically switching the screen sizes between 4 : 3 and 16 : 9. This function is effective for S-VIDEO NTSC signals.

POSITION menu

VID AUTO (PRI.)

The projector identifies the abovementioned VID or S1 signals and displays the picture by automatically choosing the screen sizes of 4 : 3 or 16 : 9 according to the VID if it is detected or S1 signals if a VID is not detected. This function is effective for S-Video NTSC signals.

THROUGH

Pictures are displayed without changing the resolution of the input signals.

16 : 9

When standard signals ^{*4} are input, the pictures are displayed with the aspect ratio converted to 16 : 9. When wide signals are input ^{*5}, the pictures are displayed without changing the aspect ratio.

4 : 3

When standard signals ^{*4} are input, the pictures are displayed without changing the aspect ratio. When wide signals are input ^{*5} and [4:3] is selected with [SCREEN FORMAT], the aspect ratio is changed to 4:3. If [4:3] is not selected with [SCREEN FORMAT], the pictures are reduced so that they will be in the 4:3 screen without changing the input aspect ratio.

H FIT

The display will use the full width of the screen range selected with [SCREEN FORMAT]. When signals have a vertical aspect ratio that is larger than the screen aspect selected with [SCREEN FORMAT], the pictures will be displayed with their bottom areas cut off.

V FIT

The display will use the full height of the screen range selected with [SCREEN FORMAT].

HV FIT

The pictures are displayed in the full screen range selected with [SCREEN FORMAT]. If the aspect ratios of the input signals and screen range differ, conversion to the screen aspect set with [SCREEN FORMAT] is performed and then the pictures are displayed.

*4 : Standard signals are input signals with an aspect ratio of 4 : 3 or 5 : 4.

*5 : Wide-screen signals are input signals with an aspect ratio of 16:10, 16 : 9, 15 : 9 or 15 : 10.

Note

- Some size modes are not available for certain types of input signals. For NTSC signals, [DEFAULT] cannot be selected.
- If an aspect ratio which is different from the aspect ratio for the input signals is selected, the pictures will appear differently from the originals. Be careful of this when selecting the aspect ratio.
- If using this projector in places such as cafes or hotels to display programs for a commercial purpose or for public presentation, note that adjusting the aspect ratio or using the zoom function to change the screen pictures may be an infringement of the rights of the original copyright owner for that program under copyright protection laws.
- If conventional (normal) 4 : 3 pictures which are not wide-screen pictures are displayed on a wide screen, the edges of the pictures may not be visible or they may become distorted. Such pictures should be viewed as with an aspect ratio of 4 : 3 in the original format intended by the creator of the pictures.

ZOOM

This adjusts the size of the projected pictures.

- 1) Press ▲ ▼ to select [ZOOM].
- 2) Press <ENTER> button.
 - The [ZOOM] screen will be displayed.
- 3) Press ▲ ▼ to select [VERTICAL]/ [HORIZONTAL], and press ◀ ▶ to adjust.

When [ASPECT] is set to [DEFAULT]

- 1) Press ▲ ▼ to select [MODE].
- 2) Press ◀ ▶ to switch [MODE].

INTERNAL	Zoom area is the factory default setting of [SCREEN FORMAT] in [SCREEN SETTING].
FULL	Enlarges the size of the pictures using the whole of the display area selected with [SCREEN FORMAT].

- 3) Press ▲▼ to select [INTERLOCKED].
- 4) Press ◀▶ to switch [INTERLOCKED].

OFF	The [VERTICAL] and [HORIZONTAL] settings are used as the vertical and horizontal zoom ratios respectively.
ON	The zoom ratio is set to the [BOTH] setting. This allows the pictures to be zoomed at equal vertical and horizontal ratios.

Note

- When [ASPECT] is set to [THROUGH], [ZOOM] will not appear.
- When other than [DEFAULT] is selected for [ASPECT], the [MODE] selection setting will not appear.

CLOCK PHASE

Clock phase adjustment achieves the best image when the screen flickers or halos are observed around contours.

- 1) Press ▲▼ to select [CLOCK PHASE].
- 2) Press ◀▶ or <ENTER> button.
 - The [CLOCK PHASE] individual adjustment screen will be displayed.
- 3) Press ◀▶ to adjust the level.
 - The value changes from 0 to 63. Adjust so that the amount of interference is at a minimum.

Note

- The CLOCK PHASE may not be adjusted, depending on the signal.
- No optimal value may be obtained if the output of the PC to which the signal input is applied is unstable.
- No optimal value may be obtained if the total number of dots is not correct.
- The [CLOCK PHASE] can be adjusted only when RGB signal input is applied with RGB1 and RGB2 IN.

KEYSTONE

If the projector is aligned non-perpendicularly to the screen, or if the projection screen has an angled surface, you can correct keystone.

- 1) Press ▲▼ to select [KEYSTONE].
- 2) Press <ENTER> button.
- 3) Select the desired adjustment item.
- 4) Press ◀▶ to adjust.

KEYSTONE

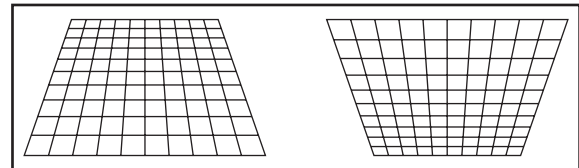

SUB KEYSTONE

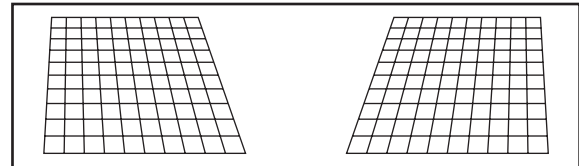

LINEARITY

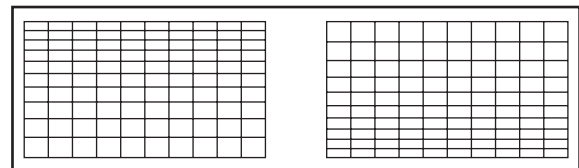

Note

- When [KEYSTONE] setting is set, displayed menu or startup logo might be projected outside of the actual image area.
- You can correct the distortion $\pm 40^\circ$ from the plane. For a better quality image, installing the projector with a minimum of distortion is recommended.
- Some distortion may be retained for lens shift adjustment.
- The result of the keystone correction will affect the aspect ratio and the size of the image.

ADVANCED MENU

- See “Navigating through the menu” (➔page 39).
- See “MAIN MENU” and “SUB MENU” (➔page 40).

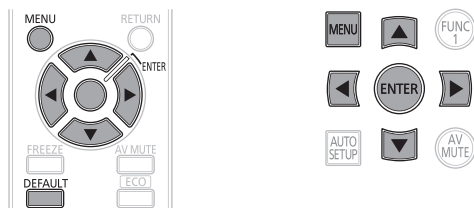

DIGITAL CINEMA REALITY

Increase the vertical resolution when the PAL (or SECAM) 576i signal input or the NTSC 480i, 1 080/50i and 1 080/60i signal input is applied.

- 1) Press ▲▼ to select [DIGITAL CINEMA REALITY].
- 2) Press ◀▶ or <ENTER> button.
 - The [DIGITAL CINEMA REALITY] individual adjustment screen will be displayed.
- 3) Press ◀▶ to select [DIGITAL CINEMA REALITY].
 - The setting will change as follows each time ◀▶ is pressed.

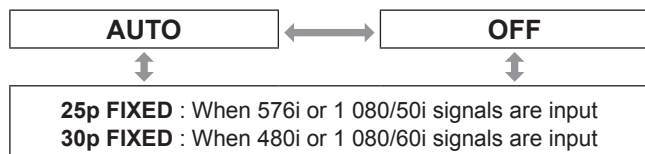

AUTO	Performs automatic detection and cinema processing. (factory default)
OFF	Unforced cinema processing.
25p FIXED	Forced cinema processing (2 : 2 pulldown) is performed when a 576i or 1 080/50i signal is input.
30p FIXED	Forced cinema processing (2 : 2 pulldown) is performed when a 480i or 1 080/60i signal is input.

Note

- In [DIGITAL CINEMA REALITY] mode, the image quality will be deteriorated if [30p FIXED] or [25p FIXED] is selected when the signal is not a 2 : 2 pulldown signal.

BLANKING

Blanking adjustment fine-tunes the images projected by the video deck or other devices when the noise appears on the edges of the screen or if a part of the image lies slightly offscreen.

- 1) Press ▲▼ to select [BLANKING].
- 2) Press <ENTER> button.
 - The [BLANKING] screen will be displayed.
- 3) Press ▲▼ to select the desired item for adjustment.
- 4) Press ◀▶ to adjust blanking.
 - The adjustment value for the PT-DZ570U can be changed within a range of 0 to 599 vertically and 0 to 959 horizontally.
 - The adjustment value for the PT-DW530U can be changed within a range of 0 to 399 vertically and 0 to 639 horizontally.
 - The adjustment value for the PT-DX500U can be changed within a range of 0 to 383 vertically and 0 to 511 horizontally.

When correcting the upper blanking of the screen (top)

Press ◀ to move the blanking zone upward; Press ▶ to downward.

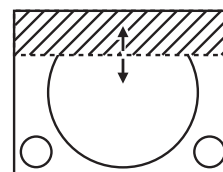

When correcting the lower blanking of the screen (bottom)

Press ▶ to move the blanking zone upward; Press ◀ to downward.

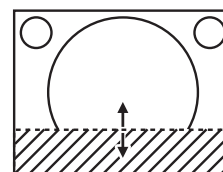

When correcting the left hand blanking of the screen (left)

Press ▶ to move the blanking zone to the right; Press ◀ to the left.

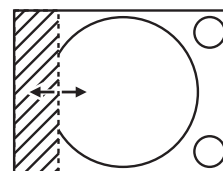

When correcting the right hand blanking of the screen (right)

Press ◀ to move the blanking zone to the right; Press ▶ to the left.

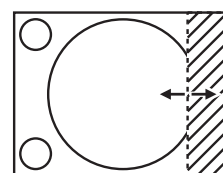

INPUT RESOLUTION

Input resolution adjustment achieves the best image when the screen flickers or halo is observed around the contour. Set the values appropriately for the signal resolution that is being used.

- 1) Press ▲▼ to select [INPUT RESOLUTION].
- 2) Press <ENTER> button.
 - The [INPUT RESOLUTION] screen will be displayed.
- 3) Press ▲▼ to select [TOTAL DOTS], [DISPLAY DOTS], [TOTAL LINES] or [DISPLAY LINES], and the press ◀▶ to adjust it.
 - Each item automatically displays a value in response to the type of the input signal. If vertical stripes appear on the screen or the image is partly missing, increase or decrease the displayed value while observing the screen to achieve the optimal value.

Note

- The vertical stripes will not appear on the all white signal image.
- The picture may be distorted during the adjusting operation, but this is not a fault.
- The [INPUT RESOLUTION] can be adjusted only when RGB signal input is applied with RGB1 and RGB2 IN.

CLAMP POSITION

Use the clamp position adjustment to achieve the optimal value when dark areas of the image are crushed or displayed in green.

- 1) Press ▲▼ to select [CLAMP POSITION].
- 2) Press ◀▶ to adjust.
 - The value changes from 1 to 255.
 - **The optimal value for the clamp position adjustment**
 If dark areas are crushed :
 The optimal value is the point where the dark area is best improved.
 If the dark areas are displayed in green :
 The optimal value is the point where the green areas become black and the crushing effect is rectified.

Note

- The [CLAMP POSITION] can be adjusted only when the RGB signal input is applied with RGB1 and RGB2 IN.
- The [CLAMP POSITION] may not be adjusted, depending on the signal.

FRAME RESPONSE

When 1 080/60i, 1 080/50i or 1 080/24sF signals are entered, the video processing is simplified and the frame delay of image is reduced.

- 1) Press ▲▼ to select [FRAME RESPONSE].
- 2) Press ◀▶ to switch [FRAME RESPONSE] setting.
 - The setting will change as follows each time the button is pressed.

NORMAL	↔	FAST
NORMAL		Precedes the image quality.
FAST		Suppresses a time delay.

Note

- Select the [NORMAL] mode to display a high-quality image.
- If [NOISE REDUCTION] is set to [1], [2] or [3], the [FRAME RESPONSE] function is suppressed.

RASTER POSITION

When the scaler is set such that the image is smaller than the display area, the image can be moved to any position inside the display area.

- 1) Press ▲▼ to select [RASTER POSITION].
- 2) Press <ENTER> button.
 - The [RASTER POSITION] screen will be displayed.
- 3) Press ▲▼◀▶ to adjust the position.

DISPLAY LANGUAGE menu

- See “Navigating through the menu” (➔page 39).
- See “MAIN MENU” and “SUB MENU” (➔page 40).

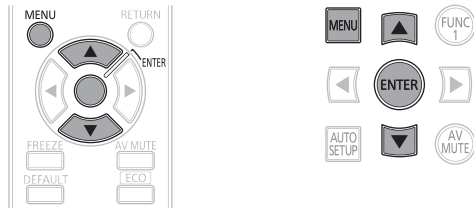

Changing the display language

This lets you switch the on-screen display language.

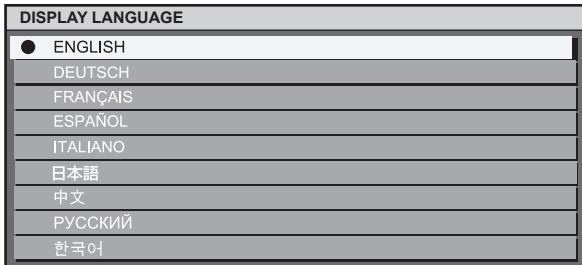

- Menus, setting items, adjustment screens, and control button names will be displayed in the language the user chooses.
- The available languages are: English, German (DEUTSCH), French (FRANÇAIS), Spanish (ESPAÑOL), Italian (ITALIANO), Japanese (日本語), Chinese (中文), Russian (русский), and Korean (한국어).

Note

- The on-screen display of the projector is set to the English language on shipping.

DISPLAY OPTION menu

- See “Navigating through the menu” (➔page 39).
- See “MAIN MENU” and “SUB MENU” (➔page 40).

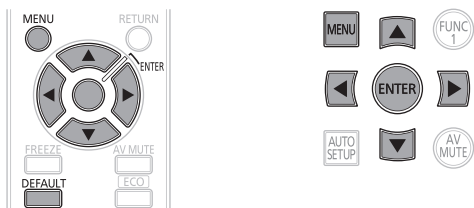

COLOR MATCHING

When multiple sets are used simultaneously, this projector allows the user to correct the difference of colors among the sets.

- 1) Press ▲▼ to select [COLOR MATCHING].
- 2) Press ◀▶ to switch [COLOR MATCHING].
 - The setting will change as follows each time ◀▶ is pressed.

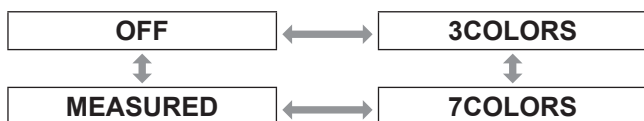

OFF	Color matching adjustment is not carried out.
3COLORS	It is possible to adjust the 3colors of [RED], [GREEN] and [BLUE].
7COLORS	It is possible to adjust the 7colors of [RED], [GREEN], [BLUE], [CYAN], [MAGENTA], [YELLOW] and [WHITE].
MEASURED	Refer to “■ Adjusting the color matching using a colorimeter” (➔ on this page) for details on this mode.

■ If [3COLORS] or [7COLORS] was selected in step 2).

- 3) Press <ENTER> button.
 - The [3COLORS] or [7COLORS] screen will be displayed.
- 4) Press ▲▼ to select [RED], [GREEN] and [BLUE] (if [7COLORS] was selected, select [RED], [GREEN], [BLUE], [CYAN], [MAGENTA], [YELLOW], and [WHITE]).

5) Press <ENTER> button.

- The [3COLORS:RED], [3COLORS:GREEN] or [3COLORS:BLUE] screen will be displayed. If you selected [7COLORS], the [7COLORS:RED], [7COLORS:GREEN], [7COLORS:BLUE], [7COLORS:CYAN], [7COLORS:MAGENTA], [7COLORS:YELLOW], or [7COLORS:WHITE] screen will be displayed.
- If [AUTO TEST PATTERN] is turned [ON], the test pattern of the selected color is displayed.

6) Press ◀▶ to adjust the values.

- These values can be adjusted from 0 (off) to 2 048 (full gain).

Note

- The effects of correcting the adjustment color:
 - When tuning the correction color that is the same as the adjustment color: the brightness of the adjustment color changes.
 - RED : RED is added to or reduced from the adjustment color.
 - GREEN : GREEN is added to or reduced from the adjustment color.
 - BLUE : BLUE is added to or reduced from the adjustment color.
- This adjustment should be carried out by a person who is familiar with the projector or by a service person because a high level of skill is required to make successful adjustment.
- Pressing <DEFAULT> button will restore the factory defaults for all items.
- When any setting other than [OFF] has been selected for [COLOR MATCHING], the [COLOR TEMPERATURE] setting is fixed at [USER1].

■ Adjusting the color matching using a colorimeter

The [RED], [GREEN], [BLUE], [CYAN], [MAGENTA], [YELLOW] and [WHITE] colors can be changed to the desired hues using a colorimeter which is capable of measuring the chromaticity coordinates and luminance.

• Inputting the current luminance and chromaticity coordinates

- 1) Press ▲▼ to select [COLOR MATCHING].
- 2) Press ◀▶ to select [709MODE] or [MEASURED].
- 3) Press <ENTER> button.
 - The [MEASURED MODE] screen will be displayed.
- 4) Press ▲▼ to select [MEASURED DATA].
- 5) Press <ENTER> button.
 - The [MEASURED DATA] screen will be displayed.

DISPLAY OPTION menu

- 6) Use the colorimeter to measure the luminance (Y) and chromaticity coordinates (x, y)
- 7) Press **▲▼** to select the colors, and press **◀▶** to select their values.
 - If [AUTO TEST PATTERN] is turned [ON], the test pattern of the selected color is displayed.
- 8) After all the data has been input, press **<MENU>** button.
 - The [MEASURED MODE] screen will be displayed.

● Inputting the coordinates of a desired color

- 9) Press **▲▼** to select [TARGET DATA].
- 10) Press **<ENTER>** button.
 - The [TARGET DATA] screen will be displayed.
- 11) Press **▲▼** to select the desired colors, and press **◀▶** to input their coordinates.
 - If [AUTO TEST PATTERN] is turned [ON], the test pattern of the selected color is displayed.
- 12) After all the data has been input, press **<MENU>** button.

Note

- If the target data is outside the color range of the projector, the colors will not be projected correctly.

COLOR CORRECTION

A different color can be adjusted and stored for each input signal system.

- 1) Press **▲▼** to select [COLOR CORRECTION].
- 2) Press **◀▶** to switch [COLOR CORRECTION] setting.
 - The setting will change as follows each time the button is pressed.



OFF	Standard setting
USER	Can adjust and store six colors ([RED], [GREEN], [BLUE], [CYAN], [MAGENTA] and [YELLOW]) for each of the four VIDEO, S-VIDEO, RGB, and YP _B Pr/YC _B Cr signaling systems.

■ If you have selected [USER] in step 2

- 3) Press **<ENTER>** button.
 - The [COLOR CORRECTION] screen is displayed.
- 4) Press **▲▼** to select [RED], [GREEN], [BLUE], [CYAN], [MAGENTA] and [YELLOW].
- 5) Press **◀▶** to adjust.
 - The adjustable range is -30 to +30.

SCREEN SETTING

Set this in accordance with the screen you are using. When the projection image aspect ratio is changed, the projector makes corrections to ensure the optimal images for the set screen size.

- 1) Press **▲▼** to select [SCREEN SETTING].
- 2) Press **<ENTER>** button.
 - The [SCREEN SETTING] screen will be displayed.
- 3) Press **◀▶** to switch [SCREEN FORMAT].

■ PT-DZ570U



■ PT-DW530U



■ PT-DX500U



- 4) Press **◀▶** to adjust [SCREEN POSITION].

- In the case of the PT-DZ570U :
When [SCREEN FORMAT] is [16 : 9]
Adjustment range: -60 to +60
When [SCREEN FORMAT] is [4 : 3]
Adjustment range: -160 to +160
- In the case of the PT-DW530U, you can adjust the setting from -132 to +131.

Note

- [SCREEN POSITION] cannot be adjusted when [SCREEN FORMAT] is [16 : 10] (PT-DZ570U/PT-DW530U) or [4 : 3] (PT-DX500U).

WAVEFORM MONITOR

(PT-DZ570U only)

This function displays the waveform of the input signal from a connected peripheral device.

You can check if the image output (BRIGHTNESS) signal level is within the range recommended by this projector and adjust it as necessary.

- 1) Press **▲▼** to select **[WAVEFORM MONITOR]**.
- 2) Press **◀▶** to switch **[WAVEFORM MONITOR]**.
 - The setting will change as follows each time **◀▶** is pressed.



- 3) Press the **<MENU>** button twice to turn off the menu screen.
- 4) Select any horizontal line with the **▲▼**.

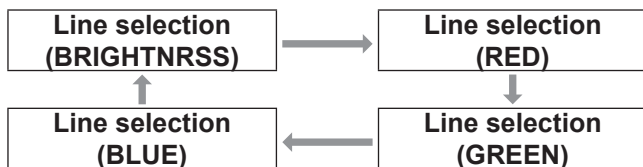

Note

- Setting can also be performed using the **<FUNCTION>** button. (➔page 66)

Adjust the waveform

Project the brightness adjustment signal from, for example, a commercially available adjustment disc (0% [0 IRE or 7.5 IRE] - 100 % [100 IRE]) and adjust the waveform.

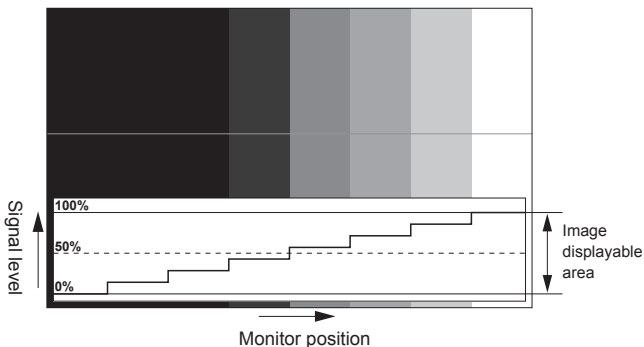

Adjusting brightness

- 1) Select **[Line selection (BRIGHTNRSS)]** in the waveform monitor.
- 2) Adjust the black level.
 - In **[BRIGHTNESS]** of on-screen menu **[PICTURE]**, adjust the 0 % of the black level of the image signal to the position corresponding to 0% on the waveform monitor.

Adjust the white level.

- In **[CONTRAST]** of on-screen menu **[PICTURE]**, adjust the 100 % of the while level of the image signal to the position corresponding to 100 % on the waveform monitor.

Adjusting RED, GREEN, and BLUE

- 1) Set **[COLOR TEMPERATURE]** to **[USER1]** or **[USER2]**. (➔page 43)
- 2) Select **[Line selection (RED)]** in the waveform monitor.
- 3) Adjust the dark portion of **RED**.
 - In **[RED]** of **[WHITE BALANCE LOW]**, adjust the 0 % of the black level of the image signal to the position corresponding to 0 % on the waveform monitor. (➔page 43)
- 4) Adjust the light portion of **RED**.
 - In **[RED]** of **[WHITE BALANCE HIGH]**, adjust the 100 % of the white level of the image signal to the position corresponding to 100 % on the waveform monitor. (➔page 43)
- 5) Adjust **[GREEN]** and **[BLUE]** in a similar manner.

Note

- When the DVI-D signal, HDMI signal, or SDI signal is inputted, check that the **[DVI SIGNAL LEVEL]**, **[HDMI SIGNAL LEVEL]**, and **[SDI SIGNAL LEVEL]** are correctly set before adjusting the black level.
- The keystone cannot be applied to the waveform monitor display.
- The waveform monitor is not displayed while the on-screen display is off.

AUTO SIGNAL

You can turn ON/OFF automatically detecting system of the AUTO SETUP feature.

- 1) Press **▲▼** to select **[AUTO SIGNAL]**.
- 2) Press **◀▶** to switch **[AUTO SIGNAL]**.
 - The setting will change as follows each time **◀▶** is pressed.



OFF	Only when <AUTO SETUP> button is pressed, the projected image position will be adjusted.
ON	If unregistered signals are input when [ON] is selected, auto setup will be initiated automatically.

DISPLAY OPTION menu

AUTO SETUP

Use this setting when adjusting a specific or oblong (16:9, etc.) signal.

- 1) Press ▲▼ to select [AUTO SETUP].
- 2) Press <ENTER> button.
 - The [AUTO SETUP] screen will be displayed.
- 3) Press ▲▼ to select [MODE].
- 4) Press ◀▶ to switch [MODE].
 - The setting will change as follows each time ◀▶ is pressed.



DEFAULT	To receive signals of which image aspect is 4:3 or 5:4 (applicable resolution : 640 × 400, 640 × 480, 800 × 600, 832 × 624, 960 × 720, 1 024 × 768, 1 152 × 864, 1 152 × 870, 1 280 × 960, 1 280 × 1 024, 1 600 × 1 200, 1 400 × 1 050)
WIDE	To receive signals of which the image aspect is wide (applicable resolution: 720 × 400, 848 × 480, 1 280 × 720, 1 024 × 600, 1 120 × 750, 1 440 × 900, 1 680 × 1 050)
USER	To receive signals of specific horizontal resolution (number of horizontally displayed dots)

- 5) If [USER] is selected, press ◀▶ to enter the horizontal resolution of signal source into [DISPLAY DOTS].
- 6) Press <ENTER> button.
 - Execute automatic adjustment. A message "PROGRESS" appears during automatic adjustment. When the adjustment is complete, the system returns to the input screen.

Adjusting the position automatically

1. Select [POSITION ADJUST] in step 3).
2. Press ◀▶ to switch [POSITION ADJUST].
 - The setting will change as follows each time ◀▶ is pressed.



OFF	Automatic adjustment is off.
ON	Screen position and size are adjusted during AUTO SETUP operation.

Adjusting the signal level automatically

1. Select [SIGNAL LEVEL ADJUST] in step 3).
2. Press ◀▶ to switch [SIGNAL LEVEL ADJUST].
 - The setting will change as follows each time ◀▶ is pressed.



OFF	Automatic adjustment is off.
ON	The black level (On-screen menu [BRIGHTNESS]) and white level (On-screen menu [CONTRAST]) are adjusted during AUTO SETUP operation.

Note

- If the input image is not a still image with a clear difference between black and white, the [SIGNAL LEVEL ADJUST] function may not operate normally.

RGB IN (Only RGB input)

Change this setting to change the input impedance of the synchronous signal input.

- 1) Press ▲▼ to select [RGB IN].
- 2) Press <ENTER> button.
 - The [RGB IN] screen will be displayed.
- 3) Press ▲▼ to select [RGB1 SYNC TERMINAL] or [RGB2 SYNC TERMINAL].
- 4) Press ◀▶ to switch.
 - The setting will change as follows each time ◀▶ is pressed.



LOW	Input impedance is set to [LOW].
HIGH	Input impedance is set to [HIGH].

DVI-D IN

Change this setting if video does not display normally when the projector and an external device are connected via DVI.

- 1) Press ▲▼ to select [DVI-D IN].
- 2) Press <ENTER> button.
 - The [DVI-D IN] screen will be displayed.
- 3) Press ▲▼ to select [DVI EDID].
- 4) Press ◀▶ to switch [DVI EDID].
 - The setting will change as follows each time ◀▶ is pressed.



EDID3	Switch between fine settings for a moving image and for a still image.
EDID1	Mainly select this when an external device (DVD player, etc.) for outputting video signals of a moving image system is connected to DVI-D IN.
EDID2 : PC	Mainly use this when an external device (PC, etc.) for outputting video signals of a still image system is connected to DVI-D IN.

- 5) Press ▲▼ to select [DVI SIGNAL LEVEL].

- 6) Press ◀▶ to switch [DVI SIGNAL LEVEL].

- The setting will change as follows each time ◀▶ is pressed.



0-255 : PC	Select this when, for example, an external device (PC, etc.) is connected via the DVI terminal output.
16-235	Select this when, for example, an external device (DVD player, etc.) is connected via the HDMI terminal output using a conversion cable.

Note

- The optimal setting differs depending on the output setting of the connected external device. Refer to the instruction manual of the external device.
- If the setting is changed, the data for plug and play changes. For the plug and play compatible resolutions, refer to "List of compatible signals" (▶ page 87).

HDMI IN

Change this setting if video does not display normally when the projector and an external device are connected via HDMI.

- 1) Press ▲▼ to select [HDMI IN].
- 2) Press <ENTER> button.
 - The [HDMI IN] screen will be displayed.
- 3) Press ◀▶ to switch [HDMI SIGNAL LEVEL].
 - The setting will change as follows each time ◀▶ is pressed.



0-1023	Select this when, for example, a DVI terminal output of an external device (PC etc.) is connected to HDMI IN using a conversion cable, etc.
64-940	Select this when, for example, an HDMI terminal output of an external device (DVD player, etc.) is connected to HDMI IN.

Note

- The optimal setting differs depending on the output setting of the connected external device. Refer to the instruction manual for the external device.
- The displayed HDMI signal level is the value when the input is 30 bit.

DISPLAY OPTION menu

ON-SCREEN DISPLAY

The user can specify the on-screen display.

- 1) Press **▲ ▼** to select [**ON-SCREEN DISPLAY**].
- 2) Press **<ENTER>** button.
 - The [ON-SCREEN DISPLAY] screen will be displayed.
- 3) Press **▲ ▼** to select the desired item, and press **◀ ▶** to change the setting.

OSD POSITION

This sets the position of the on-screen display (OSD).

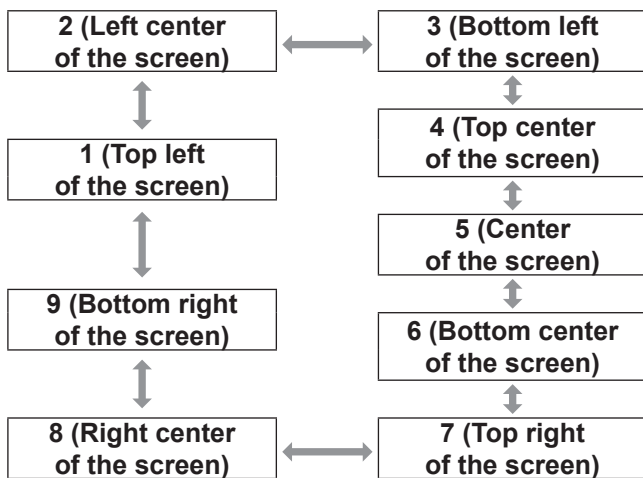

OSD DESIGN

This sets the color of the on-screen display (OSD).

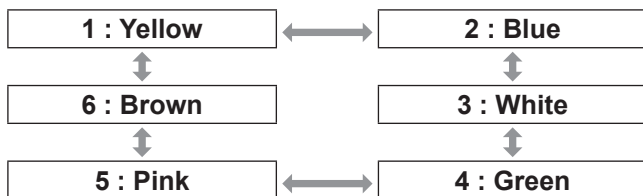

OSD MEMORY

The current menu cursor position will be retained temporarily unless the projector switched off.



INPUT GUIDE

This sets whether to display the currently selected input guide at the position set for [OSD POSITION].



WARNING MESSAGE

This sets the display of warning messages.



CLOSED CAPTION SETTING

(for NTSC, 525i (480i) input only)

Set the closed caption display as follows.

- 1) Press **▲ ▼** to select [**CLOSED CAPTION SETTING**].
- 2) Press **<ENTER>** button.
 - The [CLOSED CAPTION SETTING] screen is displayed.
- 3) Press **▲ ▼** to select, and press **◀ ▶** to switch.

CLOSED CAPTION

Displays or hides the closed caption.



MODE

Selects a closed caption mode.

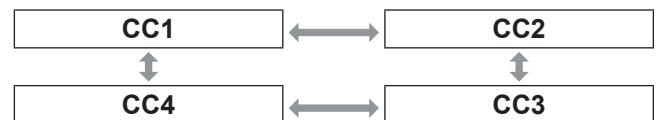

Note

- The Closed Caption function is used in North American countries to display text on a television or video screen to provide additional or interpretive information to viewers. The caption may not be displayed on some devices or when unsupported software is used.

BACK COLOR

This sets the color for the projection screen when no signals are being input.

- 1) Press ▲▼ to select [BACK COLOR].
- 2) Press ◀▶ to switch [BACK COLOR].
 - The setting will change as follows each time ◀▶ is pressed.

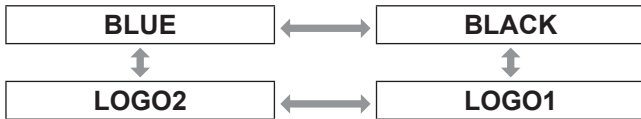

BLUE	The entire projection area will appear blue.
BLACK	The entire projection area will appear black.
LOGO1	The picture registered by the user will be projected in the projection area.
LOGO2	The Panasonic logo is projected.

Note

- Separate software is required in order to create the pictures to use for [LOGO1].

STARTUP LOGO

This sets the startup logo that is projected when the power is turned on.

- 1) Press ▲▼ to select [STARTUP LOGO].
- 2) Press ◀▶ to switch [STARTUP LOGO].
 - The setting will change as follows each time ◀▶ is pressed.



LOGO2	The Panasonic logo is projected.
NONE	No startup logo is projected.
LOGO1	The picture registered by the user will be projected.

Note

- Separate software is required in order to create the pictures to use for [LOGO1]. Consult your dealer.
- STARTUP LOGO will be displayed for 15 seconds.

Managing the sub memory list

You can restore the sub memory data when using signals from the same input source. Sub memory data contains the setting information of screen and image adjustments, such as BRIGHTNESS, CONTRAST or ASPECT.

Registering the current settings to the list

- 1) In the normal screen (when the menu is not displayed), press ◀▶ button.
 - The signal must be registered before creating a sub memory data of the signal.
 - Displays the list of corresponding sub memory data to the signal.
- 2) Press ▲▼◀▶ to select the required sub memory data.
- 3) Press <ENTER> button.
 - The [SIGNAL NAME] screen will be displayed.
- 4) Press <ENTER> button.

Note

- For renaming a registered data, follow the same procedure (steps 4 - 5) of "Renaming a registered data" (➔page 71).

Displaying the sub memory list and restoring the settings

- 1) In the normal screen (when the menu is not displayed), press ◀▶ button.
 - The [SUB MEMORY LIST] screen will be displayed.
- 2) Press ▲▼◀▶ to select the required sub memory data, and press <ENTER> button.
 - The [REGISTERED SIGNAL STATUS] screen will be displayed.
- 3) Press <ENTER> button.
 - Restores the settings in the data.

Deleting a sub memory data

- 1) In the normal screen (when the menu is not displayed), press ◀▶ button.
 - The [SUB MEMORY LIST] screen will be displayed.
- 2) Press ▲▼◀▶ to select the required sub memory data, and press <ENTER> button.
 - The [REGISTERED SIGNAL STATUS] screen will be displayed.
- 3) Press <DEFAULT> button.
 - Displays the [SUB MEMORY LIST] with change.
 - You can return to the previous step by pressing <MENU> button.

DISPLAY OPTION menu

FREEZE

You can freeze the projected image and stop the sound temporarily, regardless of the playing condition of the connected device.

- 1) Press ▲▼ to select [FREEZE].
- 2) Press <ENTER> button.
 - Press <MENU> button to escape.

SIDE BY SIDE

(PT-DZ570U and PT-DW530U only)

When a small sub-screen is placed in the main screen, dual images can be projected simultaneously.

- 1) Press ▲▼ to select [SIDE BY SIDE].
- 2) Press <ENTER> button.
 - Dual screens are projected.
- 3) Press <MENU> button.
 - The [SIDE BY SIDE] is displayed.
- 4) Press ▲▼ to select each item.

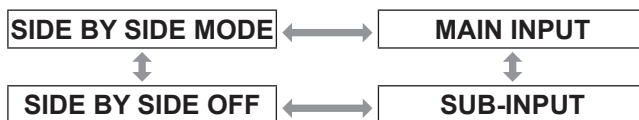

SIDE BY SIDE MODE	Selects a SIDE BY SIDE display pattern from [MODE1] to [MODE4]. <ul style="list-style-type: none"> ● Select [SIDE BY SIDE MODE] in Step 4, and press ◀▶ to switch to any of [MODE1] to [MODE4].
MAIN INPUT	Sets an input terminal to be displayed for signal main input. <ul style="list-style-type: none"> ● Select [MAIN INPUT] in Step 4, press <ENTER> button, and press ▲▼ to select any of [VIDEO], [S-VIDEO], [RGB1], [RGB2], [DVI-D], [HDMI] and [NETWORK]. Then, press <ENTER> button.
SUB INPUT	Sets an input terminal to be displayed for signal sub input. <ul style="list-style-type: none"> ● Select [SUB INPUT] in Step 4, press <ENTER> button, and press ▲▼ to select any of [VIDEO], [S-VIDEO], [RGB1], [RGB2], [DVI-D], [HDMI] and [NETWORK]. Then, press <ENTER> button. <p>CLOCK PHASE: If RGB1 or RGB2 terminal is set for signal sub input and if pictures flicker or their outlines blur, adjust the clock phase between 0 and 63.</p> <ul style="list-style-type: none"> ● Select [SUB-INPUT] in Step 4, press <ENTER> button, and press ▲▼ to select [CLOCK PHASE]. Then, press ◀▶ to change the clock phase.

SIDE BY SIDE OFF

Turns Off the dual-screen projection.

- Select [SIDE BY SIDE OFF] in Step 4, and press <ENTER> button.

Note

- The SIDE BY SIDE function is not available depending on the input signals and the selected input terminals. See “Two window display combination list” for details. (➔page 86)
- The MAIN INPUT settings apply to the [PICTURE MODE], [GAMMA], and [COLOR TEMPERATURE] video settings.

■ [SIDE BY SIDE MODE] options

MODE 1:

Projects dual screens by fully using the horizontal size of each screen.

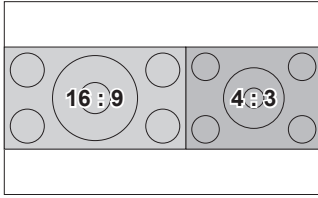

- The aspect ratio is held.
- The main and sub-screens have the same height.
- The screens are centered in vertical direction.

MODE 2:

The main and sub-screens have a 1-to-1 horizontal ratio.

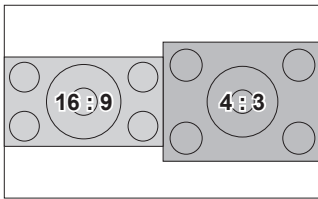

MODE 3:

The main and sub-screens have a 2-to-1 horizontal ratio.

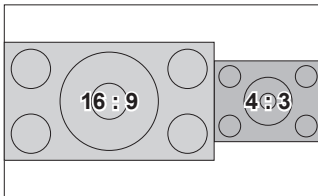

MODE 4:

The main and sub-screens have a 1-to-2 horizontal ratio.

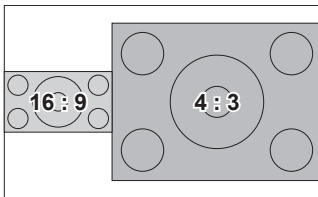

HIGH ALTITUDE MODE

If you use the projector at high elevation (1 400 m to 2 700 m), the [HIGH ALTITUDE MODE] setting needs to be [ON] to set the fan speed high.

- 1) Press ▲▼ to select [HIGH ALTITUDE MODE].
- 2) Press ◀▶ to switch [HIGH ALTITUDE MODE] and press <ENTER> to select.
 - The setting will change as follows each time ◀▶ is pressed.

OFF	↔	ON
OFF		Select this when using in normal environment (less than 1 400 m above sea level)
ON		Select this when using at high altitude (above 1 400 m and less than 2 700 m above sea level)

- 3) When the confirmation message is displayed, select [OK] or [CANCEL].

Note

- The loudness of fan noise depends on the [HIGH ALTITUDE MODE] setting.
- The separately-sold Smoke Cut Filter cannot be used when the [HIGH ALTITUDE MODE] is [ON].

LAMP POWER

Can switch the electric power of projector lamp. Set the lamp power to meet the environment and purpose of projection.

- 1) Press ▲▼ to select [LAMP POWER].
- 2) Press ◀▶ to switch [LAMP POWER].
 - The setting will change as follows each time the button is pressed.

NORMAL	↔	ECO
NORMAL		Sets the normal lamp intensity.
ECO		Sets the reduced lamp intensity.

Note

- The [ECO] mode can reduce the power consumption, reduce the operation noise, and increase the service life of projector lamp.
- The [LAMP POWER] may not drop automatically if:
 - You have set the [LAMP POWER] to [NORMAL].
 - Automatic power drop may fail immediately after the lamp is turned on or the [LAMP POWER] is set.

ECO MANAGEMENT

Can optimize lamp power and reduce the power consumption according to the application.

- 1) Press ▲▼ to select [ECO MANAGEMENT].
- 2) Press <ENTER> button.
 - The [ECO MANAGEMENT] screen is displayed.
- 3) Press ▲▼ to select ECO MANAGEMENT.
- 4) Press ◀▶ to switch the setting.

AUTO POWER SAVE

[AMBIENT LIGHT DETECTION], [SIGNAL DETECTION], and [AV MUTE DETECTION] functions can be used.

1. Select [AUTO POWER SAVE] in Step 3.
2. Press ◀▶ to switch [AUTO POWER SAVE] setting.
 - The setting will change as follows each time the button is pressed.

ON	↔	OFF
----	---	-----

3. Press ▲▼ to select AUTO POWER SAVE conditions.

AMBIENT LIGHT DETECTION	Adjusts the lamp power according to the ambient brightness.
SIGNAL DETECTION	Drops the lamp power when no signal is input.
AV MUTE DETECTION	Drops the lamp power in the AV Mute mode.

4. Press ◀▶ to enable or disable the selected condition.
 - The setting will change as follows each time the button is pressed

ON	↔	OFF
----	---	-----

PROJECTOR SETUP menu

■ NO SIGNAL SHUT-OFF

If no signal is input within a preset time, the projector power is automatically switched to the standby state.

1. Select **[NO SIGNAL SHUT-OFF]** in Step 3.
2. Press **◀▶** to switch **[NO SIGNAL SHUT-OFF]** setting.

DISABLE	The NO SIGNAL SHUT-OFF is ineffective.
10 to 90 minutes	The Auto Power-Off time can be set in 10 minute increments.

■ STANDBY MODE

This function can set the electric power when the projector is standing by.

- 1) Select **[STANDBY MODE]** in Step 3.
- 2) Press **◀▶** to switch **[STANDBY MODE]** setting.
 - The setting will change as follows each time the button is pressed.

NORMAL	↔	ECO
---------------	---	------------

Note

- If STANDBY MODE is set to [ECO], you cannot use network functions when the projector is standing by. Also, you cannot use some RS-232C protocol commands. When you turn the POWER switch [ON], display of the initial image may be delayed for approximately 10 seconds when compared with [NORMAL] mode operation.
- If set to [NORMAL], you can use network functions when the projector is standing by.

SCHEDULE

This sets the command execution schedule for each day of the week.

■ How to enable the SCHEDULE function

- 1) Press **▲▼** to select **[SCHEDULE]**.
- 2) Press **◀▶** to switch **[SCHEDULE]**.
 - The setting will change as follows each time **◀▶** is pressed.

ON	↔	OFF
-----------	---	------------

Note

- If [SCHEDULE] is set to [ON], the setting for [STANDBY MODE] is automatically set to [NORMAL] and cannot be changed. Even if [SCHEDULE] is then set to [OFF] when in this state, the setting of [STANDBY MODE] remains at [NORMAL].

■ How to assign a program

- 1) With **[SCHEDULE]** switched to **[ON]**, press **<ENTER>** button.
 - The [SCHEDULE] screen will be displayed.
- 2) Select and assign program to each day of week.
 - Press **▲▼** to select a day of week and press **◀▶** to select a program number.
 - You can set the program from No.1 to No.7. “- -” indicates that the program number has not been set yet.

■ How to set a program

You can set up to 16 commands to each program.

- 1) On the **[SCHEDULE]** screen, press **▲▼** to select **[PROGRAM EDIT]**.
- 2) Press **◀▶** to select a program number to be set and press **<ENTER>** button.
- 3) Press **▲▼** to select a command number and press **<ENTER>** button.
 - You can change the page using **◀▶**.

4) Press ▲▼ to select [TIME] or [COMMAND] and change the setting according to the instructions of the menu.

TIME	Set the time at which the command will be executed using ▲▼ buttons.
COMMAND	<p>Select a command to execute at the set time from the following.</p> <ul style="list-style-type: none"> • POWER ON • STANDBY • AV MUTE ON • AV MUTE OFF • INPUT RGB1 • INPUT RGB2 • INPUT VIDEO • INPUT S-VIDEO • INPUT DVI-D • INPUT HDMI • INPUT NETWORK • LAMP POWER NORMAL • LAMP POWER ECO • SIDE BY SIDE MODE OFF • SIDE BY SIDE MODE1 • SIDE BY SIDE MODE2 • SIDE BY SIDE MODE3 • SIDE BY SIDE MODE4 • IN STANDBY MODE (AUDIO) ON • IN STANDBY MODE (AUDIO) OFF • VOLUME

*: PT-DZ570U/PT-DW530U only

5) Press ▲▼ to select [STORE] and press <ENTER> button.

Note

- If you try to register a setting that would cause the lamp to flash for a short time, an error message will be displayed on the screen. Set the [TIME] and [COMMAND] again.
- To delete a command which has been set, press <DEFAULT> button.
- If multiple commands have been set for the same time, they are executed in chronological order starting from the smallest command number.
- The setting time operates under the local time. (➔page 67)
- If an operation is executed with the remote control or control panel of the projector or with a control command before the command set in the schedule is executed, the command set with this function may not be executed.

RS-232C

This sets the communication parameters at the serial terminals.

- 1) Press ▲▼ to select [RS-232C].
- 2) Press <ENTER> button.
 - The [RS-232C] screen will be displayed.
- 3) Press ▲▼ to select communication conditions.
- 4) press ◀▶ to change the setting.

Note

- Refer to “Serial terminal” (➔page 82).

Selecting items in [EMULATE]

When using the control commands for one of our projectors that you have previously purchased to control this projector using a computer via its serial input terminal, set up the EMULATE function as follows. This will allow you to use the control software etc. designed for our existing projectors.

1. Select [EMULATE] in step 3).
2. Press <ENTER> button.
3. Press ▲▼ to select the required item.
4. Press <ENTER> button.

● DEFAULT	DZ570 Series, DW530 Series, DX500 Series
L730 SERIES	L520 Series, L720 Series, L730 Series
L780 SERIES	L750 Series, L780 Series
L735 SERIES	L735 Series
L785 SERIES	L785 Series
F SERIES	F100 Series, FW100 Series, F200 Series, F300 Series, FW300 Series
LB SERIES	LB75 Series, LB78 Series, LB80 Series, LB90 Series, LB1 Series, LB2 Series, ST10 Series

PROJECTOR SETUP menu

REMOTE MODE

You can customize the [REMOTE IN] terminal function.

- 1) Press ▲ ▼ to select [REMOTE MODE].
- 2) Press ◀ ▶ to switch [REMOTE MODE].
 - The setting will change as follows each time ◀ ▶ is pressed.



DEFAULT	The pin assignment of the [REMOTE IN] terminal is used as the projector default setting. (➡ page 85)
USER	This is used for changing the settings for the REMOTE terminal. Any settings you make for pins 2 to 8 become valid once you press <ENTER> button.
F SERIES	Use the setting for F Series-compatible REMOTE terminal.

FUNCTION BUTTON

Three function buttons (<FUNCTION1 to 3>) on the remote control and the <FUNCTION1> button on the projector can be assigned to any frequent operations. They can be used as a useful shortcut button.



- 1) Press any of the <FUNCTION1 to 3> buttons on the remote control or the <FUNCTION1> button on the projector.
- 2) Press <MENU> button on the remote control or the projector to select a menu option (Main Menu, Submenu or Advanced Menu).
 - For the on-screen menu selection, see "On-screen menu". (➡ page 39)
- 3) Hold down any of the <FUNCTION1 to 3> buttons on the remote control or the <FUNCTION1> button on the projector more than 3 seconds.

Note

- For details, see "FUNCTION BUTTON" section of "PROJECTOR SETUP". (➡ page 66)

AUDIO SETTING

VOLUME

You can adjust the volume of the built-in monaural speaker and VARIABLE AUDIO OUT terminal.

- ◀ Decrease
- ▶ Increase

BALANCE

You can adjust to hear the sound played equally through both right and left from VARIABLE AUDIO OUT, or shift the balance so more sound plays through the left or right side.

- ◀ More sound plays through the left side
- ▶ More sound plays through the right side

IN STANDBY MODE

You can switch on/off the sound output in standby mode.

- OFF No sound in standby mode.
- ON Output audio in standby mode.

AUDIO IN SELECT

A sound input terminal of [AUDIO IN 1], [AUDIO IN 2], [AUDIO IN 3], [HDMI AUDIO IN] and [NETWORK AUDIO IN] can be selected.

- 1) Press ▲ ▼ to select a [AUDIO IN SELECT] terminal.
- 2) Press ◀ ▶ to switch [AUDIO IN SELECT].
 - The setting will change as follows each time the button is pressed.

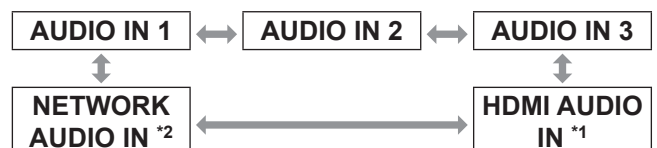

*1 : An input terminal having the HDMI port only

*2 : An input terminal having the network port only

AUDIO IN 1	Sound is output from AUDIO IN 1 terminal when video of preset input terminal is projected.
AUDIO IN 2	Sound is output from AUDIO IN 2 terminal when video of preset input terminal is projected.
AUDIO IN 3	Sound is output from AUDIO IN 3 terminal when video of preset input terminal is projected.
HDMI AUDIO IN	Sound is output from HDMI terminal when video of preset input terminal is projected.
NETWORK AUDIO IN	Sound is output from NETWORK terminal when video of preset input terminal is projected.

STATUS

Displays the status of the projector.

- 1) Press ▲▼ to select [STATUS].
- 2) Press <ENTER> button.
- 3) Press ◀▶ to move to the next page.

INPUT	Displays the input selection state.
SIGNAL NAME	Displays the input signal name.
SIGNAL FREQUENCY	Displays the frequency of the input signal.
PROJECTOR RUNTIME	Displays the projector runtime.
LAMP	<ul style="list-style-type: none"> ● ECO: LAMP POWER: Shows the lamp lighting time in ECO mode. ● NORMAL: LAMP POWER: Shows the lamp lighting time in NORMAL operation. ● TOTAL: Shows the total lamp lighting time.
INTAKE AIR TEMP.	Displays the intake air temperature of the projector.
OPTICS MODULE TEMP.	Displays the temperature inside the projector.
AROUND LAMP TEMP.	Displays the temperature around the lamp of the projector.
NUMBER OF ENTRY SIGNAL	Displays the number of registered signals.
REMOTE STATUS	Displays [REMOTE] control status.
PROJECTOR TYPE	Displays type of projector.
SERIAL NUMBER	Displays the serial number of the projector.
LAMP UNIT MODEL NO.	Displays the component number of the lamp unit.
LAMP SERIAL NUMBER	Displays the serial number for lamp.
MAIN VERSION	Displays the main version of the firmware of the projector unit.
SUB VERSION	Displays the sub version of the firmware of the projector unit.
NETWORK VERSION	Displays the network version of the projector unit.
EMULATE	Displays the set emulate mode.

ON COUNT

- POWER ON TIMES :
Displays the number of times the power has been turned on.
- LAMP ON :
Displays the number of times LAMP has been lit.

*1 :

$$\left[\begin{array}{l} \text{Lamp replacement time} = \\ \text{LAMP POWER [NORMAL] lighting time} \\ + (\text{LAMP POWER [ECO] lighting time} \times 2 \div 3) \end{array} \right]$$

DATE AND TIME

This lets you set the time zone and the current date and time for the projector's internal clock.

■ Setting the TIME ZONE

- 1) Press ▲▼ to select [DATE AND TIME].
- 2) Press <ENTER> button.
- 3) Press ▲▼ to select [TIME ZONE].
- 4) Press ◀▶ to switch [TIME ZONE].

■ Adjusting the date and time manually

- 1) Press ▲▼ to select [DATE AND TIME].
- 2) Press <ENTER> button.
- 3) Press ▲▼ to select [ADJUST CLOCK].
 - The [ADJUST CLOCK] screen will be displayed.
- 5) Press ▲▼ to select the item to be set, and press ◀▶ to set the local time.
- 6) Press ▲▼ to select [APPLY], and press <ENTER> button.
 - This completes setting of the time.

PROJECTOR SETUP menu

■ Adjusting the date and time automatically

- 1) Press ▲ ▼ to select [DATE AND TIME].
- 2) Press <ENTER> button.
- 3) Press ▲ ▼ to select [ADJUST CLOCK].
- 4) Press <ENTER> button.
 - The [ADJUST CLOCK] screen will be displayed.
- 5) Press ▲ ▼ to select [NTP SYNCHRONIZATION] and press ◀ ▶ to switch to [ON].
 - The setting will change as follows each time ◀ ▶ is pressed.
- 6) Press ▲ ▼ to select [APPLY], and press <ENTER> button.
 - This completes setting of the time.



Note

- To set the date and time automatically, the projector must be connected to the network.
- If synchronization with the NTP server fails just after [NTP SYNCHRONIZATION] is turned [ON], or if [NTP SYNCHRONIZATION] is turned [ON] while the NTP server is not set, [NTP SYNCHRONIZATION] will return to [OFF].
- Access the projector via a web browser to set the NTP server.

SAVE ALL USER DATA

This saves various setting values as a backup to the internal memory of the projector.

- 1) Press ▲ ▼ to select [SAVE ALL USER DATA].
- 2) Press <ENTER> button.
 - The [SECURITY PASSWORD] screen will be displayed.
- 3) Enter the password set for the [SECURITY PASSWORD].
 - The confirmation screen will be displayed.
- 4) Press ◀ ▶ to select [OK], and press <ENTER> button.

LOAD ALL USER DATA

This loads various setting values that were saved as a backup to the internal memory of the projector.

- 1) Press ▲ ▼ to select [LOAD ALL USER DATA].
- 2) Press <ENTER> button.
 - The [SECURITY PASSWORD] screen will be displayed.
- 3) Enter the password set for the [SECURITY PASSWORD].
 - The confirmation screen will be displayed.
- 4) Press ◀ ▶ to select [OK], and press <ENTER> button.

Note

- If this is executed, the projector enters a standby state in order to reflect the setting values.

INITIALIZE

This returns various setting values to their factory default settings.

- 1) Press ▲▼ to select [INITIALIZE].
- 2) Press <ENTER> button.
 - The [SECURITY PASSWORD] screen will be displayed.
- 3) Enter the password set for the [SECURITY PASSWORD].
 - The [INITIALIZE] screen will be displayed.
- 4) Press ▲▼ to select the desired initialize item.

ALL USER DATA	All setting values including [ENTRY SIGNAL], [NETWORK/E-MAIL], and [LOGO IMAGE] are returned to their factory default values. The projector enters a standby state in order to reflect the setting values.
ENTRY SIGNAL	All setting values saved for each of the input signals are cleared. To clear just some registered signals, perform the procedure described in "Deleting a registered data" (▶page 71).
NETWORK/E-MAIL	All setting values in [NETWORK SETUP] and [E-mail setup] settings will return to factory settings.
LOGO IMAGE	The registered image data for [LOGO1] will return to factory settings.

- 5) Press <ENTER> button.
 - The confirmation screen will be displayed.
- 6) Press ◀▶ to select [OK], and press <ENTER> button.

SERVICE PASSWORD

This function is used by a service person.

TEST PATTERN menu

- See “Navigating through the menu” (➔page 39).
- See “MAIN MENU” and “SUB MENU” (➔page 40).

TEST PATTERN

Results of adjustment of the position, size and other factors are not reflected in test patterns. Ensure the input signal is displayed before performing various kinds of setting.

1) Press ◀▶ to select the required test pattern.

■ Cycle of displayed internal test patterns

The setting will change as follows each time ◀▶ is pressed.

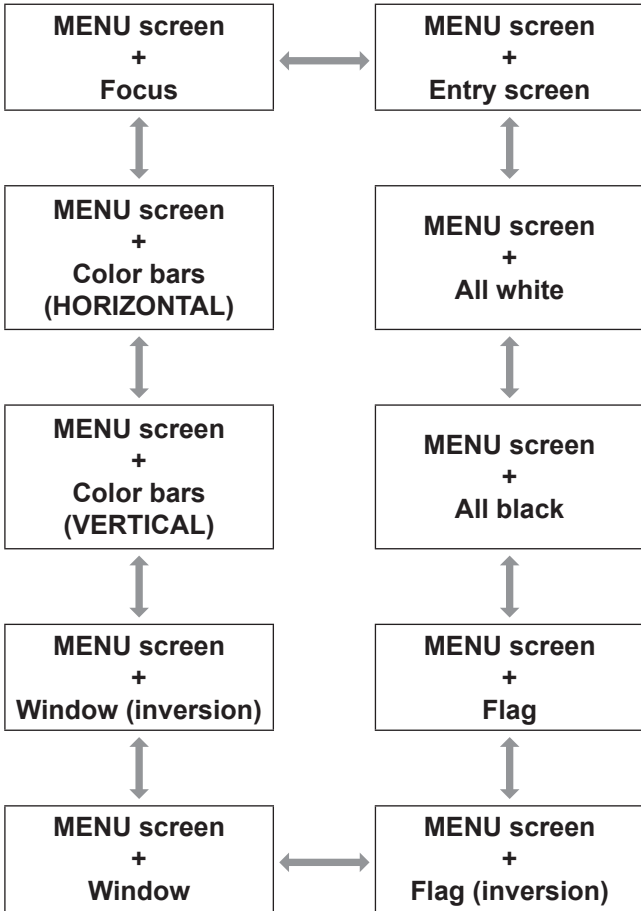

Settings

SIGNAL LIST menu

- See “Navigating through the menu” (➔page 39).
- See “MAIN MENU” and “SUB MENU” (➔page 40).

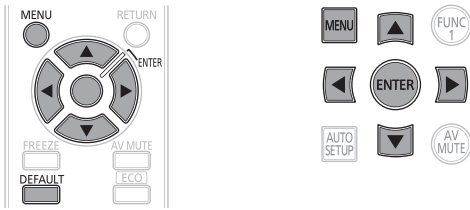

REGISTERED SIGNAL STATUS

- The name can be set for each sub memory.
- MEMORY NO. : A1 (1-2)

↑ ↑
Sub memory number

When the address number (A1, A2, ...H7, H8) signal is registered

Registering a signal to the list

When a new format input signal is applied to the projector, press <MENU> button to register to the SIGNAL LIST.

Note

- You can register data up to 96 in total number of the signal data and any corresponding sub memory data.
- The memories are numbered over 12 pages (A to L: 8 data items can be registered on each page), and the data is registered in the unused memory with the lowest number. If all the memories are used, the data of the old signals is overwritten in sequence.
- The names of the registered data are automatically determined by the input signals and memory numbers.
- If a menu is being displayed, the new signals will be registered at the instant they are input.

Renaming a registered data

- 1) Press ▲▼◀▶ to select the required signal data.
- 2) Press <ENTER> button.
 - The [REGISTERED SIGNAL STATUS] screen will be displayed.
 - Displays the character list.
 - Press <MENU> button to return to the [REGISTERED SIGNAL LIST] screen.
- 3) Press <ENTER> button.
 - The [RENAME] screen will be displayed.
- 4) Press ▲▼◀▶ to select characters and press <ENTER> button to input them.
- 5) Press ▲▼◀▶ to select [OK], and press <ENTER> button.
 - The [REGISTERED SIGNAL LIST] screen will be displayed.
 - Press ▲▼◀▶ to select [CANCEL] and press <ENTER> button to return to the [REGISTERED SIGNAL LIST] without any change.

Deleting a registered data

- 1) Press ▲▼◀▶ to select the required signal data.
- 2) Press <DEFAULT> button.
 - The [ENTRY SIGNAL CLEAR] screen will be displayed.
 - Press <MENU> button to cancel and return to the [REGISTERED SIGNAL LIST] without any change.
- 3) Press <ENTER> button.
 - Displays [REGISTERED SIGNAL LIST] and confirm the data is deleted.

SECURITY menu

- See “Navigating through the menu” (➔page 39).
- See “MAIN MENU” and “SUB MENU” (➔page 40).
- When you apply to the [SECURITY] menu before you change the password to your original, perform to input the following factory default password operation.
Press **▲▼◀▶** and **<ENTER>** button.

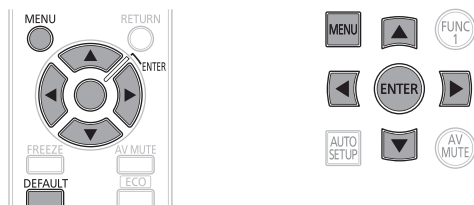

Attention

- When you apply to the SECURITY menu after you change the password to your original in the [SECURITY PASSWORD CHANGE] menu, input the original password operation.

Note

- Only asterisks * will appear on the screen to represent the actual characters of the password when the password is entered.

SECURITY PASSWORD

The [SECURITY PASSWORD] screen can be displayed when the power has been turned on. If the correct password is not entered, operations other than using **<STANDBY (⏻)>** button and **<AV MUTE>** button will not be possible.

- 1) Press **▲▼** to select [SECURITY PASSWORD].
- 2) Press **◀▶** to switch [SECURITY PASSWORD].
 - The setting will change as follows each time **◀▶** is pressed.



OFF	Deactive
ON	Active

Note

- [PASSWORD] is set to [OFF] by default and when initialized.
- Change the SECURITY PASSWORD regularly and make it uneasy to guess.
- The security password becomes valid when setting of the security password is turned [ON] and then the MAIN POWER switch is turned off.

SECURITY PASSWORD CHANGE

The password can be changed.

- 1) Press **▲▼** to select [SECURITY PASSWORD CHANGE].
- 2) Press **<ENTER>** button.
 - The [SECURITY PASSWORD CHANGE] screen will be displayed.
- 3) Press **▲▼◀▶** and numeral keys to set the password.
 - Up to 8 buttons can be set as the password.
- 4) Press **<ENTER>** button.
- 5) For the purposes of confirmation, enter the password again.
- 6) Press **<ENTER>** button.

Note

- Only asterisks * will appear on the screen to represent the actual characters of the password when the password is entered.
- If the password input second does not match with the password input first, an error message is displayed. In this case, input the correct password again.
- When numerals are used in the SECURITY PASSWORD, initialization of the security password will be necessary if the remote control is lost. For the method of initialization, consult your dealer.

DISPLAY SETTING

You can set your original text, such as company name or URL information, to display regularly on the projected image while projecting.

- 1) Press ▲▼ to select [DISPLAY SETTING].
- 2) Press ◀▶ to switch [DISPLAY SETTING].
 - The setting will change as follows each time ◀▶ is pressed.



OFF	The text display is disabled.
TEXT	The text display is enabled.
LOGO1	The picture registered by the user will be projected.

Note

- Separate software [Logo Transfer Software] is required in order to create the pictures to use for [LOGO1]. Consult your dealer.

TEXT CHANGE

You can enter your original text to be displayed when [DISPLAY SETTING] is turned [TEXT].

- 1) Press ▲▼ to select [TEXT CHANGE].
- 2) Press <ENTER> button.
 - The [TEXT CHANGE] screen will be displayed.
- 3) Press ▲▼◀▶ to select characters and press <ENTER> button to input them.
- 4) Press ▲▼◀▶ to select [OK], and press <ENTER> button.
 - The text is now changed.

MENU LOCK

You can lock <MENU> button function and the password will be asked to display the menu every time.

- 1) Press ▲▼ to select [MENU LOCK].
- 2) Press ◀▶ to switch [MENU LOCK].
 - The setting will change as follows each time ◀▶ is pressed.



OFF	Deactivate the [MENU LOCK] system.
ON	Activate the [MENU LOCK] system.

Note

- Once [MENU LOCK] is set to [ON], you cannot use <MENU> button unless you input the correct password.
- The [MENU LOCK] is set to [OFF] by default and when initialized.
- The unlock state is maintained until the projector is set to the standby mode.

MENU LOCK PASSWORD

You can change the password for [MENU LOCK] system to your original.

- 1) Press ▲▼ to select [MENU LOCK PASSWORD].
- 2) Press <ENTER> button.
 - The [MENU LOCK PASSWORD] screen will be displayed.
- 3) Press ▲▼◀▶ to select characters and press <ENTER> button to input them.
- 4) Press ▲▼◀▶ to select [OK], and press <ENTER> button.
 - To stop, select [CANCEL].

Attention

- The factory default password is "AAAA".
- When the projector is initialized, the password will be changed to the factory default setting, "AAAA".
- Change the MENU LOCK PASSWORD regularly and make it uneasy to guess.

SECURITY menu

CONTROL DEVICE SETUP

Control from the remote control and main unit controls can be restricted.

- 1) Press **▲ ▼** to select **[CONTROL DEVICE SETUP]**.
- 2) Press **<ENTER>** button.
 - The **[CONTROL DEVICE SETUP]** screen will be displayed.
- 3) Press **▲ ▼** to select **[CONTROL PANEL]** or **[REMOTE CONTROLLER]**.
- 4) Press **<ENTER>** button.
 - **[CONTROL PANEL]** screen or **[REMOTE CONTROLLER]** screen will be displayed.

■ CONTROL PANEL

- Restriction of control from the main unit controls can be set.

ENABLE	Enables control from the main unit controls.
DISABLE	Disables control from the main unit controls.

■ REMOTE CONTROLLER

- Restriction of control from the remote control can be set.

ENABLE	Enables control from the remote control.
DISABLE	Disables control from the remote control.

- 5) Press **▲ ▼** to select **[ENABLE]** or **[DISABLE]**, and press **<ENTER>** button.
 - The confirmation screen will be displayed.
- 6) Press **◀▶** to select **[OK]**, and press **<ENTER>** button.

Note

- If an attempt is made to control the projector from the remote control or main unit controls when **[DISABLE]** is set, the **[SECURITY PASSWORD]** screen appears. To change a setting, enter the security password and change the operation setting.
- The **[SECURITY PASSWORD]** screen disappears if **<MENU>** button is pressed or no operation is performed for 10 seconds.
- If you **[DISABLE]** both of the **[CONTROL PANEL]** and **[REMOTE CONTROLLER]** buttons, you cannot return to the standby mode. Use this function with utmost care.
- If a setting is reflected, the on-screen menu disappears. To continue operation, press **<MENU>** button to display the main menu.

Monitor Lamp indicators

Managing the indicated problems

If a problem should occur with the projector, the indicators will inform you. Manage the indicated problems as follow.

Attention

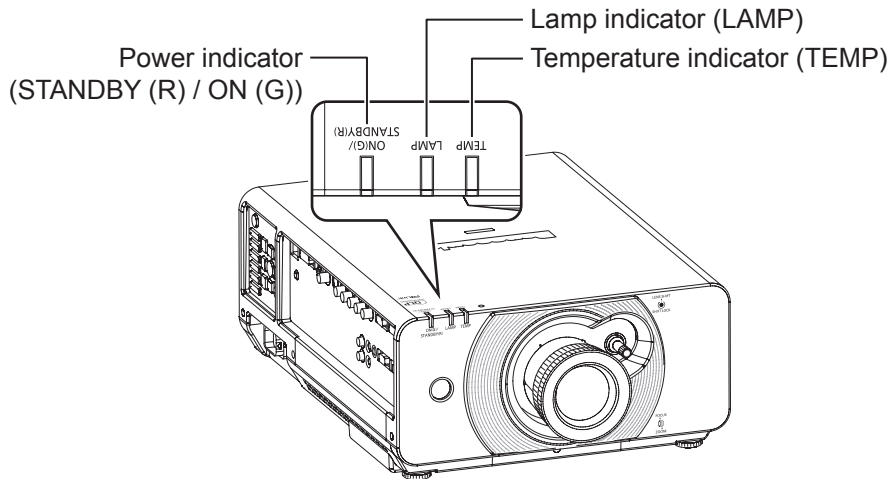

LAMP indicator

Lamp indication	Information	Check point	Remedial measure
Lighting in red	Indicates the time for replacing the lamp unit.	<ul style="list-style-type: none"> Did you notice a "REPLACE LAMP" message on the screen when turning on the projector power supply? 	<ul style="list-style-type: none"> This lamp monitor lights up when the lamp unit used hours have reached 1 800 hours (when [NORMAL] is selected as the [LAMP POWER] setting). Request the dealer to replace the lamp unit.
Blinking in red (once)	Lamp unit is not installed.	<ul style="list-style-type: none"> Check the lamp unit compartment. 	<ul style="list-style-type: none"> Install the lamp unit. When lamp unit is installed and still having the indicator lights, contact to the dealer.
Blinking in red (3 times)	Error is detected in the lamp circuit.	<ul style="list-style-type: none"> Did you turn the power back on immediately after turning it off? Some error has arisen in the lamp circuit. Check for fluctuation (or drop) in the source voltage. 	<ul style="list-style-type: none"> Wait until the lamp has cooled off, and then turn on the power. Turn off the MAIN POWER switch using the procedure on page 33 and consult the dealer.

Note

- If no problem is found or the problem remains, do not turn on the projector. Instead contact your dealer.
- If you set the [HIGH ALTITUDE MODE] to [OFF] and use the projector at an elevation higher than 1 400 meters above the sea, the lamp service life will be shortened.

Monitor Lamp indicators

TEMP indicator

Lamp indication	Information	Check point	Remedial measure
Lighting in red	Warm-up status	<ul style="list-style-type: none"> Did you turn on the power when the ambient temperature was lower than approx. 0 °C (32 °F)? 	<ul style="list-style-type: none"> Wait about 5 minutes in the current status. Install the unit in a location having an ambient temperature from 0 °C (32 °F) - 45 °C (113 °F).
	High temperature inside. (WARNING)	<ul style="list-style-type: none"> Check the ventilation port is blocked. Is the room air temperature too high? Is the filter indicator lighted? 	<ul style="list-style-type: none"> Remove the object that is blocking the ventilation port. Move the projector to a temperature of 0 °C (32 °F) - 45 °C (113 °F) and the humidity of 20 % to 80 % (no condensation). Turn off the MAIN POWER switch using the procedure on page 33 and replace the ACF unit.
Blinking in red (once)	High temperature inside. (Power ON condition)		
Blinking in red (twice)	High temperature inside. (Standby condition)		
Blinking in red (3 times)	Cooling fan has been stopped.	—	<ul style="list-style-type: none"> Turn off the MAIN POWER switch using the procedure on page 33 and consult the dealer.

Note

- If no problem is found or the problem remains, do not turn on the projector. Instead contact your dealer.

Replacement

Before replacing the unit

- Turn off the POWER switch of the projector in proper way and disconnect the power plug from the wall outlet. (➔page 31, 33)
- Be sure to observe the procedure “Powering off the projector” (➔page 33) when performing power supply operation.

Replacing the unit

Lamp unit

The LAMP unit is consumable product. You can check the duration of usage time using [LAMP] of [STATUS] (➔page 67) in the [PROJECTOR SETUP] menu.

Replacement of the lamp unit should be carried out by a qualified technician.

Contact the dealer to purchase a replacement lamp unit (ET-LAD60A:1 bulb unit, ET-LAD60AW: 2 bulb units).

Precautions on lamp unit replacement



- Handle the lamp unit with special care as the lamp is made of glass. Dropping or giving it a shock may cause it to burst or damaged.
- Phillips screwdriver is necessary when replacing a lamp unit.
- When replacing the lamp unit, be sure to hold it by the handle.
- The lamp may burst. Replace the lamp unit carefully so that the broken pieces of the lamp glass will not scatter. When the projector is mounted on the ceiling, do not work directly under the projector or put your face closer to the projector.
- For disposition of used lamps, request an industrial waste disposal contractor.

Attention

- Do not attempt replacement with an unauthorized lamp unit.
- The part numbers of accessories and separately sold components are subject to change without notice.
- Wait for more than 1 hour and make sure the lamp unit and the surroundings are cooled enough.
- Prior to replacing the lamp unit, allow it to cool down to prevent the risk of burns, damage and other hazards.

When to replace the lamp unit

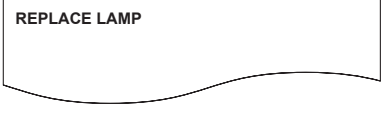
When the lamp is consumed, the brightness may decrease over time. 2 000 hours of use is the replacing time as a rough guide, and that might be shortened by the usage conditions, characteristics of the lamp unit or environmental conditions. Therefore, it is strongly recommended for the user to keep a spare lamp. If the lamp unit has not been replaced after 2 000 hours of operation have elapsed, the power will turn off automatically approximately 10 minutes after it is turned on.

	On screen	LAMP indicator
		
Over 1 800 hours	[REPLACE LAMP] is displayed on the upper left of the screen for 30 seconds. Press any button to clear the screen, or disappears after 30 seconds.	Lights in red.
Over 2 000 hours	[REPLACE LAMP] is displayed on the upper left of the screen, and it will stay until you respond. To clear the screen, press any button.	

Note

- The guide times, 2 000 hours, are rough estimates based on certain conditions and are not a guaranteed time.

Replacement

AIR FILTER

Optional air filter (service part) is available from any Panasonic dealer.

When you replace the projector lamp, replace the air filter at the same time.

The replacement lamp unit (part number ET-LAD60A, 1 bulb unit) package contains one air filter (part number ET-LAD60A), but the ET-LAD60AW lamp unit (part number ET-LAD60AW, 2 bulb units) package contains two air filters (part number ET-LAD60AW).

Procedure of Air Filter/Lamp Unit replacement

Attention

- When the projector is mounted in the ceiling, do not work directly under the projector or put your face close to the projector.
- The lamp unit and the lamp unit cover must be attached correctly and securely. Failure to do so, the projector will not be turned on for the protection circuit.
- If the lamp unit is not installed smoothly, remove it and then install it again. If it is pushed in forcibly, its connector may be broken.

- 1) Turn the main power OFF, following the procedures described in "Powering off the projector" (➔page 33), disconnect the power plug from the AC power source, and wait for one hour or more. Then check that the lamp unit has cooled down.

- 2) Loosen a "Air Filter/Lamp Unit cover fixing screw" (1 piece) using a Phillips-head screwdriver, and remove "Air Filter/Lamp Unit cover".

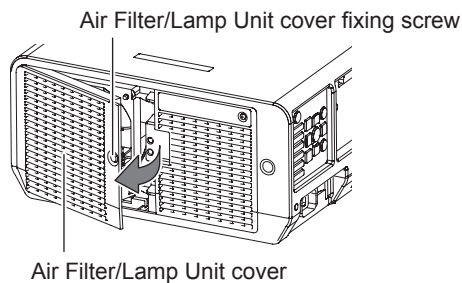

- 3) Loosen the "Exhaust fan fixing screw" (1 piece) using a Phillips-head screwdriver to make it free to rotate, and open the "Exhaust Fan" cover as shown in the figure.

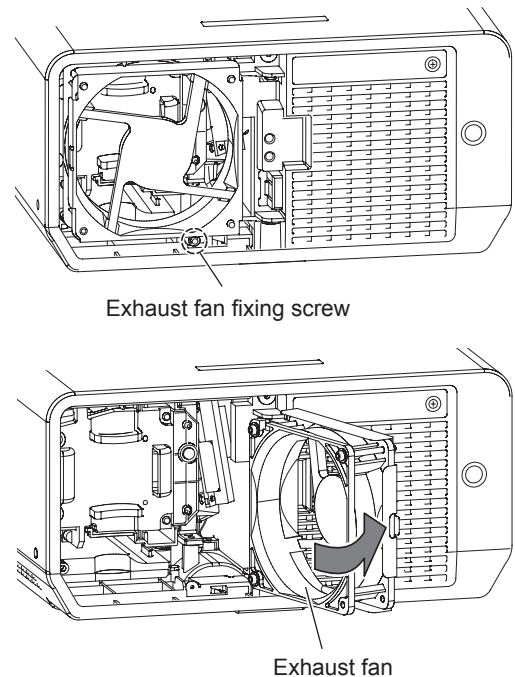

- 4) Use a Phillips screwdriver to loosen the "Lamp unit cover fixing screw" (3 screws) for the lamp unit to be replaced until the screws turn freely. Hold the "Handle" of the "Lamp unit" and gently pull the lamp unit out from the projector.

Lamp unit fixing screws

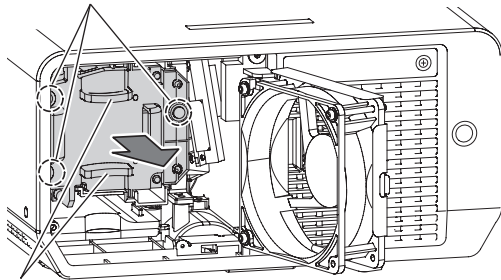

Handle

- 5) Replace the new LAMP unit in correct direction.

Groove for lamp unit installation guide

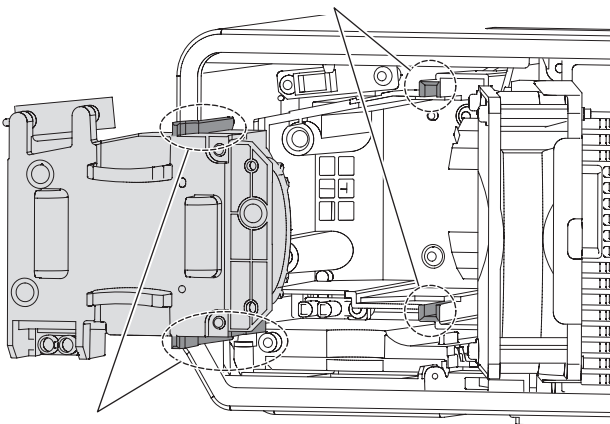

Lamp unit installation guide

- 6) Use a Phillips screwdriver to securely tighten the 2 "Lamp Unit cover fixing screw" for lamp unit.

Note

- When the lamp unit is replaced, the duration of usage time will be reset to "0".

- 7) Open the "Exhaust Fan" as illustrated, and remove the "Air Filter" from "Air filter housing".

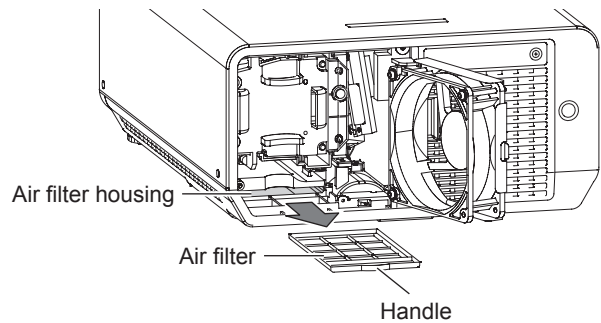

- 8) Mount a new "Air Filter" in the "Air Filter housing", and close the "Exhaust Fan".
- 9) Close the "Exhaust Fan" cover in the reverse procedure of Step (3). Then, tighten and secure the "Exhaust fan fixing screw" (1 piece) using a Phillips-head screwdriver.
- 10) Mount the "Air Filter/Lamp Unit cover", and retighten "Air Filter/Lamp Unit cover fixing screw" (1 piece) of this cover securely.

Troubleshooting

Should any problem persist, contact your dealer.

Problem	Cause	Reference page
Power does not turn on.	● The power cord may not be connected.	—
	● The <MAIN POWER> switch is turned off.	33
	● No electric supply is at the wall outlet.	—
	● The circuit breakers have tripped.	—
	● [LAMP indicator] or [TEMP indicator] is lit or flashes.	75, 76
	● The lamp unit cover has not been securely installed.	78
No picture appears.	● The video signal input source may not be connected to a terminal properly.	28
	● The input selection setting may not be correct.	36
	● The [BRIGHTNESS] adjustment setting may be at the minimum setting.	43
	● The input source which is connected to the projector may have a problem.	—
	● The [AV MUTE] function may be in use.	36
	● If the [Power indicator] flashes in red, consult your dealer.	—
The picture is fuzzy.	● The lens focus may not have been set correctly.	34
	● The projector may not be at the correct distance from the screen.	23
	● The lens may be dirty.	15
	● The projector may be tilted too much.	—
The color is pale or grayish.	● [COLOR] or [TINT] adjustment may be incorrect.	43
	● The input source which is connected to the projector may not be adjusted correctly.	—
	● RGB cable is damaged.	—
The remote control does not operate.	● The batteries may be weak.	—
	● The batteries may not have been inserted correctly.	18
	● The remote control signal receptor on the projector may be obstructed.	18
	● The remote control unit may be out of the operation range.	18
	● Strong light such as fluorescent shine onto the signal receptor.	18
	● [REMOTE CONTROLLER] of [CONTROL DEVICE SETUP] in SECURITY menu is [DISABLE].	74
	● Is the remote (REMOTE IN) terminal used for external control?	85
	● The remote control ID setting is incorrect.	21, 62
On screen menu does not appear.	● ON SCREEN button on the remote control may have been pressed and cleared.	39
The control buttons of the projector do not operate.	● [CONTROL PANEL] of [CONTROL DEVICE SETUP] in SECURITY menu is [DISABLE].	74
	● Is the remote (REMOTE IN) terminal used for external control?	85
The picture does not display correctly.	● [SYSTEM SELECTOR] may not have been set correctly.	46
	● There may be a problem with the VCR or other signal source.	—
	● A signal which is not compatible with the projector is being input.	87

Problem	Cause	Reference page
Picture from a computer does not appear.	<ul style="list-style-type: none"> • The cable may be longer than the optional cable. • The external video output from a laptop computer may not be correct. (You may be able to change the external output settings by pressing the [Fn] + [F3] or [Fn] + [F10] keys simultaneously. The actual method varies depending on the type of computer; refer to the documentation provided with your computer for further details.) 	— —
Picture from a computer DVI-D graphic board does not appear.	<ul style="list-style-type: none"> • [DVI-D IN] setting in [DISPLAY OPTION] menu may be incorrect setting. • The graphic board driver of the computer needs to be updated to the latest version. • The computer may need to be restarted after switching [DVI-D IN] setting in [DISPLAY OPTION] menu of the projector correctly. 	57 — 57
Picture from a HDMI device does not appear or picture is not stable.	<ul style="list-style-type: none"> • Is the HDMI cable securely connected? • Is the HDMI cable securely connected? Turn the power switches of the projector and attached device Off, and then turn power switches On again. • Isn't unsupported signal cable connected? 	28 — 87
No sound is output from a HDMI device.	<ul style="list-style-type: none"> • Set the sound channel of the attached device to Linear PCM. • Check the [AUDIO IN SELECT] setting of [AUDIO SETTING]. • If no audio signal is output during HDMI cable connection, connect the audio cable to any of AUDIO IN 1 to 3 terminals. 	— 66 66

Technical Information

Serial terminal

The serial connector which is on the connector panel of the projector conforms to the RS-232C interface specification, so that the projector can be controlled by a personal computer which is connected to this connector.

■ Connection

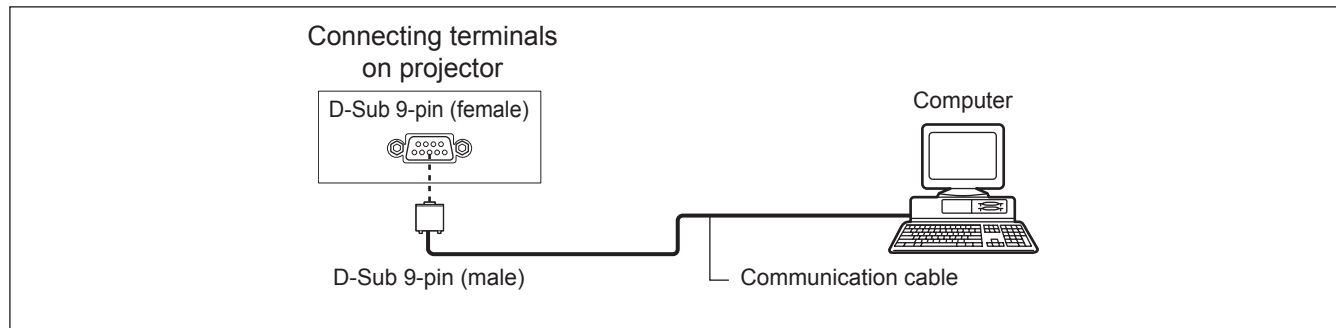

■ Pin assignments and signal names

D-Sub 9-pin (female) Outside view	Pin No.	Signal name	Contents
	①	—	NC
	②	TXD	Transmitted data
	③	RXD	Received data
	④	—	Connected internally
	⑤	GND	Earth
	⑥	—	NC
	⑦	CTS	Connected internally
	⑧	RTS	
	⑨	—	NC

■ Communication conditions (Factory setting)

Signal level	RS-232C-compliant	Character length	8 bits
Sync. method	Asynchronous	Stop bit	1 bit
Baud rate	9 600 bps	X parameter	None
Parity	None	S parameter	None

Basic format

Transmission from the computer begins with STX, then the ID, command, parameter, and ETX are sent in this order. Add parameters according to the details of control.

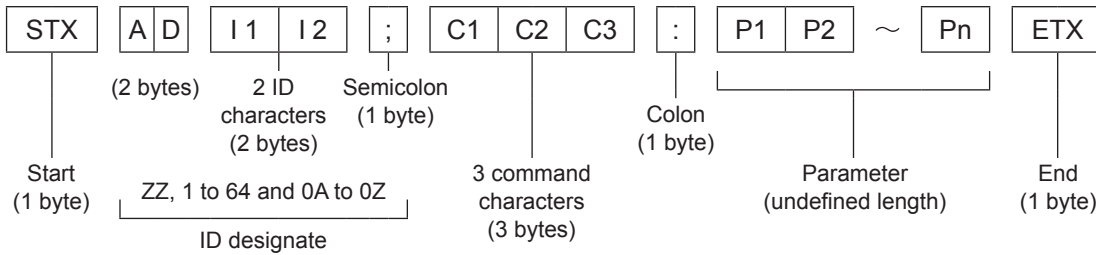

*: When sending commands without parameters, a colon (:) is not necessary.

Basic format (with sub command)

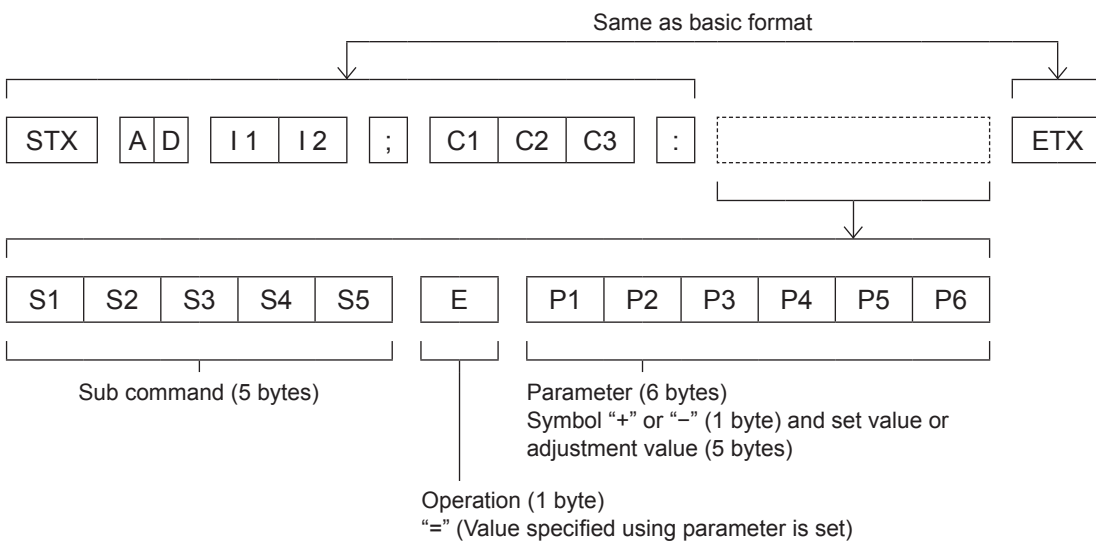

*: When transmitting a command which does not need a parameter, the operation (E) and parameter are not necessary.

Attention

- No command can be sent or received for 60 seconds after the lamp starts lighting. Try sending any command after that period has elapsed.
- When transmitting multiple commands, be sure to wait until 0.5 seconds has elapsed after receiving the response from the projector before sending the next command.

Note

- When the command can not be executed, the [ER401] status is sent from the projector to the personal computer.
- When the wrong parameter is sent, the [ER402] status is sent from the projector to the personal computer.
- Projector ID supported on the RS-232C interface is ZZ (ALL) and a group of 1 to 64 and 0A to 0Z.
- If a command is sent with a projector ID specified, the projector will return answer back only in the following cases:
If it coincides with the projector ID
If the ID specification is ALL and responding (ID ALL) is [ON]
- The "STX" character code is 02 and the "ETX" character code is 03.

Technical Information

■ Cable specifications

<When connected to a computer>

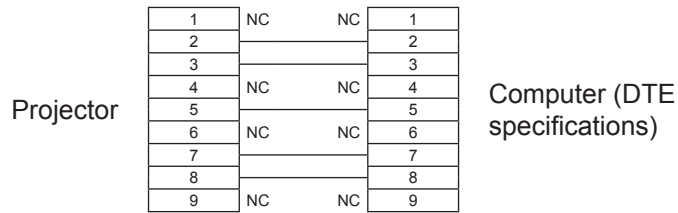

■ Control commands

When controlling the projector from a computer, the following commands are available:

<Projector control command>

Command	Control contents	Notes
PON	Power [ON]	To see if the power is [ON], use the [Power query] command.
POF	Power [OFF]	
QPW	Power query	000 = Standby 001 = Power [ON]
IIS	Switch input modes	VID = VIDEO SVD = S-VIDEO RG1 = RGB1 RG2 = RGB2 DVI = DVI-D HD1 = HDMI NWP = NETWORK
OLP	Lamp power setting	0 = NORMAL 1 = ECO
QLP	Query for lamp output setting	0 = NORMAL 1 = ECO
Q\$L	Query for lamp usage time	Response is 0000 - 2000 (Unit in hours: Number of equivalent hours for lamp output being set to [NORMAL])
OSH	Shutter	0 = End 1 = Execute
QSH	Query for shutter state	0 = End 1 = Execute
VSE	Switch aspect	0 = DEFAULT/VID AUTO/VID AUTO (PRI.) 1 = 4 : 3 2 = 16 : 9 5 = THROUGH 6 = HV FIT 9 = H FIT 10 = V FIT 20 = S1 AUTO 30 = VID AUTO
QSE	Query for aspect setting	0 = DEFAULT/VID AUTO/VID AUTO (PRI.) 1 = 4 : 3 2 = 16 : 9 5 = THROUGH 6 = HV FIT 9 = H FIT 10 = V FIT 20 = S1 AUTO 30 = VID AUTO
OPP	Side by side execution	0 = OFF 1 = ON
QPP	Query for side by side setting	0 = OFF 1 = ON
OCS	Switch sub memory	01 - 96 = Sub memory number
QSB	Query for sub memory state	01 - 96 = Sub memory number

REMOTE IN terminal

Using the [REMOTE IN] terminal provided on the connection terminals of the main unit, it is possible to operate the projector from a control panel etc. furnished in a distant location where infrared remote control signal cannot be received.

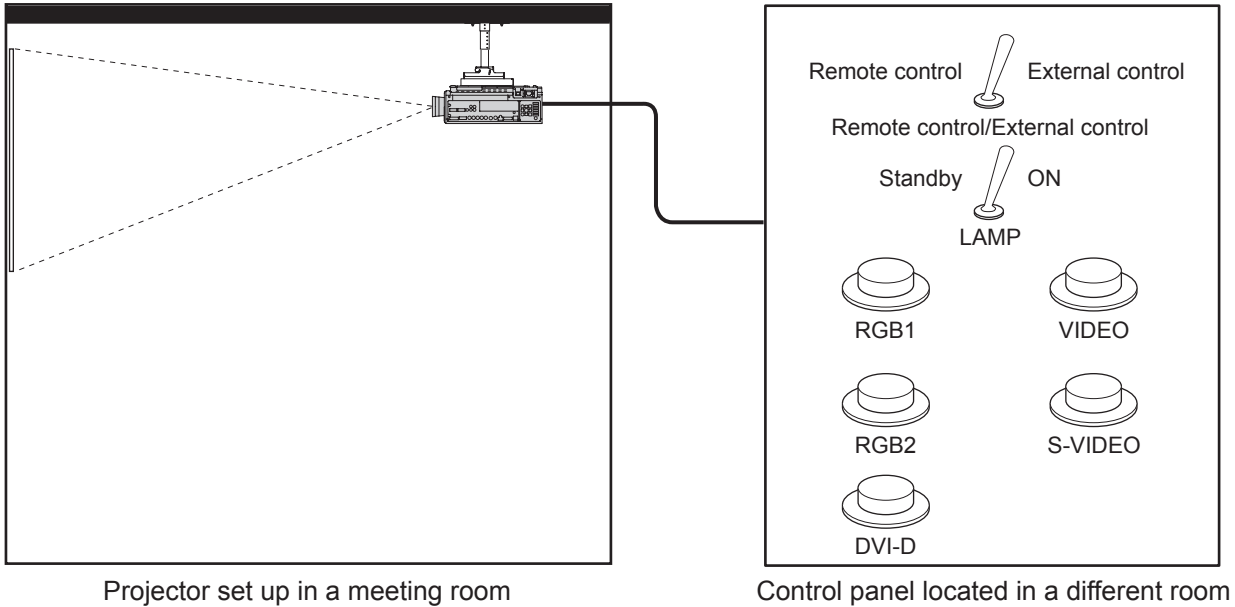

Projector set up in a meeting room

Control panel located in a different room

Pin assignments and control

D-Sub 9-pin (Outside view)	Pin No.	Signal name	Open (H)	Short (L)
	①	GND	—	GND
	②	POWER	OFF	ON
	③	RGB1	Other	RGB1
	④	RGB2	Other	RGB2
	⑤	VIDEO	Other	VIDEO
	⑥	S-VIDEO	Other	S-VIDEO
	⑦	DVI-D	Other	DVI-D
	⑧	AV MUTE	OFF	ON
	⑨	RST/SET	Controlled by remote control	Controlled by external contact

Attention

- Be sure to short-circuit Pins ① and ⑨ when controlling.
- When pin ① and pin ⑨ are short-circuited, the following buttons on the projector's control panel and on the remote control cannot be used.
 <POWER (⏻/⏿)> button, <AV MUTE> button
 In addition, the RS-232C commands and network functions that correspond to these functions cannot be used either.
- When pin ① and pin ⑨ are short-circuited and then any one of pins ③ to ⑦ is short-circuited to pin ①, the following buttons on the projector's control panel and on the remote control cannot be used.
 <POWER (⏻/⏿)> button, <INPUT SELECT> buttons (RGB1, RGB2, DVI-D, VIDEO/S-VIDEO, NETWORK, HDMI), <AV MUTE> button
 In addition, the RS-232C commands and network functions that correspond to these functions cannot be used either.
- The above is explanation in the case where "REMOTE MODE" of "PROJECTOR SETUP" (➡ page 66) is set to "STANDARD".

Technical Information

Two window display combination list (PT-DZ570U/PT-DW530U)

Subwindow		RGB1		RGB2		VIDEO input	S-VIDEO input	DVI-D		HDMI		NETWORK
		RGB input	YP _B P _R input	RGB input	YP _B P _R input			Moving image system ^{*1}	RGB system ^{*2}	Moving image system ^{*1}	RGB system ^{*2}	
Main window	RGB input			○	○	○	○	○	○	○	○	○
	YP _B P _R input			○	△	△	△	△	○	△	○	○
RGB1	RGB input											
	YP _B P _R input											
RGB2	RGB input	○	○			○	○	○	○	○	○	○
	YP _B P _R input	○	△			△	△	△	○	△	○	○
VIDEO input		○	△	○	△		×	△	○	△	○	○
S-VIDEO input		○	△	○	△		×	△	○	△	○	○
DVI-D	Moving image system ^{*1}	○	△	○	△	△	△			△	○	○
	RGB system ^{*2}	○	○	○	○	○	○			○	○	○
HDMI	Moving image system ^{*1}	○	△	○	△	△	△	△	○			×
	RGB system ^{*2}	○	○	○	○	○	○	○	○			×
NETWORK		○	○	○	○	○	○	○	○	×	×	

○ : SIDE BY SIDE combination is possible

×

△ : SIDE BY SIDE combination is possible on the following conditions.

(An image may be unstable in the sub-window under some conditions.)

1) The SIDE BY SIDE signals have the same vertical scanning frequency.

2) SIDE BY SIDE combination has signals other than the combination of Interlace signals by Interlace signals.

*1 : Only 480p, 576p, 720/60p, 720/50p, 1 080/60i, 1 080/50i, 1 080/24sF, 1 080/24p, 1 080/25p, 1 080/30p, 1 080/50p, and 1 080/60p are supported.

*2 : VGA (640 × 480) - WUXGA (1 920 × 1 200)

non-interlace signal, Dot clock frequency : 25 MHz - 162 MHz

(The WUXGA signals support only VESA CVT-RB (Reduced Blanking) signals.)

Note

- If the horizontal resolution of the input signal of the sub window is 1 280 pixels or above, the picture quality of the sub window may be lowered.

Restoring the MENU LOCK PASSWORD to default

- ① Press <AUTO SETUP> button for more than 2 seconds.
- ② Press ▼ for more than 2 seconds.

List of compatible signals

The following table specifies the types of signals compatible with the projector.

Format : V = VIDEO, S = S-VIDEO, D = DVI, H : HDMI, R : RGB, Y : YP_B

Mode	Display resolution (dots)	Scanning frequency		Dot clock frequency (MHz)	Format	PnP ^{*1}				
		H (kHz)	V (Hz)			RGB2	DVI-D EDID1	DVI-D EDID2	DVI-D EDID3	HDMI
NTSC/NTSC4.43/ PAL-M/PAL60	720 × 480i	15.7	59.9	—	V/S					
PAL/PAL-N/SECAM	720 × 576i	15.6	50.0	—	V/S					
525i (480i)	720 × 480i	15.7	59.9	13.5	R/Y					
625i (576i)	720 × 576i	15.6	50.0	13.5	R/Y					
525p (480p)	720 × 483	31.5	59.9	27.0	D/H/R/Y		○		○	○
625p (576p)	720 × 576	31.3	50.0	27.0	D/H/R/Y		○		○	○
1 125 (1 080)/60i ^{*2}	1 920 × 1 080i	33.8	60.0	74.3	D/H/R/Y		○		○	○
1 125 (1 080)/50i	1 920 × 1 080i	28.1	50.0	74.3	D/H/R/Y		○		○	○
1 125 (1 080)/24p	1 920 × 1 080	27.0	24.0	74.3	D/H/R/Y		○		○	○
1 125 (1 080)/24sF	1 920 × 1 080i	27.0	24.0	74.3	D/H/R/Y					
1 125 (1 080)/25p	1 920 × 1 080	28.1	25.0	74.3	D/H/R/Y		○		○	
1 125 (1 080)/30p	1 920 × 1 080	33.8	30.0	74.3	D/H/R/Y					
1 125 (1 080)/60p	1 920 × 1 080	67.5	60.0	148.5	D/H/R/Y		○		○	○
1 125 (1 080)/50p	1 920 × 1 080	56.3	50.0	148.5	D/H/R/Y		○		○	○
750 (720)/60p	1 280 × 720	45.0	60.0	74.3	D/H/R/Y		○		○	○
750 (720)/50p	1 280 × 720	37.5	50.0	74.3	D/H/R/Y		○		○	○
VESA400	640 × 400	31.5	70.1	25.2	D/H/R					
	640 × 400	37.9	85.1	31.5	D/H/R					
VGA480	640 × 480	31.5	59.9	25.2	D/H/R	○	○	○	○	○
	640 × 480	35.0	66.7	30.2	D/H/R					
	640 × 480	37.9	72.8	31.5	D/H/R	○		○	○	○
	640 × 480	37.5	75.0	31.5	D/H/R	○		○	○	○
	640 × 480	43.3	85.0	36.0	D/H/R					
SVGA	800 × 600	35.2	56.3	36.0	D/H/R	○		○	○	○
	800 × 600	37.9	60.3	40.0	D/H/R	○		○	○	○
	800 × 600	48.1	72.2	50.0	D/H/R	○		○	○	○
	800 × 600	46.9	75.0	49.5	D/H/R	○		○	○	○
	800 × 600	53.7	85.1	56.3	D/H/R					
MAC16	832 × 624	49.7	74.6	57.3	D/H/R	○		○	○	○
XGA	1 024 × 768	39.6	50.0	51.9	D/H/R					
	1 024 × 768	48.4	60.0	65.0	D/H/R	○		○	○	○
	1 024 × 768	56.5	70.1	75.0	D/H/R	○		○	○	○
	1 024 × 768	60.0	75.0	78.8	D/H/R	○		○	○	○
	1 024 × 768	65.5	81.6	86.0	D/H/R					
	1 024 × 768	68.7	85.0	94.5	D/H/R					
	1 024 × 768	80.0	100.0	105.0	D/H/R					
	1 024 × 768	96.7	120.0	130.0	D/H/R					
MXGA	1 152 × 864	53.7	60.0	81.6	D/H/R					
	1 152 × 864	64.0	71.2	94.2	D/H/R					
	1 152 × 864	67.5	74.9	108.0	D/H/R					
	1 152 × 864	76.7	85.0	121.5	D/H/R					
MAC21	1 152 × 870	68.7	75.1	100.0	D/H/R	○		○	○	○
1 280 × 720	1 280 × 720	37.1	49.8	60.5	D/H/R					
	1 280 × 720	44.8	59.9	74.5	D/H/R					
1 280 × 768	1 280 × 768	39.6	49.9	65.3	D/H/R					
	1 280 × 768	47.8	59.9	79.5	D/H/R					
	1 280 × 768 ^{*3}	47.4	60.0	68.3	D/H/R					
	1 280 × 768	60.3	74.9	102.3	D/H/R					
	1 280 × 768	68.6	84.8	117.5	D/H/R					

Technical Information

Mode	Display resolution (dots)	Scanning frequency		Dot clock frequency (MHz)	Format	PnP *1				
		H (kHz)	V (Hz)			RGB2	DVI-D EDID1	DVI-D EDID2	DVI-D EDID3	HDMI
1 280 × 800	1 280×800	41.3	50.0	68.0	D/H/R					
	1 280×800	49.7	59.8	83.5	D/H/R	○ *4		○ *4	○ *4	○ *4
	1 280×800 *3	49.3	59.9	71.0	D/H/R					
	1 280×800	62.8	74.9	106.5	D/H/R					
	1 280×800	71.6	84.9	122.5	D/H/R					
MSXGA	1 280×960	60.0	60.0	108.0	D/H/R					
SXGA	1 280×1 024	52.4	50.0	88.0	D/H/R					
	1 280×1 024	64.0	60.0	108.0	D/H/R	○		○	○	○
	1 280×1 024	72.3	66.3	125.0	D/H/R					
	1 280×1 024	78.2	72.0	135.1	D/H/R					
	1 280×1 024	80.0	75.0	135.0	D/H/R	○		○	○	○
	1 280×1 024	91.1	85.0	157.5	D/H/R					
1 366 × 768	1 366×768	47.7	59.8	84.8	D/H/R					
	1 366×768	39.6	49.9	69.0	D/H/R					
SXGA+	1 400×1 050	54.1	50.0	99.9	D/H/R					
	1 400×1 050	64.0	60.0	108.0	D/H/R					
	1 400×1 050	65.2	60.0	122.6	D/H/R	○		○	○	○
	1 400×1 050	65.3	60.0	121.8	D/H/R					
	1 400×1 050	78.8	72.0	149.3	D/H/R					
	1 400×1 050	82.2	75.0	155.9	D/H/R					
WXGA+	1 440×900	55.9	59.9	106.5	D/H/R					
	1 440×900	46.3	49.9	86.8	D/H/R					
UXGA60	1 600×1 200	75.0	60.0	162.0	D/H/R	○		○	○	○
WSXGA+	1 680×1 050	65.3	60.0	146.3	D/H/R					
	1 680×1 050	54.1	50.0	119.5	D/H/R					
1 920 × 1 080	1 920×1 080	55.6	49.9	141.5	D/H/R					
	1 920×1 080 *3	66.6	59.9	138.5	D/H/R					
	1 920×1 080 *5	67.2	60.0	173.0	R					
WUXGA	1 920×1 200	61.8	49.9	158.3	D/H/R					
	1 920×1 200 *3	74.0	60.0	154.0	D/H/R	○		○	○ *5	○ *5
	1 920×1 200 *5	74.6	59.9	193.3	R					

*1 : Where marked “○” signals indicates in Plug and Play is compatible with EDID of projector. Unmarked signals in Plug and Play may also be compliant if input terminals are written in the format list. Where Plug and Play is unmarked and nothing is written in the format list, difficulties in projecting image may occur even when computer and projector appear to have same resolution.

*2 : If a signal of 1 125 (1 035)/60i is input, it will be displayed as a signal of 1 125 (1 080)/60i.

*3 : VESA CVT-RB (Reduced Blanking) compatible.

*4 : PT-DW530U only

*5 : PT-DZ570U only

*6 : Some loss of data occurs to make projection easier.

Note

- The number of display dots of the PT-DZ570U is 1 920 × 1 200, and the number of display dots of the PT-DW530U is 1 280 × 800, and the number of display dots of the PT-DX500U is 1 024 × 768.
A signal of a different resolution than the above data is converted to the number of display dots and then displayed.
- The “i” appearing after the resolution indicates an interlaced signal.
- Flicker (line flicker) may be caused in images if interlace is connected.

Specifications

Model No.		PT-DZ570U	PT-DW530U	PT-DX500U	
Power supply		AC100 V - 240 V 50 Hz/60 Hz			
Power consumption		415 W			
		When [STANDBY MODE] is [ECO] : Approx. 0.3 W (100 V - 120 V), 0.4 W (220 V - 240 V) When [STANDBY MODE] is [NORMAL] : Approx. 15 W			
Amps		5.0 A - 1.9 A			
DLP chip	Panel size	17.0 mm (0.67 inch) (aspect ratio 16 : 10)	16.5 mm (0.65 inch) (aspect ratio 16 : 10)	17.8 mm (0.7 inch) (aspect ratio 4 : 3)	
	Display system	Three-unit DLP chip, DLP type			
	Number of pixels	2 304 000 pixels (1 920 × 1 200 dots)	1 024 000 pixels (1 280 × 800 dots)	786 432 pixels (1 024 × 768 dots)	
Lens		Manual zoom (2x)/Manual focus F 2.0 - 3.4, f 21.5 mm - 43.0 mm			
Projection lamp		300 W (Up to 310 W) UHM lamp			
Optical output *1		4 000 lm (ANSI)		4 500 lm (ANSI)	
Applicable scanning frequency	For RGB signal	H : 15 kHz - 100 kHz, V : 24 Hz - 120 Hz PIAS (Panasonic Intelligent Auto Scanning) system			
		Dot clock frequency Less than 162 MHz			
	For YP _B P _R signal	[480i]	H: 15.75 kHz, V: 60 Hz	[576i]	H: 15.63 kHz, V: 50 Hz
		[480p]	H: 31.5 kHz, V: 60 Hz	[576p]	H: 31.25 kHz, V: 50 Hz
		[720/50p]	H: 37.5 kHz, V: 50 Hz	[720/60p]	H: 45 kHz, V: 60 Hz
[1 035/60i]		H: 33.75 kHz, V: 60 Hz	[1 080/50i]	H: 28.13 kHz, V: 50 Hz	
[1 080/60i]	H: 33.75 kHz, V: 60 Hz	[1 080/24p]	H: 27 kHz, V: 24 Hz		
[1 080/25p]	H: 28.13 kHz, V: 25 Hz	[1 080/24sF]	H: 27 kHz, V: 48 Hz		
[1 080/30p]	H: 33.75 kHz, V: 30 Hz	[1 080/60p]	H: 67.5 kHz, V: 60 Hz		
[1 080/50p]	H: 56.25 kHz, V: 50 Hz				
● HD/SYNC, VD terminals are not compliant with 3 value composite SYNC.					
	For video signal (S-video included)	H : 15.75 kHz/15.63 kHz, V : 50 Hz/60 Hz			
	For DVI-D/HDMI signal	480p, 576p, 720/60p, 720/50p, 1 080/60p, 1 080/50p, 1 080/60i, 1 080/50i, 1 080/24sF, 1 080/30p, 1 080/25p, 1 080/24p ● Displayable resolution : VGA - WUXGA (non-interlace) ● Dot clock frequency : 25 MHz - 162 MHz			
Color system		7 standards (NTSC/NTSC4.43/PAL/PAL-N/PAL-M/SECAM/PAL60)			
Screen size		40 inch - 300 inch *3			
Screen aspect ratio		16 : 10		4 : 3	
Projection scheme		Menu-selectable from front/rear/ceiling mount, and floor mounting			
Contrast ratio		2 000 : 1			
Terminals	RGB1 IN	1 set, BNC × 5 [RGB signal] 0.7 V [p-p] 75 Ω (G-SYNC : 1.0 [p-p] 75 Ω) HD/SYNC TTL high impedance, automatic positive/negative polarity compatible VD TTL high impedance, automatic positive/negative polarity compatible [YP _B P _R signal] Y : 1.0 V [p-p] Synchronization signal included, P _B P _R : 0.7 V [p-p] 75 Ω			
	RGB2 IN	1 set of high density, D-sub 15-pin (female) [RGB signal] 0.7 V [p-p] 75 Ω (G-SYNC : 1.0 [p-p] 75 Ω) HD/SYNC TTL high impedance, automatic positive/negative polarity compatible VD TTL high impedance, automatic positive/negative polarity compatible [YP _B P _R signal] Y : 1.0 V [p-p] Synchronization signal included, P _B P _R : 0.7 V [p-p] 75 Ω			

Specifications

Model No.		PT-DZ570U	PT-DW530U	PT-DX500U
Terminals	VIDEO IN	1 set, BNC, 1.0 V [p-p] 75 Ω		
	S-VIDEO IN	1 set, Mini DIN 4-pin, Y: 1.0 V [p-p], C: 0.286 V [p-p] 75 Ω, compatible with S1 signal		
	DVI-D IN	1 set, DVI-D 24-pin (Single link), DVI 1.0 compatible, HDCP compatible		
	HDMI IN	1 set, HDMI 19-pin (HDCP/Deep color compatible)		
	SERIAL IN	1 set, D-sub 9-pin, RS-232C compatible, computer control use		
	REMOTE IN	1 set, D-sub 9-pin, external control use		
	LAN	1 set, RJ-45, network connection use, PLink compatible, 10 Base-T/100Base-TX		
	AUDIO IN1	Single - line, 0.5V [rms], RCA pin jack x 2 (L - R)		
	AUDIO IN2	Dual - line, 0.5V [rms], M3 jack (Stereo MINI)		
	AUDIO IN3	Dual - line, 0.5V [rms], M3 jack (Stereo MINI)		
	VARIABLE AUDIO OUT	Single - line, 0.5V [rms], M3 jack (Stereo MINI) Monitor output/stereo compatible 0 V [rms] - 2.0 V [rms] (variable)		
	Wireless module connection terminal	Dedicate to single-line wireless module (optional ET-WM200U)		
Power cord length		3.0 m (9.1')		
Cabinet		Moulded plastic		
Dimensions		Width : 332 mm (13 1/16"), Length : 425 mm (16 23/32"), Height : 168 mm (6 5/8") (not including surface projection parts)		
Weight		Approx. 8.5 kg (18.7 lb) *4		
Operating environment		Temperature *5 : 0 °C to 45 °C Humidity : 20 % to 80 % (no condensation)		
Remote control	Power supply	DC 3 V (AA/R6/LR6 battery × 2)		
	Operating range	Approx. 15 m (49'2") (when operated directly in front of signal receptor)		
	Weight	117 g (4.2 ozs.) (including batteries)		
	Dimensions	Width : 48 mm (1 7/8"), Length : 163 mm (6 13/32"), Height : 24.5 mm (15/16")		

*1 : Measurement, measuring conditions and method of notation all comply with ISO21118 international standards.

*2 : For details of video signals that can be projected using this projector, refer to "List of compatible signals" (➡ page 87).

*3 : This is the average value. It may differ depending on each product.

*4 : When using this projector at high elevations 1 400 - 2 700 m (4 593 - 8 858 ft) sea level, temperature will be 5 °C lower than this higher limit.

- The part numbers of accessories and separately sold components are subject to change without notice.

Specifications

Dimensions

<Unit : mm>

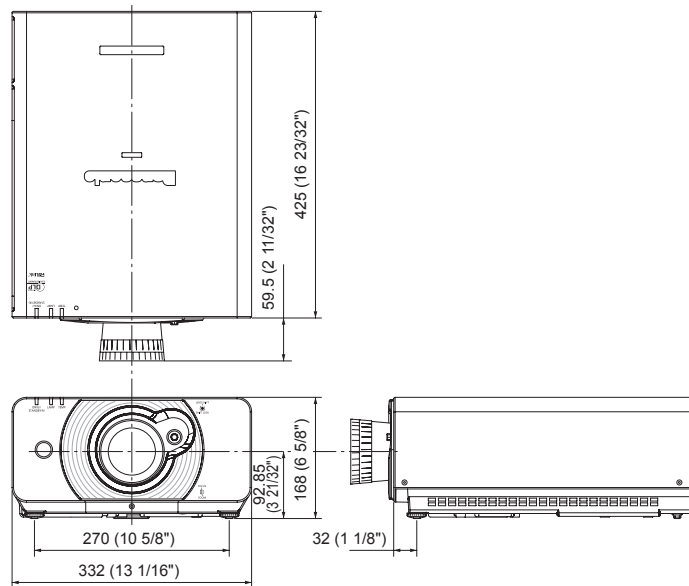

About brand

Trademark Acknowledgement

- Microsoft® and its logos, Windows®, Windows® XP, Windows Vista®, Windows® 7, and Internet Explorer® are the registered trademarks or trademarks of Microsoft Corporation in the United States and/or other countries.
- Macintosh, Mac OS and Safari are the trademarks of Apple Inc. registered in the United States and other countries.
- PJLink™ is a pending trademark in Japan, the United States, and other countries and regions.
- HDMI, the HDMI logo and High-Definition Multimedia Interface are the trademarks or registered trademarks of HDMI Licensing LLC.
- Other types of names such as company names and product names appearing in this instruction manual are trademarks or registered trademarks of their respective holders.
The ® and TM marks are not indicated in this instruction manual.

Ceiling mount bracket safeguards

When installing the ceiling mount bracket to the projector, install the accessory Drop-prevention bracket (Safety cables) to the projector.

(The projector will still be safe if they are not used, however they will help prevent the possibility of accidents caused by the projector falling down if the screws happen to become loose.)

Ceiling bracket : For high ceiling : ET-PKD110H, For low ceiling : ET-PKD110S,

Installation work of the ceiling mount bracket should only be carried by a qualified technician according to the following procedure.

- Panasonic takes no responsibility for any losses or damage occurring as a result of using a ceiling mount bracket not manufactured by Panasonic, or if damage to the projector occurs as a result of an inappropriate location used for installing the ceiling mount bracket, even if the projector's warranty period has not yet expired.
- Use a torque screwdriver or similar tool to tighten the screws. Do not use tools such as electric screwdrivers or impact screwdrivers.
- An unused ceiling mount bracket should be removed promptly by qualified technician.
- Do not use the screw holes of the front leg adjusters for the projector installation.
- Do not attach the safety cable to the burglar hook port and suspend the projector on it.
- For how to install wire ropes to the ceiling, see the installation manual for the ceiling mount bracket.
- For details, see the installation manual for the ceiling mount bracket.
- The part numbers of accessories and separately sold components are subject to change without notice.

Attachment procedure

- 1) Turn the projector upside down and place it gently on a soft cloth.
- 2) Put the plain washer on the wire rope fixing screw.
- 3) Put the wire rope through the wire rope fixing screw.
- 4) Install the wire rope fixing screws to the projector and tighten them.
 - Install the wire ropes to the 2 places in a similar manner.

Wire rope fixing screw: M4 x L12.

Tightening torque of fixing screw: 1.25 ± 0.2 Nm

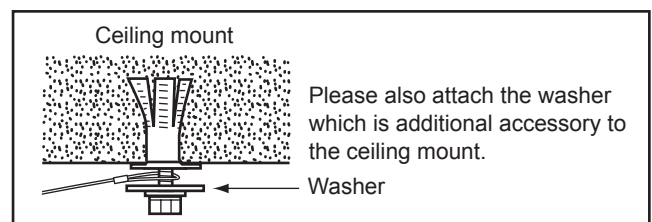
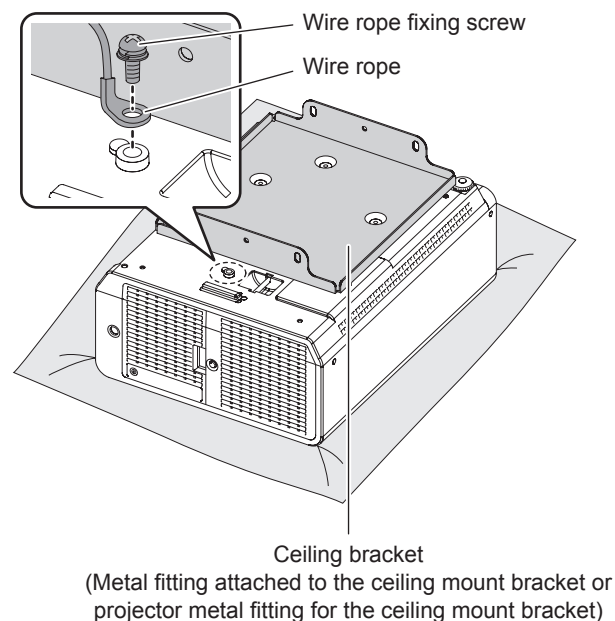

Attention

- Do not use other than the provided Wire rope fixing screw, washer and Safety cable.
- Install the wire ropes so that they do not sag between the installation portions on the body and those on the ceiling.

Cautions on Wireless LAN Module Installation

The optional Wireless LAN Module (part number ET-WM200U) is required to use wireless LAN functions.
During installation, remove the cap from the Wireless LAN Module and mount the module in the projector.

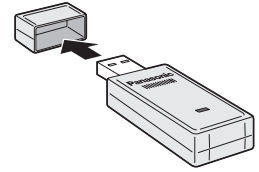

Procedure

- 1) Remove the setscrew of the Wireless LAN Module cover, and remove this cover from the projector.
- 2) Face the LED lamp of the Wireless LAN Module upward, and insert the module into the slot.
- 3) Close the Wireless LAN Module cover, and secure it by tightening the Wireless LAN Module cover fixing screw.

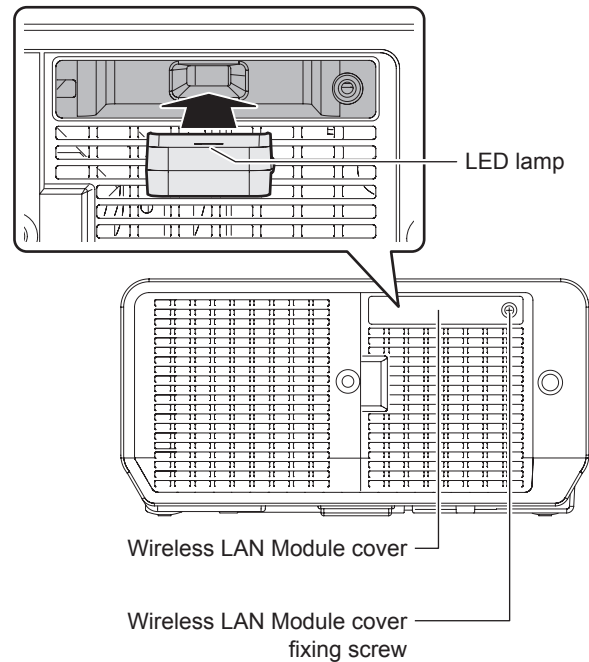

Note

- Keep the small parts out of the reach of small children.
- Tighten screws using a torque screwdriver or others. Do not use an electric screwdriver or an impact screwdriver.
- The serial number of accessories and optional parts is subject to change without notice.

Index

A		DVI-D IN	57	Remote control	18
About brand	91	E		REMOTE IN terminal	85
About Your Projector	18	ECO MANAGEMENT	63	REMOTE MODE	66
Accessories	16	F		Renaming a registered data	71
Adjustment range after lens position (optical shift)	35	FRAME RESPONSE	51	Replacement	77
ADVANCED MENU	50	FREEZE	60	Replacing the unit.....	77
AI	45	Front leg adjusters and throwing angle	27	Restoring the MENU LOCK PASSWORD to default	86
ASPECT	47	FUNCTION BUTTON	66	RGB IN (Only RGB input).....	57
Attachment procedure	92	H		RS-232C.....	65
AUDIO SETTING.....	66	HDMI IN.....	57	S	
Automatic adjustment.....	37	HIGH ALTITUDE MODE.....	63	SAVE ALL USER DATA	68
AUTO SETUP.....	56	How to adjust the focus, zoom and shift	34	SCHEDULE	64
AUTO SIGNAL.....	55	I		SCREEN SETTING	54
B		Important Safety Notice	2	Screen size and throw distance.....	23
BACK COLOR.....	59	Index.....	94	Security.....	14
Basic operations using the remote control	36	INITIALIZE	69	SECURITY menu	72
Before connection to the projector..	28	INPUT RESOLUTION	51	SECURITY PASSWORD.....	72
Before replacing the unit.....	77	INSTALLATION	62	SECURITY PASSWORD CHANGE ..	72
BLANKING	50	K		Selecting the input signal.....	34
BRIGHTNESS	43	KEYSTONE	49	Serial terminal.....	82
C		L		SERVICE PASSWORD	69
Capturing an image	36	LAMP POWER	63	Setting projector ID number to remote control.....	21
CAUTION	11	List of compatible signals	87	Setting up	22
Cautions on use.....	14	LOAD ALL USER DATA.....	68	SHARPNESS	45
Cautions on Wireless LAN Module Installation.....	93	M		SHIFT	47
Cautions when installing.....	12	MAIN MENU	40	SIDE BY SIDE (PT-DZ570U and PT-DW530U only).....	60
Cautions when transporting.....	11	Making adjustment and selection ..	32	SIGNAL LIST menu	71
Ceiling mount bracket safeguards ..	92	Managing the indicated problems...75		Specifications	89
Changing the display language	52	Managing the sub memory list.....59		Start-up display.....	17
CLAMP POSITION	51	MENU LOCK	73	STARTUP LOGO	59
Cleaning and maintenance.....	15	MENU LOCK PASSWORD	73	STATUS	67
CLOCK PHASE.....	49	Menu Navigation.....	39	SUB MENU.....	40
CLOSED CAPTION SETTING (for NTSC, 525i (480i) input only) ..	58	Monitor Lamp indicators	75	Switching the input signal	36
COLOR.....	43	N		SYSTEM SELECTOR	46
COLOR CORRECTION.....	54	Navigating through the menu	39	T	
COLOR MATCHING.....	53	NOISE REDUCTION	45	Technical Information.....	82
COLOR TEMPERATURE	43	O		TEST PATTERN	70
Connecting example :		ON-SCREEN DISPLAY	58	TEST PATTERN menu	70
AV equipment	29	P		TEXT CHANGE	73
Computers	30	PICTURE menu.....	42	TINT.....	43
Connecting the power cord.....	31	PICTURE MODE	42	To display pictures complying with the sRGB standard	46
Connections.....	28	POSITION menu	47	Troubleshooting	80
CONTRAST.....	42	Powering off the projector.....	33	Two window display combination list (PT-DZ570U/PT-DW530U)	86
CONTROL DEVICE SETUP.....	74	Powering ON/OFF	31	U	
Controlling the volume of the speaker ..	38	Powering up the projector.....	32	Using ECO button.....	37
COOLING CONDITION.....	62	Precautions with regard to safety	8	Using the AV MUTE function	36
D		Procedure	93	Using the function buttons	37
DATE AND TIME	67	Projecting.....	34	W	
DAYLIGHT VIEW.....	45	Projection method.....	22	WARNING	8
Deleting a registered data	71	PROJECTOR ID	62	WAVEFORM MONITOR (PT-DZ570U only).....	55
DIGITAL CINEMA REALITY	50	PROJECTOR SETUP menu	62	WHITE GAIN	44
Dimensions.....	91	R		Z	
Direct power off function.....	33	RASTER POSITION.....	51	ZOOM.....	48
DISPLAY LANGUAGE menu.....	52	Registering a signal to the list.....	71		
DISPLAY OPTION menu.....	53				
DISPLAY SETTING	73				
Disposal.....	15				

NOTE:

This product contains a CR Coin Cell Lithium Battery which contains Perchlorate Material - special handling may apply.

See www.dtsc.ca.gov/hazardouswaste/perchlorate.

Panasonic Corporation

Web Site : <http://panasonic.net/avc/projector/>

© Panasonic Corporation 2010

Panasonic Solutions Company

3 Panasonic Way, Secaucus, NJ 07094

TEL: (877) 803 - 8492

Panasonic Canada Inc.

5770 Ambler Drive, Mississauga, Ontario L4W 2T3

TEL: (905) 624 - 5010