

Panasonic®

Operating Instructions

DLP™ Based Projector **Commercial Use**

Model No. **PT-D3500U**

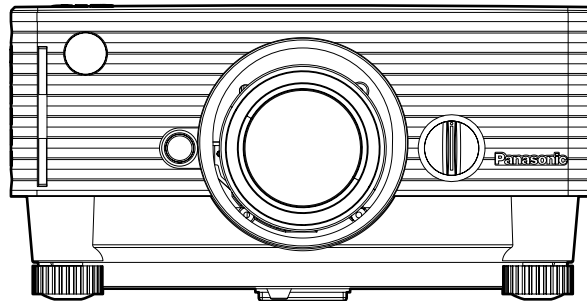
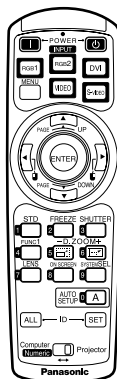

Read these instructions completely before operating this unit.

Dear Panasonic Customer:

This instruction booklet provides all the necessary operating information that you might require. We hope it will help you to get the most performance out of your new product, and that you will be pleased with your Panasonic DLP™ based projector.

The serial number of your product may be found on its back. You should note it in the space provided below and retain this booklet in case service is required.

Model number: **PT-D3500U**

Serial number:

IMPORTANT SAFETY NOTICE

WARNING: TO REDUCE THE RISK OF FIRE OR ELECTRIC SHOCK, DO NOT EXPOSE THIS PRODUCT TO RAIN OR MOISTURE.

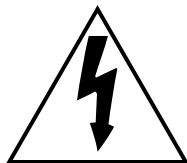

The lightning flash with arrowhead symbol, within an equilateral triangle, is intended to alert the user to the presence of uninsulated “dangerous voltage” within the Product’s enclosure that may be of sufficient magnitude to constitute a risk of electric shock to persons.



The exclamation point within an equilateral triangle is intended to alert the user to the presence of important operating and maintenance (servicing) instructions in the literature accompanying the product.

CAUTION: This equipment is equipped with a three-pin grounding-type power plug. Do not remove the grounding pin on the power plug. This plug will only fit a grounding-type power outlet. This is a safety feature. If you are unable to insert the plug into the outlet, contact an electrician. Do not defeat the purpose of the grounding plug.

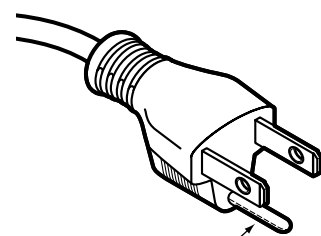

Do not remove

WARNING: This equipment has been tested and found to comply with the limits for a Class B digital device, pursuant to part 15 of the FCC Rules. These limits are designed to provide reasonable protection against harmful interference in a residential installation. This equipment generates, uses and can radiate radio frequency energy and, if not installed and used in accordance with the instructions, may cause harmful interference to radio communications. However, there is no guarantee that interference will not occur in a particular installation. If this equipment does cause harmful interference to radio or television reception, which can be determined by turning the equipment off and on, the user is encouraged to try to correct the interference by one or more of the following measures:

- Reorient or relocate the receiving antenna.
- Increase the separation between the equipment and receiver.
- Connect the equipment into an outlet on a circuit different from that to which the receiver is connected.
- Consult the dealer or an experienced radio/TV technician for help.

FCC CAUTION: To assure continued compliance, use only shielded interface cables when connecting to computer or peripheral devices. Any unauthorized changes or modifications to this equipment could void the user's authority to operate.

WARNING:

Not for use in a computer room as defined in the Standard for the Protection of Electronic Computer/Data Processing Equipment, ANSI/NFPA 75.

Declaration of Conformity

Model Number: PT-D3500U
Trade Name: Panasonic
Responsible Party: Matsushita Electric Corporation of America
One Panasonic Way, Secaucus, NJ 07094
Telephone Number: 1-800-524-1448 or 1-800-526-6610
Email: pbtsservice@panasonic.com

This device complies with Part 15 of the FCC Rules. Operation is subject to the following two conditions: (1) This device may not cause harmful interference, and (2) this device must accept any interference receiver, including interference that may cause undesired operation.

NOTICE: This product has a High Intensity Discharge (HID) lamp that contains a small amount of mercury. It also contains lead in some components. Disposal of these materials may be regulated in your community due to environmental considerations. For disposal or recycling information please contact your local authorities, or the Electronics Industries Alliance: <<http://www.eiae.org>.>

Contents

IMPORTANT SAFETY NOTICE	2	Adjusting the audio	33
Precautions with regard to safety	5	VOLUME	33
Caution	6	AUDIO MUTE	33
Accessories	7	Changing the display language	33
Precautions on handling	8	OPTION1 settings	34
Name and function of parts	9	COLOR CORRECTION	34
Remote control	9	CONTRAST MODE	34
Front and side of the projector	11	AUTO SIGNAL	34
Rear and side view of the main unit/Controls on upper panel	12	BACK COLOR	34
Side-mounted connection terminals	13	SUB MEMORY LIST	34
Using the remote control unit	14	DVI EDID	34
Loading dry cells	14	OPTION2 settings	35
Effective range of remote control operation	14	ID	35
Setting projector ID number to remote control	15	FRONT/REAR	35
Using the remote control as a PC mouse	15	DESK/CEILING	35
Using a wired remote control	16	LAMP POWER	35
Installation	17	RS232C	35
Projection schemes	17	SYSTEM INFORMATION	35
Installation geometry	17	FAN CONTROL1	35
Projection distances	17	FAN CONTROL2	36
Connection	18	FUNC1	36
Setup precautions	18	◆KEY ASSIGN	36
Example of connecting with AV products	19	AUTO POW.OFF	36
Example of connecting with PCs	20	PASSWORD	36
How to install and remove the projection lens (optional)	21	Displaying the internal test pattern	37
How to install the projection lens	21	Cycle of displayed internal test patterns	37
How to remove the projection lens	21	Setting the security	37
Projection	22	INPUT PASSWORD	37
Powering up the projector	22	AMEND PASSWORD	37
Making adjustment and selection	22	TEXT DISPLAY	37
Powering off the projector	23	TEXT CHANGE	37
Direct power off function	23	Setting the network	38
How to adjust the lens	24	Connecting the PC	38
How to adjust the lens focus, lens zoom and lens up/down position movement (optical shift)	24	System requirements	38
How to adjust the lens position to the left or right	24	Connection example	38
Automatic adjustment (AUTO SETUP)	25	Using the serial terminals	39
Using the FREEZE function	25	Examples of connection	39
Using the SHUTTER function	25	Pin assignments and signal names	39
Using the digital zoom (- D.ZOOM +) function	26	Communication conditions (Factory setting)	39
On-screen menus	27	Basic format	39
Structure of menu screens	27	Control commands	40
Basic menu operations	28	Cable specifications	40
Returning to the previous page	28	Using the Remote 2 terminal	41
Menu items shown in transparent characters	28	Indication of lamp monitor	42
Menu items setting	28	Cleaning and replacement of air filter	43
Resetting to the factory default	28	Procedure of cleaning	43
Adjusting the picture	29	Replacing of lamp unit	44
PICTURE MODE	29	Timing of lamp unit replacement	44
BRIGHT	29	Lamp unit replacement steps	45
CONTRAST	29	Using Web Browser Control	47
COLOR	29	Accessing from the Web browser	47
TINT	29	Password change page	47
COLOR TEMP.	29	Basic control page	48
WHITE GAIN	29	Detail control page	49
SHARPNESS	30	Monitor information page	49
NR	30	Error information page	50
AI	30	E-mail setup page	51
TV-SYSTEM	30	DNS server setup page	52
SYSTEM	30	POP server setup page	53
Adjusting the position	31	Ping test page	53
POSITION	31	Contents of mail sent	54
ASPECT	31	Adjust clock page	54
ZOOM	31	Network config page	55
CLOCK PHASE	31	Network status page	55
KEystone	31	Using the PJLink™ protocol	56
How to use ADVANCED MENU	32	Supported commands	56
DIGITAL CINEMA REALITY	32	PJLink™ security authentication	56
BLANKING	32	Before asking for service	57
INPUT RESOLUTION	32	Specifications	58
CLAMP POS.	32	Compatible Signal List	60
RASTER POSITION	32	Projection distances by projection lens	61
SXGA MODE	32	Dimensions	62
		Français Information	64

Precautions with regard to safety

WARNING

If a problem occurs (such as no image) or if you notice smoke or a strange smell coming from the projector, turn off the power and disconnect the power cord from the wall outlet.

- Do not continue to use the projector in such cases, otherwise fire or electric shocks could result.
- Check that no more smoke is coming out, and then contact an Authorized Service Center for repairs.
- Do not attempt to repair the projector yourself, as this can be dangerous.

Do not install this projector in a place which is not strong enough to take the full weight of the projector.

- If the installation location is not strong enough, it may fall down or tip over, and severe injury or damage could result.
- Installation work (such as ceiling suspension) should only be carried out by a qualified technician.
- If installation is not carried out correctly, there is the danger that injury or electric shocks may occur.

If foreign objects or water get inside the projector, or if the projector is dropped or the cabinet is broken, turn off the power and disconnect the power cord from the wall outlet.

- Continued use of the projector in this condition may result in fire or electric shocks.
- Contact an Authorized Service Center for repairs.

Do not cover the air filter, the air inlet and exhaust vents.

- Doing so may cause the projector to overheat, which can cause fire or damage to the projector.

Do not overload the wall outlet.

- If the power supply is overloaded (for example, by using too many adapters), overheating may occur and fire may result.

Do not remove the cover or modify it in any way.

- High voltages which can cause fire or electric shocks are present inside the projector.
- For any inspection, adjustment and repair work, please contact an Authorized Service Center.

Use only the power cord supplied with the projector.

- Use only the supplied cord with three-pin plug and insert it only into a wall outlet that is connected to earth. Otherwise, electric shock could result.

Clean the power cord plug regularly to prevent it from becoming covered in dust.

- If dust builds up on the power cord plug, the resulting humidity can damage the insulation, which could result in fire. Pull the power cord out from the wall outlet and wipe it with a dry cloth.
- If not using the projector for an extended period of time, pull the power cord plug out from the wall outlet.

Do not do anything that might damage the power cord or the power cord plug.

- Do not damage the power cord, make any modifications to it, place it near any hot objects, bend it excessively, twist it, pull it, place heavy objects on top of it or wrap it into a bundle.
- If the power cord is used while damaged, electric shocks, short-circuits or fire may result.
- Ask an Authorized Service Center to carry out any repairs to the power cord that might be necessary.

Do not handle the power cord plug with wet hands.

- Failure to observe this may result in electric shocks.

Insert the power cord plug securely into the wall outlet.

- If the plug is not inserted correctly, electric shocks or overheating could result.
- Do not use plugs which are damaged or wall outlets which are coming loose from the wall.

Do not place the projector on top of surfaces which are unstable.

- If the projector is placed on top of a surface which is sloped or unstable, it may fall down or tip over, and injury or damage could result.

Do not place the projector into water or let it become wet.

- Failure to observe this may result in fire or electric shocks.

Precautions with regard to safety

Do not disassemble the lamp unit.

- If the lamp section breaks, it may cause injury.

Do not place liquid containers on top of the projector.

- If water spills onto the projector or gets inside it, fire or electric shocks could result.
- If any water gets inside the projector, contact an Authorized Service Center.

Do not insert any foreign objects into the projector.

- Do not insert any metal objects or flammable objects into the projector or drop them onto the projector, as doing so can result in fire or electric shocks.

After removing the battery from remote control unit, keep it away from the reach of children.

- The battery can cause death by suffocation if swallowed.
- If the battery is swallowed, seek medical advice immediately.

Do not allow the + and - terminals of the battery to come into contact with metallic objects such as necklaces or hairpins.

- Failure to observe this may cause the battery to leak, overheat, explode or catch fire.
- Store the battery in a plastic bag and keep it away from metallic objects.

Replacement of the lamp unit should only be carried out by a qualified technician.

- The lamp unit has high internal pressure. If improperly handled, explosion might result.
- The lamp unit can easily become damaged if struck against hard objects or dropped, and injury or malfunctions may result.

When replacing the lamp, allow it to cool for at least one hour before handling it.

Do not bring your hands or other objects close to the air outlet port.

- Heated air comes out of the air outlet port. Do not bring your hands or face, or objects which cannot withstand heat.

Do not suspend the projector using only the hole used for the anti-theft clasp.

- The projector may fall or sustain damage, and possibly result in injury.

Caution

Do not set up the projector in humid or dusty places or in places where the projector may come into contact with smoke or steam.

- Using the projector under such conditions may result in fire or electric shocks.

When disconnecting the power cord, hold the plug, not the cord.

- If the power cord itself is pulled, the cord will become damaged, and fire, short-circuits or serious electric shocks may result.

Always disconnect all cables before moving the projector.

- Moving the projector with cables still attached can damage the cables, which could cause fire or electric shocks to occur.

Do not place objects or other projectors on top of this unit.

- The objects or projectors may lose their balance or fall off, causing possible injury. Further, stacking one projector directly on top of another may cause the projectors to become deformed, resulting in possible malfunctioning.

Do not short-circuit, heat or disassemble the battery or place it into water or fire.

- Failure to observe this may cause the battery to overheat, leak, explode or catch fire, and burns or other injury may result.

When inserting the battery, make sure the polarities (+ and -) are correct.

- If the battery is inserted incorrectly, it may explode or leak, and fire, injury or contamination of the battery compartment and surrounding area may result.
- Do not use a new battery together with an old battery.
- Remove the batteries if you are not going to use the projector for a prolonged period of time.

Use only the Specified battery.

- If incorrect batteries are used, they may explode or leak, and fire, injury or contamination of the battery compartment and surrounding area may result.

Do not look into the lens while the projector is being used.

- Strong light is emitted from the projector's lens. If you look directly into this light, it can hurt and damage your eyes.

Do not use the old lamp unit.

- The lamp section may break.

When the lamp bursts, handle it properly and observe the below precautions.

- There may be shards of glass scattered inside the projector and inside the lamp unit.
- Ask the dealer to replace the lamp and inspect the inside of the projector.
- Gas and fine particles may be blown out through the ventilation holes. The gas contains mercury. If you breathe in any of the gas, or if it gets in your eyes or mouth, consult a physician immediately.

Disconnect the power cord plug from the wall outlet as a safety precaution before carrying out any cleaning.

- Electric shocks can result if this is not done.

Ask an Authorized Service Center to clean inside the projector at least once a year.

- If dust is left to build up inside the projector without being cleaned out, it can result in fire or problems with operation.
- It is a good idea to clean the inside of the projector before the season for humid weather arrives. Ask your nearest Authorized Service Center to clean the projector when required. Please discuss with the Authorized Service Center regarding cleaning costs.

Do not reach for the openings beside the optical lens, during horizontal or vertical movements of the lens there is a injury hazard.

Accessories

Check that all of the accessories shown below have been included with your projector.

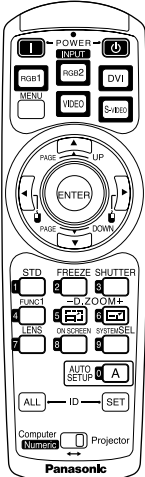
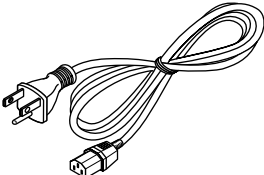
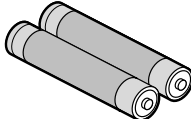
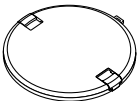
<p>Remote control unit [N2QAEA000023 x 1]</p> 	<p>Power cord [K2CG3FZ00008 x 1]</p> 	<p>Battery for remote control unit [R03NW/2ST x 1]</p> 	<p>Lens cover [TKKL5244-1 x 1]</p> 
---	--	---	--

Precautions on handling

■ Precautions on transport

Make absolutely sure that the lens cap is in place when transporting the projector or carrying it around. Both the projector and the projection lens are precision-made and, as such, are susceptible to vibration and impacts. When transporting the projector and lens or carrying them around, place them in the boxes in which they were housed at the time of purchase, and take care to keep them away from vibration and impacts.

■ Precautions on installation

Be sure to observe the following precautions when installing the product.

- **Avoid installing the product in a place exposed to vibrations or impacts.**

If the projector is installed in a place where vibrations are transmitted from a source of driving power and others or mounted in a car or a vessel, vibrations or impacts may be transmitted to the product to damage the internal parts, causing failure. Install the product in a place free from vibrations and impacts.

- **Do not move the projector while it is operating or subject it to vibration or impact.**

The service life of its internal motors may be shortened.

- **Do not install the projector near high-voltage power lines or power sources.**

The product may be exposed to interference if it is installed in the vicinity of high-voltage electrical power lines or power sources.

- **Do not place the projector on a vinyl sheet or carpet.**

If a vinyl sheet sucked up and blocks the air filter intake port, the internal temperature of the projector may increase, which triggers the protection circuit, turning off the power.

- **Be sure to ask a specialized technician when to install the product to a ceiling.**

If the product is to be installed hanging from the ceiling, purchase an optional hanging attachment (for high ceiling: Model No. ET-PKD35) (for low ceiling: Model No. ET-PKD35S) and call a specialized technician for installation.

- **Do not place the projector over 2 700 m (8 881.5') above sea level. When using it over 1 400 m (4 605.3') above sea level, set the "Fan Control1", described on page 35, to "HIGHLAND".**

Otherwise the life of the product may be shortened.

■ Disposal

To discard the product, call the dealer or a specialized dealer.

■ Precautions on use

- **To view clear images:**

- The audience cannot enjoy high-contrast and clear images if outside light or the illumination interferes the screen surface. Draw window curtains or blinds, turn off the lightings near the screen or take other proper measures.
- In rare cases, wafture can occur on the screen affected by the warm air from the exhaust port depending on the environment.

- **Do not touch the surface of the projection lens with bare hand.**

If fingerprints or stains are left on the projection lens surface, they are magnified and projected on the screen. Keep your hands away from the lens. Cover the lens with the supplied lens cap when the projector is not used.

- **Lamp**

A mercury lamp with high internal pressure is used for the light source of this product. A high-pressure mercury lamp has the following characteristics:

- It may burst with a loud sound or end its life cycle by not illuminating because of given impacts, flaws, or deterioration due to used hours.
- The life cycle of a mercury lamp varies according to the individual difference or conditions of use. In particular, turning the power on and off frequently and/or repeatedly will greatly affect the life cycle.
- In rare cases, it may burst shortly after the first lighting.
- The possibility of burst increases when the lamp is used beyond the replacement time.

Cleaning and maintenance

Be sure to remove the power cord plug from the receptacle before cleaning.

Use soft and dry cloth to clean the cabinet

If stains are hard to remove, use a cloth dampened with a kitchen detergent solution (neutral) and squeezed to wipe the cabinet and finish with a dry cloth. If a chemical wipe is used, follow its instructions.

Do not clean the lens surface with fuzzy or dusty cloth.

If dust adheres to the lens, it will be magnified and projected on the screen.

Use a soft and clean cloth to wipe off dust.

Name and function of parts

Remote control

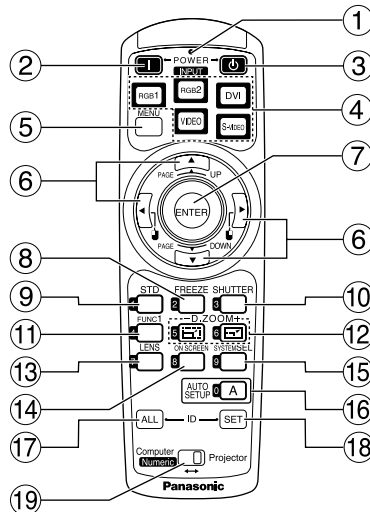

< When the operation mode selector ⑱ is set to Projector >

① Remote control operation indicator lamp

The lamp flashes when any remote control button is pressed.

② POWER ON button (page 22)

Turns on the power if the MAIN POWER has been put to the "I" position.

③ POWER OFF button (page 23)

Turns off the power if the MAIN POWER has been put to the "I" position.

④ Input selector (RGB1, RGB2, DVI, VIDEO, S-VIDEO) button

Use to toggle through the RGB1, RGB2, DVI-D, VIDEO and S-VIDEO input ports.

⑤ MENU button (page 28)

Displays and clears the Main Menu. It can also return to the previous screen when the menu is displayed.

⑥ Arrow ▲ ▼ ◀ ▶ buttons (page 28)

Use these buttons to select an item on the menu screen, change setting, adjust the sound volume and adjust the level.
Also use them to enter the "SECURITY" password.

⑦ ENTER button (page 28)

Press this button to enter your menu selection or to run function.

⑧ FREEZE button (page 25)

Press this button to freeze the image temporarily.

⑨ Standard (STD) button (page 28)

Press this button to restore the default factory setting.

⑩ SHUTTER button (page 25)

Press this button to black out the image temporarily.

⑪ Function 1 (FUNC1) button (page 36)

This button can control the functions set in "FUNC1" of the "OPTION2" screen from Main Menu.

⑫ Digital Zoom (- D.ZOOM +) buttons (page 26)

Any portion of the picture can be zoomed in.

⑬ LENS button (page 24)

Switches to the mode of projection lens adjustment.

⑭ ON SCREEN button

This button turns on and off the on-screen indication function.

⑮ SYSTEM SELECTOR button (page 30)

Signal system switching (TV system/System) can be done.

⑯ AUTO SETUP button (page 25)

Pressing this button while projecting an image automatically corrects the picture positioning on the screen. While the auto setup feature is active, a message "AUTO SETUP..." appears on the screen.

⑰ ID ALL button (page 15)

When two or more main units are used in the system, this button switches to the mode to control them simultaneously with a single remote control.

⑱ ID SET button (page 15)

When two or more main units are used in the system, this button specifies the ID of the remote control.

⑲ Operation mode selector (Computer/Numeric, Projector) switch (page 15)

Put this selector to the right position to control the projector and to the left position to control the PC or use numeric buttons.

Name and function of parts

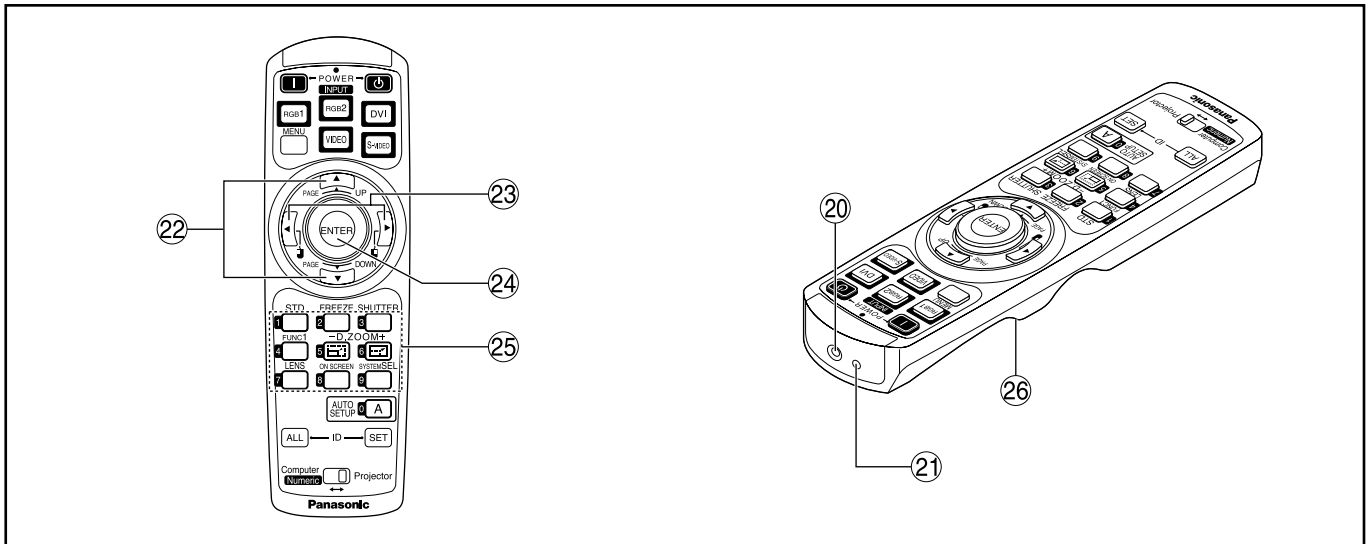

②① Remote control wired terminal (page 16)

To use the wired output terminal, connect the remote control and the main unit with the M3 stereo mini jack cable (available in the market).

②② Remote control transmitter window

Operate the remote control aiming at the remote control receiver window on the main unit.

<When the operation mode selector ①⑨ is set to Computer>

②③ PAGE UP/PAGE DOWN buttons

These buttons correspond to the PAGE UP/PAGE DOWN buttons on PC's keyboard.

②④ ⏪ ⏩ (◀ ▶) buttons

These buttons correspond to the left and right mouse buttons.

②⑤ ENTER button

Moves the mouse cursor.

②⑥ Numeric (0-9) buttons

In a system that uses a multiple number of projectors, these buttons serve to specify a particular projector.

They are also used to enter the password when the password for service personnel needs to be entered.

②⑦ Click button (page 15)

This button corresponds to the left mouse button when the operation mode is switched to the Computer position.

Note • To use the remote control as a mouse, please purchase an optional wireless mouse receiver (model No.: ET-RMRC2).

Front and side of the projector

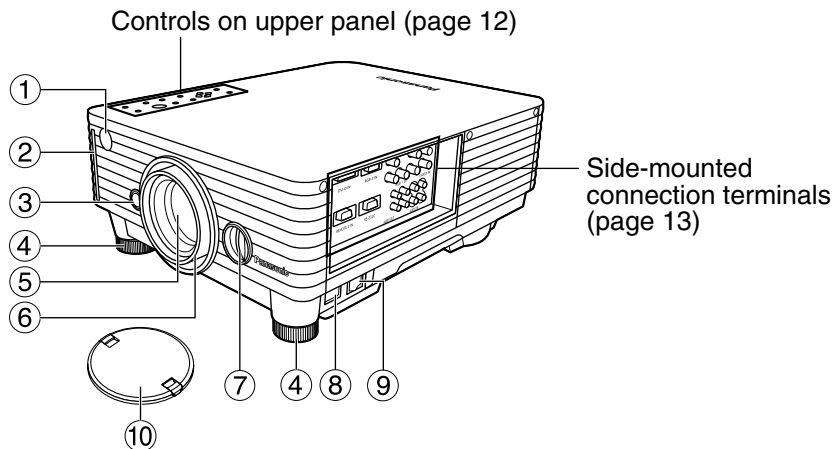

① **Remote control receiver window (page 14)**

This window receives the signal beam emitted from the remote control.

② **Air filter (page 43)**

③ **Lens lock button (page 21)**

Press this to remove the projection lens.

④ **Level-adjusting feet (page 22)**

Use these feet to adjust the tilt of the projector. The leveling feet at the front left and right can be adjusted.

⑤ **Projection lens**

Lens for projecting images on the screen.

⑥ **Focus ring (page 24)**

For focus adjustment.
Powered focus adjustment is also available.

⑦ **Lens left/right adjusting dial (page 24)**

Turn this clockwise to move the screen to the left; conversely, turn it counterclockwise to move it to the right.

⑧ **AC IN terminal (page 22)**

Connect the supplied line power cord into this receptacle.

Do not connect any other cable to this socket.

⑨ **MAIN POWER switch (page 22)**

Use this switch to turn on "I" and off "O" the commercial line power applied to the projector.

⑩ **Lens cap**

Cap the lens whenever the projector is left unused.

Name and function of parts

Rear and side view of the main unit

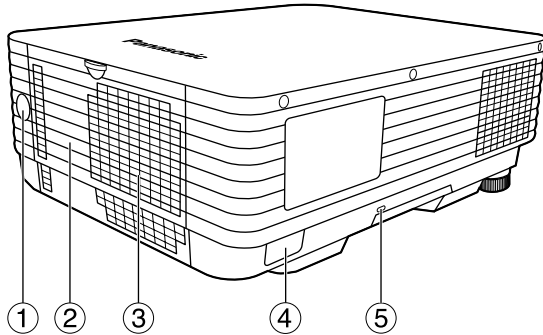

Controls on upper panel

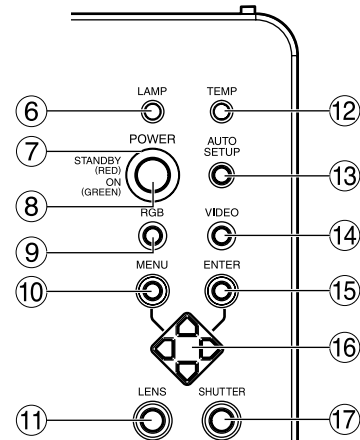

① Remote control receiver window (page 14)

This also receives the signal beam coming from the remote control.

② Lamp unit cover

The lamp unit is housed.

③ Ventilation holes

④ Clasp for attaching anti-theft chain

Attach a chain or other fastening device available from a hardware store through this clamp.

⑤ Burglar lock

Attach a commercial burglar prevention cable (e.g., from Kensington) to this lock port. It is compatible with the Microsaver Security System from Kensington. Contact details for this company are given below.

Kensington Technology Group ACCO Brands Inc.
2885 Campus Drive San Mateo, CA94403
Tel (650)572-2700
Fax (650)572-9675
<http://www.kensington.com/>
<http://www.gravis.com/>

⑥ LAMP monitor (page 42)

This lamp lights up when the time to replace lamp unit is reached. It also blinks if something unusual occurs in the lamp circuit.

⑦ Power indicator (page 22)

The lamp lights in red when the MAIN POWER switch is turned to (I) (on). It turns to green when the POWER button on the main unit or the POWER ON (I) button on the remote control is pressed.

⑧ POWER button (page 22, 23)

Turns on/off the power.

⑨ RGB input (RGB) button

Switches input as given below when pressed.

→ RGB1 → RGB2 → DVI

⑩ MENU button (page 28)

Displays and clears the Main Menu. It can also return to the previous screen when the menu is displayed.

The on-screen display (OSD) selection menu can be displayed by holding down the menu key for at least three seconds.

⑪ LENS button (page 24)

Switches to the adjustment mode for lens focus, zoom and shift (position).

⑫ Temperature monitor (TEMP) (page 42)

Lighting or blinking of this lamp indicates an abnormal condition of the internal temperature.

⑬ AUTO SETUP button (page 25)

Pressing this button while projecting an image automatically corrects the picture positioning on the screen.

⑭ Video input (VIDEO) button

Switches input as given below when pressed.

VIDEO ↔ S-VIDEO

⑮ ENTER button (page 28)

Press this button to enter your menu selection or to run function.

⑯ Arrow (▲ ▼ ◀ ▶) buttons (page 28)

Use to select an item on the menu screen, change setting, adjust the sound volume and adjust the level.

Also use them to enter the "SECURITY" password.

⑰ SHUTTER button (page 25)

Press this button to black out the image temporarily.

Side-mounted connection terminals

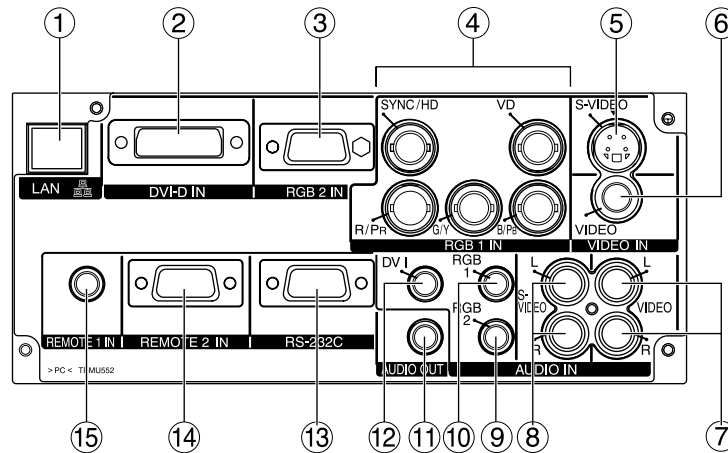

① LAN terminal (page 38)

This terminal is used to control the projector from the PC. (10Base-T/100Base-TX compliant)

LAN terminal (10Base-T/100Base-TX)

Connect LAN cable.

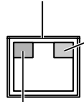

LAN 10/100 lamp (Yellow)

Lights up when 100Base-TX connected.

LAN LINK/ACT lamp (Green)

Lights up when connected. Flashes when receiving/sending signals.

② DVI-D IN terminal (page 20)

DVI-D signals are applied to this terminal. (24-pin DVI connector)

③ RGB 2 input (RGB 2 IN) terminal (page 20)

A terminal to input RGB or YPBPR signals (D-SUB 15-pin female).

④ RGB 1 input (RGB 1 IN) terminal (pages 19, 20)

A terminal to input RGB or YPBPR signals (BNC).

⑤ S-VIDEO input terminal (page 19)

An input terminal for S-video signals (MIN4-pin DIN).

This terminal complies with S1 signals and automatically toggles between 16:9 and 4:3 according to the size of input signals.

⑥ VIDEO input terminal (page 19)

An input terminal for video signals. (RCA)

⑦ VIDEO audio input terminal

An audio input terminal for video input signals. (RCA)

⑧ S-VIDEO audio input terminal

An audio input terminal for s-video input signals. (RCA)

⑨ RGB2 audio input terminal

An audio input terminal for RGB2 input signals. (M3 stereo mini jack)

⑩ RGB1 audio input terminal

An audio input terminal for RGB1 input signals. (M3 stereo mini jack)

⑪ AUDIO OUT terminal

An audio output terminal for audio amplifier or other devices. (M3 stereo mini jack)

⑫ DVI audio input terminal

An audio input terminal for DVI-D input signals. (M3 stereo mini jack)

⑬ Serial input terminal (RS-232C) (pages 20, 39)

Use the RS232C serial terminal as an alternative interface for controlling the projector from your PC (D-SUB 9-pin female).

⑭ REMOTE2 IN terminal (page 41)

The user can remotely control the main unit by using an external control circuit to this terminal (D-SUB 9-pin female).

⑮ REMOTE1 IN terminal (page 16)

The main unit can be controlled with a wired remote control cable (M3 stereo mini jack).

Using the remote control unit

■ Loading dry cells

When loading batteries into the battery compartment of the remote control, make sure that their polarities are correct.

1. Open battery compartment lid.

Open the lid in the order of steps ① and ②.

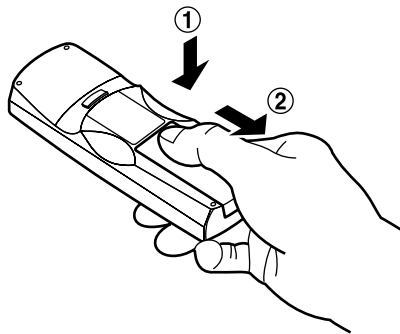

2. Insert the dry cells.

Into battery compartment, with their polarities orientated as indicated (+, -) in the compartment.

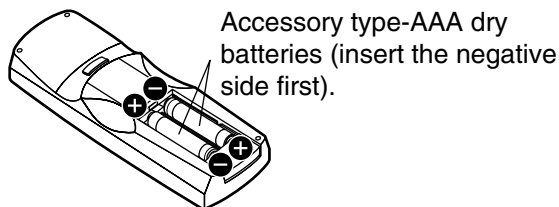

3. Close the battery compartment lid.

Replace the battery compartment lid over the compartment and slide until it clicks.

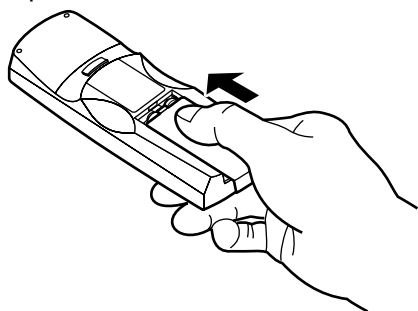

- Attention**
- Do not drop the remote control unit.
 - Do not expose remote control unit to any liquid.
 - Do not use NiCd batteries.

■ Effective range of remote control operation

The remote control should normally be aimed at either the front or rear remote control receiver window on the projector (figure 1). Otherwise, it may also be aimed at the screen, which will reflect commands back to the projector's front receiver window as illustrated in figure 2.

The effective control range is approx. 7 meters from the beam receiver on the front or rear.

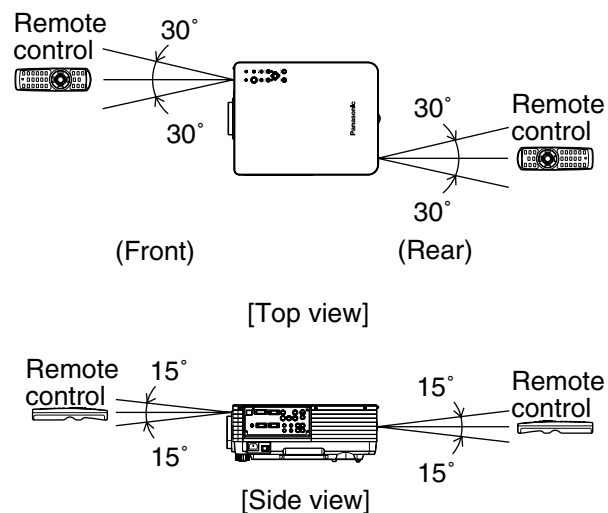

Figure 1

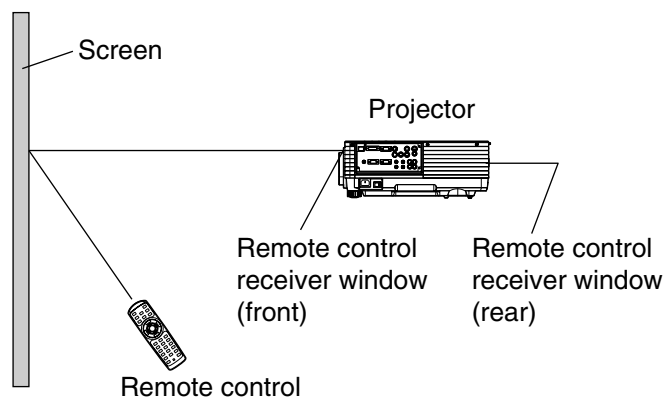

Figure 2

- Note**
- When the remote control is aimed at the screen, the effective control range may be reduced due to the optical loss by screen reflection.
 - The remote control may not function properly if an object is in the light path.
 - The remote control receiver may not function properly in intense ambient light such as fluorescent lamps. Carefully site the projector so its remote control receiver windows will not be directly exposed to intense light.

■ Setting projector ID number to remote control

Every projector has its ID number and the ID number of the controlling projector must be set to the remote control in advance so that the user can operate the remote control. **The ID number of the projector is set to “ALL” on shipping, and use the ID ALL button of the remote control when using only a single projector.**

Procedure of ID setting

- ① Change the position of the operation mode selector switch to “Computer”.
- ② Press the ID SET button, and within five seconds use the number (0 to 9) buttons to enter the 2-digit ID number set by the projector.
- ③ Change the position of the operation mode selector switch to “Projector”.

However, if the ID ALL button is pressed, the projector can be controlled regardless of the ID number of the projector (simultaneous control mode).

- Attention**
- Do not press the ID SET button accidentally or carelessly because the ID number on the remote control can be set even when no projector is around. If the ID SET button is pressed, the ID number goes back to the one set before pressing the ID SET button unless a numeric button is pressed within five seconds after the ID SET button is pressed.
 - Your specified ID number is stored in the remote control unit unless another one is specified later. However, the stored ID will be erased if the batteries of the remote control are left exhausted. When the dry cells are replaced, set the same ID number again.

■ Using the remote control as a PC mouse

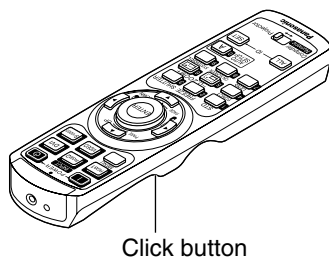
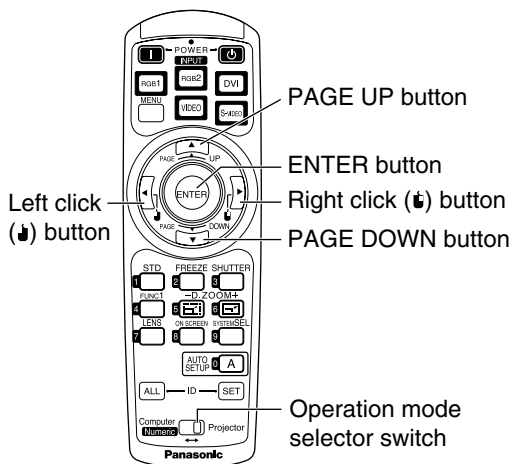

Operation mode selector switch

Put the knob to the Computer position.

- **ENTER button**
Pressing the front, rear, left and right edges of the button moves the mouse cursor up, down, left and right.
- **Right click (➡) button**
This button can be used as the right mouse button.
- **Left click (⬅) button**
This button can be used as the left mouse button.
- **PAGE UP button**
This button can be used as the Page Up button on the PC keyboard.
- **PAGE DOWN button**
This button can be used as the Page Down button on the PC keyboard.
- **Click button**
This button can be used as the left mouse button.

Note • To use the remote control as a mouse, please purchase an optional wireless mouse receiver (model No.: ET-RMRC2).

Using the remote control unit

■ Using a wired remote control

If the installed environment of the main unit is such that an obstacle to the light exists between the main unit and the remote control or the main unit is susceptible to the effects of external light, connect a M3 stereo mini jack cable available in the market to control the main unit.

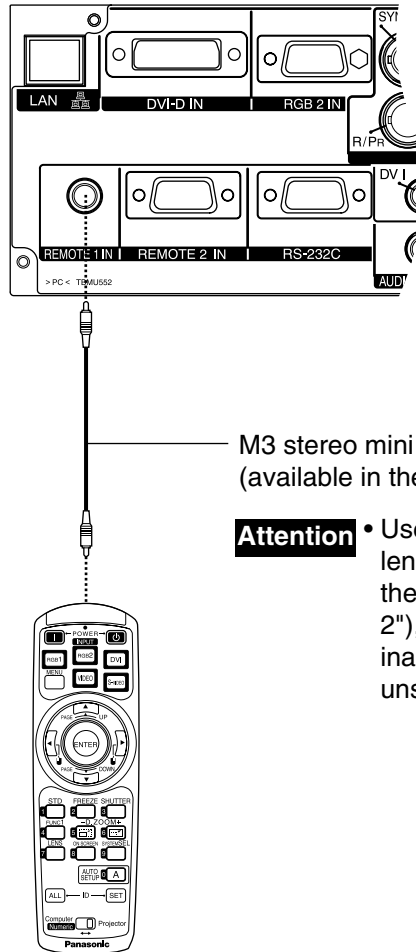

M3 stereo mini jack cable
(available in the market)

Attention • Use two-core shielded cable of length smaller than 15 m (49' 2"). If the cable length exceeds 15 m (49' 2"), or if the shielding of the cable is inadequate, the operation may be unsatisfactory.

Installation

■ Projection schemes

Any of the following four projection schemes can be used with the PT-D3500U projector depending on user's needs or viewing conditions. Use "OPTION2" menu (chosen from the MENU) to choose the appropriate projection scheme (see page 35).

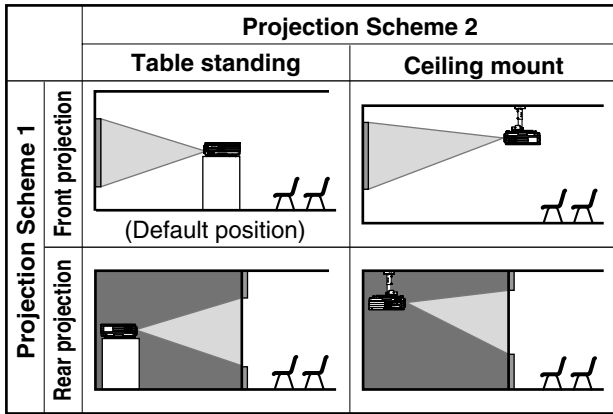

■ Installation geometry

After the projector is roughly positioned, picture size and vertical picture positioning can be finely adjusted with the powered zoom lens and lens tilt mechanism.

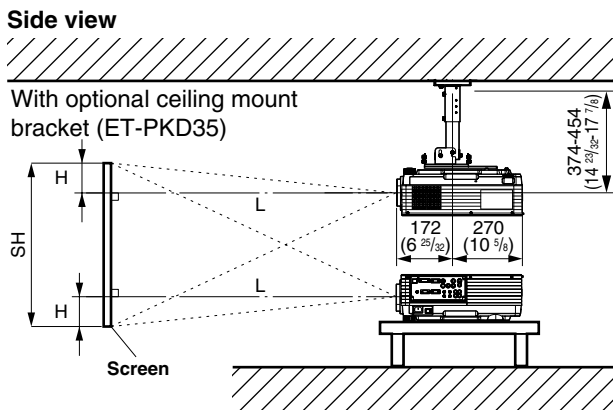

- L : Projection distance
- SH : Image height
- SW : Image width
- H : Distance from center of lens to bottom edge of projected image.

Top view

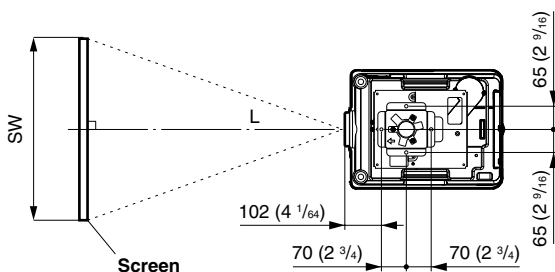

■ Projection distances

Listed in the table below are the projection distances of the standard lens provided with the PT-D3500U. Refer to page 61 for the projection distances of the projection lenses available as optional accessories.

Unit : m () : inch [] : foot

Screen Size (4 : 3)			Projection distance: L		Height position: H
Diagonal length (SD)	Height (SH)	Width (SW)	Minimum (LW)	Maximum (LT)	
1.27 (50")	0.76 [2'5"]	1.02 [3'4"]	1.81 [5'11"]	2.40 [7'10"]	0 to 0.38 (0 to 14 61/64)
1.52 (60")	0.91 [2'11"]	1.22 [4']	2.18 [7'1"]	2.89 [9'5"]	0 to 0.46 (0 to 18 7/64)
1.78 (70")	1.07 [3'6"]	1.42 [4'7"]	2.55 [8'4"]	3.38 [11'1"]	0 to 0.53 (0 to 20 55/64)
2.03 (80")	1.22 [4']	1.63 [5'4"]	2.92 [9'6"]	3.87 [12'8"]	0 to 0.61 (0 to 24 1/64)
2.29 (90")	1.37 [4'5"]	1.83 [6']	3.29 [10'9"]	4.36 [14'3"]	0 to 0.69 (0 to 27 11/64)
2.54 (100")	1.52 [4'11"]	2.03 [6'7"]	3.66 [12']	4.85 [15'10"]	0 to 0.76 (0 to 29 59/64)
3.05 (120")	1.83 [6']	2.44 [8']	4.41 [14'5"]	5.83 [19'1"]	0 to 0.91 (0 to 35 59/64)
3.81 (150")	2.29 [7'6"]	3.05 [10']	5.52 [18'1"]	7.30 [23'11"]	0 to 1.14 (0 to 44 7/8)
5.08 (200")	3.05 [10']	4.06 [13'3"]	7.38 [24'2"]	9.75 [31'11"]	0 to 1.52 (0 to 59 27/32)
6.35 (250")	3.81 [12'6"]	5.08 [16'8"]	9.23 [30'3"]	12.20 [40']	0 to 1.91 (0 to 75 13/64)
7.62 (300")	4.57 [14'11"]	6.10 [20']	11.09 [36'4"]	14.65 [48']	0 to 2.29 (0 to 90 5/32)
8.89 (350")	5.33 [17'5"]	7.11 [23'3"]	12.95 [42'5"]	17.10 [56'1"]	0 to 2.67 (0 to 105 1/8)
10.16 (400")	6.10 [20']	8.13 [26'8"]	14.80 [48'6"]	19.55 [64'1"]	0 to 3.05 (0 to 120 5/64)
12.70 (500")	7.62 [25']	10.16 [33'4"]	18.51 [60'8"]	24.45 [80'2"]	0 to 3.81 (0 to 150)
15.24 (600")	9.14 [29'11"]	12.19 [39'11"]	22.23 [72'11"]	29.35 [96'3"]	0 to 4.57 (0 to 179 59/64)

Setting-up dimensions which are not given in the above table can be calculated using the formulas below.

$$LW = 0.03713 \times SD - 0.05067$$

$$LT = 0.049 \times SD - 0.05$$

(LW,LT: m SD: inch)

For 16 : 9 aspect ratios, the following formula can be used to calculate the screen width (SW).

$$SW = (SD \times 0.0254) \times 16 \div \sqrt{337}$$

The value for SW obtained above can then be used with the following function to calculate the projection distance for the wide lens position (LW) and the projection distance for the telephoto lens position (LT).

$$LW = 1.827 \times SW - 0.05067$$

$$LT = 2.411 \times SW - 0.05$$

Note

- The dimensions in the table above and the values obtained from the above formulas may contain slight errors.
- It is recommended that you use the projection distance for the wide lens position.
- The above dimensions are the case when the aspect ratio is 4:3. When an SXGA signal is input and projected, the right and left ends of the picture will be blanked the aspect ratio will be 5:4.

Attention

- Do not place or use one projector on top of another projection unit.
- Install the projector such that the exhaust port on the rear side is not blocked and a clearance of more than 30 cm (11 13/16") is available.

Connection

■ Setup precautions

- Before connecting any of your video/audio equipment to the projector, carefully read the owners manual supplied with the equipment once again.
- All cable connections should be made with the entire system devices, including the projector, first turned off.
- Obtain commercial interconnecting cables for devices supplied with no accessory or optional interconnect cables.
- Video signals containing too much jitter may cause the images on the screen to randomly wobble or shake. Inserting a time base corrector (TBC) in the projector's video line will relieve this problem.
- The projector only accepts composite-video, S-video, analog-RGB (with TTL sync. level), and digital signal from PC.
- Some PC models are not compatible with the PT-D3500U projector.

- The pin assignments on the S-VIDEO IN port are as follows:

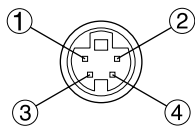

Viewed from mating side

Pin No.	Signal
①	Ground (luminance)
②	Ground (color)
③	Luminance signal
④	Color signal

- The pin assignments on the DVI-D input port are as follows (interface with DVI-D output port on PC):

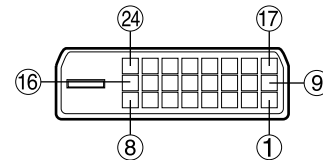

Viewed from mating side

Pin No.	Signal	Pin No.	Signal
①	T. M. D. S data 2-	⑬	T. M. D. S data 3+
②	T. M. D. S data 2+	⑭	+5 V
③	T. M. D. S data 2/4 shield	⑮	Ground
		⑯	Hot plug sense
④	T. M. D. S data 4-	⑰	T. M. D. S data 0-
⑤	T. M. D. S data 4+	⑱	T. M. D. S data 0+
⑥	DDC clock	⑲	T. M. D. S data 0/5 shield
⑦	DDC data		
⑧	—	⑳	T. M. D. S data 5-
⑨	T. M. D. S data 1-	㉑	T. M. D. S data 5+
⑩	T. M. D. S data 1+	㉒	T. M. D. S clock shield
⑪	T. M. D. S data 1/3 shield		
⑫	T. M. D. S data 3-	㉓	T. M. D. S clock+
		㉔	T. M. D. S clock-

- The pin assignments on the RGB2 input port are as follows:

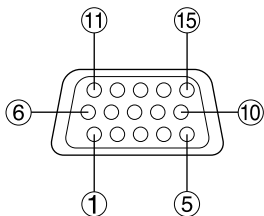

Viewed from mating side

Pin No.	Signal
①	R/P _R
②	G/G · SYNC/Y
③	B/P _B
⑫	SDA
⑬	HD/SYNC
⑭	VD
⑮	SCL

Pin ⑨ : Not used.

Pins ④ - ⑧, ⑩ and ⑪ : Ground.

Pins ⑫ and ⑮ : Valid if the PC has the corresponding function.

- The DVI-D input terminal supports single link only.
- EDID settings should be performed to suit the DVI equipment being connected. (Page 34)
- The DVI-D input terminal can be used to connect to a DVI equipment, but note that images may not appear or the projector may not work properly when connected to certain DVI equipment.

■ Example of connecting with AV products

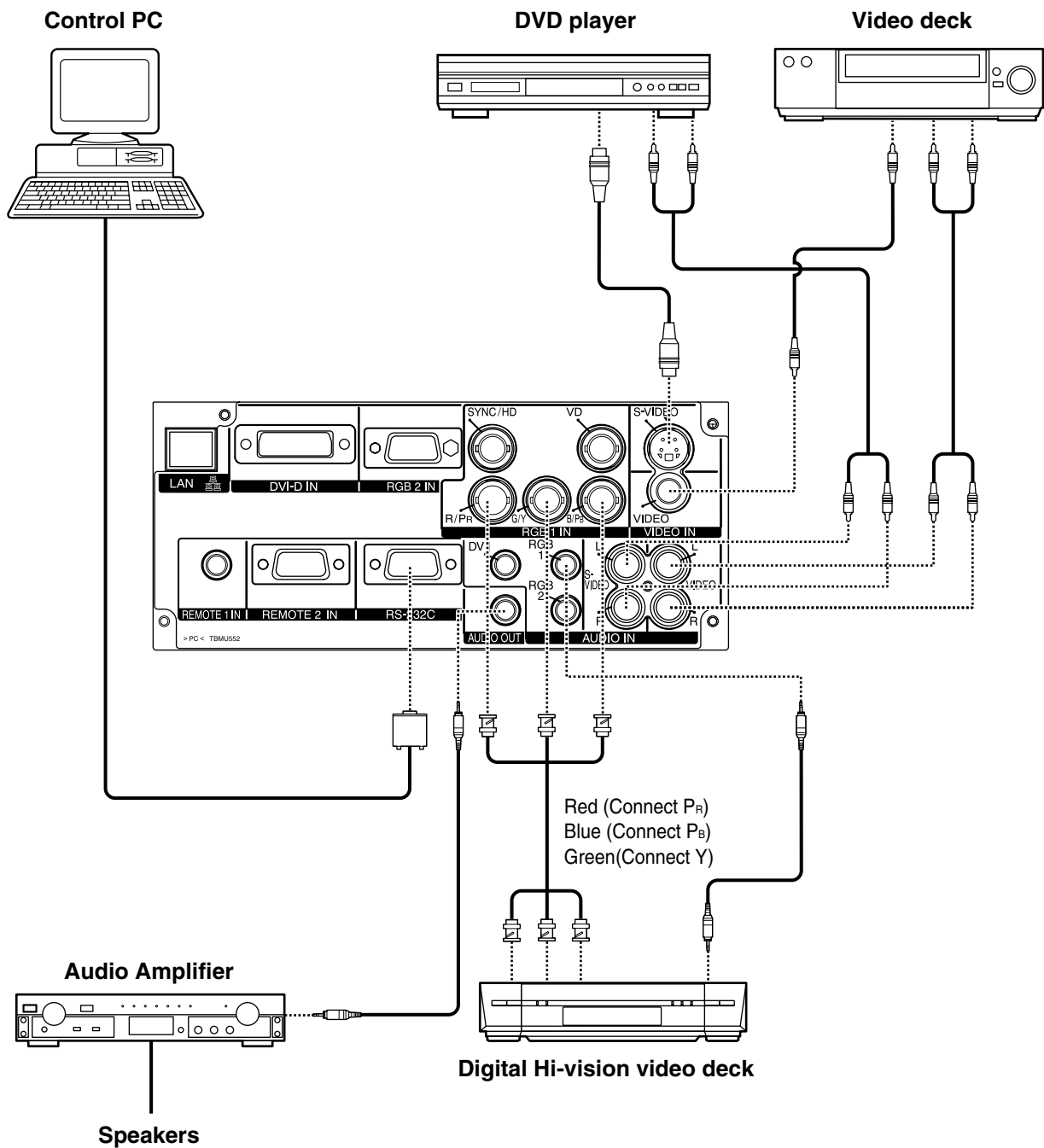

- Attention**
- When connecting with a video deck, be sure to use the one with a built-in time base corrector (TBC) or use a TBC between the projector and the video deck.
 - If nonstandard burst signals are connected, the image may be distorted. If this is the case, connect a TBC between the projector and the video deck.

■ Example of connecting with PCs

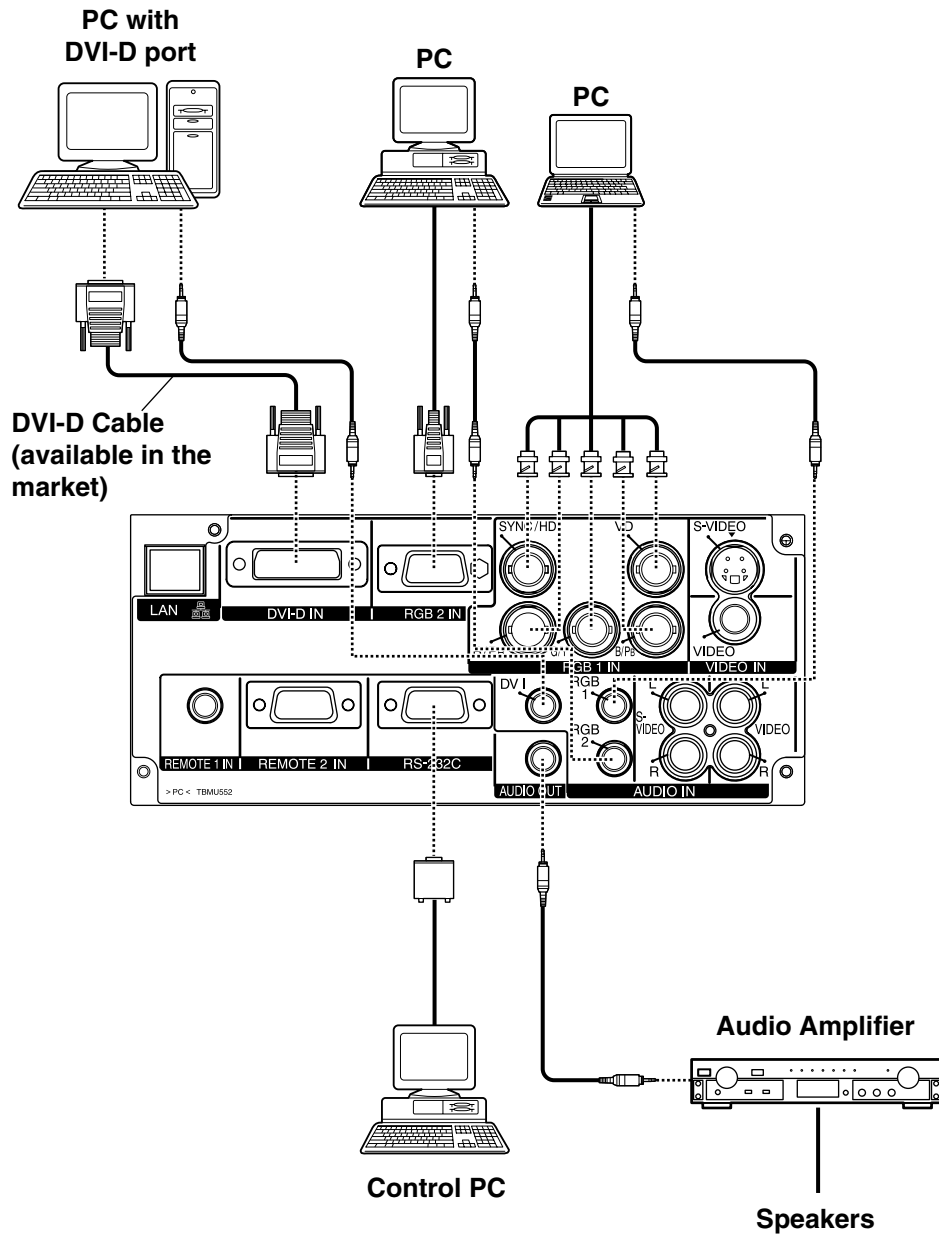

Note

- For the specifications of the RGB signals that can be applied from the PC, see the data sheet on page 60.
- If your PC has the resume feature (last memory), the computer may not function properly until the resume capability is disabled.
- When the SYNC ON GREEN signal is input, do not input sync signals to the SYNC/HD and VD terminals. Doing so may disrupt the images since, rather than using synchronization initiated by the GREEN signal, the sync signals of the SYNC/HD and VD terminals will be used instead. Even if the images are not disrupted, the white balance may be lost. If this is the case, select "USER" as the "COLOR TEMP." setting (see page 29), and adjust "W-BAL LOW".
- The white balance may be lost when the SYNC ON RGB signal is input. If this is the case, select "USER" as the "COLOR TEMP." setting (see page 29), and adjust "W-BAL LOW".

How to install and remove the projection lens (optional)

■ How to install the projection lens

- ① Align the guide of the projection lens with the guide groove in the main unit.
- ② Turn the lens clockwise until it clicks into place.

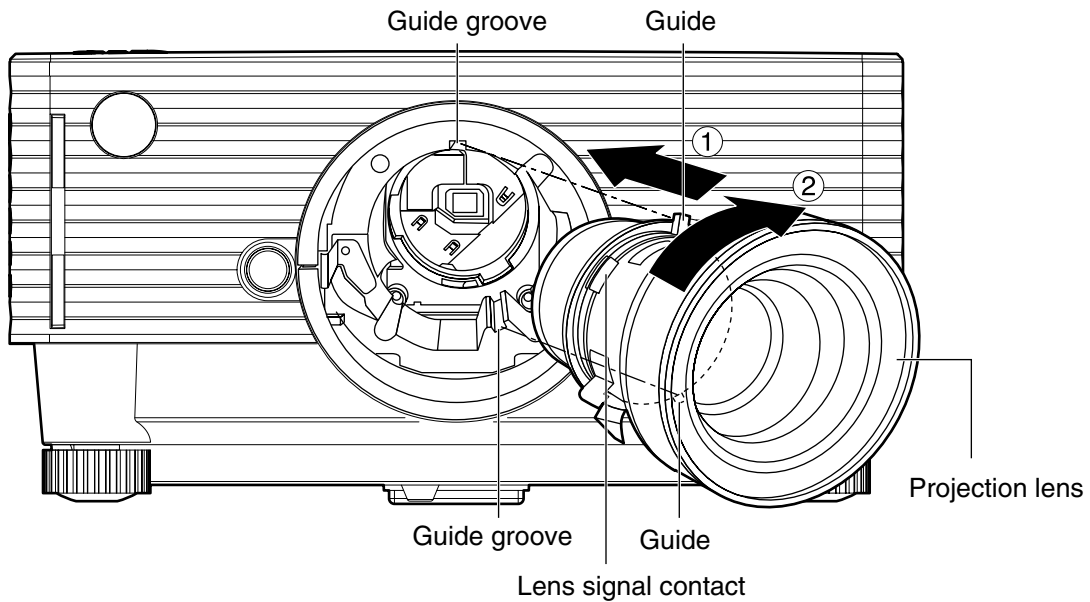

Attention • Turn the lens counterclockwise and confirm that the lens does not come off.

■ How to remove the projection lens

- ① Turn the lens counterclockwise as far as it will go.
- ② While holding down the lens lock button, turn the lens further counterclockwise.
- ③ Remove the lens.

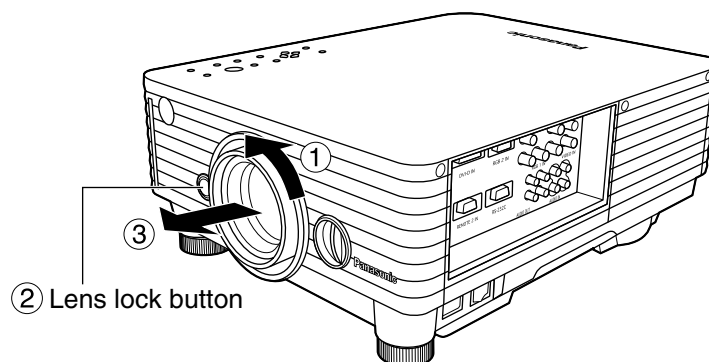

- Note**
- Before replacing the lens, turn off the projector's power.
 - Do not touch the lens signal contact. Dust or dirt may cause defective contact.
 - Do not touch the surface of the projection lens with your bare hands.
 - Store the replaced lens where it will be free from vibration and impact.

Projection

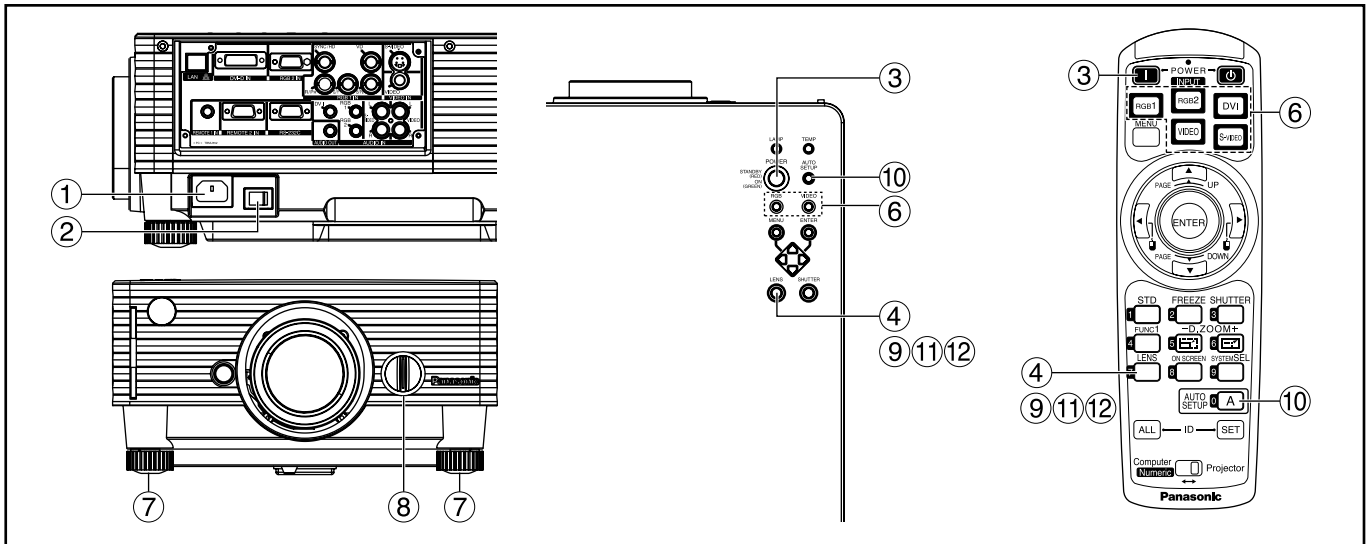

■ Powering up the projector

Remove the lens cover.

- ① **Connect the supplied power cable.**
(120 V AC, 50 Hz/60 Hz)
- ② **Press the “I” marked side of the MAIN POWER switch to turn on the power.**
The power indicator lights up red, and the projector is placed in the standby mode.
- ③ **Press the POWER button on the main unit, or the POWER ON (I) button on the remote control.**
The power indicator illuminates in green and soon the image is projected on the screen.

■ Making adjustment and selection

- ④ **Roughly adjust the focus of the lens.**
(Refer to page 24.)
Press the LENS button on the main unit or the remote control unit to display a focus adjustment screen. Pressing ▲ ▼ buttons to adjust the image into focus.
- ⑤ **Select and set the projection scheme.**
(Refer to page 35.)
- ⑥ **Select the input signal by pressing the input selector button (the RGB/VIDEO button on the main unit, or the RGB1/RGB2/VIDEO/S-VIDEO/DVI button on the remote control).**
- ⑦ **Turn the feet, and adjust the tilt of the main unit in the front and rear or left and right.**
- ⑧ **Use the lens left/right adjustment dial to adjust the direction of the lens. (page 24)**

- ⑨ **Press the LENS button three times to adjust the lens shift. (Refer to page 24.)**
- ⑩ **Press the AUTO SETUP button if the input signal is RGB/DVI signal. [on the main unit or the remote control]**
- ⑪ **Fit the image size to the screen size.**
Press the LENS button twice and adjust the zoom of the lens on the lens zoom adjustment menu.
- ⑫ **Press the LENS button and adjust the focus of the lens on the lens focus adjustment menu.**
- ⑬ **Display the zoom adjustment menu again and adjust the zoom of the lens to fit the image size to the screen size.**
(Refer to page 24.)

Note

- If the projector is powered up at about 0°C, a warm-up period of approximately five minutes may be necessary to start projection.
The temperature monitor (TEMP) lights during the warm-up period.
When the warm-up is completed, the temperature monitor (TEMP) turns off and the image is projected on the screen.
- If the surrounding temperature is very low and the warm-up period exceeds five minutes, the control determines it as an abnormal condition and turns off the power automatically. If this happens, raise the surrounding temperature to 0°C or higher and then turn the main power “on” and turn the power “on” (I).

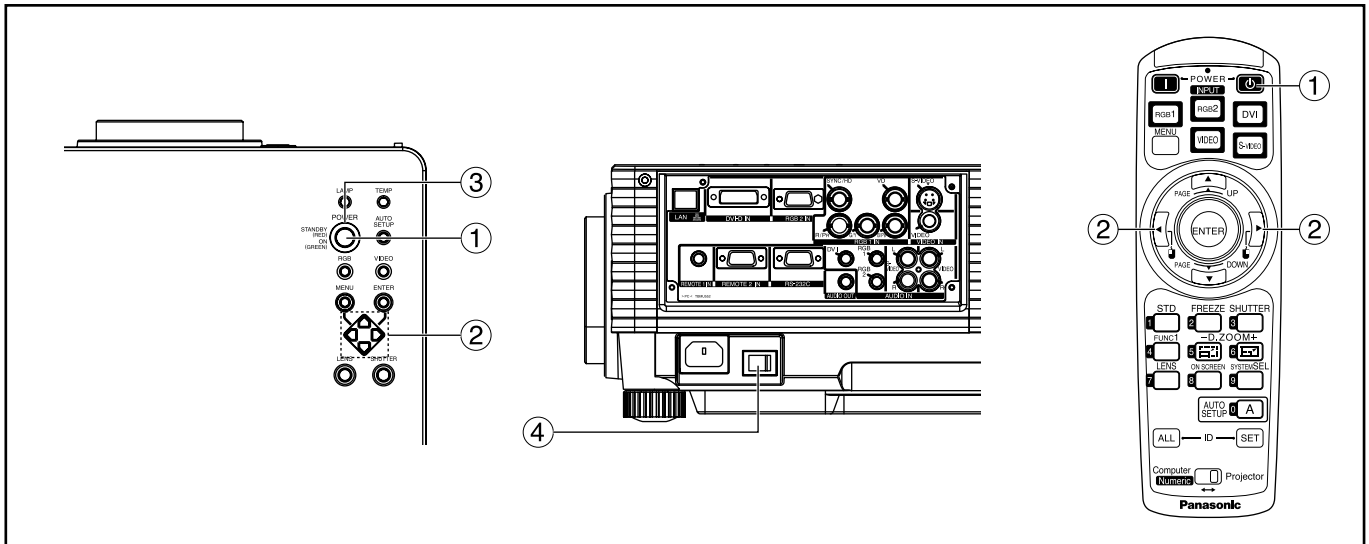

■ Powering off the projector

- ① Press the **POWER** button on the main unit, or the **POWER OFF** (⏻) button on the remote control.
- ② Select “Execute” with ◀ or ▶ button and press the **ENTER** button. (or press the **POWER** button again.)
The projection of the image stops, and the power indicator of the main unit lights up orange. (The cooling fan keeps running.)
- ③ Wait until the power indicator of the main unit turns to red (i.e., until the cooling fan stops).
- ④ Press the “○” marked side of the **MAIN POWER** switch to remove all power from the projector.

Attention • Do not turn the power supply off and then immediately back on again.
Turning on the power supply will not light up the light source lamp if the lamp is in the process of cooling down after turning off the power supply. To light up the lamp, turn on the power supply again when the lamp has been cooled sufficiently.
Turning on the power supply with the lamp in the hot condition may shorten the lamp life.

Note • The projector consumes approximately 10 watts of power even in standby mode after the cooling fan stops. (Power indicator lit in red)
• If you re-power the projector after shutting off the main power inadvertently, the projection lamp may remain unlit. Please turn the power on again after a while.

■ Direct power off function

The power supplied internally causes the cooling fan to continue operating and cool off the lamp when the power has failed or even after the power cord is disconnected immediately after the power has been turned off.

- Note**
- When the lamp has been cooled by the direct power OFF function, it sometimes takes longer than usual for the lamp to light up again.
 - While the cooling fan is operating, do not place the projector inside a box or bag.
 - The operation time of the cooling fan will be less if fewer than 2 minutes have elapsed since the power was turned on.

How to adjust the lens

■ How to adjust the lens focus, lens zoom and lens up/down position movement (optical shift)

The focus, zoom and up/down position of the images projected on the screen can be adjusted while the projector is positioned appropriately in relation to the screen.

- ① Press the LENS button on the remote control or on the control panel of the main unit.

Pressing the button changes the setup screen in the order of "Lens focus", "Lens zoom" and "Lens shift".

- ② Choose an item and adjust it using ▲ ▼ buttons.

Caution

Be careful not to catch your fingers between the lens and shroud when shifting the lens.

Note

- When a lens without zoom functions is used, the lens zoom adjustment menu will still displayed, but no operations can be performed using the items on this menu.
- By shifting the lens up/down position, it is possible to make adjustments upward or downward from the standard position in the direction of the upper 50% of the projected screen height.
- Operations can be performed faster by holding down the ▲ ▼ buttons for about 3 or more seconds.

■ How to adjust the lens position to the left or right

When the lens left/right adjustment dial is turned clockwise, the screen moves toward the left; conversely, when it is turned counterclockwise, it moves toward the right. The maximum travel distance toward the left or right is 10% of the projection screen width.

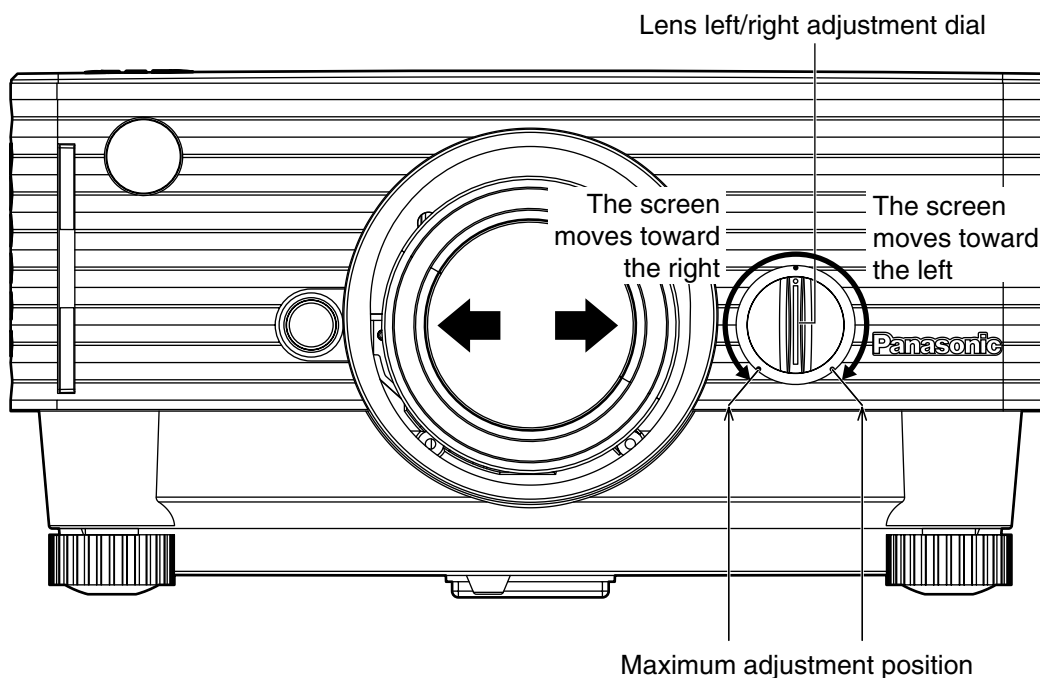

- Attention** • Move the lens left/right adjustment dial to any position up to the maximum adjustment position to make the adjustment. Turning the dial with undue force may cause malfunctioning.

Automatic adjustment (AUTO SETUP)

Automatic adjustment function adjust the resolution, clock phase and image position automatically when dots-structured analog RGB signals such as computer signal are supplied. (Automatic adjustment is not available if moving picture input signals or signals having a dot clock frequency of more than 108 MHz are supplied.) When DVI signals are input, the image position is adjusted automatically.

It is recommended to supply images with a bright white frame at the outermost periphery containing characters etc. that are clear in white and black contrast when the system is in automatic adjustment mode. Avoid supplying images that involve halftones or gradation such as photographs and computer graphics.

Note

- “CLOCK PHASE” may have been shifted even when the adjustment ended normally. In this case, manually adjust the “CLOCK PHASE”.
- Automatic adjustments cannot be performed when images with blurred edges or dark images are input. With composite sync and G-SYNC sync signals and some types of PCs, it may not be possible to perform these automatic adjustments. In this case, manually adjust the items of “INPUT RESOLUTION”, “CLOCK PHASE” and “POSITION”.
- Image may be disturbed for about 4 seconds during automatic adjustment, which is not an abnormal error.

Using the FREEZE function

The image on the screen can be frozen by pressing the FREEZE button on the remote control.

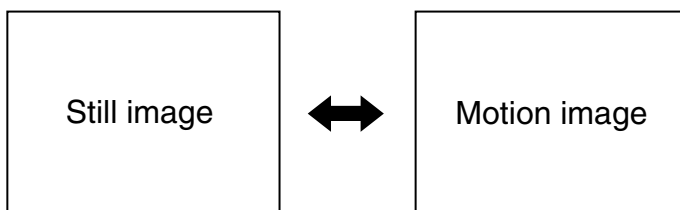

Note

- The audio is turned off.

Using the SHUTTER function

If the projector is not used for a certain period of time during the meeting intermission, for example, a shutter mode is available that allows the user to hide images temporarily.

① Press the “SHUTTER” button of the remote control or the main unit.

The image and audio are turned off.

② Press the “SHUTTER” button again.

The image and audio come back.

Using the digital zoom (– D.ZOOM +) function

A portion of the picture on the screen can be zoomed in with “– D.ZOOM +” buttons of the remote control. It is useful for highlighting a specific object during the presentation.

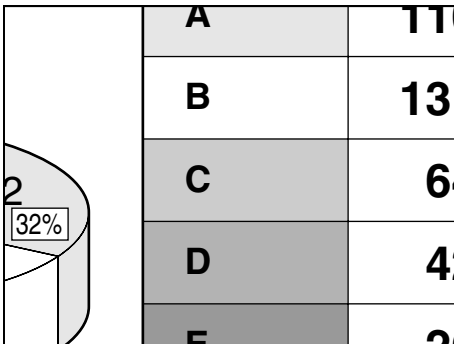
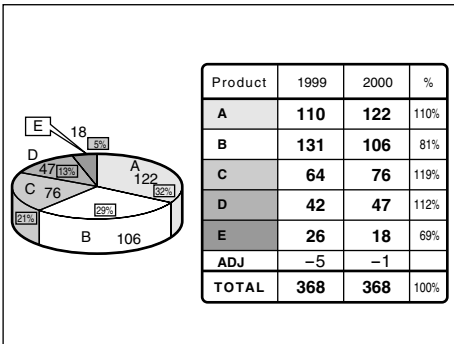

- ① **Press the “– D.ZOOM +” button of the remote control.**
The image is zoomed in.
- ② **Change the magnification with the “– D.ZOOM +” button.**
The magnification can be adjusted from 1.0 to 3.0 times.
- ③ **Use ▲ ▼ ◀ ▶ buttons to move the magnified image.**
- ④ **To restore the original image, press the “MENU” button.**

- Note**
- The digital zoomed state cannot be stored in memory.
 - If the input signal format is changed while in digital zoom mode, the projector will exit digital zoom function.
 - The combined magnification of “POSITION” zoom and digital zoom is 9.99 times maximum.

On-screen menus

■ Structure of menu screens

Menus are extensively used for configuring, adjusting or reconfiguring the projector. The menu structure is as follows:

MENU

MENU	
PICTURE	
POSITION	
ADVANCED MENU	
AUDIO	
LANGUAGE	
OPTION1	
OPTION2	
TEST PATTERN	
SECURITY	
NETWORK	
SELECT ENTER ENTER MENU EXIT	

NETWORK (page 38)

NETWORK	
HOST NAME	
DHCP	OFF
IP ADDRESS	
NET MASK	
GATEWAY	
MAC ADDRESS	
STORE	
SELECT ENTER ENTER MENU RETRN	

SECURITY (page 37)

TEST PATTERN (page 37)

OPTION2 (page 35)

OPTION2	
ID	ALL
FRONT/REAR	FRONT
DESK/CEILING	DESK
LAMP POWER	HIGH
RS232C	
SYSTEM INFORMATION	
FAN CONTROL1	NORMAL
FAN CONTROL2	HORIZ.
FUNC1	
KEY ASSIGN	NORMAL
AUTO POW. OFF	DISABLE
PASSWORD	
SELECT ADJ MENU RETRN	

OPTION1 (page 34)

OPTION1	
COLOR CORRECTION	
CONTRAST MODE	
AUTO SIGNAL	OFF
BACK COLOR	BLACK
SUB MEMORY LIST	
DVI EDID	EDID2:PC
SELECT ENTER ENTER MENU RETRN	

PICTURE (page 29)

For RGB signals

PICTURE	
PICTURE MODE	GRAPHIC
BRIGHT	32
CONTRAST	32
COLOR TEMP.	DEFAULT
WHITE GAIN	50
SHARPNESS	6
NR	OFF
AI	ON
SYSTEM	RGB
SELECT ADJ MENU RETRN	

For DVI signals

PICTURE	
PICTURE MODE	GRAPHIC
BRIGHT	32
CONTRAST	32
COLOR TEMP.	DEFAULT
WHITE GAIN	50
SHARPNESS	6
NR	OFF
AI	ON
SELECT ADJ MENU RETRN	

For S-Video/Video signals

PICTURE	
PICTURE MODE	STANDARD
BRIGHT	32
CONTRAST	32
COLOR	32
TINT	32
COLOR TEMP.	DEFAULT
WHITE GAIN	25
SHARPNESS	6
NR	OFF
AI	ON
TV-SYSTEM	AUTO1
SELECT ADJ MENU RETRN	

For YPbPr signals

PICTURE	
PICTURE MODE	STANDARD
BRIGHT	32
CONTRAST	32
COLOR	32
TINT	32
COLOR TEMP.	DEFAULT
WHITE GAIN	25
SHARPNESS	6
NR	OFF
AI	ON
SYSTEM	AUTO
SELECT ADJ MENU RETRN	

ADVANCED MENU (page 32)

ADVANCED MENU	
DIGITAL CINEMA REALITY	
BLANKING	
INPUT RESOLUTION	
CLAMP POS.	1
RASTER POSITION	
SXGA MODE	SXGA
SELECT ENTER ENTER MENU RETRN	

POSITION (page 31)

POSITION	
POSITION	
ASPECT	4:3
ZOOM	
CLOCK PHASE	16
KEYSTONE	
SELECT ENTER ENTER MENU RETRN	

LANGUAGE (page 33)

LANGUAGE	
ENGLISH	
DEUTSCH	
FRANCAIS	
ESPAÑOL	
ITALIANO	
日本語	
中文	
PYCCKM	
한국어	
SELECT ENTER ENTER MENU RETRN	

AUDIO (page 33)

AUDIO	
VOLUME	32
AUDIO MUTE	OFF
SELECT ENTER ENTER MENU RETRN	

On-screen menus

Basic menu operations

① Press the “MENU” button.

The MENU appears on the screen.

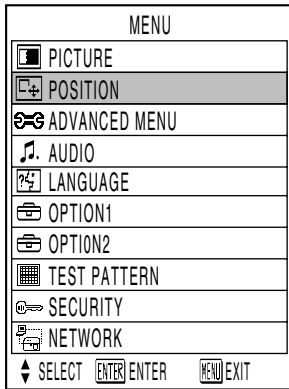

② Select (highlight) the desired item with the ▲ or ▼ buttons.

Selected items are displayed in blue.

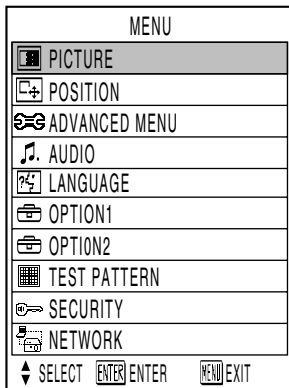

③ Press the “ENTER” button to enter your selection.

The submenu for the selected option will now open. (e.g. : PICTURE Menu)

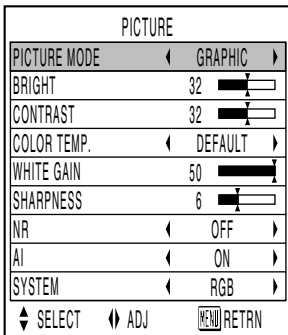

④ Highlight the desired adjustment item with the ▲ or ▼ buttons, then change the parameter value with the ◀ or ▶ buttons.

(Example of separate adjustment screen)



- If no button is operated for approx. 5 seconds while a bar graph is displayed, the screen will return to the previous page.

Returning to the previous page

- Pressing the “MENU” button returns the screen to the previous menu page.
- When the MENU is on the screen, pressing the “MENU” button clears all menus from the screen.

Menu items shown in transparent characters

- Some menu items may not be valid for certain signal formats applied to the projector. The menu items that cannot be adjusted or used are shown in transparent characters, and they cannot be selected even by pressing the ENTER button.

Menu items setting

- The bottom prompt line differs on each menu depending on the selected menu option:
 - A prompt “◀ ▶ ADJ” appears when changing the setting.
 - A prompt “ENTER ENTER” appears for a separate bar graph.
- When ▼ and ▲ buttons are displayed above or under the items in the “OPTION” screen, they indicate that there are more adjustment (items).

Resetting to the factory default

STD (standard) button is used to reset all of the projector adjustment values to the default levels which were set at the time of shipment from the factory.

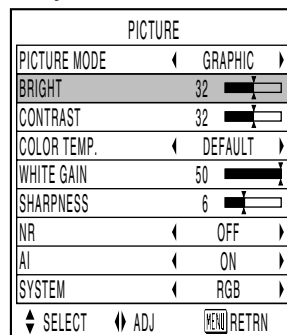

- If the parameter value on a bar graph is reset to the factory default, the bar turns to white.

Note

- The upper and lower triangular markings on a bar graph indicate the default setting for the parameter. If no such triangular markings are shown on the bar graph, the parameter cannot be reset to the factory default.

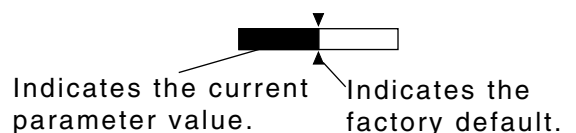

Adjusting the picture

• For RGB signals

PICTURE	
PICTURE MODE	◀ GRAPHIC ▶
BRIGHT	32
CONTRAST	32
COLOR TEMP.	◀ DEFAULT ▶
WHITE GAIN	50
SHARPNESS	6
NR	◀ OFF ▶
AI	◀ ON ▶
SYSTEM	◀ RGB ▶
⏴ SELECT ⏵ ADJ	

• For DVI signals

PICTURE	
PICTURE MODE	◀ GRAPHIC ▶
BRIGHT	32
CONTRAST	32
COLOR TEMP.	◀ DEFAULT ▶
WHITE GAIN	50
SHARPNESS	6
NR	◀ OFF ▶
AI	◀ ON ▶
⏴ SELECT ⏵ ADJ	

• For S-Video/Video signals

PICTURE	
PICTURE MODE	◀ STANDARD ▶
BRIGHT	32
CONTRAST	32
COLOR	32
TINT	32
COLOR TEMP.	◀ DEFAULT ▶
WHITE GAIN	25
SHARPNESS	6
NR	◀ OFF ▶
AI	◀ ON ▶
TV-SYSTEM	◀ AUTO1 ▶
⏴ SELECT ⏵ ADJ	

• For YPbPr signals

PICTURE	
PICTURE MODE	◀ STANDARD ▶
BRIGHT	32
CONTRAST	32
COLOR	32
TINT	32
COLOR TEMP.	◀ DEFAULT ▶
WHITE GAIN	25
SHARPNESS	6
NR	◀ OFF ▶
AI	◀ ON ▶
SYSTEM	◀ AUTO ▶
⏴ SELECT ⏵ ADJ	

■ PICTURE MODE

The picture mode can be selected from the following depending on viewing conditions and the video signal source in use:

- DYNAMIC** : Picture brightness/contrast ratio is increased to suit brighter viewing environments.
- GRAPHIC** : The picture becomes suitable for input from the personal computer.
- STANDARD** : The picture becomes suitable for moving images in general.
- CINEMA** : The picture becomes suitable for movie sources.
- NATURAL** : The picture becomes suitable for use in a dark room.

■ BRIGHT

“BRIGHT” is used to adjust the black level (brightness).

- ▶ : Raises the picture brightness.
- ◀ : Lowers the picture brightness.

■ CONTRAST

“CONTRAST” is used to adjust the contrast ratio.

- ▶ : Raises the contrast ratio.
- ◀ : Lowers the contrast ratio.

■ COLOR

(For S-Video/Video/YPbPr signals only)

- ▶ : Deepens colors.
- ◀ : Weakens colors.

■ TINT

(For S-Video/Video/YPbPr signals only)

“TINT” is used to adjust human skin.

- ▶ : Adjusts skin tone toward greenish color.
- ◀ : Adjusts skin tone toward reddish-purple.

■ COLOR TEMP.

The color temperature is adjusted when the white areas of images take on a reddish or bluish hue.

DEFAULT : Standard setting

HIGH : The white areas take on a more bluish-white hue.

MIDDLE : The white areas take on a slightly reddish hue.

USER : The RGB values of the white balance are set separately.

Press the ENTER button, select “W-BAL HIGH” or “W-BAL LOW”, and proceed with the detailed settings.

- ▶ : The colors of the selected item are darkened.
- ◀ : The colors of the selected item are lightened.

■ WHITE GAIN

The brightness of white parts of the image can be adjusted.

- ▶ : The intensity of white color increases.
- ◀ : Reverts to natural image.

Adjusting the picture

SHARPNESS

“SHARPNESS” is used to adjust the crispness of the image.

- ▶ : Sharpens the edge of the image.
- ◀ : Softens the edge of the image.

NR

In this mode, the video noise is reduced.
(For S-Video/Video/YPbPr signals)

- OFF : No correction
- ON : Noise reduction is set to ON.

(For RGB/DVI signals)

- OFF : No correction
- 1 : Low
- 2 : Middle
- 3 : High

AI

Gray scale control is exercised to suit the images, and optimal images with a clear contrast are projected.

- ON : Standard setting
- OFF : The AI mode is set to OFF.

TV-SYSTEM

(For S-Video/Video signals)

The setting that corresponds to the TV system is selected here.

AUTO1 : Standard setting
Automatically selects the TV standard that matches the input video signal, out of NTSC, PAL, NTSC4.43, SECAM and PAL60.

AUTO2 : Automatically selects the TV standard that matches the input video signal, out of NTSC, PAL-M, and PAL-N.

- Normally “AUTO1” or “AUTO2” should be chosen for this option.
- If the video signals are not displayed properly due to signal deterioration, choose the TV system that matches the input video signals.

Automatically selected by detecting the horizontal/vertical scan frequencies and color sub-carrier listed in the table below:

Signal System	H. Scan Frequency (kHz)	V. Scan Frequency (Hz)	Color Subcarrier (MHz)
NTSC	15.75	60.00	3.58
NTSC4.43	15.75	60.00	4.43
PAL	15.63	50.00	
PAL-M	15.75	60.00	3.58
PAL-N	15.63	50.00	
SECAM	15.63	50.00	4.25 or 4.41
PLA60	15.75	60.00	4.43

SYSTEM (For RGB/YPbPr signals)

This enables the RGB system or YPbPr system to be selected.

For the signals which are supported, refer to page 60.

Adjusting the position

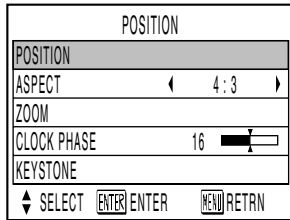

■ POSITION

The position where the images are displayed can be moved here.

- ◀ ▶ : The position is moved horizontally.
- ▲ ▼ : The position is moved vertically.

■ ASPECT

- AUTO** : (For S-Video/Video signals only)
If an S1 video signal is applied to the S-VIDEO port, the picture is automatically switched to the 16:9 aspect ratio. When video signals with a video ID (VID) are applied to the video port, the picture is automatically switched to the 16:9 aspect ratio.
- 16:9** : The image is vertically compressed into a 16:9 ratio.
- 4:3** : The aspect ratio inherent to the input video signal is left intact when projected onto the screen.
- S4:3** : Picture size is compressed to 75% of the original picture size when projected. (This mode is useful when viewing pictures with the standard 4:3 aspect ratio on a wide screen with the 16:9 aspect ratio.)

What is S1 Video?

- The S1 video is the wide-aspect-ready S-video format containing an aspect sense signal for squeezed videos fed from video equipment.
- If "AUTO" is chosen, the projector automatically compresses the squeezed input video into the 16:9 aspect ratio if it detects the aspect sense signal.

Attention • If you choose an aspect ratio that does not match the source video's aspect ratio, you will see a picture with an aspect ratio not the same as that of the original picture. Choose the appropriate aspect ratio carefully to match that of the original picture.

- Note**
- If the picture size is compressed or enlarged by using the 16:9 aspect ratio when the projector is used for profitable purpose or in the presence of an audience (for example, in a coffee shop or at a hotel etc.), it may infringe the rights of the copyright owner of the original picture.
 - If a picture with the standard (4:3) aspect ratio is projected at a wide aspect ratio, parts of the picture may run over the screen bounds or the overall picture may be distorted. To view the picture at its original aspect ratio, choose the standard 4:3 aspect ratio.

■ ZOOM

This enables the enlargement ratio to be changed and the resulting enlarged image displayed.

- ◀ ▶ : The enlargement ratio in the horizontal direction is changed.
- ▲ ▼ : The enlargement ratio in the vertical direction is changed.

■ CLOCK PHASE

(For RGB/YPbPr signals only)

Clock phase adjustment allows the user to minimize visible noise with the ◀ or ▶ button.

- Note**
- When projecting signals whose dot clock frequency is 108 MHz or higher, the noise may not disappear even when the clock phase is adjusted.
 - Clock phase adjustment is not available for digital RGB signals.

■ KEYSTONE

KEYSTONE : Keystone distortion can be corrected only along either horizontal bound of the picture.

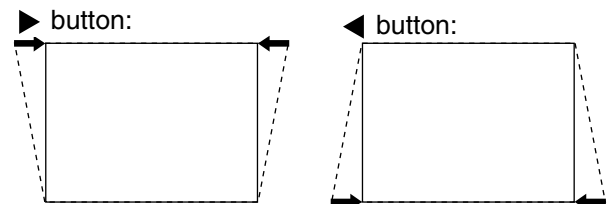

- Note**
- Keystone distortion can be corrected to $\pm 30^\circ$ of the angle of tilt for the projector. However, the greater the correction amount, the more the picture quality will deteriorate, and the harder it will become to achieve a good level of focus. To obtain the best picture quality, set up the projector and screen in such a way that the amount of keystone correction required is as minimal as possible.
 - The picture size will also change when correction of keystone distortion is carried out.

LINEARITY : After you are finished with keystone adjustment, adjust vertical linearity with the ◀ or ▶ button. Linearity is not adjustable if no correction was made to keystone distortion.

How to use ADVANCED MENU

ADVANCED MENU	
DIGITAL CINEMA REALITY	
BLANKING	
INPUT RESOLUTION	
CLAMP POS.	1
RASTER POSITION	
SXGA MODE	◀ SXGA ▶
⏴ SELSCT	ENTER ENTER
	MENU RETRN

■ DIGITAL CINEMA REALITY

(Only for input of S-Video/ Video/ YPBPR [480i, 576i] signals.)

ON: Set at ON when you need to faithfully capture images shot at 24 frames per second as in movies.

OFF: Set at OFF when unnatural images are obtained in the ON status.

■ BLANKING

You can perform fine adjustments for blanking if noise appears at the ends of the screen or the image protrudes out of the screen during image projection using a video deck and so on.

▲ ▼ : Select the UPPER, LOWER, LEFT or RIGHT adjustment.

◀ ▶ : Adjust the blanking width.

For upper adjustment

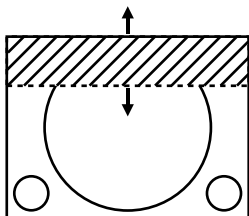

For lower adjustment

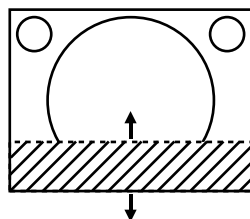

For left adjustment

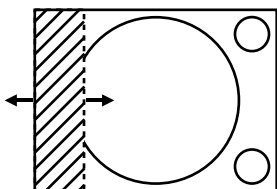

For right adjustment

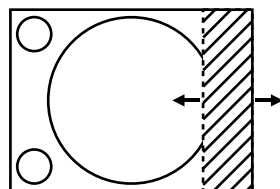

■ INPUT RESOLUTION

Input resolution adjustment achieves the best image when the screen flickers or halo is observed around the contour.

▲ ▼ : These select the items listed below.

◀ ▶ : These select the value.

“TOTAL DOTS”, “DISPLAY DOTS”, “TOTAL LINES” and “DISPLAY LINES”

Each item automatically displays a value in response to the type of the input signal. If vertical stripes appear on the screen or the image is partly missing, increase or decrease the displayed value while observing the screen to achieve the optimal value.

Note

- The abovementioned vertical stripes will not appear on the screen when all signals are input.
- The picture may be distorted during the adjusting operation, but this is not a fault.
- The input resolution can be adjusted only when RGB signal input is applied with RGB1 and RGB2 IN.

■ CLAMP POS.

(For RGB/ YPBPR signals only)

Use the clamp position adjustment to achieve the optimal value when dark areas of the image are crushed or displayed in green.

Adjust with the ◀ ▶ buttons.

The value changes from 1 to 255.

The optimal value for the clamp position adjustment

- If dark areas are crushed:
 - The optimal value is the point where the dark area is best improved.
- If the dark areas are displayed in green:
 - The optimal value is the point where the green area becomes dark and clear.

Note

- The clamp position can be adjusted only when the RGB signal input is applied with RGB1 and RGB2 IN.

■ RASTER POSITION

When the whole area where the input picture can be displayed is not used, the picture can be moved to any position inside the display area.

◀ ▶ : These adjust the value in the horizontal direction.

▲ ▼ : These adjust the value in the vertical direction.

■ SXGA MODE

This mode takes effect only when SXGA (RGB) signals are input.

SXGA : Standard setting

SXGA+ : Select this when the screen is cut off.

Adjusting the audio

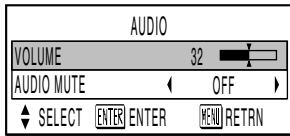

■ VOLUME

You can adjust the sound volume.

- ◀ : Sound volume decreases.
- ▶ : Sound volume increases.

■ AUDIO MUTE

You can activate/deactivate audio.

- ON: Audio is muted (you hear no sound).
- OFF: Audio is activated (you can hear sound).

Note • No audio will be output when video signal is not displayed.

Changing the display language



Currently chosen language is displayed here.

Menus, setting items, adjustment screens, and control button names will be displayed in the language the user chooses.

The available languages are:

ENGLISH, DEUTSCH, FRANÇAIS, ESPAÑOL, ITALIANO, 日本語, 中文, РУССКИЙ, 한국어.

Note • The projector's on-screen display is set to the English language by default.

OPTION1 settings

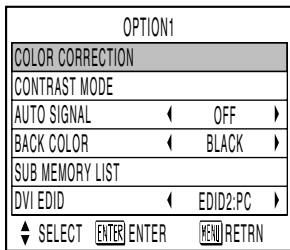

■ COLOR CORRECTION

- OFF : Standard setting
- USER : The six colors of red, green, blue, cyan, magenta and yellow can be adjusted and registered for each of four signal systems: Video, S-Video, RGB and YPbPr.

Press the “ENTER” button to make the detailed settings.

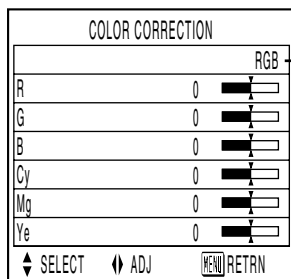

The current signal system is displayed.

■ CONTRAST MODE

There are two modes for adjusting to the operating environment.

- NORMAL : The contrast is set to normal and the brightness to maximum.
- HIGH : The contrast is set to maximum and the brightness to normal.

■ AUTO SIGNAL

The position where the screen is displayed can be adjusted automatically without pressing the AUTO SETUP button on the remote control each time signals are input when signals are input frequently such as when the projector is used at a conference.

- ON : Auto setup is performed automatically when the video signals of the images being projected have changed.
- OFF : The input auto setup function is set to OFF.

■ BACK COLOR

You can set the colors of the screen when no signal is input to the projector.

- BLUE: Set screen color to blue.
- BLACK: Set screen color to black.

■ SUB MEMORY LIST

Multiple sets of image adjustment data (PICTURE, POSITION, ADVANCED MENU adjustment values) for the same kind of signal can be registered.

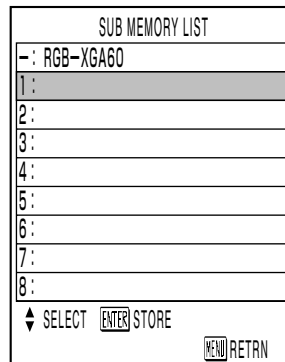

Registering in sub memory

- ① Select the sub memory number to be registered using the ▲ ▼ button.
- ② Press the ENTER button.

Note • Sub memories range from 1 to 8.

How to select sub memory

- ① Select sub memory number (1 to 8) using the ▲ ▼ buttons. Select “-” if you do not wish to use the sub memory.
- ② Press the ENTER button.

Note • You cannot select sub memory of a different signal system.

How to erase sub memory

- ① Select sub memory number (1 to 8) corresponding to sub memory to be erased using ▲ ▼ buttons.
- ② Press the STD button.
- ③ When the indicator of sub memory to be erased flashes, press the ENTER button.

■ DVI EDID

Set EDID to match the device connected.

Mode	Matching Signal
EDID1	480p, 576p, 720/60p, 1080/60i, 1080/50i
EDID2:PC	VGA480/60, SVGA/60, XGA/60, XGA/70, XGA/85, SXGA/60

OPTION2 settings

OPTION2	
ID	◀ ALL ▶
FRONT/REAR	◀ FRONT ▶
DESK/CEILING	◀ DESK ▶
LAMP POWER	◀ HIGH ▶
RS232C	
SYSTEM INFORMATION	
FAN CONTROL1	◀ NORMAL ▶
FAN CONTROL2	◀ HORIZ. ▶
FUNC1	
◆ KEY ASSIGN	◀ NORMAL ▶
AUTO POW. OFF	◀ DISABLE ▶
PASSWORD	
◆ SELECT	◀ ADJ
	◀ MENU ▶ RETRN

■ ID

The projector has an ID number setting function that helps the user to control two or more projectors either simultaneously or separately with a single remote control. **The ID number is set to “ALL” by default. Hence the ID number need not be set when only one projector is used.**

1–64 : The ID number is set in this range.

- Note**
- The ID number can be set to “ALL”, or selected from “1” to “64”.
 - If the projectors are given ID numbers, their remote controls must be assigned the same ID numbers, respectively.
 - If the ID number of a projector is set to “ALL”, it can be controlled by the remote control or the PC with any ID number.
- If multiple projectors are used and some of them have their IDs set to “ALL”, they cannot be controlled separately from the projectors with other ID numbers.
- For details on remote control ID setting, see page 15.

■ FRONT/REAR

“FRONT/REAR” is used to choose the appropriate projection scheme from Front and Rear:

- FRONT** : Choose this option if pictures are projected from the front of a reflective screen.
- REAR** : Choose this if pictures are projected from the back of a translucent screen.

■ DESK/CEILING

DESK/CEILING is used to choose the appropriate projection scheme from Desk and Ceiling:

- DESK** : Choose this option if the projector is installed on a floor-standing base.
- CEILING** : Choose if the projector is installed on the ceiling using the optional ceiling mount bracket.

■ LAMP POWER

The luminance of the projection lamp can be changed depending on user’s needs or the viewing conditions.

- HIGH** : Set when high brightness is necessary.
- LOW** : Set when high brightness is not necessary.

- Note**
- When set to “LOW”, it is possible to reduce power consumption, reduce operating noise and extend lamp service life.
 - “LOW” is set automatically when long life lamp units are used.

■ RS232C

This sets the communication parameters at the serial terminals.

For details on the serial terminals, refer to “Using the serial terminals” (page 39).

- BAUDRATE** : 9 600, 19 200 or 38 400 is selected.
- PARITY** : NONE, EVEN or ODD is selected.

■ SYSTEM INFORMATION

The projector’s system information can be viewed.

SYSTEM INFORMATION	
ROM VERSION	1.00.00
SET RUNTIME	300h
LAMP LOW	100h
HIGH	200h
TOTAL	300h
LAMP ON	20
LAMP TYPE	LAD35
	◀ MENU ▶ RETRN

■ FAN CONTROL1

The fan can be controlled in accordance with the operating conditions.

- NORMAL** : Standard setting
- HIGHLAND** : This is selected when using the projector at an altitude of over 1 400 meters.

OPTION2 settings

■ FAN CONTROL2

The fan can be controlled in accordance with the direction in which the images are to be projected.

HORIZ. : Standard setting

VERTICAL : This is selected when projecting images at a significant angle toward the vertical (more than 30 degrees from the horizontal).

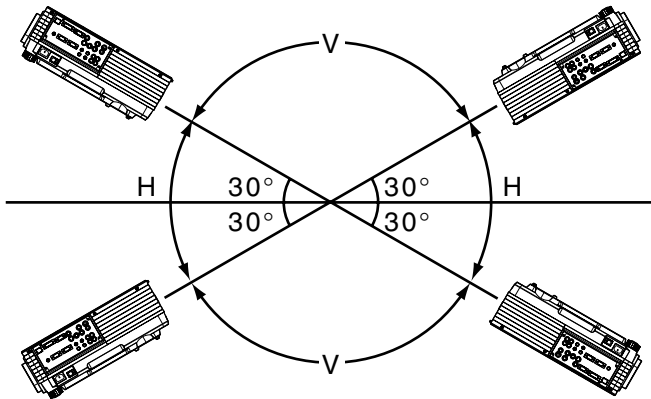

H: HORIZ.

V: VERTICAL

Attention • Select the correct FAN CONTROL2 setting in accordance with the direction in which the images are to be projected. Using the projector at the wrong FAN CONTROL2 setting will shorten the service life of the lamps.

■ FUNC1

You can set the functions of the FUNC1 button of the remote control.

LAMP POWER: This button has the same functions as "LAMP POWER" of "OPTION2."

ASPECT: This button has the same functions as "ASPECT" of "POSITION."

SUB MEMORY LIST: This button has the same functions as "SUB MEMORY LIST" of "OPTION1."

AUDIO: This button has the same functions as "AUDIO."

■ ◆ KEY ASSIGN

You can set the functions of the ▲ ▼ buttons of the remote control when the menu screen is not displayed.

NORMAL: You can deactivate the ▲ ▼ buttons when the menu screen is not displayed.

VOLUME: You can adjust the sound volume using the ▲ ▼ buttons when the menu screen is not displayed.

■ AUTO POW.OFF

The projector can be automatically set to the standby mode if no signals are input for the set duration.

DISABLE : Standard setting. This function is set to OFF.

15MIN.–60MIN.: The duration can be set in 5-minute increments from 15 to 60 minutes.

Note • The auto power OFF function does not work while the freeze function is used.

■ PASSWORD

This function is used when a service person. Input the password with the numeric buttons (0 to 9) of the remote control and press ENTER button to confirm the entry.

Displaying the internal test pattern

The projector has eight types of internal test patterns to check the condition of the set. To display test patterns, follow the steps below.

Note • Results of adjustment on the image, picture quality, position, size and other factors will not be reflected in test patterns. Be sure to display the input signal before performing various kinds of setting.

◀ ▶ : Search through the various types of test patterns

■ Cycle of displayed internal test patterns

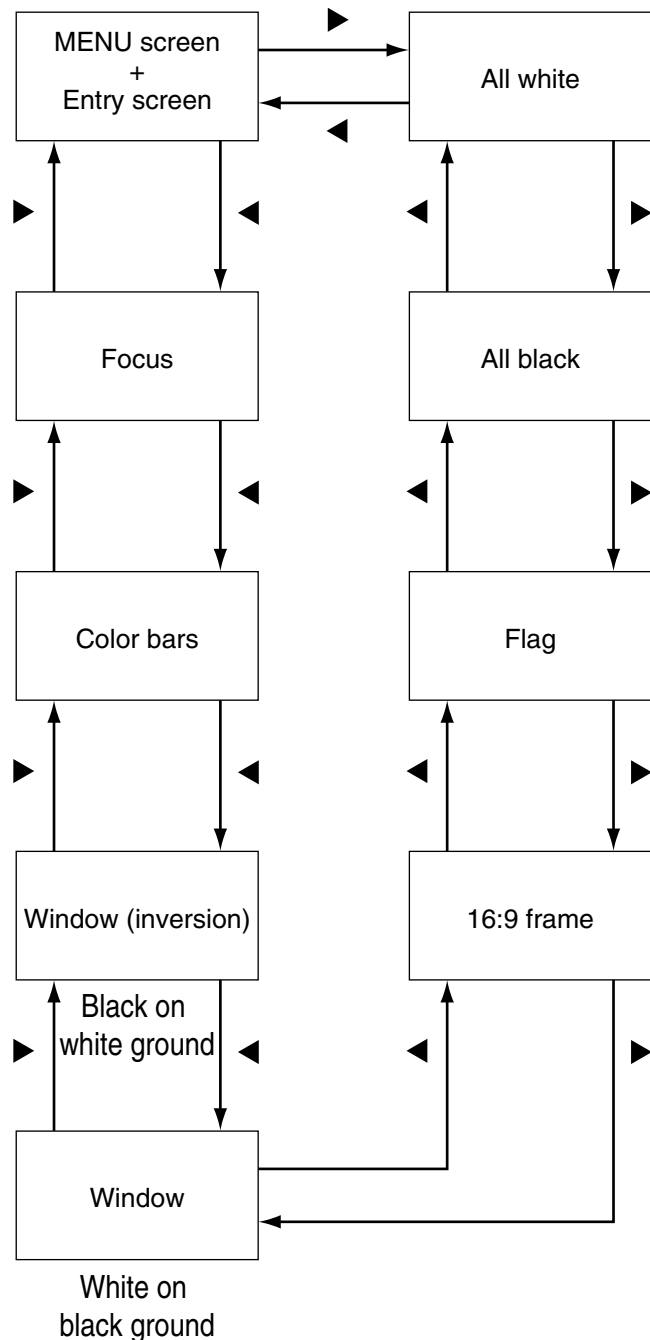

Setting the security

The projector's security function enables the password input screen to be displayed or a company's URL address to be set and displayed underneath the projected images.

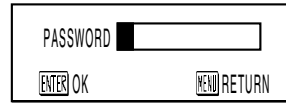

(When using the projector for the first time)
Press the ▲, ▶, ▼, ◀, ▲, ▶, ▼ and ◀ buttons in this order, and press the ENTER button.

(When the password has been changed)
Input the new password, and press the ENTER button.

■ INPUT PASSWORD

It is possible to display the password input screen each time the power is turned on. If this option is used, no operations except for the POWER button can be performed without inputting the correct password.

ON : Password input is enabled.
OFF : Password input is disabled.

■ AMEND PASSWORD

The password can be changed. Press the ENTER button.

- ① Set the password using the ▲ ▼ ◀ ▶ buttons (up to 8 buttons can be set).
- ② Press the ENTER button.
- ③ Confirm the password by inputting it again.
- ④ Press the ENTER button.
(This completes the settings.)

Note • Asterisks (*) will appear on the screen in the place of the actual password when the password is input.
• If the wrong password is input, the letters for "Password", "New", etc. appear in red. Input the correct password.

■ TEXT DISPLAY

The text which has been set can be displayed underneath the projected images all the time.

ON : The text display is enabled.
OFF : The text display is disabled.

■ TEXT CHANGE

The text which is to be displayed when ON has been selected for the text setting can be changed. Press the ENTER button.

- ① Select the text using the ▲ ▼ ◀ ▶ buttons, and press the ENTER button. (Up to 22 alphanumeric characters can be input in succession.)
- ② Select "OK" using the ▲ ▼ ◀ ▶ buttons, and press the ENTER button.

• To cancel the change at any time, select Cancel.

Setting the network

The settings required for the network must be established in order to use the web browser (page 47) functions that the PC uses to control the projector.

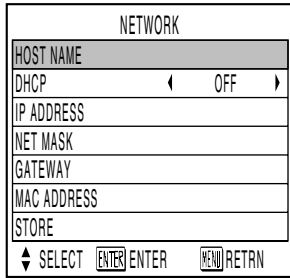

- HOST NAME** : Make alteration if necessary when to use the DHCP server.
- DHCP** : Set the DHCP item to ON when to acquire an IP address automatically using the DHCP server.
Set to OFF if DHCP server is not used.
- IP ADDRESS** : Enter the IP address if DHCP server is not used.
- NET MASK** : Enter the net mask if DHCP server is not used.
- GATEWAY** : Enter the gateway address if DHCP server is not used.
- MAC ADDRESS** : Displays the MAC address (Media Access Control Address), which is proper to the network device.
This function may be needed when to use the DHCP server.
- STORE** : The settings are stored in the memory.

- Attention**
- Before using the DHCP server, make sure the DHCP server is already functioning.
 - For details of IP address, net mask, and gateway, ask the network administrator.

Connecting the PC

System requirements

The following system specifications are required in order to use the networking functions.

- **PC**
 - OS : Windows XP/2000/Me (Millennium Edition)/98SE (Second Edition)
 - CPU : Pentium III processor or faster
 - RAM : 64 MB or more (128 MB or more for Windows XP/2000)
 - Web browser: Internet Explorer 6.0 or newer, Netscape Communicator 7.0 or newer

- **LAN cable**
 - Type : Category 5 compatible straight cable
 - Length: 100 meters or less

Attention • If you want to use the e-mail function, make sure the system can handle e-mail.

Operation is not guaranteed for all computers that meet the above conditions.

Connection example

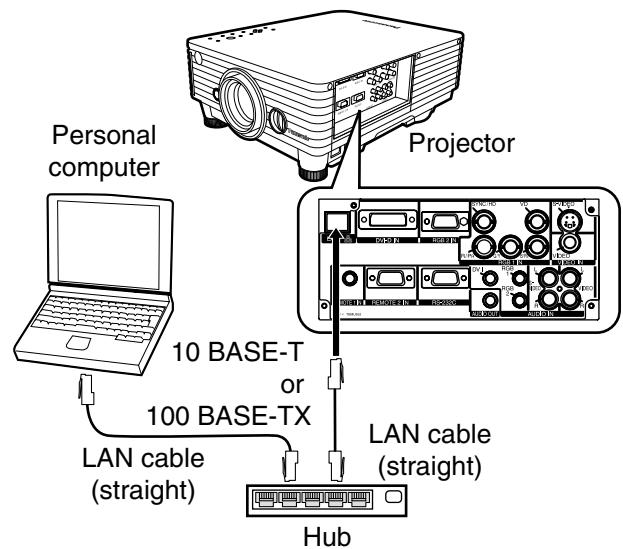

Attention • Touching the LAN port with your hand (or body) when you are carrying a static charge may damage the equipment due to a discharge of static electricity. Therefore, be careful not to touch the LAN port or metal parts of the LAN cable.

Using the serial terminals

The main unit is equipped with SERIAL terminals located in its terminal section on the side, and this terminal is compliant with RS232C.

Examples of connection

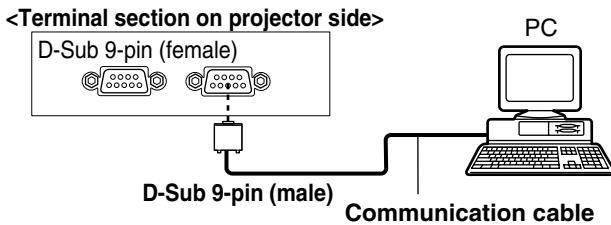

Pin assignments and signal names

D-Sub 9-pin (female), external appearance

Serial input terminal

Pin No.	Signal name	Description
①		NC
②	TXD	Send data
③	RXD	Receive data
④		Connected internally
⑤	GND	Ground
⑥		NC
⑦	CTS	Connected internally
⑧	RTS	Connected internally
⑨		NC

Communication conditions (Factory setting)

Signal level	RS232C compliant
Synchronization method	Start-stop synchronization
Baud rate	9 600bps
Parity	None
Character length	8 bits
Stop bit	1 bit
X parameter	None
S parameter	None

Basic format

Transmission from the computer begins with STX, then the ID, command, parameter, and ETX are sent in this order. Add parameters according to the details of control.

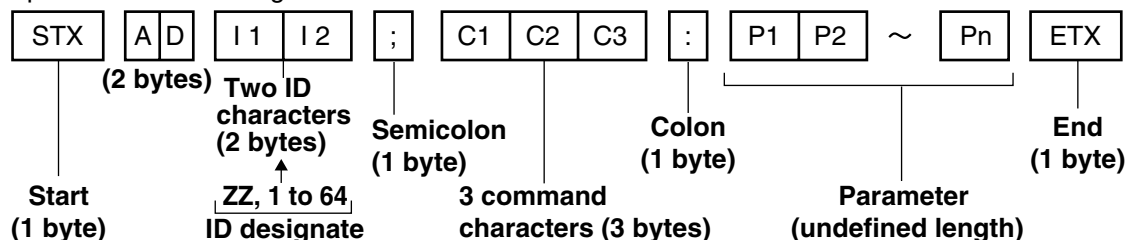

- Attention**
- No command can be sent or received for 10 to 60 seconds after the lamp starts lighting. Try sending any command after that period has elapsed.
 - When sending several commands, be sure to wait for a response from the projector before sending the next command. When sending commands without parameters, a colon (:) is not necessary.

- Note**
- If a wrong command is received, the projector will send an "ER401" command to the computer.
 - Projector ID supported on the RS232C interface is ZZ (ALL) and a group of 1 to 64.
 - If a command is sent with a projector ID specified, the projector will return answer back only in the following cases:
If it coincides with the projector ID, or ID specification is ALL .

Using the serial terminals

■ Control commands

When controlling the projector from a computer, the following commands are available:

Command	Function of command	Remarks
PON	Power "ON"	In standby mode, commands other than "PON" are invalid.
POF	Power "OFF"	
I I S	Switch input modes	Parameter VID = VIDEO SVD = S-VIDEO RG1 = RGB1 RG2 = RGB2 DVI=DVI
OSH	Shutter function	Parameter 0 = Off, 1= on
AVL	Volume	Parameter 0-63
OLP	Lamp power setting	Parameter 0 = HIGH, 1= LOW

Note • If you need a detailed command list, please contact your dealer.

■ Cable specifications

<Connecting to a PC>

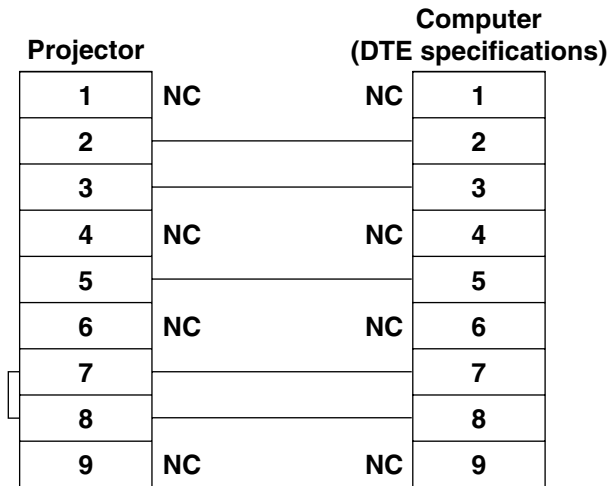

Attention • To connect the computer to the SERIAL terminal, prepare an adequate communication cable that fits to your personal computer.

Using the REMOTE 2 terminal

Using the REMOTE 2 terminal provided on the side of the main unit, it is possible to operate the projector from a control panel etc. furnished in a distant location where infrared remote control signal cannot be received.

Example of a control panel layout

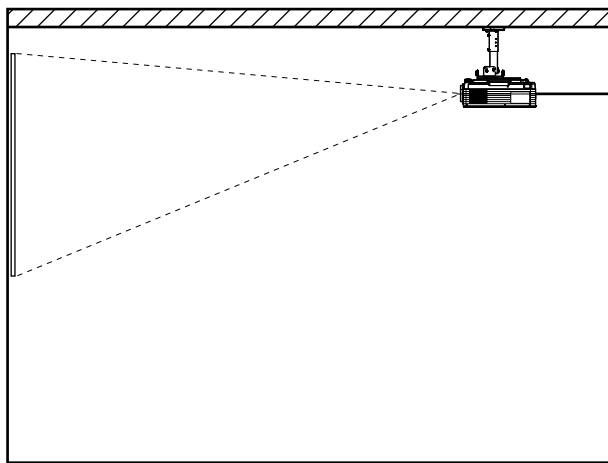

Projector set up in a meeting room

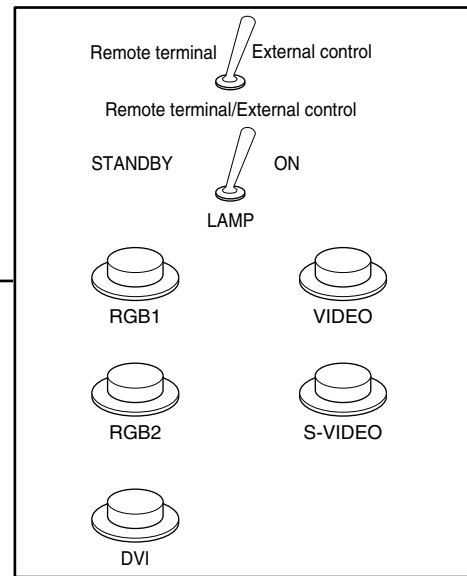

Control panel located in a different room

Pin assignments and control

Be sure to short-circuit Pins ① and ⑨ when controlling.

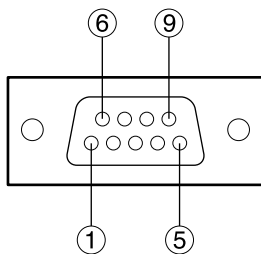

**D-Sub 9-pin (female)
external appearance**

	Names of terminals	Open (H)	Short (L)
①	GND	—————	GND
②	POWER	OFF	ON
③	RGB1	Other	RGB1
④	RGB2	Other	RGB2
⑤	VIDEO	Other	VIDEO
⑥	S-VIDEO	Other	S-VIDEO
⑦	DVI	Other	DVI
⑧	SHUTTER	OFF	ON
⑨	RST / SET	Controlled by remote control	Controlled by external contact



Note

- The following buttons on the remote control and the operation area of the projector can no longer be operated when pins ① and ⑨ are shorted: POWER button and SHUTTER button. Neither will it be possible to use the RS232C commands or network functions corresponding to these functions.
- If you short pin ① and pin ⑨, and also short one of the pins from ③ to ⑦ and pin ①, then the following buttons on the projector operating area and the remote control can no longer be operated: POWER button, RGB button (RGB1, RGB2 and DVI buttons in case of remote control), VIDEO button (VIDEO and S-VIDEO buttons in case of remote control) and SHUTTER button. Neither will it be possible to use the RS232C commands or network functions corresponding to these functions.

Indication of lamp monitor

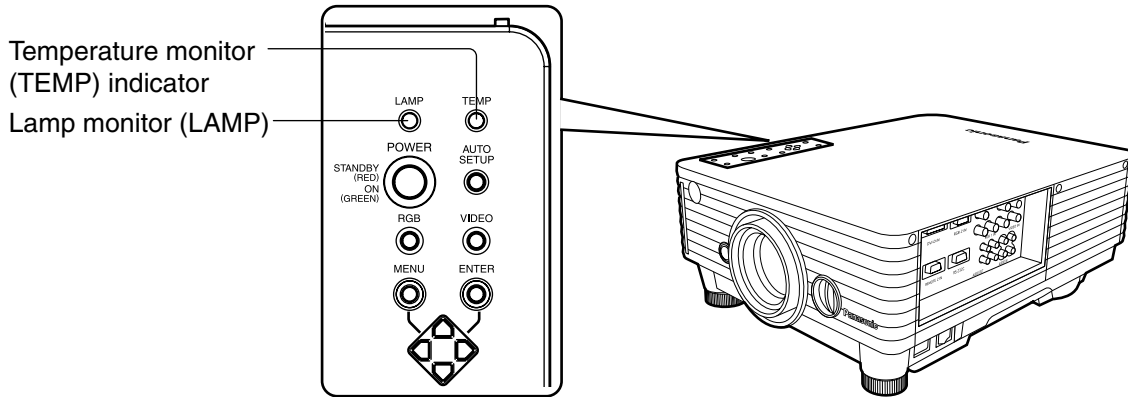
This projector is equipped with 2 indicators to show when a lamp needs replacement or there is an abnormal internal temperature. These lamps flash or light up to indicate a problem. Turn the power off and follow the steps below.



Name of monitor lamp	Lamp indication	Information	Checkpoint	Remedial measure
Temperature monitor TEMP 	Lighting in red (lamp unit ON)	Warm-up status	<ul style="list-style-type: none"> Did you turn on the power when the ambient temperature was low (approx. 0 °C)? 	<ul style="list-style-type: none"> Wait about five minutes in the current status. Install the unit in a location having an ambient temperature from 0 to 40 °C.
	Blinking in red (2 times)	High temperature inside. (WARNING)	<ul style="list-style-type: none"> Check if the ventilation port is blocked. Is the room air temperature too high? Check the air filter for clogging. 	<ul style="list-style-type: none"> Remove the object that is blocking the ventilation port. Move the projector to a temperature of 0 to 40 °C and the humidity of 20 to 80% (no condensation). Turn off the MAIN POWER switch using the procedure on page 23 and clean the air filter (refer to page 43).
	Blinking in red (3 times)	Cooling fan has been stopped.	_____	<ul style="list-style-type: none"> Turn off the main power supply (MAIN POWER) switch in the procedure shown on page 23 and consult the distributor.
Lamp monitor LAMP 	Lighting in red	Indicates the time for replacing the lamp unit.	<ul style="list-style-type: none"> Did you notice a "REPLACE THE LAMP" message on the screen when turning on the projector power supply? 	<ul style="list-style-type: none"> This lamp monitor lights up when the lamp unit used hours have reached 1 300 hours (3 800 hours when long life lamp units are used). Request the dealer to replace the lamp unit.
	Blinking in red (3 times)	Error is detected in the lamp circuit.	<ul style="list-style-type: none"> Did you turn the power back on immediately after turning it off? Some error has arisen in the lamp circuit. Check for fluctuation (or drop) in the source voltage. 	<ul style="list-style-type: none"> Wait until the lamp has cooled off, and then turn on the power. Turn off the MAIN POWER switch using the procedure on page 23 and consult the dealer.

- Attention**
- To solve any problems that the TEMP and LAMP monitor show, first turn the power off by following the steps on pages 22, 23.
 - If the power indicator blinks in red (3 times), the projector has malfunctioned. Please consult your dealer.

Cleaning and replacement of air filter

If too much dust is deposited in the air filter, temperature inside the main unit will rise and the temperature monitor (TEMP) blinks, eventually turning off the power supply.

Clean the air filter section once every 100 hours or so as a guideline depending on the location of projector operation.

■ Procedure of cleaning

① Turn off the main power and remove the power plug from the receptacle.

Turn off the main power supply observing the procedure (How to turn "OFF" the power supply) on page 23 and then remove the power plug.

② Dismantle the air filter.

Use your finger to pull the air filter tab toward you, and remove it from the main unit.

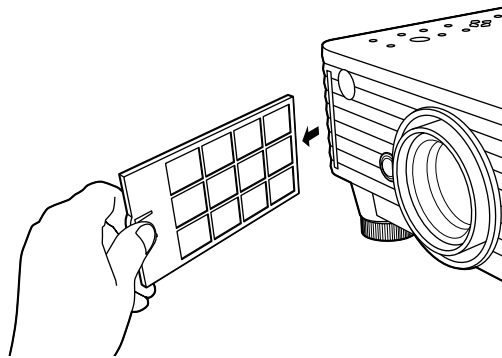

③ Clean the air filter.

Suck off deposited dust with a vacuum cleaner.

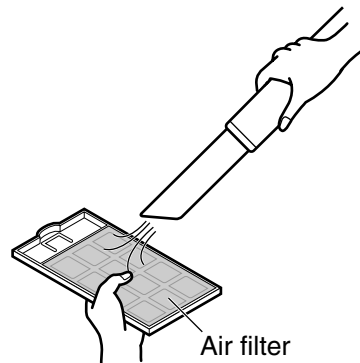

Attention • Do not suck in the air filter itself.

④ Set the air filter.

Set the air filter in the reverse order to step ②.

Attention

- Install the filter material (looks like sponge) such that it is positioned on the left side when you face the filter.
- The air filter must be fitted in place when using the projector.
Using the projector without the air filter fitted inside, dirt and dust are sucked into the projector, causing failure.

Note • If cleaning cannot remove the dust completely, then it is a sign to replace the air filter. Consult the dealer. In addition, when the lamp unit is replaced, also replace the air filter.

Replacing the lamp unit

WARNING!

Replacement of the lamp unit should only be carried out by a qualified technician.

WARNING!

When replacing the lamp, allow it to cool for at least one hour before handling it.

Precautions on lamp unit replacement

Remove the power plug and confirm that the surroundings of the lamp unit have cooled off.

- Be careful when handling a light source lamp. The lamp unit has high internal pressure. If improperly handled, explosion might result.
- A used lamp unit may burst if it is handled violently.
For disposition of used lamps, request an industrial waste disposal contractor.
- Do not reset the cumulative time, except when the lamp unit has been replaced with a new unit.
- If you continue to use a lamp after the replacement time, the lamp may break.
- Philips screwdriver is necessary when replacing a lamp unit.
Take care not to slip your hand when using a screwdriver.

Attention

- A lamp unit is an optional part. Contact the dealer.
Replacement lamp unit model No.: ET-LAD35 (single bulb)
Rating: 300W
Long life lamp unit model No.: ET-LAD35L (single bulb)
Rating: 160W
- Other lamps than specified above cannot be used. Be sure to use the specified lamp.

■ Timing of lamp unit replacement

The lamp used for the light source has its due life. The life of light source lamp used in the main unit is 1 500 hours*¹ (when lamp output is HIGH). However, it may happen that the lamp becomes dead (will not light) by the time of 1 500 hours*¹ depending on the characteristics of individual lamps and working conditions (lamps may reduce their life affected by the times of lighting and the intervals between previous lighting and next lighting). Therefore, it is strongly recommended for the user to keep a spare bulb.

If your lamp unit is not replaced after 1 300 hours*² (with the lamp output set at "HIGH"), power supply will be turned off automatically at the time of 1 500 hours*¹, entering a standby state. After 1 500 hours*¹ of initial lighting, power supply is turned off automatically about 10 minutes later, entering a standby state even if it is turned on again.

● Indication after 1 300 hours*² (with the lamp output set at "HIGH")

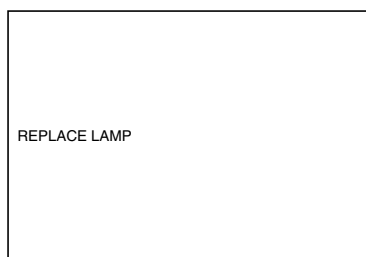

When lamp unit used hours have reached 1 300 hours*², lamp monitor (LAMP) light up including standby state.

Further, an on-screen indication will appear for about 30 seconds as shown in the diagram on the left, recommending replacement of lamp unit. (The indication on the left diagram will disappear after about 30 seconds or when either control button on the upper panel of main unit or remote control button is operated.)

After the time of 1 500 hours*¹, the on-screen indication will not disappear unless the menu (MENU) button is operated.

*¹ This time period is 4 000 hours when long life lamp units are used.

*² This time period is 3 800 hours when long life lamp units are used.

■ Lamp unit replacement steps

Attention • After 1 500 hours (4 000 hours when long life lamp units are used) of operating the same lamp, it is only possible to operate the unit for approximately 10 minutes. Steps ⑧ to ⑬ must be completed within 10 minutes.

- ① **Turn the power off by following the steps on page 23, remove the power plug and confirm that the surroundings of the lamp unit have cooled off.**

Check that the fan has stopped running.

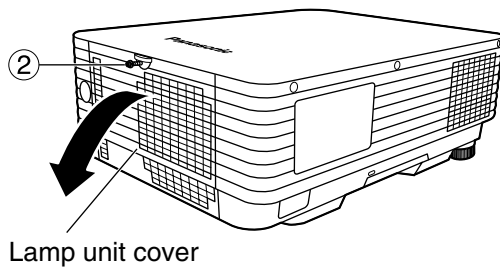

Have a Phillips screwdriver ready ahead of time.

- ② **Loosen one screw securing the lamp unit cover, and then open the lamp unit cover.**

Note • You can temporarily secure the lamp unit cover in the opened condition. By sliding the cover in the direction of the arrow, you can temporarily secure the cover or release the temporarily-secured cover.

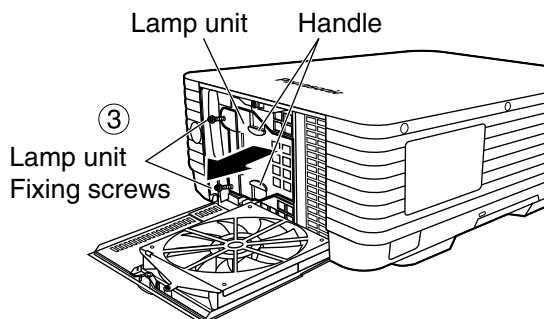
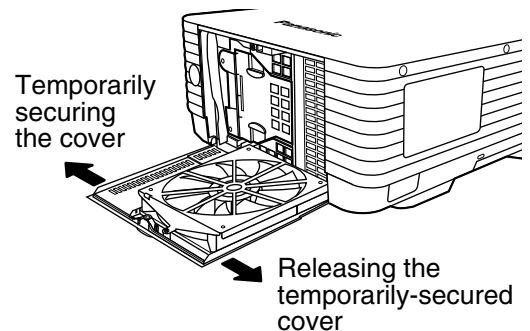

- ③ **Loosen two lamp unit fixing screws, take hold of the handles, and remove the lamp unit.**

- ④ **Install the new lamp unit.**

Insert the lamp unit by pressing it applying equal force on both left and right sides.

- ⑤ **Use a Phillips screwdriver to securely tighten the two lamp unit fixing screws.**

- ⑥ **Close the lamp unit cover by pushing the upper-right corner until it clicks. Firmly tighten the one screw securing the lamp unit cover.**

Caution

The lamp unit will be hot after it has been used.

You might get burned if you touch it while it is still hot.

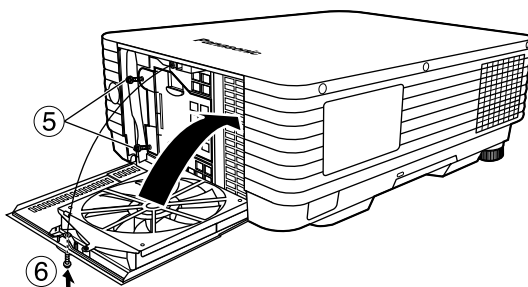

Attention • Firmly install the lamp unit and lamp unit cover. If not installed firmly, a protection circuit will function and the power will not be turned on.

Replacing the lamp unit

- ⑦ Insert the power cord plug into the wall outlet and then press the MAIN POWER switch.

Attention • If the power does not turn on even after turning the MAIN POWER switch “I”, turn the MAIN POWER “O”, confirm that the lamp unit and door are installed correctly, and turn on again.

- ⑧ Press the “POWER” button (or the POWER OFF (I) button on the remote control) so that a picture is projected onto the screen.

MENU	
PICTURE	
POSITION	
ADVANCED MENU	
AUDIO	
LANGUAGE	
OPTION1	
OPTION2	
TEST PATTERN	

- ⑨ Press the “MENU” button to display the MENU screen, and then press the ▲ and ▼ buttons to move the cursor to select “OPTION2”.

SYSTEM INFORMATION	
ROM VERSION	1.00.00
SET RUNTIME	300h
LAMP LOW	100h
HIGH	200h
TOTAL	300h

- ⑩ Press the “ENTER” button to display the “OPTION2” screen, and select “SYSTEM INFORMATION” with the ▲ and ▼ buttons.

- ⑪ Press the “ENTER” button.

The SYSTEM INFORMATION screen will be displayed.

LAMP TIME RESET	
LAD35	1433h
LAD35L	0h

- ⑫ Press and hold the “ENTER” button on the projector or the remote control for approximately 3 seconds.

An item “LAMP TIME RESET” will be added.

- ⑬ Press the ENTER button, and when the “LAMP TIME RESET” display flashes, press the ENTER button again.

The used hours of the lamp unit will be reset to zero.

Note • When the “LAMP TIME RESET” display flashes, the lamp time reset can be canceled by pressing the MENU button.

Using Web Browser Control

This projector has networking functions which allow it to be controlled through a web browser on a PC.

The controlled items are:

- Projector's settings and adjustment
- Projector's status display
- Transmission of a E-mail message when the projector has a problem

■ Accessing from the Web browser

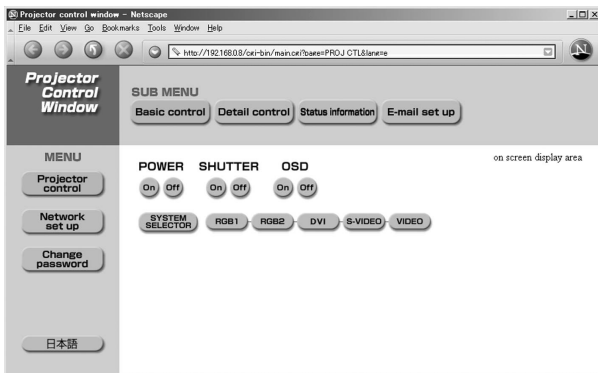

① Start the web browser on your PC, then enter the IP address which was set in the projector.

② Enter "user1" in the user name field, then enter the password in the password field.

The default setting is "panasonic" (all lower case). If you have changed the password, enter the new password here.

The host name set in the projector is displayed in the "Realm" field.

③ Click [OK].

The Basic Control page is displayed.

Note

- Avoid activating two or more Web browser simultaneously to work out setting or control actions.
- Change the password first of all.

■ Password change page

Click [Change password].

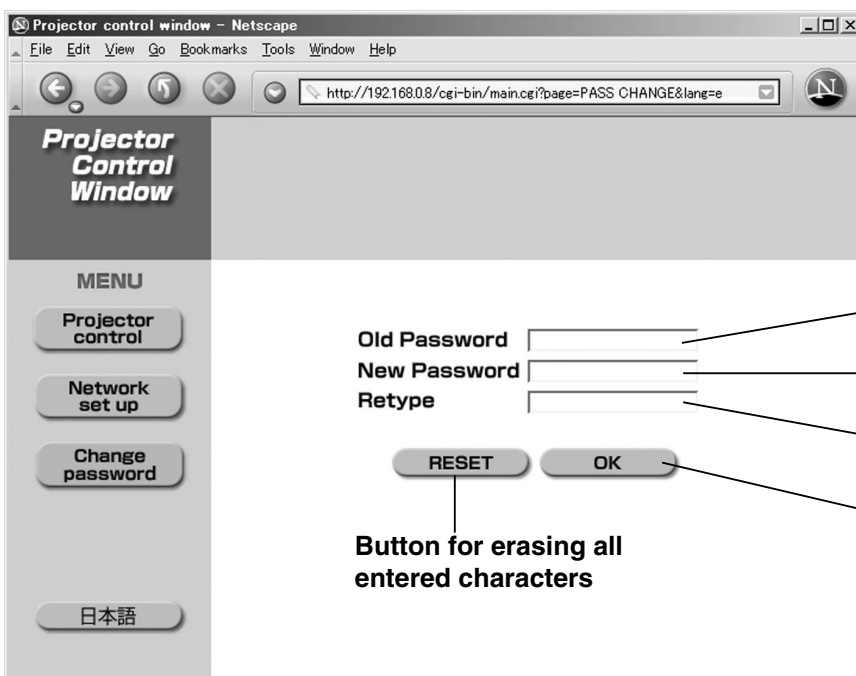

Using Web Browser Control

Basic control page

This page is the first page displayed when the projector is accessed through a web browser. To move from another page, click [Projector control], then [Basic control].

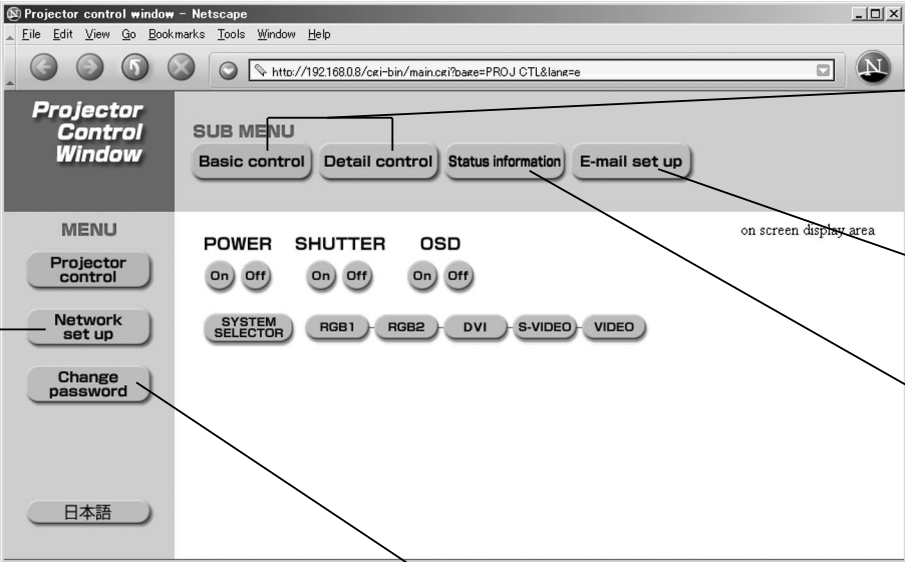

Control button
Click this item, and a projector control page appears.

E-mail set up button
Click this item, and an E-mail setting page appears.

Monitor information button
Click this item, and the status of the projector is displayed.

Network set up button
Click this item, and a network set up page for IP address and other items appear.

Change password button

Projector Control Window

SUB MENU
Basic control | Detail control | Status information | E-mail set up

MENU
Projector control
Network set up
Change password
日本語

POWER On Off **SHUTTER** On Off **OSD** On Off

SYSTEM SELECTOR RGB1 RGB2 DVI S-VIDEO VIDEO

on screen display area

Power On/Off control Shutter control

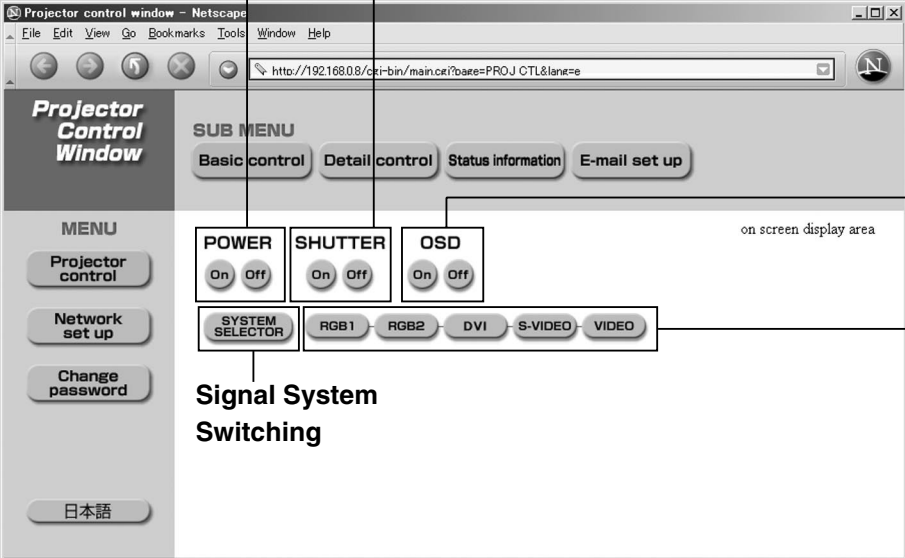

OSD (On-screen Display) display/non-display

Use these to select the input signals.

Signal System Switching

Projector Control Window

SUB MENU
Basic control | Detail control | Status information | E-mail set up

MENU
Projector control
Network set up
Change password
日本語

POWER On Off **SHUTTER** On Off **OSD** On Off

SYSTEM SELECTOR RGB1 RGB2 DVI S-VIDEO VIDEO

on screen display area

■ Detail control page

Click [Projector control], then [Detail control] to display the Detail control page.

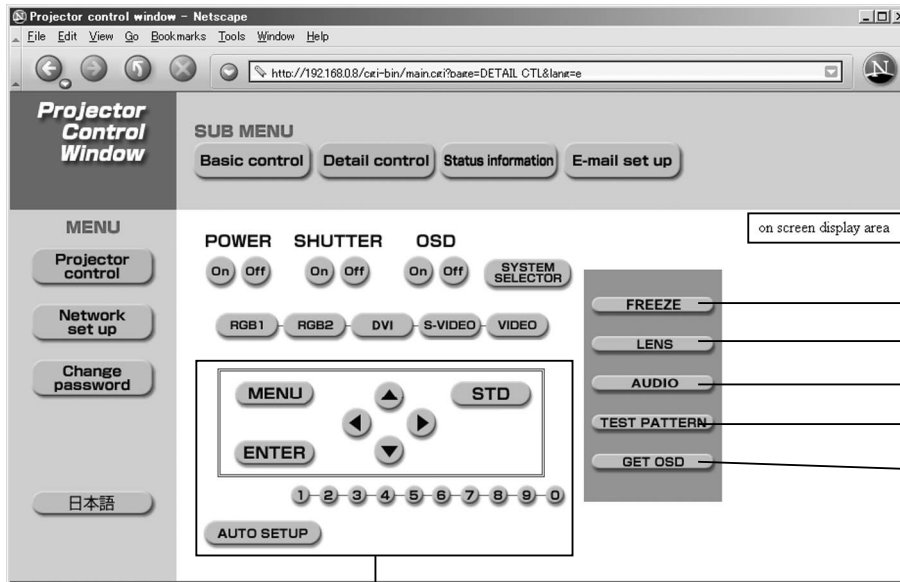

On-screen status is displayed, even if the on-screen of projector is set to off.

Temporary stop of video

Lens adjustment

Audio menu display

Test pattern display

This button updates the on-screen description on the right of the control page with the latest information.

Pressing these buttons controls the projector and updates the on-screen description on the right of the control page when control is finished.

■ Monitor information page

Click [Projector control], then [Status information] to display the Status information page. This page displays the projector statuses established for the items shown below.

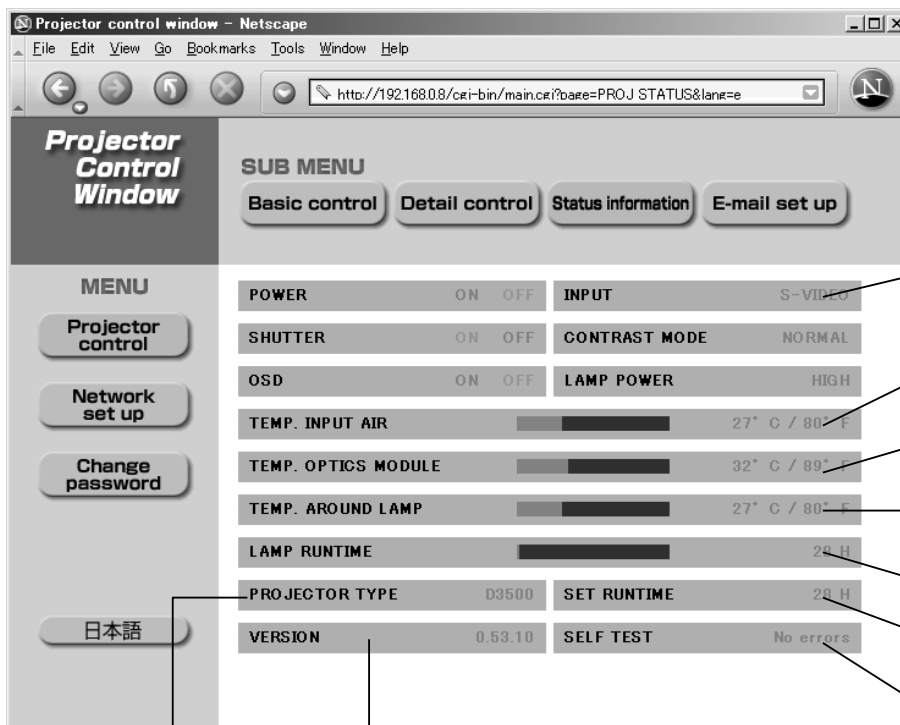

Displays the input switching status.

Displays temperature of projector's intake air.

Displays temperature inside the projector.

Displays temperature around the lamp.

Displays the lamp lit hours.

Displays used hours of the projector.

Displays self-diagnosis information.

Displays the type of projector.

Displays the firmware version of the projector main unit.

Using Web Browser Control

■ Error information page

When [Error](#) is displayed on the status information screen, click it to display the error details.

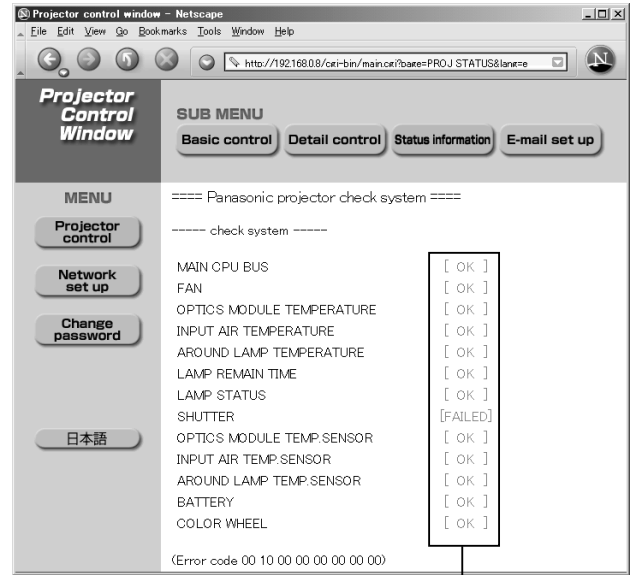
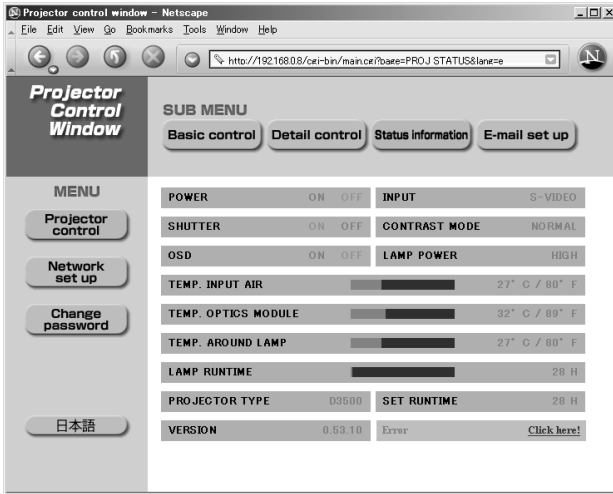

OK: Normal operation
FAILED: Occurrence of trouble

Note • Depending on the nature of the error, the projector may be placed in the standby mode for its own protection.

When [FAILED] has appeared for an item

Parameter	Description
MAIN CPU BUS	Trouble has occurred in the microcomputer circuitry. Consult your dealer.
FAN	Trouble has occurred in the fan or its drive circuit. Consult your dealer.
OPTICS MODULE TEMPERATURE	The temperature inside the projector is high. It may be that the projector is being used where the ambient temperature is high such as near a heating appliance.
INPUT AIR TEMPERATURE	The input air temperature is too high. It may be that the projector is being used where the ambient temperature is high such as near a heating appliance.
AROUND LAMP TEMPERATURE	The temperature near the lamp has risen very high. Something may be blocking the exhaust vent.
LAMP REMAIN TIME	The lamp runtime has exceeded the prescribed cumulative time, and it is now time to replace the lamp.
LAMP STATUS	The lamp has failed to light. Wait a short while for the lamp to cool off, and then turn on the power.
SHUTTER	Trouble has occurred in the shutter circuitry. Consult your dealer.
OPTICS MODULE TEMP.SENSOR	Trouble has occurred in the temperature detection sensor inside the projector. Consult your dealer.
INPUT AIR TEMP.SENSOR	Trouble has occurred in the sensor used to detect the input air temperature. Consult your dealer.
BATTERY	The backup battery has been run out. Consult your dealer.
COLOR WHEEL	Trouble has occurred in the color wheel or the color wheel drive circuit. Consult your dealer.

■ E-mail setup page

With this projector, if a problem occurs or if the lamp usage time reaches a set value, an e-mail message can be sent to one or more preset e-mail addresses (maximum two addresses). Click [Projector Control], then [E-mail set up] to display the E-mail setup page.

Select "Enable" to use the E-mail function.

Enter the IP address or server name of the E-mail server (SMTP). The DNS server must be set if the server name is entered.

Enter the E-mail address of the projector. (maximum 63 characters)

The user can enter the location of, for example, the installed projector so that the recipient may easily identify the originator of the E-mail. (maximum 63 characters)

The user can modify the minimum time interval of temperature warning mail. The default value is 60 minutes. In this case, the user cannot send another mail for 60 minutes after sending previous temperature warning mail even the set warning temperature is reached again.

The user can modify the threshold temperature for sending temperature warning mail. If the temperature rises above the set value, control sends temperature warning mail.

Enter the E-mail address of your desired recipient.

Select the conditions for sending E-mail.

ERROR:

an error is detected by self-diagnosis.

LAMP RUNTIME: remaining lamp service time has reached the value set in the field.

INPUT AIR TEMPERATURE: intake air temperature has reached the value set in the field.

Periodic warning interval setting (e-mail is sent on the checked days of the week/times)

(Continued on next page)

■ E-mail setup page (continuing)

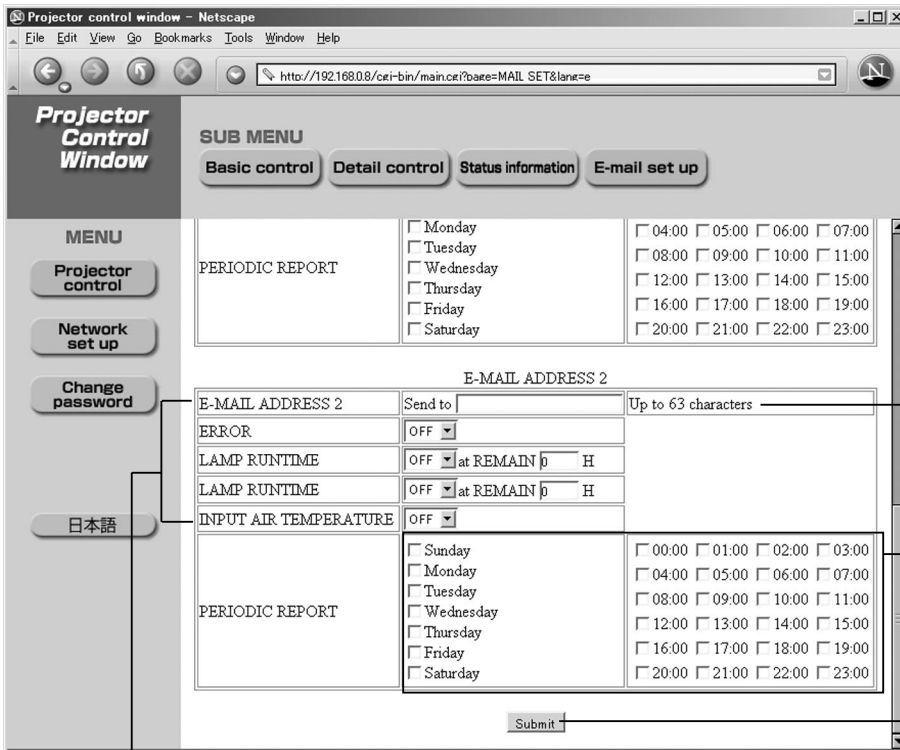

Enter the E-mail address to which the E-mail is to be sent when two E-mail addresses are going to be used. Do not enter it when the second E-mail address is not going to be used.

Check these boxes when E-mail is to be sent periodically to two E-mail addresses. E-mail will be sent at the times and on the days checked.

Button to update settings

Select the conditions for sending E-mail.

ERROR: an error is detected by self-diagnosis.

LAMP RUNTIME: remaining lamp service time has reached the value set in the field.

INPUT AIR TEMPERATURE: intake air temperature has reached the value set in the field.

■ DNS server set up page

Click [Network set up], then [DNS server set up] to display the DNS server set up page.

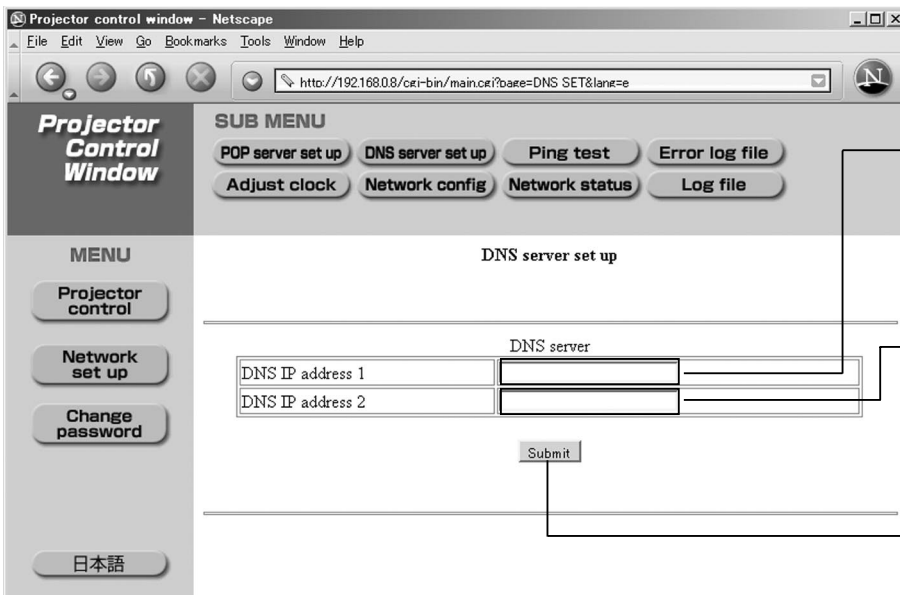

Primary DNS server address
Available input characters: Numbers (0 - 9), period (.) (ex. 192.168.0.253)

Secondary DNS server address
Available input characters: Numbers (0 - 9), period (.) (ex. 192.168.0.254)

Button to update settings

POP server setup page

The POP server is set on this page when POP authentication is required for mail transmissions. Click [Network set up], then [POP server set up] to display the POP server setup page.

Select "Enable" for this setting only when authentication is required for sending mail.

POP server name field
Available input characters: Alphanumeric characters (A–Z, a–z, 0–9), hyphen (-), period (.)

POP server user name field

POP server password field

Button to update settings

Ping test page

This page makes it possible to check whether the network is connected to the E-mail server, POP server, DNS server, etc.

Click [Network set up], then [Ping test] to display the Ping test page.

Enter the IP address of the server to be tested.

Button for conducting the test.

```
PING 192.168.0.122 (192.168.0.122): 56 data bytes
64 bytes from 192.168.0.122: icmp_seq=0 ttl=128 time=0.8 ms
64 bytes from 192.168.0.122: icmp_seq=1 ttl=128 time=3.1 ms
64 bytes from 192.168.0.122: icmp_seq=2 ttl=128 time=4.5 ms
64 bytes from 192.168.0.122: icmp_seq=3 ttl=128 time=5.8 ms

--- 192.168.0.122 ping statistics ---
4 packets transmitted, 4 packets received, 0% packet loss
round-trip min/avg/max = 0.8/3.5/5.8 ms
```

Display which appears when the connection was successful.

```
PING 192.168.0.122 (192.168.0.122): 56 data bytes

--- 192.168.0.122 ping statistics ---
4 packets transmitted, 0 packets received, 100% packet loss
```

Display which appears when the connection failed.

Using Web Browser Control

■ Contents of mail sent

- Mail with the contents shown below is sent when the E-mail settings have been established.

```

Subject: Panasonic projector report(CONFIGURE)
==== Panasonic projector report(CONFIGURE) ====
Projector Type      : D3500

----- E-mail setup data -----
TEMPERATURE WARNING SETUP
MINIMUM TIME      at [ 60] minutes interval
INPUT AIR TEMPERATURE Over [ 45C / 113F ]

ERROR             [ ON ]
LAMP RUNTIME      [ OFF ] at REMAIN [  0] H
LAMP RUNTIME      [ OFF ] at REMAIN [  0] H
INPUT AIR TEMPERATURE [ OFF ]

PERIODIC REPORT
Sunday [ OFF ] Monday [ OFF ] Tuesday [ OFF ] Wednesday [ OFF ]
Thursday [ OFF ] Friday [ OFF ] Saturday [ OFF ]

00:00 [ OFF ] 01:00 [ OFF ] 02:00 [ OFF ] 03:00 [ OFF ]
04:00 [ OFF ] 05:00 [ OFF ] 06:00 [ OFF ] 07:00 [ OFF ]
08:00 [ OFF ] 09:00 [ OFF ] 10:00 [ OFF ] 11:00 [ OFF ]
12:00 [ OFF ] 13:00 [ OFF ] 14:00 [ OFF ] 15:00 [ OFF ]
16:00 [ OFF ] 17:00 [ OFF ] 18:00 [ OFF ] 19:00 [ OFF ]
20:00 [ OFF ] 21:00 [ OFF ] 22:00 [ OFF ] 23:00 [ OFF ]

----- check system -----
MAIN CPU BUS      [ OK ]
FAN               [ OK ]
OPTICS MODULE TEMPERATURE [ OK ]
INPUT AIR TEMPERATURE [ OK ]
AROUND LAMP TEMPERATURE [ OK ]
LAMP REMAIN TIME [ OK ]
.
.
.
    
```

- Mail with the contents shown below is sent when an error has occurred.

```

Subject: Panasonic projector report(ERROR)
==== Panasonic projector report(ERROR) ====
Projector Type      : D3500

----- check system -----
MAIN CPU BUS      [ OK ]
FAN               [ OK ]
OPTICS MODULE TEMPERATURE [ OK ]
INPUT AIR TEMPERATURE [ OK ]
AROUND LAMP TEMPERATURE [ OK ]
LAMP REMAIN TIME [ OK ]
LAMP STATUS       [ FAILED ]
SHUTTER           [ OK ]
OPTICS MODULE TEMP.SENSOR [ OK ]
INPUT AIR TEMP.SENSOR [ OK ]
AROUND LAMP TEMP.SENSOR [ OK ]
BATTERY           [ OK ]
COLOR WHEEL       [ OK ]
(Error code 00 40 00 00 00 00 00)
Input air temperature : 27 degC / 80 degF
Optics module temperature : 65 degC / 149 degF
Around lamp temperature : 27 degC / 80 degF
SET RUNTIME        1857 H
POWER ON           248 times
LAMP ON            177 times
LAMP LOW           0 H
LAMP HIGH          68 H
LAMP REMAIN        1432 H

----- Network configuration -----
IP address 192.168.0.8
MAC address 00:00:00:00:00:00
Wed Jan 26 18:54:31 2005
----- Memo -----
    
```

■ Adjust clock page

Click [Network set up], then [Adjust clock] to display the Adjust clock page.

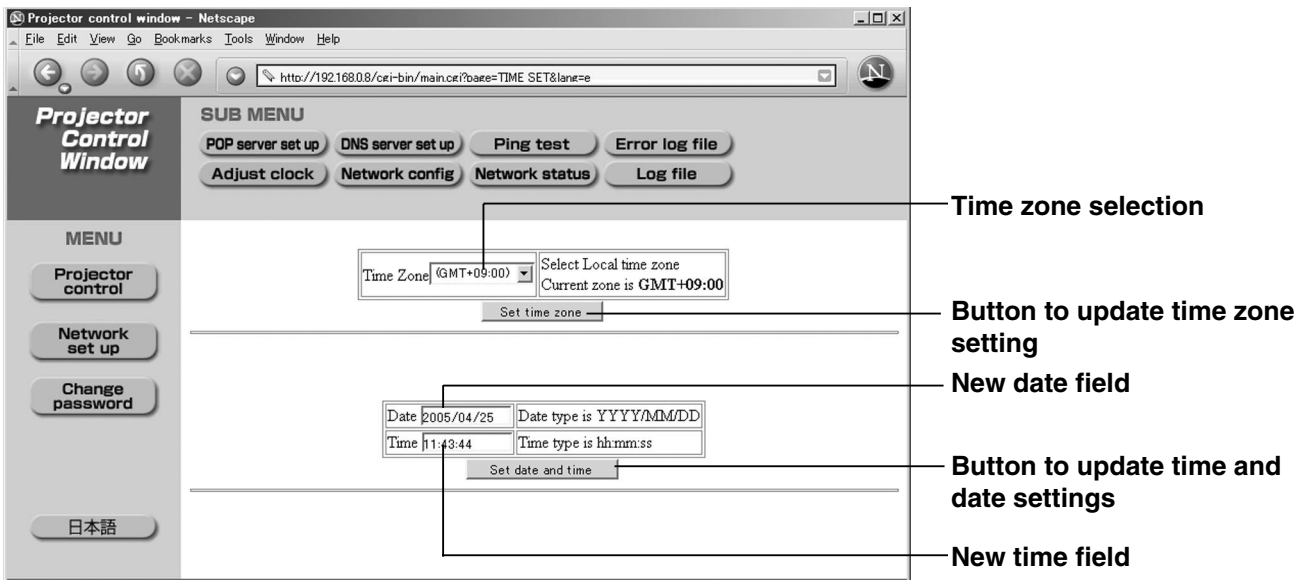

Note • If the time becomes incorrect immediately after setting the correct time, then the battery needs to be changed. Contact the dealer where you bought the projector to have the battery changed.

■ Network config page

Set this to ON to enable the DHCP client function.

Enter the IP address if DHCP server is not used.

Enter the net mask if DHCP server is not used.

Enter the gateway address if DHCP server is not used.

Enter the name of the projector here. Enter the host name here if it is required when the DHCP server is going to be used, for instance.

■ Network status page

Click [Network Setting], then [Network status] to display the Network status page.

Network software version display

Set IP address display

Set subnet mask display

MAC address display

Network status display

Using the PJLink™ protocol

The network functions of the projector are compatible with PJLink™ Class 1. The operations mentioned below can be performed from a personal computer using the PJLink™ protocol.

- Projector settings
- Projector status inquiry

■ Supported commands

The commands for controlling the projector using the PJLink™ protocol are as given in the table below.

Command	Control Description	Remarks
POWR	Power control	Parameter 0 = Standby 1 = Power "ON"
POWR ?	Power status inquiry	Parameter 0 = Standby 1 = Power "ON" 2 = Cooling down 3 = During warm-up
INPT	Input selection	Parameter 11 = RGB1 12 = RGB2 21 = VIDEO 22 = S-VIDEO 31 = DVI
INPT ?	Input selection inquiry	
AVMT	Shutter control	Parameter 10 = Mute reset of video only 11 = Mute video 20 = Mute reset of audio only 21 = Mute audio 30 = Shutter mode OFF (Mute reset of video and audio) 31 = Shutter mode ON (Mute video and audio)
AVMT ?	Shutter status inquiry	
ERST ?	Error status inquiry	Parameter 1st byte: Refers to fan error; one of 0 to 2 2nd byte: Refers to lamp error; one of 0 to 2 3rd byte: Refers to temperature error; one of 0 to 2 4th byte: 0 fixed 5th byte: 0 fixed 6th byte: Refers to some other error; one of 0 to 2 The meaning of 0 to 2 is as given below. 0 = Error not detected 1 = Warning 2 = Error
LAMP ?	Lamp status inquiry	Parameter First number (digits 1 to 5): Lamp cumulative time Second number: 0 = Lamp OFF; 1 = Lamp ON
INST ?	Input selection list inquiry	Parameter responds with following values: "11 12 21 22 31"
NAME ?	Projector name inquiry	Responds with the name set in "HOST NAME" of "NETWORK"
INF1 ?	Manufacturer's name inquiry	Responds with "Panasonic"
INF2 ?	Model name inquiry	Responds with "D3500"
INFO ?	Other information inquiry	Responds with version number and so on
CLSS ?	Class information inquiry	Responds with "1"

■ PJLink™ security authentication

The password used in PJLink™ is the same as the password set in the Web Browser Control. To use PJLink™ without authentication, do not set any password in Web Browser Control.

* PJLink™ is the applied-for trademark in Japan, USA, and in other countries and regions. For specifications of PJLink™, see the website of the Japan Business Machine and Information System Industries Association.
URL <http://pjlink.jbmia.or.jp/>

Before asking for service

---Before asking for service, check the following points.

Symptoms	Checks
Power does not turn on	<ul style="list-style-type: none"> • Is the power cord plug correctly plugged in? • Is the MAIN POWER turned on? • Is electricity running to the power outlet? • Is the temperature monitor (TEMP) indicator on the front of the unit flashing or turned on? (See page 42) • Is the lamp monitor (LAMP) indicator on the front of the unit flashing or turned on? (See page 42) • Is the lamp unit door installed correctly? • A wrong ID is set. (See pages 15 and 35)
No image	<ul style="list-style-type: none"> • Is the lens cap still on the lens? • Is the image input correctly connected? • Is the input mode set correctly? (See page 22) • Is the black level adjustment set at the minimum level? (See page 29) • Is the equipment connected to the projector operating correctly? • Is the shutter function turned on? (See page 25)
Image is blurred	<ul style="list-style-type: none"> • Is the lens focused properly? (See page 24) • Is the projection distance correct? (See page 17) • Is the lens dirty? • Is the projector positioned directly in front of the screen? (See page 17)
Light color/ bad color tone	<ul style="list-style-type: none"> • Is the color density and color tone setting correct? (See page 29) • Is the equipment connected to the projector correctly adjusted?
Remote control does not operate	<ul style="list-style-type: none"> • Are the batteries exhausted? • Are the battery polarities set correctly? (See page 14) • Are there any obstacles between the remote control and the remote control sensor? (See page 14) • Are you trying to operate the remote control beyond its operable range? (See page 14) • Are you controlling from external equipment using the REMOTE2 terminal? (See page 41) • Is there any external light interfering with remote control operation? • A wrong ID is set. (See pages 15 and 35) • Is the on-screen display function at "OFF"? (See page 9)
Abnormal image	<ul style="list-style-type: none"> • Is the input mode properly set? (See page 22) • Is the correct signal system (TV system) selected? (See page 30) • Are there any malfunctions on the source side, such as bad video tapes? • Are you inputting a signal that is not compatible with this projector? (See page 60)
Does not display images from PCs	<ul style="list-style-type: none"> • Is the cable too long? • Is the video output signal setting of the computer correctly set? (Read the operating instructions of the your PC.)

Specifications

Power supply	AC 120 V, 50 Hz/60 Hz
Power consumption	400 W (about 10 W in standby without fan running)
DLP™ panel Panel size Display system Number of pixels	0.7 inch (aspect ratio 4:3) DMD™ element, DLP type 786 432 pixels (1 024 x 768 dots)
Lens Powered zoom Powered focus control	1 to 1.32 F=1.7 to 2.0 f=25.6 mm (1") to 33.8 mm (1.3")
Projection lamp	1 bulb x 300 W UHM lamp
Optical output	3 500 lm ^{※1}
Applicable scanning frequency For video signal (S-video included) For RGB signal For DVI-D signal For YPBPR signal	Horizontally 15.73 kHz/15.63 kHz, vertically 59.94 Hz/50 Hz Horizontally 15 kHz–91 kHz, vertically 50 Hz–85 Hz, Panasonic Intelligent Auto Scanning (PIAS) system Dot clock frequency Less than 108 MHz Compliant with HDCP ^{※2} EDID1: 480p, 576p, 720/60p, 1080/60i, 1080/50i EDID2: VGA480/60, SVGA/60, XGA/60, XGA/70, XGA/85, SXGA/60 [480i], horizontally 15.73 kHz, vertically 59.94 Hz [480p], horizontally 31.5 kHz, vertically 59.94 Hz [576i], horizontally 15.63 kHz, vertically 50 Hz [576p], horizontally 31.25 kHz, vertically 50 Hz [720/60p], horizontally 45 kHz, vertically 60 Hz [1035/60i], horizontally 33.75 kHz, vertically 60 Hz [1080/60i], horizontally 33.75 kHz, vertically 60 Hz [1080/50i], horizontally 28.13 kHz, vertically 50 Hz • HD/SYNC, VD terminals are not compliant with 3 value composite SYNC.
Color system	7 standards (NTSC/NTSC4.43/PAL/PAN-N/PAL-M/SECAM/PAL60)
Screen size	50 inch–600 inch
Screen aspect ratio	4:3
Projection scheme	Menu-selectable from front/rear/ceiling mount, and floor standing
Contrast ratio	1 600:1 (when “HIGH” is selected as the “CONTRAST MODE” setting)
Interface ports RGB1 input terminal	1 set, BNC x 5 [For YPBPR input] Y: 1.0 V[p-p] synchronization signal included, PbPR: 0.7 V[p-p] 75 Ω [For RGB input] 0.7 V[p-p] 75 Ω For G-SYNC: 1.0 V[p-p] 75 Ω HD/SYNC: TTL, high-impedance, positive/negative polarity automatically adjusted VD: TTL, high-impedance, positive/negative polarity automatically adjusted • However, HD/SYNC, and VD terminals are not compliant with 3-value direct SYNC.

※1 Value when accessory lens is used, “PICTURE MODE” is set at “DYNAMIC” and zoom lens is in the wide lens position.

※2 HDCP (High-bandwidth Digital Content Protection)

HDCP is a digital video signal encryption system developed with the aim of protecting digital content.

Interface ports	
RGB2 input terminal	1 set of high-density, D-sub 15p (female) [For YPbPr input] Y: 1.0 V [p-p] synchronization signal included, PbPr: 0.7 V[p-p] 75 Ω [For RGB input] 0.7 V[p-p] 75 Ω For G-SYNC: 1.0 V[p-p] 75 Ω HD/SYNC: TTL, high-impedance, positive/negative polarity automatically adjusted VD: TTL, high-impedance, positive/negative polarity automatically adjusted • However, HD/SYNC, and VD terminals are not compliant with 3-value direct SYNC.
Video input terminal	1 set RCA 1.0 V[p-p] 75 Ω
S-video input terminal	1 set Mini DIN 4p Y 1.0 V[p-p] C 0.286 V[p-p] 75 Ω Compliant with S1 signals
Serial input terminal	D-sub 9-pin (female), RS232C compliant Used for personal computer control
Remote1 input terminal	1 set for M3 stereo mini jack Wired remote control
Remote2 terminal	D-sub 9-pin (female) Used for external control
DVI-D terminal	DVI-D 24-pin
LAN terminal	RJ-45 Compliant with PLink™
Audio input terminal	1 set of M3 stereo mini jacks (L and R) for RGB1/RGB2/DVI input 1 set of RCA (L and R) for Video/ S-Video input
Audio output terminal	1 set of M3 stereo mini jacks (L and R)
Length of power supply cord	3.0 m (9.1')
Cabinet	Molded resin
Outside dimensions	Width: 332 mm (13.1"); Height : 168 mm (6.6"); Depth: 425 mm (16.7")
Mass	7.9 kg (17.4 lb)
Working environment condition	※ ³ Ambient temperature: 0 °C to 40 °C Ambient humidity: 20 % to 80 % (no condensation)
Remote control	
Power source	3 V DC (two AAA dry cells)
Operation range	approx. 7 m (22' 11") (in front of beam receiver)
Mass	95 g (0.21 lb) (including dry cells)
Outside dimensions	Width: 45 mm (1.8"), Thickness: 23 mm (0.9"), Depth: 145 mm (5.7")
Option	
Hanging attachment (For high ceiling)	: ET-PKD35
Hanging attachment (For low ceiling)	: ET-PKD35S
Projection lens	: ET-DLE100, ET-DLE200, ET-DLE300, ET-DLE400, ET-DLE050
Wireless mouse receiver	: ET-RMRC2
Replacement lamp unit	: ET-LAD35 (single bulb)
Long life lamp unit	: ET-LAD35L (single bulb)

• The outside dimensions do not include the lens and other protruding parts. See page 63 for further details.

※³ When using the projector at high altitudes (1 400 to 2 700 m) (4 605.3' to 8 881.5'), the upper limit for the ambient temperature drops by 5 °C.

Compatible Signal List

Display mode	Resolution (as a number of dots) ※1	Scanning frequency		Dot clock frequency (MHz)	Image quality ※2	Format
		Horizontal (kHz)	Vertical (Hz)			
NTSC/NTSC4.43/ PAL-M/PAL60	720 X 480i	15.7	59.9		A	Video/S-Video
PAL/PAL-N/SECAM	720 X 576i	15.6	50.0		A	Video/S-Video
480i	720 X 480i	15.7	59.9	13.5	A	YPbPr/RGB
576i	720 X 576i	15.6	50.0	13.5	A	YPbPr/RGB
480p	720 X 483	31.5	59.9	27.0	A	YPbPr/RGB/DVI
576p	720 X 576	31.3	50.0	27.0	A	YPbPr/RGB/DVI
1080/60i	1 920 X 1 080i	33.8	60.0	74.3	A	YPbPr/RGB/DVI
1080/50i	1 920 X 1 080i	28.1	50.0	74.3	A	YPbPr/RGB/DVI
720/60p	1 280 X 720	45.0	60.0	74.3	A	YPbPr/RGB/DVI
VGA400	640 X 400	31.5	70.1	25.2	A	RGB
	640 X 400	37.9	85.1	31.5	A	RGB
VGA480	640 X 480	31.5	59.9	25.2	A	RGB/DVI
	640 X 480	35.0	66.7	30.2	A	RGB
	640 X 480	37.9	72.8	31.5	A	RGB
	640 X 480	37.5	75.0	31.5	A	RGB
	640 X 480	43.3	85.0	36.0	A	RGB
SVGA	800 X 600	35.2	56.3	36.0	A	RGB
	800 X 600	37.9	60.3	40.0	A	RGB/DVI
	800 X 600	48.1	72.1	50.0	A	RGB
	800 X 600	46.9	75.0	49.5	A	RGB
	800 X 600	53.7	85.1	56.3	A	RGB
MAC16	832 X 624	49.7	74.6	57.3	A	RGB
XGA	1 024 X 768	48.4	60.0	65.0	AA	RGB/DVI
	1 024 X 768	56.5	70.1	75.0	AA	RGB/DVI
	1 024 X 768	60.0	75.0	78.8	AA	RGB/DVI
	1 024 X 768	68.7	85.0	94.5	AA	RGB/DVI
	1 024 X 768i	35.5	87.0	44.9	AA	RGB
MXGA	1 152 X 864	64.0	71.2	94.2	A	RGB
	1 152 X 864	67.5	74.9	108.0	A	RGB
	1 152 X 864	76.7	85.0	121.5	B	RGB
MAC21	1 152 X 870	68.7	75.1	100.0	A	RGB
MSXGA	1 280 X 960	60.0	60.0	108.0	A	RGB
SXGA	1 280 X 1 024	64.0	60.0	108.0	A	RGB/DVI
	1 280 X 1 024	80.0	75.0	135.0	B	RGB
	1 280 X 1 024	91.1	85.0	157.5	B	RGB
	1 400 X 1 050	64.0	60.0	108.0	A	RGB/DVI
UXGA	1 600 X 1 280	75.0	60.0	162.0	B	RGB

※1 Character “i” that follows the number of displayed dots stands for interlace signal.

※2 The symbols used to denote the image quality have the following significance:

AA = the images are projected at the highest quality; A = the images are converted by the image processing circuit and projected; B = the amount of data is scaled down and simplified images are projected.

※3 These signals support the frame lock function.

Note

- The number of display dots of the PT-D3500U is 1 024 x 768. If signals with a number of display dots differing from the data listed above are supplied, they will be converted into signals with 1 024 x 768 dots and displayed.

Projection distances by projection lens

The table below shows the projection distances of optional projection lenses.

For the projection distance of the standard lens provided with the PT-D3500U, refer to page 17.

For instructions on how to install the lenses, refer to page 21.

(SH, SW, L, LW, LT, H : m SD : inch)

Projected screen size (4:3 aspect ratio)			Wide-angle fixed-focus lens	Wide-angle zoom lens		Intermediate- focus zoom lens		Long-focus zoom lens		Ultra-long-focus zoom lens	
Diagonal length (SD)	Height (SH)	Width (SW)	Model No. : ET-DLE050	Model No. : ET-DLE100		Model No. : ET-DLE200		Model No. : ET-DLE300		Model No. : ET-DLE400	
			(0.8) (L)	(1.33–1.78)		(2.5–4.0)		(3.7–5.7)		(5.7–8.0)	
				Minimum (LW)	Maximum (LT)	Minimum (LW)	Maximum (LT)	Minimum (LW)	Maximum (LT)	Minimum (LW)	Maximum (LT)
1.27 (50")	0.76 [2'5"]	1.02 [3'4"]	0.79 [2'7"]	1.34 [4'4"]	1.81 [5'11"]	2.46 [8']	4.05 [13'3"]	3.84 [12'7"]	6.03 [19'9"]	5.94 [19'5"]	8.31 [27'3"]
1.52 (60")	0.91 [2'11"]	1.22 [4']	0.96 [3'1"]	1.61 [5'3"]	2.19 [7'2"]	2.96 [9'8"]	4.87 [15'11"]	4.63 [15'2"]	7.26 [23'9"]	7.11 [23'3"]	9.95 [32'7"]
1.78 (70")	1.07 [3'6"]	1.42 [4'7"]	1.12 [3'8"]	1.89 [6'2"]	2.56 [8'4"]	3.46 [11'4"]	5.69 [18'8"]	5.43 [17'9"]	8.49 [27'10"]	8.28 [27'1"]	11.60 [38']
2.03 (80")	1.22 [4']	1.63 [5'4"]	1.29 [4'2"]	2.17 [7'1"]	2.93 [9'7"]	3.97 [13']	6.52 [21'4"]	6.22 [20'4"]	9.72 [31'10"]	9.45 [31']	13.24 [43'5"]
2.29 (90")	1.37 [4'5"]	1.83 [6']	1.45 [4'9"]	2.44 [8']	3.30 [10'9"]	4.47 [14'7"]	7.34 [24']	7.02 [23']	10.96 [35'11"]	10.62 [34'10"]	14.89 [48'10"]
2.54 (100")	1.52 [4'11"]	2.03 [6'7"]	1.62 [5'3"]	2.72 [8'11"]	3.68 [12']	4.98 [16'4"]	8.17 [26'9"]	7.81 [25'7"]	12.19 [39'11"]	11.79 [38'8"]	16.53 [54'2"]
3.05 (120")	1.83 [6']	2.44 [8']	1.95 [6'4"]	3.27 [10'8"]	4.42 [14'6"]	5.99 [19'7"]	9.82 [32'2"]	9.40 [30'10"]	14.65 [48']	14.14 [46'4"]	19.82 [65']
3.81 (150")	2.29 [7'6"]	3.05 [10']	2.45 [8']	4.10 [13'5"]	5.54 [18'2"]	7.50 [24'7"]	12.29 [40'3"]	11.79 [38'8"]	18.35 [60'2"]	17.65 [57'10"]	24.75 [81'2"]
5.08 (200")	3.05 [10']	4.06 [13'3"]	3.28 [10'9"]	5.48 [17'11"]	7.40 [24'3"]	10.02 [32'10"]	16.41 [53'10"]	15.76 [51'8"]	24.51 [80'4"]	23.52 [77'1"]	32.98 [108'2"]
6.35 (250")	3.81 [12'6"]	5.08 [16'8"]	–	6.87 [22'6"]	9.26 [30'4"]	12.54 [41'1"]	20.53 [67'4"]	19.74 [64'9"]	30.67 [100'7"]	29.39 [96'5"]	41.20 [135'2"]
7.62 (300")	4.57 [14'11"]	6.10 [20']	–	8.25 [27']	11.12 [36'5"]	15.06 [49'4"]	24.65 [80'10"]	23.71 [77'9"]	36.83 [120'10"]	35.27 [115'8"]	49.43 [162'2"]
8.89 (350")	5.33 [17'5"]	7.11 [23'3"]	–	9.63 [31'7"]	12.98 [42'7"]	17.58 [57'8"]	28.77 [94'4"]	27.69 [90'10"]	42.99 [141']	41.15 [135']	57.66 [189'2"]
10.16 (400")	6.10 [20']	8.13 [26'8"]	–	11.02 [36'1"]	14.84 [48'8"]	20.11 [65'11"]	32.90 [107'11"]	31.66 [103'10"]	49.15 [161'3"]	47.04 [154'3"]	65.90 [216'2"]
12.70 (500")	7.62 [25']	10.16 [33'4"]	–	13.78 [45'2"]	18.56 [60'10"]	25.15 [82'6"]	41.14 [134'11"]	39.61 [129'11"]	61.47 [201'8"]	58.85 [193']	82.38 [270'3"]
15.24 (600")	9.14 [29'11"]	12.19 [39'11"]	–	16.55 [54'3"]	22.28 [73'1"]	30.19 [99']	49.38 [162']	47.56 [156']	73.80 [242'1"]	70.67 [231'10"]	98.87 [324'4"]

Calculation formulas for projection distance by lens types

L, LW, LT : m SD : inch

Wide-angle fixed-focus lens	Model No. : ET-DLE050		$L=0.0166 \times SD - 0.0361$
Wide-angle zoom lens	Model No. : ET-DLE100	Minimum (LW)	$LW=0.0276 \times SD - 0.0452$
		Maximum (LT)	$LT=0.0372 \times SD - 0.0478$
Intermediate-focus zoom lens	Model No. : ET-DLE200	Minimum (LW)	$LW=0.0504 \times SD - 0.0657$
		Maximum (LT)	$LT=0.0824 \times SD - 0.0758$
Long-focus zoom lens	Model No. : ET-DLE300	Minimum (LW)	$LW=0.0795 \times SD - 0.1380$
		Maximum (LT)	$LT=0.1232 \times SD - 0.1310$
Ultra-long-focus zoom lens	Model No. : ET-DLE400	Minimum (LW)	$LW=0.1176 \times SD + 0.0244$
		Maximum (LT)	$LT=0.1646 \times SD + 0.0651$

Note • The dimensions in the table above and the values obtained from the above formulas may contain slight errors.

Dimensions

unit : mm () : inch

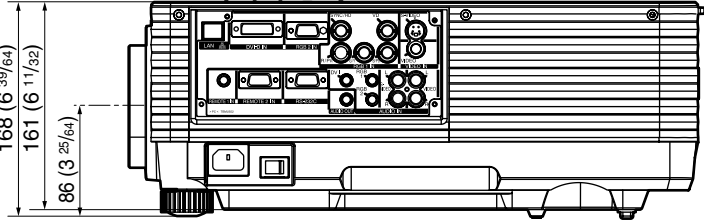
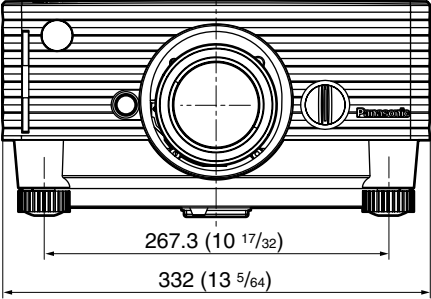
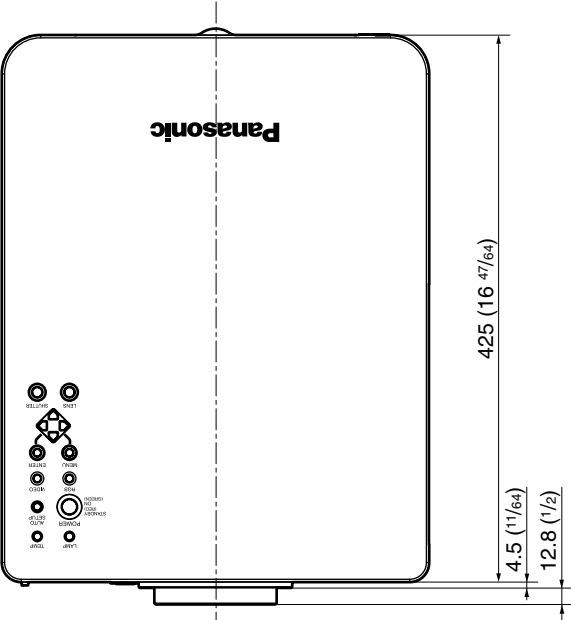

Note:

Purchase of this equipment includes the rights to use this software (the built-in microcomputer and information recorded on ROMs) but does not grant copyrights. Do not reverse engineer, change or modify the software. The guarantee will not be valid for any malfunctions caused by such actions.

Trademark Acknowledgement

- Digital Light Processing, DLP, and Digital Micromirror Device, DMD are registered trademarks of the Texas Instruments.
 - VGA and XGA are trademarks of International Business Machines Corporation.
 - S-VGA is a registered trademark of the Video Electronics Standards Association.
 - "Microsoft Windows" is a registered trademark of the Microsoft Corporation (U.S.A.) in the U.S. and other countries.
 - "Netscape" and "Netscape Navigator" are registered trademarks of the Netscape Communications Corporation in the U.S. and other countries.
 - PJLink is the applied-for trademark in Japan, USA, and in other countries and regions.
- All other trademarks are the property of the various trademark owners.

NOTES IMPORTANTES

CONCERNANT LA SÉCURITÉ

AVERTISSEMENT: POUR RÉDUIRE LES RISQUES DE FEU OU DE CHOC ÉLECTRIQUE, NE PAS EXPOSER CE PRODUIT À L'EAU OU À L'HUMIDITÉ

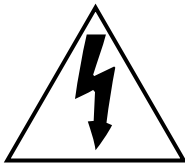
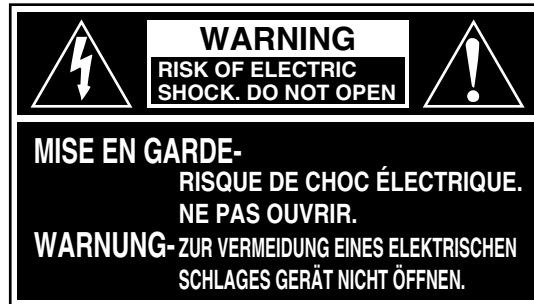

Le symbole de la flèche en forme d'éclair, dans un triangle, avertit l'utilisateur de la présence de "tensions dangereuses" à l'intérieur du produit qui peuvent être de force suffisante pour constituer un risque de choc électrique aux personnes.



Le point d'exclamation dans un triangle avertit l'utilisateur de la présence d'instructions importantes concernant l'utilisation et l'entretien (réparation) dans la littérature accompagnant le produit.

ATTENTION: Cet appareil est équipé d'une fiche de courant à trois broches avec mise à la terre. Ne pas retirer la broche de mise à la masse de la fiche. Cette fiche ne pourra être utilisée que dans une prise avec mise à la terre. Ceci est une précaution sécuritaire. S'il est impossible d'insérer la fiche dans la prise, s'adresser à un électricien. Ne pas annuler la protection de la fiche à mise à la terre.

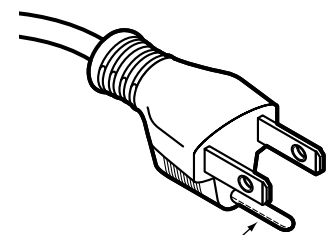

Ne pas retirer

AVERTISSEMENT:

Ne peut être utilisé dans une salle d'ordinateurs telle que définie dans la norme ANSI/NFPA 75 Standard for Protection of Electronic Computer/Data Processing Equipment.

Précautions concernant la sécurité

AVERTISSEMENT

En cas de problème (ex: pas d'image) ou si le projecteur émet de la fumée ou une odeur de brûlé, coupez le courant et débranchez le cordon électrique de la prise.

- Ne pas continuer d'utiliser le projecteur dans ces cas, autrement cela peut entraîner un incendie ou des chocs électriques.
- Après s'être assuré que de la fumée ne se dégage plus, s'adresser à un centre technique agréé et demander que les réparations nécessaires soient faites.
- Le fait de réparer le projecteur soi-même est très dangereux, et ne doit jamais être fait.

Ne pas installer ce projecteur dans un endroit qui n'est pas assez résistant pour supporter le poids du projecteur.

- Si l'emplacement d'installation n'est pas assez résistant, le projecteur risque de tomber et causer de graves blessures et (ou) des dommages.
- Demander à un technicien qualifié d'installer le projecteur par exemple s'il est installé au plafond.
- Si l'installation n'est pas faite correctement, cela peut entraîner des blessures ou des chocs électriques.

Si de l'eau ou des objets étrangers entrent dans le projecteur, si le projecteur tombe, ou si le boîtier est endommagé, éteindre l'appareil et débrancher immédiatement la fiche d'alimentation de la prise de courant.

- Si l'on continue d'utiliser le projecteur dans ces conditions, cela peut entraîner un incendie ou des chocs électriques.
- S'adresser à un centre technique agréé pour que les réparations nécessaires puissent être faites.

Ne pas couvrir le filtre et la sortie d'air.

- Cela risque de faire surchauffer le projecteur, et causer un incendie ou endommager le projecteur.

Ne pas surcharger la prise de courant.

- Si l'alimentation est surchargée (par exemple, par l'utilisation de trop d'adaptateurs), cela risque de faire surchauffer le projecteur et peut entraîner un incendie.

Ne pas retirer le couvercle ou le modifier.

- Des hautes tensions qui peuvent causer de graves blessures sont présentes à l'intérieur du projecteur.
- Pour toute inspection, réglage ou réparation, s'adresser à un centre technique agréé.

Utiliser exclusivement le cordon d'alimentation fourni avec le projecteur.

- Utiliser exclusivement le cordon fourni à fiche 3 broches et l'insérer uniquement dans une prise de courant mise à la terre. Autrement, cela peut entraîner un choc électrique.

Nettoyer la fiche du cordon d'alimentation régulièrement afin d'éviter toute accumulation de poussière.

- Si de la poussière s'accumule sur la fiche du cordon d'alimentation, l'humidité peut endommager l'isolant et entraîner un incendie. Débrancher le cordon d'alimentation de la prise de courant et l'essuyer avec un chiffon sec.
- Si le projecteur ne sera pas utilisé pendant une période prolongée, débrancher le cordon d'alimentation de la prise de courant.

Faire attention de ne pas endommager le cordon d'alimentation.

- Ne pas endommager le cordon d'alimentation, ne pas le modifier, ne pas placer d'objets lourds, ne pas le chauffer, ne pas le placer près d'objets chauffants, ne pas le tordre, ne pas le plier ou le tirer excessivement et ne pas le rouler en boule.
- Si le cordon d'alimentation est endommagé, cela peut entraîner un incendie et des chocs électriques.
- Si le cordon d'alimentation est endommagé, le faire réparer par un centre technique agréé.

Ne pas manipuler le cordon d'alimentation avec les mains mouillées.

- Cela peut entraîner des chocs électriques.

Brancher la fiche du cordon d'alimentation fermement dans la prise de courant.

- Si la fiche n'est pas complètement insérée, cela peut entraîner des chocs électriques ou la faire surchauffer.
- Si la fiche est endommagée ou la plaque de la prise est desserrée, elles ne devraient pas être utilisées.

Ne démontez pas le bloc lampe.

- Une rupture de la lampe peut provoquer une blessure corporelle.

Précautions concernant la sécurité

Ne pas placer le projecteur sur des surfaces instables.

- Si le projecteur est placé sur une surface qui est inclinée ou instable, il risque de tomber ou de se renverser et cela peut causer des blessures ou des dommages.

Ne pas placer le projecteur dans l'eau ou ne pas le laisser se mouiller.

- Sinon cela peut causer un incendie ou des chocs électriques.

Ne pas placer des récipients de liquide sur le projecteur.

- Si de l'eau se renverse sur le projecteur, s'adresser à un centre technique agréé.
- Si n'importe quel liqui de s'infiltrer à l'intérieur du projecteur, entrer en contact avec un centre commercial autorisé.

Ne pas mettre d'objets étrangers dans le projecteur.

- Ne pas insérer d'objets métalliques ou inflammables dans les orifices de ventilation ou les faire tomber sur le projecteur, car cela peut causer un incendie ou des chocs électriques.

Après avoir retiré la pile de la télécommande, la garder hors de la portée des enfants.

- Si avalée, la pile peut causer la mort par suffocation.
- Si la pile est avalée, s'adresser à un médecin immédiatement.

Ne pas laisser les bornes + et – de la pile entrer en contact avec des objets métalliques tels que des colliers ou des épingles à cheveux.

- Cela peut faire que la pile fuit, surchauffe, éclate ou prene feu.
- Garder la pile dans un sachet en plastique et la maintenir éloignée des objets métalliques.

Le remplacement de la lampe ne doit être effectué que par un technicien qualifié.

- La lampe a une pression interne élevée. Si elle est manipulé incorrectement, une explosion peut s'ensuivre.
- La lampe peut être facilement endommagé si elle est heurté contre des objets durs ou si on le laisse tomber et des blessures et des mauvais fonctionnements peuvent s'ensuivre.

Lorsque vous remplacez la lampe, laissez-la refroidir au moins une heure avant de la manipuler.

Ne pas placer les mains ou autres objets près de la sortie d'air.

- De l'air chaud sort par l'ouverture de sortie d'air. Ne pas placer les mains ou le visage, ou d'autres objets qui ne peuvent résister à la chaleur près de cette sortie d'air, sinon cela peut causer des blessures ou des dommages.

Ne pas suspendre le projecteur uniquement par l'orifice utilisé pour le fermoir antivol.

- Le projecteur risquerait de tomber ou de subir des dommages, voire de causer une blessure.

Attention

Ne pas installer le projecteur dans des endroits humides ou poussiéreux ou dans des endroits où le projecteur peut entrer en contact avec de la fumée ou la vapeur.

- L'utilisation du projecteur dans de telles conditions peut causer un incendie ou des chocs électriques.

Pour débrancher le cordon d'alimentation, tenir la fiche et non pas le cordon.

- Si le cordon d'alimentation est tiré, le cordon sera endommagé et cela peut causer un incendie, des courts-circuits ou des chocs électriques sérieux.

Débrancher toujours tous les câbles avant de déplacer le projecteur.

- Le fait de déplacer le projecteur avec des câbles branchés peut endommager les câbles, ce qui pourrait causer un incendie ou des chocs électriques.

Ne placez pas d'objets ou d'autres projecteurs sur cet appareil.

- Il y a un risque de blessure corporelle si les objets ou projecteurs se déséquilibrent ou tombent. De plus, l'installation d'un projecteur directement sur un autre peut provoquer une déformation des projecteurs et un dysfonctionnement.

Ne pas court-circuiter, chauffer ou démonter la pile et ne pas la placer dans l'eau ou le feu.

- Cela peut faire que la pile fuit, surchauffe, éclate ou prenne feu et causer des brûlures ou autres blessures.

Lors de l'insertion de la pile, s'assurer que les polarités (+ et -) sont correctes.

- Si la pile est insérée incorrectement, elle peut éclater ou fuir et cela peut causer un incendie, des blessures ou la contamination du compartiment des piles.

N'utiliser que la pile indiquée.

- Si une pile incorrecte est utilisée, elle peut éclater ou fuir et cela peut causer un incendie, des blessures ou la contamination du compartiment des piles.

Ne pas regarder directement dans la lentille pendant que le projecteur fonctionne.

- Une lumière intense est émise par la lentille du projecteur. Si l'on regarde directement dans cette lumière, elle risque de causer des blessures et de graves lésions aux yeux.

N'utilisez pas un bloc lampe usagé.

- Cela peut entraîner une rupture de la lampe.

Si la lampe éclate, manipulez-la de façon appropriée en prenant les précautions ci-dessous.

- Il peut y avoir des tessons éparpillés à l'intérieur du projecteur et du bloc lampe.
- Demandez au revendeur de remplacer la lampe et d'inspecter l'intérieur du projecteur.
- Des gaz et de fines particules peuvent être expulsés par les orifices de ventilation. Ces gaz contiennent du mercure. Si vous inhalez du gaz ou s'il pénètre dans vos yeux ou votre bouche, consultez immédiatement un médecin.

Débrancher la fiche du cordon d'alimentation de la prise de courant comme mesure de sécurité avant d'effectuer tout nettoyage.

- Sinon cela peut causer des chocs électriques.

Demander à un centre technique agréé de nettoyer l'intérieur du projecteur au moins une fois par an.

- S'il n'est pas nettoyé et que la poussière s'accumule à l'intérieur du projecteur, cela peut causer un incendie ou des problèmes de fonctionnement.
- Il est recommandé de nettoyer l'intérieur du projecteur avant que la saison humide n'arrive. Demander au centre technique agréé le plus proche de nettoyer le projecteur lorsque cela est requis. Se renseigner auprès du centre technique agréé pour le coût du nettoyage.

Ne touchez pas les ouvertures à côté de l'objectif pendant le mouvement horizontal ou vertical de l'objectif. Il y a des risques de blessure.

Précautions pour la manipulation

■ Précautions pour le transport

S'assurer absolument que le capuchon d'objectif est en place pour transporter le projecteur ou le déplacer. Le projecteur et la lentille de projection sont fabriqués avec précision et, en tant que tels, sont sensibles aux vibrations et aux chocs. Pour transporter le projecteur et la lentille ou les déplacer, les mettre dans les cartons dans lesquels ils étaient au moment de leur achat, et prendre des précautions afin de les protéger de vibrations et de chocs.

■ Précautions pour l'installation

Observez les précautions suivantes à l'installation du produit.

- **Évitez d'installer le produit à un emplacement exposé à des vibrations ou impacts.**

Si le projecteur est installé à un emplacement où des vibrations sont transmises d'une source à puissance motrice et autre, ou monté sur une voiture ou un bateau, des vibrations ou impacts peuvent être transmis au produit qui peuvent endommager les pièces internes, causant une défaillance. Installez le produit à un emplacement exempt de vibrations et d'impacts.

- **Ne déplacez pas le projecteur pendant qu'il fonctionne, et évitez de l'exposer à des vibrations ou chocs.**

La durée de service de ses moteurs internes risquerait d'être réduite.

- **N'installez pas le projecteur près de lignes haute tension ou de sources d'énergie.**

Le produit pourrait être exposé à des interférences s'il est installé à proximité de lignes haute tension ou de sources d'énergie.

- **Ne placez pas le projecteur sur une feuille en vinyle ou un tapis.**

Si la feuille de vinyle est aspirée et bloque de port d'admission du filtre à air, la température peut augmenter à l'intérieur du projecteur, ce qui déclenchera le circuit de protection et mettra le projecteur hors tension.

- **Consultez un technicien spécialisé pour l'installation du projet au plafond.**

Si le produit doit être suspendu au plafond, achetez un accessoire de suspension en option (pour plafond haut: Modèle n° ET-PKD35) (pour plafond bas: Modèle n° ET-PKD35S) et appelez un technicien spécialisé pour l'installation.

- **N'installez pas le projecteur à plus de 2 700 m (8 881.5') au-dessus du niveau de la mer.**

A l'utilisation au-dessus de 1 400 m (4 605.3') au-dessus du niveau de la mer, réglez "VENTILATEUR1", expliqué à la page 35, à "MONTAGNE".

En cas contraire, la durée de vie l'appareil risque d'être raccourcie.

■ Mise au rebut

Contactez le revendeur ou un revendeur spécialisé pour la mise au rebut du produit.

■ Précautions pour l'utilisation

- **Pour visualiser des images nettes:**

- Le public ne peut pas jouir d'un fort contraste et d'images nettes si la lumière extérieure ou l'éclairage interfère avec la surface de l'écran. Tirez les rideaux des fenêtres ou les stores, éteignez l'éclairage près de l'écran ou prenez d'autres mesures adaptées.
- Cas rare, un flottement peut survenir sur l'écran affecté par l'air chaud du port de sortie selon l'environnement.

- **Ne touchez pas la surface de l'objectif de projection les mains nues.**

Si des empreintes de doigts sont laissées sur la surface de l'objectif de projection, elles seront agrandies et projetées sur l'écran. Maintenez vos mains loin de l'objectif. Couvrez l'objectif avec le bouchon d'objectif fourni quand le projecteur n'est pas utilisé.

- **Lampe**

Une lampe au mercure à pression interne élevée est utilisée comme source lumineuse de ce produit. Cette lampe a les caractéristiques suivantes.

- Elle peut éclater sous l'effet d'un son fort ou terminer sa vie de service par un non-éclairage à cause de certains impacts, d'imperfections ou d'une détérioration due aux heures d'utilisation.
- La vie de service d'une lampe au mercure varie individuellement et selon les conditions d'utilisation.
- Dans de rares cas, elle peut éclater un peu après son premier allumage.
- La possibilité d'un éclatement augmente quand la lampe est utilisée au-delà du temps de remplacement.

Nettoyage et maintenance

Débranchez bien la fiche du cordon d'alimentation de la prise avant le nettoyage.

Utilisez un chiffon doux et sec pour nettoyer le coffret

Pour les taches rebelles, utilisez un chiffon humidifié de solution détergente de cuisine (neutre) et essorez-le pour essuyer le coffret; finissez avec un chiffon sec. En cas d'utilisation d'un produit chimique, suivez ses instructions.

Ne nettoyez pas la surface de l'objectif avec un chiffon pelucheux ou poussiéreux.

Si de la poussière adhère à l'objectif, elle sera grossie et projetée sur l'écran. Utilisez un chiffon doux et sec pour éliminer la poussière.

Remplacement de la lampe

Attention !

Le remplacement de la lampe ne doit être réalisé que par un technicien qualifié.

Attention !

Lorsque vous remplacez la lampe, laissez-la refroidir au moins une heure avant de la manipuler.

Précautions pour le remplacement de la lampe

Retirez la fiche du cordon d'alimentation et assurez-vous que la section qui entoure la lampe est refroidie.

- Soyez prudent en manipulant la lampe source de lumière. La lampe peut éclater si elle est heurtée par des objets solides ou si elle tombe à cause de la forte pression d'air dans l'ampoule.
- Une lampe usée peut éclater si elle est manipulée sans soin.
Contactez une entreprise d'évacuation des déchets industriels pour l'enlèvement des lampes usées.
- Ne remettez pas à zéro la durée cumulée, à moins que le bloc lampe n'ait été remplacé par un bloc lampe neuf.
- Si vous persistez à utiliser une lampe après le moment où elle aurait dû être remplacée, la lampe peut casser.
- Un tournevis Philips est requis pour le remplacement de la lampe.
Faites attention que votre main ne glisse pas en utilisant le tournevis.

Attention

- La lampe est une pièce en option. Contactez le revendeur.
Bloc de lampe de rechange, modèle n°: ET-LAD35 (une ampoule)
Valeurs nominales: 300 W
Bloc de lampe longue durée, modèle n°: ET-LAD35L (une ampoule)
Valeurs nominales : 160 W
- Des lampes autres que celles spécifiées ci-dessus ne sont pas utilisables. Utilisez la lampe spécifiée.

■ Période de remplacement de la lampe

La lampe utilisée comme source lumineuse dans le projecteur a une vie de service de 1 500 heures*¹ (quand la sortie de la lampe est HAUT). Il peut arriver que la lampe soit épuisée (ne s'allume pas) à 1 500 heures*¹ selon les caractéristiques des lampes individuelles et les conditions de travail (la vie de service des lampes peut être réduite par le nombre d'allumages et les intervalles entre les allumages). Il est donc fortement conseillé aux utilisateurs de conserver une ampoule de rechange.

Si la lampe n'est pas remplacée après 1 300 heures*² (avec la sortie de lampe réglée sur "CHAUD"), l'alimentation sera automatiquement coupée à 1 500 heures*¹, avec passage en mode d'attente. 1 500 heures*¹ à partir de l'allumage initial, l'alimentation est automatiquement coupée environ 10 minutes plus tard, avec passage en mode d'attente, même si la lampe est allumée à nouveau.



● Indication après 1 300 heures*² (avec la sortie de lampe réglée sur "CHAUD")

Quand la lampe a été utilisée 1 300 heures*², le témoin de lampe (LAMPE) s'allume, état d'attente y compris.

Une indication sur écran apparaîtra également environ 30 secondes comme indiqué dans le diagramme de droite, recommandant le remplacement de la lampe. (L'indication dans le diagramme de gauche disparaîtra après environ 30 secondes ou quand une touche de commande du panneau supérieur de l'appareil ou une touche de la télécommande est opérée.)

Après 1 500 heures*¹, l'indication sur écran ne disparaîtra pas à moins d'une opération de la touche MENU.

*¹ Cette période est de 4 000 heures lorsque des blocs lampes longue durée sont utilisés.

*² Cette période est de 3 800 heures lorsque des blocs lampes longue durée sont utilisés.

■ Procédure de remplacement de la lampe

Attention • Au bout de 1 500 heures (4 000 heures lorsque des blocs lampes longue durée sont utilisés) de fonctionnement pour une même lampe, le projecteur ne peut plus fonctionner que pendant environ 10 minutes. Les étapes ⑧ à ⑬ doivent être achevées en moins de 10 minutes.

- ① **Mettez hors tension en suivant la procédure de la page 23, débranchez la fiche électrique et vérifiez que les éléments autour de la lampe ont refroidi.**

Assurez-vous que le ventilateur est arrêté.

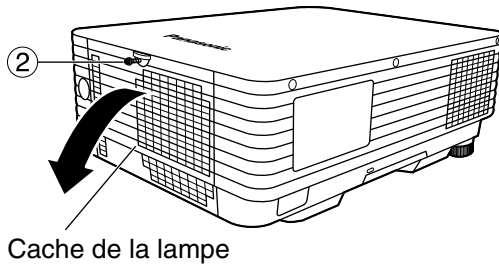

Préparez un tournevis Phillips à l'avance.

- ② **Desserrez la vis fixant le cache de la lampe, puis ouvrez le cache.**

Remarque • Vous pouvez fixer temporairement le cache de la lampe en position ouverte. En glissant le cache dans le sens de la flèche, vous pouvez fixer temporairement le cache ou le libérer.

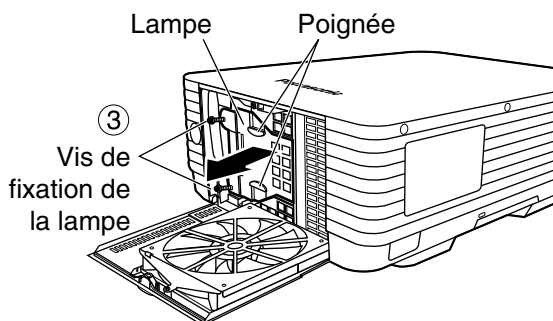
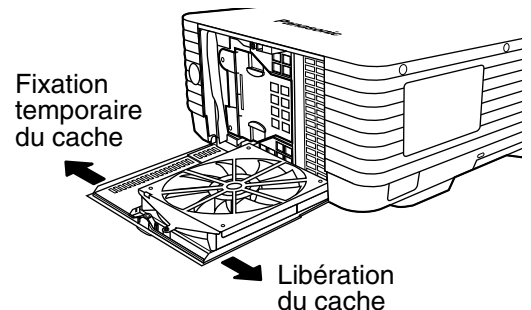

- ③ **Desserrez les deux vis de fixation de la lampe, saisissez les poignées et retirez la lampe.**

- ④ **Installez la nouvelle lampe.**

Insérez la lampe en appuyant dessus avec une force égale des côtés gauche et droit.

- ⑤ **Utilisez un tournevis Phillips pour serrer correctement les deux vis de fixation de la lampe.**

- ⑥ **Fermez le cache de la lampe en poussant sur le coin supérieur droit jusqu'à ce qu'il émette un léger bruit sec. Serrez solidement la vis fixant le cache de la lampe.**

Attention • La lampe et le cache doivent être correctement fixés. Si ce n'est pas le cas, un circuit de protection entre en action et la mise sous tension sera impossible.

Attention

La lampe est chaude si elle vient d'être utilisée.

Vous risquez de vous brûler si vous la touchez alors qu'elle est encore chaude.

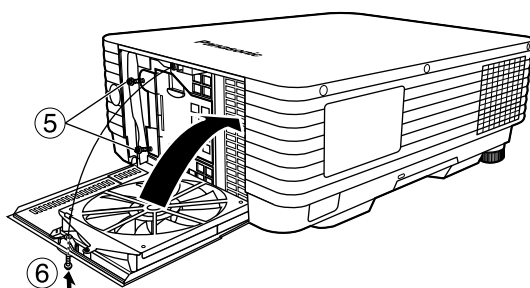

- ⑦ Branchez la fiche du cordon d'alimentation dans la prise murale et actionnez l'interrupteur MAIN POWER.

Attention • Si la mise sous tension ne s'effectue pas même une fois que vous avez positionné l'interrupteur principal sur "I", remettez ce dernier sur "O", vérifiez que la lampe et son cache sont correctement installés et rallumez.

- ⑧ Appuyez sur la touche "POWER" (ou sur la touche POWER OFF (I) de la télécommande) afin de projeter une image sur l'écran.

MENU	
IMAGE	
POSITION	
MENU AVANCÉ	
AUDIO	
LANGAGE [LANGUAGE]	
OPTION1	
OPTION2	
MIRE DE TEST	

- ⑨ Appuyez sur la touche "MENU" pour afficher l'écran du MENU, puis utilisez les touches ▲ et ▼ pour amener le curseur sur "OPTION2" et sélectionner cette option.

INFORMATION SYSTÈME	
VERSION ROM	1.00.00
VALID. DURÉE	300h
LAMP FAIBLE	100h
FORTE	200h
TOTAL	300h

- ⑩ Appuyez sur la touche "ENTER" pour afficher l'écran "OPTION2", et sélectionnez "INFORMATION SYSTÈME" avec les touches ▲ et ▼.

- ⑪ Appuyez sur la touche "ENTER".

L'écran INFORMATION SYSTÈME apparaît.

INIT. COMPT	
LAD35	1433h
LAD35L	0h

- ⑫ Maintenez presse la touche "ENTER" sur le projecteur ou sur la télécommande pendant environ 3 secondes.

L'article "INIT. COMPT" sera ajouté.

- ⑬ Appuyez sur la touche ENTER et lorsque l'affichage "INIT COMPT" clignote, appuyez de nouveau sur la touche ENTER.

Les heures d'utilisation de la lampe seront remises à zéro.

Remarque • Lorsque l'affichage "INIT. COMPT" clignote, la remise à zéro du temps de la lampe peut être annulée en appuyant sur la touche MENU.

Panasonic[®]

Professional/Industrial Video

Panasonic Broadcast & Television Systems Company

Division of Matsushita Electric Corporation of America

One Panasonic Way 4E-7 Secaucus, NJ 07094 (201) 392-4443
3330 Cahuenga Blvd West Los Angeles, CA 90068 (323) 436-3500

Technical Support:

(800) 524-1448

(800) 526-6610

FAX: (201) 392-6514

E-Mail: pbtssupport@panasonic.com

Panasonic Canada Inc.

5770 Ambler Drive, Mississauga, Ontario L4W 2T3 (905) 624-5010

©Matsushita Electric Industrial Co., Ltd. 2005