

myprojectorlamps.com

**The most trusted, dependable name
in projector lamp sales.**



<http://www.myprojectorlamps.com>



<http://www.myprojectorlamps.ca>



<http://www.myprojectorlamps.eu>

The following projector manual has not been modified or altered in any way.

Panasonic

LCD PROJECTOR Operating Instructions

Model No. **PT-LC50E**



Please read these instructions completely before operating this LCD Projector.

By clicking on the red highlighted words in this document, you can go directly to a support page.

Dear Panasonic Customer:

This instruction manual provides all the necessary operating information that you might require. We hope it will help you to get the most performance out of your new product, that you will be pleased with your Panasonic LCD Projector.

For your own protection and prolonged operation of your LCD Projector, please be sure to read the “**Important Safeguards**” carefully, before use.

Things You Should Know

Caution:

This equipment has been tested and found to comply with the limits for a Class B digital device, pursuant to Part 15 of the FCC Rules. These limits are designed to provide reasonable protection against harmful interference in a residential installation. This equipment generates, uses, and can radiate radio frequency energy and, if not installed and used in accordance with the instructions, may cause harmful interference to radio communications. However, there is no guarantee that interference will not occur in a particular installation. If this equipment does cause harmful interference to radio or television reception, which can be determined by turning the equipment off and on, the user is encouraged to try to correct the interference by one or more of the following measures:

- Reorient or relocate the receiving antenna.
- Increase the separation between the equipment and receiver.
- Connect the equipment into an outlet on a circuit different from that to which the receiver is connected.
- Consult the dealer or an experienced radio/TV technician for help.

Things You Should Know

Declaration of Conformity (USA only)

Model Number: PT-LC50E

Trade Name: **Panasonic**

Responsible party: Matsushita Electric Corporation of America.

Address: One Panasonic Way Secaucus New Jersey 07094

Telephone number: 1-800-528-8601

This device complies with Part 15 of the FCC Rules, Operation is subject to the following two conditions: (1) This device may not cause harmful interference, and (2) this device must accept any interference received, including interference that may cause undesired operation.

FCC Warning: (USA only)

To assure continued FCC compliance, use only the provided grounded power supply cord and prevent undesirable interference, use only the provided shielded VGA cable with 2 ferrite cores while connecting LCD to computer and all other connecting cables should be shielded. Any changes or modifications not expressly approved by the party responsible for compliance could void the user's authority to operate this equipment.

Warning: (E.U. only)

To assure continued CE Mark compliance, use only the provided earthed power supply cord and prevent undesirable interference, use only the provided shielded VGA cable with 2 ferrite cores while connecting LCD to computer and all other connecting cables should be shielded.

Any changes or modifications not expressly approved by the party responsible for compliance could void the user's authority to operate this equipment.

© 2000 Matsushita Electric Industrial Co., Ltd

All product/brand names are trademarks or registered trademarks of the respective holders.

Important Safeguards



CAUTION: Please read all of these instructions before you operate your LCD Projector. Save these instructions for future reference.

Machine Noise Information Ordinance 3. GSGV, January 18, 1991: The sound pressure level at the operator position is equal or less than 44 dB (A) according to ISO 7779. (However, this is when the ambient temperature is less than 30 °C.)

Electrical energy can perform many useful functions. This LCD Projector has been engineered and manufactured to meet applicable safety standards. But **IMPROPER USE CAN RESULT IN POTENTIAL ELECTRICAL SHOCK OR FIRE HAZARDS.** In order not to defeat the safeguards incorporated into this LCD Projector, observe the following basic rules for its installation, use and servicing.

- 1** Unplug the LCD Projector from the wall outlet before cleaning.
- 2** Do not use liquid cleaners or aerosol cleaners. Use a soft dry cloth to clean the LCD Projector unit. If the unit is very dirty, wet a cloth with neutral detergent, squeeze it tight, wipe the unit with it, and finish by wiping with a dry cloth. Do not use a chemical duster or polisher-cleaner because it can adversely affect the unit and peel the paint coat.
- 3** Do not use attachments not recommended by Panasonic, as they may cause hazards.

Important Safeguards

- 4 Do not use the LCD Projector near water; for example, near a bathtub, washbowl, kitchen sink, laundry tub, in a wet basement, near a swimming pool, etc. Never spill liquid into the LCD Projector.
- 5 Do not place the LCD Projector on an unstable cart, stand, or table. The LCD Projector may fall, which may cause serious injury to a child or an adult, and/or serious damage to the unit. Use only with a cart or stand recommended by its manufacturer, as being suitable for use with the LCD Projector.
- 6 The LCD Projector equipment and cart combinations should be moved with care. Quick stops, excessive force, and uneven surfaces may cause the equipment and cart combination to overturn.
- 7 Slots and openings in the cabinet back and bottom are provided for ventilation. To ensure reliable operation of the LCD Projector and to protect it from overheating, these openings must not be blocked or covered. These openings should never be covered with cloth or other material. The bottom opening should not be blocked by placing the LCD Projector on a bed, sofa, rug, or other similar surface. The LCD Projector should not be placed near or over a radiator or heating vent. The LCD Projector should not be placed in a built-in installation such as a bookcase unless proper ventilation is provided.



Important Safeguards

- 8** The LCD Projector should be operated only from the type of power source indicated on the back of the LCD Projector or in the specifications. If you are not sure of the type of power supplied to your home, consult your LCD Projector dealer or local power company.
- 9** Do not allow anything to rest on the power cord. Do not place the LCD Projector where the cord will be walked on.
- 10** Follow all warnings and instructions marked on the LCD Projector.
- 11** As a safety feature, the LCD Projector is equipped with a 3-prong grounded plug. The 3-prong grounded plug will fit only into a grounding type power outlet. If the plug does not fit, use an adaptor that is properly grounded or have an electrician install a grounded type outlet. Do not attempt to modify this AC plug.
- 12** For added protection of the LCD Projector during a lightning storm, or when it is left unattended or not in use for long periods of time, unplug it from the wall outlet and disconnect any cable systems. This will prevent damage to the projector due to lightning and power-line surges.
- 13** Do not overload wall outlets and extension cords with too many products, because this can result in fire or electric shock.

Important Safeguards

- 14** Never push objects of any kind into the LCD Projector through cabinet slots as they may touch dangerous voltage points or short out parts, which could result in a fire or electric shock.
- 15** Do not attempt to service the LCD Projector yourself. Opening or removing covers may expose you to dangerous voltage or other hazards. Refer all servicing to qualified service personnel.
- 16** Unplug the LCD Projector equipment from the wall outlet and refer servicing to qualified service personnel under the following conditions:
 - A. When the power cord or plug is damaged or frayed.
 - B. If liquid has been spilled into the LCD Projector.
 - C. If the LCD Projector has been exposed to rain or water.
 - D. If the LCD Projector does not operate normally when you follow the operating instructions. Adjust only those controls that are covered by the operating instructions; improper adjustment of other controls may cause damage and will often require extensive work by a qualified technician to restore the LCD Projector to normal operation.
 - E. If the LCD Projector has been dropped or the cabinet has been damaged.
 - F. When the LCD Projector exhibits a distinct change in performance – this indicates a need for service.

Important Safeguards



- 17** Upon completion of any service or repairs to the LCD Projector, ask the service technician to perform a routine safety check to determine that the LCD Projector is in safe operating condition.
- 18** When replacement parts are required, be sure the service technician has used replacement parts specified by the manufacturer that have the same characteristics as the original parts. Unauthorized substitutions may result in fire, electric shock, or other hazards.
- 19** Air filter should be cleaned every 100 lamp on hours. The LCD Projector may become too hot if filter is not cleaned when required.
- 20** If lens becomes dirty, or smudged, clean with a clean, dampened cloth. Never touch the lens with your fingers.
- 21** Do not look directly into the aperture and lens while operating as this may result in damage to your eyes.

Important Safeguards

IMPORTANT: THE MOULDED PLUG (U.K. only)

FOR YOUR SAFETY, PLEASE READ THE FOLLOWING TEXT CAREFULLY.

This appliance is supplied with a moulded three pin mains plug for your safety and convenience. A 13 amp fuse is fitted in this plug. Should the fuse need to be replaced, please ensure that the replacement fuse has a rating of 13 amps and that it is approved by ASTA or BSI to BS1362.

Check for the ASTA mark  or the BSI mark  on the body of the fuse.

If the plug contains a removable fuse cover, you must ensure that it is refitted when the fuse is replaced.

If you lose the fuse cover, the plug must not be used until a replacement cover is obtained.

A replacement fuse cover can be purchased from your local Panasonic Dealer.

If the fitted moulded plug is unsuitable for the socket outlet in your home, then the fuse should be removed and the plug cut off and disposed of safely. There is a danger of severe electrical shock if the cut off plug is inserted into any 13 amp socket.

If a new plug is to be fitted, please observe the wiring code as shown below.

If in any doubt, please consult a qualified electrician.

Important Safeguards

WARNING: – **THIS APPLIANCE MUST BE EARTHED.**

IMPORTANT: – The wires in this mains lead are coloured in accordance with the following code: –

Green-and-Yellow: Earth

Blue: Neutral

Brown: Live

As the colours of the wire in the mains lead of this appliance may not correspond with the coloured markings identifying the terminals in your plug, proceed as follows.

The wire which is coloured GREEN-AND-YELLOW must be connected to the terminal in the plug which is marked with the letter E or by the Earth symbol \perp or coloured GREEN or GREEN-AND-YELLOW.

The wire which is coloured BLUE must be connected to the terminal in the plug which is marked with the letter N or coloured BLACK.

The wire which is coloured BROWN must be connected to the terminal in the plug which is marked with the letter L or coloured RED.

How to replace the fuse. Open the fuse compartment with a screwdriver and replace the fuse.

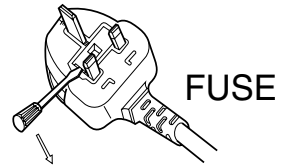

LCD Projector Features

1 **Compact & Lightweight**

This LCD Projector is lightweight and compact allowing you to give presentations at any location.

2 **Built-in Simple Stand**

The Built-in Simple Stand makes it possible to match the projection angle with the basic use environment of your office with one-touch ease.

3 **Attachable/Removable Swivel Stand**

Flexible settings are possible because the projected image height and left/right tilt can be adjusted freely.

4 **One-touch Auto Setup**

One-touch image adjustments of RGB input can be made. The unit detects the condition (up/down) of the simple stand and automatically corrects keystone distortion.

5 **Compatible with most Personal Computers**

The RGB input accepts signals from VGA, SVGA, XGA, SXGA, and Macintosh compatible computers with no additional hardware.

6 **Supports Component Video (YPbPr) Input**

This unit supports progressive DVD and HDTV (480 i/480 p/625 i/720 p/1080 i) when components are connected.

LCD Projector Features

7 Accommodates all International Broadcast Video Signal Formats

The LCD Projector accepts NTSC/PAL/SECAM/PAL-M/PAL-N/NTSC4.43 video signal formats.

8 Digital Zoom and Freeze Feature

With remote control operation, you can display a enlarged portion of the screen up to 5 times. You can also display a freeze frame (paused) screen.

9 On-board Card Type Wireless Remote Control

Keys necessary for basic operation have been simply arranged on this compact remote control which can be stored neatly in the unit.

10 On Screen Display

In addition to English, you can select German, French, Spanish, Italian, Japanese, and Chinese.

11 Automatic Universal Power Supply

This unit has an operating voltage range of AC 100 V - 240 V.

12 CD-ROM Manual

Because this is an electronic manual, by simply clicking on the link given for each item of information, you can go directly to the related page for instructions.

LCD Projector Features

13 Image Quality Select Feature, R/G/B Level Adjust Feature

With the Image Quality mode switch (Dynamic/Natural) you can also fine-adjust the white balance of the projected image.

14 Full Function Remote Control Unit for LCD Projector (optional)

A full function remote control unit for LCD Projector. With built-in wireless mouse and laser pointer is available.

15 Frontal Air Vent Design

Vented air will not blow on persons located to the side or in rear of the projector and light leakage will not be a problem with the Frontal Air Vent design.

Equipped with a variety of convenient functions

A variety of functions such as the following have been provided.

- A blue screen is projected (at start-up only) when no signal is being input.
- Freeze functions for video and audio signals can be toggled on and off.
- The input signal display function can be toggled on and off.
- 16:9 (wide) screen projection is provided.
- Two projection modes (directions) to choose from.

Contents of LCD Projector Box

Please confirm that the following items are packed in the LCD Projector box.

They are provided to help you use or set up your LCD Projector.

- (1) LCD Projector
- (2) Wireless Remote Control Unit (LSSQ0275)
- (3) CR2025 Lithium Battery (Included with the remote control unit)
- (4) 2.44 m Power Cord (VJAS0188)
- (5) 2.35 m Power Cord (VJAS0189)
- (6) VGA Cable (LSJA0239)
- (7) Video Cable (LSJA0074)
- (8) Audio Cable (LSJA0240)
- (9) Lens Cap (Included with the projector)
- (10) Carrying Bag (LSFC0015)
- (11) Swivel Stand (LSYC0162)
- (12) CD ROM (Operating Instructions)
- (13) Quick Reference Manual

Product Information

LCD Projector

Labels on the unit are omitted.

■ Top, right and front (In case Swivel stand is installed.)

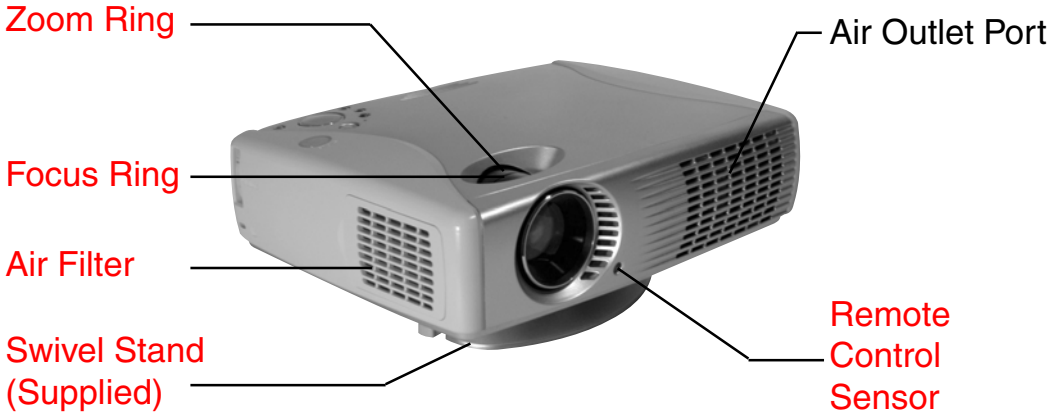

■ Back and bottom

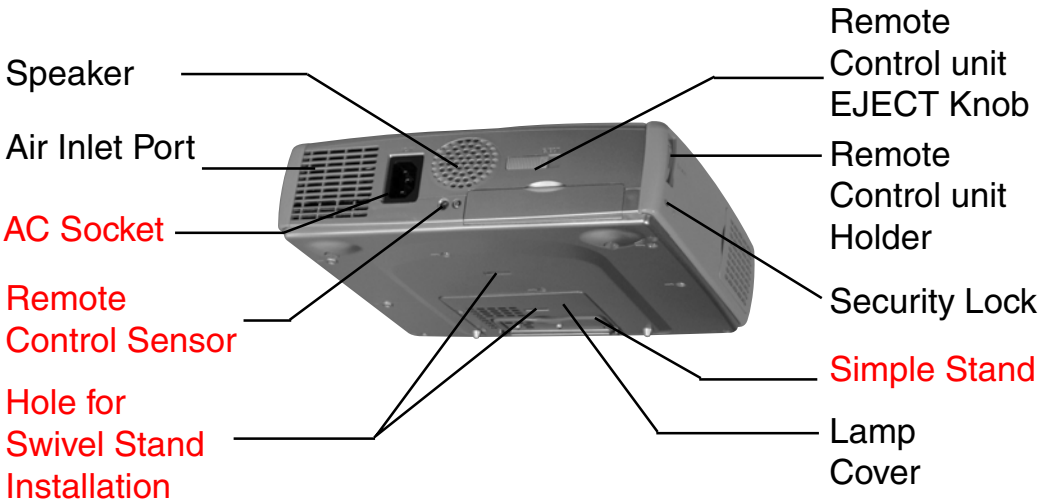

MicroSaver and Kensington are registered trademarks of Kensington Technology Group. All product names mentioned in this document are trademarks or registered trademarks of their respective owners.

© 1998 Kensington Technology Group.

Kensington Technology Group
2885 Campus Drive
San Mateo, CA 94403, U.S.A

Phone: (650)572-2700

Fax: (650)572-9675

Product Information

LCD Projector

Control panel

POWER Indicator
STANDBY (RED)
ON (GREEN)

POWER Button

STATUS Code
Indicator

INPUT
Button

KEystone
Button

MENU
Button

Adjust ▲▼◀▶
Buttons
(Also used for
Volume -/+)

ENTER
Button



Product Information

LCD Projector

■ Connector panel

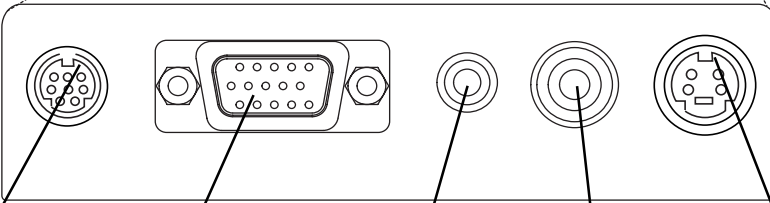

RS232C
SERIAL
Connector

RGB/YPbPr IN
RGB/YPbPr
Input
Connector

AUDIO IN
Audio
Input
Connector

VIDEO IN
Video
Input
Connector

S-VIDEO IN
S-Video
Input
Connector

Note

The serial connector which is on the terminal board of the projector conforms to the RS-232C interface specification, so that the projector can be controlled by a personal computer which is connected to this connector.

Product Information

Remote Control unit

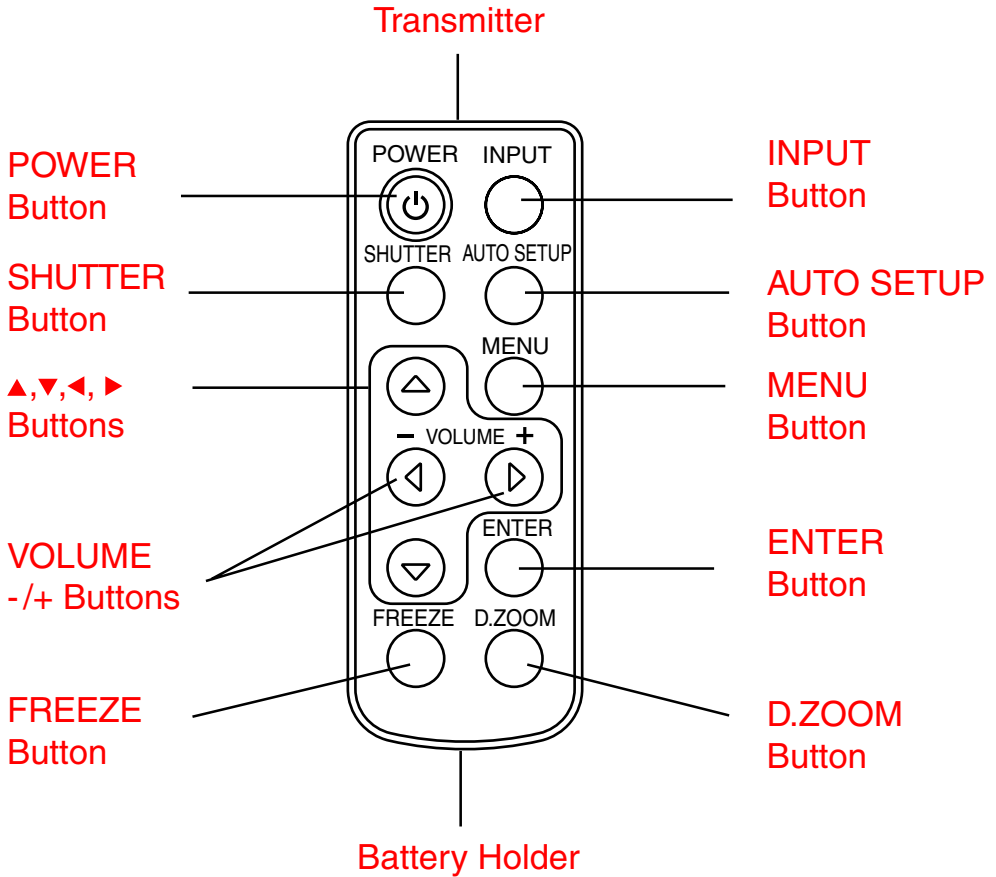

Note

When you purchase the optional full functional remote control unit (ET-RMLC50), you can enjoy the wireless mouse and laser pointer features.

Before using the Remote Control Unit

Remote Control comes with battery inside. Please remove white protective film before use.

■ Replacing the battery

Insert the new lithium battery making sure the polarities (+) and (-) are correct.

WARNING:

Replace battery with CR2025 only. Use of another battery may present a risk of fire or explosion.

Caution: Battery may explode if mistreated. Dispose of used battery promptly. Keep away from children. Do not recharge, disassemble or dispose of in fire.

- 1 While pushing the battery holder tab to the left, pull out the battery holder.

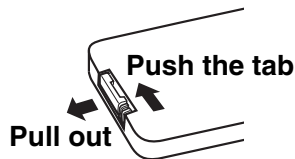

- 2 Insert the battery into the battery holder so that the + side is facing upward.

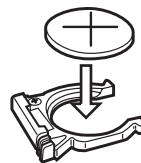

- 3 Insert the battery holder.

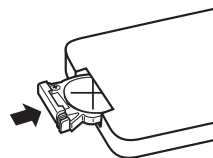

Note

- Do not drop the remote control unit.
- Keep the remote control unit away from liquids.
- Remove the battery if not using the remote control unit for long periods.

Before using the Remote Control Unit

■ Operating range

If the remote control unit is held so that it is facing directly in front of the front or rear remote control signal receptors, the operating range is within approximately 7 m (23 ft) from the surfaces of the receptors. Furthermore, the remote control unit can be operated from an angle of $\pm 30^\circ$ to the left or right and $\pm 15^\circ$ above or below the receptors. (In this case, the operating range is shortened.)

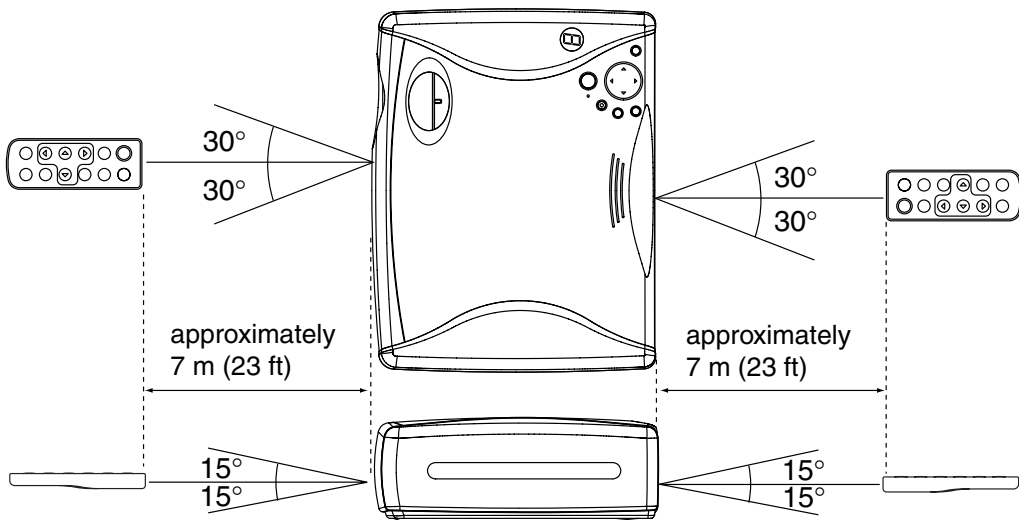

Note

- If there are any obstacles in between the remote control unit and the receptors, the remote control unit may not operate correctly.
- If strong light is allowed to shine onto the remote control signal receptor, or if there are any obstacles between the remote control signal receptor and the remote control unit, correct remote control operation may not be possible.
- If facing the remote control unit toward the screen to operate the projector, the operating range of the remote control unit will be limited by the amount of light reflection loss caused by the characteristics of the screen used.

Attaching and Removing the Swivel Stand

A swivel stand can be attached to or removed from the LCD Projector. When attached, you can fine-adjust the projection angle. To attach or remove the swivel stand, follow the steps below.

•Attachment

- 1 Place the unit upside down. Place the unit on a flat, stable surface covered with a soft cloth, etc.

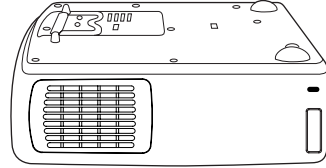

- 2 1) First, insert the swivel base into the front openings of the projector.
2) Then, while pressing the PUSH Button, insert into the rear openings.

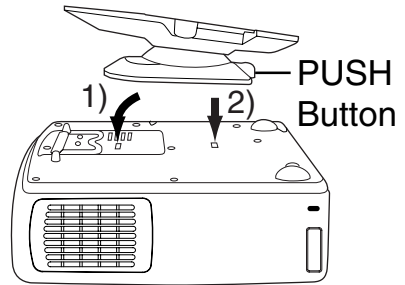

•Removal

- 1 Place the unit upside down. Place the unit on a flat, stable surface covered with a soft cloth, etc.

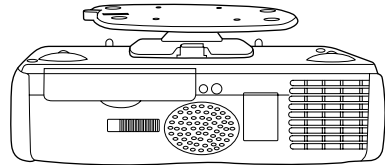

- 2 While pressing the PUSH Button, remove the Swivel stand.

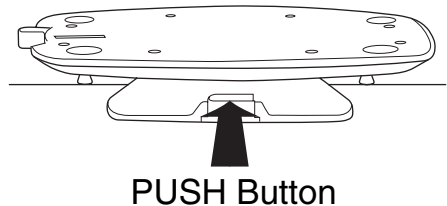

Caution:

Never pick the unit up by the swivel stand.

System Configuration Example

■ Example of connection to audio-visual equipment

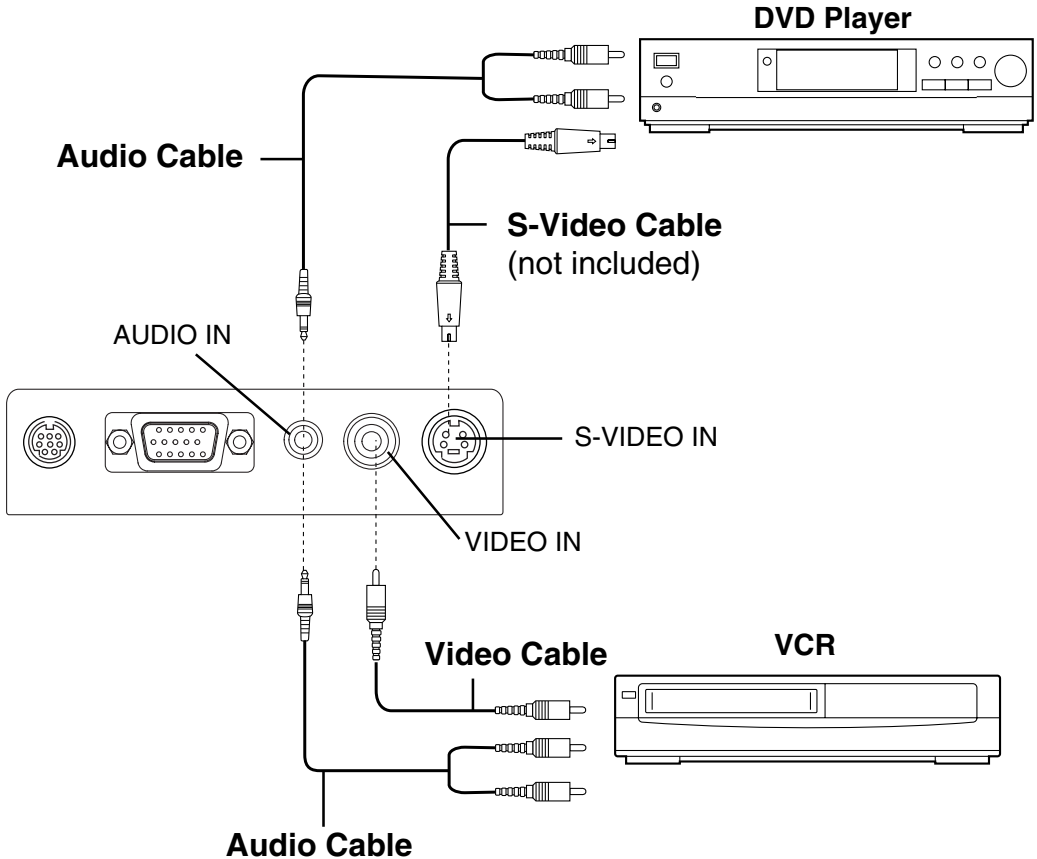

Note

- Only one audio system circuit is available for the AUDIO IN jack, so if you wish to change the audio input source, you will need to remove and insert the appropriate plugs.
- If the video signal source is connected using a cable with a BNC junction plug, use the BNC-RCA Adaptor (not included) to convert the pin jack.

System Configuration Example

■ Example of connection to a Personal Computer

Personal Computer

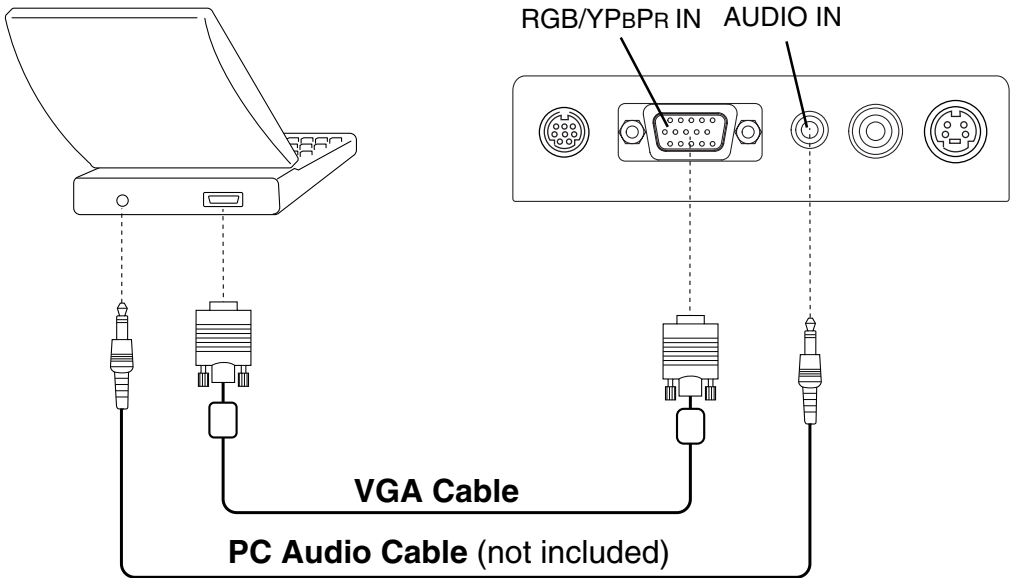

Note

- When using the PC Plug & Play feature, first, attach the AC cord to the LCD Projector and turn the projector power on. Then, turn the PC power on.
- When LCD Projector power is turned off, turn the personal computer off as well.
- Refer to the “**Signals that can be Input**” for types of RGB signals which can be input to the projector by connecting a personal computer.

System Configuration Example

■ Connecting D-sub15-BNC5 (female) Adaptor Cable

The Component signal (YPbPr signal) can be input and projected with this LCD Projector. Please read the operating instructions regarding the output side of the component when connecting.

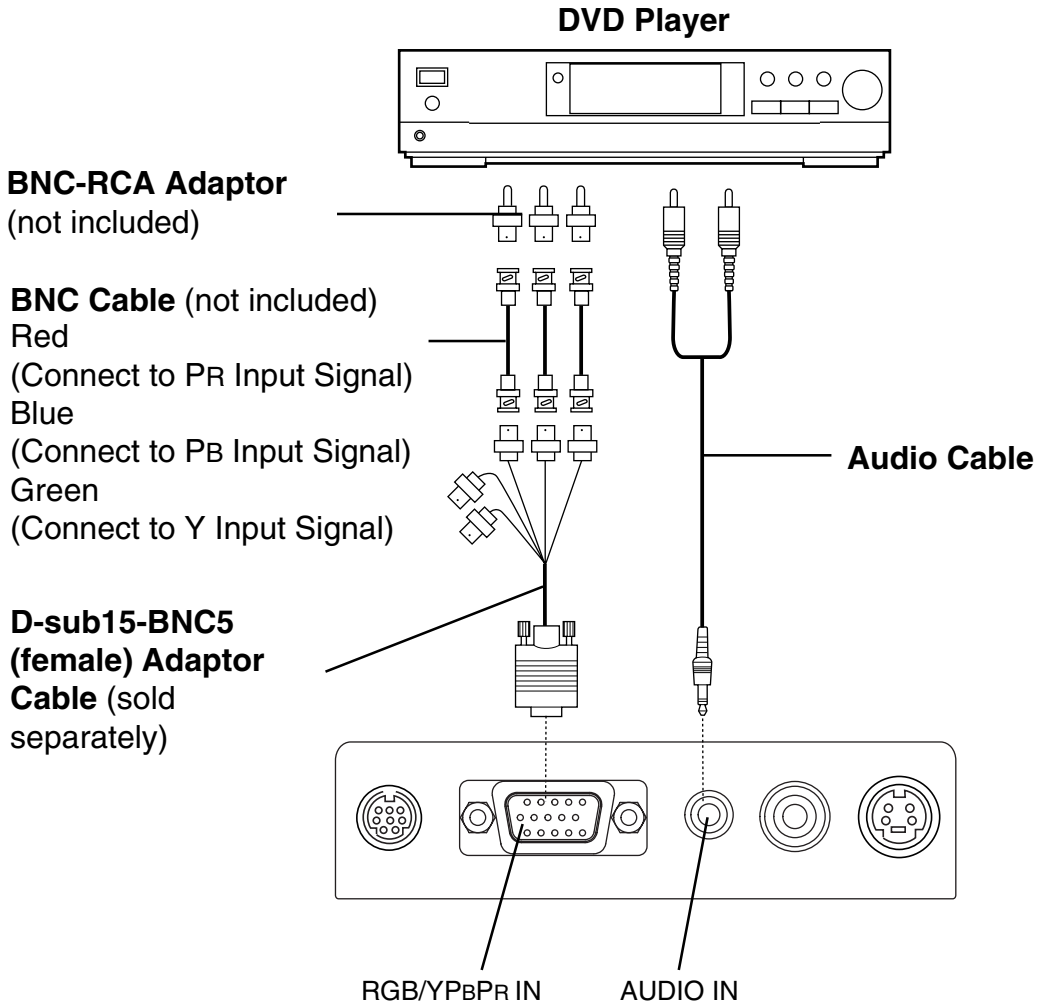

System Configuration Example

Notes on system configuration

- Turn off the power supply of each system component before connecting any of the components.
- Read the instruction manual for each system component before connecting it.
- If the cables necessary for connecting a component to the system are not included with the component or available as an option, you may need to fashion a cable to suit the component concerned.
- If there is a lot of jitter in the video signal input from the video source, the picture on the screen may flicker. In such cases, it will be necessary to connect a TBC (time base corrector).
- It may not be possible to connect some types of personal computer.

Note

- Because each Y, PB, and PR signal is input independently, the Component signal allows for more faithful color reproduction.
- The Component signal output terminal indication will differ according to the output device (PR, PB, Y/R-Y, B-Y, Y/Cr, Cb, Y, etc.). Please read the operating instructions included with the output device.
- You need to change the input signal setting on this LCD Projector when inputting the Component signal. In this case, please refer to “**Setting of the RGB/YPBPR Input Signal Selection**”.
- D-sub15-BNC5 (female) Adaptor Cable (sold separately) often have BNC connectors, however a DVD output device usually has RCA jacks. In this case, you will need BNC-RCA adaptors (not included).

Setting-up Positions

There are two ways of installing this projector as shown next page. This section explains the standard case of the floor-mounted front projection.

(The projection method can be set from the MENU screen. Refer to the “[Changing the Projection Mode](#)”.)

Caution: When you set up the LCD Projector

- Do not place it in humid or dusty places, or places where the air is sooty or full of cigarette smoke. If the lens, mirror, or other optical components become dirty, the picture will blur or darken, making viewing difficult.
- Do not expose to extreme heat or cold. Operating temperature: 0 °C – 40 °C (32 °F – 104 °F)

Preparation

- Refer to “[screen size and required distance](#)”.
- Select a room that can be darkened.

Setting-up Positions

Front projection

Viewing a picture projected on the front of the screen from a floor.

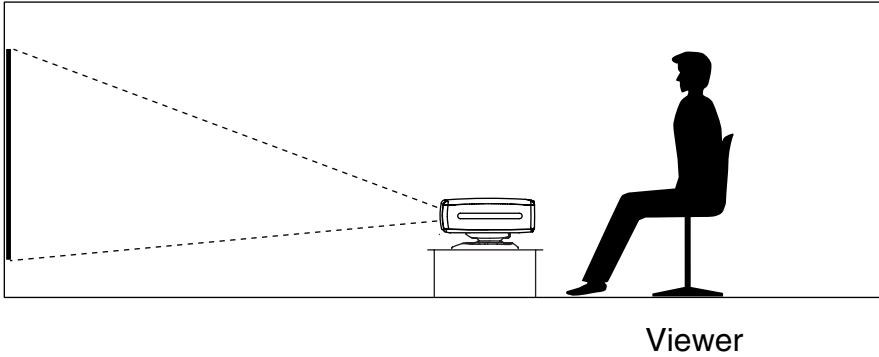

Rear projection

Viewing a picture projected through the back of the screen from a floor installation.

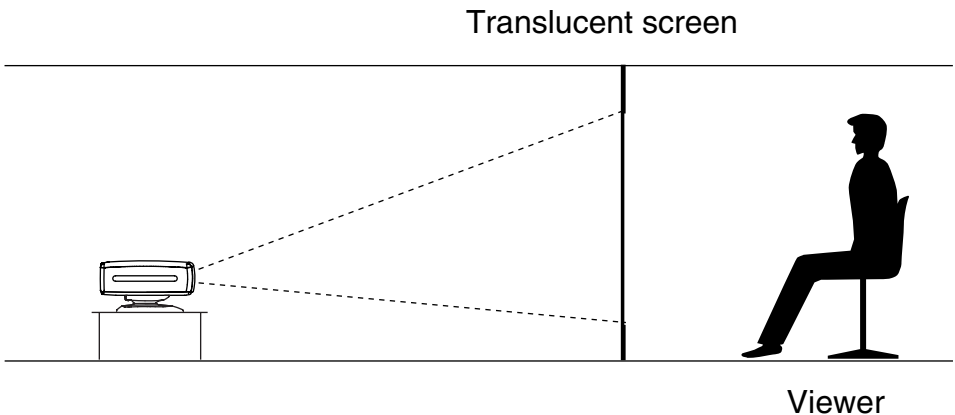

Setting-up Positions

■ screen size and required distance

The screen should be positioned so that it is not directly touched by sunlight or room light as this will wash out the colors of the picture making it hard to see. When possible, close all blinds, curtains, etc. and dim the lights. Also, the LCD Projector should be at a 90° angle to the screen for the best picture results. To determine the distance for the desired size, please refer to the “**LCD Projector /Screen Relative Position Chart**”.

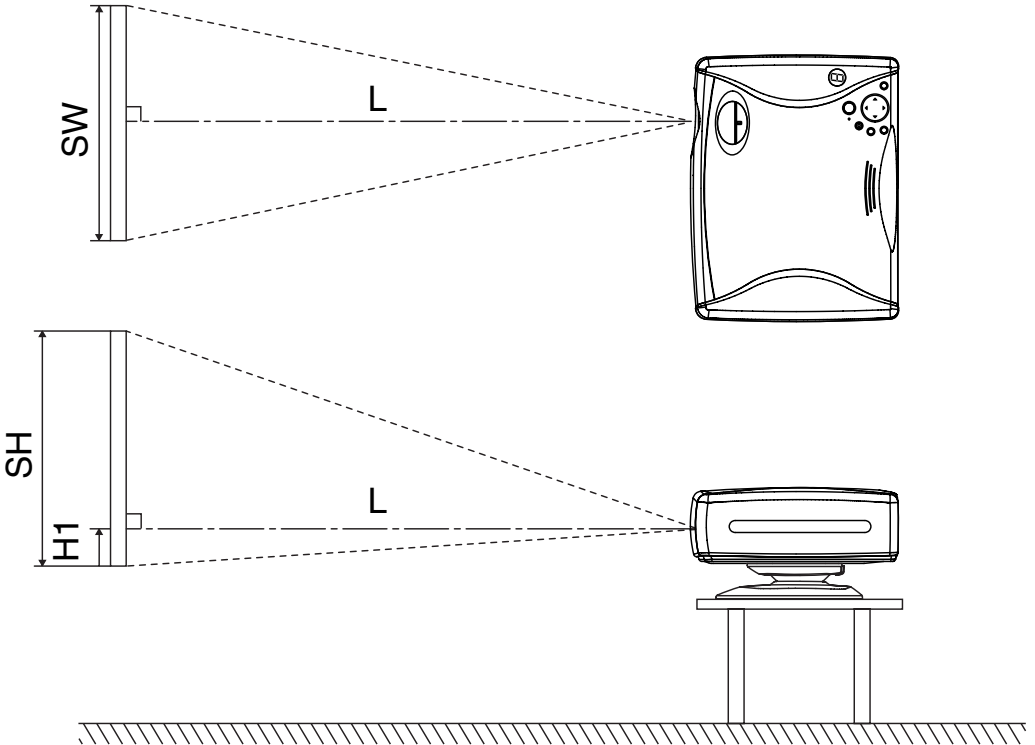

Setting-up Positions

■ LCD Projector /Screen Relative Position Chart

The picture can be adjusted to the desired size within the range of the zoom lens. (The values in the table are reference values.)

Screen type (4:3)			Throw distance (L)		Height position (H1)
Screen size	Width (SW)	Height (SH)	Wide (LW)	Telephoto (LT)	
30 in	0.61 m	0.46 m		1.6 m	6.5 cm
40 in	0.81 m	0.61 m	1.6 m	2.1 m	8.7 cm
60 in	1.22 m	0.91 m	2.4 m	3.1 m	13.1 cm
80 in	1.63 m	1.22 m	3.2 m	4.2 m	17.4 cm
100 in	2.03 m	1.52 m	4.0 m	5.2 m	21.8 cm
150 in	3.05 m	2.29 m	6.0 m	7.8 m	32.7 cm
200 in	4.06 m	3.05 m	8.1 m	10.5 m	43.5 cm
250 in	5.08 m	3.81 m	10.1 m	13.1 m	54.4 cm
300 in	6.10 m	4.57 m	12.1 m	15.7 m	65.3 cm

Setting-up dimensions which are not given in the above table can be calculated using the formulas below.

If the screen size is SD, then the following formula is first used to obtain the screen width (SW).

$$SW (m) = SD \times 0.0254 \div 5 \times 4$$

The value for SW obtained above can then be used with the following functions to calculate the projection distance.

$$LW (m) = 1.98 \times SW$$

$$LT (m) = 2.57 \times SW$$

For 16:9 aspect ratios, the following formula can be used to calculate the screen width (SW) and the projection distance for the wide lens position.

$$SW (m) = SD \times 0.0254 \div 18.36 \times 16$$

Turning the power on and off

Disconnecting the power cord from a wall outlet while the cooling fan is operating, or projecting immediately after power is turned on will shorten the lamp operating life.

POWER Button

**POWER Indicator
STANDBY(RED)
ON(GREEN)**



POWER Button



(Supplied)

Note

- Insert Power Cord into LCD Projector AC socket and connect to properly grounded wall outlet.
- When power is turned off, the cooling fan continues to operate (approximately 60 seconds) in order to cool the projector interior.
- This unit consumes approx. 15 W in OFF condition when plugged into an AC outlet.

Turning the power on and off

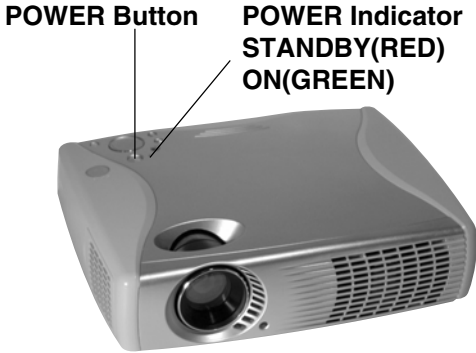

POWER Button



Turning on the power

- 1 Press POWER Button** on the LCD Projector or remote control unit.
- 2** The power indicator will flash, then turn solid green and a picture will be projected onto the screen.

Note

The LCD Projector cannot be turned on for 60 seconds after turning it off.

Turning off the power

- 1 Press POWER Button** on the LCD Projector or remote control unit. "Please press POWER button again to power off." is displayed on the screen, **and then press POWER Button** again.
- 2** The power indicator will illuminate flashing red.
- 3 Wait for the cooling fan to stop.**
The power indicator changes to solid red, the cooling fan stops, and the projector goes into Stand-by mode. (After about 1 minute)

Adjusting the Lens

Refer to the “**LCD Projector/Screen Relative Position Chart**”. After placing the LCD Projector to the throw distance which corresponds with the desired screen size, follow the steps below to adjust the zoom and focus while viewing a projected image.

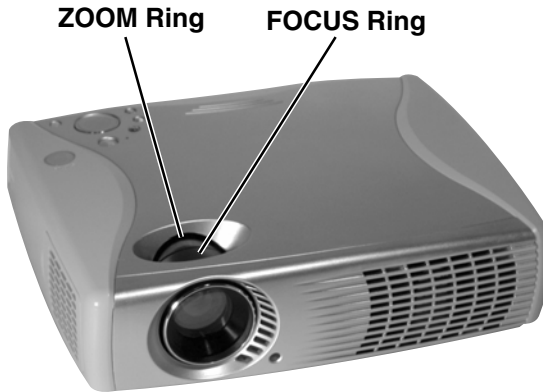

• Adjustment procedure

- 1 Turn the ZOOM Ring** to adjust the size of the picture.
 - When facing the rear of the projector, turn the ring to the right for a smaller picture, or to the left for a larger picture.

- 2 Turn the FOCUS Ring** to adjust the focus of the picture.
 - Turn the ring to the right or left until the picture is at the optimum focus.

- 3 Turn the ZOOM Ring again** to adjust the size of the picture.
 - When you turn the FOCUS Ring, the size of the picture changes.

Menu operations

This section explains how to reach the desired selection or setting screens from the MENU screen.

**When an RGB signal is being projected.
(for white balance adjustment of the red component)**

1 Press the MENU Button.

The Main MENU screen will be displayed.

Use the ▲, ▼ Buttons to select an item, and then **press the ENTER Button.**

The Second MENU screen will be displayed.

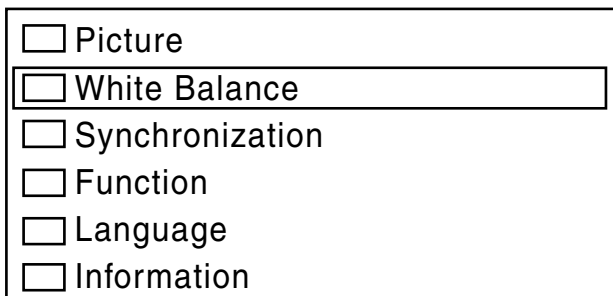

(Main MENU)

2 Press the ▲ or ▼ Buttons

to select an item, and then **press the ◀ or ▶ Buttons** to change or adjust the setting.

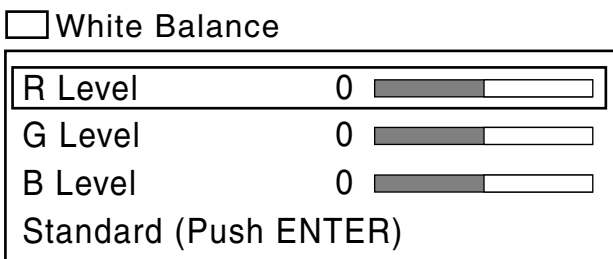

(Second MENU)

Note

- The last adjustment condition is saved and will not be erased even if the power is turned off.
- The value differs with each input signal.

Menu operations

■ Returning to the previous screen

If you press the MENU Button while a menu screen is being displayed, the display will return to the previous screen.

If you press the MENU Button while the Main MENU screen will be cleared.



■ Returning adjustment values to the factory default settings (standard values)

If “Standard” is selected while the “Second MENU” is displayed, the setting can be returned to the factory default setting.

However, the operation of this function varies depending on which screen is being displayed.

Use the ▲ , ▼ Buttons
to select “Standard”,
and then **press the**
ENTER Button.

Picture

Image Quality	•Dynamic •Natural
Brightness	0 
Contrast	0 
Standard (Push ENTER)	

Changing the Projection Mode

The projection mode used by the projector can be changed in accordance with the setting-up position. You may select from two direction types. At the time of shipment from the factory, the projector is set to the “Front” projection mode, but this can be changed if required.

The procedure and on-screen display as shown below are based on RGB as the input signal from a personal computer.

• Selecting procedure

1 Press MENU to display the menu.

2 Press ▲ or ▼ to select “Function”, and then **ENTER** to display the screen.

<input type="checkbox"/> Picture
<input type="checkbox"/> White Balance
<input type="checkbox"/> Synchronization
<input checked="" type="checkbox"/> Function
<input type="checkbox"/> Language
<input type="checkbox"/> Information

3 Press ▲ or ▼ to select “Projection Mode”.

4 Press ◀ or ▶ to select projecting mode.

- Front (Factory setting)
- Rear (Right and Left displays in reverse)

<input checked="" type="checkbox"/> Function	
RGB/YPbPr	•RGB •YPbPr
Projection Mode	•Front •Rear
Expansion	•ON •OFF
On Screen Display	•ON •OFF
Auto Lamp Off	•YES •NO
Standard (Push ENTER)	

Setting the Screen Type

This LCD Projector is compatible with wide screen (16:9 ratio). If a wide screen is used and you set the screen type to 16:9 in order to project a wide (16:9) picture to fill the entire screen, pictures are correctly projected within the screen when projecting older (normal) 4:3 ratio pictures. Please follow the instructions below to set the screen type.

The procedure and on-screen display as below are based on S-VIDEO/VIDEO as the input signal.

• Setting procedure

- 1 Press MENU** to display the menu.
- 2 Press ▲ or ▼** to select “Function”, and then **ENTER** to display the screen.

<input type="checkbox"/> Picture
<input type="checkbox"/> White Balance
<input type="checkbox"/> Video System
<input checked="" type="checkbox"/> Function
<input type="checkbox"/> Language
<input type="checkbox"/> Information

- 3 Press ▲ or ▼** to select “Screen”.
- 4 Press ◀ or ▶** to change the screen type.
 - The 4:3 type screen is set at the factory.

<input type="checkbox"/> Function		
Projection Mode	•Front	•Rear
Screen	•4:3	•16:9
16:9	•ON	•OFF
On Screen Display	•ON	•OFF
Auto Lamp Off	•YES	•NO
Standard (Push ENTER)		

Changing to 16:9 (wide) screen format

When a S-VIDEO/VIDEO or DTV Format (RGB, YPBPR) signals is input, the image can be displayed in 16:9 (wide) screen by the following procedure. This only applies for S-VIDEO/VIDEO and DTV Format signals. The procedure below describes the on-screen displays when the S-VIDEO signal or the VIDEO signal is being projected.

•Selecting procedure

- 1 Press MENU** to display the menu.
- 2 Press ▲ or ▼** to select “Function”, **and then ENTER** to display the screen.



<input type="checkbox"/> Picture
<input type="checkbox"/> White Balance
<input type="checkbox"/> Video System
<input checked="" type="checkbox"/> Function
<input type="checkbox"/> Language
<input type="checkbox"/> Information

- 3 Press ▲ or ▼** to select “16 : 9”.

- 4 Press ◀ or ▶** to select “ON” or “OFF”.
 - Select “OFF” to return the normal screen. (This is the factory setting.)
 - Select “ON” to display in 16:9 (wide) screen.

<input type="checkbox"/> Function	
Projection Mode	•Front •Rear
Screen	•4:3 •16:9
16:9	•ON •OFF
On Screen Display	•ON •OFF
Auto Lamp Off	•YES •NO
Standard (Push ENTER)	

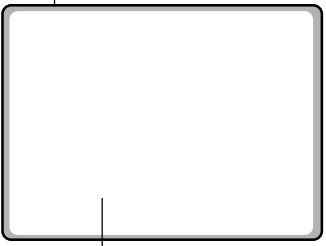
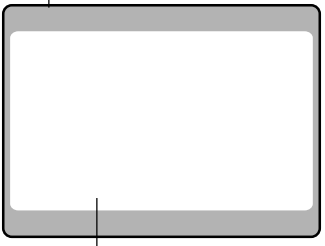
Explanation of Screen Type

	16:9 (Wide) Function OFF	16:9 (Wide) Function ON
4:3 Type Screen	<p>Screen</p>  <p>Projected pictures (4:3)</p>	<p>Screen</p>  <p>Projected pictures (16:9)</p>
16:9 Type Screen	<p>Screen</p>  <p>Projected pictures (4:3)</p>	<p>Screen</p>  <p>Projected pictures (16:9)</p>

Note

Even if the 16:9 (wide) screen feature is set to OFF, when an "S1" signal or DTV Format signal (720 p, 1 080 i) is input, the image is automatically displayed in 16:9 (wide) screen.

Changing the input signal

The input source for picture signals can be changed by pressing the INPUT Buttons on the projector operating panel or on the remote control unit.

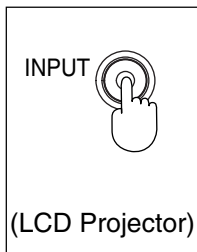

or

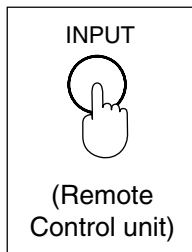

Press the INPUT Buttons

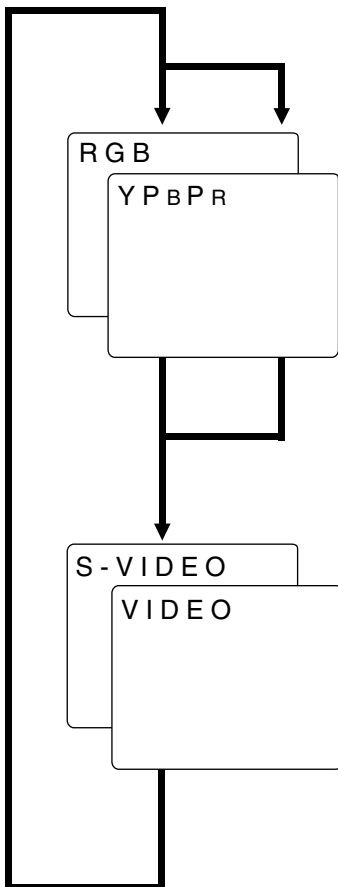

The signal from the source which is connected to the RGB/YPBPR IN connector is projected.

This terminal accepts input of RGB input signals from a personal computer and DTV Format signals (RGB, YPBPR) from a DVD or a digital broadcast. No monitor or projector can automatically decide whether a Component signal is the RGB-type or the YPBPR-type. **So, you will have to select either RGB or YPBPR manually.**

The signal from the source which is connected to the S-VIDEO IN connector or VIDEO IN connector is projected.

If cables are connected to both connectors, the S-VIDEO signal will be selected automatically. (The S-VIDEO signal has priority.)

Changing the input signal

Note

- To turn off the input signal on-screen display, please see “**Turning off the input signal display**”.
- Only one audio system circuit is available for the AUDIO IN jack, so if you wish to change the audio input source, you will need to remove and insert the appropriate plugs.
- The LCD Projector is shipped from the factory with the system format selection function set to “AUTO”. If the correct picture is not projected when S-VIDEO/VIDEO signal is input and it is necessary to change the input to match the input signal, refer to “**S-VIDEO/VIDEO Signal Format Selection**”.
- Please refer to the “**Setting of the RGB/YPBPR Input Signal Selection**” if you change the signal input to the RGB/YPBPR connector.
- When RGB signal is input, **please input the registered signals found**.

Adjusting the LCD Projector projection angle

Adjusting the LCD Projection angle of the LCD Projector. When the projector is in the horizontal position, keystone correction is unnecessary and a correct image can be viewed.

■ Using the simple stand

While lifting up the front of the projector, pull down the simple stand located underneath the unit.



Note

The LCD Projector detects whether the Simple Stand is down or up and automatically corrects keystone distortion when the KEYSTONE Button is pressed.

Caution:

Never pick the unit up by the simple stand.

■ Using the swivel stand

1 Slide the TIGHTEN Knob to the LOOSEN position.

FRONT

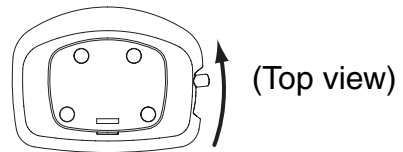

2 Adjust to the desired projection angle. If necessary, you can also tilt to the right or left.



3 Slide the TIGHTEN Knob to the TIGHTEN position.

FRONT

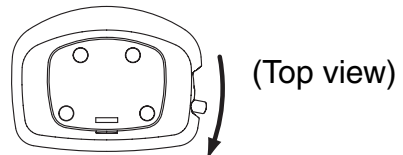

Basic LCD Projector Operation

■ Adjusting the Volume

The volume can be adjusted using the VOLUME +/- Buttons on the remote control unit.

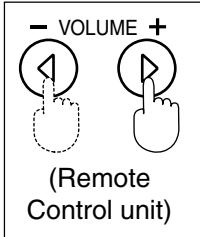

- Press **VOLUME -** Button to turn down the volume.
- Press **VOLUME +** Button to turn up the volume.

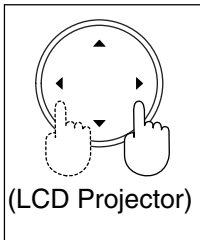

Note

- The "Volume" will remain displayed on the screen for approximately 5 seconds.
- Volume cannot be adjusted with the ◀, ▶ keys on the unit while D. ZOOM and MENU screens are displayed.

■ Freezing the picture

Projection can be switched between a frozen (still) picture and a moving picture each time the FREEZE Button on the remote control unit is pressed. Press FREEZE Button again to resume motion.

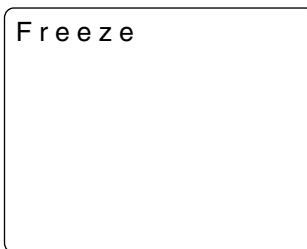
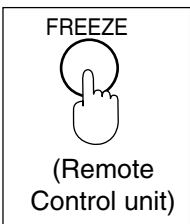

Note

Sound is muted while the picture is frozen.

Basic LCD Projector Operation

■ Turning off the Picture and Sound at the same time

When SHUTTER Button is pressed on the remote control the picture and sound turns off and the screen goes black, Press SHUTTER Button again to resume picture and sound.

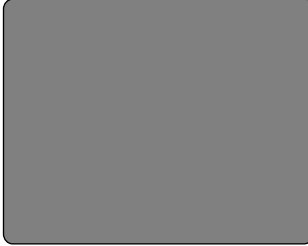
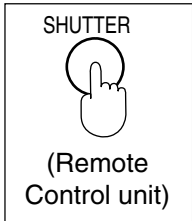

Black screen

Note

- When the screen goes black, the picture will not be shown on the screen. However, the picture continues to be sent from the personal computer or video source.
- The projector uses less power in shutter mode than it does in normal projection mode.

Using the Auto Setup Feature

When projecting RGB signal images from a personal computer, it is possible to automatically adjust the image's position, dot clock and phase simultaneously (only for projection of images with RGB signal inputs other than DTV format signals). Perform the operation described below if you wish to use this function.

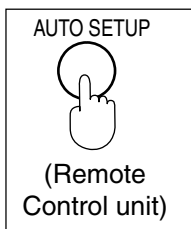

Press the AUTO SETUP Button on the remote control unit.

Auto Setup

Note

- The LCD Projector detects whether the simple stand is down or up and automatically corrects keystone distortion.
- Adjusted settings are saved as is even if power is turned off.
- If the edges of the projected picture are indistinct, or if a dark picture is being projected, the automatic set up processing may stop automatically before it is complete. If this happens, project a different picture and then press the AUTO SETUP Button once more. Or, perform the following operations as indicated in the on-screen display.
Refer to the **“Adjusting the Image Position, Dot Clock and Phase”**.
Refer to the **“Keystone correction function”**.

Adjusting the Image Position, Dot Clock and Phase

Confirm the picture position, Dot Clock, and Phase. If the picture is not correctly positioned within the display area of the screen (the edge of the picture does not appear), adjust the picture position. The items which can be adjusted will vary depending on the type of input signal.

The procedure and on-screen display as shown below are based on RGB as the input signal from a personal computer.

• When adjusting the Horizontal Position (H Position)

1 Press MENU to display the menu.

2 Press ▲ or ▼ to select “Synchronization”, and then **ENTER** to display the screen.

<input type="checkbox"/> Picture
<input type="checkbox"/> White Balance
<input checked="" type="checkbox"/> Synchronization
<input type="checkbox"/> Function
<input type="checkbox"/> Language
<input type="checkbox"/> Information

3 Press ▲ or ▼ to select “H Position”.

• When adjusting the Vertical Position, Dot Clock, and Phase, move the arrow to the item you want to adjust.

<input type="checkbox"/> Synchronization		
H Position	49	
V Position	27	
Dot Clock	900	
Phase	15	
Standard (Push ENTER)		

4 Press ◀ or ▶ to adjust the H Position setting.

• The current setting will be displayed on the screen by numerals and a bar.

Adjusting the Image Position, Dot Clock and Phase

Depending on the adjustment item, the adjust procedure and adjustment will vary. Please refer to the chart below.

Adjustment item	Button	Adjustment Details	Remarks
H Position	Press ► Button.	The image moves to the right.	
	Press ◀ Button.	The image moves to the left.	
V Position	Press ► Button.	The image moves up.	
	Press ◀ Button.	The image moves down.	
Dot Clock	Adjust the personal computer's dot clock and the projector's dot clock so that no bit interference (vertical stripes) appears on the screen.		RGB, YPBPR only
Phase	Adjust in order to remove any picture interference or contour blurring which may occur in computer images.		RGB only

Selecting the Image Quality

This LCD Projector can select Dynamic or Natural as the special characteristic of image quality.

Follow the instructions below to select the image qualities you prefer.

The procedure and on-screen display as shown below are based on RGB as the input signal from a personal computer.

• Setting procedure

1 Press MENU to display the menu.



2 Press ▲ or ▼ to select “Picture”, and **then ENTER** to display the screen.

<input type="checkbox"/> Picture
<input type="checkbox"/> White Balance
<input type="checkbox"/> Synchronization
<input type="checkbox"/> Function
<input type="checkbox"/> Language
<input type="checkbox"/> Information

3 Press ▲ or ▼ to select “Image Quality”.

4 Press ◀ or ▶ to select the Image Quality.

- Dynamic is the factory RGB input signal setting.
- Natural is the factory S-VIDEO/VIDEO, YP_BPR input signal setting.

<input type="checkbox"/> Picture	
Image Quality	•Dynamic •Natural
Brightness	0 
Contrast	0 
Standard (Push ENTER)	

Adjusting the Picture to the Desired Setting

The items which can be adjusted will vary depending on the type of input signal.

The adjustment procedure below describes the on-screen displays when the S-VIDEO signal or the VIDEO signal is being projected.

•Adjustment procedure (when adjusting the Color)

1 Press MENU to display the menu.





2 Press ▲ or ▼ to select “Picture”, and **then ENTER** to display the screen.

<input type="checkbox"/> Picture
<input type="checkbox"/> White Balance
<input type="checkbox"/> Video System
<input type="checkbox"/> Function
<input type="checkbox"/> Language
<input type="checkbox"/> Information

3 Press ▲ or ▼ to select “Color”.

4 Press ◀ or ▶ to adjust the color.

- The current setting will be displayed on the screen by numerals and a bar.

<input type="checkbox"/> Picture	
Image Quality	•Dynamic •Natural
Color	0 
Tint	0 
Brightness	0 
Contrast	0 
Sharpness	0 
Standard (Push ENTER)	

Adjusting the Picture to the Desired Setting

Depending on the adjustment item, the adjust procedure and adjustment will vary. Please refer to the chart below.

Adjustment item	Button	Adjustment Details	Remarks
Color	Press ► Button.	The color becomes deeper.	YPBPR, S-VIDEO/VIDEO only
	Press ◀ Button.	The color becomes paler.	
Tint	Press ► Button.	Flesh tones become greenish.	NTSC/NTSC 4.43 (S-VIDEO/VIDEO) only
	Press ◀ Button.	Flesh tones become reddish.	
Brightness	Press ► Button.	The screen becomes brighter.	
	Press ◀ Button.	The screen becomes darker.	
Contrast	Press ► Button.	Only the Highlights of the image become brighter, adding Contrast.	
	Press ◀ Button.	The Highlights become less bright, diminishing Contrast.	
Sharpness	Press ► Button.	The picture quality becomes sharper.	YPBPR, S-VIDEO/VIDEO only
	Press ◀ Button.	The picture quality becomes softer.	

Note

The different adjustment condition cannot be saved for S-VIDEO and VIDEO.

Adjusting the White Balance

The picture may become over-saturated with red or blue colour, and the white colour may not be at the desired degree of whiteness. In such cases, adjust the white balance by the following procedure.

The procedure and on-screen display as shown below are based on RGB as the input signal from a personal computer.

• Adjustment procedure (for white balance adjustment of the red component)

1 Press MENU to display the menu.

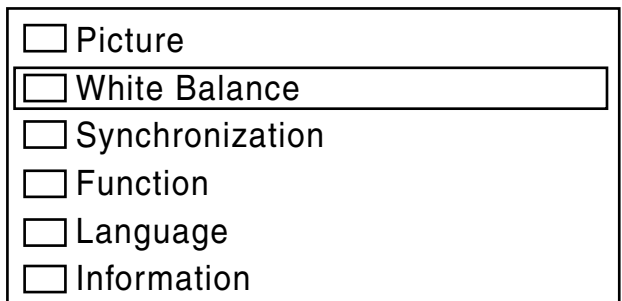

A screenshot of a menu with the following items, each preceded by a small square icon:

- Picture
- White Balance (highlighted with a thick border)
- Synchronization
- Function
- Language
- Information

2 Press ▲ or ▼ to select “White Balance”, and then **ENTER** to display the screen.

3 Press ▲ or ▼ to select “R Level”.

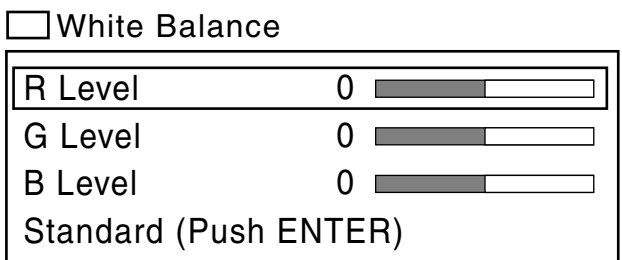

A screenshot of the 'White Balance' adjustment screen. At the top, there is a header 'White Balance' with a small square icon to its left. Below this, there are three sliders, each with a label, a numerical value '0', and a horizontal bar with a dark segment on the left and a white segment on the right:

- R Level 0
- G Level 0
- B Level 0

At the bottom of the screen, the text 'Standard (Push ENTER)' is displayed.

4 Press ◀ or ▶ to adjust the R Level setting.

- The current setting will be displayed on the screen by numerals and a bar.

Adjusting the White Balance

Depending on the adjustment item, the adjust procedure and adjustment will vary. Please refer to the chart below.

Adjustment item	Button	Adjustment Details
R Level	Press ► Button.	The red component becomes stronger.
	Press ◀ Button.	The red component becomes weaker.
G Level	Press ► Button.	The green component becomes stronger.
	Press ◀ Button.	The green component becomes weaker.
B Level	Press ► Button.	The blue component becomes stronger.
	Press ◀ Button.	The blue component becomes weaker.

Note

Unless properly adjusted, none of the colour may display normally.

Setting of the RGB/YPBPR Input Signal Selection

DTV Format Signal, such as DVD or digital broadcast, etc. can be input and projected with this Projector. When using this function, please refer to **correctly connect to the output device of the DTV Format Signal** and perform the following settings correctly.

This LCD Projector allows input of RGB or YPBPR signals (Component input signal) to the RGB/YPBPR input terminal, but you will need to change the setting of the input signal selection manually when changing the signal to be input. If the input signal selection is not set correctly, a normal image will not be projected.

The RGB input signal is set at the factory. Please follow the instructions below to change the input signal.

• Setting procedure

1 Press MENU to display the menu.

- Picture
- White Balance
- Synchronization
- Function
- Language
- Information

2 Press ▲ or ▼ to select “Function”, **and then ENTER** to display the screen.

3 Press ▲ or ▼ to select “RGB/YPBPR”.

- Function
- RGB/YPBPR •RGB •YPBPR
- Projection Mode •Front •Rear
- Expansion •ON •OFF
- On Screen Display •ON •OFF
- Auto Lamp Off •YES •NO
- Standard (Push ENTER)

4 Press ◀ or ▶ to change the input signal.

Turning off the input signal display

The function which displays the currently selected input signal on the screen can be turned off by the following procedure. Freeze displays will also be turned off.

The procedure and on-screen display as shown below are based on RGB as the input signal from a personal computer.

•Selecting procedure

1 Press MENU to display the menu.

2 Press ▲ or ▼ to select “Function”, and then **ENTER** to display the screen.

<input type="checkbox"/> Picture
<input type="checkbox"/> White Balance
<input type="checkbox"/> Synchronization
<input checked="" type="checkbox"/> Function
<input type="checkbox"/> Language
<input type="checkbox"/> Information

3 Press ▲ or ▼ to select “On Screen Display”.

4 Press ◀ or ▶ to select “ON” or “OFF”.

- Select “OFF” to turn off the input signal display function.
- Select “ON” to turn the input signal display function. The input signal will be displayed each time it is changed. (This is the factory setting.)

<input checked="" type="checkbox"/> Function	
RGB/YPBPR	•RGB •YPBPR
Projection Mode	•Front •Rear
Expansion	•ON •OFF
On Screen Display	•ON •OFF
Auto Lamp Off	•YES •NO
Standard (Push ENTER)	

Auto Lamp Off

The power save function operates as follows: If the projector continues projecting for 15 minutes or more while there is no input signal to be projected, the light source will shut off automatically to save power. And, the projector will enter standby mode. At the time of shipment from the factory, the Auto Lamp Off function is set YES, so that if you will not use this function, you can turn it off by the following procedure. The procedure and on-screen display as shown below are based on RGB as the input signal from a personal computer.

•Selecting procedure

1 Press MENU to display the menu.

2 Press ▲ or ▼ to select “Function”, and then **ENTER** to display the screen.

<input type="checkbox"/> Picture
<input type="checkbox"/> White Balance
<input type="checkbox"/> Synchronization
<input checked="" type="checkbox"/> Function
<input type="checkbox"/> Language
<input type="checkbox"/> Information

3 Press ▲ or ▼ to select “Auto Lamp Off”.

4 Press ◀ or ▶ to select “YES” or “NO”.

<input checked="" type="checkbox"/> Function	
RGB/YPBPR	•RGB •YPBPR
Projection Mode	•Front •Rear
Expansion	•ON •OFF
On Screen Display	•ON •OFF
Auto Lamp Off	•YES •NO
Standard (Push ENTER)	

Canceling enlarging (scanning line conversion) function

When a signal less than 800 X 600 dots signals is input, the LCD Projector automatically enlarges the image to 800 X 600 dots. This may cause picture quality degradation. For better image, select Expansion: OFF by the following procedure. The procedure and on-screen display as shown below are based on RGB as the input signal from a personal computer.

• Setting procedure

1 Press MENU to display the menu.

- Picture
- White Balance
- Synchronization
- Function
- Language
- Information

2 Press ▲ or ▼ to select “Function”, and then **ENTER** to display the screen.

3 Press ▲ or ▼ to select “Expansion”.

- Function
- RGB/YPbPr •RGB •YPbPr
- Projection Mode •Front •Rear
- Expansion •ON •OFF
- On Screen Display •ON •OFF
- Auto Lamp Off •YES •NO
- Standard (Push ENTER)

4 Press ◀ or ▶ to select “ON” or “OFF”.

- Select “OFF” to cancel enlarge (scanning line conversion) function.
- Select “ON” to use enlarge (scanning line conversion) function. (This is the factory setting.)

Keystone correction function

When the screen and projector are not level, a keystone (trapezoid) image may occur. This can be corrected by doing the following.

- **procedure**

1 Project a picture onto the screen.

2 Press the **KEYSTONE Button** on the projector.

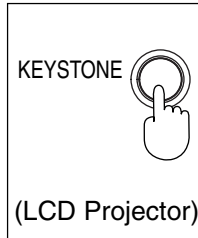

3 Press **◀ or ▶** to adjust the Keystone.

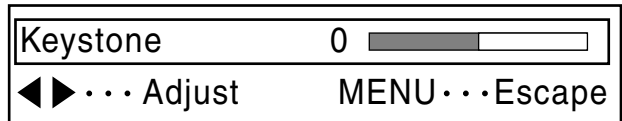

Keystone correction function

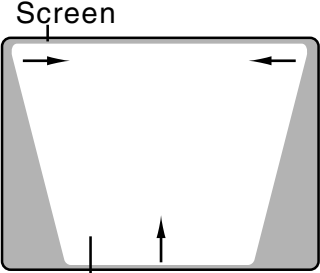
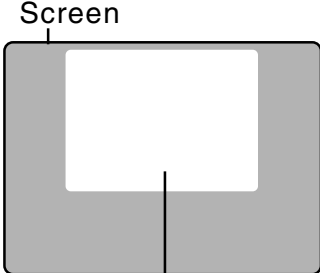
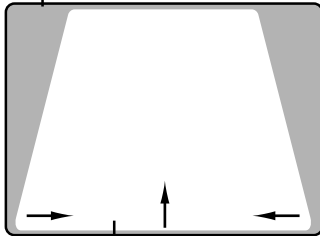
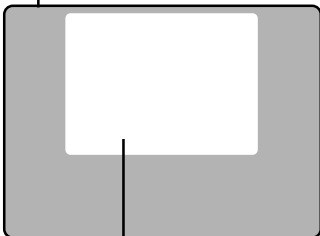
	Keystone Image	Corrected Image
Keystone (top : wide)	 <p>Screen</p> <p>Projected pictures</p> <p>Press ▶ .. Top becomes narrow.</p>	 <p>Screen</p> <p>Projected pictures</p>
Keystone (under : wide)	 <p>Screen</p> <p>Projected pictures</p> <p>Press ◀ .. Bottom becomes narrow.</p>	 <p>Screen</p> <p>Projected pictures</p>

Note

- When keystone is corrected, the screen becomes smaller.
- The LCD Projector detects whether the Simple Stand is down or up and automatically corrects keystone distortion when the KEYSTONE Button is pressed.

Selecting the Language for On-Screen Displays

The language of the LCD Projector is set to English as the factory setting. To select one of seven different languages for on-screen display, follow the instructions below. The procedure below describes the on-screen display when the S-VIDEO signal or the VIDEO signal is being projected.

•Selecting procedure

1 Press MENU to display the menu.

2 Press ▲ or ▼ to select “Language”, and then **ENTER** to display the screen.

<input type="checkbox"/> Picture
<input type="checkbox"/> White Balance
<input type="checkbox"/> Video System
<input type="checkbox"/> Function
<input checked="" type="checkbox"/> Language
<input type="checkbox"/> Information

3 Press ▲ or ▼ to select language.

- You can select English, German, French, Spanish, Italian, Japanese and Chinese.

<input type="checkbox"/> Language
<input checked="" type="checkbox"/> English
Deutsch
Français
Español
Italiano
日本語
中文

Information Functions

You can display the input signal type and lamp run time. Display items differ depending on the input signal. The procedure and on-screen display as shown below are based on RGB as the input signal from a personal computer.

• procedure

1 Press MENU to display the menu.

2 Press ▲ or ▼ to select “Information”.

<input type="checkbox"/> Picture
<input type="checkbox"/> White Balance
<input type="checkbox"/> Synchronization
<input type="checkbox"/> Function
<input type="checkbox"/> Language
<input checked="" type="checkbox"/> Information

3 Press ENTER to display the screen.

<input type="checkbox"/> Information	
No. of Dots	800 x 600
H Frequency	37.88 kHz
V Frequency	60 Hz
Lamp Runtime	100 h

Information Functions

Display Item	Description	Remarks
No. of Dots	Input signal dot number is displayed.	Personal Computer Signals (RGB) only
H Frequency	Horizontal frequency number is displayed.	
V Frequency	Vertical frequency number is displayed.	
Signal	Name of the input signal type is displayed. When AUTO is selected in the Video System screen, the selected format will be displayed.	YPbPr VIDEO/ S-VIDEO only
Lamp Runtime	Number of hours the lamp has been used is displayed.	

Digital Zoom Functions

You can enlarge and project specific portions of the input picture and select the enlargement ratio for this portion using the D.ZOOM buttons on the remote control unit.

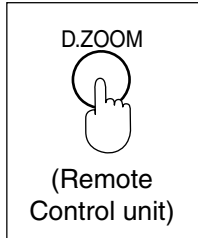
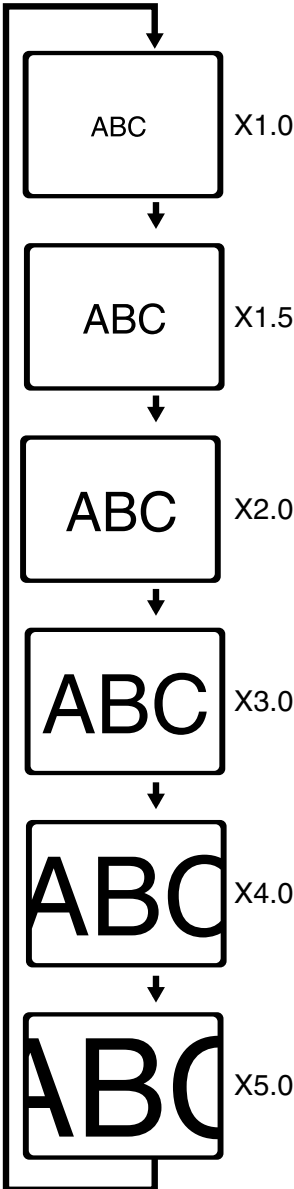

- **Press D.ZOOM Button** the picture will become bigger.

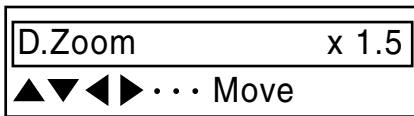

Note

You can enlarge the centre portion of the image to one of 6 magnifications.

Digital Zoom Functions

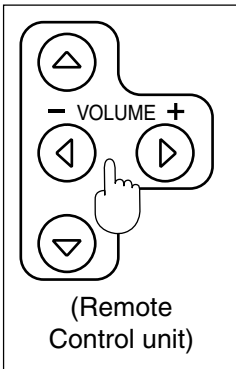
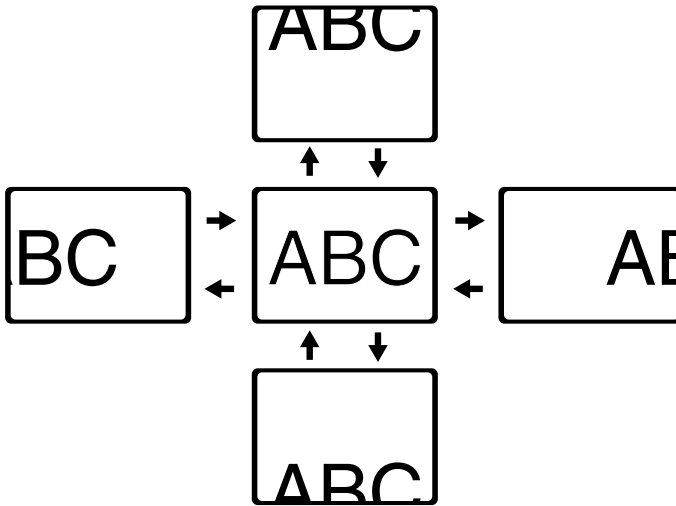

- Use the ▲ and ▼ arrow Buttons to move the position up and down.
- Use the ◀ and ▶ arrow Buttons to move the position to the left and right.

Note

Position cannot be moved with arrow Buttons on the unit.

Status Code Display Indications

■ Warning Indicators

This LCD Projector has a STATUS Code Display which calls your attention to problem conditions existing inside the LCD Projector. The LCD Projector displays a status Code Indication each time an internal problem is detected. If any of the following indications appear in the STATUS Code Display, immediately turn off the Power Button, **and then see the chart to determine a course of action.**

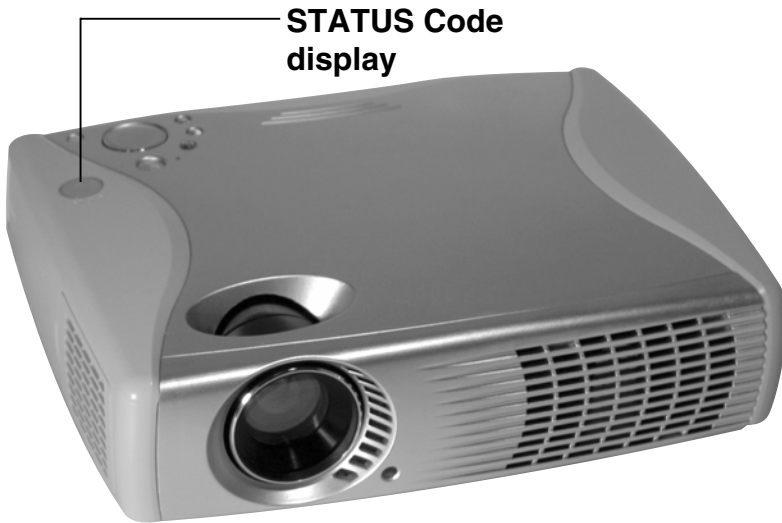

Note

Please wait one minute before turning the power back on, to allow the lamp to cool. A much longer time may be required if the projector had attained an abnormally high internal temperature.

Status Code Display Indications

STATUS Code	Symptom	Problem	Possible Solution
F-L	Lamp does not light up.	• Cooling fan malfunction.	• Take the Projector to your nearest Service Centre.
C-0		• Misinstalled Air Filter Unit or Lamp cover.	• Properly install Air Filter Unit or Lamp cover.
A-n		• Temperature Sensor malfunction.	• Take the Projector to your nearest Service Centre.
A-0		• Clogged air filter. • Blocked air intake. • The surrounding temperature of the place of use may be too high.	• Clean the filter. • Relocate projector to a proper location. • Place Projector so that surrounding temperature is between 0 °C (32 °F) and 40 °C (104 °F) and the humidity is between 20 % and 80 % (with no condensation.)
L-n		• If the Lamp will not light after turning on the main power 2 or 3 times, the Lamp may be damaged.	• Take the Projector to your nearest Service Centre.
P-2		• Lamp Voltage is not correct.	
P-3		• Abnormal temperature rise.	
P-4		• Other causes.	
L-1	Lamp operation time is over 1 900 hours.	• It is nearly time to replace the Lamp Unit.	• Replace the Lamp unit.
L-0	Lamp operation time reaches 2 000 hours.	• The Lamp Unit must be replaced.	
C-d	Forced cooling fan operating to expedite lamp replacement.	_____	_____

Cleaning the Air Filter

■ Air Filter

The air filter should be cleaned about every 100 hours. Also, clean the air filter if the “A-0” is indicated in the STATUS Code display.

Replace the filter when it is clogged or dirty even after cleaning.

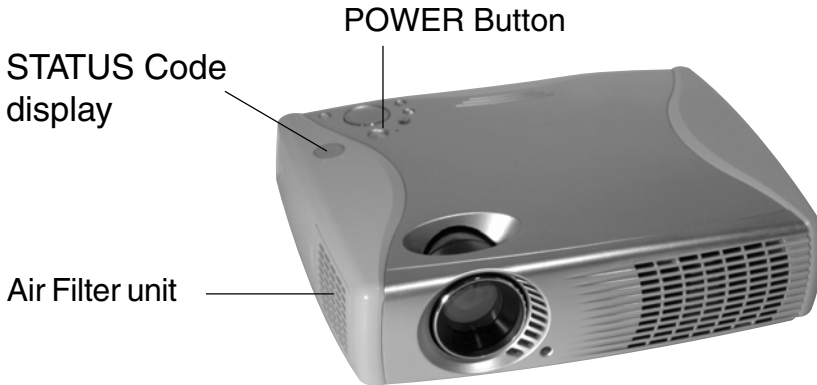

• **Cleaning procedure** (Tools required: Vacuum Cleaner.)

1 Set the POWER Button to OFF and unplug the power cord.

Note

Wait until the cooling fan stops and the STANDBY(R) ON(G) indicator turns solid red.

2 Remove the Air Filter unit

Hold the indent on the Air Filter unit with your hands and pull the Air Filter unit out of the LCD Projector.

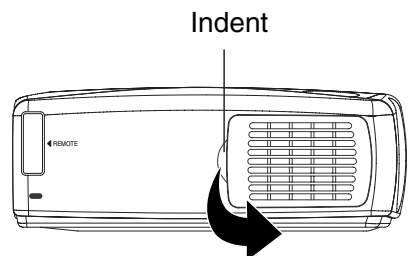

Cleaning the Air Filter

3 Clean the Filter.

Gently remove any accumulated dust from Air Filter unit with your vacuum cleaner.

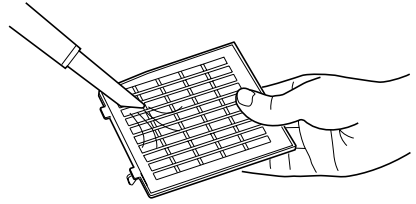

CAUTION: Operating LCD Projector with torn or damaged Filter may cause damage to LCD Projector.

4 Replace the Air Filter unit.

Slide the Air Filter into the LCD Projector so that the indentations of the filter and projector are aligned. Then, press on the arrow mark until you hear it snap into place.

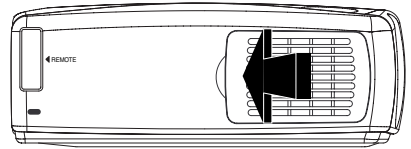

- The LCD Projector power cannot be turned on unless the Air Filter unit is correctly installed.
- Using with the air filter sponge removed will result in dirt and dust being drawn in and lead to malfunction.

Note

If the dust cannot be removed by cleaning, it is time to replace the air filter.

Lamp Replacement

Warning

If the Lamp does not light and the LAMP STATUS Code is “L-n,” If the Lamp will not light after turning on the main power 2 or 3 times, the Lamp may be damaged. If the Lamp still does not light, the Lamp may be damaged. Because Lamp fragments could cause injury, DO NOT attempt to replace Lamp yourself. Take the LCD Projector to your dealer for repair.

STATUS Code display



■ Lamp replacement period

The LCD Projector lamp has a limited operating life of approximately 2 000 hours.

If lamp operation time exceeds 1 900 hours, “L-1” is displayed as the STATUS Code.

“Lamp replacement is recommended.” will be displayed on-screen when operation time reaches 1 900 hours.

Lamp replacement is recommended.

**Take the LCD Projector to your dealer for repair.
(Order Lamp ET-LAC50.)**

- When the lamp operation time has exceeded 1 900 hours, a warning will appear for 15 seconds when the LCD Projector power is turned on.

Lamp Replacement

■ In case lamp time reaches 2 000 hours

The LCD Projector will shut itself OFF and the STATUS Code indication becomes “L-0”.

- If the Lamp is not replaced, turning POWER on will only cause the screen at right to be displayed for 5 minutes.

Unless you change to a new lamp, POWER will be off 5 minutes later.

Note

The lamp used as the light source eventually wears out. The service life of the light source lamp used on the PT-LC50E is about 2 000 hours, but depending on the individual lamp's properties and the usage conditions the lamp may no longer light after less than 2 000 hours (the lamp is affected by the number of times the lamp is lit and the time span until it is relit, and these may shorten the service life). Because of this, we recommend having a replacement lamp on hand.

Signals that can be Input

The projection mode will be matched automatically to one of the modes which have been pre-set inside the Projector.
If a signal which differs greatly from any of the types listed below is input, the picture image may not be displayed correctly, or a blue background may be displayed.

■ RGB Signals that can be Input

Display mode name		Signal data			
		No. of dots	Horizontal frequency (kHz)	Vertical frequency (Hz)	Dot clock frequency (MHz)
Personal Computer Signals	VGA400 (70 Hz)	640 X 400	31.47	70.08	25.175
	VGA480 (60 Hz)	640 X 480	31.47	59.94	25.175
	Macintosh 13"	640 X 480	35.00	66.67	30.241
	VESA400 (85 Hz)	640 X 400	37.86	85.08	31.500
	VESA480 (72 Hz)	640 X 480	37.86	72.81	31.500
	VESA480 (75 Hz)	640 X 480	37.50	75.00	31.500
	VESA480 (85 Hz)	640 X 480	43.27	85.01	36.000
	SVGA (56 Hz)	800 X 600	35.16	56.25	36.000
	SVGA (60 Hz)	800 X 600	37.88	60.32	40.000
	SVGA (72 Hz)	800 X 600	48.08	72.19	50.000
	SVGA (75 Hz)	800 X 600	46.88	75.00	49.500
	SVGA (85 Hz)	800 X 600	53.67	85.06	56.250
	XGA (60 Hz)*	1 024 X 768	48.36	60.00	65.000
	XGA (70 Hz)*	1 024 X 768	56.48	70.07	75.000
	XGA (75 Hz)*	1 024 X 768	60.02	75.03	78.750
	Macintosh 16"*	832 X 624	49.73	74.55	57.283
	Macintosh 19"*	1 024 X 768	60.24	74.93	80.000
XGA (85Hz)*	1 024 X 768	68.68	85.00	94.500	

Signals that can be Input

Display mode name		Signal data			
		No. of dots	Horizontal frequency (kHz)	Vertical frequency (Hz)	Dot clock frequency (MHz)
Personal Computer Signals	1 152 X 864 (70 Hz)*	1 152 X 864	63.85	70.01	94.500
	1 152 X 864 (75 Hz)*	1 152 X 864	67.50	75.00	108.000
	1 152 X 864 (85 Hz)*	1 152 X 864	77.09	85.00	121.500
	Macintosh 21''*	1 152 X 870	68.68	75.06	100.000
	1 280 X 960 (60 Hz)*	1 280 X 960	60.00	60.00	108.000
	1 280 X 960 (75 Hz)*	1 280 X 960	75.00	75.00	126.000
	1 280 X 1 024 (60 Hz)*	1 280 X 1 024	63.98	60.02	108.000
	1 280 X 1 024 (75 Hz)*	1 280 X 1 024	79.98	75.03	135.000
DTV Format Signals	480 i	664 X 485	15.73	29.97	12.650
	480 p	720 X 483	31.47	59.94	27.000
	720 p*	1 280 X 720	45.00	60.00	74.250
	1 080 i*	1 920 X 1 080	33.75	30.00	74.250
	625 i	756 X 576	15.63	25.00	14.500

Note

- ★ Changing the number of dots to be displayed to within 800 X 600 may cause a portion of information to be omitted, or the image quality to be degraded.
- DTV Format Signals are picture signals from a DVD or a digital broadcast.
- The Sync. signal of a DTV format signal (RGB) is only supported if the Horizontal and Vertical frequencies are separate.

Signals that can be Input

■ Component Signals (YP_BPR) that can be Input

Display mode name		Signal data			
		No. of dots	Horizontal frequency (kHz)	Vertical frequency (Hz)	Dot clock frequency (MHz)
DTV Format Signals	480 i	664 X 485	15.73	29.97	12.650
	480 p	720 X 483	31.47	59.94	27.000
	720 p*	1 280 X 720	45.00	60.00	74.250
	1 080 i*	1 920 X 1 080	33.75	30.00	74.250
	625 i	756 X 576	15.63	25.00	14.500

Note

- ★ Changing the number of dots to be displayed to within 800 X 600 may cause a portion of information to be omitted, or the image quality to be degraded.
- DTV Format Signals are picture signals from a DVD or a digital broadcast.

Signals that can be Input

■ S-VIDEO/VIDEO Signal that can be Input

Signal format name	Horizontal scanning frequency (kHz)	Vertical scanning frequency (Hz)	Colour sub-carrier frequency (MHz)
AUTO	Selected automatically.		
NTSC	15.75	60.00	3.58
NTSC4.43			4.43
PAL-M			3.58
PAL	15.63	50.00	4.43
PAL-N			3.58
SECAM			4.25 or 4.41

Note

- NTSC and PAL-M have the same scanning frequencies and color sub-carrier frequencies, but they have different colour modulation methods. Because of this, if the incorrect setting is selected, colour pictures may appear in black-and-white.
- The video system screen is not displayed with no S-VIDEO/VIDEO input signal.

S-VIDEO/VIDEO Signal Format Selection

If the correct signal format is not selected and the picture does not appear normal when VIDEO or S-VIDEO signal is being input, select the format by the following procedure. This function is set to “AUTO” at the time of shipment from the factory, so that the projector can normally be used with this setting.

• Setting procedure

1 Press MENU to display the menu.

2 Press ▲ or ▼ to select “Video System”, **and then ENTER** to display the screen.

<input type="checkbox"/> Picture
<input type="checkbox"/> White Balance
<input checked="" type="checkbox"/> Video System
<input type="checkbox"/> Function
<input type="checkbox"/> Language
<input type="checkbox"/> Information

3 Press ▲ or ▼ to switch the setting to “AUTO”, “NTSC”, “NTSC4.43”, “PAL”, “PAL-M”, “PAL-N” or “SECAM” until a normal picture is obtained.

<input type="checkbox"/> Video System
AUTO
<input checked="" type="checkbox"/> NTSC
NTSC4.43
PAL
PAL-M
PAL-N
SECAM

Note

If using a signal source with poor picture quality, such as a dubbed tape, it may not be possible to get the picture to display properly.

Blue (Black) Screen with No Input Signal

The LCD Projector is equipped with an internal Blue (Black) Screen function which turns the screen blue black when the video or personal computer equipment connected to the input jack is turned off, or when there is nothing connected to the input jack.

- If the power is turned on when no input signal is input to the LCD Projector, the screen will turn blue. The Focus screen appears only until the video or personal computer equipment is connected to the input jack and turned on.

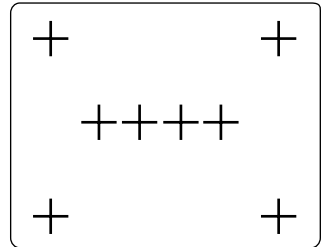

- During operation, if the input signal is terminated, the screen goes black and “No Signal” will be displayed.

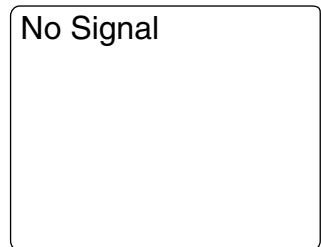

- If an unrecognizable signal is input, the screen goes black and “Signal” is displayed.
- When RGB signal is input, please input the registered signals found on “**Signals that can be Input**”.

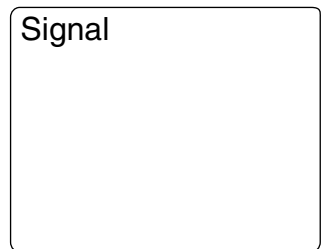

Optional Accessories

For ordering instructions, see the accessory order form page.

- (1) Full Functional Remote Control Unit (ET-RMLC50)
- (2) Replacement Lamp (ET-LAC50)
- (3) D-sub15-BNC5 Adapter Cable (ET-ADBNC)

Note

When the full functional remote control unit is used, you can operate the wireless mouse and laser pointer features.

Specifications

LCD panels		0.7" Poly silicon LCD panel X 3, RGB shutter method, using Translucent TN crystal panels
Drive method		Active Matrix 4:3 Aspect Ratio panels, TFT (Thin Film Transistor)
No. of pixels		480 000 (800 X 600) stripe pixels X 3 panels
Lens		1-1.3 zoom lens, F2.3-2.6, f28 mm- 37 mm Manual Focus
Projector lamp		130 W UHM Lamp
Contrast ratio		300 : 1
Brightness		700 lumen / ANSI
No. of colours		16 777 216
Screen size		30" - 300"
Projection (throw) distance		1.6 m - 15.7 m
Lens axis shift		6:1 Low position
Color systems		PAL/SECAM/NTSC/PAL-M/PAL-N/NTSC4.43
Video input signal		1 V [p-p], sync negative, 75 Ω terminated
S-Video input signal		Y (luminance signal) : 1 V [p-p], sync negative, 75 Ω terminated C (chrominance signal) : burst 0.286 V [p-p], 75 Ω terminated
Audio input signal		0.32 V [rms]
Audio out		0.5 W Mono
RGB/YPbPr input signal	Video signal	RGB Analog (0.7 V [p-p], 1.0 V [p-p] with sync on green, 75 Ω) YPbPr (Y: 1.0 V [p-p], Pb, Pr: 0.7 V [p-p], 75 Ω)
	Sync signal	H/V separate, H/V composite, or Sync-on-Green
	H-Frequency	24 KHz - 80 KHz (TTL Level)
	V-Frequency	50 Hz - 86 Hz (TTL Level)
Connectors		S-Video Input: Mini Din 4-pin X 1 Video Input : RCA pin X 1 Audio Input: M3 stereo mini pin X 1 Serial Port (RS-232C): Mini Din 8-pin X 1 RGB/YPbPr Input: D-Sub mini 15-pin X 1

Specifications

Controls	Cabinet Buttons/ Switches	Power ON/OFF, Menu, Input, ▲, ▼, ◀ (Volume -), ▶ (Volume +), Enter, Keystone	
	Remote Control Buttons	Power ON/OFF, Freeze, Shutter, Enter, Menu, Input, ▲, ▼, ◀ (Volume -), ▶ (Volume +), D.Zoom, Auto setup	
Speaker		36 mm round	
Operating Temperature		0 °C (32 °F) - 40 °C (104 °F)	
Operating Humidity		20 % - 80 %	
Storage Temperature		-20 °C to 40 °C (-4 °F to 104 °F)	40 °C to 60 °C (104 °F to 140 °F)
Storage Humidity		5 % - 85 % (non-condensing)	Normal humidity
Power Supply		100 V - 240 V AC (50 Hz or 60 Hz) Automatic	
Power consumption		210 W	
Dimensions W x H x D (excluding projected portion)		267 mm x 74 mm x 208 mm	
Weight		2.5 kg	
Approvals		FCC, UL, C-UL, CE, VDE	

Note

Specifications and design subject to change without notice.

Before Requesting Service

If the LCD Projector unit fails, check the following before calling your dealer for service.

Problem	Possible Cause
Power does not turn on.	<ul style="list-style-type: none">•The power cord may not be connected.•The main power supply may not be supplied to the wall outlet.•The Status Codes are indicated on the STATUS Code Display.•The lamp unit or lamp unit cover may not have been correctly installed.•The Air Filter Unit may not have been correctly installed.
No picture appears.	<ul style="list-style-type: none">•The lens cap may still be attached to the lens.•The signal input source may not be connected properly.•The input selection setting may not be correct.•The Brightness adjustment may be lowest setting.•The LCD Projector may be set to the Shutter mode.•The connected signal source may be turned off.
The picture is fuzzy.	<ul style="list-style-type: none">•The lens focus may not have been set correctly, or the Projector may not be at the correct distance from the screen.•The lens may be dirty.•The LCD Projector may not be set up so that it is perpendicular to the screen.•The VIDEO or R, G, B adjustments may not have been set correctly.
Colour is too light or tint is poor.	<ul style="list-style-type: none">•Colour or Tint adjustment may be incorrect.•The video formats may not match.•The signal cables may be connected incorrectly. For instance, the PB, PR connectors may be reversed.

Before Requesting Service

Problem	Possible Cause
No sound can be heard.	<ul style="list-style-type: none">• The audio signal source may not be connected properly.• The volume adjustment may be at the lowest possible setting.• The Mute function or Audio/Video Shutter function may be active.
Remote Control does not operate.	<ul style="list-style-type: none">• The batteries may be spent, or they may not be inserted correctly.• There may be an object blocking the infrared signals between remote control unit and the Projector.• The remote control unit may be out of the operating range.
The colour is black-and white.	<ul style="list-style-type: none">• The Video System may not be correct.

Matsushita Electric Industrial Co., Ltd.

Central P.O. Box 288, Osaka 530-91, Japan