

***myprojectorlamps.com***

**The most trusted, dependable name  
in projector lamp sales.**



<http://www.myprojectorlamps.com>



<http://www.myprojectorlamps.ca>



<http://www.myprojectorlamps.eu>

The following projector manual has not been modified or altered in any way.

# Panasonic

LCD Projector Commercial Use

## Operating Instructions

---

ENGLISH

Model No. **PT-LB10NTE**  
**PT-LB10E**  
**PT-LB10VE**  
**PT-LB10SE**

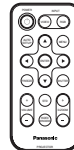
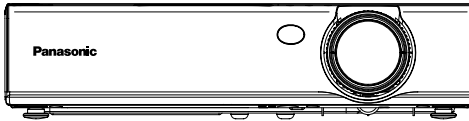

Before operating this product, please read the instructions carefully and save this manual for future use.

# Dear Panasonic Customer:

This instruction booklet provides all the necessary operating information that you might require. We hope it will help you to get the most out of your new product, and that you will be pleased with your Panasonic LCD projector. The serial number of your product may be found on its bottom. You should note it in the space provided below and retain this booklet in case service is required.

Model number: **PT-LB10NTE / PT-LB10E / PT-LB10VE / PT-LB10SE**

Serial number: \_\_\_\_\_

## IMPORTANT SAFETY NOTICE

**WARNING: THIS APPARATUS MUST BE EARTHED.**

**WARNING: To prevent damage which may result in fire or shock hazard, do not expose this appliance to rain or moisture.**

Machine Noise Information Ordinance 3. GSGV, January 18, 1991: The sound pressure level at the operator position is equal or less than 70 dB (A) according to ISO 7779.

**WARNING:**

- 1) Remove the plug from the wall outlet when this unit is not in use for a prolonged period of time.
- 2) To prevent electric shock, do not remove cover. No user serviceable parts inside. Refer servicing to qualified service personnel.
- 3) Do not remove the earthing pin on the power plug. This apparatus is equipped with a three prong earthing-type power plug. This plug will only fit an earthing-type power outlet. This is a safety feature. If you are unable to insert the plug into the outlet, contact an electrician. Do not defeat the purpose of the earthing plug.

**WARNING:**

- For permanently connected equipment, a readily accessible disconnect device shall be incorporated in the building installation wiring;
- For pluggable equipment, the socket-outlet shall be installed near the equipment and shall be easily accessible.

**CAUTION:**

To assure continued compliance, follow the attached installation instructions, which includes using the provided power cord and shielded interface cables when connecting to computer or peripheral device. If you use serial port to connect PC for external control of projector, you must use optional RS-232C serial interface cable with ferrite core. Any unauthorized changes or modifications to this equipment will void the user's authority to operate.

## IMPORTANT: THE MOULDED PLUG (U.K. only)

### FOR YOUR SAFETY, PLEASE READ THE FOLLOWING TEXT CAREFULLY.

This appliance is supplied with a moulded three pin mains plug for your safety and convenience. A 13 amp fuse is fitted in this plug. Should the fuse need to be replaced, please ensure that the replacement fuse has a rating of 13 amps and that it is approved by ASTA or BSI to BS1362.

Check for the ASTA mark  or the BSI mark  on the body of the fuse.

If the plug contains a removable fuse cover, you must ensure that it is refitted when the fuse is replaced. If you lose the fuse cover, the plug must not be used until a replacement cover is obtained. A replacement fuse cover can be purchased from an Authorised Service Centre.

**If the fitted moulded plug is unsuitable for the mains socket in your home, then the fuse should be removed and the plug cut off and disposed of safely. There is a danger of severe electrical shock if the cut off plug is inserted into any 13 amp socket.**

If a new plug is to be fitted, please observe the wiring code as shown below. If in any doubt, please consult a qualified electrician.

### WARNING: — THIS APPLIANCE MUST BE EARTHED.

IMPORTANT: — The wires in this mains lead are coloured in accordance with the following code: —

Green-and-Yellow:	Earth
Blue:	Neutral
Brown:	Live

As the colours of the wire in the mains lead of this appliance may not correspond with the coloured markings identifying the terminals in your plug, proceed as follows.

The wire which is coloured GREEN-AND-YELLOW must be connected to the terminal in the plug which is marked with the letter E or by the Earth symbol  or coloured GREEN or GREEN-AND-YELLOW.

The wire which is coloured BLUE must be connected to the terminal in the plug which is marked with the letter N or coloured BLACK.

The wire which is coloured BROWN must be connected to the terminal in the plug which is marked with the letter L or coloured RED.

How to replace the fuse Open the fuse compartment with a screwdriver and replace the fuse.

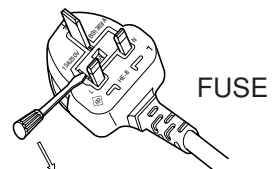

# Contents

## Preparation

### **IMPORTANT SAFETY NOTICE ...2**

Precautions with regard to safety .....6

Accessories .....10

Before use .....11

Location and function of each part .....13

Inserting the wireless card .....18

## Getting started

Setting-up .....19

Projection methods, Projector position, Projection distances

Connections .....21

Connecting to computer, Connecting to video equipment

Preparation for the remote control unit .....23

## Basic operation

Turning on the power .....24

Turning off the power .....26

## Useful functions

Correcting keystone distortion and automatic positioning .....28

Turning off the picture and sound momentarily .....29

Pausing a picture .....29

Enlarging the picture .....30

Adjusting the volume .....30

Displaying two screens .....31

## Adjustments and settings

On-screen menus .....32

Menu screens, Menu operation guide, Returning a setting to the factory default

Correcting keystone distortion .....36

Adjusting the picture .....37

PICTURE MODE, CONTRAST, BRIGHT, COLOR, TINT, SHARPNESS, COLOR TEMP.,

White balance R/G/B, AI, TV-SYSTEM, STILL MODE, SIGNAL MODE, Projecting sRGB-compatible pictures

Adjusting the position .....40

POSITION, DOT CLOCK, CLOCK PHASE, ASPECT, RESIZING, FRAME LOCK

Changing the display

language .....43

Option settings .....43

OSD, AUTO SEARCH, AUTO SIGNAL, AUTO KEYSTN, RGB/YP<sub>B</sub>Pr, VGA60/480p, SXGA MODE, Noise Reduction (NR), BLACKBOARD, BACK COLOR, FRONT/REAR, DESK/CEILING, FAN CONTROL, LAMP POWER, LAMP RUNTIME, FUNC 1, CONTROL KEY, AUTO POW.OFF, POWER MEMORY

Setting up the security

function .....47

INPUT/AMEND PASSWD, TEXT DISPLAY/CHANGE

Network setup .....49

## Care and maintenance

When the TEMP indicator and the LAMP indicator are illuminated .....50

Cleaning and replacing

the air filter .....52

Replacing the lamp unit .....53

Before calling for service .....56

Cleaning and maintenance .....57

## Others

Specifications .....58

Appendix .....60

List of compatible signals, Pin assignments, Projection dimensions calculation methods, Using the SERIAL connector

Dimensions .....64

Trademark

acknowledgements .....64

# Precautions with regard to safety

## WARNING

**If you notice smoke, strange smells or noise coming from the projector, disconnect the mains plug from the mains socket.**

- Do not continue to use the projector in such cases, otherwise fire or electric shocks could result.
- Check that no more smoke is coming out, and then contact an Authorised Service Centre for repairs.
- Do not attempt to repair the projector yourself, as this can be dangerous.

**Do not install this projector in a place which is not strong enough to take the full weight of the projector.**

- If the installation location is not strong enough, it may fall down or tip over, and severe injury or damage could result.

**Installation work (such as ceiling suspension) should only be carried out by a qualified technician.**

- If installation is not carried out correctly, there is the danger that injury or electric shocks may occur.

**If foreign objects or water get inside the projector, or if the projector is dropped or the cabinet is broken, disconnect the mains plug from the mains socket.**

- Continued use of the projector in this condition may result in fire or electric shocks.
- Contact an Authorised Service Centre for repairs.

**Do not overload the mains socket.**

- If the power supply is overloaded (for example, by using too many adapters), overheating may occur and fire may result.

**Do not remove the cover or modify it in any way.**

- High voltages can cause fire or electric shocks.
- For any inspection, adjustment and repair work, please contact an Authorised Service Centre.

**Clean the mains plug regularly to prevent it from becoming covered in dust.**

- If dust builds up on the mains plug, the resulting humidity can damage the insulation, which could result in fire. Pull the mains plug out from the mains socket and wipe it with a dry cloth.
- If not using the projector for an extended period of time, pull the mains plug out from the mains socket.

**Do not do anything that might damage the mains lead or the mains plug.**

- Do not damage the mains lead, make any modifications to it, place it near any hot objects, bend it excessively, twist it, pull it, place heavy objects on top of it or wrap it into a bundle.
- If the mains lead is used while damaged, electric shocks, short-circuits or fire may result.
- Ask an Authorised Service Centre to carry out any repairs to the mains lead that might be necessary.

**Do not handle the mains plug with wet hands.**

- Failure to observe this may result in electric shocks.

**Insert the mains plug securely into the mains socket.**

- If the plug is not inserted correctly, electric shocks or overheating could result.
- Do not use plugs which are damaged or mains sockets which are coming loose from the wall.

**Do not place the projector on top of surfaces which are unstable.**

- If the projector is placed on top of a surface which is sloped or unstable, it may fall down or tip over, and injury or damage could result.

**Do not place the projector into water or let it become wet.**

- Failure to observe this may result in fire or electric shocks.

**Do not place the projector on soft materials such as carpets or sponge mats.**

- Doing so may cause the projector to overheat, which can cause burns, fire or damage to the projector.

**Do not place liquid containers on top of the projector.**

- If water spills onto the projector or gets inside it, fire or electric shocks could result.
- If any water gets inside the projector, contact an Authorised Service Centre.

**Do not insert any foreign objects into the projector.**

- Do not insert any metal objects or flammable objects into the projector or drop them onto the projector, as doing so can result in fire or electric shocks.

**Keep the batteries out of the reach of infants.**

- If the batteries are swallowed, death by suffocation may result. If you believe that the batteries may have been swallowed, seek medical advice immediately.

**Do not allow the + and - terminals of the batteries to come into contact with metallic objects such as necklaces or hairpins.**

- Failure to observe this may cause the batteries to leak, overheat, explode or catch fire.
- Store the batteries in a plastic bag and keep them away from metallic objects.



**During a thunderstorm, do not touch the projector or the cable.**

- Electric shocks can result.

**Do not use the projector in a bath or shower.**

- Fire or electric shocks can result.

**Do not look into the lens while the projector is being used.**

- Strong light is emitted from the projector's lens. If you look directly into this light, it can hurt and damage your eyes.
- Be especially careful not to let young children look into the lens. In addition, disconnect the mains plug when you are away from the projector.

**Do not place your hands or other objects close to the air outlet port.**

- Heated air comes out of the air outlet port. Do not place your hands or face, or objects which cannot withstand heat close to this port, otherwise burns or damage could result.

**When replacing the lamp, allow it to cool for at least one hour before handling it.**

- The lamp cover gets very hot, and contact with it can cause burns.

**Before replacing the lamp, be sure to disconnect the mains plug from the mains socket.**

- Electric shocks or explosions can result if this is not done.

## **Caution**

**Do not cover the air inlet port or the air outlet port.**

- Doing so may cause the projector to overheat, which can cause fire or damage to the projector.
- Do not place the projector in narrow, badly ventilated places such as closets or bookshelves.
- Do not place the projector on cloth or papers, as these materials could be drawn into the air inlet port.

**Do not set up the projector in humid or dusty places or in places where the projector may come into contact with smoke or steam.**

- Using the projector under such conditions may result in fire or electric shocks.

**When disconnecting the mains lead, hold the plug, not the lead.**

- If the mains lead itself is pulled, the lead will become damaged, and fire, short-circuits or serious electric shocks may result.

**Always disconnect all cables before moving the projector.**

- Moving the projector with cables still attached can damage the cables, which could cause fire or electric shocks to occur.

**Do not place any heavy objects on top of the projector.**

- Failure to observe this may cause the projector to become unbalanced and fall, which could result in damage or injury.

**Do not short-circuit, heat or disassemble the batteries or place them into water or fire.**

- Failure to observe this may cause the batteries to overheat, leak, explode or catch fire, and burns or other injury may result.

**When inserting the batteries, make sure the polarities (+ and -) are correct.**

- If the batteries are inserted incorrectly, they may explode or leak, and fire, injury or contamination of the battery compartment and surrounding area may result.

**Use only the specified batteries.**

- If incorrect batteries are used, they may explode or leak, and fire, injury or contamination of the battery compartment and surrounding area may result.

**Insulate the battery using tape or similar before disposal.**

- If the battery comes into contact with metallic objects or other batteries, it may catch fire or explode.

**Do not put your weight on this projector.**

- You could fall or the projector could break, and injury may result.
- Be especially careful not to let young children stand or sit on the projector.

**If not using the projector for an extended period of time, disconnect the mains plug from the mains socket.**

- If dust builds up on the mains plug, the resulting humidity may damage the insulation, which could result in fire.
- This projector continues to draw approximately 6 W of power even when the power is turned off.

**Disconnect the mains plug from the mains socket as a safety precaution before carrying out any cleaning.**

- Electric shocks can result if this is not done.

**Do not install the accessory wireless card to any device other than the card slot of the projector. (PT-LB10NTE only)**

- If this is not observed, damage to the device may result.



**Ask an Authorised Service Centre to clean inside the projector at least once a year.**

- If dust is left to build up inside the projector without being cleaned out, it can result in fire or problems with operation.
- It is a good idea to clean the inside of the projector before the season for humid weather arrives. Ask your nearest Authorised Service Centre to clean the projector when required. Please discuss with the Authorised Service Centre regarding cleaning costs.

**We are constantly making efforts to preserve and maintain a clean environment. Please take non repairable units back to your dealer or a recycling company.**

# Accessories

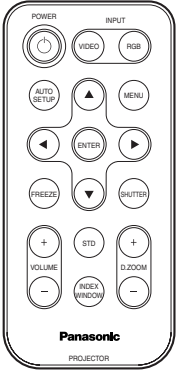
Check that all of the accessories shown below have been included with your projector.

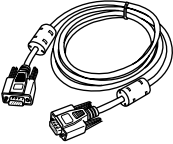
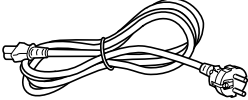
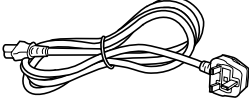
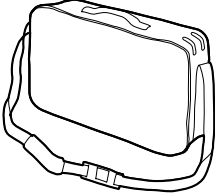
<p>Card remote control unit (TNQE239 x1)</p> 	<p>Lithium battery for remote control unit (CR2025 x1)</p> 	<p>RGB signal cable [1.8 m (5'10"), K1HA15DA0002 x1]</p> 
	<p>Mains lead for Continental Europe (K2CM3DR00002 x 1)</p> 	<p>Mains lead for U.K. (K2CT3DR00005 x 1)</p> 
<p>Carrying bag (TPEP013 x 1)</p> 		

## PT-LB10NTE only

<p>CD-ROM (TQBH9005 x1)</p> 	<p>Wireless Card (N5HBD0000029 x1)*1</p> 	<p>Hexagon wrench (TKLA0701 x1)</p> 
---	--	---

\*1 N5HBD0000031 x 1 for Spain  
 N5HBD0000030 x 1 for Singapore  
 N5HBD0000028 x 1 for Malaysia

# Before use

## Caution when moving the projector

**Be sure to attach the lens cover before moving the projector.**

The projection lens is extremely susceptible to vibration and shocks. When moving the projector, use the accessory carrying bag. When placing the projector inside the carrying bag, position it so that the lens is facing upward. Do not put anything else in the bag other than the projector and the cables.

## Cautions regarding setting-up

**Avoid setting up in places which are subject to vibration or shocks.**

The internal parts can be damaged, which may cause malfunctions or accidents.

**Do not set up the projector near high-voltage power lines or near motors.**

The projector may be subject to electromagnetic interference.

**If installing the projector to the ceiling, ask a qualified technician to carry out all installation work.**

You will need to purchase the separate installation kit (Model No.ET-PKC80). Furthermore, all installation work should only be carried out by a qualified technician.

**If using this projector at high elevations (above 1 400 m), set the “FAN CONTROL” to “HIGH”. (Refer to page 45.)**

Failure to observe this may result in malfunctions.

## Notes on use

### **In order to get the best picture quality**

Draw curtains or blinds over any windows and turn off any fluorescent lights near the screen to prevent outside light or light from indoor lamps from shining onto the screen.

### **Do not touch the surfaces of the lens with your bare hands.**

If the surface of the lens becomes dirty from fingerprints or anything else, this will be magnified and projected onto the screen. Moreover, when not using the projector, retract the lens and then cover it with the lens cover.

### **Screen**

Do not apply any volatile substances which may cause discolouration to the screen, and do not let it become dirty or damaged.

### **Lamp**

The lamp may need to be replaced earlier due to variables such as individual lamp characteristics, usage conditions and the installation environment, especially when the projector is subjected to continuous use for more than 10 hours or the power is frequently turned on and off.

### **Liquid crystal panel**

The liquid crystal panel of the projector is built with very high precision technology to provide fine picture details. Occasionally, a few non-active pixels may appear on the screen as fixed points of blue, green or red. Please note that this does not affect the performance of your LCD.

### **Wireless card (PT-LB10NTE only)**

Static electricity from the human body can damage the wireless card. To prevent this, touch a nearby metallic object such as an aluminium sash or a door knob to dissipate the static charge from your body.

### **Wireless card slot (PT-LB10NTE only)**

Make sure that there are no foreign objects inside the slot when inserting the wireless card. Failure to observe this may damage the card and the slot.

# Location and function of each part

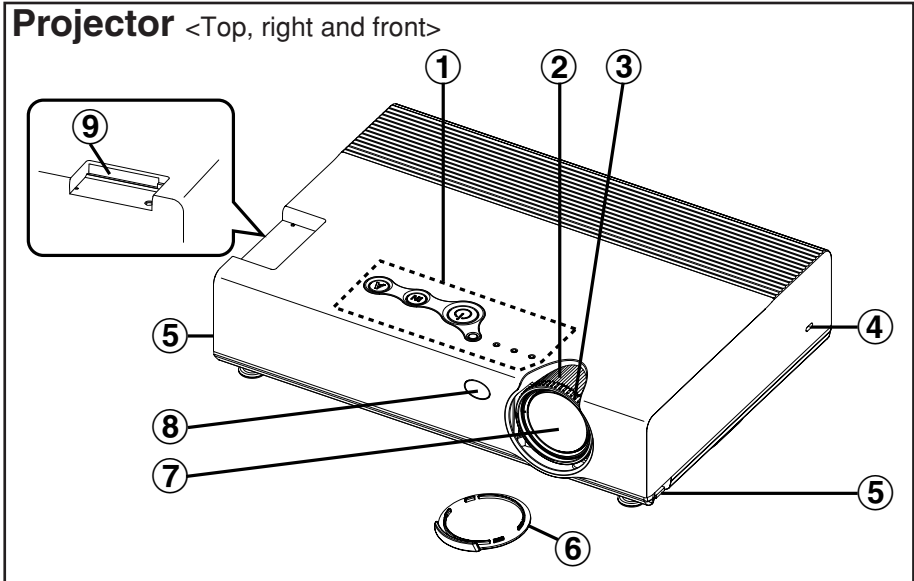

- ① **Projector control panel** (page 16)
- ② **Zoom ring** (page 25)
- ③ **Focus ring** (page 25)
- ④ **Security lock**  
This can be used to connect a commercially-available theft-prevention cable (manufactured by Kensington). This security lock is compatible with the Microsaver Security System from Kensington.
- ⑤ **Leg adjuster buttons (L/R)** (page 25)  
These buttons are used to unlock the front adjustable legs. Press to adjust the angle of tilt of the projector.
- ⑥ **Lens cover**
- ⑦ **Projection lens**
- ⑧ **Remote control signal receptor** (page 23)
- ⑨ **Wireless card slot** (PT-LB10NTE only) (page 18)  
Insert the wireless card into here.

## Projector <Back and bottom>

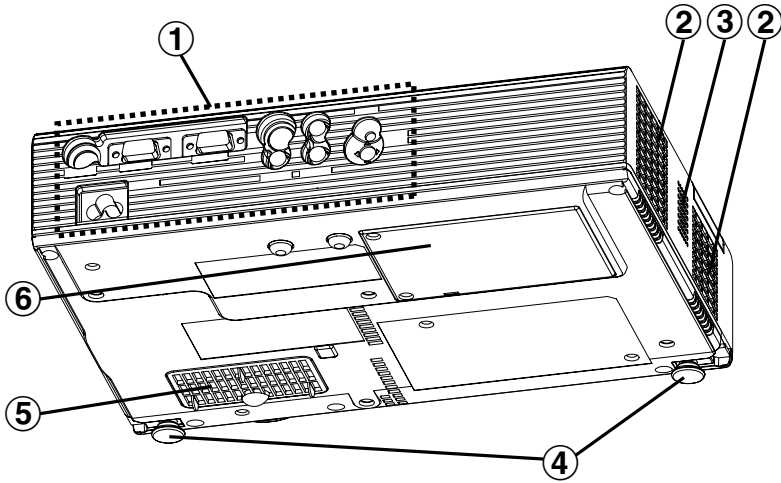

- ① **Connector panel** (page 15)
- ② **Air outlet port**  
Do not cover this port.
- ③ **Speaker**
- ④ **Front adjustable legs (L/R)** (page 25)
- ⑤ **Air inlet port, Air filter** (page 52)  
Do not cover this port.
- ⑥ **Lamp unit holder** (page 53)

### NOTE:

- During projection of an image, the cooling fan will operate, emitting a small noise as it operates. Turning the lamp on or off will cause this noise to increase a little.
- By using the “OPTION2” menu to set “LAMP POWER” to “LOW”, the operating sound of the fan can be reduced. (Refer to page 45.)

## WARNING

**Do not place your hands or other objects close to the air outlet port.**

- Heated air comes out of the air outlet port. Do not place your hands or face, or objects which cannot withstand heat close to this port, otherwise burns or damage could result.

## Connector panel

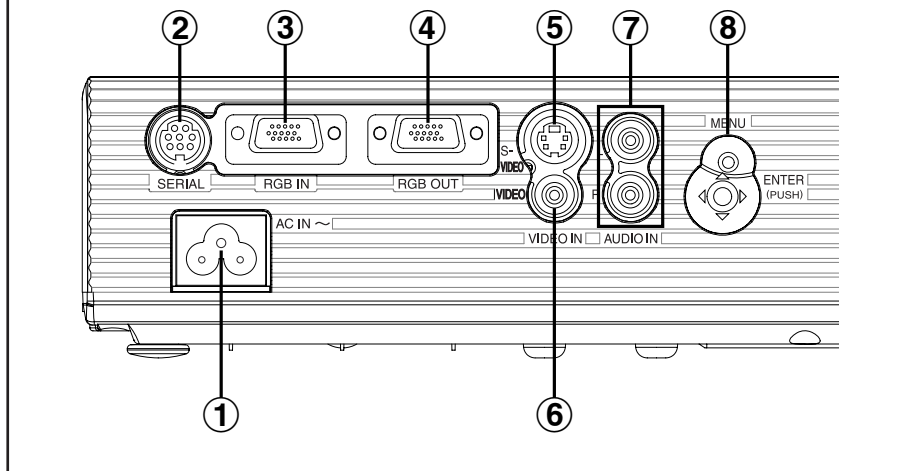

- ① **Power input socket (AC IN)** (page 24)  
The accessory mains lead is connected here.  
Do not use any mains lead other than the accessory mains lead.
- ② **SERIAL connector** (pages 21, 22 and 62)  
This connector is used to connect a personal computer to the projector in order to control the projector externally. (RS-232C compatible)
- ③ **RGB IN connector** (pages 21 and 22)  
This connector is used to input RGB signals and YPBPr signals.
- ④ **RGB OUT connector** (page 21)  
This connector is used to output RGB signals and YPBPr signals from the RGB IN connector.
- ⑤ **S-VIDEO IN connector** (pages 22 and 41)  
This connector is used to input signals from S-VIDEO-compatible equipment such as a video deck. The connector is S1 signal compatible, and it automatically switches between 16:9 and 4:3 aspect ratios in accordance with the type of signal being input.
- ⑥ **VIDEO IN connector** (page 22)  
This connector is used to input video signals from video equipment such as a video deck.
- ⑦ **AUDIO IN L-R connectors** (pages 21 and 22)
- ⑧ **Menu operation (on connector panel)** (page 16)



## Projector control panel

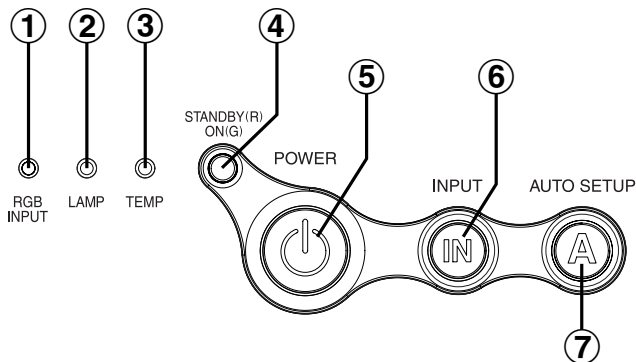

## Menu operation

<on connector panel:page 15>

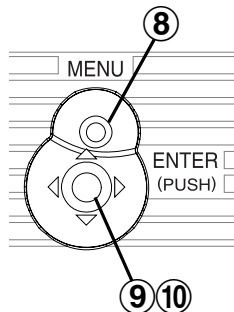

## Remote control unit

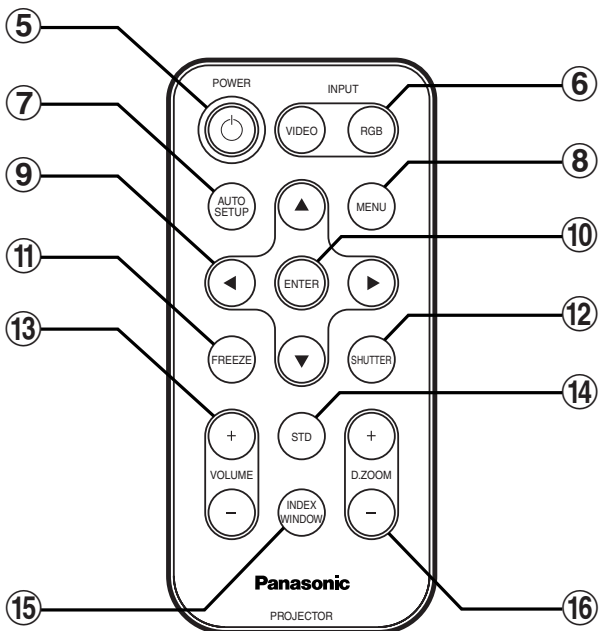

### ① RGB INPUT indicator

This indicator illuminates when a signal is being input to the RGB IN connector.

### ② LAMP indicator (page 51)

This indicator illuminates when it is time to replace the lamp unit. It flashes if a circuit abnormality is detected.

- ③ **TEMP indicator** (page 50)  
This indicator illuminates if an abnormally high temperature is detected inside the projector or around it. If the temperature rises above a certain level, the power supply will be turned off automatically and the indicator will flash.
- ④ **Power indicator** (pages 24, 26 and 27)  
This indicator illuminates red when the projector is in standby mode, and it illuminates green when a picture starts to be projected.
- ⑤ **POWER button** (pages 24 and 26)
- ⑥ **INPUT buttons** (page 25)  
These buttons are used to switch the input signals from the connected equipment.
- ⑦ **AUTO SETUP button** (pages 25 and 28)  
If this button is pressed while a picture is being projected, the projection settings will be adjusted automatically in accordance with the signal being input. In addition, the angle of tilt of the projector will be automatically detected and adjusted in order to correct any keystone distortion.
- ⑧ **MENU button** (pages 32 and 34)  
This button is used to display the “MAIN MENU”. When a menu screen is being displayed, this button can be used to return to a previous screen or to clear the screen.
- ⑨ **Arrow (▲▼◀▶) buttons** (page 34)  
These buttons are used to select and adjust items in the on-screen menus.
- ⑩ **ENTER button** (page 34)  
This button is used to accept and to activate items selected in the on-screen menus.
- ⑪ **FREEZE button** (page 29)  
This button is used to momentarily freeze projection so that a still picture is displayed.
- ⑫ **SHUTTER button** (page 29)  
This button is used to momentarily turn off the picture and sound.
- ⑬ **VOLUME +/- buttons** (page 30)  
These buttons are used to adjust the volume of the sound output from the projector’s built-in speaker. Refer to page 33 for details on how to adjust the volume using the buttons on the projector control panel.
- ⑭ **STD (standard) button** (page 35)  
This button is used to reset the projector adjustment values to the factory default settings.
- ⑮ **INDEX WINDOW button** (page 31)  
This button can be used to split the image projection area into a still picture and a moving picture. When “NETWORK” is selected, screen display will be switched between four window style and index style. (PT-LB10NTE only. Refer to the accessory CD-ROM for details.)
- ⑯ **D.ZOOM +/- buttons** (page 30)  
These buttons are used to enlarge the projected image.

## (PT-LB10NTE only)

### Wireless card

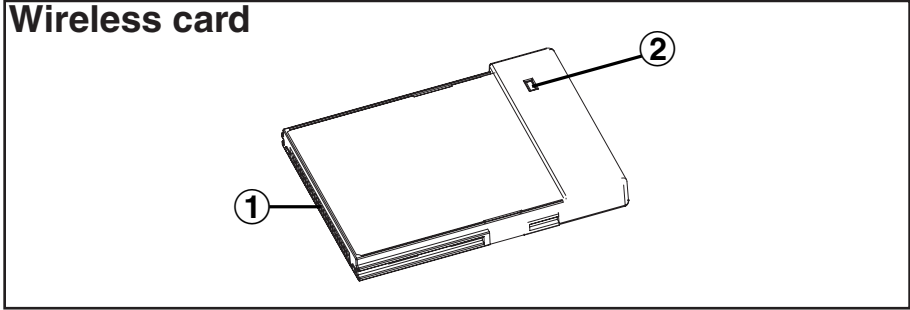

#### ① Connector

This connector is for connecting the wireless card to the projector's card slot. Be careful not to touch the connector.

#### ② Wireless card access indicator

Flashes while the projector is being accessed with personal computers by means of a wireless network.

## Inserting the wireless card (PT-LB10NTE only)

Insert the wireless card before using the PT-LB10NTE.

The card lock is already installed at the factory default setting. When you insert the wireless card, first remove the card lock fixing screw using the hexagon wrench to release the card lock.

Hexagon wrench  
(accessory)

Card lock fixing  
screw

Card lock

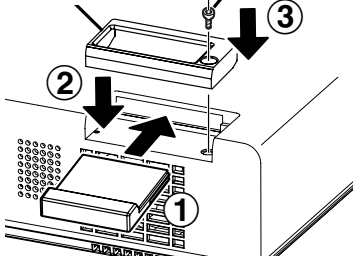

① Insert the wireless card until it locks.

② Set the card lock.

③ Fasten the card lock with the card lock fixing screw using the hexagon wrench.

- When removing the wireless card, unlock the card lock, and then pull out the wireless card.

# Setting-up

## Projection methods

In way of installing projector, any one of the following four projection methods are used. Select whichever projection method matches the setting-up method. (The projection method can be set from the "OPTION2" menu. Refer to page 45 for details.)

### ● Front-desk projection

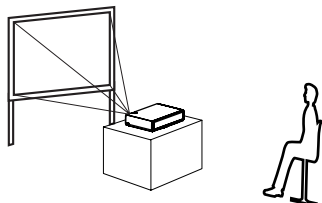

Menu items	Setting
FRONT/REAR	FRONT
DESK/CEILING	DESK

### ● Front-ceiling projection

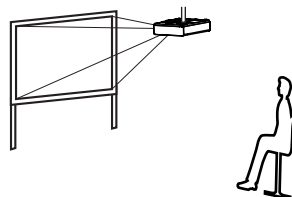

Menu items	Setting
FRONT/REAR	FRONT
DESK/CEILING	CEILING

### ● Rear-desk projection (Using a translucent screen)

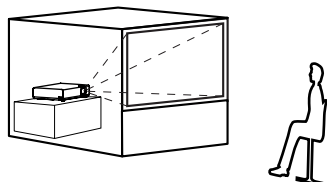

Menu items	Setting
FRONT/REAR	REAR
DESK/CEILING	DESK

### ● Rear-ceiling projection (Using a translucent screen)

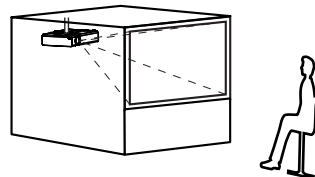

Menu items	Setting
FRONT/REAR	REAR
DESK/CEILING	CEILING

### NOTE:

- You will need to purchase the separate ceiling bracket (ET-PKC80) when using the ceiling installation method.
- If you set up the projector vertically, it may cause damage to the projector.
- It is recommended that you set up the projector in a place that is tilted at less than  $\pm 30^\circ$ . Setting up the projector in places that are tilted at more than  $\pm 30^\circ$  may cause malfunctions.

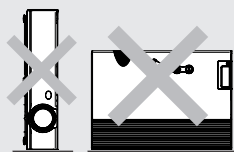

## Projector position

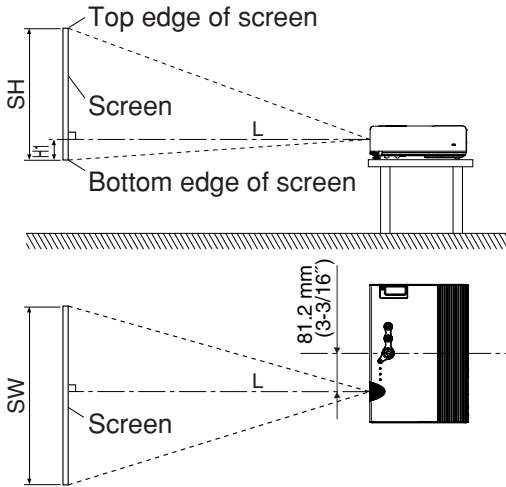

L: Projection distance  
 SH: Image height  
 SW: Image width  
 H1: Distance from centre of lens to bottom edge of projected image

## Projection distances

4:3 Screen size (diagonal)	Projection distance (L)				Height position (H1)
	PT-LB10NTE/PT-LB10E/PT-LB10SE		PT-LB10VE		
	Wide (LW)	Telephoto (LT)	Wide (LW)	Telephoto (LT)	
0.84 m(33")	—	1.1 m(3'7")	—	1.1 m(3'7")	0.08 m(3-1/8")
1.02 m(40")	1.2 m(3'11")	1.4 m(4'7")	1.2 m(3'11")	1.4 m(4'7")	0.09 m(3-17/32")
1.27 m(50")	1.5 m(4'11")	1.7 m(5'6")	1.5 m(4'11")	1.8 m(5'10")	0.11 m(4-5/16")
1.52 m(60")	1.8 m(5'10")	2.1 m(6'10")	1.8 m(5'10")	2.1 m(6'10")	0.14 m(5-1/2")
1.78 m(70")	2.1 m(6'10")	2.4 m(7'10")	2.1 m(6'10")	2.5 m(8'2")	0.16 m(6-9/32")
2.03 m(80")	2.4 m(7'10")	2.8 m(9'2")	2.4 m(7'10")	2.9 m(9'6")	0.18 m(7-1/16")
2.29 m(90")	2.7 m(8'10")	3.2 m(10'5")	2.8 m(9'2")	3.2 m(10'5")	0.20 m(7-27/32")
2.54 m(100")	3.0 m(9'10")	3.5 m(11'5")	3.0 m(9'10")	3.6 m(11'9")	0.22 m(8-21/32")
3.05 m(120")	3.6 m(11'9")	4.2 m(13'9")	3.7 m(12'1")	4.3 m(14'1")	0.26 m(10-7/32")
3.81 m(150")	4.5 m(14'9")	5.3 m(17'4")	4.6 m(15'1")	5.4 m(17'8")	0.33 m(12-31/32")
5.08 m(200")	6.0 m(19'8")	7.1 m(23'3")	6.1 m(20")	7.3 m(23'11")	0.44 m(17-5/16")
6.35 m(250")	7.5 m(24'7")	8.9 m(29'2")	7.6 m(24'11")	9.1 m(29'10")	0.55 m(21-5/8")
7.62 m(300")	9.0 m(29'6")	10.7 m(35'1")	9.2 m(30'2")	11.0 m(36'1")	0.66 m(25-31/32")

### NOTE:

- The dimensions in the table above are approximate.
- If you use the projection distance for the 16:9 screen, the 4:3 projection image overflows the screen at the top and bottom.
- For details about projected image distances, refer to page 61.

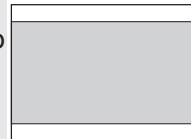

# Connections

## Notes on connections

- Read the instruction manual for each peripheral device carefully before connecting it.
- Turn off the power supply for all peripheral devices before making any connections.
- If the cables necessary for connection are not included with the peripheral device or available as an option, you may need to prepare a proper cable for the device concerned.
- If there is a lot of jitter in the video signal, the projected image may flicker. In such cases, it will be necessary to connect a TBC (time base corrector).
- Refer to the list on page 60 for details on compatible signals which can be input to the projector.
- Only one audio system circuit is available for the AUDIO IN L-R connectors, so if you change the audio input source, you will need to remove and insert the appropriate plugs.

## Connecting to computer

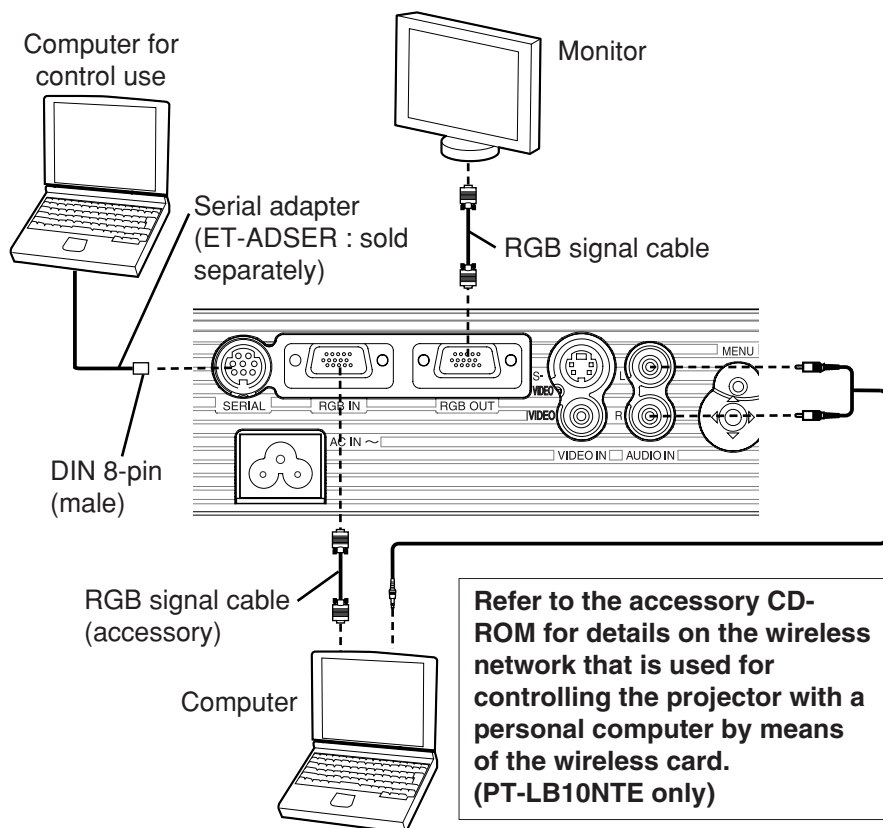

# Connecting to video equipment

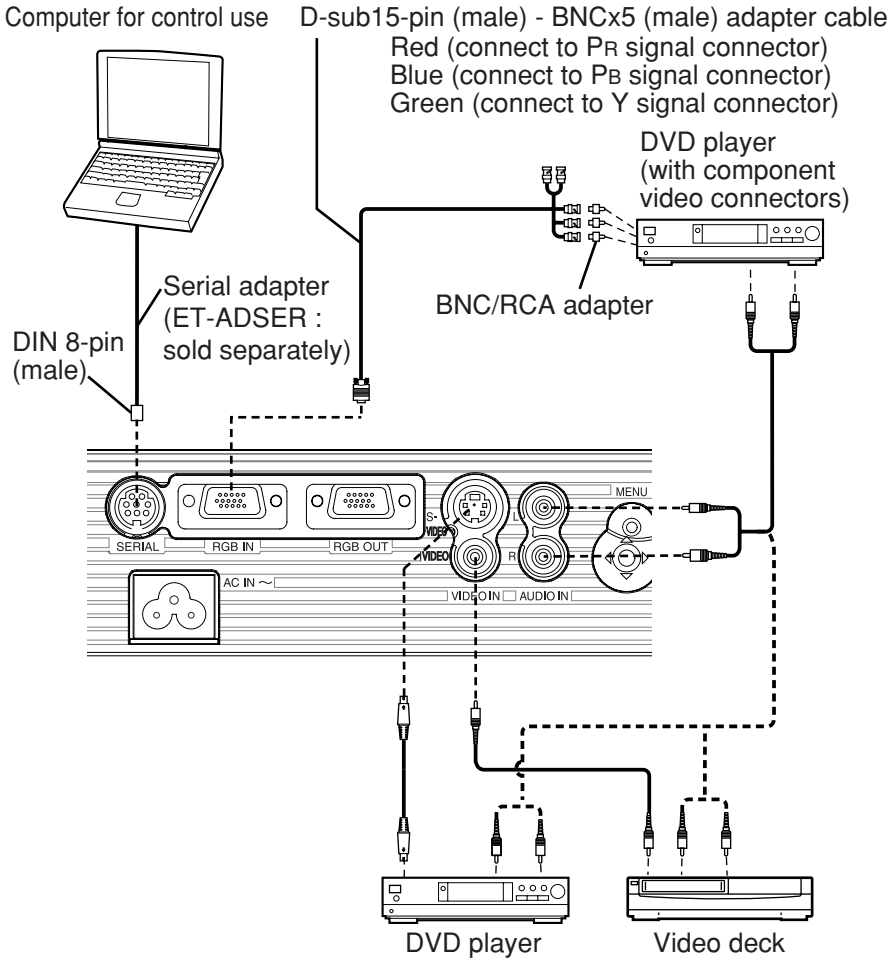

**NOTE:**

- If the signal cables are disconnected or if the power supply for the computer or video deck is turned off while “D.ZOOM”(digital zoom) or “INDEX WINDOW” is being used, these functions will be cancelled.

# Preparation for the remote control unit

Insert the accessory lithium battery while making sure that the polarities are correct.

- ① While pushing the battery holder tab to the right, pull out the battery holder.

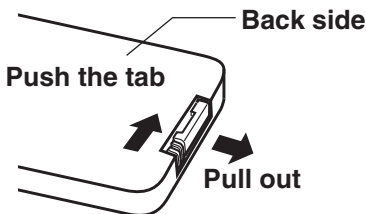

- ② Insert the battery into the battery holder so that the + side is facing upward.

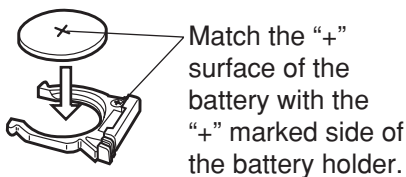

- ③ Insert the battery holder.

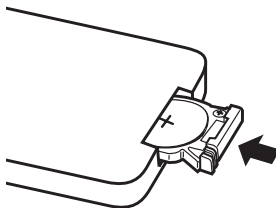

## NOTE:

- Do not drop the remote control unit.
- Keep the remote control unit away from liquids.
- Remove the battery if not using the remote control unit for long periods.
- Use only CR2025 batteries as replacement batteries.
- If the remote control unit is held so that it is facing directly in front of the remote control signal receptor, the operating range is within approximately 7 m (23') from the surfaces of the receptor. Furthermore, the remote control unit can be operated from an angle of  $\pm 30^\circ$  to the left or right and  $\pm 15^\circ$  above or below the receptors.
- If there are any obstacles in between the remote control unit and the receptor, the remote control unit may not operate correctly.
- If strong light is allowed to shine onto the remote control signal receptor, correct projector operation may not be possible. Place the projector as far away from light sources as possible.
- If facing the remote control unit toward the screen to operate the projector, the operating range of the remote control unit will be limited by the amount of light reflection loss caused by the characteristics of the screen used.



# Turning on the power

## Before turning on the power

- 1, Ensure that all peripheral devices are connected properly.
- 2, Remove the lens cover.

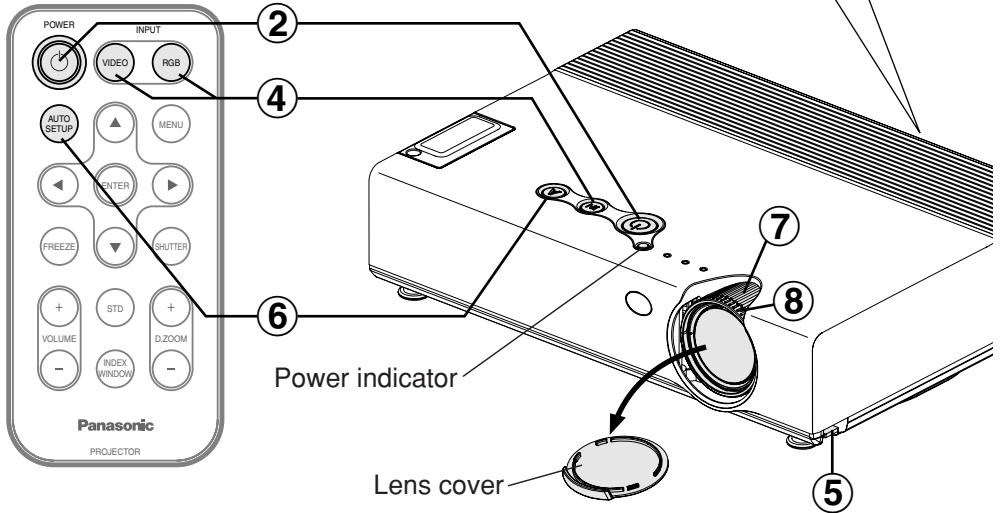
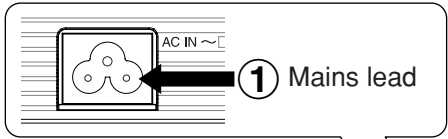

## 1 Connect the accessory mains lead to the AC IN socket.

- The power indicator on the projector will illuminate red.

## 2 Press the POWER button.

- The power indicator on the projector will flash green. After a short period, the indicator will illuminate green, and a picture will be projected.

## 3 Turn on the power of all connected devices.

- Start the play function of a device such as a DVD player.

### NOTE:

- If the mains lead was disconnected during projection when the projector was used the last time, projection will start after the mains lead is connected (when "POWER MEMORY" in the "OPTION2" menu is set to "ON"). Refer to page 46 for details.
- A tinkling sound may be heard when the lamp unit is turned on, but this is not a sign of a malfunction.

## 4 Press the input select button to select the input signal.

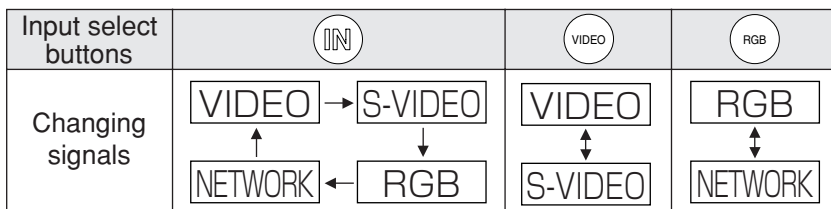

- A picture will be projected in accordance with the selected input signal.
- When a YPBPr signal is being input, “YPBPr” will be displayed instead of “RGB”.
- “NETWORK” is for PT-LB10NTE only.

Follow the procedure below when you set the projector up first, and when you change the setup place.

## 5 Adjusting the angle

- While pressing the adjuster buttons, adjust the forward/back angle of tilt of the projector. Adjust so that the projector is as vertical to the screen as possible.

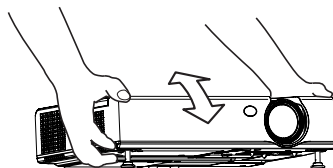

## 6 Press the AUTO SETUP button to initiate automatic positioning.

- The tilt of the projector and the input signal will be detected and keystone distortion and the position of the image will be corrected. (Refer to page 28 for details.)

AUTO SETUP

## 7 Adjusting the size

- Turn the zoom ring to adjust the size of the projected image.

## 8 Adjusting the focus

- Turn the focus ring to adjust the focus of the projected image.

# Turning off the power

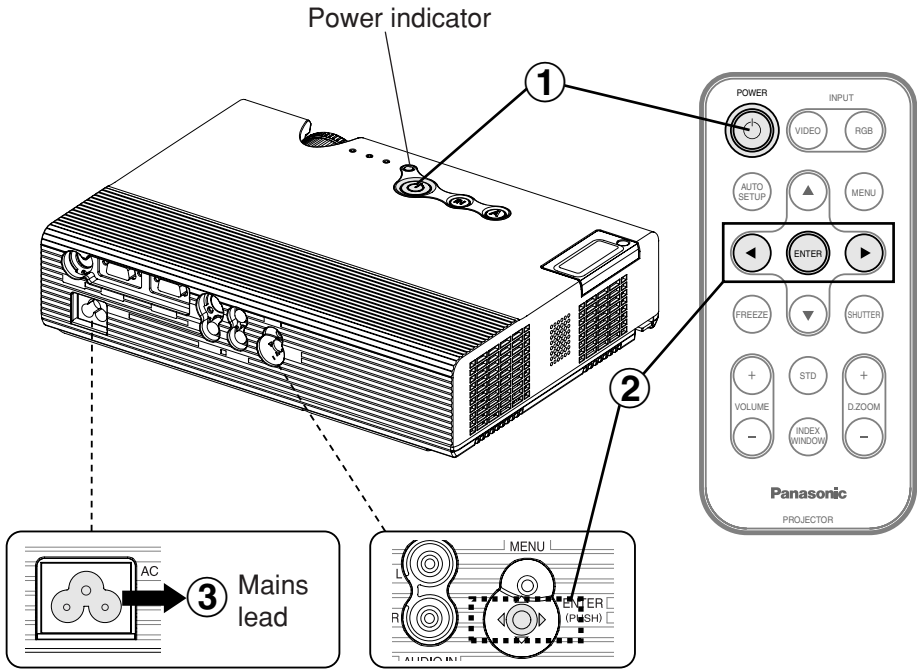

- 1 Press the POWER button.**
- “POWER OFF” is displayed on the screen.

- 2 Press the ◀ or ▶ button to select “OK”, and then press the ENTER button.**
- The lamp unit will switch off and the picture will stop being projected. (The power indicator on the projector will illuminate orange while the cooling fan is still operating.)

- 3 Disconnect the mains lead after the power indicator on the projector illuminates red.**

## NOTE:

- You can also turn off the power by pressing the POWER button twice or by holding it down for at least 0.5 seconds.
- When the projector is in standby mode (the power indicator on the projector is illuminated red), the projector continues to draw approximately 6 W of power even when the cooling fan has stopped.

### Direct power off function

You can disconnect the mains lead during projection or immediately after use and move the projector. The cooling fan will operate by the internal power supply to cool down the lamp.

- When this function is used, it may take more time for the lamp to turn back on again compared to when the lamp cools down with the mains lead connected.
- Do not put the projector in a bag while the cooling fan is operating.

## CAUTION

**If not using the projector for an extended period of time, disconnect the mains plug from the mains socket.**

- If dust builds up on the mains plug, the resulting humidity may damage the insulation, which could result in fire.
- This projector continues to draw approximately 6 W of power even when the power is turned off.

### Power indicator

Power indicator status		Projector status
Red	Illuminated	The projector is in standby mode and image projection is possible by pressing the POWER button.
Green	Flashing	The projector is preparing for projection after the power is turned on while the power indicator is illuminated red. (After a short period, a picture will be projected.)
	Illuminated	A picture is being projected.
Orange	Illuminated	The lamp is cooling down after the power is turned off. (The cooling fan is operating.)
	Flashing	The projector is preparing for projection after the power is turned on while the power indicator is illuminated orange. (After a short period, a picture will be projected.)

# Correcting keystone distortion and automatic positioning (AUTO SETUP)

This projector detects its degree of tilt and the input signal. Keystone distortion and the position of the image can then be corrected automatically in accordance with the input signal.



Projector control panel

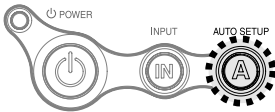

**Press the AUTO SETUP button.**

(When the projected image has caused keystone distortion)

Screen

Projected image

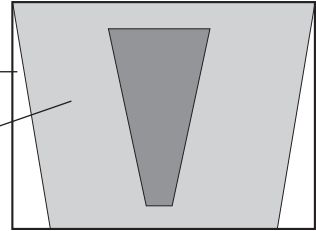

- Automatic positioning will be carried out.

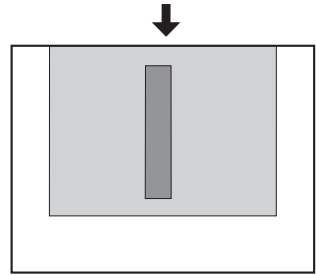

## NOTE:

- “AUTO SEARCH” will also be carried out. (When “AUTO SEARCH” is set to “ON”, refer to page 44 for details.)
- When RGB signals are being input, “DOT CLOCK”, and “CLOCK PHASE” will be adjusted automatically in addition to keystone distortion and the position of the image being corrected (except when the dot clock frequency is 100 MHz or higher). Refer to page 40 for details.
- If the edges of the projected image are indistinct, or if a dark picture is being projected, the automatic setup processing may stop automatically before it is complete. If this happens, project a different picture and then press the AUTO SETUP button again.
- Set “AUTO KEYSTN” in the “OPTION1” menu to “OFF” to prevent any deterioration of the picture as a result of keystone correction. (Refer to page 44.)

# Turning off the picture and sound momentarily (SHUTTER)

The “SHUTTER” function can be used to momentarily turn off the picture and sound from the projector when the projector is not being used for short periods of time, such as during breaks in meetings or when carrying out preparation. The projector uses less power in “SHUTTER” mode than it does in normal projection mode.



## Press the SHUTTER button.

- The picture and sound will be turned off.
- Press any button on either the projector or remote control unit to return to normal operating mode.

### NOTE:

- “SHUTTER” on the “MAIN MENU” is the same function.

# Pausing a picture (FREEZE)



## Press the FREEZE button.

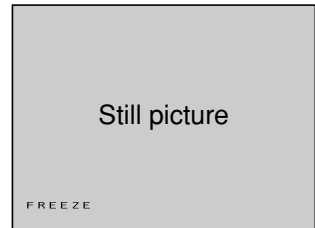

- The picture being projected will be paused.
- Press the FREEZE button again to cancel the still picture.

### NOTE:

- The FREEZE button will be disabled when “NETWORK” is selected. (PT-LB10NTE only)

# Enlarging the picture (D.ZOOM)

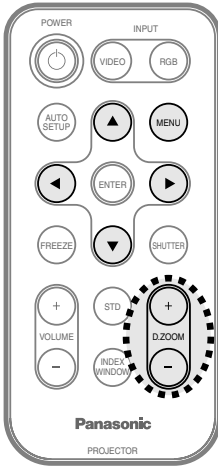

Press the D.ZOOM +/- button.

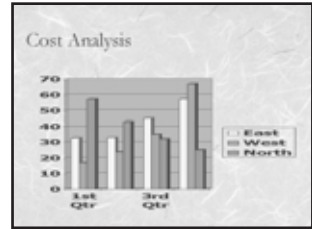

- The picture will then be enlarged to 1.5 times the normal size.

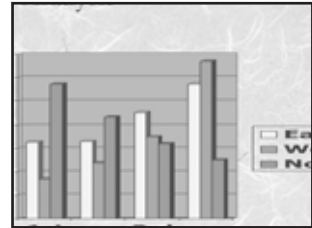

## The remote control unit functions during D.ZOOM (digital zoom)

Press the ▲, ▼, ◀ and ▶ buttons to move the enlarged area which you want to project.

Press the D.ZOOM +/- buttons to change the enlargement ratio.

Press the MENU button to return to the normal screen.

### NOTE:

- The enlargement ratio can be changed within the range of x1 to x2, in steps of 0.1. When RGB signals are being input, the enlargement ratio can be changed within the range of x1 to x3, except when the "FRAME LOCK" is set to "ON".
- If the type of signal being input changes while the digital zoom function is being used, the digital zoom function will be cancelled.

# Adjusting the volume (VOLUME)

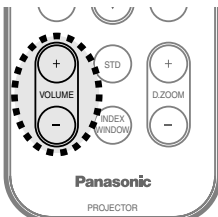

Press the VOLUME +/- button.

- Press the + button to raise the volume.
- Press the - button to lower the volume.

### NOTE:

- You can also select "VOLUME" from the "MAIN MENU" to adjust the volume.
- The VOLUME button will be disabled when "NETWORK" is selected. (PT-LB10NTE only)

# Displaying two screens (INDEX WINDOW)

This function lets you store a picture which is being projected into memory, so that you can display a still picture and a moving picture on the screen.



## Press the INDEX WINDOW button.

- The aspect ratio of the screen changes and the image is vertically elongated in comparison to a normal image.
- When “NETWORK” is selected, screen display will be switched between four window style and index style. (PT-LB10NTE only. Refer to the accessory CD-ROM for details.)

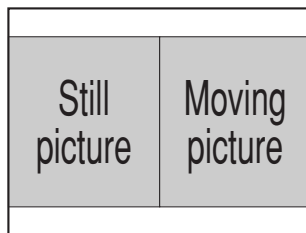

## The remote control unit functions during INDEX WINDOW

### Press the ▲ or ▼ button to select a screen size.

It can switch to three stages.

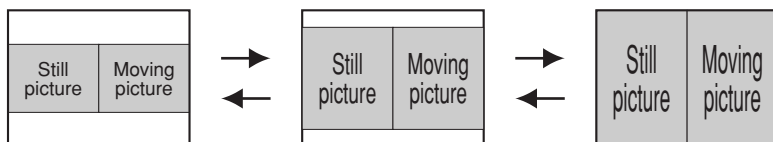

### Press the ◀ or ▶ button to switch between the still picture screen and moving picture screen.

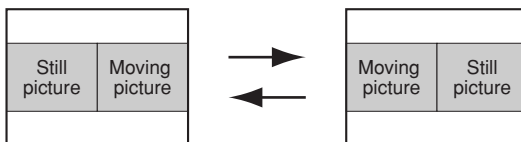

### Press the ENTER button to capture the present moving picture in a still window.

### Press the MENU button to return to the previous screen.

## NOTE:

- When the screen size is changed, the picture's aspect ratio will also change. Make sure that you fully understand the notes on “ASPECT” on page 42 before using the “INDEX WINDOW” function.
- “INDEX WINDOW” on the “MAIN MENU” is the same function.



# On-screen menus

## Menu screens

The various settings and adjustments for this projector can be carried out by selecting the operations from on-screen menus.

The general arrangement of these menus is shown below.

### MAIN MENU

MENU	
⬅➡	KEYSTONE
🖼️	PICTURE
📐	POSITION
🖼️	INDEX WINDOW
🔲	SHUTTER
🎵	VOLUME
🗣️	LANGUAGE
📁	OPTION1
📁	OPTION2
🔑	SECURITY
📡	NETWORK
⬇️	SELECT
🗑️	ENTER
🗑️	MENU
➡️	EXIT



- Press the MENU button to display the “MAIN MENU”. Refer to page 34 for details on how to operate the on-screen menus.

### 🖼️➡️ KEYSTONE correction (page 36)

KEYSTONE 0

- Keystone distortion of the on-screen display will not be corrected.

### 🖼️ PICTURE menu (page 37)

When an RGB signal is being input or NETWORK is selected

PICTURE	
PICTURE MODE (DYNAMIC)	
CONTRAST	32
BRIGHT	32
SHARPNESS	0
COLOR TEMP.	(STANDARD)
W-BAL R	32
W-BAL G	32
W-BAL B	32
AI	( ON )
SIGNAL MODE	XGA
STANDARD	
⬇️ SELECT ⬅️➡️ ADJ  RETRN	

- When NETWORK is selected, “W-BAL R/G/B” settings will not be displayed. (PT-LB10NTE only)

When a YPbPr signal is being input

PICTURE	
PICTURE MODE (STANDARD)	
CONTRAST	32
BRIGHT	32
COLOR	32
TINT	32
SHARPNESS	6
COLOR TEMP.	(STANDARD)
AI	( ON )
SIGNAL MODE	480P
STANDARD	
⬇️ SELECT ⬅️➡️ ADJ  RETRN	

When an S-VIDEO/VIDEO signal is being input

PICTURE	
PICTURE MODE (STANDARD)	
CONTRAST	32
BRIGHT	32
COLOR	32
TINT	32
SHARPNESS	8
COLOR TEMP.	(STANDARD)
AI	( ON )
TV-SYSTEM	( AUTO )
STILL MODE	( OFF )
STANDARD	
⬇️ SELECT ⬅️➡️ ADJ  RETRN	

-  **POSITION menu** (page 40)  
When an RGB/YPbPr signal is being input

POSITION	
<b>POSITION</b>	
DOT CLOCK	32
CLOCK PHASE	16
ASPECT	◀ 4:3 ▶
RESIZING	◀ ON ▶
FRAME LOCK	◀ OFF ▶
STANDARD	
⏴ SELECT  ENTER  RETRN	

When an S-VIDEO/VIDEO signal is being input

POSITION	
<b>POSITION</b>	
ASPECT	◀ 4:3 ▶
RESIZING	◀ ON ▶
STANDARD	
⏴ SELECT  ENTER  RETRN	

-  **INDEX WINDOW function** (page 31)

-  **SHUTTER function** (page 29)

### **VOLUME adjustment**

Press the ENTER button, and then press the ◀ or ▶ button to adjust the volume.

-  **LANGUAGE menu** (page 43)

LANGUAGE	ENGLISH
<b>ENGLISH</b>	
DEUTSCH	
FRANÇAIS	
ESPAÑOL	
ITALIANO	
РУССКИЙ	
한국어	
中文	
⏴ SELECT  ENTER  RETRN	

-  **OPTION1 menu** (page 43)

OPTION1	
<b>OSD</b>	
AUTO SEARCH	◀ ON ▶
AUTO SIGNAL	◀ ON ▶
AUTO KEYSTN	◀ ON ▶
RGB/YPbPr	◀ AUTO ▶
VGA60/480P	◀ 480P ▶
SXGA MODE	◀ SXGA ▶
NR	◀ OFF ▶
BLACKBOARD	◀ OFF ▶
⏴ SELECT  ADJ  RETRN	

-  **OPTION2 menu** (page 43)

OPTION2	
<b>BACK COLOR</b>	
FRONT/REAR	◀ FRONT ▶
DESK/CEILING	◀ DESK ▶
FAN CONTROL	◀ STANDARD ▶
LAMP POWER	◀ HIGH ▶
LAMP RUNTIME	◀ 10H ▶
FUNC 1	◀ INDEX ▶
CONTROL KEY	◀ ON ▶
AUTO POW. OFF	◀ DISABLE ▶
POWER MEMORY	◀ ON ▶
⏴ SELECT  ADJ  RETRN	

-  **SECURITY menu** (page 47)

SECURITY	
<b>INPUT PASSWD</b>	
AMEND PASSWD	◀ OFF ▶
TEXT DISPLAY	◀ OFF ▶
TEXT CHANGE	
⏴ SELECT  ADJ  RETRN	

-  **NETWORK menu** (page 49)  
(PT-LB10NTE only)

NETWORK	
<b>NETWORK 1</b>	
NAME CHANGE	◀ LB10NT ▶
INPUT PASSWD	◀ OFF ▶
AMEND PASSWD	
WEB CONTROL	◀ ON ▶
DEFAULT	
⏴ SELECT  ENTER  RETRN	

# Menu operation guide



Menu operation  
(on connector panel)

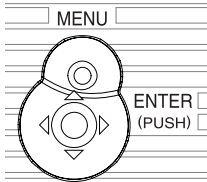

## ① Press the MENU button.

The "MAIN MENU" will be displayed.

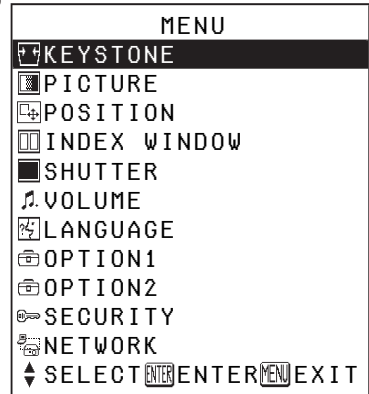

## ② Press the ▲ or ▼ button to select an item.

Selected item will be displayed in blue.

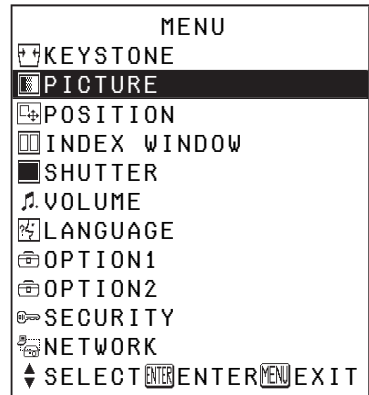

## ③ Press the ENTER button to accept the selection.

The selected menu screen or adjustment screen will then be displayed.  
(Example: "PICTURE" menu)

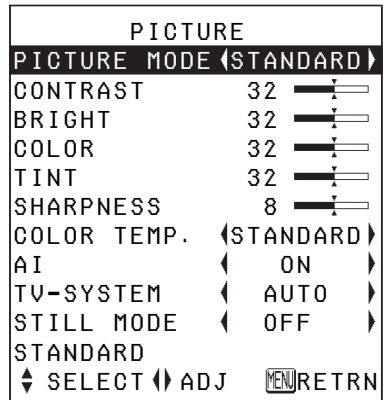

### NOTE:

- Press the MENU button to return to the previous screen.

- ④ Press the ▲ or ▼ button to select an item, and then press the ◀ or ▶ button to change or adjust the setting.

An individual adjustment screen such as the one shown below will be displayed for bar scale items.



The bar scale will turn green when any adjustment changes the setting from the factory set value.

## Unavailable on-screen menu items

This projector has unadjustable items and unusable functions depending on the signal being input.

When an item cannot be adjusted or a function cannot be used, the corresponding on-screen menu display does not appear, and the item or function will not work even if the ENTER button is pressed.

## Returning a setting to the factory default

If you press the STD (standard) button on the remote control unit, you can return settings to the factory default settings. However, the operation of this function varies depending on which screen is being displayed.

- When a menu screen is being displayed

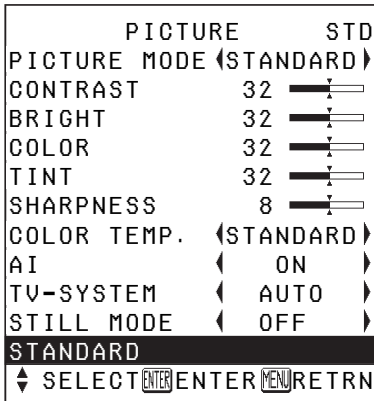

All items displayed will be returned to their factory default settings, “STD” will be displayed in the top-right screen and the bar scale will appear white.

### NOTE:

- You can also select “STANDARD” from the menu screen and then press the ENTER button.

- When an individual adjustment screen is being displayed



Only the item displayed will be returned to the factory default setting, and the bar scale will appear white.

### NOTE:

- Triangle symbols above and below the bar scale indicate the factory default setting. Items which do not have these triangle symbols cannot be returned to the factory default setting.

### Indicates the standard factory default setting

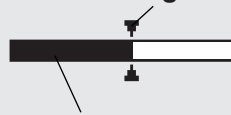

### Indicates the current adjustment value

- The positions of triangle symbols vary depending on the type of signal being input.

# Correcting keystone distortion

Keystone distortion is corrected automatically when the projector's automatic setup function is used, but this correction will not apply if the screen itself is tilted. In such cases, you can correct the keystone distortion manually with the following procedure.

## Vertical keystone distortion correction only.

KEYSTONE 0 

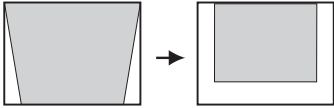
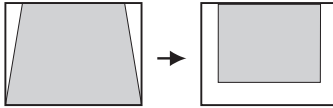
Vertical keystone distortion correction		
	Operation	Press the ► button.

### NOTE:

- If you press the AUTO SETUP button after correcting the keystone distortion manually, the automatic keystone correction function will operate and the corrected picture will return to its previous incorrect condition. To prevent this from happening, you can set "AUTO KEYSTN" in the "OPTION1" menu to "OFF". (Refer to page 44.)
- Vertical keystone distortion can be corrected to  $\pm 30^\circ$  of the angle of tilt. However, the greater the correction amount, the more the picture quality will deteriorate, and the harder it will become to achieve a good level of focus. To obtain the best picture quality, set up the projector and screen in such a way that the amount of keystone correction required is as minimal as possible.
- The picture size will also change when correction of keystone distortion is carried out.

# Adjusting the picture

Press the ▲ or ▼ button on the projector or remote control unit to select an item, and then press the ◀ or ▶ button to change the setting.

For items with bar scales, press the ENTER button or the ◀ or ▶ button to display the adjustment screen, and then press the ◀ or ▶ button to make the adjustment.

When an RGB signal is being input or NETWORK is selected

PICTURE	
PICTURE MODE (DYNAMIC ▶)	
CONTRAST	32
BRIGHT	32
SHARPNESS	0
COLOR TEMP.	(STANDARD ▶)
W-BAL R	32
W-BAL G	32
W-BAL B	32
AI	( ON ▶)
SIGNAL MODE	XGA
STANDARD	
◆ SELECT ◀▶ ADJ  RETRN	

When NETWORK is selected, “W-BAL R/G/B” settings will not be displayed. (PT-LB10NTE only)

When an YPBPR signal is being input

PICTURE	
PICTURE MODE (STANDARD ▶)	
CONTRAST	32
BRIGHT	32
COLOR	32
TINT	32
SHARPNESS	6
COLOR TEMP.	(STANDARD ▶)
AI	( ON ▶)
SIGNAL MODE	480P
STANDARD	
◆ SELECT ◀▶ ADJ  RETRN	

When an S-VIDEO/VIDEO signal is being input

PICTURE	
PICTURE MODE (STANDARD ▶)	
CONTRAST	32
BRIGHT	32
COLOR	32
TINT	32
SHARPNESS	8
COLOR TEMP.	(STANDARD ▶)
AI	( ON ▶)
TV-SYSTEM	( AUTO ▶)
STILL MODE	( OFF ▶)
STANDARD	
◆ SELECT ◀▶ ADJ  RETRN	

## PICTURE MODE

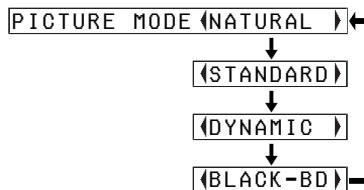

Select the picture mode that best matches the image source and room conditions.

The mode best used in dark rooms is “NATURAL”. For rooms having regular lighting conditions in use, select “STANDARD”. For exceptionally bright rooms, use “DYNAMIC”.

“BLACK-BD” is for the PT-LB10NTE/PT-LB10E/PT-LB10SE only. This item is available only when “BLACKBOARD” in the “OPTION1” menu is set to “ON”. Select “BLACK-BD” when projecting onto blackboards.

## CONTRAST

This adjusts the contrast of the picture. (Adjust the “BRIGHT” setting first if required before adjusting the “CONTRAST” setting.)

The picture is bright: ◀ button

The picture is dark: ▶ button

## BRIGHT

This adjusts the darker areas (black areas) in the picture.

Black areas are too light: ◀ button

Dark areas are too solid: ▶ button

## COLOR

(S-VIDEO/VIDEO/YPbPr only)

The colour is too deep: ◀ button

The colour is too pale: ▶ button

## TINT

(NTSC/NTSC 4.43/YPbPr only)

This adjusts the flesh tones in the picture.

The flesh tones are greenish:

◀ button

The flesh tones are reddish:

▶ button

## SHARPNESS

To soften the picture details:

◀ button

To sharpen the picture details:

▶ button

## COLOR TEMP.

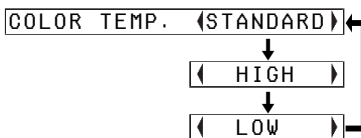

This is used to adjust the white areas of the picture if they appear bluish or reddish.

## White balance R/G/B (W-BAL R/G/B)

(RGB only)

This is used to adjust the white areas of the picture if they appear colourised.

To make the selected colour lighter:

◀ button

To make the selected colour stronger:

▶ button

## AI ON

The lamp is controlled according to the input signals to project images with the best quality.

## OFF

“AI” is disabled.

### NOTE:

- “AI” is disabled when “LAMP POWER” is set to “LOW”. (Refer to page 45.)

## TV-SYSTEM

(S-VIDEO/VIDEO only)

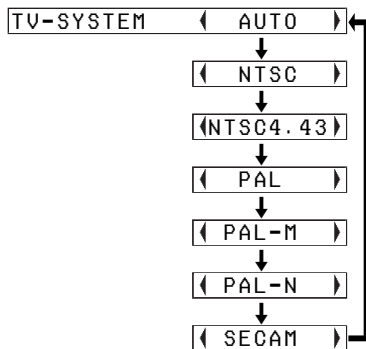

This should normally be set to “AUTO”. If the signal is of such poor quality that the correct format cannot be automatically distinguished, change the setting manually to the required TV system.

### NOTE:

- When set to “AUTO”, the projector automatically distinguishes between NTSC/NTSC 4.43/PAL/PAL60/PAL-M/PAL-N/SECAM signals.

## STILL MODE

(S-VIDEO/VIDEO only)

To reduce flickering of still images (vertical flicker), set “STILL MODE” to “ON”.

### NOTE:

- Set to “OFF” when playing back moving images.

## SIGNAL MODE

(RGB/YPbPr/NETWORK only)

This displays the type of signal which is currently being projected. Refer to the list on page 60 for details on each type of signal.

### Projecting sRGB-compatible pictures

sRGB is an international colour reproduction standard (IEC61966-2-1) established by the International Electrotechnical Commission (IEC). If you would like the colours in sRGB-compatible pictures to be reproduced more faithfully, make the following settings.

- ① Press the **▲** or **▼** button to select “PICTURE MODE”, and then press the **◀** or **▶** button to select “NATURAL”.
- ② Press the **STD** (standard) button on the remote control unit.
- ③ Press the **▲** or **▼** button to select “COLOR TEMP.”, and then press the **◀** or **▶** button to select “STANDARD”.

### NOTE:

- sRGB is only enabled when RGB signals are being input (when “LAMP POWER” is set to “HIGH” and “AI” is set to “OFF”).



# Adjusting the position

When an RGB signal is being input, press the AUTO SETUP button first to initiate automatic positioning. If the optimum setting is not obtained when "AUTO SETUP" is carried out, adjust by the following procedure.

Press the ▲ or ▼ button on the projector or remote control unit to select an item, and then press the ◀ or ▶ button to change the setting. For items with bar scales, press the ENTER button or the ◀ or ▶ button to display the adjustment screen, and then press the ◀ or ▶ button to make the adjustment.

When an RGB/YPbPr signal is being input

POSITION	
<b>POSITION</b>	
DOT CLOCK	32
CLOCK PHASE	16
ASPECT	◀ 4:3 ▶
RESIZING	◀ ON ▶
FRAME LOCK	◀ OFF ▶
STANDARD	
◄ SELECT  ENTER  MENU RETRN	

When an S-VIDEO/VIDEO signal is being input

POSITION	
<b>POSITION</b>	
ASPECT	◀ 4:3 ▶
RESIZING	◀ ON ▶
STANDARD	
◄ SELECT  ENTER  MENU RETRN	

## POSITION

Moves the picture position.

Press the ENTER button to display the "POSITION" screen.

Press the ◀ or ▶ button to move the picture horizontally.

Press the ▲ or ▼ button to move the picture vertically.

POSITION	H	64	
	V	32	

## DOT CLOCK

(RGB only)

Periodic striped pattern interference (noise) may occur when a striped pattern such as the one below is projected. If this happens, press the ◀ or ▶ button to adjust so that any such noise is minimised.

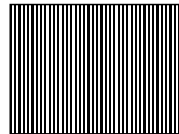

## CLOCK PHASE

(RGB/YPbPr only)

Adjust the "DOT CLOCK" setting first before carrying out this adjustment. Press the ◀ or ▶ button to adjust so that the noise level is least noticeable.

### NOTE:

- If signals with a dot clock frequency of 100 MHz or higher are being input, interference may not be completely eliminated when the "DOT CLOCK" and "CLOCK PHASE" adjustments are carried out.

## ASPECT

(S-VIDEO/VIDEO/480i, 576i, 480p and 576p YPbPr only)

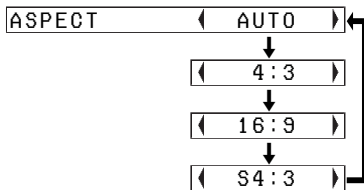

### AUTO

(S-VIDEO only)

When an S1 video signal is being input, the aspect ratio is changed automatically to project a 16:9 picture.

### 4:3

The input signal is projected without change.

### 16:9

The picture is compressed to a ratio of 16:9 and projected.

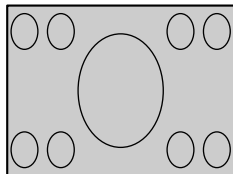

When a horizontally squeezed signal is being input.

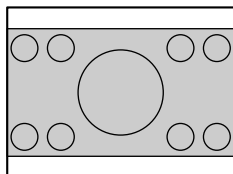

### S4:3

The size of the input signal is compressed to 75% and projected. (This is useful for projecting a picture with a 4:3 aspect ratio onto a 16:9 screen.)

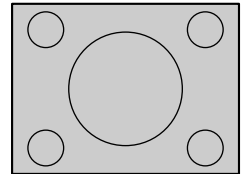

When a 4:3 signal is being input.

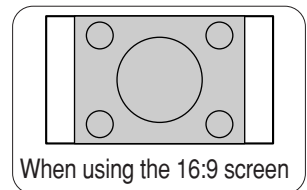
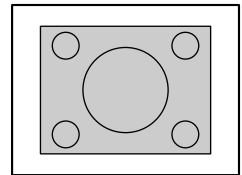

When using the 16:9 screen

### S1 video signals

- S1 video signals are a type of video signal with an aspect ratio of 16:9 which include a detector signal. This detector signal is output by some sources such as wide-vision video decks.
- When "ASPECT" is set to "AUTO", the projector recognizes the detector signal and automatically switches the aspect ratio to 16:9.

**NOTE:**

- If a selected mode does not match the aspect ratio of the input signal, it may affect the quality of viewing of the original picture. Keep this in mind when selecting the aspect ratio.
- If using this projector in places such as cafes or hotels to display programmes for a commercial purpose or for public presentation, note that if the aspect ratio (16:9) selection function is used to change the aspect ratio of the screen picture, you may be infringing the rights of the original copyright owner for that programme under copyright protection laws.
- If a normal (4:3) picture which was not originally intended for wide-screen viewing is projected onto a wide screen, distortion may occur around the edges of the picture, or part of the picture may not be visible. Such programmes should be viewed in 4:3 mode to give proper consideration to the aims and intentions of the original programme's creator.

**RESIZING**

This should normally be set to "ON". (This setting is only for signals which have lower resolutions than the LCD panels. Refer to page 60 for details.)

**ON**

The pixel resolution of the input signal is converted to the same resolution as the LCD panels before being projected. For signals with lower resolutions, gaps in the pixels are automatically interpolated into the picture before it is projected. This may sometimes cause problems with the quality of the picture.

**OFF**

The input signal is projected at its original resolution, with no pixel conversion. The projected picture will be smaller than normal, so adjust the zoom setting or move the projector forwards or backwards to adjust the picture size if necessary. If set to "OFF", some features, such as "D.ZOOM" (digital zoom), "KEYSTONE" or "INDEX WINDOW" will not function.

**FRAME LOCK**

If the picture's condition is bad while a RGB moving picture is projected, set "FRAME LOCK" to "ON". Refer to page 60 for compatible RGB signals.

# Changing the display language

Press the ▲ or ▼ button on the projector or remote control unit to select a language, then press the ENTER button to accept the setting.

LANGUAGE	ENGLISH
<b>ENGLISH</b>	
DEUTSCH	
FRANÇAIS	
ESPAÑOL	
ITALIANO	
РУССКИЙ	
한국어	
中文	
◆ SELECT	ENTER MENU RETRN

Indicates the language which is currently set.

## Option settings

Press the ▲ or ▼ button on the projector or remote control unit to select an item, then press the ◀ or ▶ button to change the setting.

OPTION1	
<b>OSD</b>	<b>ON</b>
AUTO SEARCH	ON
AUTO SIGNAL	ON
AUTO KEYSTN	ON
RGB/YP <sub>B</sub> PR	AUTO
VGA60/480P	480P
SXGA MODE	SXGA
NR	OFF
BLACKBOARD	OFF
◆ SELECT	ADJ MENU RETRN

OPTION2	
<b>BACK COLOR</b>	<b>BLUE</b>
FRONT/REAR	FRONT
DESK/CEILING	DESK
FAN CONTROL	STANDARD
LAMP POWER	HIGH
LAMP RUNTIME	10H
FUNC 1	INDEX
CONTROL KEY	ON
AUTO POW. OFF	DISABLE
POWER MEMORY	ON
◆ SELECT	ADJ MENU RETRN

## OSD

### ON

The signal name is displayed in the top-right corner of the screen when the input signal is changed.

### OFF

Use this setting when you do not want the signal name to be displayed.

### NOTE:

- The setting for “TV-SYSTEM” will also be displayed when an S-VIDEO/VIDEO signal is being input.

## AUTO SEARCH

This should normally be set to “ON”

### ON

When the power is turned on and “AUTO SETUP” is running, the projector detects which signals are being input, and uses these signals for projection.

(If a picture is being projected, the signal source is not automatically changed.)

### OFF

Use this setting when you do not want the signal source to be changed automatically when the power is turned on and “AUTO SETUP” is running.

## AUTO SIGNAL

This should normally be set to “ON”.

### ON

“AUTO SETUP” will be carried out automatically when the input signal is changed.

### OFF

“AUTO SETUP” will not function when the input signal is changed.

## AUTO KEYSTN

This should normally be set to “ON”.

### ON

During “AUTO SETUP”, the angle of tilt of the projector is detected and keystone distortion is corrected automatically.

### OFF

Use this setting when you do not want automatic keystone correction to be carried out during “AUTO SETUP”, such as when the screen itself is at an angle.

## RGB/YP<sub>B</sub>PR

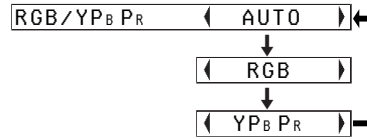

This should normally be set to “AUTO”. RGB or YP<sub>B</sub>PR is selected automatically depending on the synchronising signal status.

When 480i, 576i, 480p, 576p, 1 080/60i, 1 080/50i, 720/60p and some VGA480 signals are being input, select “RGB” or “YP<sub>B</sub>PR” in accordance with the input signal.

## VGA60/480p

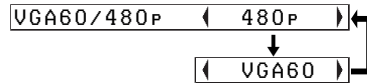

Set to “VGA60” when 59.9Hz VGA480 signals are being input (refer to page 60 for details). Set to “480p” when 480p RGB signals are being input.

## SXGA MODE

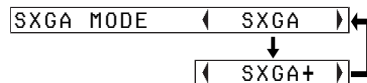

This setting is only for an SXGA signal.

### SXGA

Select this item normally.

### SXGA+

When the edges of the projected image are not visible, select this item.

## Noise Reduction (NR)

(S-VIDEO/VIDEO only)

If noise occurs from the projector because of a poor input signal, set “NR” to “ON”.

To turn off the “NR” feature, set it to “OFF”.

## BLACKBOARD

(PT-LB10NTE/PT-LB10E/  
PT-LB10SE only)

Set to “ON” when “PICTURE  
MODE” is set to “BLACK-BD”.

(Refer to page 37.)

## BACK COLOR

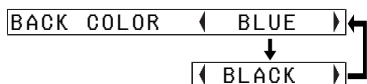

This sets the colour which is projected onto the screen when no signal is being input to the projector.

## FRONT/REAR

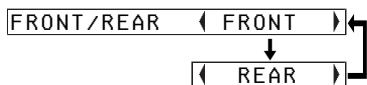

This setting should be changed in accordance with the projector setting-up method.  
(Refer to page 19.)

### FRONT

When the projector is placed in front of a screen.

### REAR

When using a translucent screen.

## DESK/CEILING

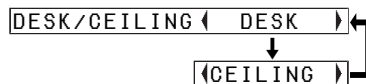

This setting should be changed in accordance with the projector setting-up method.  
(Refer to page 19.)

### DESK

When the projector is placed on a desk or similar.

### CEILING

When the projector is suspended from a ceiling using the ceiling bracket (sold separately).

## FAN CONTROL

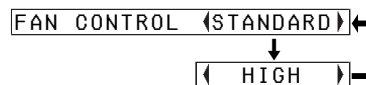

Set “FAN CONTROL” to “HIGH”, when using this projector at high elevations (above 1 400 m) only.

## LAMP POWER

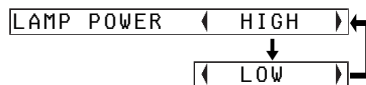

This setting changes the lamp brightness. When set to “LOW”, the luminance of the lamp is reduced, but the projector uses less power, and the operating noise is also reduced. This can help to extend the lamp’s operating life. If using the projector in small rooms where high luminance is not required, it is recommended that you set the “LAMP POWER” to “LOW”.

### NOTE:

- “LAMP POWER” cannot be set when no signal is being input.

## LAMP RUNTIME

This setting displays the usage time for the lamp unit which is currently being used. When replacing the lamp unit, follow the instructions on page 54, and reset “LAMP RUNTIME” to “0”.

### NOTE:

- The lamp’s operating life varies depending on the usage conditions (such as the “LAMP POWER” setting and the number of times the power is turned on and off).

## FUNC 1

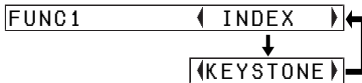

This assigns a function to the FUNC1 button of the ET-RM300 wireless remote control unit (sold separately).

### INDEX

Functions in the same way as the INDEX WINDOW button on the accessory card remote control unit. (page 31)

### KEYSTONE

Functions in the same way as when “KEYSTONE” is selected from the “MAIN MENU”. (page 36)

## CONTROL KEY

To disable the buttons on the projector, set “CONTROL KEY” to “OFF”. A confirmation screen will then be displayed. Select “OK” by using ◀ or ▶ button. To use the buttons on the projector, set to “ON” by using the remote control unit.

## AUTO POW.OFF

If no signal is input to the projector for the duration of the period you set, the projector will return to standby mode. The period can be set from 15 minutes to 60 minutes in 5 minute intervals. If you don’t use this feature, set it to “DISABLE”. This feature will not function when using the “FREEZE” function.

## POWER MEMORY

This sets the projector’s start up status for when the mains lead is connected.

### ON

The projector will start from the same status as when the mains lead was disconnected. If the mains lead was disconnected during projection when the projector was used the last time, projection will start after the mains lead is connected.

### OFF

The projector will be in standby mode.

# Setting up the security function

This projector is equipped with a security function. A password input screen can be displayed, or a company URL can be set up and displayed at the bottom of the projected image.

Press the ▲ or ▼ button on the projector or remote control unit to select “SECURITY”, then press the ENTER button.

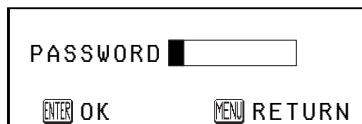
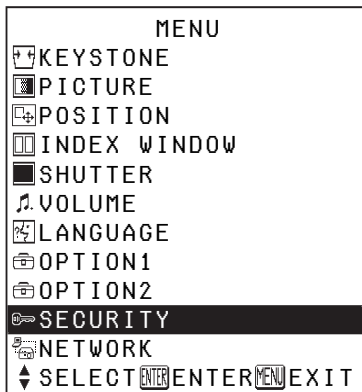

(When you use the “SECURITY” function for the first time)

Press the ▲, ►, ▼, ◀, ▲, ►, ▼ and ◀ buttons in order, then press the ENTER button.

(When a password change has been made before)

Type in the changed password, then press the ENTER button.

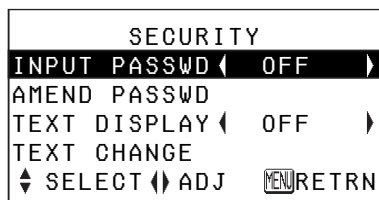

## INPUT PASSWD

The password input screen can be displayed when the power is turned on. All of the controls other than the POWER button are disabled unless the password is entered correctly.

### ON

“INPUT PASSWD” is enabled.

### OFF

“INPUT PASSWD” is disabled. The password input screen will not be displayed when the power is turned on.

## AMEND PASSWD

Passwords can be changed. Press the ENTER button to display the “AMEND PASSWD” screen.

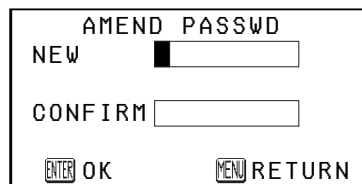

- ① Set a password by pressing the ▲, ▼, ◀, and ► buttons. (A maximum of 8 buttons can be set.)
- ② Press the ENTER button.
- ③ Enter the password again for confirmation.
- ④ Press the ENTER button. Password change will be completed.



**NOTE:**

- The entered password will appear as \*. It will not be displayed on the screen.
- If you enter the wrong password, the letters “PASSWORD” and “NEW” will become red. Enter the correct password again.

## TEXT DISPLAY

You can set text to be displayed at the bottom of the projected image at all times.

**ON**

“TEXT DISPLAY” is enabled.

**OFF**

“TEXT DISPLAY” is disabled.

## TEXT CHANGE

The text which is displayed when “TEXT DISPLAY” is set to “ON” can be changed.

Press the ENTER button to display the “TEXT CHANGE” screen.

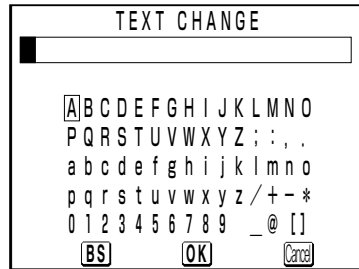

- ① Press the ▲, ▼, ◀ and ▶ buttons to select the characters, then press the ENTER button. (You can enter 22 characters continuously.)
  - Select “BS” to delete a character.
- ② Press the ▲, ▼, ◀ and ▶ buttons to select “OK”, then press the ENTER button.
  - Select “Cancel” to cancel the change.

# Network setup (PT-LB10NTE only)

You need to make adjustments on some items when controlling the projector with a personal computer by means of the wireless network. Refer to the accessory CD-ROM for details.

NETWORK	
<b>NETWORK</b>	<b>1</b>
NAME CHANGE	LB10NT
INPUT PASSWD	OFF
AMEND PASSWD	
WEB CONTROL	ON
DEFAULT	
⏏ SELECT <b>ENTER</b> ENTER <b>MENU</b> RETRN	

## NETWORK

Select the network setting you want to use.

## NAME CHANGE

The name for this projector can be set.

## INPUT PASSWD

Set to "ON" if you want password confirmation to be used when controlling the projector with a personal computer by means of the wireless network.

## AMEND PASSWD

Passwords can be changed.

## WEB CONTROL

To control the projector with a personal computer by means of the wireless network, set the "WEB CONTROL" to "ON".

## DEFAULT

Network settings can be returned to the factory default settings.

# When the TEMP indicator and the LAMP indicator are illuminated

There are two indicators on the control panel of the projector which give information about the operating condition of the projector. These indicators illuminate or flash to warn you about problems that have occurred inside the projector, so if you notice that one of the indicators is on, turn off the power and check the table below for the cause of the problem.

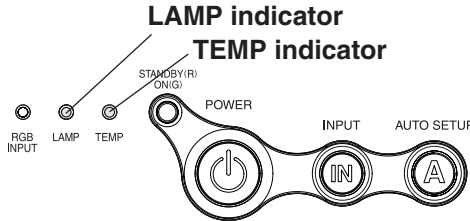

TEMP indicator		
Indicator display	Illuminated (red) (Lamp unit on)	Flashing (red) (Lamp unit off)
Problem	The surrounding temperature or the temperature inside the projector has become unusually high.	The surrounding temperature or the temperature inside the projector has become dangerously high, causing the lamp unit to automatically shut off.
Possible cause	<ul style="list-style-type: none"> <li>● The ventilation holes may be covered.</li> <li>● The ambient temperature in the place of use may be too high.</li> <li>● The air filter may be blocked.</li> </ul>	
Remedy	<ul style="list-style-type: none"> <li>● Uncover the ventilation holes.</li> <li>● Set up the projector in a place where the temperature is between 0 °C (32 °F) and 40 °C (104 °F) and the humidity is between 20% and 80% (with no condensation). [If you set the “FAN CONTROL” to “HIGH” (page 45), set up the projector in a place where the temperature is between 0 °C (32 °F) and 35 °C (95 °F) and the humidity is between 20% and 80% (with no condensation).]</li> <li>● Disconnect the mains lead by following the procedure on page 26, and then clean the air filter. (Refer to page 52)</li> </ul>	

<b>LAMP indicator</b>			
<b>Indicator display</b>	lluminated (red)	Flashing (red)	
<b>Problem</b>	It is nearly time to replace the lamp unit.	An abnormality has been detected in the lamp circuit.	
<b>Possible cause</b>	<ul style="list-style-type: none"> <li>Does “REPLACE LAMP” appear on the screen after the projector is turned on?</li> </ul>	<ul style="list-style-type: none"> <li>The power may have been turned on straight away after it was turned off.</li> </ul>	<ul style="list-style-type: none"> <li>There may be an abnormality in the lamp circuit.</li> </ul>
<b>Remedy</b>	<ul style="list-style-type: none"> <li>This occurs when the operation time for the lamp unit is nearing 1 800 hours (when “LAMP POWER” has been set to “HIGH”). Ask your dealer or an Authorised Service Centre to replace the lamp unit.</li> </ul>	<ul style="list-style-type: none"> <li>Wait for a while until the lamp unit cools down before turning the power back on again.</li> </ul>	<ul style="list-style-type: none"> <li>Disconnect the mains lead by following the procedure on page 26, and then contact an Authorised Service Centre.</li> </ul>

**NOTE:**

- Be sure to disconnect the mains lead by following the procedure given in “Turning off the power” on page 26 before carrying out any of the procedures in the “Remedy” column.
- If the power turns off after the TEMP indicator has illuminated, it means an abnormality has occurred. Please contact an Authorised Service Centre so that the necessary repairs can be made.

# Cleaning and replacing the air filter

If the air filter becomes clogged with dust, the internal temperature of the projector will rise, the TEMP indicator will illuminate and the projector's power will turn off (the TEMP indicator will flash after the power is turned off). **The air filter should be cleaned every 100 hours of use.**

## Cleaning

Use a vacuum cleaner to clean off any accumulated dust.

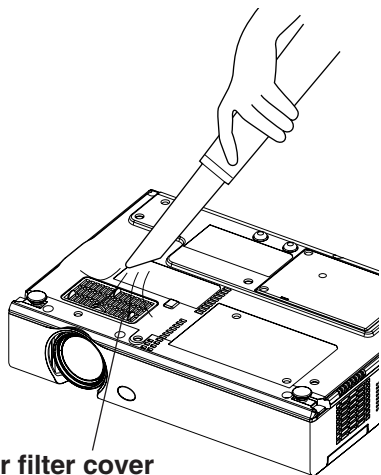

Air filter cover

### NOTE:

- If the dust cannot be cleaned by a vacuum cleaner, remove the air filter and soak it in water, and then wash out the dust by hand. Be sure to install the air filter after it has dried.
- Do not use detergent when washing the air filter.
- If the dust cannot be removed by cleaning, it is time to replace the air filter. Please consult your dealer. Furthermore, if the lamp unit is being replaced, replace the air filter at this time also.

## Replacement procedure

- ① Turn off the power and disconnect the mains lead. Be sure to disconnect the mains lead by following the procedure given on page 26.
- ② Gently turn the projector upside down, and then remove the air filter cover.

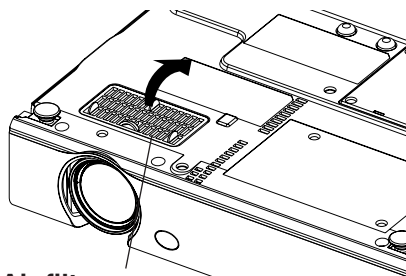

Air filter cover

- ③ Replace the air filter, and then install the air filter cover.

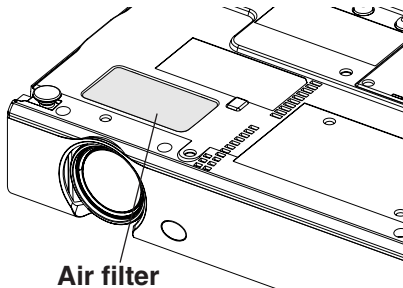

Air filter

### NOTE:

- Be sure to install the air filter before using the projector. If the projector is used without the air filter installed, dust and other foreign particles will be drawn into the projector, and malfunctions will result.

# Replacing the lamp unit

## Warning

When replacing the lamp, allow it to cool for at least one hour before handling it.

- The lamp cover gets very hot, and contact with it can cause burns.

## Notes on replacing the lamp unit

- The light generating lamp is made of glass, so dropping it or allowing it to hit hard objects may cause it to burst. Be careful when handling the lamp.
- Dispose of the removed old lamp with the same care that would be taken with a fluorescent light.
- A Phillips screwdriver is necessary for removing the lamp unit.

### NOTE:

- The projector is not supplied with a replacement lamp unit. Please ask your dealer for details. Lamp unit product no.: **ET-LAB10**

### CAUTION:

- Do not use any lamp unit other than the one with the product number indicated above.

## Lamp unit replacement period



The lamp is a consumable product. Even when the full life of the bulb has not been exhausted, the brightness of the light will gradually decline. Therefore periodic replacement of the lamp is necessary.

The intended lamp replacement interval is 2 000 hours, but it is possible that the lamp may need to be replaced earlier due to variables such as a particular lamp's characteristics, usage conditions and the installation environment. Early preparation for lamp replacement is encouraged.

The lamp will automatically shut off after approximately 10 minutes when 2 000 hours of use have been reached because of a much greater chance of it exploding after this time.

### NOTE:

- The usage hours explained above are for when "LAMP POWER" in the "OPTION2" menu has been set to "HIGH" and when "AI" in the "PICTURE" menu has been set to "OFF". If "LAMP POWER" is set to "LOW", or "AI" is set to "ON", the life of the lamp can be extended.
- While 2 000 hours is the intended replacement interval, it is not a period of time covered by warranty.

	On-screen display	LAMP indicator
		
More than 1 800 hours	Displayed for 30 seconds. Pressing any button will clear the display.	Illuminates red during image projection and standby mode.
More than 2 000 hours	Remains displayed until any button is pressed.	

## Lamp unit replacement procedure

### NOTE:

- If the lamp usage time has passed 2 000 hours (when “LAMP POWER” has been set to “HIGH” and when “AI” has been set to “OFF”), the projector will switch to standby mode after approximately 10 minutes of operation. The steps ⑦ to ⑪ on the next page should thus be completed within 10 minutes.

- ① **Disconnect the mains lead from the projector by following the procedure on page 26, and check that the area around the lamp unit has cooled down.**
- ② **Use a Phillips screwdriver to turn the lamp unit cover fixing screws at the bottom of the projector, and then remove the lamp unit cover.**

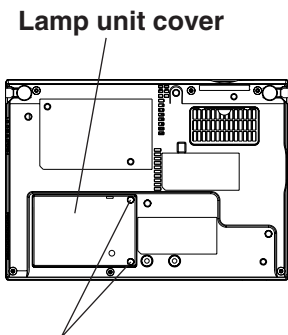

Lamp unit cover fixing screws

- ③ **Use a Phillips screwdriver to loosen the two lamp unit fixing screws until the screws turn freely. Then hold the handle of the lamp unit and gently pull it out from the projector.**

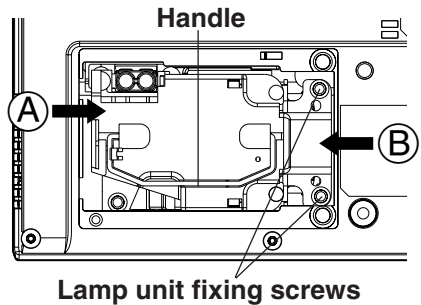

- ④ **Insert the new lamp unit while making sure that the direction of insertion is correct, and then use a Phillips screwdriver to securely tighten the lamp unit fixing screws.**

When inserting the new lamp unit, be sure to push it in at the point (A) and (B).

- ⑤ Install the lamp unit cover, and then use a Phillips screwdriver to securely tighten the lamp unit cover fixing screws.

**NOTE:**

- Be sure to install the lamp unit and the lamp unit cover securely. If they are not securely installed, it may cause the protection circuit to operate so that the power cannot be turned on.

- ⑥ Connect the mains lead.
- ⑦ Press the **POWER** button so that a picture is projected onto the screen.

**NOTE:**

- If the mains lead was disconnected during projection when the projector was used the last time, projection will start after the mains lead is connected (when “POWER MEMORY” in the “OPTION2” menu is set to “ON”). Refer to page 46 for details.

- ⑧ Press the **MENU** button to display the “MAIN MENU”, and then press the **▲** or **▼** button to select “OPTION2”.

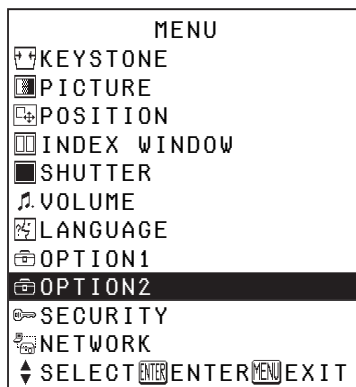

- ⑨ Press the **ENTER** button to display the “OPTION2” menu, and then press the **▲** or **▼** button to select “LAMP RUNTIME”.

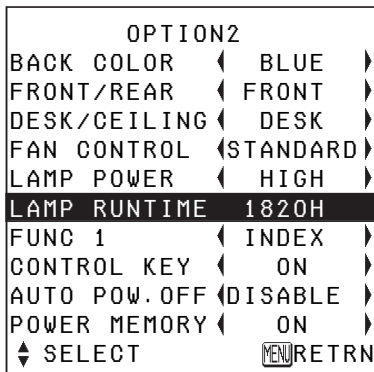

- ⑩ Press and hold the **ENTER** button for approximately 3 seconds.

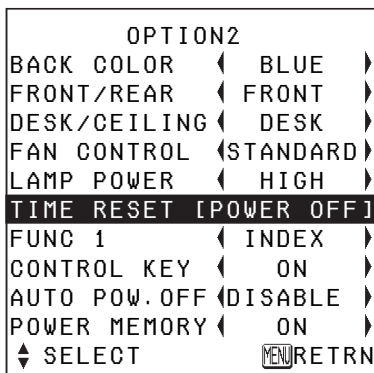

The “LAMP RUNTIME” will change to “TIME RESET [POWER OFF]”.

**NOTE:**

- If the **MENU** button is pressed, the lamp time resetting screen will be cancelled.

- ⑪ Turn off the power.
- This will reset the cumulative usage time for the lamp unit to “0”. Refer to page 26 for details on how to turn off the power.



# Before calling for service

Before calling for service, check the following points.

Problem	Possible cause	Page
<b>Power does not turn on.</b>	<ul style="list-style-type: none"> <li>● The mains lead may not be connected.</li> <li>● The main power supply is not being supplied to the mains socket.</li> <li>● TEMP indicator is illuminated or flashing.</li> <li>● LAMP indicator is illuminated or flashing.</li> <li>● The lamp unit cover has not been securely installed.</li> </ul>	<p>–</p> <p>–</p> <p>50</p> <p>51</p> <p>–</p>
<b>No picture appears.</b>	<ul style="list-style-type: none"> <li>● The video signal input source may not be connected properly.</li> <li>● The input selection setting may not be correct.</li> <li>● The “BRIGHT” adjustment setting may be at the minimum possible setting.</li> <li>● The “SHUTTER” function may be in use.</li> </ul>	<p>–</p> <p>25</p> <p>38</p> <p>29</p>
<b>The picture is fuzzy.</b>	<ul style="list-style-type: none"> <li>● The lens cover may still be attached to the lens.</li> <li>● The lens focus may not have been set correctly.</li> <li>● The projector may not be at the correct distance from the screen.</li> <li>● The lens may be dirty.</li> <li>● The projector may be tilted too much.</li> </ul>	<p>–</p> <p>25</p> <p>20</p> <p>–</p> <p>20</p>
<b>The colour is pale or grayish.</b>	<ul style="list-style-type: none"> <li>● “COLOR” or “TINT” adjustment may be incorrect.</li> <li>● The input source which is connected to the projector may not be adjusted correctly.</li> </ul>	<p>38</p> <p>–</p>
<b>No sound can be heard.</b>	<ul style="list-style-type: none"> <li>● The audio signal source may not be connected properly.</li> <li>● The volume adjustment may be at the lowest possible setting.</li> </ul>	<p>–</p> <p>30,</p> <p>33</p>
<b>The remote control unit does not operate.</b>	<ul style="list-style-type: none"> <li>● The battery may be weak.</li> <li>● The battery may not be inserted correctly.</li> <li>● The remote control signal receptor on the projector may be obstructed.</li> <li>● The remote control unit may be out of the operation range.</li> </ul>	<p>–</p> <p>23</p> <p>23</p> <p>23</p>
<b>The buttons on the projector do not function.</b>	<ul style="list-style-type: none"> <li>● The “CONTROL KEY” may be set to “OFF”. In order to set the “CONTROL KEY” to “ON” without using the remote control unit, keep holding down the ENTER button on the projector and press the MENU button for more than 2 seconds.</li> </ul>	<p>46</p>

Problem	Possible cause	Page
The picture does not display correctly.	● The signal format (“TV-SYSTEM”) may not be set correctly.	39
	● There may be a problem with the video tape or other signal source.	–
	● A signal which is not compatible with the projector may be being input.	60
Picture from computer does not appear.	● The cable may be too long.	–
	● The external video output for the laptop computer may not be set correctly. (You may be able to change the external output settings by pressing the [Fn]+[F3] or [Fn]+[F10] keys simultaneously. The actual method varies depending on the type of computer, so refer to the documentation provided with your computer for further details.)	–
	● If an RGB INPUT indicator is turned off, the video signals may not be output from the computer.	16

## Cleaning and maintenance

**Before carrying out cleaning and maintenance, be sure to disconnect the mains plug from the mains socket.**

**Wipe the cabinet with a soft, dry cloth.**

If the cabinet is particularly dirty, soak the cloth in water with a small amount of neutral detergent in it, squeeze the cloth very well, and then wipe the cabinet. After cleaning, wipe the cabinet dry with a dry cloth. If using a chemically-treated cloth, read the instructions supplied with the cloth before use.

**Do not wipe the lens with a cloth that is dusty or which produces lint.**

If any dust or lint gets onto the lens, such dust or lint will be magnified and projected onto the screen. Use a blower to clean any dust and lint from the lens surface, or use a soft cloth to wipe off any dust or lint.

# Specifications

Power supply:	100 V - 240 V ~, 50 Hz/60 Hz
Power consumption:	220 W [During standby (when fan is stopped): Approx. 6 W]
Amps:	2.5 A - 1.0 A

---

LCD panel:	
Panel size (diagonal):	0.7 type (17.78 mm)
Aspect ratio:	4:3
Micro lens array:	Available
Display method:	3 transparent LCD panels (RGB)
Drive method:	Active matrix method
Pixels:	
PT-LB10NTE/PT-LB10E/PT-LB10VE:	786 432 (1 024 x 768) x 3 panels
PT-LB10SE:	480 000 (800 x 600) x 3 panels

---

Lens:	Manual zoom (1 - 1.2) / Manual focus
PT-LB10NTE/PT-LB10E/PT-LB10SE:	F 1.7 - 1.9 f 21.5 mm - 25.8 mm
PT-LB10VE:	F 2.0 - 2.3 f 22.0 mm - 26.2 mm

---

Lamp:	UHM lamp (155 W)
-------	------------------

---

Luminosity:	
PT-LB10NTE/PT-LB10E/PT-LB10SE:	2 000 lm
PT-LB10VE:	1 600 lm

---

Scanning frequency (for RGB signals):	
Horizontal scanning frequency:	15 kHz - 91 kHz
Vertical scanning frequency:	50 Hz - 85 Hz
Dot clock frequency:	Less than 100 MHz

---

YPbPr signals:	480i, 576i, 480p, 576p, 1 080/60i, 1 080/50i, 720/60p
----------------	--

---

Colour system:	7 (NTSC/NTSC 4.43/PAL/PAL-M/PAL-N/ PAL60/SECAM)
----------------	--

---

Projection size:	838.2 mm - 7 620 mm (33" - 300")
------------------	----------------------------------

---

Throw distance:	
PT-LB10NTE/PT-LB10E/PT-LB10SE:	1.1 m - 10.7 m (3'7" - 35'1")
PT-LB10VE:	1.1 m - 11.0 m (3'7" - 36'1")

---

Optical axis shift:	6:1 (fixed)
---------------------	-------------

---

Screen aspect ratio:	4:3
----------------------	-----

---

Installation:	Front/Rear/Ceiling/Desk (menu selection)
---------------	--

---

Speaker:	4 cm x 3 cm oval x 1
----------	----------------------

---

Max. useable volume output:	1 W (mono)
-----------------------------	------------

## Connectors

---

RGB IN/OUT:	Dual line, one for input and one for output. D-sub HD 15-pin (female)
-------------	--

During YPbPr input/output:

Y:	1.0 V [p-p] (Including sync), 75 $\Omega$
PB, PR :	0.7 V [p-p], 75 $\Omega$

During RGB input/output:	
R.G.B.:	0.7 V [p-p], 75 Ω
G.SYNC:	1.0 V [p-p], 75 Ω
HD/SYNC:	TTL, automatic positive/negative polarity compatible
VD:	TTL, automatic positive/negative polarity compatible
VIDEO IN:	Single-line, RCA pin jack 1.0 V [p-p], 75 Ω
S-VIDEO IN:	Single-line, Mini DIN 4-pin Y 1.0 V [p-p], C 0.286 V [p-p], 75 Ω
AUDIO IN:	Single-line, RCA pin jack x 2 (L-R) 0.5 V [rms]
SERIAL:	DIN 8-pin RS-232C compatible
<hr/>	
Cabinet:	Moulded plastic (PC/ABS)
Dimensions:	
Width:	297 mm (11-11/16")
Height:	73 mm (2-27/32")
Length:	210 mm (8-1/4")
<hr/>	
Weight:	
PT-LB10NTE:	2.2 kg (4.9 lbs.)
PT-LB10E/PT-LB10VE/PT-LB10SE:	2.1 kg (4.6 lbs.)
Operating environment:	
Temperature:	0 °C - 40 °C (32 °F - 104 °F) [When the "FAN CONTROL" is set to "HIGH" (page 45): 0 °C - 35 °C (32 °F - 95 °F)]
Humidity:	20% - 80% (no condensation)
Certifications:	EN60950, EN55022, EN61000-3-2, EN61000-3-3, EN55024
<hr/>	
<b>&lt;Remote control unit&gt;</b>	
Power supply:	3 V DC (Lithium CR2025 battery x1)
Operating range:	Approx. 7 m (23') (when operated directly in front of signal receptor)
Weight:	18 g (0.6 ozs.) (including battery)
Dimensions:	
Width:	40 mm (1-9/16")
Length:	6.5 mm (-1/4")
Height:	86 mm (3-3/8")
<hr/>	
<b>&lt;Options&gt;</b>	
Ceiling bracket	ET-PKC80
Wireless remote control unit	ET-RM300
Serial adapter (DIN 8-pin/D-sub 9-pin)	ET-ADSER
Wireless card	ET-CDWL3E/ET-CDWL2E ET-CDWL3ES/ET-CDWL2ES (for Spain) ET-CDWL3SG/ET-CDWL2SG (for Singapore) ET-CDWL3U/ET-CDWL2U (for Malaysia)

# Appendix

## List of compatible signals

Mode	Display resolution (dots)*1	Scanning frequency		Dot clock frequency (MHz)	Picture quality*2		Resizing*3		Format
		H (kHz)	V (Hz)		LB10NTE LB10E LB10VE	LB10SE	LB10NTE LB10E LB10VE	LB10SE	
NTSC/NTSC4.43/ PAL-M/PAL60	720 x 480i	15.7	59.9		A	A	OK	OK	Video/S-Video
PAL/PAL-N/SECAM	720 x 576i	15.6	50.0		A	A	OK	OK	Video/S-Video
480i	720 x 480i	15.7	59.9	13.5	A	A	OK	OK	YPbPr/RGB
576i	720 x 576i	15.6	50.0	13.5	A	A	OK	OK	YPbPr/RGB
480p	720 x 483	31.5	59.9	27.0	A	A	OK	OK	YPbPr/RGB
576p	720 x 576	31.3	50.0	27.0	A	A	OK	OK	YPbPr/RGB
1 080/60i	1 920 x 1 080i	33.8	60.0	74.3	A	A			YPbPr/RGB
1 080/50i	1 920 x 1 080i	28.1	50.0	74.3	A	A			YPbPr/RGB
720/60p	1 280 x 720	45.0	60.0	74.3	A	A			YPbPr/RGB
VGA400	640 x 400	31.5	70.1	25.2	A	A	OK	OK	RGB
	640 x 400	37.9	85.1	31.5	A	A	OK	OK	RGB
VGA480 *4	640 x 480	31.5	59.9	25.2	A	A	OK	OK	RGB
	640 x 480	35.0	66.7	30.2	A	A	OK	OK	RGB
	640 x 480	37.9	72.8	31.5	A	A	OK	OK	RGB
	640 x 480	37.5	75.0	31.5	A	A	OK	OK	RGB
	640 x 480	43.3	85.0	36.0	A	A	OK	OK	RGB
SVGA	800 x 600	35.2	56.3	36.0	A	AA	OK		RGB
*4	800 x 600	37.9	60.3	40.0	A	AA	OK		RGB
	800 x 600	48.1	72.2	50.0	A	AA	OK		RGB
	800 x 600	46.9	75.0	49.5	A	AA	OK		RGB
	800 x 600	53.7	85.1	56.3	A	AA	OK		RGB
MAC16	832 x 624	49.7	74.6	57.3	A	A	OK		RGB
XGA *4	1 024 x 768	48.4	60.0	65.0	AA	A			RGB
	1 024 x 768	56.5	70.1	75.0	AA	A			RGB
	1 024 x 768	60.0	75.0	78.8	AA	A			RGB
	1 024 x 768	68.7	85.0	94.5	AA	A			RGB
	1 024 x 768i	35.5	87.0	44.9	AA	A			RGB
MXGA	1 152 x 864	64.0	71.2	94.2	A	A			RGB
	1 152 x 864	67.5	74.9	108.0	B	B			RGB
	1 152 x 864	76.7	85.0	121.5	B	B			RGB
MAC21	1 152 x 870	68.7	75.1	100.0	B	B			RGB
MSXGA *4	1 280 x 960	60.0	60.0	108.0	B	B			RGB
SXGA *4	1 280 x 1 024	64.0	60.0	108.0	B	B			RGB
	1 280 x 1 024	80.0	75.0	135.0	B	B			RGB
	1 280 x 1 024	91.1	85.0	157.5	B	B			RGB
*4	1 400 x 1 050	64.0	60.0	108.0	B	B			RGB
UXGA *4	1 600 x 1 200	75.0	60.0	162.0	B	B			RGB

\*1 The “i” appearing after the resolution indicates an interlaced signal.

\*2 The following symbols are used to indicate picture quality.

AA Maximum picture quality can be obtained.

A Signals are converted by the image processing circuit before picture is projected.

B Some loss of data occurs to make projection easier.

\*3 Signals with “OK” in the “Resizing” column can be set using the “RESIZING” command in the “POSITION” menu. (page 42)

\*4 Signals that are compatible with the “FRAME LOCK” function. (page 42)

# Pin assignments

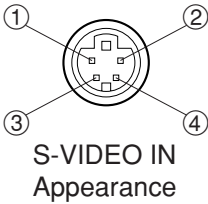

Pin No.	Signal
①	Earth (Luminance signal)
②	Earth (Colour signal)
③	Luminance signal
④	Colour signal

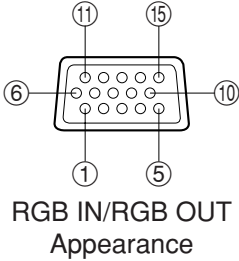

Pin No.	Signal
①	R/P <sub>R</sub>
②	G/G·SYNC/Y
③	B/P <sub>B</sub>
⑫	SDA
⑬	HD/SYNC
⑭	VD
⑮	SCL

Pin ④ and ⑨ are spare.

Pins ⑤ -⑧, ⑩ and ⑪ are for earth.

Pins ⑫ and ⑮ functions are only valid when supported by the computer.

## Projection dimensions calculation methods

If the screen size (diagonal) is SD (m), then the following formula is used to calculate the projection distance for the wide lens position (LW) and the projection distance for the telephoto lens position (LT).

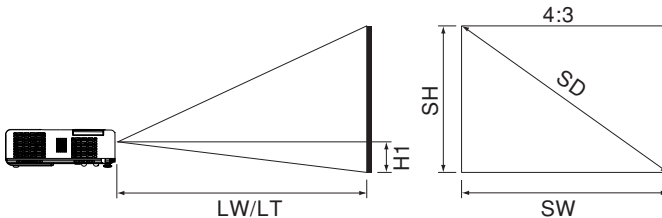

PT-LB10NTE/PT-LB10E/PT-LB10SE	PT-LB10VE
$LW=0.030 \times SD / 0.0254 - 0.037$	$LW=0.031 \times SD / 0.0254 - 0.038$
$LT=0.036 \times SD / 0.0254 - 0.037$	$LT=0.037 \times SD / 0.0254 - 0.038$

For 16:9 aspect ratios, the following formula can be used to calculate the projection distance.

PT-LB10NTE/PT-LB10E/PT-LB10SE	PT-LB10VE
$LW=0.032 \times SD / 0.0254 - 0.037$	$LW=0.033 \times SD / 0.0254 - 0.038$
$LT=0.039 \times SD / 0.0254 - 0.037$	$LT=0.040 \times SD / 0.0254 - 0.038$

\*The values obtained from the formulas above are approximate.

# Using the SERIAL connector

The serial connector which is on the connector panel of the projector conforms to the RS-232C interface specification, so that the projector can be controlled by a personal computer which is connected to this connector.

## Connection

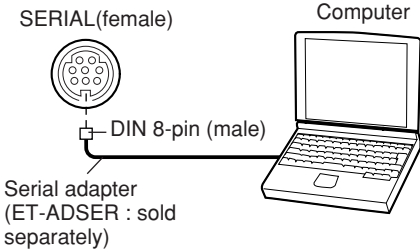

You must use only RS-232C Serial Interface Cable with ferrite core, type ET-ADSER.

## Pin assignments and signal names

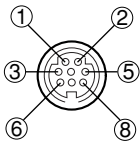

DIN 8-pin Appearance

Pin No.	Signal name	Contents
③	RXD	Received data
④	GND	Earth
⑤	TXD	Transmitted data
①		Connected internally
②		
⑥		
⑦		NC
⑧		NC

## Communications settings

Signal level	RS-232C
Sync. method	Asynchronous
Baud rate	9 600 bps
Parity	None
Character length	8 bits
Stop bit	1 bit
X parameter	None
S parameter	None

## Basic format

The data sent from the computer to the projector is transmitted in the format shown below.

STX	Command	:	Parameter	ETX
Start byte (02h)	3 bytes		1 byte 1 byte-5 bytes	End byte (03h)

### NOTE:

- The projector can not receive the command for 10 seconds after the lamp is switched on. Wait 10 seconds before sending the command.
- If sending multiple commands, check that a response has been received from the projector for one command before sending the next command.
- When a command which does not require parameters is sent, the colon (:) is not required.
- If an incorrect command is sent from the personal computer, the "ER401" command will be sent from the projector to the personal computer.

## Control commands

The commands which the personal computer can use to control the projector are shown in the following table.

Command	Control Contents	Remarks
PON	Power ON	In standby mode, all commands other than the PON command are ignored. <ul style="list-style-type: none"> <li>• The PON command is ignored during lamp ON control.</li> <li>• If a PON command is received while the cooling fan is operating after the lamp has switched off, the lamp is not turned back on again straight away, in order to protect the lamp.</li> </ul>
POF	Power OFF	
AVL	Volume	Parameter 000-063 (Adjustment value 0-63)
IIS	Input signal selection	Parameter VID=VIDEO                      SVD=S-VIDEO RG1=RGB (YPbPr) NWP=NETWORK (PT-LB10NTE only)
Q\$\$	Lamp ON condition query	Callback 0 = Standby 1 = Lamp ON control active 2 = Lamp ON 3 = Lamp OFF control active

## Cable specifications

(When connected to a personal computer)

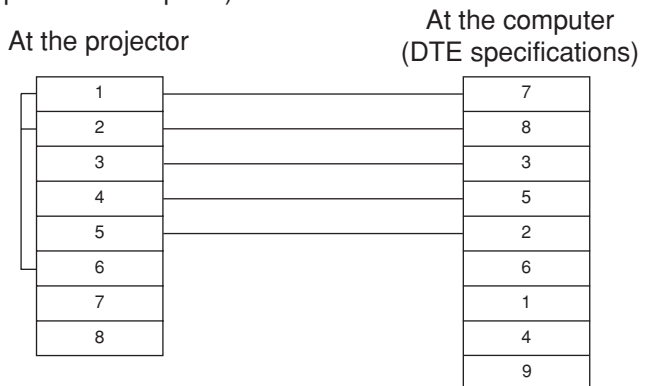



# Dimensions

<Units: mm (inch)>

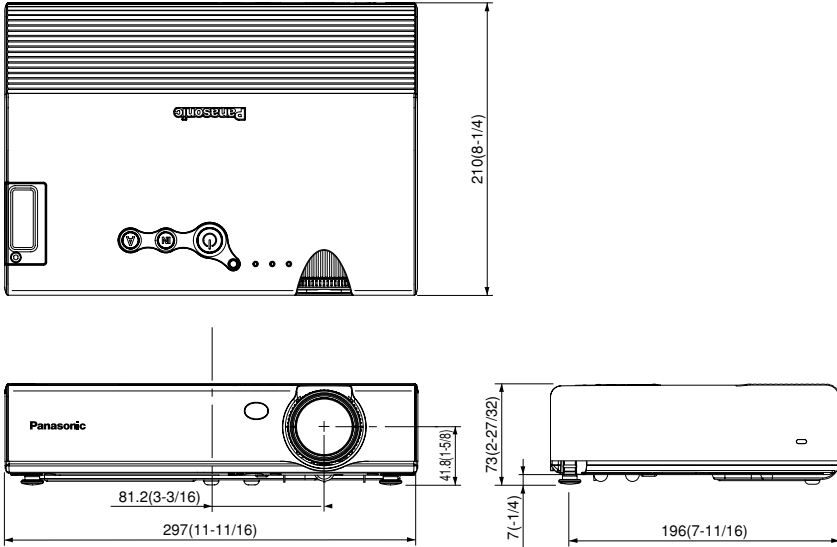

## Trademark acknowledgements

- VGA and XGA are trademarks of International Business Machines Corporation.
- Macintosh is a registered trademark of Apple Computer, Inc.
- S-VGA is a registered trademark of the Video Electronics Standards Association.

All other trademarks are the property of the various trademark owners.

These Operating Instructions are printed on recycled paper.