

myprojectorlamps.com

**The most trusted, dependable name
in projector lamp sales.**



<http://www.myprojectorlamps.com>



<http://www.myprojectorlamps.ca>



<http://www.myprojectorlamps.eu>

The following projector manual has not been modified or altered in any way.

Panasonic®

Operating Instructions

LCD Projector **Commercial Use**

Model No. **PT-FW100NTU**

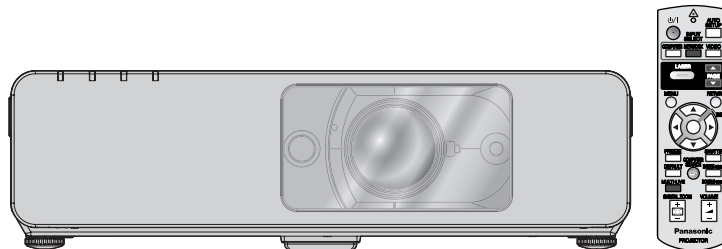

Before operating this product, please read the instructions carefully and save this manual for future use.

TQBJ0216

ENGLISH

Important Safety Notice

Dear Panasonic Customer:

This instruction booklet provides all the necessary operating information that you might require. We hope it will help you to get the most out of your new product, and that you will be pleased with your Panasonic LCD projector. The serial number of your product may be found on its bottom. You should note it in the space provided below and retain this booklet in case service is required.

Model number: **PT-FW100NTU**

Serial number:

WARNING: TO REDUCE THE RISK OF FIRE OR ELECTRIC SHOCK, DONOT EXPOSE THIS PRODUCT TO RAIN OR MOISTURE.

Power Supply: This LCD Projector is designed to operate on 100 V - 240 V, 50 Hz/60 Hz AC, house current only.

CAUTION: The AC power cord which is supplied with the projector as an accessory can only be used for power supplies up to 125 V, 7 A. If you need to use higher voltages or currents than this, you will need to obtain a separate 250 V power cord. If you use the accessory cord in such situations, fire may result.

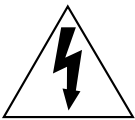

The lightning flash with arrowhead symbol, within an equilateral triangle, is intended to alert the user to the presence of uninsulated "dangerous voltage" within the product's enclosure that may be of sufficient magnitude to constitute a risk of electric shock to persons.



The exclamation point within an equilateral triangle is intended to alert the user to the presence of important operating and maintenance (servicing) instructions in the literature accompanying the product.

CAUTION: This equipment is equipped with a three-pin grounding-type power plug. Do not remove the grounding pin on the power plug. This plug will only fit a grounding-type power outlet. This is a safety feature. If you are unable to insert the plug into the outlet, contact an electrician. Do not defeat the purpose of the grounding plug.

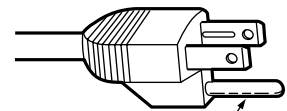

Do not remove

Pursuant to at the directive 2004/108/EC, article 9(2)
 Panasonic Testing Centre
 Panasonic Service Europe, a division of Panasonic Marketing Europe GmbH
 Winsbergring 15, 22525 Hamburg, F.R. Germany

NOTICE:

- This product has a High Intensity Discharge (HID) lamp that contains mercury. Dispose may be regulated in your community due to environmental considerations. For disposal or recycling information, please contact your local authorities, or the Electronics Industries Alliance: <http://www.eiae.org>

WARNING:

This equipment has been tested and found to comply with the limits for a Class B digital device, pursuant to Part 15 of the FCC Rules. These limits are designed to provide reasonable protection against harmful interference in a residential installation. This equipment generates, uses and can radiate radio frequency energy and, if not installed and used in accordance with the instructions, may cause harmful interference to radio communications. However, there is no guarantee that interference will not occur in a particular installation. If this equipment does cause harmful interference to radio or television reception, which can be determined by turning the equipment off and on, the user is encouraged to try to correct the interference by one or more of the following measures:

- Reorient or relocate the receiving antenna.
- Increase the separation between the equipment and receiver.
- Connect the equipment into an outlet on a circuit different from that to which the receiver is connected.
- Consult the dealer or an experienced radio/TV technician for help.

FCC CAUTION: To assure continued compliance, use only shielded interface cables when connecting to computers or peripheral devices. Any unauthorized changes or modifications to this equipment will void the users authority to operate.

If you use serial port to connect PC for external control of projector, you must use optional RS-232C serial interface cable with ferrite core. Any unauthorized changes or modifications to this equipment will void the user's authority to operate.

FCC RF Exposure Warning: (if provided with wireless device)

- This equipment complied with FCC radiation exposure limits set forth for an uncontrolled environment.
- This equipment has been approved for mobile operation and requires minimum 20 cm spacing be provided between antenna(s) and all person's body (excluding extremities of hands, wrist and feet) during wireless modes of operation.
- This equipment may not be used with other installed transmitters, which may be capable of simultaneous transmission.

WARNING:

- Not for use in a computer room as defined in the Standard for the Protection of Electronic Computer/Data Processing Equipment, ANSI/NFPA 75.
- For permanently connected equipment, a readily accessible disconnect device shall be incorporated in the building installation wiring.
- For pluggable equipment, the socket-outlet shall be installed near the equipment and shall be easily accessible.

Declaration of Conformity

Model Number: PT-FW100NTU
 Trade Name: **Panasonic**
 Responsible party: Panasonic Corporation of North America
 Address: One Panasonic Way, Secaucus, New Jersey 07094
 Telephone number: (888) 411 - 1996
 E-mail: projectorsupport@us.panasonic.com

This device complies with Part 15 of the FCC Rules. Operation is subject to the following two conditions: (1) This device may not cause harmful interference, and (2) this device must accept any interference received, including interference that may cause undesired operation.

Information on Disposal in other Countries outside the European



This symbol is only valid in the European Union.

If you wish to discard this product, please contact your local authorities or dealer and ask for the correct method of disposal.

Contents

Quick steps

1. Set up your projector
See “Setting up” on page 14.



2. Connect with other devices
See “Connections” on page 18.



3. Prepare the Remote control
See “Remote control” on page 11.



4. Start projecting
See “Switching the projector on/off” on page 20.



5. Adjust the image
See “Menu Navigation” on page 27.

- When you start the projection for the first time, the minimum required setting screen for projection will be displayed. See “Minimum required setting screen” on page 10.

Important Information

Important Safety Notice	2
Precautions with regard to safety	6
WARNINGS	6
CAUTIONS.....	7
Cautions when transporting	8
Cautions when installing	8
Cautions on use	9
Accessories	9

Preparation

Read this first	10
Minimum required setting screen	10
About Your Projector	11
Remote control	11
Projector body	12

Getting Started

Setting up	14
Screen size and throw distance	14
Projection method	15
Front leg adjusters and throwing angle	15
Lens shift and positioning.....	16
Connections	18
Before connection to the projector	18
Connecting with computers.....	18
Connecting with AV equipment	19

Basic Operation

Switching the projector on/off	20
Power cord	20
POWER indicator	20
Switching on the projector.....	21
Switching off the projector.....	21
Projecting an image	22
Selecting the input signal	22
Positioning the image.....	22
Remote control operation	23
Operating range	23
Setting up the image position automatically.....	23
Switching the input signal.....	24
Using the laser pointer	24
Capturing an image.....	25
Stopping the projection temporary	25
Resetting to the factory default settings	25
Projecting an image in INDEX-WINDOW mode.....	25
Projecting 2 images at a time.....	26
Enlarging the centred area.....	26
Controlling the volume of the speaker.....	26

Settings

Menu Navigation	27
Navigating through the MENU	27
Main menu and Sub-menu	28
PICTURE menu	30
PICTURE MODE	30
CONTRAST	30
BRIGHTNESS	30
COLOR	30
TINT	30
SHARPNESS	30
COLOR TEMPERATURE	30
DAYLIGHT VIEW	30
DETAILED SETUP	31
POSITION menu	32
KEYSTONE	32
POSITION	32
DOT CLOCK	32
CLOCK PHASE	32
ASPECT	32
FRAME LOCK	33
OPTION menu	34
INPUT GUIDE	34
STARTUP LOGO	34
COMPUTER2 SELECT	34
FILTER SETUP	34
FILTER REMAINING	34
LAMP RUNTIME	35
POWER OFF TIMER	35
DIRECT POWER ON	35
CONTROL PANEL	35
AUTO SETUP	35
SIGNAL SEARCH	35
INSTALLATION	35
SCREEN FORMAT	35
HIGHLAND	36
TEST PATTERN	36
DETAILED SETUP	36
SECURITY menu	37
INPUT PASSWORD	37
PASSWORD CHANGE	37
TEXT DISPLAY	37
TEXT CHANGE	37
NETWORK menu	38
Items in NETWORK menu	38

Maintenance

TEMP, LAMP and FILTER Indicators	39
Managing the indicated problems	39
Care and Replacement	40
Cleaning the projector	40
Replacing the ARF (Auto Rolling Filter)	40
Replacing the Lamp unit	41
Ceiling mount bracket safeguards	42
Troubleshooting	43

Appendix

Technical Information	44
List of compatible signals	44
Serial terminal	45
Computer connection guidance	46
REMOTE terminal	47
Specifications	48
Screen size and throw distance for 16:9 aspect ratio	50
Screen size and throw distance for 4:3 aspect ratio	50
Dimensions	51
Trademark acknowledgements	51
Index	52
Avis important concernant la sécurité	54
Précautions de sécurité	56
AVERTISSEMENT	56
MISES EN GARDE	57
Précautions lors du transport	59
Précautions lors de l'installation	59
Précautions lors de l'utilisation	59
Remplacement de l'unité de la lampe	60
Protections du support de montage au plafond	61

Important Information

Preparation

Getting Started

Basic Operation

Settings

Maintenance

Appendix

Precautions with regard to safety

WARNINGS

If you notice smoke, strange smells or noise coming from the projector, disconnect the power plug from the wall outlet.

- Do not continue to use the projector in such cases, otherwise fire or electric shocks could result.
- Check that no more smoke is coming out, and then contact an Authorized Service Center for repairs.
- Do not attempt to repair the projector yourself, as this can be dangerous.

Do not install this projector in a place which is not strong enough to take the full weight of the projector.

- If the installation location is not strong enough, it may fall down or tip over, and severe injury or damage could result.

Installation work (such as ceiling suspension) should only be carried out by a qualified technician.

- If installation is not carried out correctly, there is the danger that injury or electric shocks may occur.
- Do not use other than an authorized ceiling mount bracket.

If foreign objects or water get inside the projector, or if the projector is dropped or the cabinet is broken, disconnect the power plug from the wall outlet.

- Continued use of the projector in this condition may result in fire or electric shocks.
- Contact an Authorized Service Center for repairs.

Do not overload the wall outlet.

- If the power supply is overloaded (for example, by using too many adapters), overheating may occur and fire may result.

Never attempt to modify or disassemble the projector.

- High voltages can cause fire or electric shocks.
- For any inspection, adjustment and repair work, please contact an Authorized Service Center.

Clean the power plug regularly to prevent it from becoming covered in dust.

- If dust builds up on the power plug, the resulting humidity can damage the insulation, which could result in fire. Pull the power plug out from the wall outlet and wipe it with a dry cloth.
- If not using the projector for an extended period of time, pull the power plug out from the wall outlet.

Do not handle the power plug with wet hands.

- Failure to observe this may result in electric shocks.

Insert the power plug securely into the wall outlet.

- If the plug is not inserted correctly, electric shocks or overheating could result.
- Do not use plugs which are damaged or wall outlets which are coming loose from the wall.

Do not place the projector on top of surfaces which are unstable.

- If the projector is placed on top of a surface which is sloped or unstable, it may fall down or tip over, and injury or damage could result.

Do not place the projector into water or let it become wet.

- Failure to observe this may result in fire or electric shocks.

Do not do anything that might damage the power cord or the power plug.

- Do not damage the power cord, make any modifications to it, place it near any hot objects, bend it excessively, twist it, pull it, place heavy objects on top of it or wrap it into a bundle.
- If the power cord is used while damaged, electric shocks, short-circuits or fire may result.
- Ask an Authorized Service Center to carry out any repairs to the power cord that might be necessary.

Do not place the projector on soft materials such as carpets or sponge mats.

- Doing so may cause the projector to overheat, which can cause burns, fire or damage to the projector.

Do not place liquid containers on top of the projector.

- If water spills onto the projector or gets inside it, fire or electric shocks could result.
- If any water gets inside the projector, contact an Authorized Service Center.

Do not insert any foreign objects into the projector.

- Do not insert any metal objects or flammable objects into the projector or drop them onto the projector, as doing so can result in fire or electric shocks.

Do not allow the + and - terminals of the batteries to come into contact with metallic objects such as necklaces or hairpins.

- Failure to observe this may cause the batteries to leak, overheat, explode or catch fire.
- Store the batteries in a plastic bag and keep them away from metallic objects.

Do not touch the leaked liquid from the batteries.

- If you touch the leaked liquid, it may hurt your skin. Immediately wash away the liquid with water and seek medical advice.
- If you get the leaked liquid in your eye, it may cause blindness or damage. Never rub your eye, and immediately wash away the liquid with water and seek medical advice.

During a thunderstorm, do not touch the projector or the cable.

- Electric shocks can result.

Precautions with regard to safety

Do not use the projector in a bath or shower.

- Fire or electric shocks can result.

Do not place your skin into the light beam while the projector is being used.

- Strong light is emitted from the projector's lens. If you place directly into this light, it can hurt or damage your skin.

Do not look into the lens while the projector is being used.

- Strong light is emitted from the projector's lens. If you look directly into this light, it can hurt and damage your eyes.
- Be especially careful not to let young children look into the lens. In addition, turn off the power and disconnect the power plug when you are away from the projector.

Do not place your hands or other objects close to the air outlet port.

- Heated air comes out of the air outlet port. Do not place your hands or face, or objects which cannot withstand heat close to this port [allow at least 50 cm (20") of space], otherwise burns or damage could result.

Replacement of the lamp is recommended to be carried out by a qualified technician.

- The lamp has high internal pressure. If improperly handled, explosion might result.
- The lamp can easily become damaged if struck against hard objects or dropped, and injury or malfunctions may result.

When replacing the lamp, allow it to cool for at least one hour before handling it.

- The lamp cover gets very hot, and touching it can cause burns.

Before replacing the lamp, be sure to disconnect the power plug from the wall outlet.

- Electric shocks or explosions can result if this is not done.

Do not allow infants or pets to touch the remote control unit.

- Keep the remote control unit out of the reach of infants and pets after using it.

CAUTIONS

Do not cover the air inlet port or the air outlet port.

- Doing so may cause the projector to overheat, which can cause fire or damage to the projector.
- Do not place the projector in narrow, badly ventilated places such as closets or bookshelves.
- Do not place the projector on cloth or papers, as these materials could be drawn into the air inlet port.

Do not set up the projector in humid or dusty places or in places where the projector may come into contact with oily smoke or steam.

- Using the projector under such conditions may result in fire, electric shocks or plastic deterioration. The plastic deterioration may cause the falling down of the projector which is mounted in the ceiling.

Do not set up the projector in a high temperature environment, such as near a heater or in direct sunlight.

- Failure to observe this may result in fire, malfunction or plastic deterioration.

Do not set up the projector outdoors.

- The projector is designed for indoor use only.

When disconnecting the power cord, hold the plug, not the cord.

- If the power cord itself is pulled, the cord will become damaged, and fire, short-circuits or serious electric shocks may result.

Always disconnect all cables before moving the projector.

- Moving the projector with cables still attached can damage the cables, which could cause fire or electric shocks to occur.

Do not place any heavy objects on top of the projector.

- Failure to observe this may cause the projector to become unbalanced and fall, which could result in damage or injury.

Do not short-circuit, heat or disassemble the batteries or place them into water or fire.

- Failure to observe this may cause the batteries to overheat, leak, explode or catch fire, and burns or other injury may result.

When inserting the batteries, make sure the polarities (+ and -) are correct.

- If the batteries are inserted incorrectly, they may explode or leak, and fire, injury or contamination of the battery compartment and surrounding area may result.

Use only the specified batteries.

- If incorrect or different kind of batteries are used, they may explode or leak, and fire, injury or contamination of the battery compartment and surrounding area may result.

Precautions with regard to safety

Do not mix old and new batteries.

- If the batteries are inserted incorrectly, they may explode or leak, and fire, injury or contamination of the battery compartment and surrounding area may result.

Remove the used batteries from the remote control promptly.

- If you leave used batteries in the remote control for an extended period of time, it may cause liquid leaking, abnormal internal temperature rising or explosion.

If not using the projector for an extended period of time, disconnect the power plug from the wall outlet and remove the batteries from the remote control.

- If dust builds up on the power plug, the resulting humidity may damage the insulation, which could result in fire.
- Keeping or leaving the remote control with batteries inside may cause insulation deterioration, electrical leakage or explosion which could result in fire.

Do not put your weight on this projector.

- You could fall or the projector could break, and injury may result.
- Be especially careful not to let young children stand or sit on the projector.

We are constantly making efforts to preserve and maintain a clean environment. Please take non repairable units back to your dealer or a recycling company.

Disconnect the power plug from the wall outlet as a safety precaution before carrying out any cleaning.

- Electric shocks can result if this is not done.

If the lamp has broken, ventilate the room immediately. Do not touch or bring your face close to the broken pieces.

- Failure to observe this may cause the user to absorb the gas which was released when the lamp broke and which contains nearly the same amount of mercury as fluorescent lamps, and the broken pieces may cause injury.
- If you believe that you have absorbed the gas or that the gas has got into your eyes or mouth, seek medical advice immediately.
- Ask your dealer about the replacement of the lamp unit and check the inside of the projector.

Ask an Authorized Service Center to clean inside the projector at least once a year.

- If dust is left to build up inside the projector without being cleaned out, it can result in fire or problems with operation.
- It is a good idea to clean the inside of the projector before the season for humid weather arrives. Ask your nearest Authorized Service Center to clean the projector when required. Please discuss with the Authorized Service Center regarding cleaning costs.

Cautions when transporting

Do not subject the projector to excessive vibration or shocks.

- The projector lens need to be handled with care.
- Cover the lens with the lens cover when transporting the projector.

When transporting the projector, hold the body at the bottom securely.

- Do not hold the adjuster legs or the top cover to move the projector, as this may damage the projector.

Cautions when installing

Avoid setting up in places which are subject to vibration or shocks.

- The internal parts can be damaged, which may cause malfunctions or accidents.

Avoid setting up in places which are subject to sudden temperature changes, such as near an air conditioner or lighting equipment.

- The life of the lamp may be shortened or the projector may be turned off. See "TEMP indicator" on page 39.

Do not set up the projector near high-voltage power lines or near motors.

- The projector may be subject to electromagnetic interference.

If installing the projector to the ceiling, ask a qualified technician to carry out all installation work.

- You will need to purchase the separate installation kit (Model No. ET-PKF100H, ET-PKF100S). Furthermore, all installation work is should only be carried out by a qualified technician.
- See "Ceiling mount bracket safeguards" on page 42 for the **Safety cable** installation.

If using this projector at high elevations (above 1 400 m), set the HIGHLAND to ON. See "HIGHLAND" on page 36.

- Failure to observe this may result in malfunctions or the life of the lamp or the other components may be shortened.

Cautions on use

In order to get the best picture quality

- Draw curtains or blinds over any windows and turn off any lights near the screen to prevent outside light or light from indoor lamps from shining onto the screen.

Do not touch the surfaces of the lens or the front glass with your bare hands.

- If the surface of the lens becomes dirty from fingerprints or anything else, this will be magnified and projected onto the screen. Moreover, when not using the projector, close the **Front panel cover**.

Liquid crystal panel

- Do not project the same image for long periods of time, as this may remain as an afterimage on the liquid crystal panel.
- The liquid crystal panel of the projector is built with very high precision technology to provide fine picture details. Occasionally, a few stuck pixels may appear on the screen as fixed points of blue, green or red. It is recommended to switch off the projector once and try after 1 hour later again. Please note that this does not affect the performance of your LCD.

The projector has a high pressure mercury lamp and that is characterized as follows.

- The brightness of the lamp depends on the duration of use.
- The lamp may explode or shorten the lamp life by shocks or chipping damage.
- The lamp may explode only occasionally after using the projector.
- The lamp may explode if using the projector after the instructed lamp replacement timing.
- The lamp life is depends on individual lamp characteristics, usage condition and the installation environment. Especially the consecutive use of the projector for more than 10 hours, or the frequent switching on or off may greatly affect on the lamp life.

Screen

- Do not apply any volatile substances which may cause discoloration to the screen, and do not let it become dirty or damaged.

Optical components

- If you use the projector consecutively 6 hours every day, the optical components may need to be replaced in less than 1 year.

Accessories

Make sure the following accessories are provided with your projector.

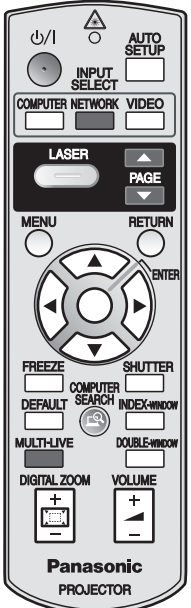
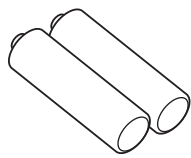
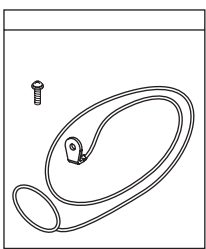
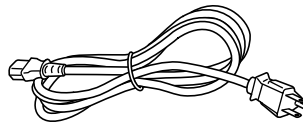
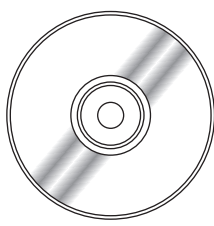
<p>Remote control for PT-FW100NTU (x1) N2QAYB000158</p> 	<p>AA batteries for Remote control (x2)</p> 	<p>Safety cable TTRA0141 Attachment screw (x1) Safety cable (x1)</p> 
	<p>Power cord (x1) K2CM3DH00015</p> 	<p>CD-ROM (x1) TQBH9009</p> 

Read this first

Minimum required setting screen

When you start the projection for the first time, the minimum required setting screen for projection will be displayed.

LANGUAGE

Select the required language setting.

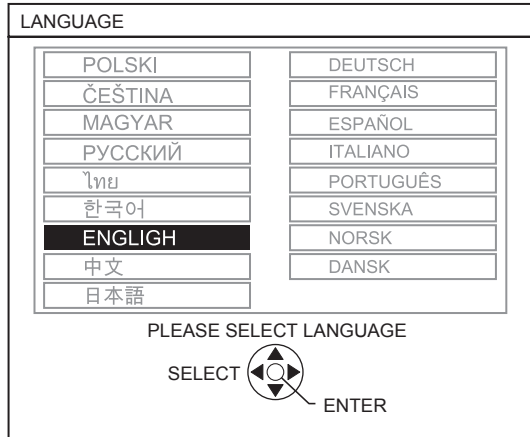

Press ▲ ▼ ◀ ▶ buttons of the **Remote control** or **Control panel** on the projector to highlight the required language, and press **ENTER** to proceed to the next setting.

OPTION

Select the current projection method, screen size and fan speed setting. If you need return to the previous setting, press the **RETURN** button.

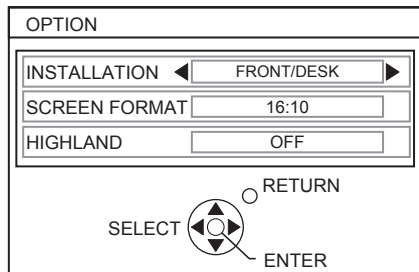

Press the ENTER button to start the projection.

- Once you finish the minimum requirement setting, it will not be displayed again unless the projector is initialized. See "INITIALIZE ALL" on page 36.
- You can change the settings from the **MAIN MENU**. See "Menu Navigation" on page 27.

INSTALLATION

Press ◀ ▶ buttons of the **Remote control** or **Control panel** on the projector to select the required installation method. Press ▼ to proceed to the **HIGHLAND** setting.

FRONT/DESK	Setting on a desk/floor and projecting from front
FRONT/CEILING	Mounting in the ceiling and projecting from front
REAR/DESK	Setting on a desk/floor and projecting from rear
REAR/CEILING	Mounting in the ceiling and projecting from rear

SCREEN FORMAT

Select the required screen format by pressing ◀ ▶.

- **16:10** When project on a 16:10 or 4:3 screen.
- **16:9** When project on a 16:9 screen.

HIGHLAND

If you use the projector at high elevation, the **HIGHLAND** setting need to be **ON** to set the fan speed high. Press ◀ ▶ to select the required option. If you need to return to the **INSTALLATION**, press ▲.

- **OFF** The fan speed is low.
- **ON** The fan speed is high.

NOTE:

- At 1 400 m (4 593 ft) above sea level, the setting must be **ON**.
- The loudness of fan noise depends on the **HIGHLAND** setting.

About Your Projector

Remote control

POWER button
While the **MAIN POWER** is on, switch between stand-by mode and projection mode. (page 20)

Project a laser pointer. (page 24)

Display the **MAIN MENU**. (page 27)

Navigate through the menus with **▲▼◀▶**, and activate the menu item with **ENTER**. (page 27)

Capture the projected image as a frozen picture. (page 25)

Reset some of the settings to the factory default settings. (page 25)

● See **CD-ROM** contents.

Control to change the scale by means of digital zoom. (page 26)

COMPUTER SEARCH ● See **CD-ROM** contents.

AUTO SETUP Automatically adjust the setting of **DOT CLOCK**, **CLOCK PHASE** and **SIGNAL SEARCH** for the projected image of **COMPUTER** signal. (page 23)

COMPUTER **INPUT SELECT** buttons
Switch the required input signal button to select.
● See **CD-ROM** contents.

NETWORK
VIDEO

● See **CD-ROM** contents.

PAGE

RETURN Return to the previous menu. (page 27)

SHUTTER Turn off the projection temporarily. (page 25)

INDEX-WINDOW Display the frozen image while the display of subsequent images continues. (page 25)

DOUBLE-WINDOW Display 2 different source images at a time. (page 25)

VOLUME Control to adjust the volume of the speakers. (page 26)

Battery compartment

1. Press the tab and lift up the cover.
2. Insert the batteries according to the polarity diagram indicated inside.

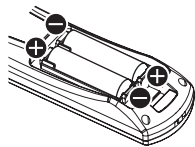
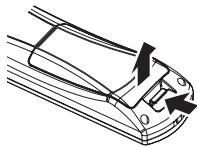

Top view

Remote control signal and Laser pointer beam emitters. (page 23)

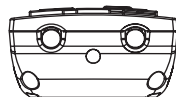

Attaching a hand strap

You can attach a favorite strap on to the **Remote control**.

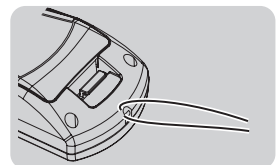

Remote control indicator

If you press any button except the **LASER** button, the **Remote control indicator** will flash. If you press the **LASER** button, it will lit.

Remote control indicator

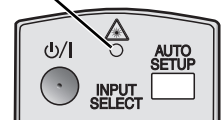

NOTE:

- Do not drop the **Remote control**.
- Avoid contact with liquids or moisture.
- Use manganese batteries or alkaline batteries with the **Remote control**.
- Do not attempt to modify or disassemble the **Remote control**. Contact an Authorized Service Center for repairs.
- Do not keep pressing the **Remote control** buttons as this may shorten battery life.
- Do not point the laser in other people's eyes or stare into beam.
- See "Remote control operation" on page 23.

Projector body

Top and front view

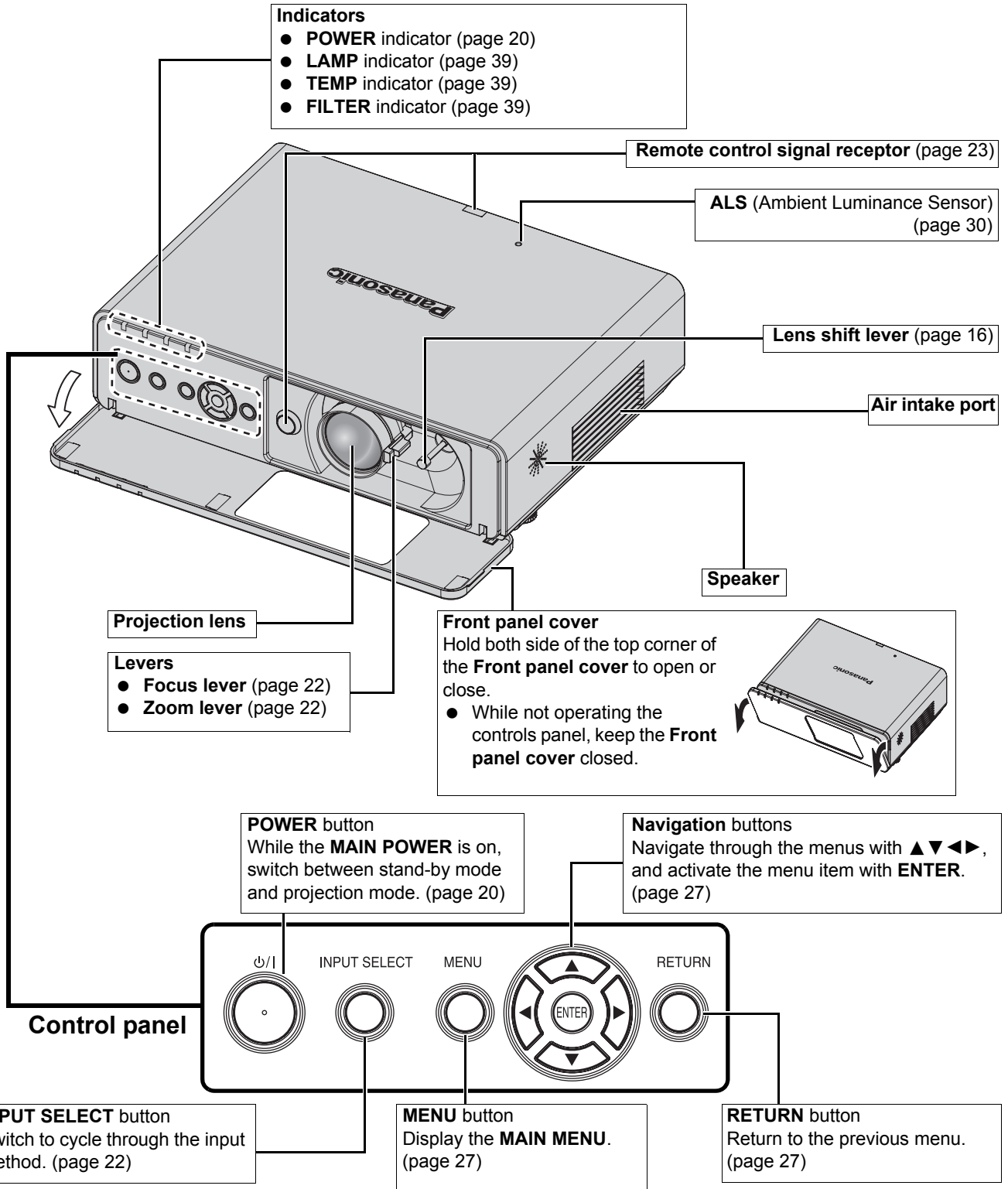

NOTE:

- Do not cover the ventilation openings or place anything within 50 cm (20") of them as this may cause damage or injury.
- While the projector is not in use, keep the **FRONT PANEL COVER** closed to protect the lens.

Back and bottom view

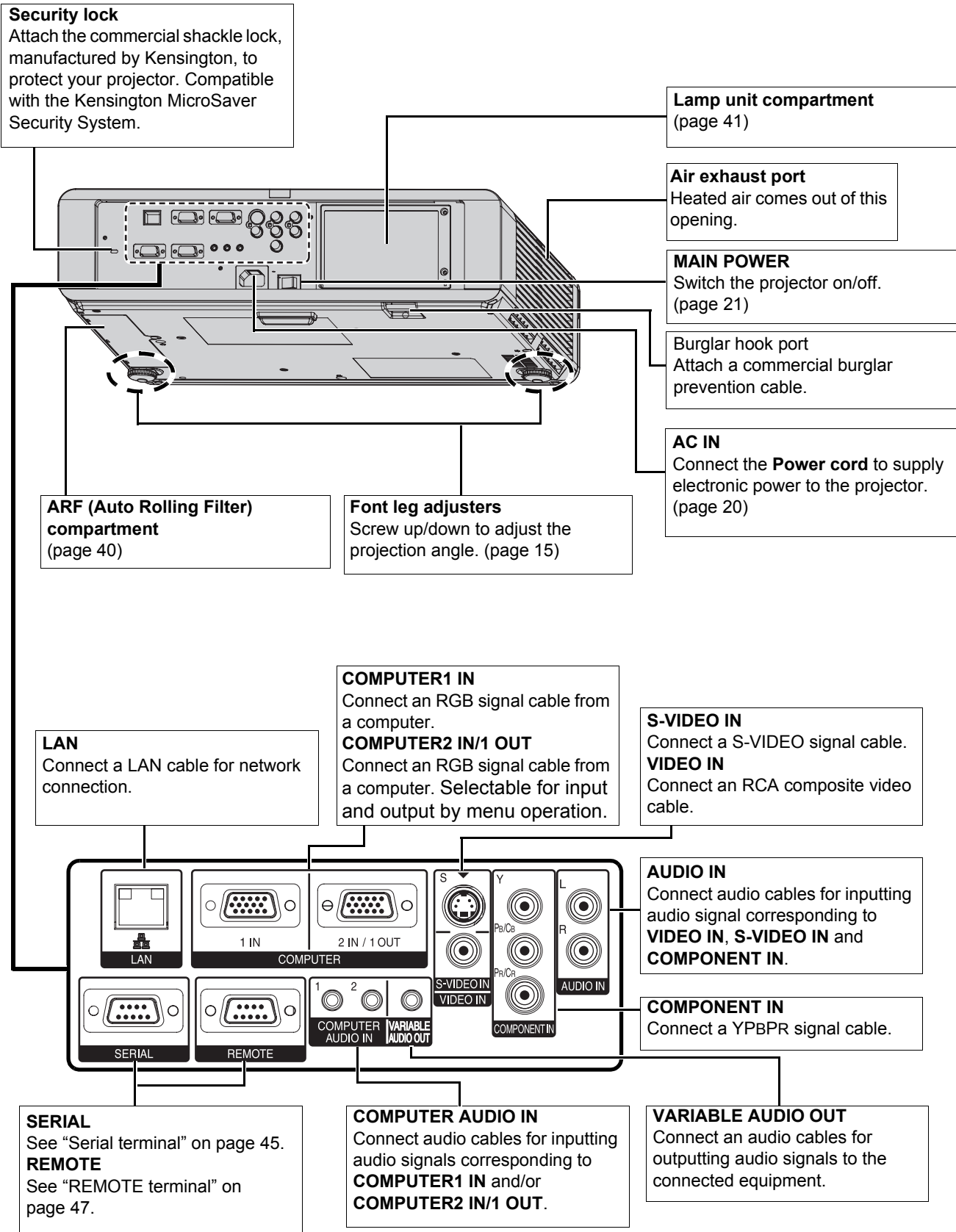

NOTE:

- Do not cover the ventilation openings or place anything within 50 cm (20") of them as this may cause damage or injury.
- When a cable is connected to the **VARIABLE AUDIO OUT**, the built-in speaker will be disabled.

Setting up

Screen size and throw distance

You can adjust the projection size with 2.0x zoom lens. Calculate and define the throw distance as follows.

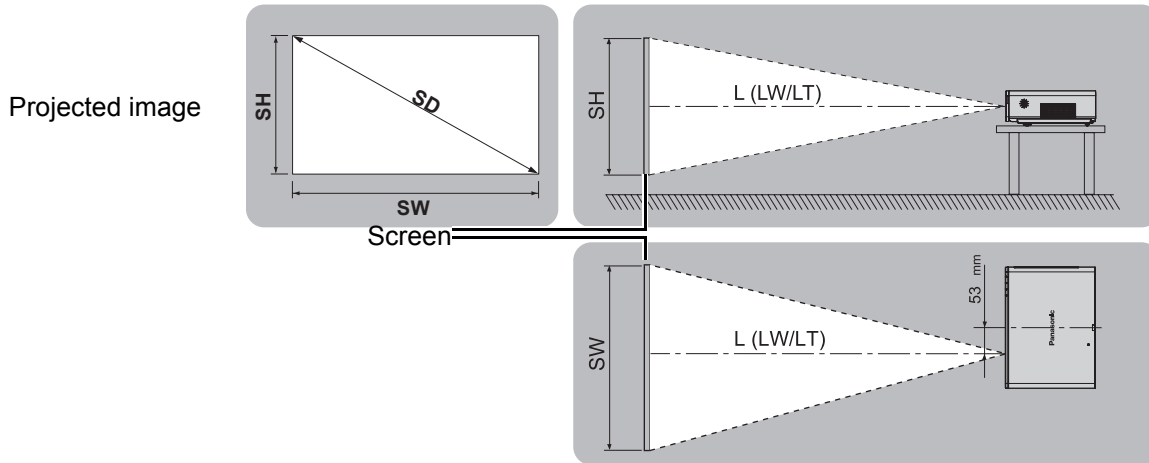

Getting Started

Projection size (16 : 10)			Throw distance (L)	
Screen Diagonal (SD)	Screen height (SH)	Screen width (SW)	Minimum distance (LW)	Maximum distance (LT)
(0.84 m) 33"	0.44 m (1'5")	0.71 m (2'3")		1.8 m (5'10")
(1.02 m) 40"	0.54 m (1'9")	0.86 m (2'9")	1.1 m (3'7")	2.3 m (7'6")
(1.27 m) 50"	0.67 m (2'2")	1.08 m (3'6")	1.4 m (4'7")	2.8 m (9'2")
(1.52 m) 60"	0.81 m (2'7")	1.29 m (4'2")	1.7 m (5'6")	3.4 m (11'1")
(1.78 m) 70"	0.94 m (3'1")	1.51 m (4'11")	2.0 m (6'6")	4.0 m (13'1")
(2.03 m) 80"	1.08 m (3'6")	1.72 m (5'7")	2.3 m (7'6")	4.6 m (15'1")
(2.29 m) 90"	1.21 m (3'11")	1.94 m (6'4")	2.6 m (8'6")	5.1 m (16'8")
(2.54 m) 100"	1.35 m (4'5")	2.15 m (7')	2.9 m (9'6")	5.7 m (18'8")
(3.05 m) 120"	1.62 m (5'3")	2.58 m (8'5")	3.4 m (11'1")	6.9 m (22'7")
(3.81 m) 150"	2.02 m (6'7")	3.23 m (10'7")	4.3 m (14'1")	8.6 m (28'2")
(5.08 m) 200"	2.69 m (8'9")	4.31 m (14'1")	5.7 m (18'8")	11.5 m (37'8")
(6.35 m) 250"	3.37 m (11')	5.38 m (17'7")	7.2 m (23'7")	14.3 m (46'10")
(7.62 m) 300"	4.04 m (13'3")	6.46 m (21'2")	8.6 m (28'2")	17.2 m (56'5")

* All measurements above are approximate and may differ slightly from the actual measurements.

Calculation methods for screen dimensions

You can calculate more detailed screen dimension from the screen diagonal.

$$SW (m) = SD (") \times 0.0215$$

$$SH (m) = SD (") \times 0.0135$$

$$LW (m) = 0.0289 \times SD (") - 0.046$$

$$LT (m) = 0.0576 \times SD (") - 0.061$$

* The results above are approximate and may differ slightly from the actual measurements.

NOTE:

- See page 50 for the screen size and throw distance of 4:3/16:9.
- Do not use the projector at a raised or a horizontally tilted position as it may cause malfunction of the projector.
- Make sure the projector lens surface is parallel with the screen. You can tilt the projector body approximately $\pm 30^\circ$ vertically. Overtilting may result in shortening the component's life.
- For the best quality of the projection image, install a screen where sun light or room light does not shine directly onto the screen. Close window shades or curtains to block the lights.

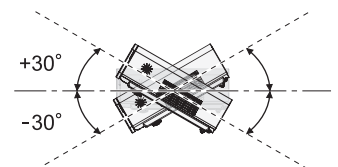

Projection method

You can use the projector with any of the following 4 projection methods. To set the desired method in the projector, See "INSTALLATION" on page 35.

■ Setting on a desk/floor and projecting from front

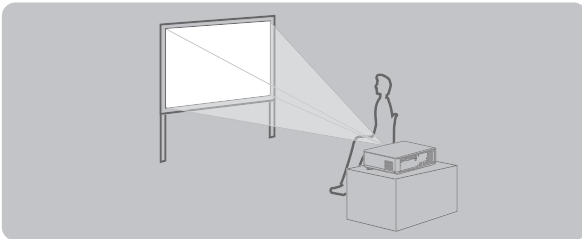

INSTALLATION: FRONT/DESK

■ Setting on a desk/floor and projecting from rear

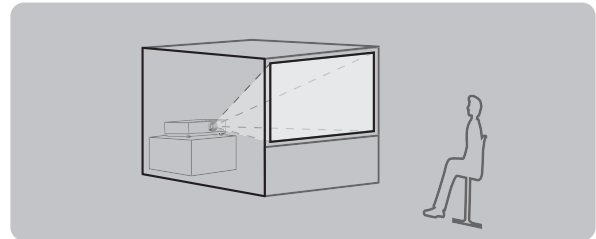

INSTALLATION: REAR/DESK

■ Mounting in the ceiling and projecting from front

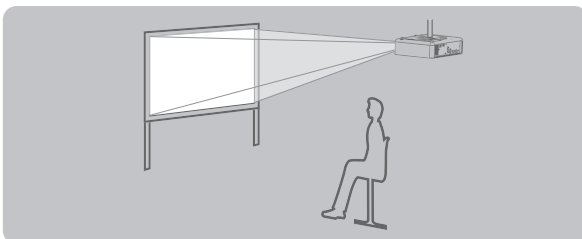

INSTALLATION: FRONT/CEILING

■ Mounting in the ceiling and projecting from rear

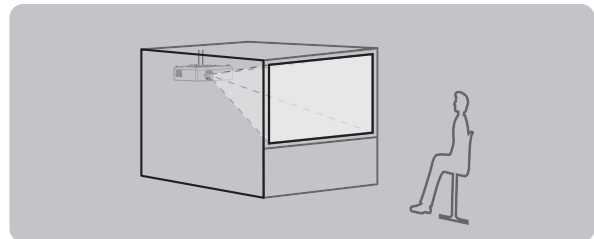

INSTALLATION: REAR/CEILING

NOTE:

- A translucent screen is required for rear projection.
- When mounting the projector in the ceiling, the optional ceiling mount bracket (ET-PKF100H, ET-PKF100S) is required.
- See "Ceiling mount bracket safeguards" on page 42.

Front leg adjusters and throwing angle

You can screw up/down the front leg adjusters to control the angle of the projector for adjusting the throwing angle. See "Positioning the image" on page 22.

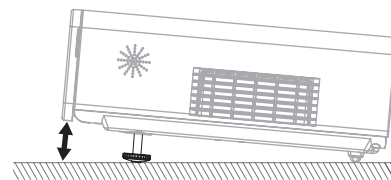
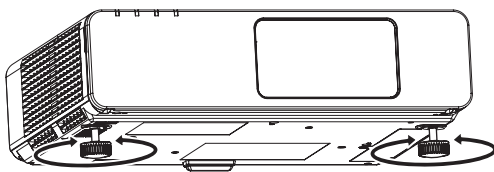

NOTE:

- Heated air comes out of the **Air exhaust port**. Do not touch the **Air exhaust port** directly.
- If keystone distortion occurs, see "KEYSTONE" on page 32.
- Screw up the adjuster legs, and an audible click will be heard as the limit.

Lens shift and positioning

If the projector is not positioned right in front of the center of the screen, you can adjust the projected image position by moving the **Lens shift lever** within the shift range of the lens.

Adjusting the Lens shift lever

1. Open the **Front panel cover**.
2. Screw the **Lens shift lever** counterclockwise to unlock.
3. Move the **Lens shift lever** to adjust the projected image position.
4. Screw the **Lens shift lever** clockwise to lock.

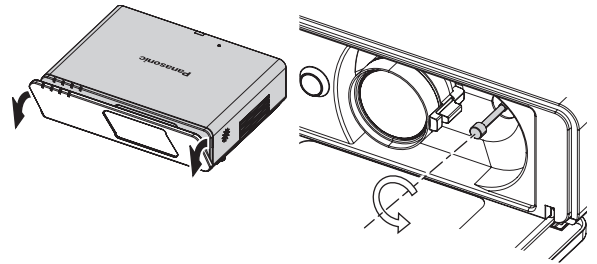

Horizontal shift

You can place the projector where the projector lens is up to 24% horizontally off-center from the screen and then adjust the image position with the **Lens shift lever**.

Up to about 24 % of the projection

Up to about 24 % of the projection

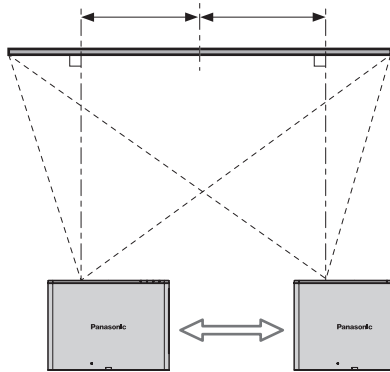

Shifting the lever right:
Moving to screen's right.

Shifting the lever left:
Moving to screen's left.

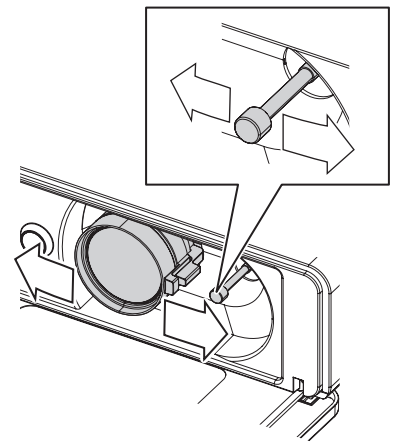

Vertical shift

You can place the projector where the projector lens is up to 57% vertically off-center from the screen and then adjust the image position with the **Lens shift lever**.

Up to about 57 % of the projection

Up to about 57 % of the projection

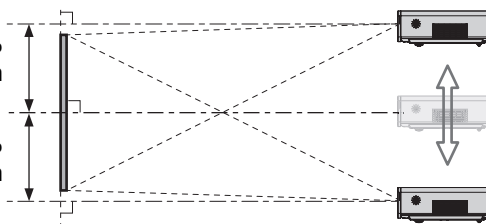

Shifting the lever down:
Moving to screen's bottom.

Shifting the lever up:
Moving to screen's top.

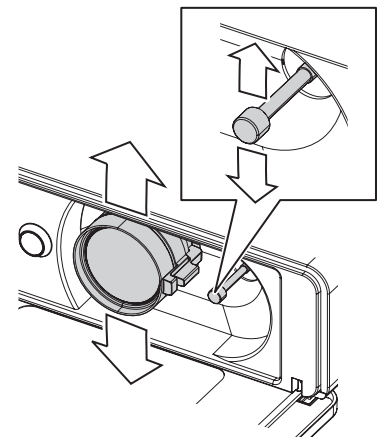

Projector location range

You can determine where to locate the screen and the projector by considering the lens shift possibilities. See "Positioning the image" on page 22.

When the screen position is fixed

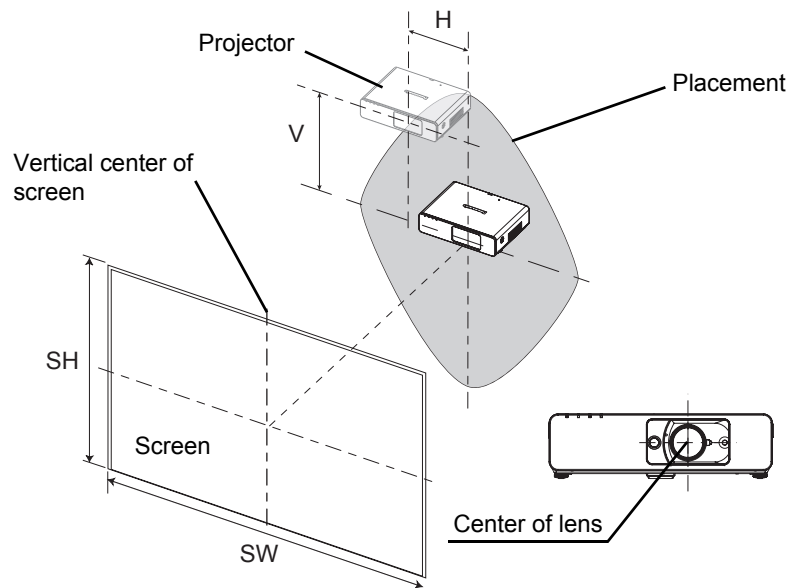

When the projector position is fixed

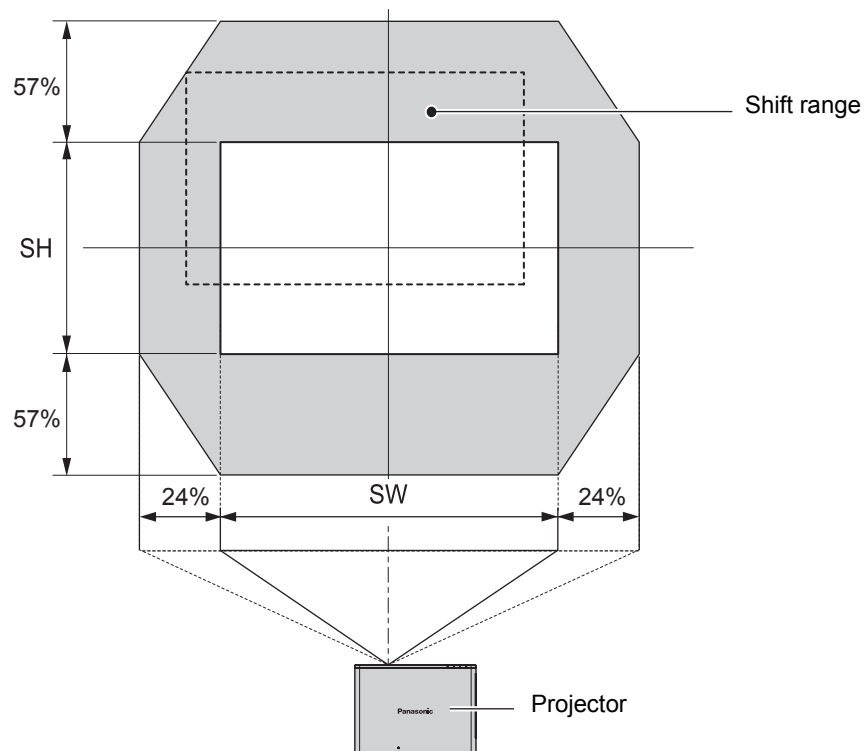

NOTE:

- When the projector is located right in front of the screen and the **Lens shift lever** is centred, you will get the best quality of the projection image.
- When the **Lens shift lever** is at the vertical limit of the shift range, you cannot move the lever to the horizontal limit, likewise when the **Lens shift lever** is at the horizontal limit of the shift range, you cannot move the lever to the horizontal limit.
- When the projector is tilted and you adjust **KEYSTONE**, the center of the screen and the lens need to be realigned.
- Do not attempt to pull the **Lens shift lever** hard while adjusting.

Connections

Before connection to the projector

- Read and follow the operating and connecting instructions of each peripheral device.
- The peripheral devices must be turned off.
- Use cables that match each peripheral device to be connected.
- If the input signal is affected by signal jitter, the projected image may have poor image quality and timebase correction is effective.
- Confirm the type of video signals. See “List of compatible signals” on page 44.

Connecting with computers

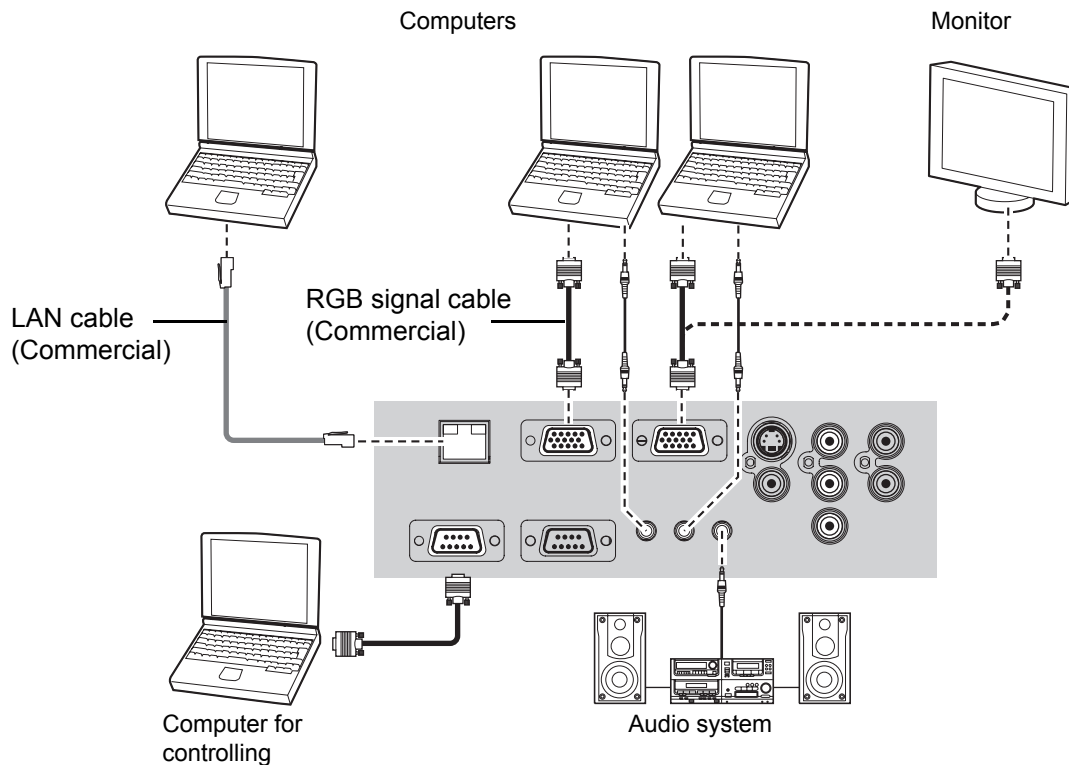

NOTE:

- When **COMPUTER2 SELECT** in the **OPTION** menu is set to **OUTPUT**, do not connect any input signals.
- See **CD-ROM** contents for the LAN network connection.

LAN terminal

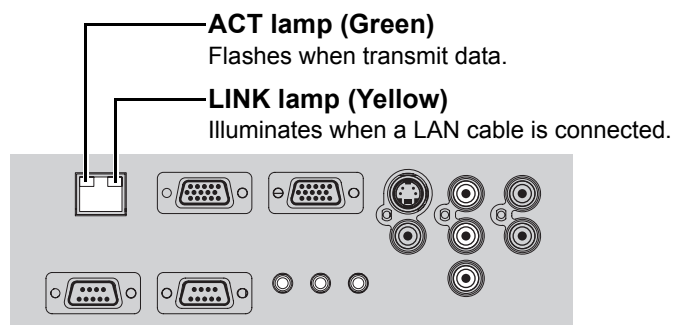

NOTE:

- Do not touch the metal parts of the **LAN** terminal. Failure to observe this may cause malfunction by static electricity.

Connecting with AV equipment

Connecting with VIDEO IN/S-VIDEO IN

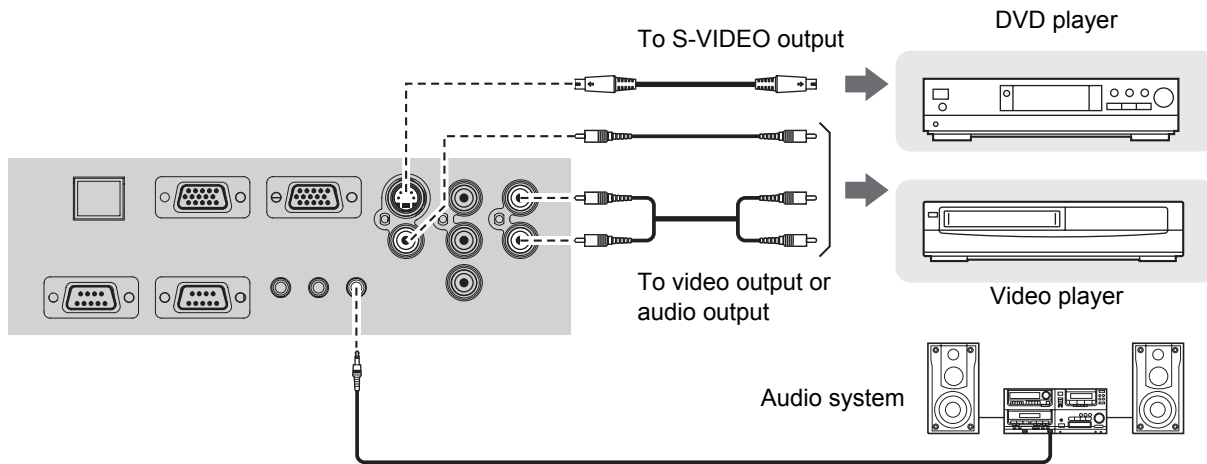

NOTE:

- When you connect more than one AV equipment, switch the audio connection manually.

Connecting with COMPONENT IN

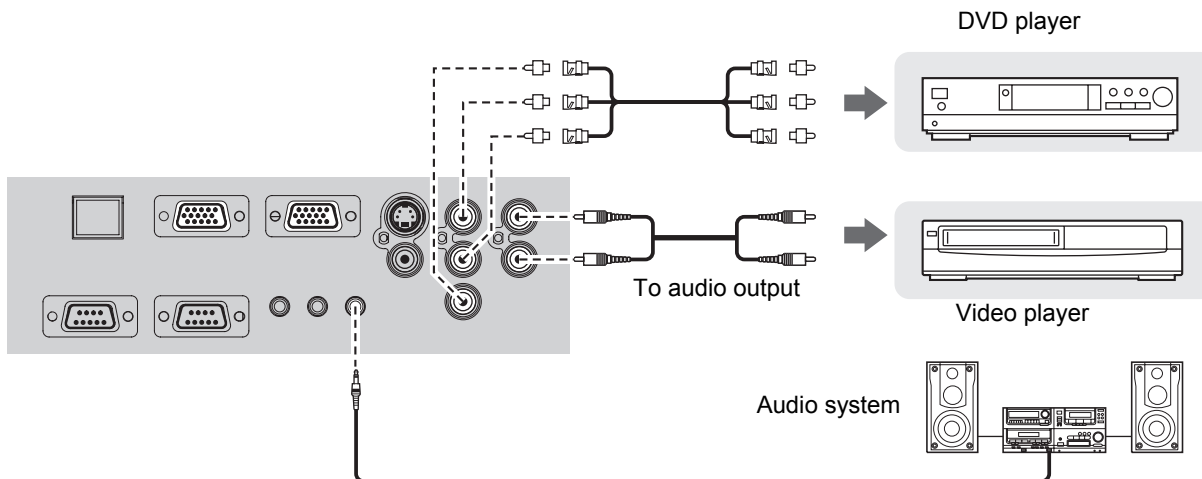

NOTE:

- If you connect the BNC cables, use with a commercial BNC-RCA adaptor.

Switching the projector on/off

Power cord

Connecting

1. Make sure the shape of the power plug and the **AC IN** connector on the back of the projector match, then push the plug all the way in.
2. Connect the **Power cord** to a wall outlet.

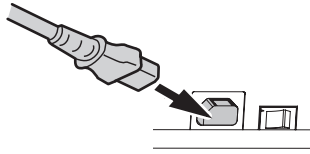

Disconnecting

1. Make sure the **MAIN POWER** is switched off and unplug the **Power cord** from the wall outlet.
2. Hold the plug and unplug the **Power cord** from the **AC IN** connector on the back of the projector.

Direct power off function

You can disconnect the **Power cord** from the projector or switch off the **MAIN POWER** button while projecting or soon after projecting. The internal lamp cooling fan will keep operating by the internal power supply.

NOTE:

- If the projector is switched on again while the internal cooling fan is still operating by the internal power supply, it may take a while to start the projection.

Direct power on function

If you activate the **DIRECT POWER ON**, you can start the projection only with connecting the **Power cord** or switching on the **MAIN POWER**. See "DIRECT POWER ON" on page 35.

NOTE:

- Do not use other than a provided **Power cord**.
- Ensure all the input devices are connected and turned off before connecting the **Power cord**.
- Do not force the connector as this may damage the projector and/or the power cord.
- Dirt or dust build-up around plugs may cause fire or electrical hazards.
- Switch off the power to the projector when not in use.

POWER indicator

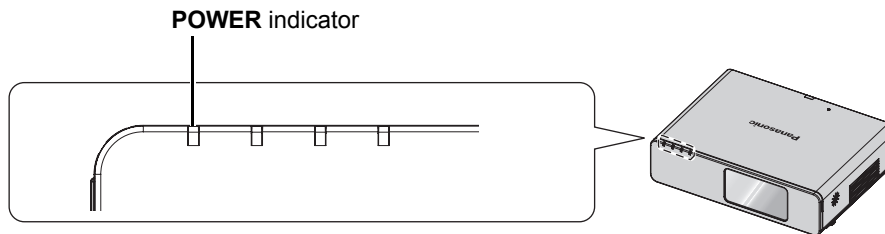

Indicator status		Status
No illumination or flashing		The MAIN POWER is switched off.
RED	Lit	The MAIN POWER is switched on and the projector is in standby. When the LAMP or TEMP indicator is flashing, the POWER indicator will not be lit.
	Flashing	Network connection is ready while the POWER is turned off.
GREEN	Flashing	The POWER is switched on and the projector is getting ready to project.
	Lit	The projector is ready to project.
ORANGE	Lit	The POWER is switched off and the projector is cooling the lamp.
	Flashing	The POWER is switched on again when cooling the lamp and recovering to projection mode. Recovery may take a while.

NOTE:

- If the projector is switched on again while the internal cooling fan is still operating by the internal power supply, it may take a while to start the projection.
- The electric consumption in standby mode is 4 W.

Switching on the projector

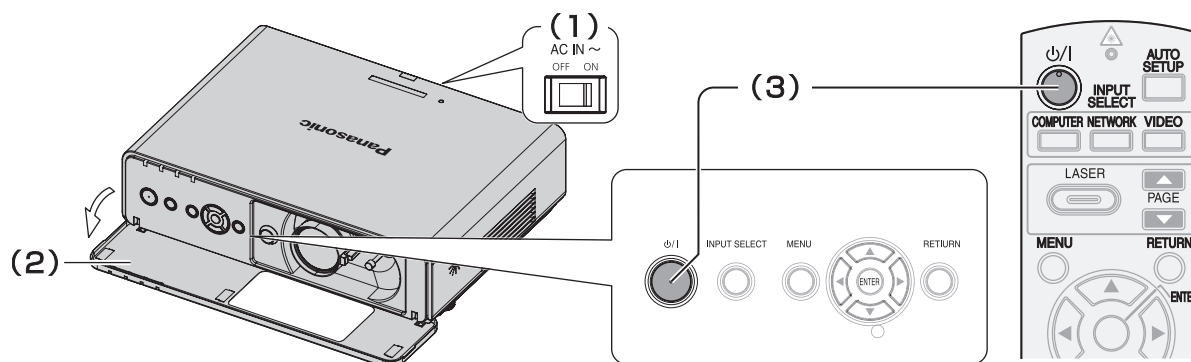

1. Switch the **MAIN POWER** on.
 - The power indicator lights up in **RED**.
2. Open the **Front panel cover**.
 - This is not necessary in **Remote control** operation.
3. Press the **POWER** button.
 - The power indicator lights up in **GREEN** after flashing for a while.
 - The **STARTUP LOGO** is displayed on the screen. See "STARTUP LOGO" on page 34.

NOTE:

- When starting up the projector some small rattling or tinkling sound may be heard, or the display may flicker for the characteristics of the lamp. Those are normal and do not affect the performance of the projector.
- If you disconnected the **Power cord** or switched off the **MAIN POWER** while on projecting mode, the projection will start with connecting the **Power cord** or switching on the **MAIN POWER**. See "DIRECT POWER ON" on page 35.

Switching off the projector

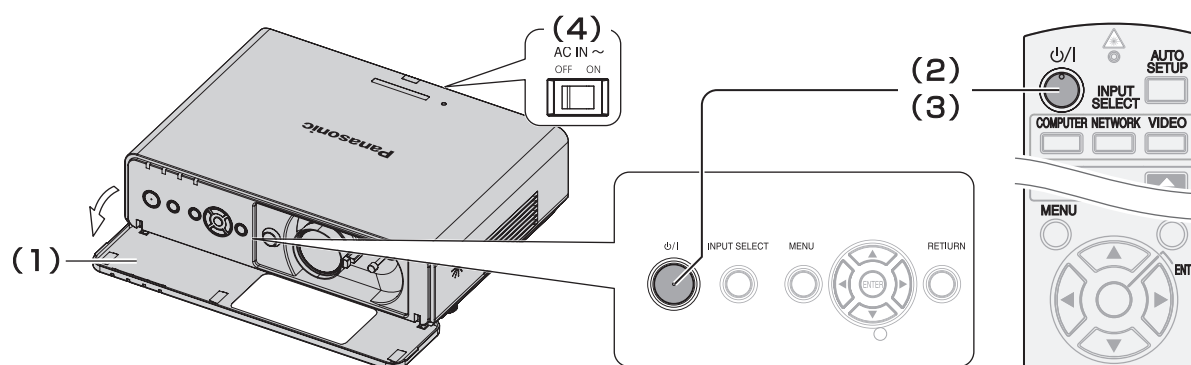

1. Open the **Front panel cover**.
 - This is not necessary in **Remote control** operation.
2. Press the **POWER** button.
 - The confirmation screen is displayed. It will disappear and return to the projection after 10 seconds without any operation.
 - To return to the projection, press any button except the **POWER** button.
3. Press the **POWER** button.
 - The power indicator lights up in **ORANGE** while cooling the lamp, then illuminates **RED** when is ready to switch off the **MAIN POWER**.
4. Switch off the **MAIN POWER** on the back of the projector.

NOTE:

- Press the **POWER** twice or for a long duration to switch the power off.
- You can disconnect the **Power cord** or switch off the **MAIN POWER** instead of following this procedure. See "DIRECT POWER ON" on page 35.
- You can turn off the projector by pressing the **POWER** button longer than 0.5 seconds.

Projecting an image

Selecting the input signal

1. Switch on the connected devices.
 - Press the play button of the required device.
2. Press the **INPUT SELECT** buttons to select the required input method if needed. See “Switching the input signal” on page 24.
 - The image will be projected on the screen.

NOTE:

- **SIGNAL SEARCH** is **ON** as default and the signal from the connected devices is detected automatically. See “SIGNAL SEARCH” on page 35.

Positioning the image

1. Open the **Front panel cover**.
2. Adjust the projected image with the **Lens shift lever**. See “Lens shift and positioning” on page 16.

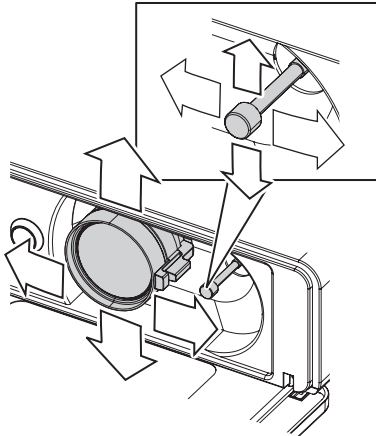

3. Adjust the angle of the projector.
 - Screw down the **Front leg adjusters** and adjust the angle vertically.
 - See “Front leg adjusters and throwing angle” on page 15.

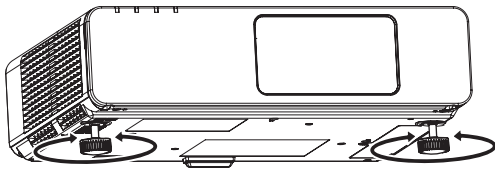

4. Adjust the focus and the projected image size.
 - Turn the **Focus lever** and **Zoom lever** to adjust the image.
 - You can confirm the adjusted effect with the **TEST PATTERN** in **OPTION** menu. See “TEST PATTERN” on page 36.

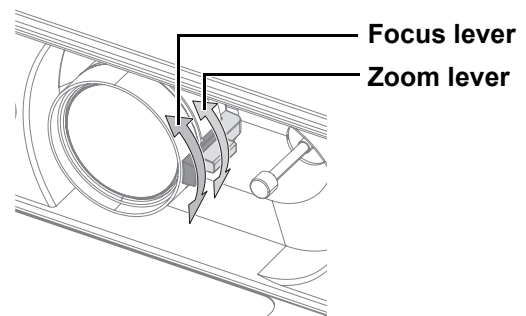

NOTE:

- Do not touch the **Air Exhaust port** as this may cause burns or injury.
- If keystone distortion occurs, see “KEYSTONE” on page 32.
- If you adjust the focus, you may need to adjust the size of the image by moving the **Zoom lever** again.

Remote control operation

Operating range

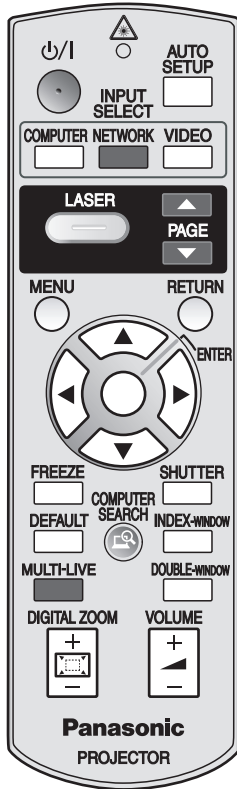

You can operate the projector with the **Remote control** within the remote range 15 m (49'2").

● Facing to the projector

Ensure the **Remote control emitter** is facing to the **Remote control signal receptor** on front/back of the projector and press the required buttons to operate.

● Facing to the screen

Ensure the **Remote control emitter** is facing to the screen and press the required buttons to operate the projector. The signal will be reflected off the screen. The operating range may differ due to the screen material. This function may not be effective with a translucent screen.

NOTE:

- Do not let strong light shine onto the signal receptor. The **Remote control** may malfunction under strong light such as fluorescent.
- If there are any obstacles between the **Remote control** and the **Remote control signal receptor**, the **Remote control** may not operate correctly.

Setting up the image position automatically



You can adjust the setting of **POSITION**, **DOT CLOCK** and **CLOCK PHASE** in the **POSITION** menu automatically for the projected **COMPUTER** signal image.

NOTE:

- If the dot clock frequency is 108 MHz or higher, **AUTO SETUP** is not effective.
- If the projected image is dark or blurred around the edge, **AUTO SETUP** may stop the processing before complete. Project a much clearer or lighter image and press the **AUTO SETUP** button again.

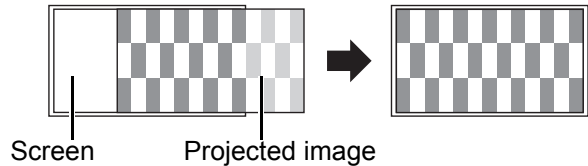

Remote control operation

Switching the input signal



You can switch the input method manually by pressing the **COMPUTER**, **NETWORK** and **VIDEO** buttons. Press the required button several times or ◀ ▶ to cycle through the input methods as follows. The actual projected image will be changed in a while.

- The graphical guidance will be displayed on the upper right of the projected image and you can confirm the selected input method which is highlighted in yellow. See "INPUT GUIDE" on page 34.

Pressing the COMPUTER button



NOTE:

- Only when the **COMPUTER2 SELECT** is set to **INPUT**, you can switch between **COMPUTER1** and **COMPUTER2**.

NOTE:

- If you select an unplugged input method, the guidance will blink on and off several times.
- See "List of compatible signals" on page 44.
- See "Connections" on page 18.

Pressing the NETWORK button

- See CD-ROM contents for more detailed information.

Pressing the VIDEO button

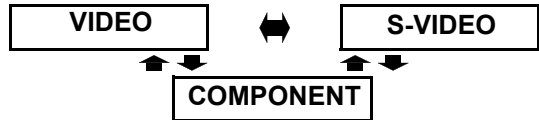

Pressing the INPUT SELECT button on the projector

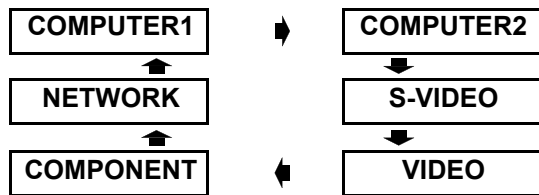

Using the laser pointer



You can highlight items on the screen with the red laser pointer while projecting the image in presentations or visual demonstrations as an eye-catching pointing device.

Hold down the **LASER** button to go on the laser pointer and release to go off.

NOTE:

- The laser pointer should never be projected directly into the eyes of a person or animal.
- Do not aim the laser at reflective surfaces.
- Do not allow children to use laser pointer.
- Never look directly into the laser beam.
- The laser pointer is not effective with translucent screens.
- Please read the cautions on the **Remote control**.
- This is a Class 2 laser product.

Deactivating the LASER button

You can deactivate the **LASER** button for an accidental operation.

- Open the battery compartment cover of the **Remote control**.
- Slide the switch tab.
- Close the battery compartment cover of the **Remote control**.
 - See "Battery compartment" on page 11.

Top view

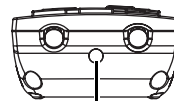

Laser pointer beam emitter

Deactivating switch

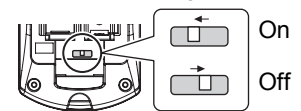

Cautions

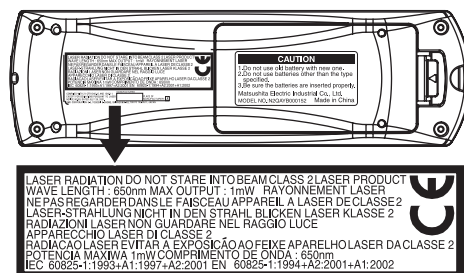

COMPLIES WITH 21 CFR1040.10 AND 1040.11 EXCEPT FOR DEVIATIONS PERMISSIBLE TO LASER
 NOTE: MODEL DATED JULY 26, 2001. MANUFACTURED IN CHINA PLACE OF MANUFACTURE: [A]
 SANKI CORPORATION 9-6, 1-10-2008H 6-CHOME, SHANGHAI WANGKUN, TOKYO TESBIT, JAPAN



CAUTION: Use of controls of adjustments or performance of procedures other than those specified herein may result in hazardous radiation exposure.

Capturing an image

FREEZE

When projecting an image, press **FREEZE** to capture the projected image and display it on the screen as a still picture. While the image is frozen, the sound will be stopped.

Press the **FREEZE** button to return to the projection.

Stopping the projection temporary

SHUTTER

You can turn off the lamp and stop the projection temporary for electrical power save.

Press the **SHUTTER** button to return to the projection.

Resetting to the factory default settings

DEFAULT

You can reset most of the customized settings to the factory defaults by pressing the **DEFAULT** button of the **Remote control**. Display the required sub menu or the menu items, and press the **DEFAULT** button again.
 ● See "Main menu and Sub-menu" on page 28.

NOTE:

- Some menu items are not available to reset by pressing the **DEFAULT** button. Adjust each menu items manually.
- To reset all the settings to the factory defaults, see "INITIALIZE ALL" on page 36.

Projecting an image in INDEX-WINDOW mode

INDEX-WINDOW

You can project an image in split 2 windows as an **INDEX-WINDOW**, one is frozen, stored in memory and displayed on the screen's left side, while the display of subsequent images continues on the right.
 To escape from the **INDEX-WINDOW**, press the **MENU** or **RETURN** button.

● **Changing the image size**

Press **▲ ▼** to switch and cycle through in 3 size.

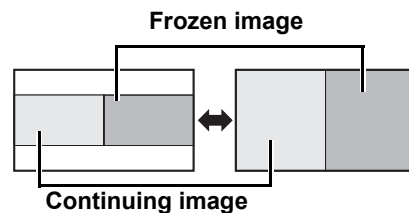

NOTE:

- If you change the window size, the aspect ratio of the image is changed and becomes vertically elongated.

● **Switching the position**

In default, the frozen image is displayed on the left and the subsequent image is displayed on the right. Press **◀ ▶** to switch the position.

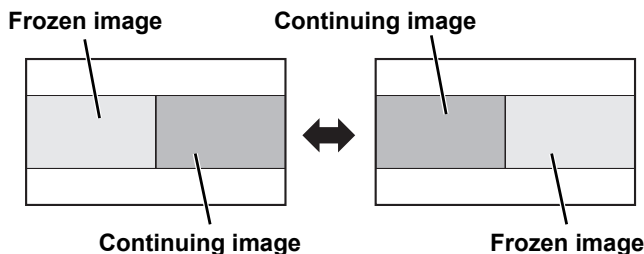

● **Capturing a new image**

While in **INDEX-WINDOW** mode, press **ENTER** to capture a new image and the frozen image window will be updated in a while.

Remote control operation

Projecting 2 images at a time

DOUBLE-WINDOW



You can project the image and another source of image at the same time in double window style. Press any button of **RETURN**, **MENU**, **DOUBLE-WINDOW** or **INPUT SELECT** buttons to return to the normal projection style.

NOTE:

- **FREEZE** and **VOLUME** controls are available with the first image only.
- While **DOUBLE-WINDOW** is activated, **DIGITAL ZOOM**, **INDEX-WINDOW** and **AUTO SETUP** are not available.
- While **DOUBLE-WINDOW** is activated, the main menu will not be displayed.
- The second image will apply to the value of the **PICTURE** settings of the first image except **CONTRAST** and **BRIGHTNESS**.
- **COMPUTER** and **NETWORK** signals will not keep the adjusted aspect ratio.

Unavailable combinations

The following combinations are not available.

- **COMPUTER1 - COMPONENT**
- **COMPUTER2 - NETWORK**
- **S-VIDEO - VIDEO**
- **S-VIDEO - COMPONENT**
- **VIDEO - COMPONENT**

Switching the signal

In default, the first image is displayed on the left and the second image is displayed on the right. You can switch and cycle through the signals of the second image by pressing **▲ ▼**

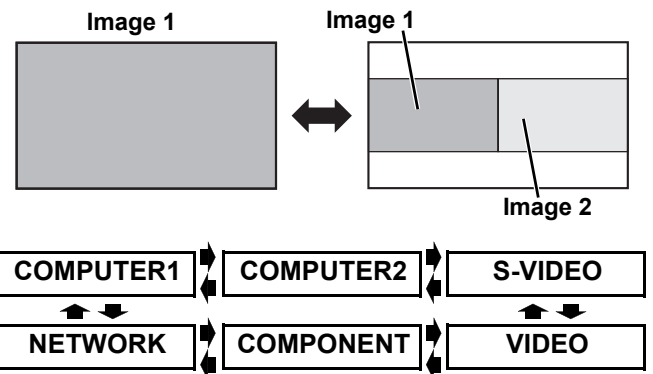

Enlarging the centred area

DIGITAL ZOOM



You can enlarge the projected image down to a centred area for emphasizing within the range of 1x to 2x.

NOTE:

- When the **COMPUTER** signal is projected, the enlargement range will be changed to 1x to 3x. When the **FRAME LOCK** in **POSITION** menu is set to **ON**, the enlargement range is 1x to 2x. See "FRAME LOCK" on page 33.
- When the input signal is changed while the **DIGITAL ZOOM** is activated, the **DIGITAL ZOOM** will be cancelled.
- While **DIGITAL ZOOM** is activated, **FREEZE** is not available.

Enlarging the image

1. Press **DIGITAL ZOOM +/-** once.
 - The centred area of the image will then be enlarged to 1.5x.



2. Adjust the image size by pressing **DIGITAL ZOOM +/-**.
 - The image size will be changed in steps of 0.1.



Shifting the centre point

Press **▲ ▼ ◀ ▶** to shift the centre point.

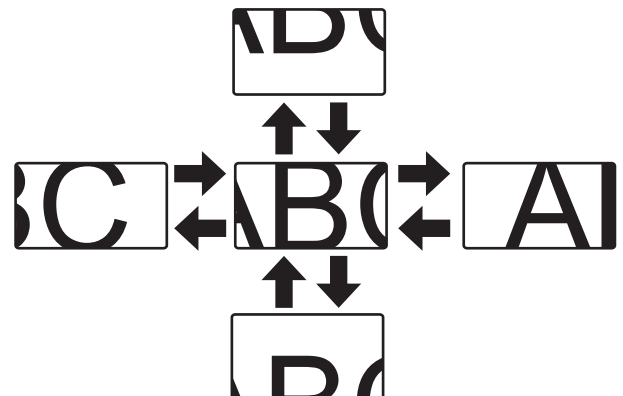

Controlling the volume of the speaker

VOLUME



You can control the volume of the built-in speakers and output sound. Press **+/-** to control the volume.

NOTE:

- Power consumption can be reduced if the volume level is lowered.

Menu Navigation

The menu system allows you to access functions which do not have their own dedicated buttons on the **Remote control**. The menu options are structured and categorized. You can navigate through the menu with ▲ ▼ ► ◀ buttons.

Navigating through the MENU

Displaying the Main menu

MENU Press the **MENU** button to display the **Main menu** and the operating guidance.

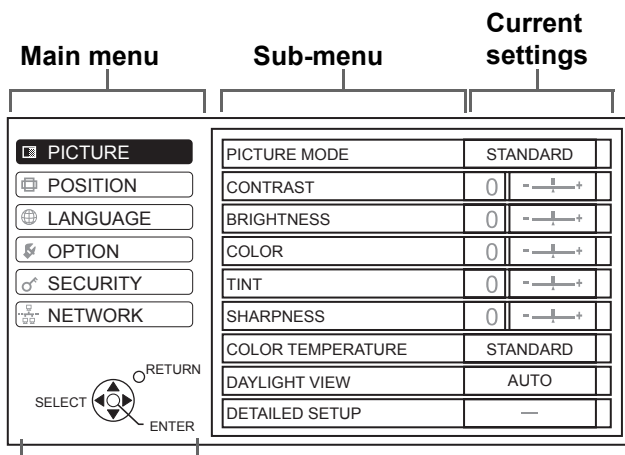

Operating guidance

Contains the required buttons to adjust the settings.

Adjusting with the bar scale items

The triangle mark under the bar indicates factory default setting and the square indicates the current setting.

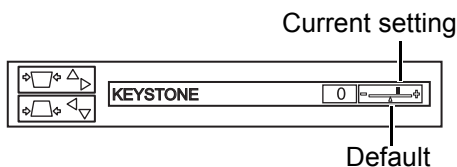

Returning to the previous menu

RETURN Press the **MENU** or **RETURN** button to return to the previous menu. Press repeatedly to escape from the menu mode and return to the projection.

Operating procedure

- Press ▲ ▼ to scroll to the required **Main menu** item and press **ENTER** to select.
 - The selected item is highlighted in orange and the **Sub-menu** is displayed on the right.
 - See “Main menu and Sub-menu” on page 28.

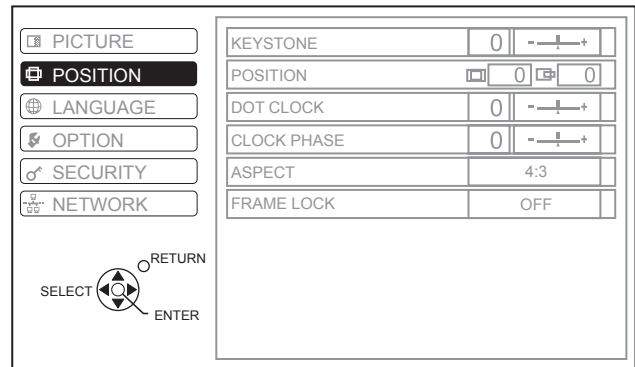

- Press ▲ ▼ to scroll to the required **Sub-menu** item and press ◀ ► or **ENTER** to adjust.
 - The selected item is called up and the other menu items disappear from the screen. Called up item will be disappear after 5 seconds and return to the menu mode.
 - If there is a lower level, the next level will be displayed.

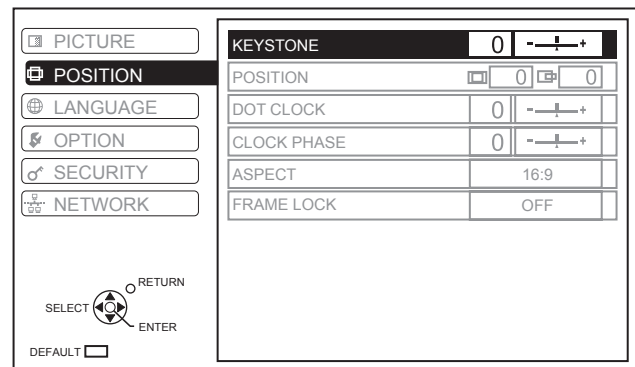

- Press ◀ ► to adjust or set the selected item.
 - For items using a bar scale, the current settings are displayed on the left of the bar scale.
 - You can cycle through the options of an item by pressing ◀ ►.



- Press **MENU** or **RETURN** to return to the previous menu.

NOTE:

- See “Resetting to the factory default settings” on page 25 to reset each menu items.
- See “INITIALIZE ALL” on page 36 to reset all the settings.



Menu Navigation

Main menu and Sub-menu

The **Main menu** has 6 options. Select the required menu item and press **ENTER** to display the **Sub-menu**.

NOTE:

- Some default settings vary by the selected input signal.
- **Sub-menu** items vary according to the selected input signal.
- Some settings are adjustable without any signals.

Main menu	Sub-menu	Options (* is default setting)		Page	
PICTURE 	PICTURE MODE	NATURAL	DYNAMIC ^{*1}	page 30	
		STANDARD *	BLACKBOARD		
	CONTRAST	• Default: 0		page 30	
	BRIGHTNESS	• Default: 0		page 30	
	COLOR ^{*2}	• Default: 0		page 30	
	TINT ^{*2}	• Default: 0		page 30	
	SHARPNESS	• Default: 0		page 30	
	COLOR TEMPERATURE	LOW	STANDARD *		page 30
	HIGH				
DAYLIGHT VIEW	AUTO *	ON		page 30	
	OFF				
DETAILED SETUP ^{*3}	WHITE BALANCE ^{*4}	WHITE BALANCE RED		page 31	
		WHITE BALANCE GREEN			
		WHITE BALANCE BLUE			
		• Default: 0			
TV-SYSTEM (S-VIDEO/VIDEO signals only)	AUTO *	NTSC			
	NTSC 4.43	PAL			
	PAL-M	PAL-N			
	SECAM				
STILL MODE (S-VIDEO/VIDEO)	OFF *				
	ON				
NOISE REDUCTION (S-VIDEO/VIDEO)	ON *				
	OFF				
POSITION 	KEystone ^{*5}	• Default: 0		page 32	
	POSITION	H	• Default: 0		page 32
		V	• Default: 0		
	DOT CLOCK ^{*4}	• Default: 0		page 32	
	CLOCK PHASE ^{*6}	• Default: 0		page 32	
	ASPECT	4:3	S4:3		page 32
16:9 *		AUTO			
FRAME LOCK	OFF *	ON		page 33	



Settings

LANGUAGE

1/2
DEUTSCH
FRANÇAIS
ESPAÑOL
ITALIANO
PORTUGUÊS
SVENSKA
NORSK
DANSK
▼

2/2
POLSKI
ČEŠTINA
MAGYAR
РУССКИЙ
ไทย
한국어
● ENGLISH
中文
日本語

*1. Default setting for **COMPUTER/COMPONENT** signals
 *2. Not available with **COMPUTER/NETWORK** signals
 *3. **VIDEO/S-VIDEO/COMPUTER** signals only
 *4. **COMPUTER** signals only
 *5. Only **KEystone** is available with **NETWORK** signals
 *6. **COMPUTER/COMPONENT** signals only

Main menu	Sub-menu	Options (* is default setting)		Page	
	OPTION				
	INPUT GUIDE	DETAILED* OFF	SIMPLE	page 34	
	STARTUP LOGO	ON* USER	OFF	page 34	
	COMPUTER2 SELECT	INPUT*	OUTPUT	page 34	
	FILTER SETUP	1* 2	3	page 34	
	FILTER REMAINING			page 34	
	LAMP RUNTIME			page 35	
	POWER OFF TIMER	OFF* 15 MIN. 20 MIN. 25 MIN. 30 MIN. 35 MIN.	40 MIN. 45 MIN. 50 MIN. 55 MIN. 60 MIN.	page 35	
	DIRECT POWER ON	OFF*	ON	page 35	
	CONTROL PANEL	VALID*	INVALID	page 35	
	AUTO SETUP	AUTO*	BUTTON	page 35	
	SIGNAL SEARCH	ON*	OFF	page 35	
	INSTALLATION	FRONT/DESK* FRONT/CEILING	REAR/DESK REAR/CEILING	page 35	
	SCREEN FORMAT	16:9*	16:10	page 35	
	HIGHLAND	OFF*	ON	page 36	
	CLOSED CAPTION	CC1 CC2	TT1 TT2	page 36	
	TEST PATTERN			page 36	
	DETAILED SETUP	OSD DESIGN	TYPE1 TYPE3	TYPE2	page 36
		SXGA MODE	SXGA	SXGA+	
		XGA MODE	XGA	WXGA	
		BLACKBOARD	ON*	OFF	
	BACK COLOR	BLUE*	BLACK		
	VOLUME				
	AUDIO BALANCE	• Default: 0			
	INITIALIZE ALL				
	SECURITY				
	INPUT PASSWORD	OFF*	ON	page 37	
	PASSWORD CHANGE			page 37	
	TEXT DISPLAY	OFF*	ON	page 37	
	TEXT CHANGE			page 37	
 (See CD-ROM contents)	NETWORK				
	WIRED LAN			page 38	
	WIRELESS LAN				
	NAME CHANGE				
	INPUT PASSWORD				
	PASSWORD CHANGE				
	NETWORK STANDBY				
	WEB CONTROL				
	LIVE MODE CUT IN				
	STATUS				
INITIALIZE					

PICTURE menu

Remote control

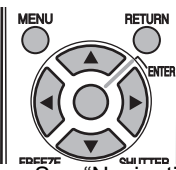

- See "Navigating through the MENU" on page 27.
- See "Main menu and Sub-menu" on page 28.

Control panel

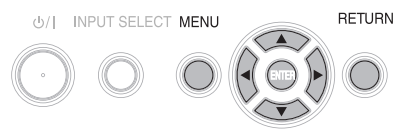

PICTURE MODE

Depending on the projection environment, you can use these preset parameter settings to optimize image projection. Press ◀ ▶ to cycle through the options.

NATURAL	Reproduces the original color of the image
STANDARD	Setting for a general image
DYNAMIC	Bright and sharp setting
BLACKBOARD	Setting for when projecting on a blackboard See "BLACKBOARD" on page 36.

NOTE:

- It may take for a while until the selected mode is stabilized.

CONTRAST

You can adjust the contrast of the projected image. Adjust the **BRIGHTNESS** in advance if necessary.



BRIGHTNESS

You can adjust the brightness of the projected image.



COLOR

You can adjust the color saturation of the projected image. (Available with **VIDEO/S-VIDEO/COMPONENT** signals only)



TINT

You can adjust the skin tone in the projected image. (Available with **VIDEO/S-VIDEO/COMPONENT** signals only)



SHARPNESS

You can adjust the sharpness of the projected image.



COLOR TEMPERATURE

You can adjust the white balance of the projected image.

- **LOW** More bluish
- **STANDARD** Balanced white
- **HIGH** More reddish

DAYLIGHT VIEW

You can keep the projected image bright and vivid even in well-lit rooms where the ambient light sources cannot be controlled, such as when a door opens or when window coverings fail to block out sunlight.

- **AUTO:** Automatic adjustment
- **ON:** Active
- **OFF:** Deactive

NOTE:

- Do not cover the **ALS** (Ambient Luminance Sensor) of the projector. See "ALS (Ambient Luminance Sensor)" on page 12.
- **AUTO** is not available when **INSTALLATION** setting in **OPTION** menu is set to **REAR/DESK** or **REAR/CEILING**.

DETAILED SETUP

You can perform more detailed image adjustment manually.

For S-VIDEO/VIDEO signals

● TV-SYSTEM

When the video signal is changed, the setting switches automatically. You can switch the setting manually to match the video data. Press ◀ ▶ to cycle through the options.

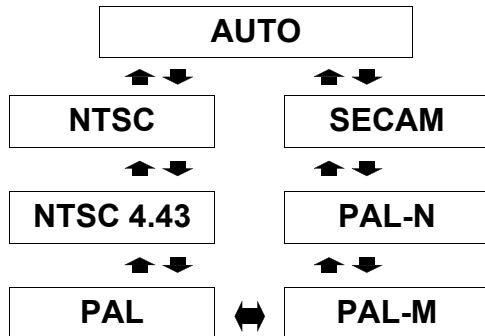

NOTE:

- AUTO setting will select from NTSC/NTSC 4.43/PAL/PAL60/PAL-M/PAL-N/SECAM.

● STILL MODE

You can reduce the vertical flicker when projecting a still image.

- OFF: Deactive
- ON: Active

NOTE:

- Set to OFF when projecting a moving image.

● NOISE REDUCTION

You can switch the automatic noise reduction system on/off. Press ◀ ▶ to select the required setting.

- ON: Automatic noise reduction
- OFF: No noise reduction

NOTE:

- Applying noise reduction may affect image quality.

For RGB signals

● WHITE BALANCE

You can adjust the white balance more properly in 3 colors temperature by pressing ◀ ▶.

- WHITE BALANCE RED
- WHITE BALANCE GREEN
- WHITE BALANCE BLUE

POSITION menu

Remote control	Control panel
<ul style="list-style-type: none"> • See "Navigating through the MENU" on page 27. • See "Main menu and Sub-menu" on page 28. 	

KEYSTONE

If the projector is aligned non-perpendicularly to the screen, or if the projection screen has an angled surface, you can correct keystone.

Image	Operation

NOTE:

- You can correct the distortion ± 30 degrees from the plane. For a better quality image, installing the projector with a minimum of distortion is recommended.
- Some distortion may be retained for lens shift adjustment.
- The distortion of the **Main menu** screen is not correctable.
- The result of the keystone correction will affect the aspect ratio and the size of the image.

POSITION

You can move the projected image for fine adjustment. Press \blacktriangleleft \blacktriangleright to move horizontally and \blacktriangleup \blacktriangledown vertically. (Available with **VIDEO/S-VIDEO/COMPUTER/COMPONENT** signals only)

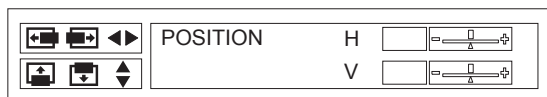

DOT CLOCK

If you have interference patterns of the projected image, which is sometimes referred to as moire or noise, you can minimize it by pressing \blacktriangleleft \blacktriangleright to adjust the clock frequency. (Available with signals from **COMPUTER** only)

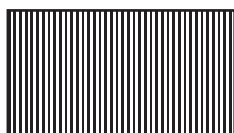

NOTE:

- If the projecting signal's dot clock frequency is higher than 108 MHz, the adjustment may not make a difference.
- **DOT CLOCK** needs to be adjusted before adjusting the **CLOCK PHASE**.

CLOCK PHASE

If you require further adjustment for the same reason as the **DOT CLOCK** adjustment, you can fine adjust the timing of the clock. Press \blacktriangleleft \blacktriangleright to adjust. (Available with signals from **COMPUTER/COMPONENT** only)

NOTE:

- If the projecting signal's dot clock frequency is higher than 108 MHz, the adjustment may not make a difference.

ASPECT

You can switch the aspect ratio manually when needed. Press \blacktriangleleft \blacktriangleright to cycle through the options.

Aspect ratio options

● AUTO

Signals which contains an identifying signal will be detected and automatically project the image in proper ratio.

● 4:3

When a 4:3 or 5:4 signal is detected, the image will be projected without any change, and other signals will be adjusted to 4:3 with preserving original ratio.

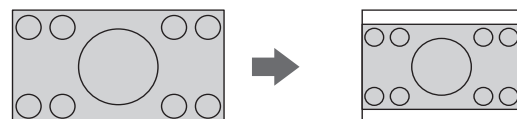

● 16:9

When a 16:10, 16:9 or 15:9 signal is detected, the image will be projected without any change, and other signals will be adjusted to 16:9.

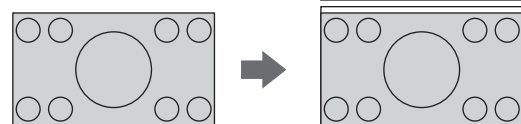
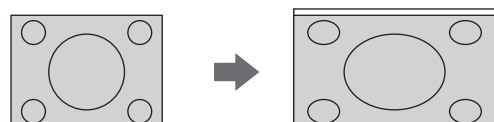

H-FIT

The 4:3/5:4 image will be stretched to the horizontal limit of the **SCREEN FORMAT** setting size with preserving original ratio and the vertical edge will be cropped.

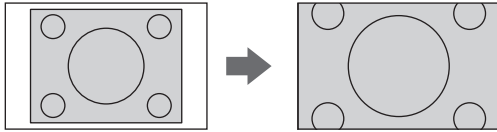

V-FIT

The 16:9 (16:10)/15:9 image will be stretched to the vertical limit of the **SCREEN FORMAT** setting size with preserving original ratio and the horizontal edge will be cropped.

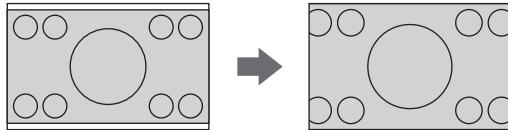

HV-FIT

The image will be stretched to the vertical and horizontal limit of the **SCREEN FORMAT** setting size with preserving original ratio and the vertical and horizontal edge will be cropped.

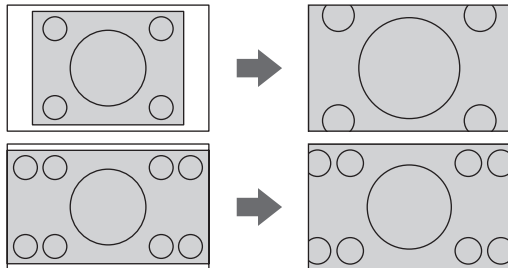

NOTE:

- If you project an image with an unmatched aspect ratio, the image may distort or some portions may be cropped. Select an aspect ratio which preserves the intention of the image creator.
- The order of **ASPECT** types is defined not only by the input method but also by the input signals. See “List of compatible signals” on page 44.
- If you project a copyrighted image enlarged or distorted by using **ASPECT** function in commercial use in a public place, such as a restaurant or hotel, you might infringe on the copyright of the creator which is protected by copyright law.
- **AUTO** will not be selectable with some certain signals from **VIDEO/S-VIDEO/COMPONENT**.

Aspect ratio depend on signals and SCREEN FORMAT menu option

SCREEN FORMAT menu	ASPECT menu
VIDEO/S-VIDEO/COMPONENT	
16:10	AUTO ◀▶ 4:3 ◀▶ 16:9 ◀▶ H-FIT ◀▶ HV-FIT
16:9	AUTO ◀▶ 4:3 ◀▶ H-FIT ◀▶ HV-FIT
● 1 080/50i, 1 080/60i, 720/50p, 720/60p	
16:10	16:9 ◀▶ V-FIT ◀▶ HV-FIT ◀▶ 4:3
16:9	Not available
COMPUTER	
16:10	4:3 ◀▶ 16:9 ◀▶ H-FIT ◀▶ HV-FIT
16:9	4:3 ◀▶ H-FIT ◀▶ HV-FIT
● WXGA768	
16:10	16:9 ◀▶ V-FIT ◀▶ HV-FIT ◀▶ 4:3
16:9	16:9 ◀▶ HV-FIT
● WIDE signals except WXGA768	
16:10	16:9 ◀▶ 4:3
16:9	4:3 ◀▶ HV-FIT

FRAME LOCK

If the projected image is degraded, you can activate **FRAME LOCK** for synchronization. Press ◀▶ to select the required option.

- OFF Deactive
- ON Active

NOTE:

- This function is available with **COMPUTER** signals only.

OPTION menu

Remote control

- See “Navigating through the MENU” on page 27.
- See “Main menu and Sub-menu” on page 28.

Control panel

INPUT GUIDE

When you change the input method, the guidance appears in the upper right corner of the screen. The following display methods are available. Press ◀ ▶ to cycle through the options.

Options	Function
OFF	Turn off the guidance.
SIMPLE	Display the input method by text. The INPUT GUIDE will go out after 5 seconds without any operation.
DETAILED	Display the input method by graphic. The INPUT GUIDE will go out after 10 seconds without any operation. If you select any COMPUTER terminal which has no signal, the computer connection guidance will be displayed. See “Computer connection guidance” on page 46.

STARTUP LOGO

You can switch the logo on/off that is displayed when starting up the projector. Press ◀ ▶ to select the required option. **STARTUP LOGO** will be displayed for 30 seconds.

- **ON** Active
- **OFF** Deactive
- **USER** Display the original text

● Editing the original text

If you select **USER**, you can display the 2 lines of original text up to 40 characters in 1 line instead of the logo.

TEXT CHANGE

A	B	C	D	E	F	G	H	I	J	K	L	M	DELETE	
N	O	P	Q	R	S	T	U	V	W	X	Y	Z		
a	b	c	d	e	f	g	h	i	j	k	l	m		
n	o	p	q	r	s	t	u	v	w	x	y	z		
0	1	2	3	4	5	6	7	8	9	SPACE				
!	"	#	\$	%	&	'	*	+	-	/	=	?@	\	^
_	`		~	()	<	>	[]	{	}	,	.	;

OK
CANCEL

1. Select **USER** and press **ENTER**.
2. Select the required line to enter or edit the original text, and press **ENTER**.
3. Use ▲ ▼ ◀ ▶ to specify the location of the required character and press **ENTER**.
 - The selected character will be displayed in the box.
 - Select **DELETE** to delete the last entered character and press **ENTER**.
4. Repeat the step 3 until you finish the text to display in a line.
5. Select **OK** and press **ENTER** to set the entered text in a box.
 - Press ▼ and edit the **TEXT2** if you need to, and repeat the step 3 - 5.

COMPUTER2 SELECT

You can switch the function of the **COMPUTER2 IN/1 OUT** terminal.

- **INPUT** **COMPUTER2 IN**
- **OUTPUT** **COMPUTER1 OUT**

FILTER SETUP

You can change the pace of the **ARF** (Auto Rolling Filter) performance for the use environment. Press ◀ ▶ to select the required option.

- **1** Ventilated with indoor air (e.g. small office room)
- **2** Ventilated with outdoor air (e.g. large office room, class room)
- **3** Public indoor space (e.g. restaurant, building lobby)

NOTE:

- The **ARF** is a nonreusable product.
- Select the most suitable option for the use environment.
- If you select an unsuitable option, it may greatly affect on the duration of the projector life.

FILTER REMAINING

You can check the remaining amount of the **ARF** (Auto Rolling Filter). The color of the bar scale is indicating the condition of the **ARF**.

- Yellow The filter remaining amount is getting low.
- Red No more remaining.

NOTE:

- See “Replacing the ARF (Auto Rolling Filter)” on page 40.
- After you replace the ARF, **FILTER REMAINING** should be reset to “0” by pressing the **ENTER** button for 3 seconds.

LAMP RUNTIME

You can check how long the lamp has been used.

NOTE:

- **LAMP RUNTIME** is a relevant matter for lamp replacement timing. See “Replacing the Lamp unit” on page 41.
- When the lamp unit is replaced with the new one (ET-LAF100), the setting will be reset to “0”.

POWER OFF TIMER

You can set the off timer to switch off the **POWER** of the projector after a certain period of time automatically when no signal is detected. Press ◀▶ to select the required period from 15 to 60 minutes at intervals of 5 minutes.

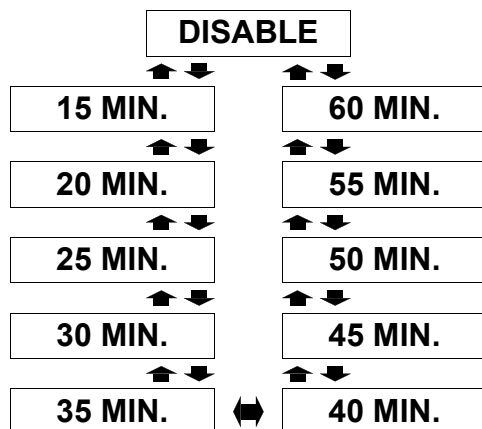

DIRECT POWER ON

You can switch the projector start up status for when the **Power cord** is connected while the **MAIN POWER** is on, or for when the **MAIN POWER** is switched on while the **Power cord** is connected. Press ◀▶ to select the required option.

- **OFF** The projector will start from the standby mode or the projecting mode.
- **ON** The projector will start from the projecting mode.

NOTE:

- When the projector is started from the projecting mode, pressing the **POWER** button procedure is skippable.

CONTROL PANEL

You can turn off the function of the control panel buttons on the projector body. Press ◀▶ to select the required option.

- **INVALID** Invalidate the control panel buttons Confirmation screen will be displayed.
- **VALID** Validate the control panel buttons

AUTO SETUP

You can turn off the **AUTO SETUP** function for when the **COMPUTER** signal is detected.

- **AUTO** When the projector detect a **COMPUTER** signal, adjust the projected image position automatically for **SIGNAL SEARCH**, **DOT CLOCK** and **CLOCK PHASE**.
- **BUTTON** Only when the **AUTO SETUP** button is pressed, the projected image position will be adjusted for **DOT CLOCK** and **CLOCK PHASE**. See “Remote control” on page 11.

NOTE:

- Usually the recommended setting is **AUTO**.

SIGNAL SEARCH

You can turn off the auto signal detecting system.

- **ON** Detect the input signal from the terminals and project the image.
- **OFF** Deactive

NOTE:

- **SIGNAL SEARCH** is not available when any input signal is projecting.
- Usually the recommended setting is **ON**.

INSTALLATION

When installing the projector, select the projection method according to the projector position. Press ◀▶ to cycle through the options. See “Projection method” on page 15.

FRONT/DESK	Setting on a desk/floor and projecting from front
FRONT/CEILING	Mounting in the ceiling and projecting from front
REAR/DESK	Setting on a desk/floor and projecting from rear
REAR/CEILING	Mounting in the ceiling and projecting from rear

SCREEN FORMAT

Select the required screen format by pressing ◀▶.

- **16:10** When project on a 16:10 or 4:3 screen.
- **16:9** When project on a 16:9 screen.

OPTION menu

HIGHLAND

If you use the projector at high elevation, the **HIGHLAND** setting need to be **ON** to set the fan speed high. Press ◀ ▶ to select the required option.

- **OFF** The fan speed is low.
- **ON** The fan speed is high.

NOTE:

- At 1 400 m (4 593 ft) above sea level, the setting must be **ON**.
- The loudness of fan noise depends on the **HIGHLAND** setting.

CLOSED CAPTION

If the input signal contains closed captions, you can turn on the feature and switch the channels. Press ◀ ▶ to select the required option.

OFF	Deactive
CC1	Caption channels
CC2	
TT1	Text channels
TT2	

TEST PATTERN

You can use the 7 different test patterns to adjust the focus of the image. See “Lens shift and positioning” on page 16.

1. Press **ENTER** to display the test pattern 1.
2. Press ◀ ▶ to select the required test pattern.
3. Adjust the focus with the **Focus lever**.
4. Press **MENU** or **RETURN** to return to the previous menu, oar press repeatedly to escape the menu mode.

NOTE:

- When the projector and/or the screen is tilted, adjust the focus at the centre of the image. The upper and lower edge might be out of focus.
- When the image is distorted in keystone, adjust the **KEystone** in **POSITION** menu.

DETAILED SETUP

You can perform more detailed setting in various items.

OSD DESIGN

You can change the background color of the menu. Press ◀ ▶ to select the required option.

TYPE1	Semi transparent black
TYPE2	Solid blue
TYPE3	Semi transparent dark blue

SXGA MODE

You can switch the setting between **SXGA** and the larger setting, **SXGA+**. Press ◀ ▶ to select the required option.

WIDE MODE

You can turn **ON/OFF** the **WIDE MODE** setting.

- **ON** For WIDE signals
- **OFF** For other type of signals

BLACKBOARD

You can exclude the **BLACKBOARD** in menu items of **PICTURE MODE** in **PICTURE** menu. Press ◀ ▶ to select the required option.

- **ON** Include the **BLACKBOARD** in menu items.
- **OFF** Exclude the **BLACKBOARD** in menu items.

BACK COLOR

You can choose a **BLUE** or **BLACK** screen for when the projector is idle. Press ◀ ▶ to select the required option.

VOLUME

You can adjust the volume of the built-in monaural speaker and **VARIABLE AUDIO OUT** terminal.

- ◀ Decrease
- ▶ Increase

AUDIO BALANCE

You can adjust to hear the sound played equally through both right and left external stereo speakers, or shift the balance so more sound plays through the left or right side.

- ◀ More sound plays through the left side
- ▶ More sound plays through the right side

INITIALIZE ALL

You can reset all of the customized settings to the factory defaults except **NETWORK**, **LAMP RUNTIME** and **FILTER REMAINING** menu settings.

1. Press the **ENTER** button
2. Turn off the projector by pressing the **POWER** button.
3. Switch off the **MAIN POWER** button to reset the projector.
4. The minimum required setting screen will be displayed.
 - See “Minimum required setting screen” on page 10.

SECURITY menu

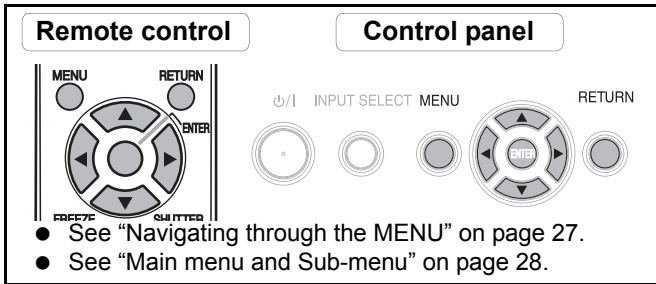

Entering the SECURITY menu

Every time when you apply to the **SECURITY** menu, you will be asked to perform the password operation.

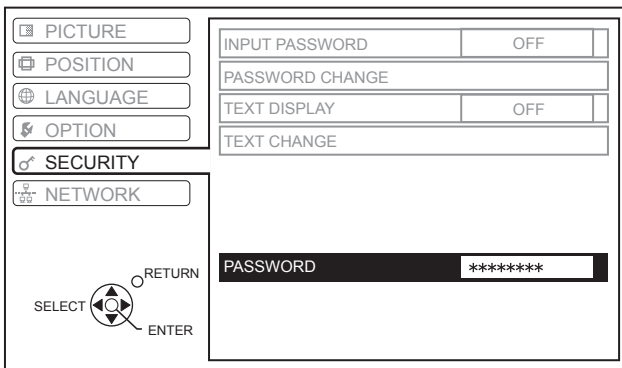

When you apply to the **SECURITY** menu before you change the password to your original, perform to input the following factory default password operation.

- Press ▲▶▼◀▲▶▼◀ and **ENTER**.

After you change the password

When you apply to the **SECURITY** menu after you change the password to your original in the **PASSWORD CHANGE** menu, input the original password operation.

NOTE:

- The factory default password is valid until you change the password in **PASSWORD CHANGE** menu.
- The entered password operations will appear as asterisks in the box.

INPUT PASSWORD

You can activate the security system and the password operation will be asked to perform when the projecting mode started. Unless you perform the correct password operation, all of the button controls will be disabled except the **POWER** button.

- **OFF** Deactive
- **ON** Active

NOTE:

- When you activated the security system, make sure to change the password to your original for safety.
- The factory default password is valid until you change the password in **PASSWORD CHANGE** menu.

PASSWORD CHANGE

You can change the password operation to your original.

1. Press a series of button operation up to 8 as a password by using ▲ ▼ ◀ ▶ buttons.
2. Press **ENTER**.
3. Press the exact same series of button operation you entered in the **NEW** password box for confirmation.
 - If a series of button operation is incorrect, you will be asked to perform again.
4. Press **ENTER**.

NOTE:

- The entered password operations will appear as asterisks in the box.

TEXT DISPLAY

You can set your original text, such as company name or URL information, to display regularly at the bottom of the projected image while projecting.

- **OFF** Deactive
- **ON** Active

TEXT CHANGE

You can enter your original text up to 22 characters for **TEXT DISPLAY**.

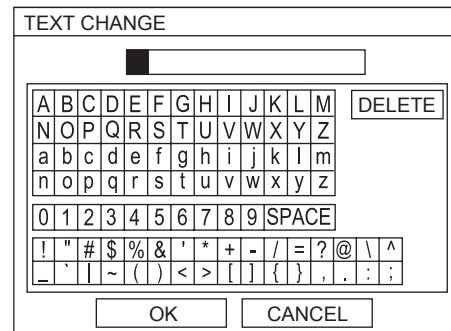

1. Use ▲ ▼ ◀ ▶ to specify the location of the required character.
2. Press **ENTER**.
 - The selected character will be displayed in the **TEXT CHANGE** box.
3. Repeat until finish your original text.
 - Select **DELETE** to delete the last entered character and press **ENTER**.
4. Select **OK** and press **ENTER** to set the entered text.
 - Select **CANCEL** or press **MENU/RETURN** buttons to return to the previous menu.

NETWORK menu

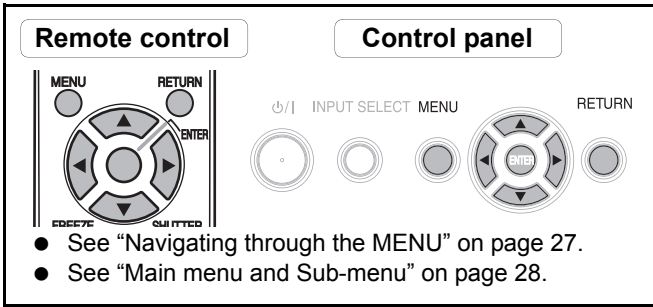

NOTE:

- See more detailed instructions in the contents of the **CD-ROM** which is provided with the projector.

Items in NETWORK menu

In **NETWORK** menu, the following items are available.

- WIRED LAN
- WIRELESS LAN
- NAME CHANGE
- INPUT PASSWORD
- PASSWORD CHANGE
- NETWORK STANDBY
- WEB CONTROL
- LIVE MODE CUT IN
- STATUS
- INITIALIZE

TEMP, LAMP and FILTER Indicators

Managing the indicated problems

If a problem should occur with the projector, the **TEMP**, **LAMP** and/or **FILTER** indicators will inform you. Manage the indicated problems as follow.

1. Confirm the status of all indicators and projector, and switch off the projector in proper way.
2. Find out the cause of the problem by status of the **TEMP**, **LAMP** and/or **FILTER** indicators.
3. Follow the instruction for each indication below and solve the problem.
4. Turn on the projector in the correct way and confirm the indicator is not indicating a problem any longer.

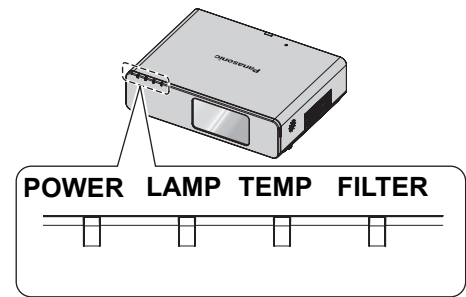

NOTE:

- If no problem is found or the problem remains, do not turn on the projector. Instead contact an Authorized Service Center.

LAMP indicator

Indicator	● Illuminating RED	● Flashing RED		
Problem	LAMP RUNTIME has reached 2 800 hours.	LAMP circuit failure, abnormal function or Lamp unit is damaged.		
Cause	Lamp unit will run out soon and needs to be replaced.	The MAIN POWER is switched on again before the Lamp unit is cooled enough.	LAMP circuit failure, abnormal function.	Lamp unit is damaged.
Remedy	See “Replacing the Lamp unit” on page 41.	Let the Lamp unit cool down and turn on the MAIN POWER .	Contact an Authorized Service Center.	See “Replacing the Lamp unit” on page 41.

TEMP indicator

Indicator	● Illuminating RED and still projecting ● Flashing RED and POWER is turned off			
Problem	The temperature inside and/or outside the projector is abnormally high.			
Cause	The ventilation openings are covered.	The room temperature is too high.	The ARF is excessively dirty and the ventilation is poor.	The projector is located at high elevations (above 1 400 m).
Remedy	Remove the object(s) from the ventilation openings or clear around the projector.	Reinstall the projector in temperature controlled place. See page 48.	Replace the ARF in the proper method. See page 40.	Turn on the projector* ¹ and set the HIGHLAND to ON . See page 36.

*1. The projector will perform only 2 minutes with OFF setting at high elevation.

FILTER indicator

When the **FILTER** indicator is flashing **GREEN**, the **ARF** is normally rolling up.

Indicator	● Illuminating RED	● Flashing RED	● Illuminating ORANGE	● Flashing ORANGE
Problem	FILTER REMAINING has turned red. See page 34.	The projector cannot detect the ARF .	The ARF cannot operate properly.	FILTER REMAINING has turned yellow. See page 34.
Cause	ARF has been run out.	ARF is not attached.	Foreign object is blocking the ARF operation.	ARF is running out.
Remedy	See “Replacing the ARF (Auto Rolling Filter)” on page 40.	Attach the ARF .	Remove the foreign object or contact an Authorized Service Center.	Prepare the ARF for replacement.

Care and Replacement

Cleaning the projector

Before cleaning the projector

- Switch off the **MAIN POWER** and disconnect the power plug from the wall outlet.
- Unplug all the cables from the projector.

Cleaning the outer surface of the projector

Wipe off dirt and dust gently with a soft cloth.

- If it is difficult to remove the dirt, soak a cloth in a neutral detergent diluted with water, wring the cloth well and then wipe the projector. Dry off the projector with dry cloth.
- If you use a chemical treated wipe, follow the instructions supplied with it.

Cleaning the lens and front glass surface

Wipe off dirt and dust gently with a lint-free cloth.

- Make sure no dirt or dust remains on the surface of the lens. It will be enlarged and projected onto a screen.

Replacing the ARF (Auto Rolling Filter)

Before replacing the ARF

- Press the **POWER** button for at least 0.5 seconds or press twice to turn off the projector.
- Wait until the cooling fan stops and the **POWER** indicator turn to **RED**.
- Disconnect the **Power cord** from the main socket.
- Prepare a Phillips-head screw driver.
- Contact an Authorized Service Center to purchase a replacement **ARF** (ET-RFF100).

When to replace the ARF

ARF is consumable product and effects on ventilation. **FILTER** indicator will inform you of the replacement timing. You can check the remaining amount of the **ARF** in **FILTER REMAINING** menu.

NOTE:

- See "FILTER REMAINING" on page 34.
- See "FILTER indicator" on page 39.

Replacement procedure

1. Turn the projector upside down and place it gently on a soft cloth.
2. Use a Phillips-head screwdriver to loosen 3 **ARF cover** fixing screws until the screws turn freely and remove the **ARF cover**.
3. Use a Phillips-head screwdriver to loosen an **ARF** fixing screws and release the clamp, then slightly slide up the used **ARF** to remove.
4. Insert the new **ARF** into the compartment in correct direction and slightly push down until it clicks. Tighten the **ARF** fixing screws securely with a Phillips-head screwdriver.
5. Attach the **ARF cover** and tighten the **ARF cover** fixing screws securely with a Phillips-head screwdriver.

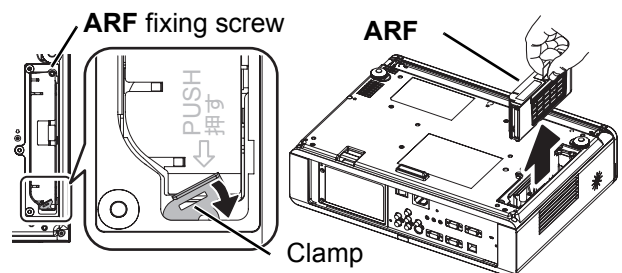
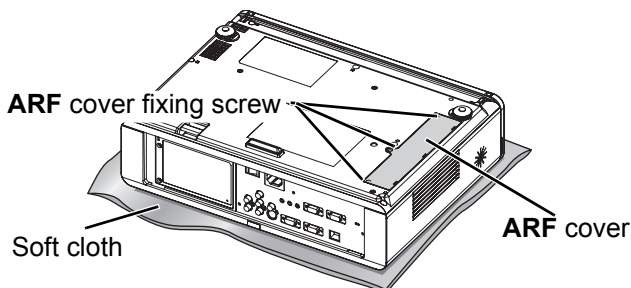

NOTE:

- If the **ARF** and/or **ARF cover** are attached incorrectly, the projector may not be turned on.
- Do not switch the power on while the **ARF cover** removed.
- When you replace the **ARF** unit, clean the compartment and/or the **Air Exhaust port** if you need to.

Resetting the FILTER REMAINING

1. Turn on the projector and display the **FILTER REMAINING** in **OPTION** menu. Press the **ENTER** button for 3 seconds and the confirmation screen will be displayed.
2. Press **◀** to select **OK** and press the **ENTER** button to reset **FILTER REMAINING** to "0". See "FILTER REMAINING" on page 34.

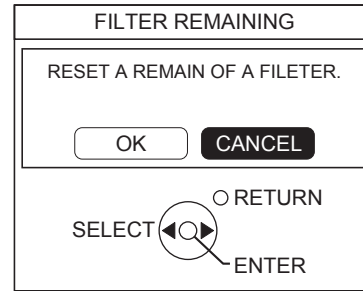

Replacing the Lamp unit

Before replacing the Lamp unit



- Switch off the **MAIN POWER** and disconnect the power plug from the wall outlet.
- Make sure the **Lamp unit** and the surroundings are cooled enough.
- Prepare a Phillips-head screwdriver.
- Contact an Authorized Service Center to purchase a replacement **Lamp unit** (ET-LAF100).
- When the projector is mounted in the ceiling, do not work directly under the projector or put your face closer to the projector.

NOTE:

- Prior to replacing the lamp unit, allow it to cool down to prevent the risk of burns, damage and other hazards.
- Do not attempt replacement with an unauthorized lamp unit.

When to replace the Lamp unit

The **Lamp unit** is consumable and the brightness decreases by duration of usage. The **LAMP** indicator will inform you of the replacement timing at 2 800 hours, and at 3 000 hours, the projector will be turned off. Those figures are rough guidance and might be shortened by the usage conditions, characteristics of the **Lamp unit**, environmental conditions, and so on. You can check the duration of usage time using **LAMP RUNTIME** in the **OPTION** menu.

Indication	On screen	LAMP indicator
Over 2 800 hours		
Over 3 000 hours	<p>"REPLACE LAMP" is displayed on the upper left of the screen, and it will stay until you respond. To clear the screen, press any button.</p>	Illuminates RED .

NOTE:

- The guide times, 2 800 and 3 000 hours, are rough estimates based on certain conditions and is not a guaranteed time.
- For more information about the **Lamp unit**, such as guaranteed time, see the instructions which is provided with the **Lamp unit**.

Care and Replacement

Replacement procedure

Removing and replacing the lamp unit

1. Use a Phillips-head screwdriver to loosen the 2 **Lamp unit cover** fixing screws on the back of the projector until the screws turn freely, and remove the **Lamp unit cover**.

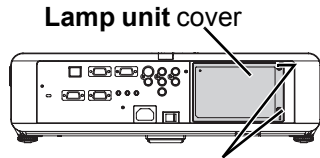

2. Use a Phillips-head screwdriver to loosen the 2 **Lamp unit** fixing screws.
3. Hold the handles of the **Lamp unit** and release the lamp unit lock.
4. Pull the used **Lamp unit** gently from the projector.

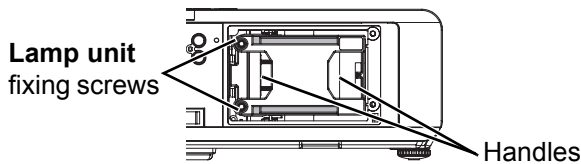

5. Replace the new **Lamp unit** in correct direction.
 - **LAMP RUNTIME** will be reset to "0" automatically.

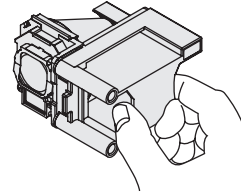

6. Press in the **Lamp unit** until it clicks and make sure the unit is installed securely.
7. Tighten the 2 **Lamp unit** fixing screws securely with a Phillips-head screwdriver.

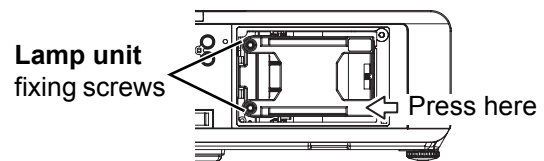

8. Attach the **Lamp unit cover** and tighten the 2 **Lamp unit cover** fixing screws securely with a Phillips-head screwdriver.

Ceiling mount bracket safeguards

The projector and the ceiling mount bracket are designed sufficiently safety though, make sure the safety cable provided with the projector is installed and attached to the bottom of the projector when mounting in the ceiling for safety and security.

NOTE:

- Even if it is guarantee period, the manufacturer is not responsible for any hazard or damage caused by using a ceiling mount bracket which is not purchased from an authorized distributors, or environmental conditions.
- Make sure to use a torque driver and do not use an electrical screwdriver or an impact screwdriver.
- Installation work of the ceiling mount bracket should only be carried by a qualified technician.
- Remove an unused ceiling mount bracket promptly.

Installing the safety cable

1. Install the ceiling mount bracket according to the installation instructions.
2. Loop the security cable around the ceiling mount bracket with less slack.
 - Lace the cable of the end with a latch through the loop on the other end of the cable.
3. Attach the latch on to the bottom of the projector with a provided screw.
 - Torque: 1.25 ± 0.2 N·m

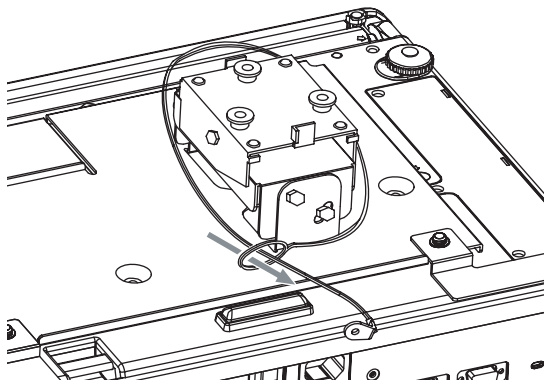

* Indicated above is ET-PKX100S.

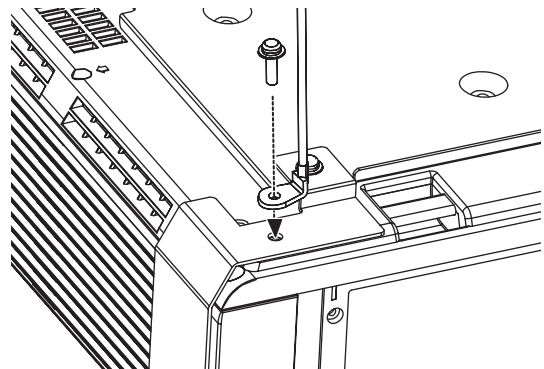

Troubleshooting

Should any problem persist, contact your dealer.

Problem	Cause	Reference page
Power does not turn on.	● The power cord may not be connected.	20
	● The MAIN POWER switch is turned off.	21
	● No electric supply is at the wall outlet.	20
	● TEMP indicator is lit or flashes.	39
	● LAMP indicator is lit or flashes.	39
	● The lamp unit cover has not been securely installed.	42
No picture appears.	● The video signal input source may not be connected to a terminal properly.	-
	● The input selection setting may not be correct.	19
	● The BRIGHTNESS adjustment setting may be at the minimum setting.	24
	● The SHUTTER function may be in use.	30
		25
The picture is fuzzy.	● The lens focus may not have been set correctly.	22
	● The projector may not be at the correct distance from the screen.	14
	● The lens may be dirty.	9
	● The projector may be tilted too much.	16
The color is pale or greyish.	● COLOR or TINT adjustment may be incorrect.	30
	● The input source which is connected to the projector may not be adjusted correctly.	28
No sound can be heard from the internal speaker.	● The audio signal source may not be connected properly.	18
	● A cable may be connected to the VARIABLE AUDIO OUT terminal.	13
	● The volume adjustment may be at the lowest possible setting.	26
The control buttons of the projector do not operate.	● CONTROL PANEL in OPTION menu is invalidated. If you have a loss of the Remote control while the CONTROL PANEL is invalidated, press and hold the MENU button for 2 seconds with pressing the ENTER button.	35
The Remote control does not operate.	● The batteries may be weak.	-
	● The batteries may not have been inserted correctly.	11
	● The remote control signal receptor on the projector may be obstructed.	23
	● The remote control unit may be out of the operation range.	23
The picture does not display correctly.	● The signal format (TV-SYSTEM) may not have been set correctly.	31
	● There may be a problem with the VCR or other signal source.	-
	● A signal which is not compatible with the projector is being input.	44
Picture from a computer does not appear.	● The cable may be longer than the optional cable.	-
	● The external video output from a laptop computer may not be correct. (You may be able to change the external output settings by pressing the [Fn] + [F3] or [Fn] + [F10] keys simultaneously. The actual method varies depending on the type of computer; refer to the documentation provided with your computer for further details.)	46
	● COMPUTER2 SELECT setting in OPTION menu is not correct.	34

Technical Information

List of compatible signals

Mode	Display resolution (dots) ^{*1}	Scanning frequency		Dot clock frequency (MHz)	Picture quality ^{*2}	Terminals
		H (kHz)	V (kHz)			
NTSC/NTSC 4.43/ PAL-M/PAL60	720 x 480i	15.7	59.9	-	A	VIDEO/S-VIDEO
PAL/PAL-N/SECAM	720 x 576i	15.6	50.0	-	A	
480i	720 x 480i	15.7	59.9	13.5	A	COMPONENT/ COMPUTER ^{*3}
576i	720 x 576i	15.6	50.0	13.5	A	
480p	720 x 483	31.5	59.9	27.0	A	
576p	720 x 576	31.3	50.0	27.0	A	
1 080/60i	1 920 x 1 080i	33.8	60.0	74.3	A	
1 080/50i	1 920 x 1 080i	28.1	50.0	74.3	A	
720/60p	1 280 x 720	45.0	60.0	74.3	A	
720/50p	1 280 x 720	37.5	50.0	74.3	A	
VESA	640 x 400	31.5	70.1	25.2	A	
	640 x 400	37.9	85.1	31.5	A	
VGA480	640 x 480	31.5	59.9	25.2	A	COMPUTER
	640 x 480	35.0	66.7	30.2	A	
	640 x 480	37.9	72.8	31.5	A	
	640 x 480	37.5	75.0	31.5	A	
	640 x 480	43.3	85.0	36.0	A	
SVGA	800 x 600	35.2	56.3	36.0	A	
	800 x 600	37.9	60.3	40.0	A	
	800 x 600	48.1	72.2	50.0	A	
	800 x 600	46.9	75.0	49.5	A	
	800 x 600	53.7	85.1	56.3	A	
MAC	832 x 624	49.7	74.6	57.3	A	
XGA	1 024 x 768	39.6	50.1	51.9	A	
	1 024 x 768	48.4	60.0	65.0	A	
	1 024 x 768	56.5	70.1	75.0	A	
	1 024 x 768	60.0	75.0	78.8	A	
	1 024 x 768	68.7	85.0	94.5	A	
MXGA	1 152 x 864	64.0	71.2	94.2	A	
	1 152 x 864	67.5	74.9	108.0	A	
	1 152 x 864	76.7	85.0	121.5	A	
MAC	1 152 x 870	68.7	75.1	100.0	A	
MSXGA	1 280 x 960	60.0	60.0	108.0	A	
SXGA	1 280 x 1 024	64.0	60.0	108.0	A	
	1 280 x 1 024	80.0	75.0	135.0	A	
	1 280 x 1 024	91.1	85.0	157.5	A	
SXGA60+	1 400 x 1 050	64.0	60.0	108.0	A	
	1 400 x 1 050	65.1	59.9	122.4	A	
UXGA	1 600 x 1 200	75.0	60.0	162.0	A	
WXGA	1 280 x 768	39.6	49.9	65.3	A	
	1 280 x 768	47.8	59.9	79.5	A	
	1 280 x 800	41.3	50.0	68.0	AA	

*1. The "i" appearing after the resolution indicates an interlaced signal.

*2. The following symbols are used to indicate picture quality.

AA Maximum picture quality can be obtained.

A Signals are converted by the image processing circuit before picture is projected.

*3. YPbPr signals are available with COMPONENT terminal, and RGBHV signals are available with COMPUTER terminals.

Serial terminal

The serial connector which is on the connector panel of the projector conforms to the RS-232C interface specification, so that the projector can be controlled by a personal computer which is connected to this connector.

Connection

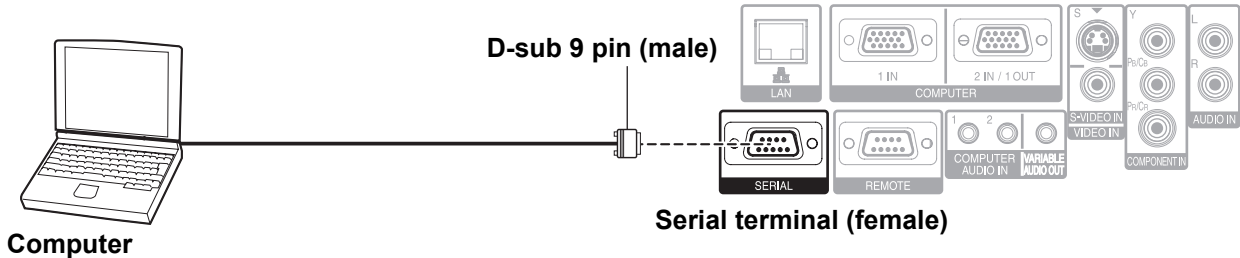

Pin assignments and signal names

	Pin No.	Signal name	Contents
	①		NC
	②	TXD	Transmitted data
	③	RXD	Received data
	④		NC
	⑤	GND	Earth
	⑥		NC
	⑦	RTS	Connected internally
	⑧	CTS	
	⑨		NC

Communication settings

Signal level	RS-232C	Character length	8 bits
Sync. method	Asynchronous	Stop bit	1 bit
Baud rate	9 600 bps	X parameter	None
Parity	None	S parameter	None

Basic format

STX	Command	:	Parameter	ETX
Start byte (02h)	3 bytes	1 byte	1 byte - 4 bytes	End (03h)

The data streaming from the computer will start with STX, and proceed to Command, Parameter and end with ETX. You can add the required parameter.

- The projector can not receive any command for 10 seconds after the lamp is switched on. Wait 10 seconds before sending the command.
- If sending multiple commands, check that a response has been received from the projector for one command before sending the next command.
- When a command which does not require parameters to be sent, the colon (:) is not required.
- If an incorrect command is sent from the personal computer, the ER401 command will be sent from the projector to the personal computer.

Technical Information

Cable specifications

(When connected to a personal computer)

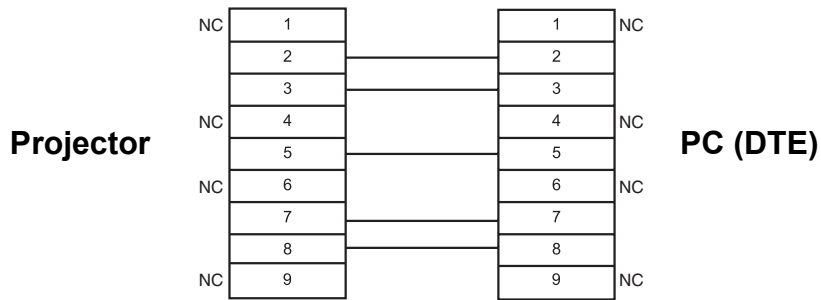

Control commands

Command	Control contents	Remarks
PON	Power ON	In standby mode, all commands other than the PON command are ignored. ● The PON command is ignored during lamp ON control.
POF	Power OFF	If a PON command is received while the cooling fan is operating after the lamp has switched off, the lamp is not turned back on again straight away in order to protect the lamp.
AVL	Volume	Parameter 000 - 063 (Adjustment value 0 - 63)
IIS	INPUT	Parameter: VID = VIDEO RG1 = COMPUTER1 NWP = WIRELESS SVD = S-VIDEO RG2 = COMPUTER2
Q\$\$	Lamp condition query	Call back 0 = Standby 1 = Lamp ON control active 2 = Lamp ON 3 = Lamp OFF control active
OSH	SHUTTER	Turning off the projection temporarily. Send the command to switch between ON and OFF. Do not send the command consecutively.

Computer connection guidance

You can switch the signals which to output from the **COMPUTER1 OUT** terminal by pressing the computer key command. The key commands are depend on the manufactures. If you select the computer terminals which has no signals while the **INPUT GUIDE** is set to **DETAILED**, the computer connection guidance will be displayed.

Manufacturer	Key command	Manufacturer	Key command	Manufacturer	Key command
Panasonic NEC	Fn + F3	TOSHIBA SHARP HP	Fn + F5	IBM SONY	Fn + F7
				Apple	F7
FUJITSU	Fn + F10	EPSON DELL	Fn + F8	Other	Fn +

NOTE:

- The computer connection guidance will disappear after 5 minutes.
- Please refer the instructions which provided with the computers for more detailed information.

REMOTE terminal

You can remotely operate the projector from the outside the **Remote control** range by connecting to the **REMOTE** terminal.

Pin assignments and signal names

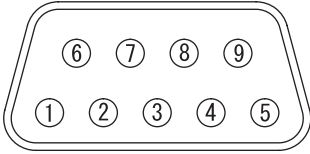
	Pin No.	Signal name	Contents
	①	GND	Ground
	②	POWER	POWER ON
	③	INPUT SEL3	Select input signal 3
	④		NC
	⑤	INPUT SEL1	Select input signal 1
	⑥	INPUT SEL2	Select input signal 2
	⑦		Connect internally
	⑧		
	⑨	ENABLE	Control by external contact

LAMP switching

Pin No.	Settings	
② - ①	Short	Open
Operation	On	Off

Switching input signals

Pin No.	Settings					
③ - ①	Open	Open	Short	Short	Short	Open
⑤ - ①	Open	Short	Open	Open	Short	Short
⑥ - ①	Open	Open	Short	Open	Open	Short
Input signal	COMPUTER1	COMPUTER2	COMPONENT	VIDEO	S-VIDEO	NETWORK

NOTE:

- When pin ① and pin ⑨ are short-circuited, the buttons on the projector's control panel, **POWER** and **INPUT SELECT** buttons on the **Remote control** cannot be used. In addition, the RS-232C commands and network functions that correspond to these functions cannot be used either.
- While pin ⑨ is "Open", do not short-circuit pin ①, ②, ③, ⑤ and ⑥. The projector would reject all the signals from the **Remote control**.

Technical Information

Specifications

Power supply		AC 100 - 240 V 50 Hz/60 Hz
Power consumption		350 W During standby (when fan is stopped): 4 W
Amps		4.1 A - 1.5 A
LCD panel	Panel size (diagonal)	0.74 type (17.78 mm)
	Aspect ratio	16 : 10
	Display method	3 transparent LCD panels (RGB)
	Drive method	Active matrix method
	Pixels	1 024 000 (1 280 x 800) x 3 panels
Lens		Manual zoom (2x)/Manual focus F 1.7 - 2.6, f 21.6 mm - 43.0 mm
Lamp		UHM lamp (250 W)
Luminosity		3 000 lm
Operating environment		Temperature 0 °C - 40 °C (32 °F - 104 °F) When the HIGHLAND (page 36) is set to ON: 0 °C - 35 °C (32 °F - 95 °F) Humidity 20% - 80% (no condensation)
Scanning frequency*1 (for RGB signal)	Horizontal scanning frequency	15 kHz - 91 kHz
	Vertical scanning frequency	50 Hz - 85 Hz
	Dot clock frequency	Less than 108 MHz
COMPONENT (YPbPr) signals		525i (480i), 525p (480p), 625i (576i), 625p (576p), 750 (720)/60p, 750 (720)/50p, 1 125 (1 080)/60i, 1 125 (1 080)/50i
Color system		7 (NTSC/NTSC 4.43/PAL/PAL-M/PAL-N/PAL60/SECAM)
Projection size		33" - 300" (838.2 mm - 7 620 mm)
Throw distance		1.1 m - 17.2 m (3'7" - 56'5")
Screen aspect ratio		16 : 10
Installation		FRONT/DESK, FRONT/CEILING, REAR/DESK, REAR/CEILING (Menu selection method)
Speaker		1 piece 4 cm (1 - 9/16")
Max. usable volume output		3.0 W

*1. See "List of compatible signals" on page 44 for available signals.

Terminals	S-VIDEO IN	Single - line, Mini DIN 4p Y: 1.0 V [p-p], C: 0.286 V [p-p], 75 Ω
	VIDEO IN	Single - line, RCA pin jack 1.0 V [p-p], 75Ω
	COMPONENT1 IN	Single - line, D - sub HD 15-pin (female) R.G.B. 0.7 V [p-p], 75 Ω TTL high impedance, automatic positive/negative polarity compatible HD, VD/SYNC
	COMPUTER2 IN/ 1 OUT	Single - line, D - sub HD 15-pin (female) Selectable for input and output by menu operation. R.G.B. 0.7 V [p-p], 75 Ω TTL high impedance, automatic positive/negative polarity compatible HD, VD/SYNC
	COMPONENT IN	Y, PB/CB, PR/CR Single - line, RCA pin jack x 3 Y: 1.0 V [p-p] (including sync), 75 Ω PB/CB, (PR/CR) 0.7 V [p-p], 75 Ω
	AUDIO IN	Single - line, 0.5V [rms], RCA pin jack x 2 (L - R)
	COMPUTER AUDIO IN	Dual - line, 0.5V [rms], M3 jack (Stereo MINI)
	VARIABLE AUDIO OUT	Single - line, 0.5V [rms], M3 jack (Stereo MINI) Monitor output/stereo compatible 0 V [rms] - 2.0 V [rms] (variable)
	SERIAL	D-sub 9-pin RS-232C compatible
	REMOTE	D-sub 9-pin For external control
	LAN (RJ-45)	Single - line, For network connection 10 Base-T/100Base-TX/1000Base-T
Wireless LAN	Compatible	IEEE802.11b/IEEE802.11g (Wireless LAN standard protocol)
	Wireless channel	IEEE802.11b/IEEE802.11g: 1 - 13 channels
	Distance	30 m (98'5") Depends on the usage environment
Cabinet		Moulded plastic (PC+ABS)
Dimensions	Width	432 mm (17")
	Height	124.5 mm (4 - 7/8")
	Length	319 mm (12 - 17/32")
Weight	6.2 kg (13.7 lbs.)	
Certifications		UL60950-1 C-UL FCC Class B ICES-003
Remote control	Power supply	3 V DC (AA battery x 2)
	Operating range	Approx. 15 m (49'2") (when operated directly in front of signal receptor)
	Weight	117 g (4.2 ozs.) (including batteries)
	Dimensions	Width 48 mm (1 - 7/8") Length 163 mm (6 - 13/32") Height 24.5 mm (-15/16") (not including surface projection parts)
Options	Ceiling bracket	ET-PKF100H/ET-PKF100S

Technical Information

Screen size and throw distance for 16:9 aspect ratio

Projection size (16 : 9)			Throw distance (L)	
Screen diagonal (SD)	Screen height (SH)	Screen width (SW)	Minimum distance (LW)	Maximum distance (LT)
33" (0.84 m)	0.41 m (1'4")	0.73 m (2'4")		1.9 m (6'2")
40" (1.02 m)	0.50 m (1'7")	0.89 m (2'11")	1.2 m (3'11")	2.3 m (7'6")
50" (1.27 m)	0.62 m (2')	1.11 m (3'7")	1.5 m (4'11")	2.9 m (9'6")
60" (1.52 m)	0.75 m (2'5")	1.33 m (4'4")	1.7 m (5'6")	3.5 m (11'5")
70" (1.78 m)	0.87 m (2'10")	1.55 m (5'1")	2.0 m (6'6")	4.1 m (13'5")
80" (2.03 m)	1.00 m (3'3")	1.77 m (5'9")	2.3 m (7'6")	4.7 m (15'5")
90" (2.29 m)	1.12 m (3'8")	1.99 m (6'6")	2.6 m (8'6")	5.3 m (17'4")
100" (2.54 m)	1.25 m (4'1")	2.21 m (7'3")	2.9 m (9'6")	5.9 m (19'4")
120" (3.05 m)	1.49 m (4'10")	2.66 m (8'8")	3.5 m (11'5")	7.1 m (23'3")
150" (3.81 m)	1.87 m (6'1")	3.32 m (10'10")	4.4 m (14'5")	8.8 m (28'10")
200" (5.08 m)	2.49 m (8'2")	4.43 m (14'6")	5.9 m (19'4")	11.8 m (38'8")
250" (6.35 m)	3.11 m (10'2")	5.53 m (18'1")	7.4 m (24'3")	14.7 m (48'2")
300" (7.62 m)	3.74 m (12'3")	6.64 m (21'9")	8.9 m (29'2")	17.7 m (58')

* All measurements above are approximate and may differ slightly from the actual measurements.

Calculation methods for screen dimensions

You can calculate more detailed screen dimension from the screen diagonal.

$$SW (m) = SD (") \times 0.0221$$

$$SH (m) = SD (") \times 0.0125$$

$$LW (m) = 0.0297 \times SD (") - 0.045$$

$$LT (m) = 0.0592 \times SD (") - 0.061$$

* The results above are approximate and may differ slightly from the actual measurements.

Screen size and throw distance for 4:3 aspect ratio

Projection size (4 : 3)			Throw distance (L)	
Screen diagonal (SD)	Screen height (SH)	Screen width (SW)	Minimum distance (LW)	Maximum distance (LT)
33" (0.84 m)	0.50 m (1'7")	0.67 m (2'2")		2.1 m (6'10")
40" (1.02 m)	0.61 m (2')	0.81 m (2'7")	1.3 m (4'3")	2.6 m (8'6")
50" (1.27 m)	0.76 m (2'5")	1.02 m (3'4")	1.6 m (5'2")	3.2 m (10'5")
60" (1.52 m)	0.91 m (2'11")	1.22 m (4')	1.9 m (6'2")	3.9 m (12'9")
70" (1.78 m)	1.07 m (3'06")	1.42 m (4'7")	2.3 m (7'6")	4.5 m (14'9")
80" (2.03 m)	1.22 m (4')	1.63 m (5'4")	2.6 m (8'6")	5.2 m (17')
90" (2.29 m)	1.37 m (4'5")	1.83 m (6')	2.9 m (9'6")	5.8 m (19')
100" (2.54 m)	1.52 m (4'11")	2.03 m (6'7")	3.2 m (10'5")	6.5 m (21'3")
120" (3.05 m)	1.83 m (6')	2.44 m (8')	3.9 m (12'9")	7.8 m (25'7")
150" (3.81 m)	2.29 m (7'6")	3.05 m (10')	4.9 m (16')	9.8 m (32'1")
200" (5.08 m)	3.05 m (10')	4.06 m (13'3")	6.5 m (21'3")	13.0 m (42'7")
250" (6.35 m)	3.81 m (12'6")	5.08 m (16'8")	8.2 m (26'10")	16.3 m (53'5")
300" (7.62 m)	4.57 m (14'11")	6.10 m (20')	9.8 m (32'1")	19.5 m (63'11")

* All measurements above are approximate and may differ slightly from the actual measurements.

Calculation methods for screen dimensions

You can calculate more detailed screen dimension from the screen diagonal.

$$SW (m) = SD (") \times 0.0203$$

$$SH (m) = SD (") \times 0.0152$$

$$LW (m) = 0.0339 \times SD (") - 0.052$$

$$LT (m) = 0.0653 \times SD (") - 0.052$$

* The results above are approximate and may differ slightly from the actual measurements.

Dimensions

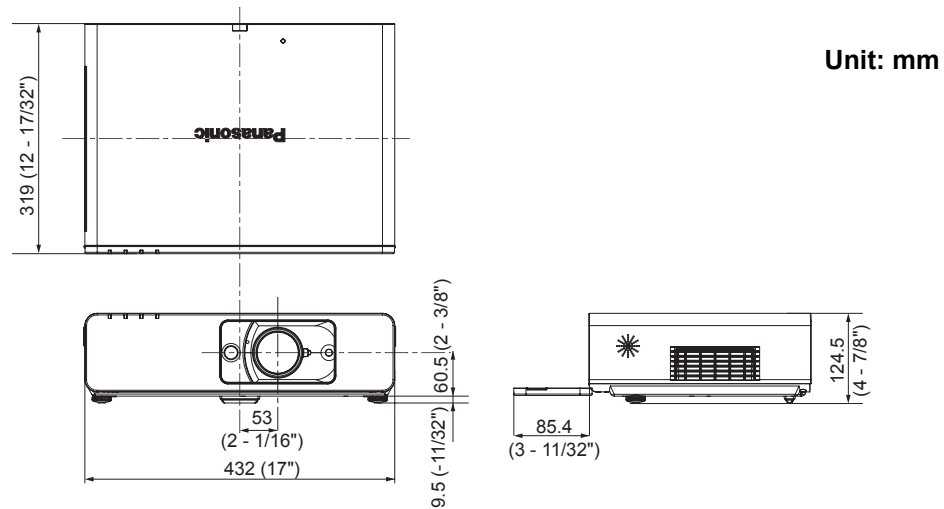

Trademark acknowledgements

- VGA and XGA are trademarks of International Business Machines Corporation.
- S-VGA is a registered trademark of the Video Electronics Standards Association.
- HDMI, the HDMI logo and High-Definition Multimedia Interface are trademarks or registered trademarks of HDMI Licensing LLC.
- The font used in the on-screen displays is a Ricoh bitmap font, which is manufactured and sold by Ricoh Company, Ltd.

All other trademarks are the property of the various trademark owners.

Index

A	
AC IN	13
Accessories	9
Air exhaust port	13
Air intake port	12
ALS (Ambient Luminance Sensor)	12
ARF (Auto Rolling Filter)	
Compartment	13
FILTER indicator	12
FILTER indicator status	39
FILTER REMAINING	34
Replacing	40
ASPECT	32
AUDIO BALANCE	36
AUDIO IN	13
AUTO SETUP	
Menu	35
Remote control	23
Remote control button	11
B	
BACK COLOR	36
Battery compartment	11
BLACKBOARD	36
BRIGHTNESS	30
C	
Calculation methods	
16:10	14
16:9	50
4:3	50
CD-ROM	
Accessories	9
Cleaning	40
CLOCK PHASE	32
CLOSED CAPTION	36
COLOR	30
COLOR TEMPERATURE	30
COMPONENT IN	13
COMPUTER	
Connection guidance	46
Remote control	24
Remote control button	11
COMPUTER AUDIO IN	13
COMPUTER SEARCH	11
COMPUTER1 IN	13
COMPUTER2 IN/1 OUT	13
COMPUTER2 SELECT	34
Connections	18
CONTRAST	30
CONTROL PANEL	35
D	
DAYLIGHT VIEW	30
DEFAULT	
Remote control	25
Remote control button	11
DETAILED SETUP	
OPTION menu	36
PICTURE menu	31
DIGITAL ZOOM	
Remote control	26
Remote control button	11
Dimensions	51
Direct power off	20
DIRECT POWER ON	
Function	20
Menu	35
DOT CLOCK	32
DOUBELE-WINDOW	26
E	
ENTER	
Control panel button	12
Remote control button	11
F	
FILTER REMAINING	34
FILTER SETUP	34
Focus lever	12, 22
FRAME LOCK	33
FREEZE	
Remote control	25
Remote control button	11
Front leg adjusters	13, 15, 22
Front panel cover	12
H	
Hand strap	11
HIGHLAND	36
I	
INDEX-WINDOW	
Remote control	25
Remote control button	11
INITIALISE ALL	36
INPUT GUIDE	34
INPUT PASSWORD	37
INPUT SELECT	
Control panel button	12
Remote control button	11
Selecting	22, 24
INSTALLATION	
Menu	35
Projection method	15
K	
KEYSTONE	32
L	
LAMP	
Indicator	12
Indicator status	39
LAMP RUNTIME	35
Lamp unit compartment	13
Replacing	41
LAN	13
LANGUAGE	28
LASER	
Remote control	24
Remote control button	11
Lens shift lever	12, 16, 22
Lever	
Focus lever	12
Lens shift lever	12
Zoom lever	12

M		SERIAL	13
Mains lead		Basic format	45
Accessories	9	Cable specifications	46
Connecting	20	Communication settings	45
MENU		Connection	45
Control panel button	12	Control commands	46
Main menu	28	Pin assignments	45
Navigation	27	SHARPNESS	30
Remote control button	11	SHUTTER	
N		Remote control	25
Navigation buttons		Remote control button	11
Control panel button	12	SIGNAL SEARCH	35
Remote control button	11	Speaker	12
NETWORK		Specifications	48
Remote control	24	STARTUP LOGO	34
Remote control button	11	STILL MODE	31
NOISE REDUCTION	31	Sub-menu	28
O		S-VIDEO IN	13
OPTION menu	34	SXGA MODE	36
OSD DESIGN	36	T	
P		Technical Information	44
PAGE	11	TEMP	
PASSWORD CHANGE	37	Indicator	12
PICTURE menu	30	Indicator status	39
PICTURE MODE	30	TEST PATTERN	36
POSITION	32	TEXT CHANGE	37
POSITION menu	32	TEXT DISPLAY	37
POWER		Throw distance	
Control panel	12	16:10	14
Indicator	12	16:9	50
Indicator status	20	4:3	50
Remote control button	11	Throwing angle	15
POWER OFF TIMER	35	TINT	30
Projection lens	12	Troubleshooting	43
R		TV-SYSTEM	31
REMOTE	13	V	
LAMP switching	47	VARIABLE AUDIO OUT	13
Pin assignments	47	VIDEO	
Switching input signals	47	Remote control	24
Remote control		Remote control button	11
Accessories	9	VIDEO IN	13
Indicator	11	VOLUME	36
Signal emitter	11	Remote control	26
Signal receptor	12	Remote control button	11
RETURN		W	
Control panel button	12	WHITE BALANCE	31
Remote control button	11	WIDE MODE	36
S		Z	
Safety cable		Zoom lever	12, 22
Accessories	9		
Safeguards	42		
SCREEN FORMAT	35		
Screen size			
16:10	14		
16:9	50		
4:3	50		
Security lock	13		
SECURITY menu	37		

Avis important concernant la sécurité

Cher client Panasonic:

Ce mode d'emploi vous donne toutes les informations concernant l'utilisation de ce projecteur. Nous espérons qu'il vous aidera à utiliser au mieux votre nouvel appareil, et que votre projecteur à cristaux liquides Panasonic vous donnera entière satisfaction. Le numéro de série du produit se trouve au bas du produit. Le noter dans l'espace prévu ci-dessous et conserver ce manuel pour le cas où des réparations seraient nécessaires à l'avenir.

Numéro de modèle: **PT-FW100NTU**

Numéro de série:

AVERTISSEMENT: POUR REDUIRE LES RISQUES DE FEU OU DE CHOC ÉLECTRIQUE, NE PAS EXPOSER CE PRODUIT À L'EAU OU À L'HUMIDITÉ.

Alimentation: Ce projecteur LCD est conçu pour fonctionner sur secteur de 100 V - 240 V, 50 Hz/60 Hz seulement.

ATTENTION: Le cordon d'alimentation secteur fourni avec le projecteur peut être utilisé uniquement pour une alimentation électrique de 125 V, 7 A maximum. Si on veut l'utiliser avec une tension ou un courant plus forts, on doit se procurer un autre cordon d'alimentation de 250 V. Si on utilise le cordon fourni sous ces conditions, risque de provoquer un incendie.

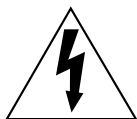

Le symbole de la flèche en forme d'éclair, dans un triangle, avertit l'utilisateur de la présence de «tensions dangereuses» à l'intérieur du produit qui peuvent être de force suffisante pour constituer un risque de choc électrique aux personnes.



Le point d'exclamation dans un triangle avertit l'utilisateur de la présence d'instructions importantes concernant l'utilisation et l'entretien (réparation) dans la littérature accompagnant le produit.

ATTENTION: Cet appareil est équipé d'une fiche de courant à trois broches avec mise à la terre. Ne pas retirer la broche de mise à la masse de la fiche. Cette fiche ne pourra être utilisée que dans une prise avec mise à la terre. Ceci est une précaution sécuritaire. S'il est impossible d'insérer la fiche dans la prise, s'adresser à un électricien. Ne pas annuler la protection de la fiche à mise à la terre.

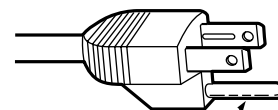

Ne pas retirer

Pursuant to at the directive 2004/108/EC, article 9(2)
Panasonic Testing Centre
Panasonic Service Europe, a division of Panasonic Marketing Europe GmbH
Winsbergring 15, 22525 Hamburg, F.R. Germany

NOTICE:

- Ce produit possède une lampe à décharge haute intensité (DHI) qui contient du mercure. Son élimination peut être réglementée dans votre s à cause de considérations environnementales. Pour d'amples informations sur la mise au rebut ou le recyclage, veuillez contacter vos autorités locales ou aller au site Web de l'Electronics Industries Alliance: <http://www.eiae.org>

AVERTISSEMENT:

Cet équipement a été soumis à des tests qui ont démontré que celui-ci respectait les limites spécifiées pour les appareils numériques de la classe B aux termes de la partie 15 des règles de la FCC (Federal Communications Commission U.S.A.). Ces limites ont pour objet de fournir une protection raisonnable contre les interférences nuisibles dans le cas d'une installation en milieu résidentiel. Cet équipement produit, utilise et peut rayonner de l'énergie de haute fréquence, et s'il n'est pas installé et utilisé conformément aux instructions fournies avec celui-ci, peut provoquer des interférences nuisibles aux communications radio. En outre, même en cas d'utilisation conforme, il n'est pas garanti qu'aucune interférence ne saurait survenir avec certaines installations. Si cet équipement s'avère nuire à la bonne réception d'émissions de radiophonie ou de télévision, ce que l'on pourra déterminer en mettant l'équipement successivement hors tension puis sous tension, il est conseillé de tenter de remédier au problème par l'une des méthodes suivantes:

- Réorientez ou déplacez l'antenne du récepteur;
- Éloignez l'équipement du récepteur;
- Branchez l'équipement dans une prise de courant située sur un circuit autre que celui qui alimente la prise de courant du récepteur;
- Demandez conseil à votre distributeur ou à un technicien de radio/télévision expérimenté.

ATTENTION:

Pour assurer la bonne conformité, utilisez uniquement des câbles d'interface blindés lorsque vous connectez des ordinateurs ou des périphériques. Toute modification non autorisée de cet équipement annulera le droit de l'utilisateur à utiliser cet équipement. Si le port sériel est utilisé pour connecter un ordinateur personnel afin de commander le projecteur depuis l'extérieur, il faut utiliser le câble d'interface sériel en option RS-232C avec une âme en ferrite. Tout changement ou modification non autorisé à cet équipement annule l'autorité de faire fonctionner cet appareil.

Avertissement de la FCC relative à l'exposition RF : (si fourni avec un appareil sans fil)

- Cet équipement est conforme aux limitations concernant l'exposition aux radiations établies par la FCC dans un environnement non contrôlé.
- Cet équipement a été approuvé pour un fonctionnement mobile et requiert de respecter une distance minimum de 20 cm entre l'antenne(s) et toutes les parties de votre corps (sauf les extrémités des mains, poignets et pieds) durant les modes de fonctionnement sans fil.
- Cet équipement ne peut pas être utilisé avec d'autres transmetteurs installés, qui peuvent être capable de transmission simultanée.

ADVERTENCIA:

- Ne peut être utilisé dans une salle d'ordinateurs telle que définie dans la norme ANSI/NFPA 75 Standard for Protection of Electronic Computer/Data Processing Equipment.
- Pour l'équipement branché en permanence, un dispositif de dis connexion d'accès facile doit être incorporé dans le câble d'installation du bâtiment;
- Pour l'équipement bran chable, une prise secteur d'accès facile doit être installée près de l'équipement.

Déclaration de conformité

Modèle n°: PT-FW100NTU
 Désignation commerciale: **Panasonic**
 Fabricant responsable: Panasonic Corporation of North America
 Adresse: One Panasonic Way, Secaucus, New Jersey 07094
 Téléphone: (888) 411 - 1996
 Email: projectorsupport@us.panasonic.com

Cet appareil est conforme à la partie 15 des règles de la FCC (Federal Communications Commission U.S.A.) ce qui signifie: (1) que l'appareil ne produit pas d'interférences nuisibles, et (2) que l'appareil est capable de supporter sans danger les interférences reçues, y compris celles susceptibles de perturber son fonctionnement.

Informations sur l'évacuation des déchets dans les pays ne faisant pas partie de l'Union européenne



Ce symbole n'est reconnu que dans l'Union européenne. Pour vous débarrasser de ce produit, veuillez contacter les autorités locales ou votre revendeur afin de connaître la procédure d'élimination à suivre.

Précautions de sécurité

AVERTISSEMENT

Si l'on remarque une émission de fumée, d'odeurs suspectes ou de bruits provenant du projecteur, débrancher la fiche du cordon d'alimentation de la prise de courant.

- Ne pas continuer d'utiliser le projecteur dans ces cas-là, autrement cela peut entraîner un incendie ou des chocs électriques.
- Après s'être assuré que de la fumée ne se dégage plus, s'adresser à un centre technique agréé et demander que les réparations nécessaires soient faites.
- Le fait de réparer le projecteur soi-même est très dangereux, et ne doit jamais être fait.

Ne pas installer ce projecteur dans un endroit qui n'est pas assez résistant pour supporter le poids du projecteur.

- Si l'emplacement d'installation n'est pas assez résistant, le projecteur risque de tomber et causer de graves blessures et (ou) des dommages.

Demander à un technicien qualifié d'installer le projecteur par exemple s'il est installé au plafond.

- Si l'installation n'est pas faite correctement, cela peut entraîner des blessures ou des chocs électriques.
- Ne pas utiliser un support de montage au plafond qui n'est pas agréé.

Si de l'eau ou des objets étrangers pénètrent dans le projecteur, si le projecteur tombe, ou si le boîtier est endommagé, débrancher immédiatement la fiche du cordon d'alimentation de la prise de courant.

- Si l'on continue d'utiliser le projecteur dans cette condition, cela peut entraîner un incendie ou des chocs électriques.
- S'adresser à un centre technique agréé pour que les réparations nécessaires puissent être faites.

Ne pas surcharger la prise de courant.

- Si l'alimentation est surchargée (par exemple, par l'utilisation de trop d'adaptateurs), cela risque de faire surchauffer le projecteur et peut entraîner un incendie.

Ne jamais entreprendre toute modification quelconque ou démontage du projecteur.

- Des hautes tensions qui peuvent causer de graves blessures sont présentes à l'intérieur du projecteur.
- Pour toute inspection, réglage ou réparation, s'adresser à un centre technique agréé.

Nettoyer la fiche du cordon d'alimentation régulièrement afin d'éviter toute accumulation de poussière.

- Si de la poussière s'accumule sur la fiche du cordon d'alimentation, l'humidité peut endommager l'isolant et entraîner un incendie. Débrancher la fiche du cordon d'alimentation de la prise de courant et l'essuyer avec un tissu sec.
- Si le projecteur n'est pas utilisé pendant une période prolongée, débrancher la fiche du cordon d'alimentation de la prise de courant.

Faire attention à ne pas endommager le cordon d'alimentation.

- Ne pas endommager le cordon d'alimentation, ne pas le modifier, ne pas le placer sous des objets lourds, ne pas le chauffer, ne pas le placer près d'objets chauffants, ne pas le tordre, ne pas le plier ou le tirer excessivement et ne pas le rouler en boule.
- Si le cordon d'alimentation est endommagé, cela peut entraîner un incendie et des chocs électriques.
- Si le cordon d'alimentation est endommagé, le faire réparer par un centre technique agréé.

Ne pas manipuler le cordon d'alimentation avec les mains mouillées.

- Cela peut entraîner des chocs électriques.

Brancher la fiche du cordon d'alimentation fermement dans la prise de courant.

- Si la fiche n'est pas complètement insérée, cela peut entraîner des chocs électriques ou la faire surchauffer.
- Si la fiche est endommagée ou la plaque de la prise desserrée, celles-ci ne devraient pas être utilisées.

Ne pas placer le projecteur sur des surfaces instables.

- Si le projecteur est placé sur une surface qui est inclinée ou instable, il risque de tomber ou de se renverser et cela peut causer des blessures ou des dommages.

Ne pas placer le projecteur dans l'eau ou ne pas le laisser se mouiller.

- Sinon cela peut causer un incendie ou des chocs électriques.

Ne pas placer le projecteur sur des matériaux comme du tapis ou du tissu éponge.

- Cela peut provoquer une surchauffe du projecteur, pouvant entraîner des brûlures, un incendie ou endommager le projecteur.

Ne pas placer des récipients de liquide sur le projecteur.

- Si de l'eau se renverse sur le projecteur ou pénètre dans celui-ci, il y aura risque d'incendie ou d'électrocution.
- Si de l'eau entre à l'intérieur du projecteur, entrer en contact avec un centre technique agréé.

Ne pas mettre d'objets étrangers dans le projecteur.

- Ne pas insérer d'objets métalliques ou inflammables dans les orifices de ventilation ou les faire tomber sur le projecteur, car cela peut causer un incendie ou des chocs électriques.

Veiller à ce que les bornes + et – des piles n'entrent pas en contact avec des objets métalliques tels que colliers ou épingles à cheveux.

- Sinon, les piles risquent de fuir, de surchauffer, d'exploser ou de prendre feu.
- Ranger les piles dans un sac en plastique, et ne pas les ranger à proximité d'objets métalliques.

Ne pas toucher le liquide provenant des fuites des piles.

- Si vous touchez le liquide des fuites, cela pourrait abîmer votre peau. Enlever le liquide à l'eau claire et rechercher immédiatement le secours d'un médecin.
- Si vous recevez du liquide des fuites dans les yeux, cela pourrait provoquer la cécité ou des blessures. Ne pas vous frotter les yeux, enlever le liquide à l'eau claire et rechercher immédiatement le secours d'un médecin.

Pendant un orage, ne pas toucher le projecteur ou le câble.

- Il y a risque d'électrocution.

Ne pas utiliser l'appareil dans un bain ou une douche.

- Il y a risque d'incendie ou d'électrocution.

Veillez à ce que le faisceau lumineux n'éclaire pas directement votre peau pendant que vous utilisez le projecteur.

- Une lumière intense est émise par l'objectif du projecteur. Si vous vous placez dans ce faisceau lumineux, celui-ci risquera de vous blesser ou de vous abîmer la peau.

Ne pas regarder directement dans l'objectif pendant que le projecteur fonctionne.

- Une lumière intense est émise par l'objectif du projecteur. Si l'on regarde directement dans cette lumière, elle risque de causer des blessures et de graves lésions aux yeux.
- Veiller particulièrement à ce que les enfants ne regardent pas dans l'objectif. En outre, éteindre le projecteur si on le laisse sans surveillance.

MISES EN GARDE

Ne pas obstruer les orifices d'entrée et de sortie d'air.

- Cela risque de faire surchauffer le projecteur, et causer un incendie ou endommager le projecteur.
- Ne pas installer le projecteur dans des endroits étroits, mal ventilés tels que des placards ou des étagères.
- Ne pas placer le projecteur sur des tissus ou du papier, ces matériaux peuvent être aspirés dans l'orifice d'entrée d'air.

Débrancher toujours tous les câbles avant de déplacer le projecteur.

- Le fait de déplacer le projecteur avec des câbles branchés peut endommager les câbles, ce qui pourrait causer un incendie ou des chocs électriques.

Ne pas placer les mains ou autres objets près de l'orifice de sortie d'air.

- De l'air chaud sort par l'orifice de sortie d'air. Ne pas placer les mains, le visage ou d'autres objets qui ne peuvent résister à la chaleur près de cette sortie d'air [laisser un espace d'au moins 50 cm], sinon des brûlures ou des dommages risqueraient de s'ensuivre.

Le remplacement de la lampe ne doit être effectué que par un technicien qualifié.

- La lampe a une pression interne élevée. Si elle est manipulée incorrectement, une explosion peut s'ensuivre.
- La lampe peut être facilement endommagée si elle est heurtée contre des objets durs ou si on la laisse tomber et des blessures et des mauvais fonctionnements peuvent s'ensuivre.

Lors du remplacement de la lampe, la laisser refroidir pendant au moins une heure avant de la manipuler.

- Le couvercle de la lampe devient très chaud, et on risque de se brûler si on le touche.

Avant de remplacer la lampe, veiller à débrancher la fiche du cordon d'alimentation de la prise de courant.

- Il y a risque d'électrocution ou d'explosion.

Ne pas laisser des enfants ou des animaux domestiques toucher la télécommande.

- Après avoir utilisé la télécommande, la ranger hors de portée des enfants ou des animaux domestiques.

Ne pas installer le projecteur dans des endroits humides ou poussiéreux ou dans des endroits où le projecteur peut entrer en contact avec des fumées grasses ou de la vapeur.

- L'utilisation du projecteur dans de telles conditions peut causer un incendie, des chocs électriques ou une détérioration du boîtier en plastique. Une détérioration du plastique risquerait en effet d'entraîner une chute du projecteur en cas d'installation au plafond.

Ne pas installer le projecteur dans un environnement à haute température, tel qu'à proximité d'un chauffage ou en plein soleil.

- Sinon cela peut causer un incendie, un dysfonctionnement ou une détérioration du plastique.

Précautions de sécurité

Pour débrancher le cordon d'alimentation, tenir la fiche et non pas le cordon.

- Si le cordon d'alimentation est tiré, le cordon sera endommagé et cela peut causer un incendie, des courts-circuits ou des chocs électriques sérieux.

Ne pas placer d'objets lourds sur le projecteur.

- Cela peut déséquilibrer le projecteur et le faire tomber, ce qui peut entraîner des dommages ou des blessures.

Ne pas court-circuiter, chauffer ou démonter les piles, et ne pas les mettre dans l'eau ou dans le feu.

- Sinon, les piles risqueront de surchauffer, de fuir, d'exploser ou de prendre feu, et donc de causer des brûlures ou d'autres blessures.

Lorsqu'on insère les piles, veiller à ce que les polarités (+ et -) soient bien respectées.

- Si l'on insère les piles incorrectement, elles risquent d'exploser ou de fuir, ce qui peut causer un incendie, des blessures ou une contamination du logement des piles et de la zone environnante.

Utiliser uniquement les piles spécifiées.

- Si l'on insère des piles d'un type différent, elles risquent d'exploser ou de fuir, ce qui peut causer un incendie, des blessures ou une contamination du logement des piles et de la zone environnante.

Ne pas mélanger des piles usées et des piles neuves.

- Si l'on insère les piles incorrectement, elles risquent d'exploser ou de fuir, ce qui peut causer un incendie, des blessures ou une contamination du logement des piles et de la zone environnante.

Si l'on n'utilise pas le projecteur pendant une période prolongée, débrancher la fiche du cordon d'alimentation de la prise de courant et retirer les piles de la télécommande.

- Si de la poussière s'accumule sur la fiche du cordon d'alimentation, l'humidité ainsi créée risquera d'endommager l'isolation, ce qui peut provoquer un incendie.
- Le fait de laisser les piles à l'intérieur de la télécommande pendant trop longtemps en cas d'inactivité risque de causer une dégradation de l'isolation, une fuite de courant ou même des explosions, ce qui pourrait causer un incendie.

Nous faisons tous les efforts possibles afin de préserver l'environnement. Prière de rapporter l'appareil, s'il n'est pas réparable, à votre revendeur ou à un centre de recyclage.

Ne pas peser de tout son poids sur ce projecteur.

- On risque de tomber ou de casser l'appareil, ce qui peut causer des blessures.
- Veiller tout particulièrement à ce que les enfants ne se tiennent pas debout ou ne s'asseyent pas sur le projecteur.

Retirer rapidement les piles de la télécommande.

- Si vous laissez des piles usagées dans la télécommande pendant une longue période, cela risque de provoquer des fuites, une hausse anormale de la température interne ou une explosion.

Si la lampe s'est cassée, ventiler immédiatement la pièce. Ne pas toucher ni approcher le visage des morceaux cassés.

- Le non respect de cette consigne peut entraîner l'absorption du gaz par l'utilisateur. Ce gaz se dégage lorsque la lampe est cassée et il contient presque autant de mercure qu'une lampe fluorescente, de plus les morceaux cassés peuvent provoquer des blessures.
- Si vous pensez avoir inhalé du gaz ou que du gaz a pénétré dans votre bouche ou dans vos yeux, contactez un médecin immédiatement.
- S'adresser au revendeur pour le remplacement de la lampe et l'inspection de l'intérieur du projecteur.

Débrancher la fiche du cordon d'alimentation de la prise de courant comme mesure de sécurité avant d'effectuer tout nettoyage.

- Sinon cela peut causer des chocs électriques.

Demander à un centre technique agréé de nettoyer l'intérieur du projecteur au moins une fois par an.

- S'il n'est pas nettoyé et que de la poussière s'accumule à l'intérieur du projecteur, cela peut causer un incendie ou des problèmes de fonctionnement.
- Il est recommandé de nettoyer l'intérieur du projecteur avant l'arrivée de la saison humide. Demander au centre technique agréé le plus proche de nettoyer le projecteur lorsque cela est requis. Se renseigner auprès du centre technique agréé pour le coût du nettoyage.

Précautions lors du transport

Ne pas soumettre le projecteur à des vibrations ou des chocs excessifs.

- L'objectif du projecteur doit être manipulé avec soin.
- Placer le couvercle sur l'objectif lors du transport du projecteur.

Lors du transport du projecteur, bien le tenir par le bas.

- Ne pas tenir le projecteur par les pieds de réglage ou le couvercle supérieur pour le déplacer car cela pourrait l'endommager.

Précautions lors de l'installation

Éviter de l'installer dans les endroits sujets à des vibrations ou à des chocs.

- Les pièces internes peuvent être endommagées, ce qui peut causer des pannes ou des accidents.

Éviter d'installer le projecteur à des endroits sujets à des changements de température brusques, à proximité d'un climatiseur ou d'un matériel d'éclairage.

- La durée de vie de la lampe risquerait d'être réduite, ou le projecteur risquerait de s'éteindre. « Indicateur TEMP » à la page 41.

Ne pas installer le projecteur près de lignes d'alimentation électrique à haute tension ou de moteurs.

- Le projecteur peut être soumis à des interférences électromagnétiques.

Si le projecteur est installé au plafond, demander à un technicien qualifié de faire tous les travaux d'installation.

- Il faut acheter le kit d'installation séparé (numéro de modèle: ET-PKF100H, ET-PKF100S). En outre, tous les travaux d'installation doivent être exécutés uniquement par un technicien qualifié.
- Voir « Protections du support de montage au plafond » à la page 44 pour plus de détails à propos de l'installation du **Câble de sécurité**.

Si l'on utilise ce projecteur à un endroit élevé (au dessus de 1 400 m), régler MONTAGNE sur OUI. Voir « MONTAGNE » à la page 38.

- Le non-respect de ces consignes peut entraîner un dysfonctionnement ou peut raccourcir la durée de vie de la lampe ou d'autres composants.

Précautions lors de l'utilisation

Afin d'obtenir la meilleure qualité d'image

- Fermer les rideaux ou les volets de toutes les fenêtres et éteindre les lampes fluorescentes situées à proximité de l'écran afin que la lumière extérieure ou la lumière des lampes intérieures n'éclaire pas l'écran.

Ne pas toucher aux surfaces de l'objectif ou du verre avant avec les mains nues.

- Si la surface de l'objectif est salie par des empreintes digitales ou autre, celles-ci seraient agrandies et projetées sur l'écran. De plus, refermer le **Couvercle du panneau avant** lorsque le projecteur n'est pas utilisé.

Affichage à cristaux liquides

- Ne pas projeter la même image pendant une longue durée, car elle risquerait de former une après-image sur l'affichage à cristaux liquides.
- L'affichage à cristaux liquides du projecteur a été fabriqué en utilisant une technologie de haute précision afin d'offrir une image très détaillée. Il est possible que parfois quelques pixels figés apparaissent sur l'écran sous forme de points fixes bleus, verts ou rouges. Il est alors recommandé d'éteindre le projecteur puis de le rallumer environ 1 heure après. Bien noter que ceci n'affecte pas le bon fonctionnement de votre LCD.

Écran

- N'appliquer aucun produit volatil qui risque de décolorer l'écran, et veiller à ce que l'écran ne soit pas sale ou endommagé.

Le projecteur possède une lampe au mercure à haute pression interne avec les caractéristiques suivantes.

- La luminosité de la lampe dépend de la durée d'utilisation.
- Des chocs ou des écaillages sur la lampe pourraient la faire exploser ou écourter la durée de vie de la lampe.
- La lampe pourrait exploser occasionnellement après l'utilisation du projecteur.
- La lampe pourrait exploser si le projecteur est utilisé après le délai conseillé de remplacement de la lampe.
- La durée de vie de la lampe dépend des caractéristiques individuels de la lampe, des conditions d'utilisation et de l'environnement d'installation. L'utilisation consécutive pendant plus de 10 heures du projecteur ou de la commutation fréquente peuvent en particulier affecter considérablement la durée de vie de la lampe.

Composants optiques

- Si vous utilisez la lampe 6 heures consécutivement chaque jour, les composants optiques pourraient nécessiter un remplacement dans moins d'un an.

Remplacement de l'unité de la lampe

■ Avant de remplacer le l'Unité de la lampe

- Éteindre l'**ALIMENTATION PRINCIPALE** puis débrancher le cordon principal de la prise du secteur.
- Vérifier que l'**Unité de la lampe** ainsi que les pièces autour aient eu le temps de refroidir.
- Préparer un tournevis cruciforme.
- Contacter un centre de service après-vente agréé pour acheter une **Unité de la lampe** (ET-LAF100) de rechange.
- En cas d'installation du projecteur au plafond, ne jamais travailler directement dessous et éloigner le visage du projecteur.

REMARQUE:

- Avant de remplacer la lampe, la laisser refroidir pour éviter les risques de brûlures, les dommages et autres dangers.
- Ne pas essayer de la remplacer par une lampe non autorisée.

■ Délai de remplacement de l'Unité de la lampe

L'**Unité de la lampe** est un consommable et sa luminosité diminue avec la durée d'utilisation. L'indicateur **LAMPE** vous informera des délais de remplacement de 2800 heures, et coupera le projecteur à 3000 heures. Ces valeurs sont fournies avant tout à titre indicatif et peuvent être réduites en fonction des conditions d'utilisation réelles, des caractéristiques de l'**Unité de la lampe**, de la température ambiante, etc. Vous pouvez **DURÉE DE LA LAMPE** dans le menu **OPTION**.

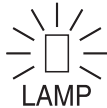
Indication	A l'écran	Indicateur LAMPE
Plus de 2 800 heures		
Plus de 3 000 heures	<p>«REEMPLACER LA LAMPE» s'affiche en haut à gauche de l'écran, et attend votre réponse. Pour le supprimer immédiatement, appuyer sur n'importe quelle touche.</p>	S'allume en ROUGE .

REMARQUE:

- Les durées indiquées, de 2800 et 3000 heures, sont des estimations basé sur certaines conditions et ne représentent en aucun cas des durées garanties.
- Pour plus d'informations à propos des caractéristiques de l'**Unité de la lampe**, telles que la durée de garantie, se reporter aux instructions fournies avec l'**Unité de la lampe**.
- Lorsque la durée d'utilisation de la lampe dépasse 3000 heures, le projecteur passera en mode de veille après environ 10 minutes d'utilisation.

■ Procédure de remplacement

● Retirer et remplacer la lampe

1. Dévisser à l'aide d'un tournevis cruciforme les 3 vis de fixation du **Couvercle de la lampe** à l'arrière du projecteur jusqu'à ce qu'elles tournent librement, puis retirer le **Couvercle de la lampe**.

Couvercle de la l'Unité de la lampe

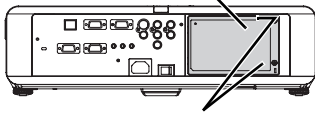

Vis de fixation du couvercle de l'Unité de la lampe

2. Dévisser les 2 vis de fixation de l'**Unité de la lampe** à l'aide du tournevis cruciforme.
3. Tenir l'**Unité de la lampe** par la poignée puis débloquer le verrou de la lampe.
4. Extraire doucement l'**Unité de la lampe** du projecteur.

Vis de fixation de l'Unité de la lampe

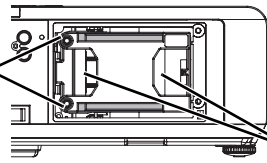

Poignées

5. Remettre la nouvelle **Unité de la lampe** à son emplacement.

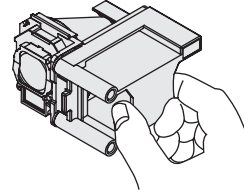

6. Appuyer sur l'**Unité de la lampe** jusqu'à ce qu'elle s'encliquète et s'assurer qu'elle soit bien fixée en place.
7. Resserrer les 2 vis de fixation de l'**Unité de la lampe** à l'aide du tournevis cruciforme.

Vis de fixation de l'Unité de la lampe

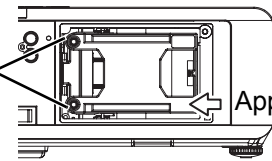

Appuyer ici

8. Fixer le **Couvercle de la lampe** puis resserrer les 3 vis du **Couvercle de la lampe** à l'aide du tournevis cruciforme.

■ Protections du support de montage au plafond

Bien que le projecteur ainsi que le support d'installation au plafond aient été conçus pour répondre aux plus hauts critères de sécurité, il est néanmoins recommandé d'installer et d'attacher au bas du projecteur le câble de sécurité fourni, en cas d

REMARQUE:

- Pendant toute la durée de la garantie, le fabricant ne pourrait en aucun cas être tenu pour responsable de tout danger ou dommages causés soit par l'utilisation d'un support au plafond non conforme, acheté auprès de distributeurs non autorisés, soit par ses conditions d'utilisation.
- N'utiliser qu'un tournevis dynamométrique durant l'installation, et ne jamais utiliser un tournevis électrique ou un tournevis à frapper.
- Les travaux d'installation du support au plafond ne devront être effectués que par un technicien qualifié.
- Démontez au plus vite tout support au plafond qui ne sera plus utilisé.

■ Installation du câble de sécurité

1. Installer le support de montage au plafond en suivant les consignes d'installation.
2. Faire passer la boucle du câble à l'aide d'un verrou en le bouclant par l'autre extrémité.
 - Attacher une des extrémités du câble à l'aide d'un verrou en le bouclant par l'autre extrémité.
3. Fixer le verrou au bas du projecteur à l'aide de la vis fournie.
 - Couple: 1.25 ± 0.2 N·m

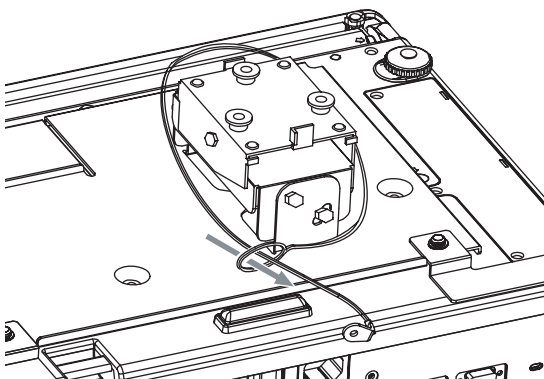

*Ceci vaut pour le ET-PKF100S.

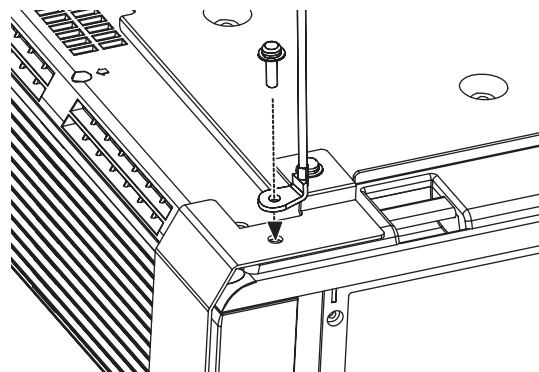

NOTE:

This product contains a CR Coin Cell Lithium Battery which contains Perchlorate Material - special handling may apply.

See www.dtsc.ca.gov/hazardouswaste/perchlorate.

Panasonic[®]

Projectors

Panasonic Projector Systems Company

Unit of Panasonic Corporation of North America

One Panasonic Way, Secaucus, NJ 07094
(201) 392 - 6591

Technical Support:

(888) 411 - 1996

FAX: (201) 348 - 7523

E-Mail: projectorsupport@us.panasonic.com

© 2007 Matsushita Electric Industrial Co., Ltd. All Rights Reserved.

Printed in Japan
S0507-1067B