

myprojectorlamps.com

**The most trusted, dependable name
in projector lamp sales.**



<http://www.myprojectorlamps.com>



<http://www.myprojectorlamps.ca>



<http://www.myprojectorlamps.eu>

The following projector manual has not been modified or altered in any way.

Panasonic®

Operating Instructions

LCD Projector **Commercial Use**

Model No.

PT-F300NTU

PT-F300U

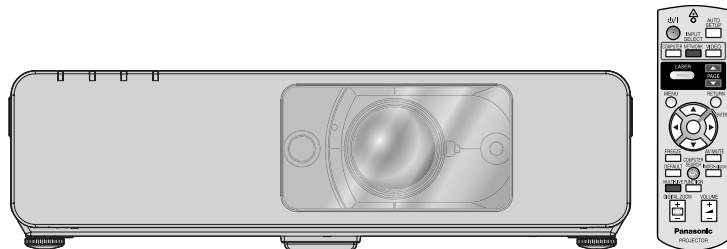

(PT-F300NTU)

Before operating this product, please read the instructions carefully and save this manual for future use.

TQBJ0279-1

ENGLISH

Important Safety Notice

Dear Panasonic Customer:

The following information should be read and understood as it provides details, which will enable you to operate the projector in a manner which is both safe to you and your environment, and conforms to legal requirements regarding the use of projectors. Before connecting, operating or adjusting this projector, please read these instructions completely and save this booklet with the projector for future reference. We hope it will help you to get the most out of your new product, and that you will be pleased with your Panasonic LCD projector.

The serial number of your product may be found on its bottom. You should note it in the space provided below and retain this booklet in case service is required.

Model number: PT-F300NTU/PT-F300U

Serial number:

WARNING: TO REDUCE THE RISK OF FIRE OR ELECTRIC SHOCK, DONOT EXPOSE THIS PRODUCT TO RAIN OR MOISTURE.

Power Supply: This LCD Projector is designed to operate on 100 V - 240 V, 50 Hz/60 Hz AC, house current only.

CAUTION: The AC power cord which is supplied with the projector as an accessory can only be used for power supplies up to 125 V, 7 A. If you need to use higher voltages or currents than this, you will need to obtain a separate 250 V power cord. If you use the accessory cord in such situations, fire may result.



The lightning flash with arrowhead symbol, within an equilateral triangle, is intended to alert the user to the presence of uninsulated "dangerous voltage" within the product's enclosure that may be of sufficient magnitude to constitute a risk of electric shock to persons.



The exclamation point within an equilateral triangle is intended to alert the user to the presence of important operating and maintenance (servicing) instructions in the literature accompanying the product.

CAUTION: This equipment is equipped with a three-pin grounding-type power plug. Do not remove the grounding pin on the power plug. This plug will only fit a grounding-type power outlet. This is a safety feature. If you are unable to insert the plug into the outlet, contact an electrician. Do not defeat the purpose of the grounding plug.

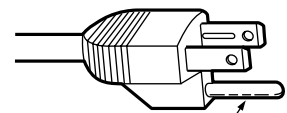

Do not remove

Pursuant to at the directive 2004/108/EC, article 9(2)
 Panasonic Testing Center
 Panasonic Service Europe, a division of Panasonic Marketing Europe GmbH
 Winsbergring 15, 22525 Hamburg, F.R. Germany

NOTICE:

- This product has a High Intensity Discharge (HID) lamp that contains mercury. Disposal may be regulated in your community due to environmental considerations. For disposal or recycling information, please contact your local authorities, or the Electronic Industries Alliance: <http://www.eiae.org>

WARNING:

This equipment has been tested and found to comply with the limits for a Class B digital device, pursuant to Part 15 of the FCC Rules. These limits are designed to provide reasonable protection against harmful interference in a residential installation. This equipment generates, uses and can radiate radio frequency energy and, if not installed and used in accordance with the instructions, may cause harmful interference to radio communications. However, there is no guarantee that interference will not occur in a particular installation. If this equipment does cause harmful interference to radio or television reception, which can be determined by turning the equipment off and on, the user is encouraged to try to correct the interference by one or more of the following measures:

- Reorient or relocate the receiving antenna.
- Increase the separation between the equipment and receiver.
- Connect the equipment into an outlet on a circuit different from that to which the receiver is connected.
- Consult the dealer or an experienced radio/TV technician for help.

FCC CAUTION: To assure continued compliance, follow the attached installation instructions and use only shielded interface cables when connecting to computer and/or peripheral devices. Any changes or modifications not expressly approved by Panasonic Corp. of North America could void the user's authority to operate this device.

FCC RF Exposure Warning: (if provided with wireless device)

- This equipment complied with FCC radiation exposure limits set forth for an uncontrolled environment.
- This equipment has been approved for mobile operation and requires minimum 20 cm spacing be provided between antenna(s) and all person's body (excluding extremities of hands, wrist and feet) during wireless modes of operation.
- This equipment may not be used with other installed transmitters, which may be capable of simultaneous transmission.

WARNING:

- Not for use in a computer room as defined in the Standard for the Protection of Electronic Computer/Data Processing Equipment, ANSI/NFPA 75.
- For permanently connected equipment, a readily accessible disconnect device shall be incorporated in the building installation wiring.
- For pluggable equipment, the socket-outlet shall be installed near the equipment and shall be easily accessible.

Declaration of Conformity

Model Number: PT-F300NTU/PT-F300U
 Trade Name: **Panasonic**
 Responsible party: Panasonic Corporation of North America
 Address: One Panasonic Way, Secaucus, New Jersey 07094
 Telephone number: (888) 411 - 1996
 E-mail: projectorsupport@us.panasonic.com

This device complies with Part 15 of the FCC Rules. Operation is subject to the following two conditions: (1) This device may not cause harmful interference, and (2) this device must accept any interference received, including interference that may cause undesired operation.

Information on Disposal in other Countries outside the European



These symbols are only valid in the European Union.

If you wish to discard this product, please contact your local authorities or dealer and ask for the correct method of disposal.



Contents

Quick steps

1. Set up your projector
See “Setting up” on page 15.



2. Connect with other devices
See “Connections” on page 19.



3. Prepare the Remote control
See “Remote control” on page 14.



4. Start projecting
See “Switching the projector on/off” on page 21.



5. Adjust the image
See “Menu Navigation” on page 30.

- **When you start the projection for the first time, the minimum required setting screen for projection will be displayed.**
See “Minimum required setting screen” on page 11.

Important Information

Important Safety Notice	2
Precautions with regard to safety	6
WARNINGS	6
CAUTIONS	7
Cautions when transporting	8
Cautions when installing	8
Cautions on use	9
Security	9
Accessories	10

Preparation

Read this first	11
Minimum required setting screen	11
About Your Projector	12
Projector body	12
Remote control	14

Getting Started

Setting up	15
Screen size and throw distance	15
Projection method	16
Front leg adjusters and throwing angle	16
Lens shift and positioning	17
Connections	19
Before connection to the projector	19
Connecting example: Computers	19
Connecting example: AV equipment	20

Basic Operation

Switching the projector on/off	21
Power cord	21
Power indicator	22
Switching on the projector	23
Switching off the projector	23
Projecting an image	24
Selecting the input signal	24
Positioning the image	24
Remote control operation	25
Operating range	25
Setting up the image position automatically	25
Switching the input signal	26
Enlarging the centered area	26
Capturing an image	27
Stopping the projection	27
Resetting to the factory default settings	27
Projecting an image in INDEX-WINDOW mode	27
Using an assigned function	28
Using the laser pointer	28
Controlling the volume of the speaker	29

Settings	
Menu Navigation	30
Main menu and Sub-menu	30
Navigating through the menu	32
PICTURE menu	33
PICTURE MODE	33
CONTRAST	33
BRIGHTNESS	33
COLOR	33
TINT	33
SHARPNESS	33
WHITE BALANCE RED	33
WHITE BALANCE GREEN	33
WHITE BALANCE BLUE	33
COLOR TEMPERATURE	34
DAYLIGHT VIEW	34
DIGITAL CINEMA REALITY	34
NOISE REDUCTION	34
TV-SYSTEM	34
RGB/YPbPr	34
POSITION menu	35
KEYSTONE	35
SHIFT	35
DOT CLOCK	35
CLOCK PHASE	35
OVER SCAN	35
ASPECT	36
FRAME LOCK	37
DISPLAY OPTION menu	38
ON-SCREEN DISPLAY	38
DVI-D IN	38
CLOSED CAPTION SETTING	38
STARTUP LOGO	39
AUTO SETUP	39
SIGNAL SEARCH	39
BACK COLOR	39
WIDE MODE	39
SXGA MODE	39
OTHER FUNCTIONS	40
PROJECTOR SETUP menu	41
STATUS	41
COMPUTER2 SELECT	41
NO SIGNAL SHUT-OFF	41
INITIAL START UP	41
INSTALLATION	42
HIGH ALTITUDE MODE	42
EMULATE	42
FUNCTION BUTTON	42
AUDIO SETTING	42
TEST PATTERN	43
INITIALIZE ALL	43
FILTER COUNTER RESET	43
SECURITY menu	44
PASSWORD	44
PASSWORD CHANGE	44
TEXT DISPLAY	44
TEXT CHANGE	44
MENU LOCK	45
MENU LOCK PASSWORD	45
CONTROL DEVICE SETUP	45
NETWORK menu	46
Items in NETWORK menu	46

Maintenance	
TEMP, LAMP and FILTER Indicators	47
Managing the indicated problems	47
Care and Replacement	48
Cleaning the projector	48
Replacing the Lamp unit	48
Replacing the Auto Cleaning Filter (ACF)	49
Troubleshooting	51
Appendix	
Technical Information	52
List of compatible signals	52
Serial terminal	53
Computer connection guidance	54
REMOTE terminal	55
DVI-D IN terminal	56
Ceiling mount bracket safeguards	56
Screen size and throw distance for 16:9 aspect ratio	57
Specifications	58
Dimensions	60
Trademark acknowledgements	60
Index	61
Avis important concernant la sécurité	63
Précautions de sécurité	65
AVERTISSEMENT	65
MISES EN GARDE	66
Précautions lors du transport	67
Précautions lors de l'installation	67
Précautions lors de l'utilisation	67
Sécurité	68
Remplacement de l'unité de la lampe	69
Protections du support de montage au plafond	70

Important Information

Preparation

Getting Started

Basic Operation

Settings

Maintenance

Appendix

Precautions with regard to safety

WARNINGS

If you notice smoke, strange smells or noise coming from the projector, disconnect the power plug from the wall outlet.

- Do not continue to use the projector in such cases, otherwise fire or electric shocks could result.
- Check that no more smoke is coming out, and then contact an Authorized Service Center for repairs.
- Do not attempt to repair the projector yourself, as this can be dangerous.

Do not install this projector in a place which is not strong enough to take the full weight of the projector.

- If the installation location is not strong enough, it may fall down or tip over, and severe injury or damage could result.

Installation work (such as ceiling suspension) should only be carried out by a qualified technician.

- If installation is not carried out correctly, there is the danger that injury or electric shocks may occur.
- Do not use other than an authorized ceiling mount bracket.

If foreign objects or water get inside the projector, or if the projector is dropped or the cabinet is broken, disconnect the power plug from the wall outlet.

- Continued use of the projector in this condition may result in fire or electric shocks.
- Contact an Authorized Service Center for repairs.

The wall outlet shall be installed near the equipment and shall be easily accessible.

- Unplug the power plug from the wall outlet immediately when problem occurred.

Do not overload the wall outlet.

- If the power supply is overloaded (for example, by using too many adapters), overheating may occur and fire may result.

Never attempt to modify or disassemble the projector.

- High voltages can cause fire or electric shocks.
- For any inspection, adjustment and repair work, please contact an Authorized Service Center.

Clean the power plug regularly to prevent it from becoming covered in dust.

- If dust builds up on the power plug, the resulting humidity can damage the insulation, which could result in fire. Pull the power plug out from the wall outlet and wipe it with a dry cloth.
- If not using the projector for an extended period of time, pull the power plug out from the wall outlet.

Do not handle the power plug with wet hands.

- Failure to observe this may result in electric shocks.

Insert the power plug securely into the wall outlet.

- Do not use other than the provided power cord.
- If the plug is not inserted correctly, electric shocks or overheating could result.
- Do not use plugs which are damaged or wall outlets which are coming loose from the wall.

Do not place the projector on top of surfaces which are unstable.

- If the projector is placed on top of a surface which is sloped or unstable, it may fall down or tip over, and injury or damage could result.

Do not place the projector into water or let it become wet.

- Failure to observe this may result in fire or electric shocks.

Do not do anything that might damage the power cord or the power plug.

- Do not damage the power cord, make any modifications to it, place it near any hot objects, bend it excessively, twist it, pull it, place heavy objects on top of it or wrap it into a bundle.
- If the power cord is used while damaged, electric shocks, short-circuits or fire may result.
- Ask an Authorized Service Center to carry out any repairs to the power cord that might be necessary.

Do not place the projector on soft materials such as carpets or sponge mats.

- Doing so may cause the projector to overheat, which can cause burns, fire or damage to the projector.

Do not place liquid containers on top of the projector.

- If water spills onto the projector or gets inside it, fire or electric shocks could result.
- If any water gets inside the projector, contact an Authorized Service Center.

Do not insert any foreign objects into the projector.

- Do not insert any metal objects or flammable objects into the projector or drop them onto the projector, as doing so can result in fire or electric shocks.

Do not allow the + and - terminals of the batteries to come into contact with metallic objects such as necklaces or hairpins.

- Failure to observe this may cause the batteries to leak, overheat, explode or catch fire.
- Store the batteries in a plastic bag and keep them away from metallic objects.

Precautions with regard to safety

Do not touch the leaked liquid from the batteries.

- If you touch the leaked liquid, it may hurt your skin. Immediately wash away the liquid with water and seek medical advice.
- If you get the leaked liquid in your eye, it may cause blindness or damage. Never rub your eye, and immediately wash away the liquid with water and seek medical advice.

During a thunderstorm, do not touch the projector or the cable.

- Electric shocks can result.

Do not use the projector in a bath or shower.

- Fire or electric shocks can result.

Do not place your skin into the light beam while the projector is being used.

- Strong light is emitted from the projector's lens. If you place directly into this light, it can hurt or damage your skin.

Do not look into the lens while the projector is being used.

- Strong light is emitted from the projector's lens. If you look directly into this light, it can hurt and damage your eyes.
- Be especially careful not to let young children look into the lens. In addition, turn off the power and disconnect the power plug when you are away from the projector.

Do not place your hands or other objects close to the air outlet port.

- Heated air comes out of the air outlet port. Do not place your hands or face, or objects which cannot withstand heat close to this port [allow at least 50 cm (20") of space], otherwise burns or damage could result.

Replacement of the lamp is recommended to be carried out by a qualified technician.

- The lamp has high internal pressure. If improperly handled, explosion might result.
- The lamp can easily become damaged if struck against hard objects or dropped, and injury or malfunctions may result.

When replacing the lamp, allow it to cool for at least one hour before handling it.

- The lamp cover gets very hot, and touching it can cause burns.

Before replacing the lamp, be sure to disconnect the power plug from the wall outlet.

- Electric shocks or explosions can result if this is not done.

Do not allow infants or pets to touch the remote control unit.

- Keep the remote control unit out of the reach of infants and pets after using it.

CAUTIONS

Do not cover the air inlet port or the air outlet port.

- Doing so may cause the projector to overheat, which can cause fire or damage to the projector.
- Do not place the projector in narrow, badly ventilated places such as closets or bookshelves.
- Do not place the projector on cloth or papers, as these materials could be drawn into the air inlet port.

Do not set up the projector in humid or dusty places or in places where the projector may come into contact with oily smoke or steam.

- Using the projector under such conditions may result in fire, electric shocks or plastic deterioration. The plastic deterioration may cause the falling down of the projector which is mounted on the ceiling.

Do not set up the projector in a high temperature environment, such as near a heater or in direct sunlight.

- Failure to observe this may result in fire, malfunction or plastic deterioration.

Do not set up the projector outdoors.

- The projector is designed for indoor use only.

When disconnecting the power cord, hold the plug, not the cord.

- If the power cord itself is pulled, the cord will become damaged, and fire, short-circuits or serious electric shocks may result.

Always disconnect all cables before moving the projector.

- Moving the projector with cables still attached can damage the cables, which could cause fire or electric shocks to occur.

Do not place any heavy objects on top of the projector.

- Failure to observe this may cause the projector to become unbalanced and fall, which could result in damage or injury.

Do not short-circuit, heat or disassemble the batteries or place them into water or fire.

- Failure to observe this may cause the batteries to overheat, leak, explode or catch fire, and burns or other injury may result.

Precautions with regard to safety

When inserting the batteries, make sure the polarities (+ and -) are correct.

- If the batteries are inserted incorrectly, they may explode or leak, and fire, injury or contamination of the battery compartment and surrounding area may result.

Use only the specified batteries.

- If incorrect or different kind of batteries are used, they may explode or leak, and fire, injury or contamination of the battery compartment and surrounding area may result.

Do not mix old and new batteries.

- If the batteries are used mixing old and new, they may explode or leak, and fire, injury or contamination of the battery compartment and surrounding area may result.

Remove the used batteries from the remote control promptly.

- If you leave used batteries in the remote control for an extended period of time, it may cause liquid leaking, abnormal internal temperature rising or explosion.

If not using the projector for an extended period of time, disconnect the power plug from the wall outlet and remove the batteries from the remote control.

- If dust builds up on the power plug, the resulting humidity may damage the insulation, which could result in fire.
- Keeping or leaving the remote control with batteries inside may cause insulation deterioration, electrical leakage or explosion which could result in fire.

Do not put your weight on this projector.

- You could fall or the projector could break, and injury may result.
- Be especially careful not to let young children stand or sit on the projector.

Disconnect the power plug from the wall outlet as a safety precaution before carrying out any cleaning.

- Electric shocks can result if this is not done.

If the lamp has broken, ventilate the room immediately. Do not touch or bring your face close to the broken pieces.

- Failure to observe this may cause the user to absorb the gas which was released when the lamp broke and which contains nearly the same amount of mercury as fluorescent lamps, and the broken pieces may cause injury.
- If you believe that you have absorbed the gas or that the gas has got into your eyes or mouth, seek medical advice immediately.
- Ask your dealer about the replacement of the lamp unit and check the inside of the projector.

Ask an Authorized Service Center to clean inside the projector at least once a year.

- If dust is left to build up inside the projector without being cleaned out, it can result in fire or problems with operation.
- It is a good idea to clean the inside of the projector before the season for humid weather arrives. Ask your nearest Authorized Service Center to clean the projector when required. Please discuss with the Authorized Service Center regarding cleaning costs.

Do not use chemical treated wipes when cleaning.

- Using chemical treated wipes may result in plastic distortion or deterioration.

We are constantly making efforts to preserve and maintain a clean environment. Please take non repairable units back to your dealer or a recycling company.

Cautions when transporting

Do not subject the projector to excessive vibration or shocks.

- The projector lens need to be handled with care.
- Cover the lens with the lens cover when transporting the projector.

When transporting the projector, hold the body at the bottom securely.

- Do not hold the adjuster legs or the top cover to move the projector, as this may damage the projector.

Cautions when installing

Avoid setting up in places which are subject to vibration or shocks.

- The internal parts can be damaged, which may cause malfunctions or accidents.

Avoid setting up in places which are subject to sudden temperature changes, such as near an air conditioner or lighting equipment.

- The life of the lamp may be shortened or the projector may be turned off. See "TEMP indicator" on page 47.

Precautions with regard to safety

Do not set up the projector near high-voltage power lines or near motors.

- The projector may be subject to electromagnetic interference.

If installing the projector to the ceiling, ask a qualified technician to carry out all installation work.

- You will need to purchase the separate installation kit (Model No. ET-PKF100H, ET-PKF100S). Furthermore, all installation work should only be carried out by a qualified technician.
- See “Ceiling mount bracket safeguards” on page 56 for the safety cable installation.

If using this projector at high elevations 1 400 - 2 700 m (4 593 - 8 858 ft) sea level, set the HIGH ALTITUDE MODE to ON. See “HIGH ALTITUDE MODE” on page 42.

- Failure to observe this may result in malfunctions or the life of the lamp or the other components may be shortened.

Cautions on use

In order to get the best picture quality

- Draw curtains or blinds over any windows and turn off any lights near the screen to prevent outside light or light from indoor lamps from shining onto the screen.

Do not touch the surfaces of the lens or the front glass with your bare hands.

- If the surface of the lens becomes dirty from fingerprints or anything else, this will be magnified and projected onto the screen. Moreover, when not using the projector, close the front panel cover.

Liquid crystal panel

- Do not project the same image for long periods of time, as this may remain as an afterimage on the liquid crystal panel. Display the white screen test pattern for more than an hour to remove it. See “TEST PATTERN” on page 43.
- The liquid crystal panel of the projector is built with very high precision technology to provide fine picture details. Occasionally, a few stuck pixels may appear on the screen as fixed points of blue, green or red. It is recommended to switch off the projector once and try after 1 hour later again. Please note that this does not affect the performance of your LCD.

The projector has a high pressure mercury lamp and that is characterized as follows.

- The brightness of the lamp depends on the duration of use.
- The lamp may explode or shorten the lamp life by shocks or chipping damage.
- The lamp may explode only occasionally after using the projector.
- The lamp may explode if using the projector after the instructed lamp replacement timing.
- When the lamp exploded, it emits internal smoke-like gas.
- The lamp life is depends on individual lamp characteristics, usage condition and the installation environment. Especially the consecutive use of the projector for more than 10 hours, or the frequent switching on or off may greatly affect on the lamp life.

Optical components

- If you use the projector consecutively 6 hours every day, the optical components may need to be replaced in less than 1 year.

Security

Take the safety measures for use of the projector that should cover the following envisioned incidents.

- The leakage of your personal registered information.
- Dishonest operation by an untrusted third party.
- Locking out or prevent anyone else from using the projector by an untrusted third party.



Security instruction

- The connecting network must be secured by firewall or others.
- Change your password regularly.
- Do not use password too simple to guess.
- The Authorized Service Center will never ask you for the password.
- Do not share your password with anyone else.
- Password the projector and restrict access to authorized users only.

Precautions with regard to safety

Accessories

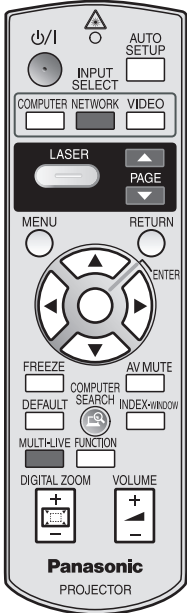
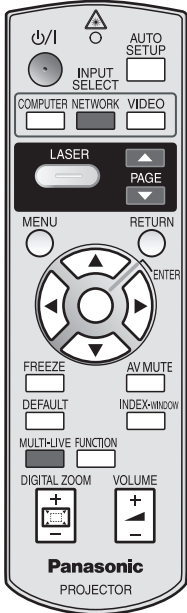
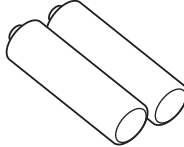
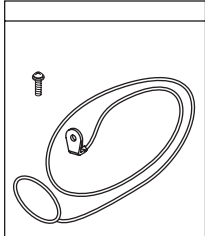
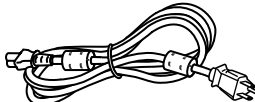
Make sure the following accessories are provided with your projector.

<p>Remote control for PT-F300NTU (x1) N2QAYB000308</p> 	<p>Remote control for PT-F300U (x1) N2QAYB000311</p> 	<p>AA batteries for remote control (x2)</p>  <p>Power cord (x1) K2CG3DH00054</p>  <p>Power cord secure lock (x1) TTRA0182</p> 	<p>Safety cable TTRA0141 Attachment screw (x1) Safety cable (x1)</p>  <p>CD-ROM (x1) TQBH9012</p> 
--	--	--	---

* The protectors for enclosed products, such as a plug cover or foam cartons, must be treated properly.

* Contact to an Authorized Service Center for lost accessories.

Read this first

Minimum required setting screen

When you start the projection for the first time, the minimum required setting screen for projection will be displayed.

INITIAL SETTING

1. Select the required language setting by pressing ◀ ▶, then press the **ENTER** button.

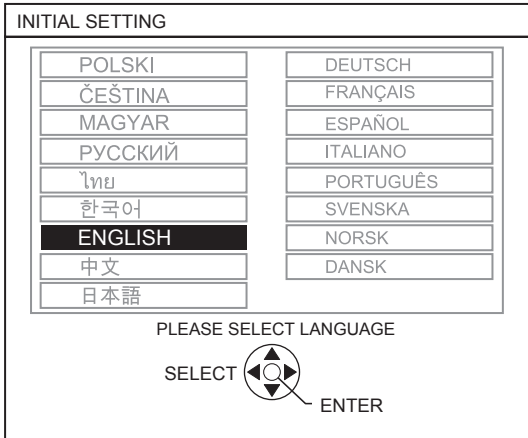

2. Select the minimum required settings to start the projection.
 - Press the **RETURN** button to return to the language setting menu.
 - Press ▲ ▼ to move through the menu items.
 - Press ◀ ▶ to select the required setting.
 - Press the **ENTER** button to complete the setting and start the projection.

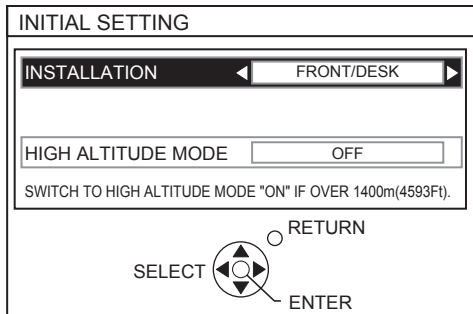

INSTALLATION

Select the required installation method.

FRONT/DESK	Setting on a desk/floor and projecting from front
FRONT/CEILING	Mounting on the ceiling and projecting from front
REAR/DESK	Setting on a desk/floor and projecting from rear
REAR/CEILING	Mounting on the ceiling and projecting from rear

HIGH ALTITUDE MODE

If you use the projector at high elevation, the **HIGH ALTITUDE MODE** setting need to be **ON** to set the fan speed high.

- **OFF** The fan speed is low.
- **ON** The fan speed is high.

NOTE:

- At 1 400 - 2700 m (4 593 - 8 858 ft) above sea level, the setting must be **ON**.
- The loudness of fan noise depends on the **HIGH ALTITUDE MODE** setting.

NOTE:

- Once you finish the minimum requirement setting, it will not be displayed again unless the projector is initialized. See "INITIALIZE ALL" on page 43.
- You can change the each setting from the main menu. See "Menu Navigation" on page 30.

About Your Projector

Projector body

Top and front view

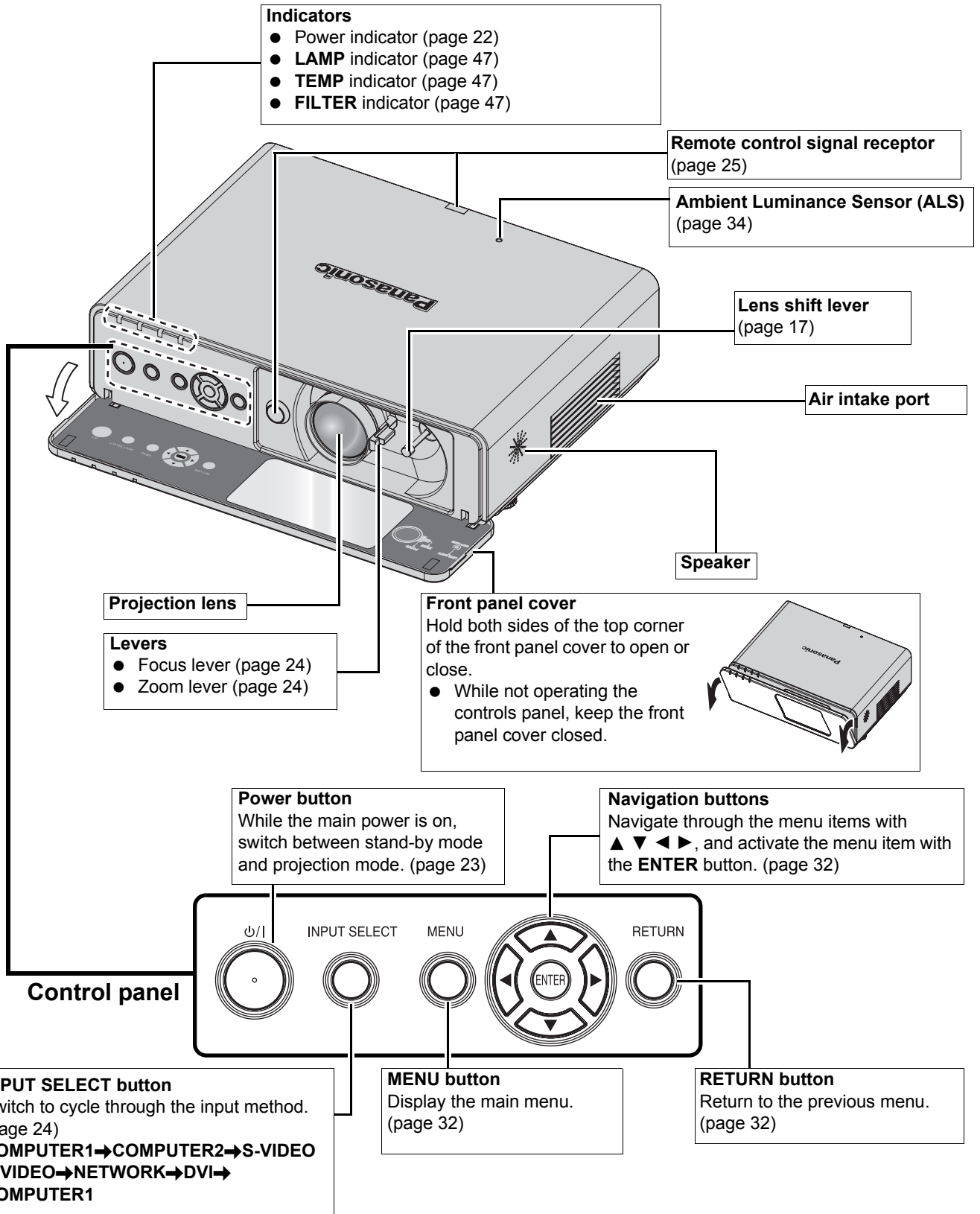

NOTE:

- Do not cover the ventilation openings or place anything within 50 cm (20") of them as this may cause damage or injury.
- While the projector is not in use, keep the front panel cover closed to protect the lens.

Back and bottom view

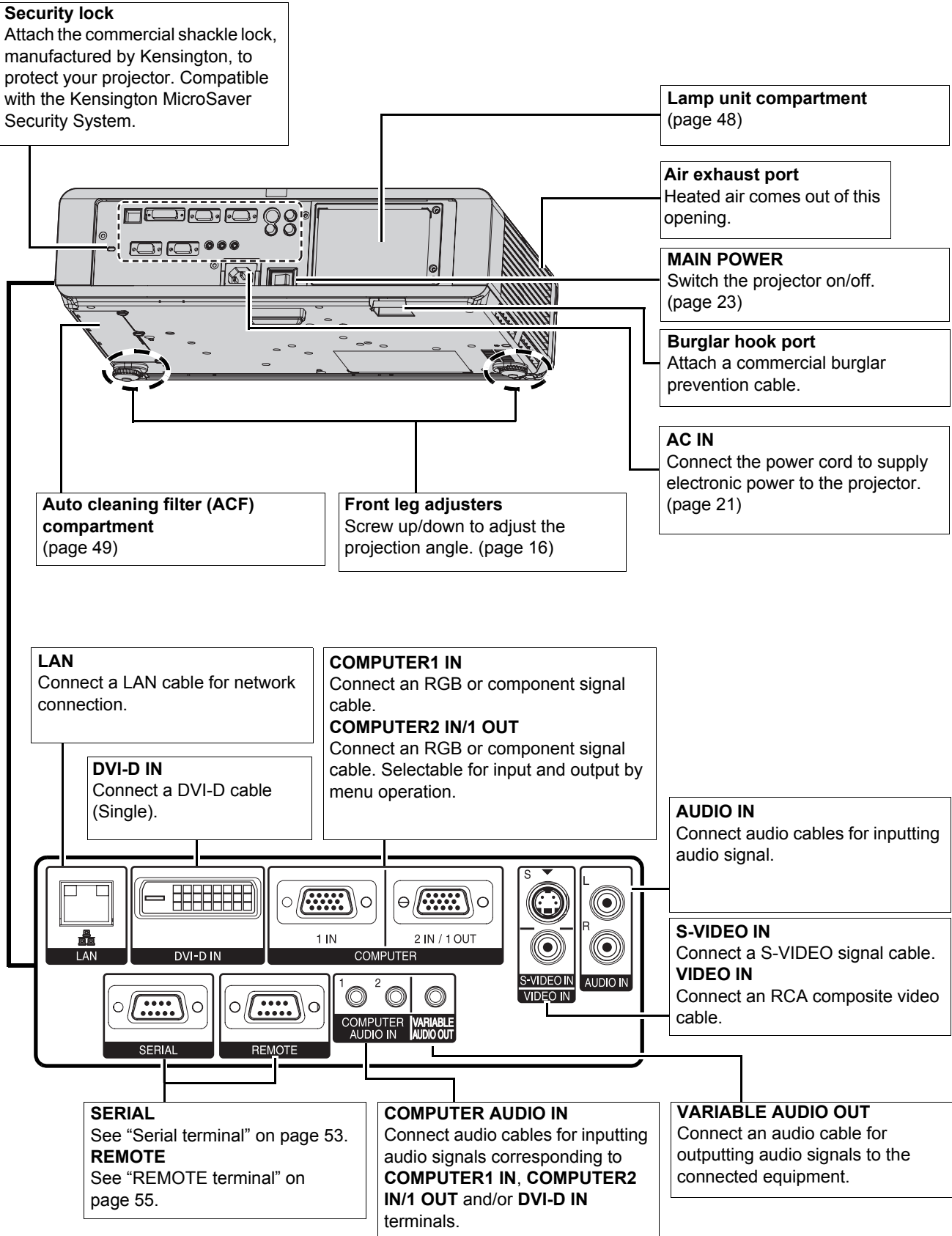







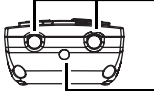

NOTE:

- Do not cover the ventilation openings or place anything within 50 cm (20") of them as this may cause damage or injury.
- When a cable is connected to the **VARIABLE AUDIO OUT**, the built-in speaker will be disabled.

About Your Projector







Remote control

<p>Attaching a hand strap You can attach a favorite strap on to the remote control.</p> 	<p>Top view</p>  <p>Remote control signal emitters (page 25)</p> <p>Laser pointer beam emitter (page 28)</p>	<p>Remote control indicator Pressing any button except the LASER button, the remote control indicator will flash. Pressing the LASER button, it will lit.</p>
--	--	--

<p>Power button While the MAIN POWER is on, switch between standby mode and projection mode. (page 21)</p> 
<p>Project a laser pointer. (page 28)</p> 
<p>Display the main menu. (page 32)</p> 
<p>Navigate through the menus with ▲▼◀▶, and activate the menu item with the ENTER button. (page 32)</p> 
<p>Capture the projected image as a frozen picture. (page 27)</p> 
<p>Reset some of the settings to the factory default settings. (page 27)</p> 
<p>Assign the frequently use functions from the options for shortcut. (page 27)</p> 
<p>Control to change the scale by means of digital zoom. (page 26)</p> 



(Shown as PT-F300NTU)

<p>AUTO SETUP</p> 	<p>Automatically adjust the setting of SHIFT, DOT CLOCK, CLOCK PHASE and SIGNAL SEARCH for the projected image of COMPUTER/DVI signal. (page 25)</p>
<p>COMPUTER VIDEO</p> 	<p>Switch the required input signal button to select.</p>
<p>RETURN</p> 	<p>Return to the previous menu. (page 32)</p>
<p>AV MUTE</p> 	<p>Turn off the projection temporarily. (page 27)</p>
<p>INDEX-WINDOW</p> 	<p>Display the frozen image while the display of subsequent images continues. (page 27)</p>
<p>VOLUME</p> 	<p>Control to adjust the volume of the speaker. (page 29)</p>

<p>MULTI-LIVE NETWORK PAGE COMPUTER SEARCH</p>  <p>These buttons are for network control. See the contents of the provided CD-ROM for instructions. The COMPUTER SEARCH button is for PT-F300NTU only.</p>

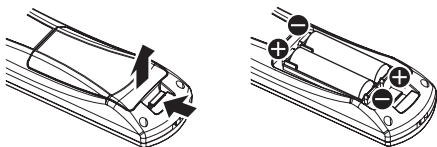
<p>Battery compartment</p>  <ol style="list-style-type: none"> 1. Press the tab and lift up the cover. 2. Insert the batteries according to the polarity diagram indicated inside.

<p>NOTE:</p> <ul style="list-style-type: none"> • Do not drop the remote control. • Avoid contact with liquids or moisture. • Use manganese batteries or alkaline batteries with the remote control. • Do not attempt to modify or disassemble the remote control. Contact an Authorized Service Center for repairs. • Do not keep pressing the remote control buttons as this may shorten battery life. • Do not point the laser in other people's eyes or stare into beam. • See "Remote control operation" on page 25.

Setting up

Screen size and throw distance

You can adjust the projection size with 2.0x zoom lens. Calculate and define the throw distance as follows.

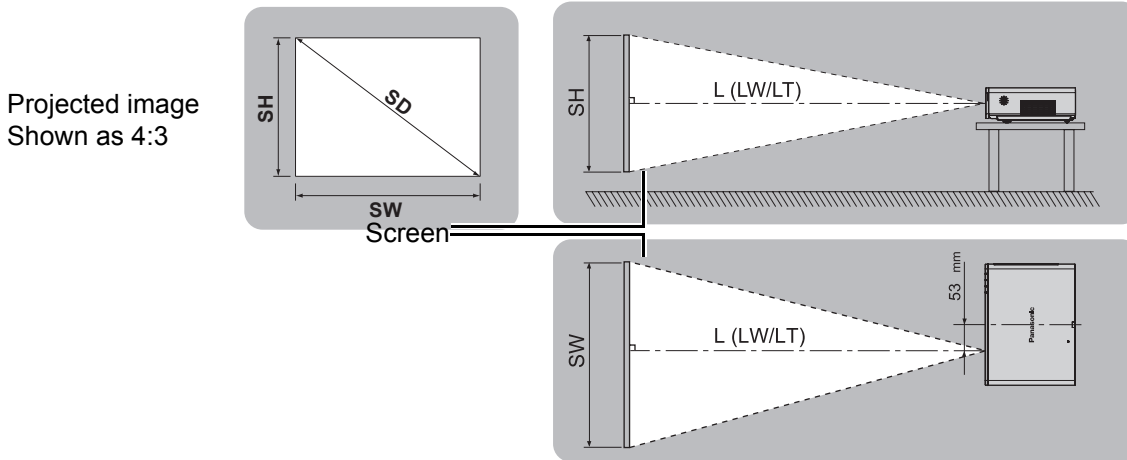

All measurements and the calculation results below are approximate and may differ slightly from the actual measurements.

Projection size (4 : 3)			Throw distance (L)	
Screen diagonal (SD)	Screen height (SH)	Screen width (SW)	Minimum distance (LW)	Maximum distance (LT)
33" (0.84 m)	0.50 m (1'7")	0.67 m (2'2")		1.9 m (6'2")
40" (1.02 m)	0.61 m (2')	0.81 m (2'7")	1.2 m (3'11")	2.4 m (7'10")
50" (1.27 m)	0.76 m (2'5")	1.02 m (3'4")	1.5 m (4'11")	3.0 m (9'10")
60" (1.52 m)	0.91 m (2'11")	1.22 m (4')	1.8 m (5'10")	3.6 m (11'9")
70" (1.78 m)	1.07 m (3'6")	1.42 m (4'7")	2.1 m (6'10")	4.2 m (13'9")
80" (2.03 m)	1.22 m (4')	1.63 m (5'4")	2.4 m (7'10")	4.8 m (15'8")
90" (2.29 m)	1.37 m (4'5")	1.83 m (6')	2.7 m (8'10")	5.4 m (17'8")
100" (2.54 m)	1.52 m (4'11")	2.03 m (6'7")	3.0 m (9'10")	6.0 m (19'8")
120" (3.05 m)	1.83 m (6')	2.44 m (8')	3.6 m (11'9")	7.2 m (23'7")
150" (3.81 m)	2.29 m (7'6")	3.05 m (10')	4.5 m (14'9")	9.0 m (29'6")
200" (5.08 m)	3.05 m (10')	4.06 m (13'3")	6.1 m (20')	12.0 m (39'4")
250" (6.35 m)	3.81 m (12'6")	5.08 m (16'8")	7.6 m (24'11")	15.1 m (49'6")
300" (7.62 m)	4.57 m (14'11")	6.10 m (20')	9.1 m (29'10")	18.1 m (59'4")

Calculation methods

$$SW (m) = SD (") \times 0.0203$$

$$SH (m) = SD (") \times 0.0152$$

$$LW (m) = 0.0305 \times SD (") - 0.049$$

$$LT (m) = 0.0604 \times SD (") - 0.05$$

NOTE:

- See page 57 for the screen size and throw distance of 16:9.
- Do not use the projector at a raised or a horizontally tilted position as it may cause malfunction of the projector.
- Make sure the projector lens surface is parallel with the screen. You can tilt the projector body approximately $\pm 30^\circ$ vertically. Overtilting may result in shortening the component's life.
- For the best quality of the projection image, install a screen where sun light or room light does not shine directly onto the screen. Close window shades or curtains to block the lights.

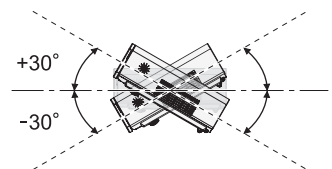

Setting up

Projection method

You can use the projector with any of the following 4 projection methods. To set the desired method in the projector, See "INSTALLATION" on page 42.

■ Setting on a desk/floor and projecting from front

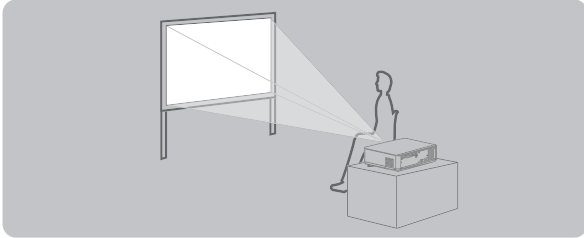

INSTALLATION: FRONT/DESK

■ Setting on a desk/floor and projecting from rear

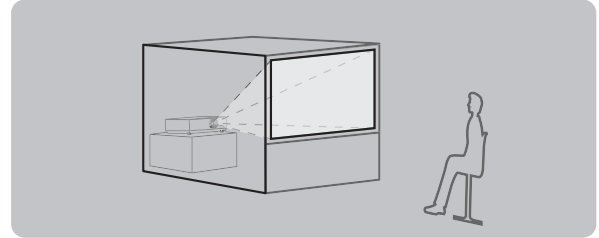

INSTALLATION: REAR/DESK

■ Mounting on the ceiling and projecting from front

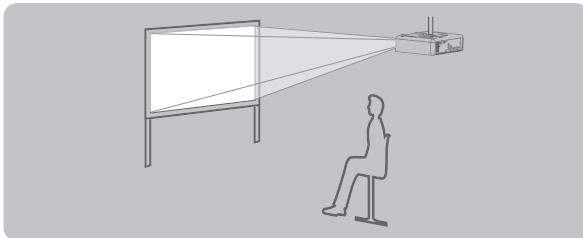

INSTALLATION: FRONT/CEILING

■ Mounting on the ceiling and projecting from rear

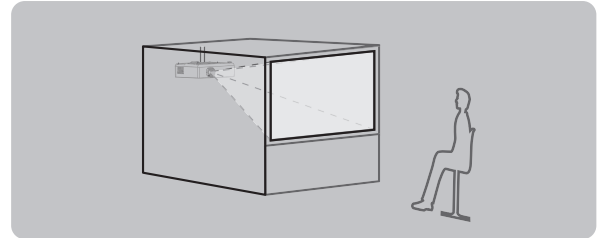

INSTALLATION: REAR/CEILING

NOTE:

- A translucent screen is required for rear projection.
- When mounting the projector on the ceiling, the optional ceiling mount bracket (ET-PKF100H, ET-PKF100S) is required.
- See "Ceiling mount bracket safeguards" on page 56.

Front leg adjusters and throwing angle

You can screw up/down the front leg adjusters to control the angle of the projector for adjusting the throwing angle. See "Positioning the image" on page 24.

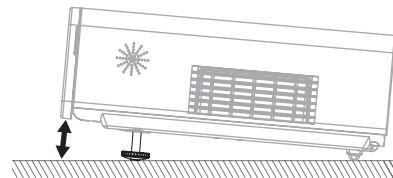
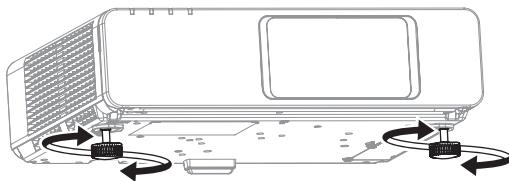

NOTE:

- Heated air comes out of the air exhaust port. Do not touch the air exhaust port directly.
- If keystone distortion occurs, see "KEYSTONE" on page 35.
- Screw up the adjuster legs, and an audible click will be heard as the limit.

Lens shift and positioning

If the projector is not positioned right in front of the center of the screen, you can adjust the projected image position by moving the lens shift lever within the shift range of the lens.

Adjusting the lens shift lever

1. Open the front panel cover.
2. Screw the lens shift lever counterclockwise to unlock.
3. Move the lens shift lever to adjust the projected image position.
4. Screw the lens shift lever clockwise to lock.

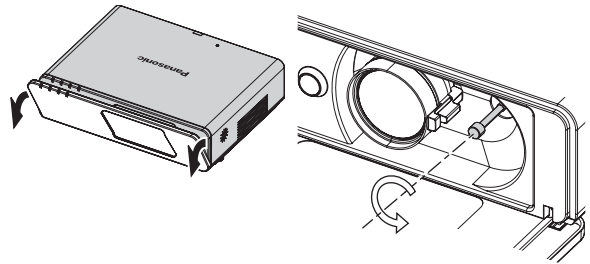

Horizontal shift

You can place the projector where the projector lens is up to 27% horizontally off-center from the screen and then adjust the image position with the lens shift lever.

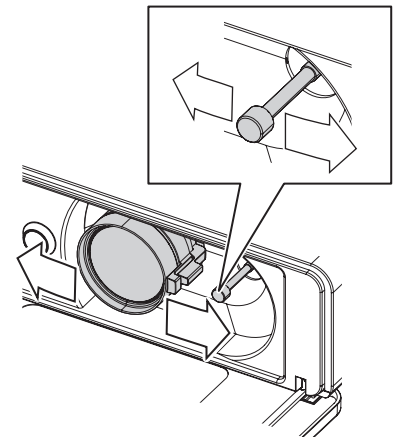
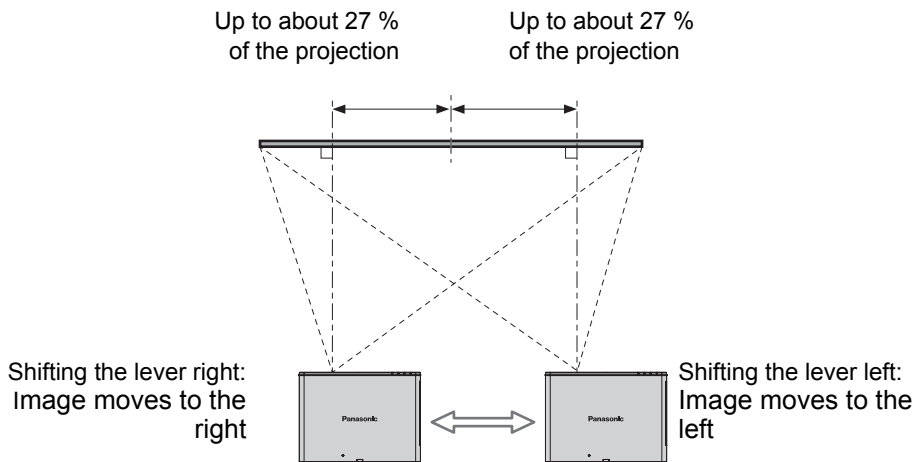

Vertical shift

You can place the projector where the projector lens is up to 50% vertically off-center from the screen and then adjust the image position with the lens shift lever.

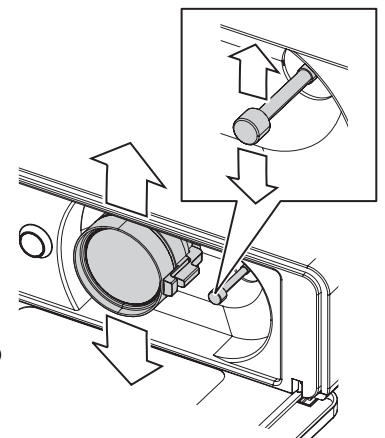
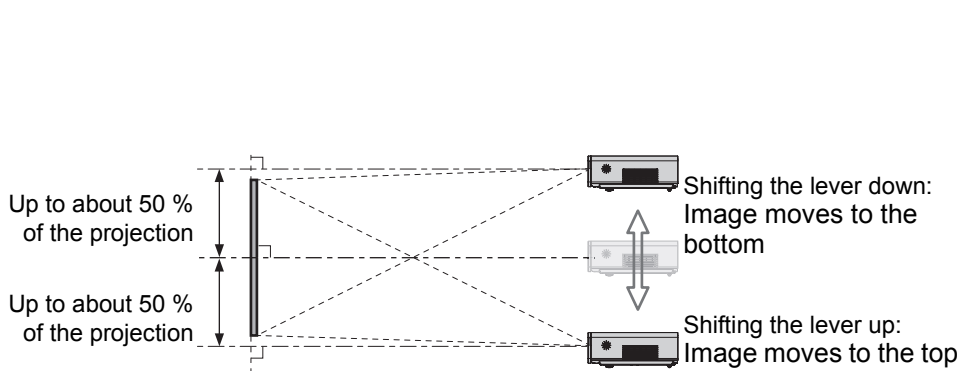

Setting up

Projector location range

You can determine where to locate the screen and the projector by considering the lens shift possibilities. See "Positioning the image" on page 24.

When the screen position is fixed

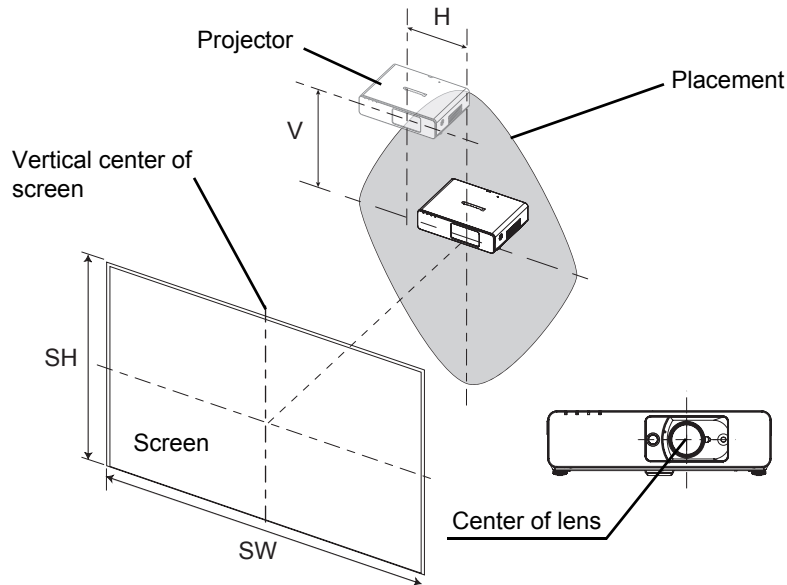

When the projector position is fixed

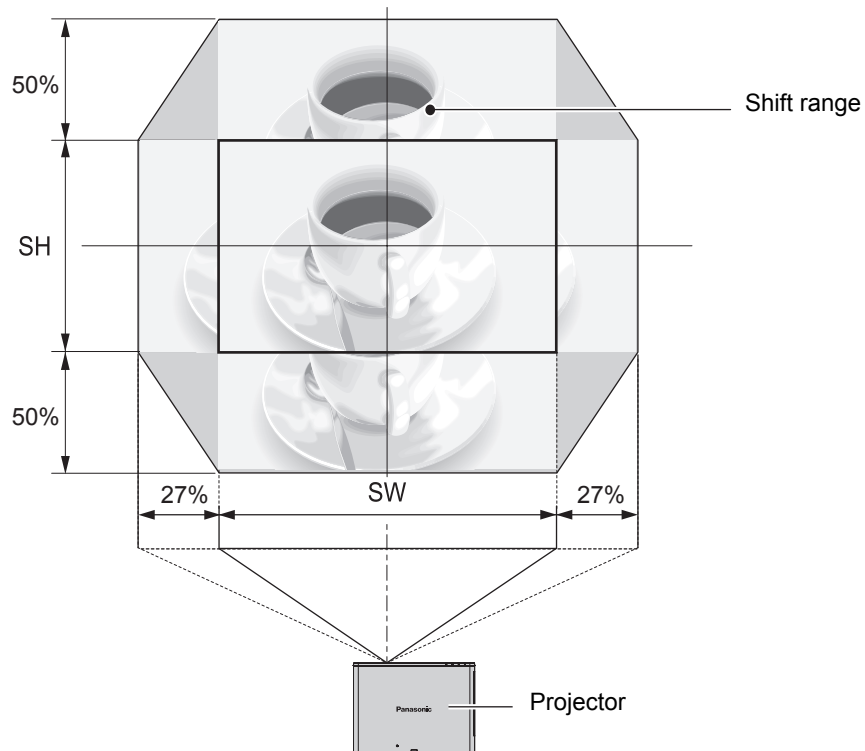

NOTE:

- When the projector is located right in front of the screen and the lens shift lever is centered, you will get the best quality of the projection image.
- When the lens shift lever is at the vertical limit of the shift range, you cannot move the lever to the horizontal limit, likewise when the lens shift lever is at the horizontal limit of the shift range, you cannot move the lever to the vertical limit.
- When the projector is tilted and you adjust **KEYSTONE**, the center of the screen and the lens need to be realigned.
- Do not attempt to pull the lens shift lever hard while adjusting.

Connections

Before connection to the projector

- Read and follow the operating and connecting instructions of each peripheral device.
- The peripheral devices must be turned off.
- Use cables that match each peripheral device to be connected.
- If the input signal is affected by signal jitter, the projected image may have poor image quality and timebase correction is effective.
- Confirm the type of video signals. See “List of compatible signals” on page 52.

Connecting example: Computers

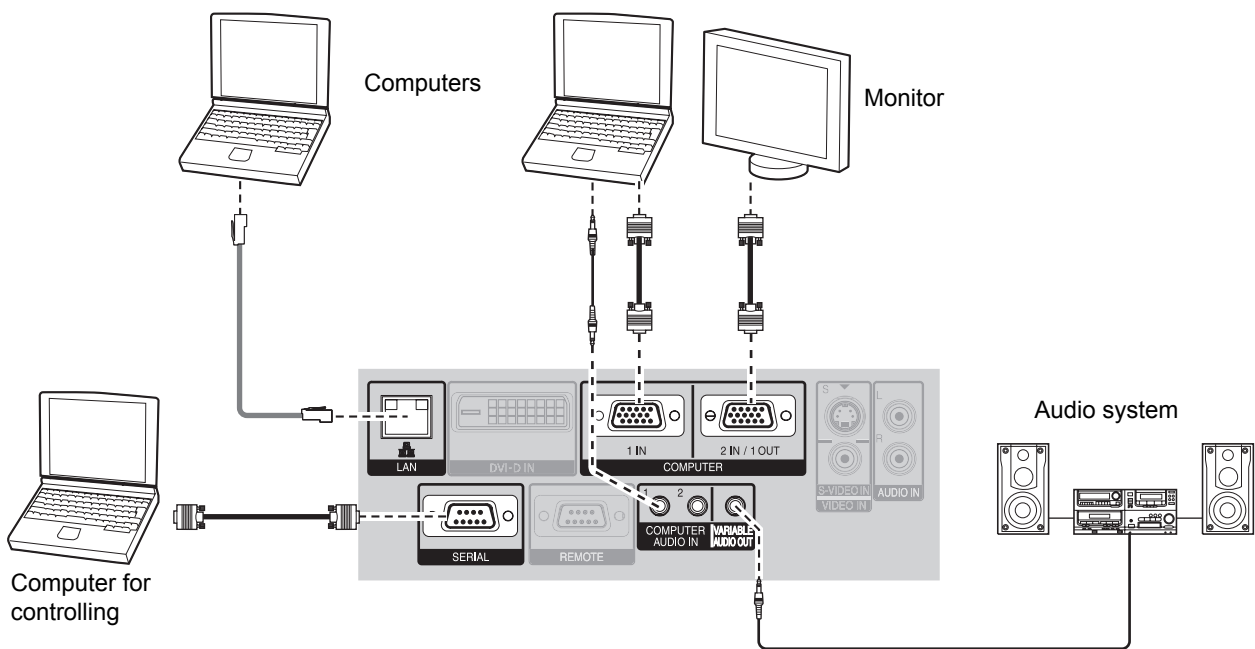

NOTE:

- Use **COMPUTER** terminals to input **YPbPr** signals.
- When connecting to the **COMPUTER** terminals, you can switch the audio input terminal between **COMPUTER AUDIO IN** and **AUDIO IN**. See “AUDIO SETTING” on page 42.
- When **COMPUTER2 SELECT** in the **OPTION** menu is set to **OUTPUT**, do not connect any input signals.
- See CD-ROM contents for the LAN network connection.

LAN terminal

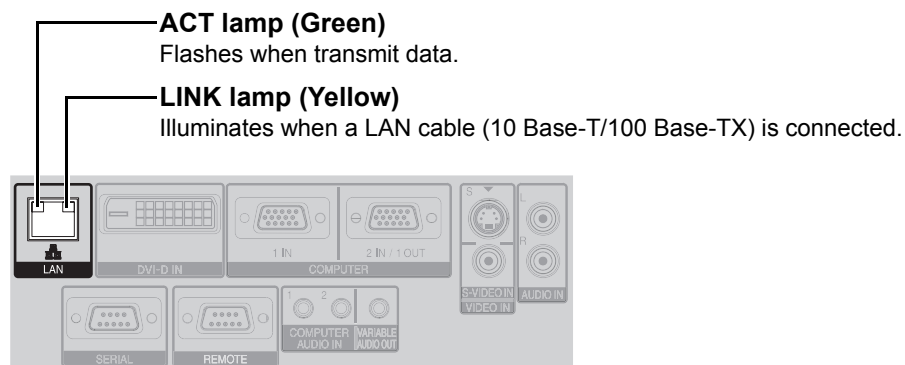

NOTE:

- Do not touch the metal parts of the **LAN** terminal. Failure to observe this may cause malfunction by static electricity.

Connections

Connecting example: AV equipment

Connecting with VIDEO IN/S-VIDEO IN

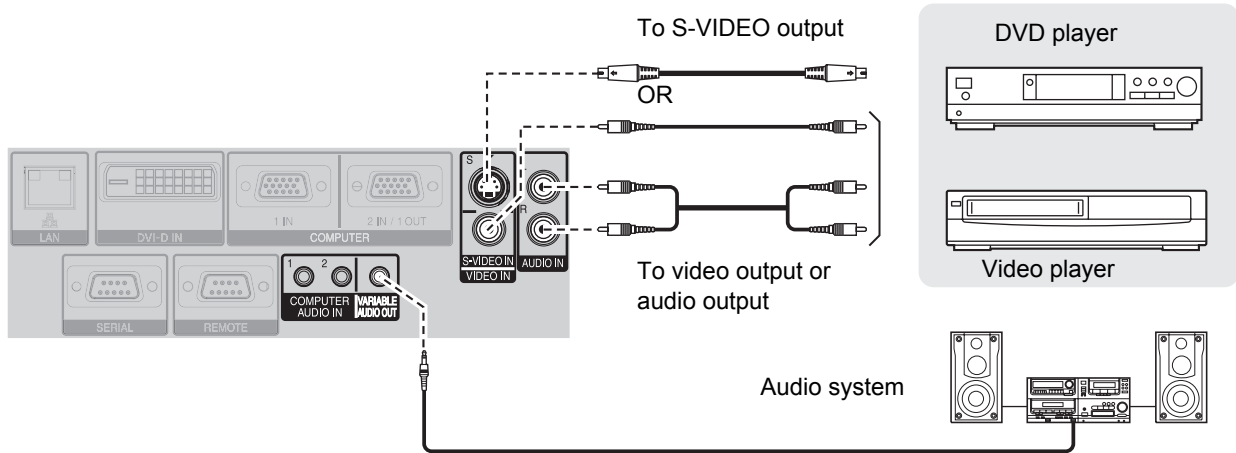

NOTE:

- When you connect more than one AV equipment, switch the audio connection manually.

Connecting with DVI-D IN

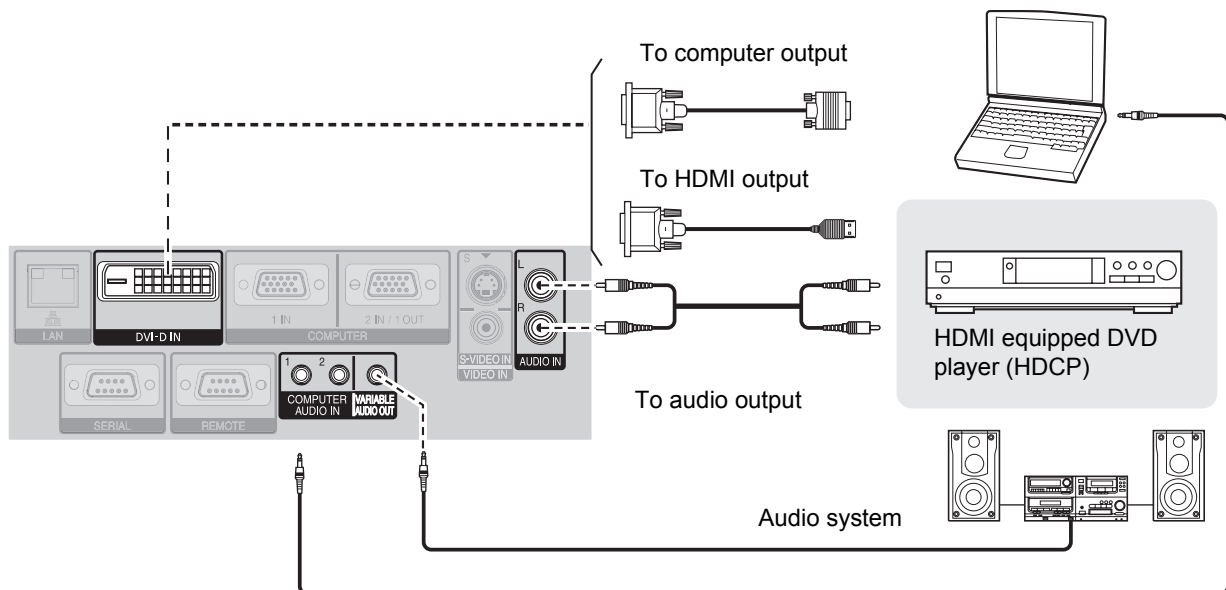

NOTE:

- DVI-D is single link.
- Prepare a HDMI - DVI-D cable for HDMI connection.
- You may need to change the setting of the DVI EDID in DISPLAY OPTION menu with some DVI-D IN connection. See "DVI-D IN" on page 38.
- Malfunction may occur or other problems could be encountered with some kind of HDMI or DVI equipment.
- When connecting to the **DVI-D IN** terminal, you can switch the audio input terminal between **COMPUTER AUDIO IN 2** and **AUDIO IN**. See "AUDIO SETTING" on page 42.

Switching the projector on/off

Power cord

Connecting

1. Make sure the shape of the power plug and the **AC IN** terminal on the back of the projector match, then push the plug all the way in.

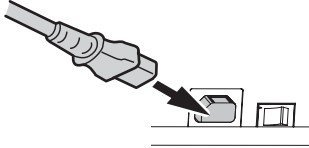

2. Align the side of the power cord secure lock with the side guide rail of the **AC IN** terminal of the projector and slide it in.

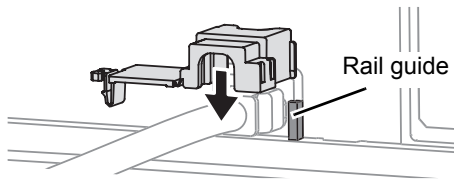

3. Place the latch to the latch catcher and press until it clicks.

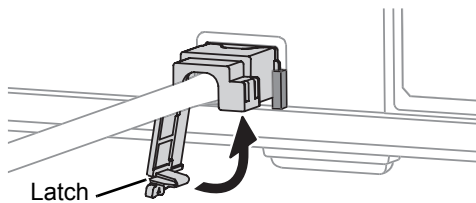

4. Connect the power cord to a wall outlet.

Disconnecting

1. Unplug the power cord from the wall outlet.
2. Depress the latch and slide the cover off.

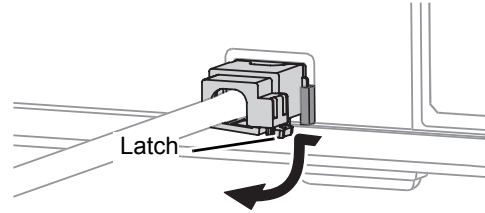

3. Slide the power cord secure lock up along the side guide rail and remove.

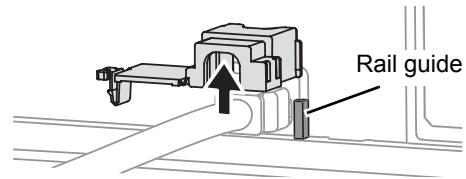

4. Hold the plug and unplug the power cord from the **AC IN** terminal on the back of the projector.
 - Power indicator lights in orange if the internal cooling fan is still operating by internal power supply.

NOTE:

- Do not use other than the provided power cord.
- Ensure all the input devices are connected and turned off before connecting the power cord.
- Do not force the connector as this may damage the projector and/or the power cord.
- Dirt or dust build-up around plugs may cause fire or electrical hazards.
- Switch off the power to the projector when not in use.
- If the projector is switched on again while the internal cooling fan is still operating by the internal power supply, it may take a while to start the projection.

Direct power on function

You can start the projection with only supplying the electric power. See "INITIAL START UP" on page 41.

Direct power off function

You can switch off the electric power supply any time by unplugging the power plug from the wall outlet or by switching off the main power. The internal lamp cooling fan keeps operating by the internal power supply, and stops automatically when cooled enough.

Switching the projector on/off

Power indicator

The power indicator informs you the status of the power.

- When the **LAMP** or **TEMP** indicator is flashing, you cannot switch on the power. See “TEMP, LAMP and FILTER Indicators” on page 47.

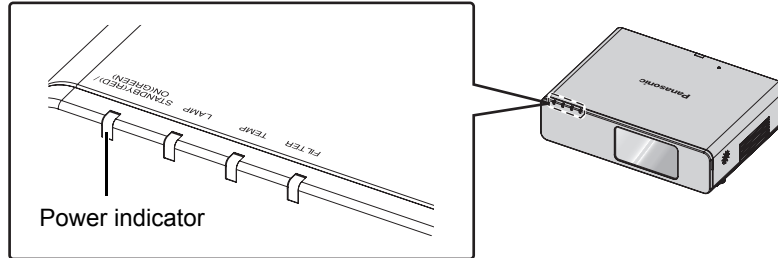

Indicator status		Status
No illumination or flashing		The MAIN POWER is switched off.
RED	Lit	The MAIN POWER is switched on and the projector is in standby mode. When the LAMP or TEMP indicator is flashing, not available to switch on the power.
	Flashing	The power is switched off. (When NETWORK STANDBY in NETWORK menu or IN STANDBY MODE of AUDIO SETTING in PROJECTOR SETUP menu is set to ON). Press the power button to start the projection.
GREEN	Flashing	The power is switched on and the projector is getting ready to project.
	Lit	Projecting.
ORANGE	Lit	The power is switched off and the projector is cooling the lamp. The indicator will light or flash, and start the projection after a short time.
	Flashing	The power is switched on again when cooling the lamp and recovering to projection mode.

NOTE:

- If the projector is switched on again while the internal cooling fan is still operating by the internal power supply, it may take a while to start the projection.
- The electric consumption in standby mode is 4 W.

Switching on the projector

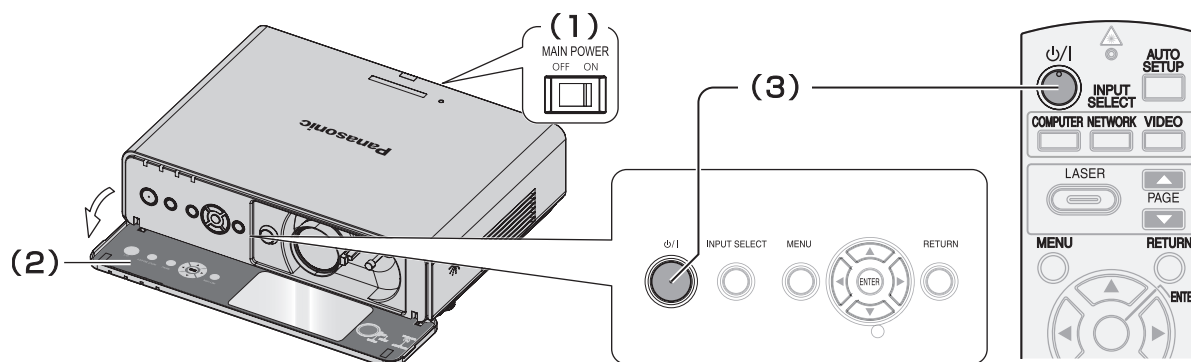

1. Switch the **MAIN POWER** on.
 - The power indicator lights up in red.
2. Open the front panel cover.
 - This is not necessary in remote control operation.
3. Press the power button.
 - The power indicator lights up in green after flashing for a while.
 - The **STARTUP LOGO** will be displayed on the screen. See “STARTUP LOGO” on page 39.

NOTE:

- When starting up the projector, some small rattling or tinkling sound may be heard, or the display may flicker for the characteristics of the lamp. Those are normal and will not affect the performance of the projector.
- When the internal cooling fan is operating, some operational sound may be heard. The loudness of the operational sound depends on the external temperature.
- If you disconnected the power cord or switched off the **MAIN POWER** while on projecting mode, the projection will start with connecting the power cord or switching on the **MAIN POWER**. See “INITIAL START UP” on page 41.

Switching off the projector

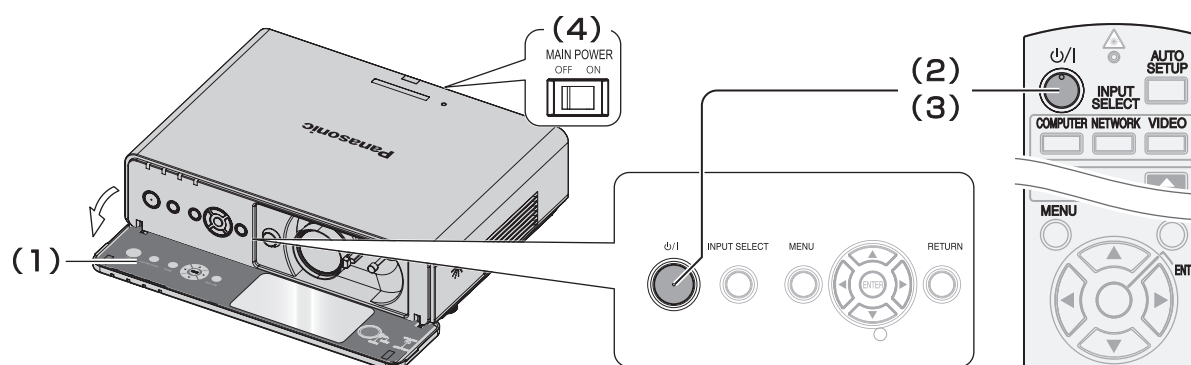

1. Open the front panel cover.
 - This is not necessary in remote control operation.
2. Press the power button.
 - The confirmation screen is displayed. It will disappear and return to the projection after 10 seconds without any operation.
 - To return to the projection, press any button except the power button.
3. Press the power button.
 - The power indicator lights up in orange while cooling the lamp, then illuminates red when is ready to switch off the **MAIN POWER**.
4. Switch off the **MAIN POWER** on the back of the projector.

NOTE:

- You can disconnect the power cord or switch off the **MAIN POWER** instead of following this procedure. See “INITIAL START UP” on page 41.

Projecting an image

Selecting the input signal

1. Switch on the connected devices.
 - Press the play button of the required device.
2. Press the **INPUT SELECT** buttons to select the required input method if needed. See “Switching the input signal” on page 26.
 - The image will be projected on the screen.

NOTE:

- **SIGNAL SEARCH** is **ON** as default and the signal from the connected devices is detected automatically. See “SIGNAL SEARCH” on page 39.

Positioning the image

1. Open the front panel cover.
2. Adjust the projected image with the lens shift lever. See “Lens shift and positioning” on page 17.

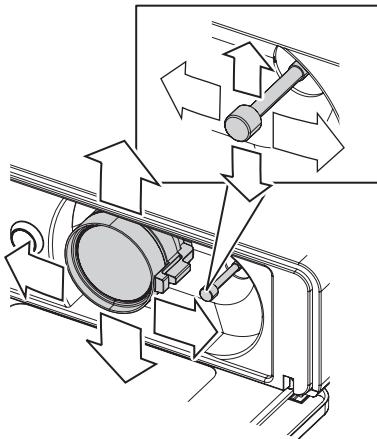

4. Adjust the focus and the projected image size.
 - Turn the focus lever and zoom lever to adjust the image.
 - You can confirm the adjusted effect with the **TEST PATTERN** in **OPTION** menu. See “TEST PATTERN” on page 43.

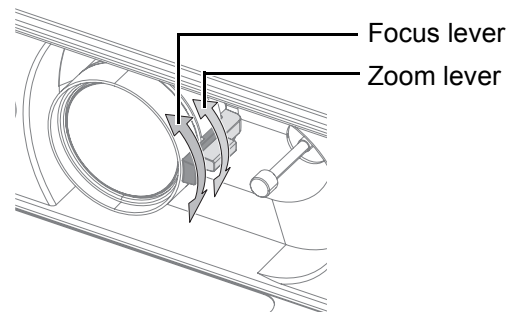

3. Adjust the angle of the projector.
 - Screw down the front leg adjusters and adjust the angle vertically.
 - See “Front leg adjusters and throwing angle” on page 16.

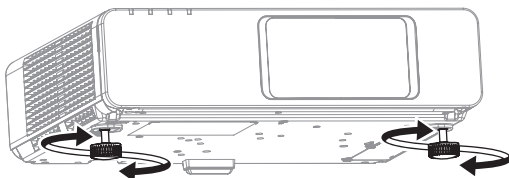

NOTE:

- Do not touch the air exhaust port as this may cause burns or injury.
- If keystone distortion occurs, see “KEYSTONE” on page 35.
- If you adjust the focus, you may need to adjust the size of the image by moving the zoom lever again.

Remote control operation

Operating range

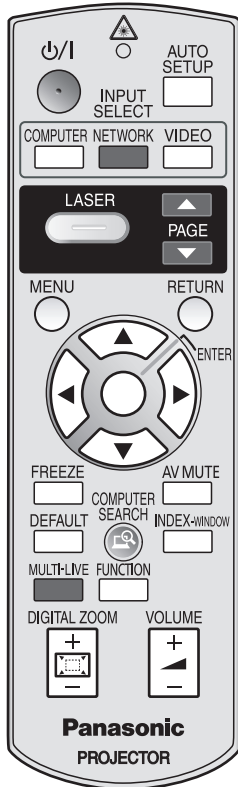

(Shown as PT-F300NTU)

You can operate the projector with the remote control within the remote range 15 m (49'2"), approximately $\pm 30^\circ$ vertically and horizontally.

● Facing to the projector

Ensure the remote control emitter is facing to the remote control signal receptor on front/back of the projector and press the required buttons to operate.

● Facing to the screen

Ensure the remote control emitter is facing to the screen and press the required buttons to operate the projector. The signal will be reflected off the screen. The operating range may differ due to the screen material. This function may not be effective with a translucent screen.

NOTE:

- Do not let strong light shine onto the signal receptor. The remote control may malfunction under strong light such as fluorescent.
- If there are any obstacles between the remote control and the remote control signal receptor, the remote control may not operate correctly.

Setting up the image position automatically

AUTO SETUP
You can adjust the setting of **SHIFT**, **DOT CLOCK** and **CLOCK PHASE** in the **POSITION** menu automatically for the projected **COMPUTER** signal image.

- With DVI signal, adjust **SHIFT** setting only.

NOTE:

- If the dot clock frequency is 150 MHz or higher, **AUTO SETUP** is not effective.
- If the projected image is dark or blurred around the edge, **AUTO SETUP** may stop the processing before complete. Project a much clearer or lighter image and press the **AUTO SETUP** button again.
- When there is no signal input and **SIGNAL SEARCH** in **DISPLAY OPTION** menu is **ON**, the auto signal detecting system will start.

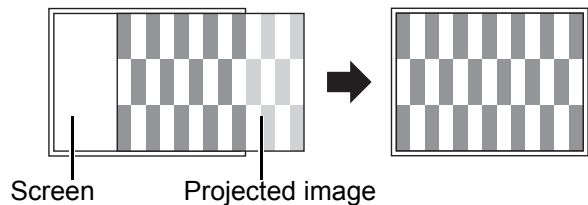

Remote control operation

Switching the input signal

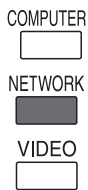

You can switch the input method manually by pressing the **COMPUTER**, **NETWORK** and **VIDEO** buttons. Press the required button several times or **◀▶** to cycle through the input methods as follows. The actual projected image will be changed in a while.

- The graphical guidance will be displayed on the upper right of the projected image and you can confirm the selected input method which is highlighted in yellow. See "INPUT GUIDE" on page 38.

NOTE:

- If you select an unplugged input method, the guidance will blink on and off several times.
- See "List of compatible signals" on page 52.
- See "Connections" on page 19.

Pressing the **COMPUTER** button

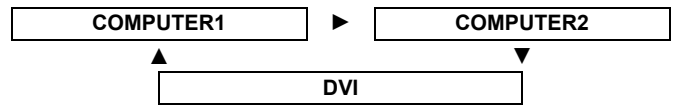

NOTE:

- Only when the **COMPUTER2 SELECT** is set to **INPUT**, the **COMPUTER2** is selectable.

Pressing the **NETWORK** button

- Only for the network connection operation. See CD-ROM contents for more detailed information.

Pressing the **VIDEO** button



Pressing the **INPUT SELECT** button on the projector

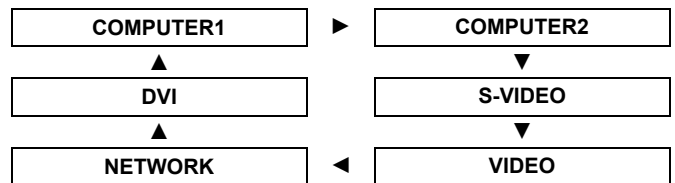

Enlarging the centered area



You can enlarge the projected image down to a centered area for emphasizing within the range of 1x to 2x.

● Enlarging the image

1. Press the **DIGITAL ZOOM +/-** button once.
 - The centered area of the image will then be enlarged to 1.5x.

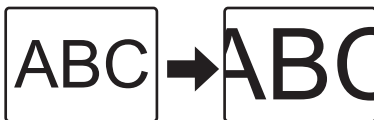

2. Adjust the image size by pressing the **DIGITAL ZOOM +/-** button.

- The image size will be changed in steps of 0.1.



● Shifting the center point

Press **▲▼◀▶** to shift the center point.

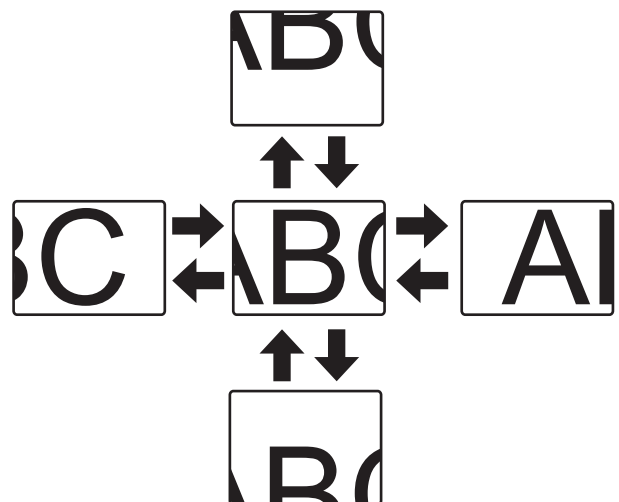

NOTE:

- When the **COMPUTER** signal is projected, the enlargement range will be changed to 1x to 3x. When the **FRAME LOCK** in **POSITION** menu is set to **ON**, the enlargement range is 1x to 2x. See "FRAME LOCK" on page 37.
- When the input signal is changed while the **DIGITAL ZOOM** is activated, the **DIGITAL ZOOM** will be cancelled.
- While **DIGITAL ZOOM** is activated, **FREEZE** is not available.

Capturing an image



Press the **FREEZE** button to capture the image and stop the audio, and you can see it as a still picture while the AV equipment are continuing.

Press the **FREEZE** button again to escape and return to the continuing image.

Stopping the projection



You can stop the projection and audio sound through the projector for saving electrical

power. Press the **AV MUTE** button again to escape.

Resetting to the factory default settings



You can reset most of the customized settings to the factory defaults by pressing the **DEFAULT** button of the remote control. Display the required sub menu or the menu items, and press the **DEFAULT** button again.

- See "Main menu and Sub-menu" on page 30.

NOTE:

- Some menu items are not available to reset by pressing the **DEFAULT** button. Adjust each menu items manually.
- To reset all the settings to the factory defaults, see "INITIAL START UP" on page 41.

Projecting an image in INDEX-WINDOW mode



You can project an image in split 2 windows as an **INDEX-WINDOW**, one is frozen, stored in memory and displayed on the screen's left side, while the display of subsequent images continues on the right.

To escape from the **INDEX-WINDOW**, press the **MENU** or **RETURN** button.

● Changing the image size

Press **▲ ▼** to capture a new image and change the size in 3 ways.

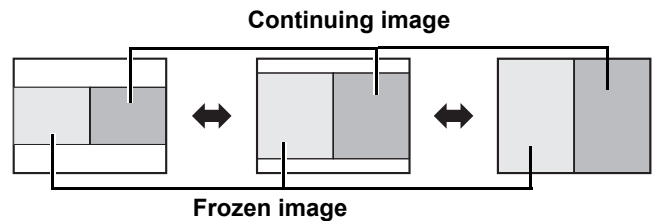
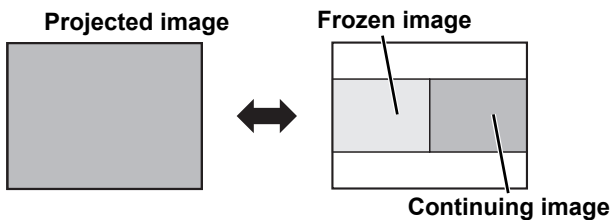

● Switching the position

In default, the frozen image is displayed on the left and the subsequent image is displayed on the right. Press **◀ ▶** to switch the position.

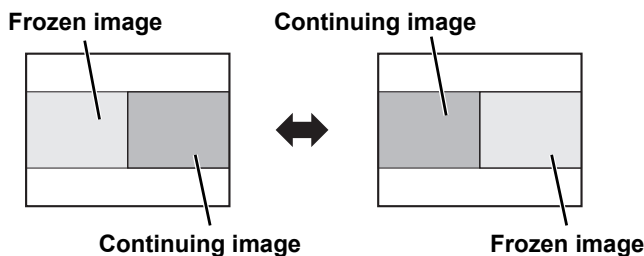

NOTE:

- If you change the window size, the aspect ratio of the image is changed and becomes vertically elongated.
- When vertically enlarged, some signals image with **THROUGH** aspect ratio setting will not be displayed correctly.

● Capturing a new image

While in **INDEX-WINDOW** mode, press the **ENTER** button to capture a new image and the frozen image window will be updated in a while.

NOTE:

- When capturing a quick moving picture, perform several times to get a stabled image.

Remote control operation

Using an assigned function

You can assign a selected function to the **FUNCTION** button. Following functions are assignable.

Options	Functions	Refer
DISABLE	Deactivate the FUNCTION button.	-
ASPECT	Display the ASPECT menu.	36
PICTURE MODE	Display the PICTURE MODE menu.	33
DAYLIGHT VIEW	Display the DAYLIGHT VIEW menu.	34
CLOSED CAPTION	Press to turn on/off the CLOSED CAPTION .	34

NOTE:

- See "FUNCTION BUTTON" on page 42.

Using the laser pointer



You can highlight items on the screen with the red laser pointer while projecting the image in presentations or visual demonstrations as an eye-catching pointing device.

Hold down the **LASER** button to go on the laser pointer and release to go off.

• Top view

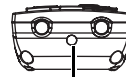

Laser pointer beam emitter

• Deactivating switch

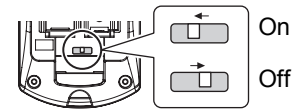

Disable the LASER button

You can disable the **LASER** button for an accidental operation.

1. Open the battery compartment cover of the remote control.
2. Slide the switch tab.
3. Close the battery compartment cover of the remote control.
 - See "Battery compartment" on page 14.

NOTE:

- If you press the disabled **LASER** button, the alert "**LASER POINTER IS DISABLED.**" will be displayed on the screen. While the menu is displaying, the alert will not be displayed.

• Cautions

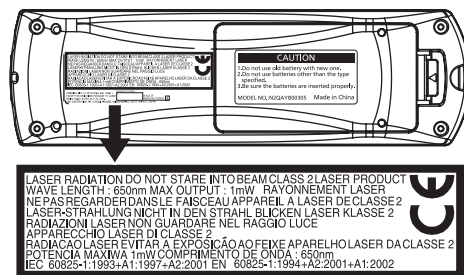

CAUTION
 1. Do not use 6R batteries (other than 6R).
 2. Do not use batteries other than the type identified. (The batteries are marked properly).
 MODEL NO. RD5547893035 Made in China

LASER RADIATION DO NOT STARE INTO BEAM CLASS 2 LASER PRODUCT
 WAVE LENGTH : 650nm MAX OUTPUT : 1mW RAYONNEMENT LASER
 NE PAS REGARDER DANS LE FAISCEAU APPAREIL A LASER DE CLASSE 2
 LASER-STRAHLUNG NICHT IN DEN STRAHL BLICKEN LASER KLASSE 2
 RADIAZIONI LASER NON GUARDARE NEL RAGGIO LUCE
 APPARECCHIO LASER DI CLASSE 2
 RADIAÇÃO LASER EVITAR A EXPOSIÇÃO AO FEIXE APARELHO LASER DA CLASSE 2
 POTENCIA MAXIMA 1mW COMPRIMENTO DE ONDA : 650nm
 IEC 60825-1:1993+A1:1997+A2:2001 EN 60825-1:1994+A2:2001+A1:2002

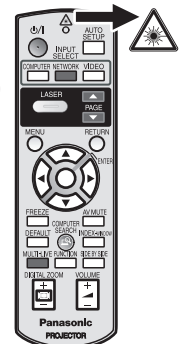

(Shown as PT-F300NTU)

CAUTION: Use of controls of adjustments or performance of procedures other than those specified herein may result in hazardous radiation exposure.

NOTE:

- The laser pointer should never be projected directly into the eyes of a person or animal.
- Do not aim the laser at reflective surfaces.
- Do not allow children to use laser pointer.
- Never look directly into the laser beam.
- The laser pointer is not effective with translucent screens.
- Please read the cautions on the remote control.
- This is a Class 2 laser product.

Controlling the volume of the speaker

VOLUME



You can control the volume of the built-in speakers and output sound. Press "+" side of the **VOLUME** button to increase and "-" to decrease.

NOTE:

- Power consumption can be reduced if the volume level is lowered.

Menu Navigation

Main menu and Sub-menu

The menu options are structured and categorized. You can navigate through the menu with ▲ ▼ ◀ ▶ buttons. See “Menu Navigation” on page 30.

- The underlined items are factory default settings.
- Some default settings vary by the selected input signal.
- Sub-menu items vary according to the selected input signal.
- Some settings are adjustable without any signals.

PICTURE

PICTURE MODE		page 33
NATURAL	STANDARD	
DYNAMIC	BLACKBOARD	
CINEMA		
CONTRAST		page 33
(Default: 0)		
BRIGHTNESS		page 33
(Default: 0)		
COLOR		page 33
(Not available with NETWORK connection)		
(Default: 0)		
TINT		page 33
(Not available with NETWORK connection)		
(Default: 0)		
SHARPNESS		page 33
(Default: 0)		
WHITE BALANCE RED^{*1}		page 33
(Default: 0)		
WHITE BALANCE GREEN^{*1}		page 33
(Default: 0)		
WHITE BALANCE BLUE^{*1}		page 33
(Default: 0)		
COLOR TEMPERATURE		page 34
<u>DEFAULT</u>		
LOW	HIGH	
DAYLIGHT VIEW		page 34
<u>AUTO</u>		
OFF	ON	
DIGITAL CINEMA REALITY		page 34
<u>ON</u>	OFF	
NOISE REDUCTION		page 34
<u>OFF</u>	ON	
TV-SYSTEM		page 34
<u>AUTO</u>		
NTSC	NTSC 4.43	
PAL	PAL-M	
PAL-N	SECAM	
RGB/YPBPR		page 34
<u>AUTO</u>		
RGB	YPBPR	

*1. Available with still image of COMPUTER/DVI signals only

POSITION

KEYSTONE		page 35
(Default: 0)		
SHIFT		page 35
(Not available with NETWORK connection)		
H (Default: 0)	V (Default: 0)	
DOT CLOCK		page 35
(Signals from COMPUTER only)		
(Default: 0)		
CLOCK PHASE		page 35
(Signals from COMPUTER only)		
(Default: 0)		
OVER SCAN		page 35
(Not available with NETWORK connection)		
ASPECT		page 36
AUTO	4:3	16:9
THROUGH		S4:3
FRAME LOCK		page 37
(Signals from COMPUTER only)		
<u>OFF</u>	ON	

LANGUAGE

DEUTSCH	POLSKI
FRANÇAIS	ČEŠTINA
ESPAÑOL	MAGYAR
ITALIANO	РУССКИЙ
PORTUGUÊS	ไทย
SVENSKA	한국어
NORSK	ENGLISH
DANSK	中文
	日本語

DISPLAY OPTION

ON-SCREEN DISPLAY		page 38
INPUT GUIDE		
<u>DETAILED</u>	SIMPLE	
OFF		
OSD DESIGN		
<u>TYPE1</u>	TYPE2	
TYPE3		
WARNING MESSAGE		
<u>ON</u>	OFF	
DVI-D IN		page 38
DVI EDID		
<u>EDID1</u>	EDID2(PC)	
DVI SIGNAL LEVEL		
<u>0-255:PC</u>	16-235	

CLOSED CAPTION SETTING	page 38
CLOSED CAPTION	
OFF	ON
MODE	
CC1	CC2 CC3 CC4
STARTUP LOGO	page 39
ON	OFF
USER	
AUTO SETUP	page 39
AUTO	BUTTON
SIGNAL SEARCH	page 39
ON	OFF
BACK COLOR	page 39
BLUE	BLACK
WIDE MODE	page 39
AUTO	OFF
ON	
SXGA MODE	page 39
SXGA	SXGA+
OTHER FUNCTIONS	page 40
AUTO SETUP	FREEZE
AV MUTE	INDEX-WINDOW
DIGITAL ZOOM	



PROJECTOR SETUP

STATUS	page 41
SIGNAL	
NAME	FREQUENCY
RUNTIME	
PROJECTOR	LAMP
REMAINING FILTER	
QUANTITY	APPROX.TIME
COMPUTER2 SELECT	page 41
INPUT	OUTPUT
NO SIGNAL SHUT-OFF	page 41
DISABLE	
15 MIN.	20 MIN. 25 MIN. 30 MIN.
35 MIN.	40 MIN. 45 MIN. 50 MIN.
55 MIN.	60 MIN.
INITIAL START UP	page 41
LAST MEMORY	ON STANDBY
INSTALLATION	page 42
FRONT/DESK	FRONT/CEILING
REAR/DESK	REAR/CEILING
HIGH ALTITUDE MODE	page 42
OFF	ON
EMULATE	page 42
DEFAULT	D3500
D4000	D/W5K series
L730	L780
L735	L785
LB/W80	
FUNCTION BUTTON	page 42
DISABLE	ASPECT
PICTURE MODE	DAYLIGHT VIEW
CLOSED CAPTION	

AUDIO SETTING	page 42
VOLUME (Default: 20)	
BALANCE (Default: 0)	
IN STANDBY MODE	
OFF	ON
● AUDIO IN SELECT	
DVI	
COM.AUDIO IN 2	AUDIO IN
COMPUTER1	
COM.AUDIO IN 1	AUDIO IN
COMPUTER2	
COM.AUDIO IN 2	AUDIO IN
TEST PATTERN	page 43
INITIALIZE ALL	page 43
FILTER COUNTER RESET	page 43



SECURITY

PASSWORD	page 44
OFF	ON
PASSWORD CHANGE	page 44
TEXT DISPLAY	page 44
OFF	ON
TEXT CHANGE	page 44
MENU LOCK	page 45
OFF	ON
MENU LOCK PASSWORD	page 45
CONTROL DEVICE SETUP	page 45
CONTROL PANEL	
ENABLE	DISABLE
REMOTE CONTROLLER	
ENABLE	DISABLE



NETWORK

	page 46
WIRED LAN	
WIRELESS LAN (PT-F300NTU only)	
NAME CHANGE	PASSWORD
PASSWORD CHANGE	
NETWORK STANDBY	
NETWORK CONTROL	
LIVE MODE CUT IN	
COMPUTER SEARCH	
MULTI-LIVE	STATUS
INITIALIZE	

See CD-ROM contents for more detailed information.

Menu Navigation

Navigating through the menu

Displaying the Main menu

MENU Press the **MENU** button to display the main menu and the operating guidance.

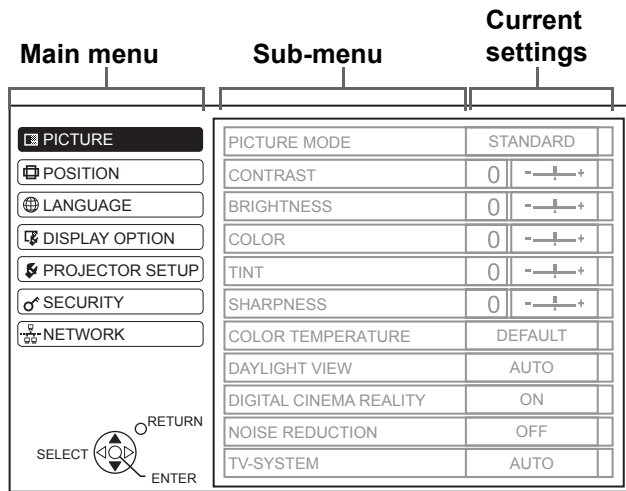

Operating guidance

Contains the required buttons to adjust the settings.

Adjusting with the bar scale items

The triangle mark under the bar indicates factory default setting and the square indicates the current setting.

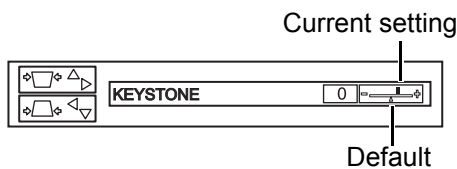

Returning to the previous menu

RETURN Press the **MENU** or **RETURN** button to return to the previous menu. Press repeatedly to escape from the menu mode and return to the projection.



Operating procedure

- Press **▲ ▼** to scroll to the required main menu item and press the **ENTER** button to select.
 - The selected item is highlighted in orange and the sub-menu is displayed on the right.
 - See "Main menu and Sub-menu" on page 30.

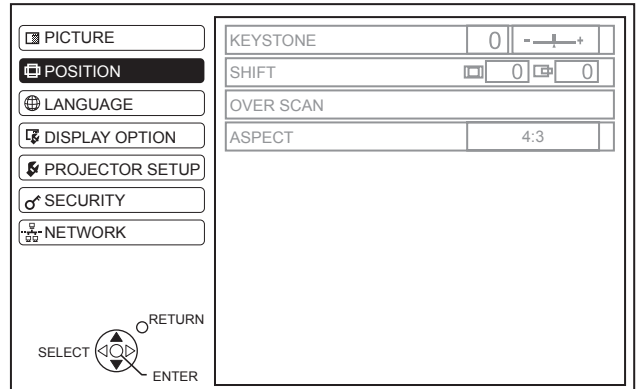

- Press **▲ ▼** to scroll to the required sub-menu item and press **◀ ▶** or the **ENTER** button to adjust.
 - The selected item is called up and the other menu items disappear from the screen. Called up item will be disappear after 5 seconds and return to the menu mode.
 - If there is a lower level, the next level will be displayed.

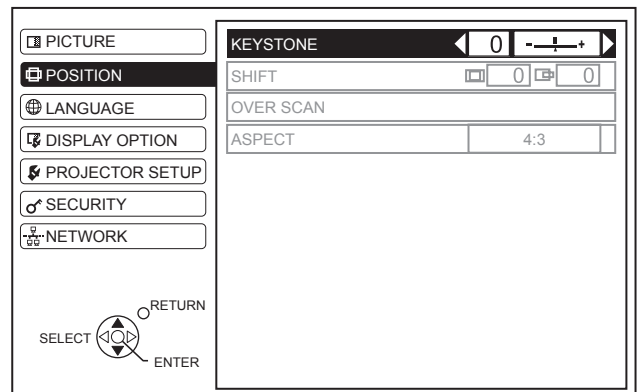

- Press **◀ ▶** to adjust or set the selected item.
 - For items using a bar scale, the current settings are displayed on the left of the bar scale.
 - You can cycle through the options of an item by pressing **◀ ▶**.



- Press the **MENU** or **RETURN** button to return to the previous menu.

NOTE:

- See "Resetting to the factory default settings" on page 27 to reset each menu item.
- See "INITIALIZE ALL" on page 43 to reset all the settings.

PICTURE menu

Remote control

- See “Navigating through the menu” on page 32.
- See “Main menu and Sub-menu” on page 30.

Control panel

PICTURE MODE

Depending on the projection environment, you can use these preset parameter settings to optimise image projection. Press ◀ ▶ to cycle through the options.

STANDARD	Setting for a general image
DYNAMIC	Bright and sharp setting
BLACKBOARD	Setting for when projecting on a blackboard
NATURAL *1	Reproduces the original color of the image
CINEMA *2	Setting for a cinema type movie

*1. Selectable when still image is displayed.

*2. Selectable when moving image is displayed.

NOTE:

- It may take for a while until the image stabilized in the selected mode.

CONTRAST

You can adjust the contrast of the projected image. Adjust the **BRIGHTNESS** in advance if necessary.



BRIGHTNESS

You can adjust the brightness of the projected image.



COLOR

You can adjust the color saturation of the projected image. (Available with **VIDEO/S-VIDEO/YPbPr/RGB** movie/**DVI** movie signals only)



TINT

You can adjust the skin tone in the projected image. (Available with **VIDEO/S-VIDEO/YPbPr/RGB** movie/**DVI** movie signals only)



SHARPNESS

You can adjust the sharpness of the projected image.



WHITE BALANCE RED

You can adjust the white balance more properly in red color temperature by pressing ◀ ▶. (Available with **RGB/DVI** still signals only)

WHITE BALANCE GREEN

You can adjust the white balance more properly in green color temperature by pressing ◀ ▶. (Available with **RGB/DVI** still signals only)

WHITE BALANCE BLUE

You can adjust the white balance more properly in blue color temperature by pressing ◀ ▶. (Available with **RGB/DVI** still signals only)

PICTURE menu

COLOR TEMPERATURE

You can adjust the white balance of the projected image.

- **LOW** More bluish
- **DEFAULT** Balanced white
- **HIGH** More reddish

DAYLIGHT VIEW

You can keep the projected image bright and vivid even in well-lit rooms where the ambient light sources cannot be controlled, such as when a door opens or when window coverings fail to block out sunlight.

- **AUTO:** Automatic adjustment
- **ON:** Active
- **OFF:** Deactive

NOTE:

- Do not cover the Ambient Luminance Sensor (ALS) of the projector. See "Ambient Luminance Sensor (ALS)" on page 12.
- **AUTO** is not available when **INSTALLATION** setting in **OPTION** menu is set to **REAR/DESK** or **REAR/CEILING**.

DIGITAL CINEMA REALITY

You can improve the vertical resolution of a 2-2 or 2-3 pulldown movie. Press ◀ ▶ to select the required setting. (Not available with **NETWORK** signals)

- **OFF** Deactive
- **ON** Active

NOTE:

- Available with 480i, 576i, 1 080/60i and 1 080/50i only.

NOISE REDUCTION

You can switch the automatic noise reduction system on/off. Press ◀ ▶ to select the required setting.

- **ON:** Automatic noise reduction
- **OFF:** No noise reduction

NOTE:

- Applying noise reduction may affect image quality.

TV-SYSTEM

When the video signal is changed, the setting switches automatically. You can switch the setting manually to match the video data. Press ◀ ▶ to cycle through the options. (Available with **S-VIDEO/VIDEO** only)

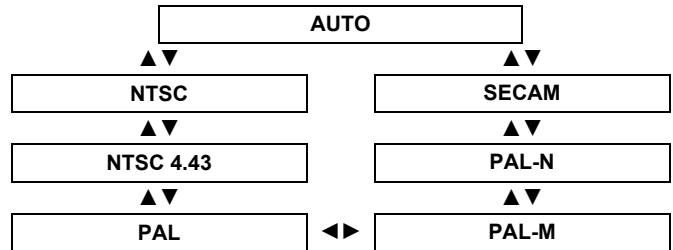

NOTE:

- **AUTO** setting will select from **NTSC/NTSC 4.43/PAL/PAL60/PAL-M/PAL-N/SECAM**.

RGB/YPbPr

The projector will detect the signal from the **COMPUTER** terminals if the signal is **RGB** or **YPbPr**. You can turn off the automatic detecting system and switch between **RGB** and **YPbPr** manually.

- **AUTO:** Automatic detecting system
- **RGB:** Project as **RGB** signal
- **YPbPr:** Project as **YPbPr** signal

NOTE:

- Available with VGA60, 480i, 576i, 480p, 576p, 1 080/60i, 1 080/50i, 720/60p, 720/50p, 1 080/60p, 1 080/50p only.
- When the input signal is not selected correctly with **AUTO** setting, select **RGB** or **YPbPr** manually.

POSITION menu

Remote control

Control panel

- See “Navigating through the menu” on page 32.
- See “Main menu and Sub-menu” on page 30.

KEYSTONE

If the projector is aligned non-perpendicularly to the screen, or if the projection screen has an angled surface, you can correct keystone.

Image	Operation

NOTE:

- You can correct the distortion ± 30 degrees from the plane. For a better quality image, installing the projector with a minimum of distortion is recommended.
- Some distortion may be retained for lens shift adjustment.
- The distortion of the main menu screen is not correctable.
- The result of the keystone correction will affect the aspect ratio and the size of the image.

SHIFT

You can move the projected image for fine adjustment. Press $\blacktriangleleft \blacktriangleright$ to move horizontally and $\blacktriangle \blacktriangledown$ vertically. (Not available with **NETWORK** signals)

	SHIFT	H	
		V	

DOT CLOCK

If you have interference patterns of the projected image, which is sometimes referred to as moire or noise, you can minimize it by pressing $\blacktriangleleft \blacktriangleright$ to adjust the clock frequency. (Available with signals of **RGB/DVI** still only)

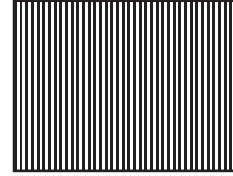

NOTE:

- If the projecting signal's dot clock frequency is higher than 150 MHz, the adjustment may not make a difference.
- **DOT CLOCK** needs to be adjusted before adjusting the **CLOCK PHASE**.

CLOCK PHASE

If you require further adjustment for the same reason as the **DOT CLOCK** adjustment, you can fine adjust the timing of the clock. Press $\blacktriangleleft \blacktriangleright$ to adjust. (Available with signals of **RGB/DVI** still only)

NOTE:

- If the projecting signal's dot clock frequency is higher than 150 MHz, the adjustment may not make a difference.

OVER SCAN

If the 4 edges of an image is partly dropped, you can use this function to adjust and project it properly. (Not available with signals of **NETWORK**)

- \blacktriangleleft Shrink
- \blacktriangleright Enlarge

ASPECT

You can switch the aspect ratio manually when needed. Press ◀ ▶ to cycle through the options.

■ **Aspect ratio options**

● **AUTO**

Signals which contains an identifying aspect signal will be detected and automatically project the image in proper ratio. (NTSC and 525i (480i) signals only)

● **4:3**

When a 4:3 or 5:4 signal is detected, the image will be projected without any change, and other signals will be adjusted to 4:3 with preserving original ratio.

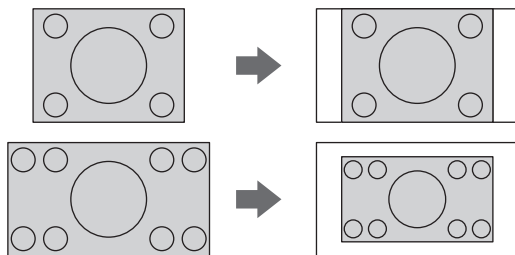

● **16:9**

When a 16:9 is input, the image will be projected without any change, and other signals will be adjusted to 16:9 without preserving original ratio.

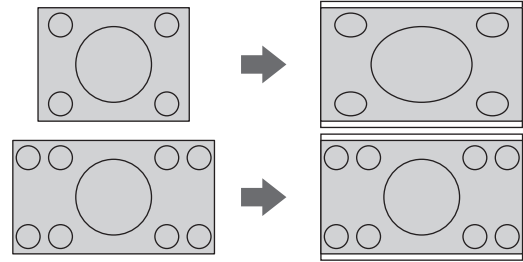

● **S4:3**

The input signal will be sized down 75 % and projected. When projecting 4:3 signal on to a 16:9 screen, it will be sized down 75 % with preserving original ratio.

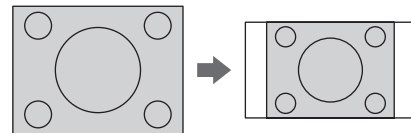

● **THROUGH**

The image will be projected without any size adjustment.

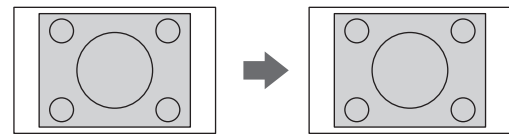

NOTE:

- If you project an image with an unmatched aspect ratio, the image may distort or some portions may be cropped. Select an aspect ratio which preserves the intention of the image creator.
- The order of **ASPECT** types is defined not only by the input method but also by the input signals. See “List of compatible signals” on page 52.
- If you project a copyrighted image enlarged or distorted by using **ASPECT** function in commercial use in a public place, such as a restaurant or hotel, you might infringe on the copyright of the creator which is protected by copyright law.
- Selectable aspect ratio options vary according to input signals.

FRAME LOCK

If the projected image is degraded, you can activate **FRAME LOCK** for synchronisation. Press ◀ ▶ to select the required option. (Available with **RGB/DVI** signals only)

- **OFF** Deactive
- **ON** Active

DISPLAY OPTION menu

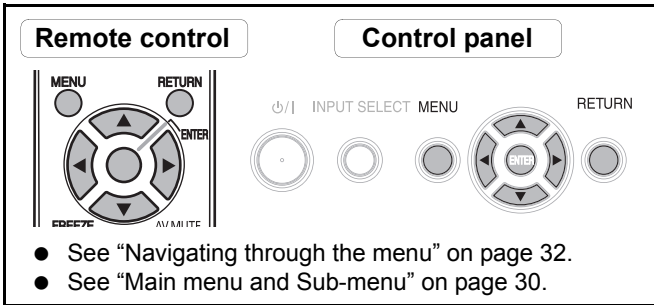

ON-SCREEN DISPLAY

INPUT GUIDE

When you change the input method, the guidance appears in the upper right corner of the screen. The following display methods are available. Press ◀ ▶ to cycle through the options.

Options	Function
DETAILED	Display the input method by graphic. The INPUT GUIDE will go out after 3 seconds without any operation. If you select any COMPUTER or DVI terminal which has no signal, the computer connection guidance will be displayed. See “Computer connection guidance” on page 54.
SIMPLE	Display the input method by text. The INPUT GUIDE will go out after 3 seconds without any operation.
OFF	Turn off the guidance.

OSD DESIGN

You can change the background color of the menu. Press ◀ ▶ to select the required option.

TYPE1	Semi transparent black
TYPE2	Solid blue
TYPE3	Semi transparent dark blue

WARNING MESSAGE

You can let display only the minimum warning messages and hide others.

- **ON** All of the warning messages will be displayed.
- **OFF** Only the minimum warning messages will be displayed.

NOTE:

- When the **WARNING MESSAGE** is set to **OFF**, use the projector with utmost care due to the most of warning messages will not be displayed.

DVI-D IN

NOTE:

- The **DVI-D IN** setting for the best quality depends on the output equipment. Refer the instructions of the connected equipment.
- **DVI** signal is very sensitive, and malfunction may occur or other problems could be encountered with some **DVI** equipment.

DVI EDID

You can switch the EDID setting and signal level for variable **DVI** signals.

- **EDID1** 480p, 576p, 1 080/60i, 1 080/50i, 720/60p, 720/50p, 1 080/60p, 1 080/50p
- **EDID2(PC)** VGA60, SVGA60, XGA60, XGA70, XGA75, WXGA768/60, SXGA60, SXGA60+, WXGA800/60

DVI SIGNAL LEVEL

- **0-255:PC** (PC scale) For connecting to a computer via **DVI-D IN** terminal.
- **16-235** (TV scale) For connecting to AV equipment via **DVI-D IN** terminal, such as DVI - HDMI connection.

CLOSED CAPTION SETTING

If the input signal contains closed captions, you can turn on the feature and switch the channels.

CLOSED CAPTION

- **OFF** Deactive
- **ON** Active

MODE

- **CC1 - 4** Change the channels **CC1 - 4**

NOTE:

- VCR with TBC (Time Base Corrector) function is recommended for video cassette tapes.

STARTUP LOGO

You can switch the logo on/off that is displayed when starting up the projector. Press ◀ ▶ to select the required option. **STARTUP LOGO** will be displayed for 30 seconds.

- **ON** Active
- **OFF** Deactive
- **USER** Display the original text

● Editing the original text

If you select **USER**, you can display the 2 lines of original text up to 40 characters in 1 line instead of the logo.

1. Select **USER** and press **ENTER**.
2. Select the required line to enter or edit the original text, and press the **ENTER** button.
3. Enter the characters and repeat until finish the line.
 - Use ▲ ▼ ◀ ▶ to specify the location of the required character, and press the **ENTER** button.
 - Move the cursor to **ALL DELETE** and press the **ENTER** button to delete all the entered text line.
 - Press the **DEFAULT** button to delete the last entered character or indicated with the cursor in the text line.
 - To insert a character in the entered text line, move the cursor to the text box to select the required place and press ▼ to select a character.
4. Select **OK** and press the **ENTER** button to set the entered text in a box.
 - Press ▼ and edit the **TEXT2** if you need to, and repeat the step 3.

AUTO SETUP

You can turn off the **AUTO SETUP** button function for when the **COMPUTER** signal is detected.

- **AUTO** When the projector detects a **COMPUTER** or **DVI** signal, adjust the projected image position automatically for **SHIFT**, **SIGNAL SEARCH**, **DOT CLOCK** and **CLOCK PHASE**.
- **BUTTON** Only when the **AUTO SETUP** button is pressed, the projected image position will be adjusted for **DOT CLOCK** and **CLOCK PHASE**. See "Remote control" on page 14.

NOTE:

- Usually the recommended setting is **AUTO**.

SIGNAL SEARCH

You can turn off the auto signal detecting system.

- **ON** Detect the input signal from the terminals and project the image.
- **OFF** Deactive

NOTE:

- **SIGNAL SEARCH** is not available when any input signal is projecting.
- Usually the recommended setting is **ON**.

BACK COLOR

You can choose a **BLUE** or **BLACK** screen for when the projector is idle. Press ◀ ▶ to select the required option.

WIDE MODE

When projecting **WIDE** signals, switch to **ON** to display the image in well adjusted size.

- **AUTO** Automatic detective system
- **OFF** For 4:3 signals
- **ON** For **WIDE** signals (16:9, 16:10 and 15:9)

SXGA MODE

You can switch the projection mode between **SXGA+** and **SXGA** for **SXGA** signals. Press ◀ ▶ to select the required option.

- **SXGA** Smaller setting
- **SXGA+** Larger setting

DISPLAY OPTION menu

OTHER FUNCTIONS

From menu operation, you can apply to the functions, which are only for the remote control.

Menu items	Refer
AUTO SETUP	See page 25.
FREEZE	See page 27.
AV MUTE	See page 27.
INDEX-WINDOW	See page 27.
DIGITAL ZOOM	You can enlarge the projected image. Press ◀ ▶ to adjust the size, and press the ENTER button. Press the RETURN button to return to the normal projection.

PROJECTOR SETUP menu

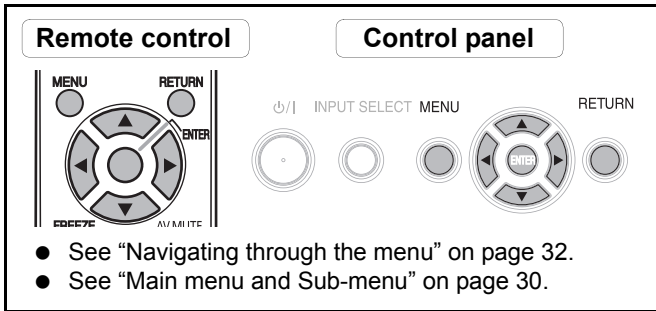

STATUS

You can see the status of the projector about the following items.

Items	Description
SIGNAL	
NAME	Projecting signal name
FREQUENCY	Projecting signal frequency
RUNTIME	
PROJECTOR	Duration of projector used time
LAMP	Duration of lamp used time
REMAINING FILTER	
QUANTITY	Quantity of filter remaining
APPROX.TIME	Approximately time of filter remaining

NOTE:

- **QUANTITY** and **APPROX.TIME** of **REMAINING FILTER** is not the accurate but the calculated and predicted result based on the filter rolling pace. Incorrect remaining time could be displayed briefly; such as suddenly shortened or stays same for a while.
- Replacement of the Auto Cleaning Filter (ACF) needs to be prepared when the **QUANTITY** and **APPROX.TIME** of **REMAINING FILTER** becomes few.

COMPUTER2 SELECT

You can switch the function of the **COMPUTER2 IN/1 OUT** terminal.

- **INPUT** **COMPUTER2 IN**
- **OUTPUT** **COMPUTER1 OUT**

NO SIGNAL SHUT-OFF

You can set the timer to switch off the power of the projector after a certain period of time automatically when no signal is detected. Press ◀ ▶ to select the required period from 15 to 60 minutes at intervals of 5 minutes.

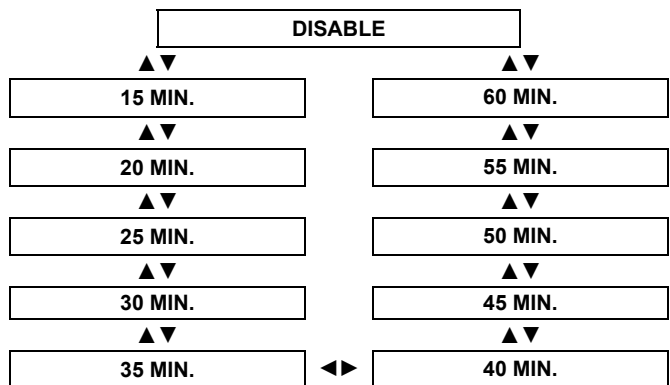

INITIAL START UP

You can select how the projector start when the power cord is connected.

Options	Description
LAST MEMORY	Start as the same mode as the last switched off.
STANDBY	Always start in standby mode.
ON	Always start in projecting mode.

PROJECTOR SETUP menu

INSTALLATION

When installing the projector, select the projection method according to the projector position. Press ◀ ▶ to cycle through the options. See "Projection method" on page 16.

FRONT/DESK	Setting on a desk/floor and projecting from front
FRONT/CEILING	Mounting on the ceiling and projecting from front
REAR/DESK	Setting on a desk/floor and projecting from rear
REAR/CEILING	Mounting on the ceiling and projecting from rear

HIGH ALTITUDE MODE

If you use the projector at high elevation, the **HIGH ALTITUDE MODE** setting needs to be **ON** to set the fan speed high. Press ◀ ▶ to select the required option.

- **OFF** The fan speed is low.
- **ON** The fan speed is high.

NOTE:

- At 1 400 m (4 593 ft) above sea level, the setting must be **ON**.
- The loudness of fan noise depends on the **HIGH ALTITUDE MODE** setting.

EMULATE

You can switch to the Panasonic past model's control commands for COMPUTER connection.

DEFAULT	F100, FW100, F200, F300, FW300 models
D3500	D3500 models
D4000	D4000 models
D/W5K series	D5500, DW5000, D5600, DW5100, D5700 models
L730	L520, L720 models
L780	L750, L780 models
L735	L735 models
L785	L785 models
LB/W80	LB75, LB80, LW80 models

FUNCTION BUTTON

You can assign a certain menu function to the **FUNCTION** button as shortcut. Press ◀ ▶ to select the required menu option, and the **ENTER** button.

Options	Functions	Refer
DISABLE	Deactivate the FUNCTION button.	-
ASPECT	Display the ASPECT menu.	36
PICTURE MODE	Display the PICTURE MODE menu.	33
DAYLIGHT VIEW	Display the DAYLIGHT VIEW menu.	34
CLOSED CAPTION	Press to turn on/off the CLOSED CAPTION .	38

NOTE:

- Without any operation for 5 seconds, the displayed menu will be disappeared.

AUDIO SETTING

VOLUME

You can adjust the volume of the built-in monaural speaker and **VARIABLE AUDIO OUT** terminal.

- ◀ Decrease
- ▶ Increase

BALANCE

You can adjust to hear the sound played equally through both right and left from **VARIABLE AUDIO OUT**, or shift the balance so more sound plays through the left or right side.

- ◀ More sound plays through the left side
- ▶ More sound plays through the right side

IN STANDBY MODE

You can switch on/off the sound output in standby mode.

- **OFF** No sound in standby mode.
- **ON** Output audio in standby mode.

AUDIO IN SELECT

You can switch the audio output method for **COMPUTER1 IN**, **COMPUTER2 IN** and **DVI-D IN** terminals.

● DVI

- **COM.AUDIO IN 2** Output audio that is input to the **COMPUTER AUDIO 2**.
- **AUDIO IN** Output audio that is input to the **AUDIO IN**.

● COMPUTER1

- **COM.AUDIO IN 1** Output audio that is input to the **COMPUTER AUDIO 1**.
- **AUDIO IN** Output audio that is input to the **AUDIO IN**.

● COMPUTER2

● COM.AUDIO IN 2

Output audio that is input to the **COMPUTER AUDIO 2**.

● AUDIO IN

Output audio that is input to the **AUDIO IN**.

TEST PATTERN

You can use the 7 different test patterns to adjust the focus of the image. See "Lens shift and positioning" on page 17.

1. Press the **ENTER** button to display the test pattern 1.
2. Press ◀ ▶ to select the required test pattern.
3. Adjust the focus with the focus lever.
4. Press the **MENU** or **RETURN** button to return to the previous menu, or press repeatedly to escape from the menu mode.

NOTE:

- When the projector and/or the screen is tilted, adjust the focus at the center of the image. The upper and lower edge might be out of focus.
- When the image is distorted in keystone, adjust the **KEYSTONE** in **POSITION** menu.

INITIALIZE ALL

You can reset all of the customized settings to the factory defaults except **NETWORK**, **RUNTIME** and **REMAINING FILTER** of **STATUS** in **PROJECTOR SETUP** menu.

1. Press the **ENTER** button.
2. Select **OK** by pressing ◀, then press the **ENTER** button.
3. Turn off the power by pressing the power button.
4. Switch off the **MAIN POWER** button to reset the projector.
5. Switch on the **MAIN POWER** button.
6. Press the power button.
7. The minimum required setting screen will be displayed.
 - See "Minimum required setting screen" on page 11.

NOTE:

- The security system is deactivated by default and when initialized.
- When the projector is initialized, it will be reset to the factory default password operation.

FILTER COUNTER RESET

After you replaced the Auto Cleaning Filter (ACF), **REMAINING FILTER** of **STATUS** in **PROJECTOR SETUP** need to be reset to "0".

1. Press the **ENTER** button for more than 3 seconds.
 - The confirmation screen will be displayed.
2. Select **OK** by pressing ◀, then press the **ENTER** button.
3. Display the **STATUS** and confirm the figure.

SECURITY menu

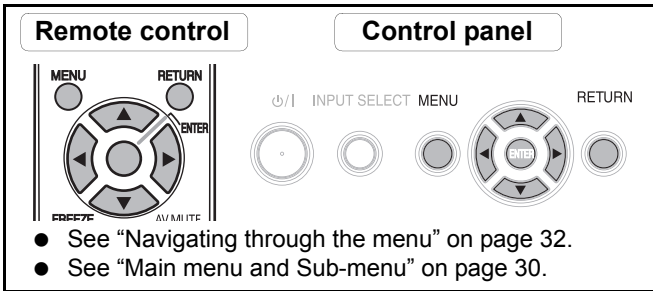

Entering the SECURITY menu

Every time when you apply to the **SECURITY** menu, you will be asked to perform the password operation.

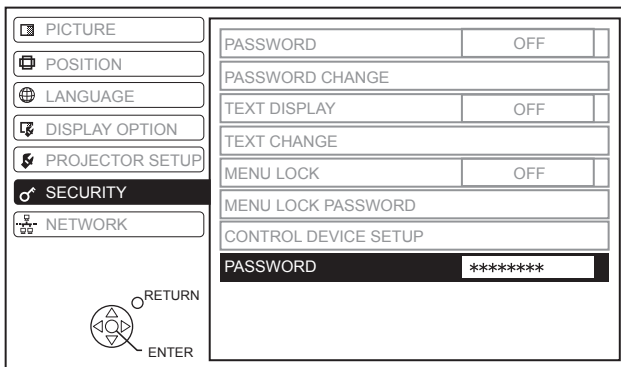

When you apply to the **SECURITY** menu before you change the password to your original, perform to input the following factory default password operation.

- Press ▲▶▼◀▲▶▼◀ and the **ENTER** button.

After you change the password

When you apply to the **SECURITY** menu after you change the password to your original in the **PASSWORD CHANGE** menu, input the original password operation.

NOTE:

- The factory default password is valid until you change the password in **PASSWORD CHANGE** menu.
- The entered password operations will appear as asterisks in the box.

PASSWORD

You can activate the security system and the password operation will be asked to perform when the projecting mode started. Unless you perform the correct password operation, all of the button controls will be disabled except the power button.

- **OFF** Deactive
- **ON** Active

NOTE:

- When you activated the security system, make sure to change the password to your original for safety.
- The factory default password is valid until you change the password in **PASSWORD CHANGE** menu.

PASSWORD CHANGE

You can change the password operation to your original.

1. Press a series of button operation up to 8 as a password by using ▲▼◀▶.
2. Press the **ENTER** button.
3. Press the exact same series of button operation you entered in the **NEW** password box for confirmation.
 - If a series of button operation is incorrect, you will be asked to perform again.
4. Press the **ENTER** button.

NOTE:

- The entered password operations will appear as asterisks in the box.

TEXT DISPLAY

You can set your original text, such as company name or URL information, to display regularly at the bottom of the projected image while projecting.

- **OFF** Deactive
- **ON** Active

TEXT CHANGE

You can enter your original text up to 22 characters for **TEXT DISPLAY**.

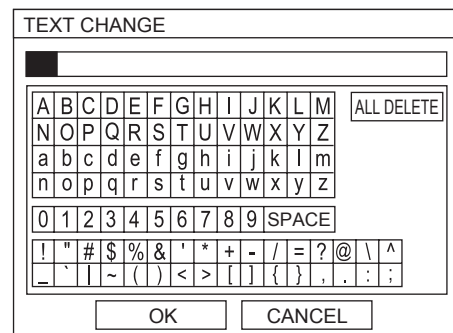

1. Enter your original text.
 - Use ▲▼◀▶ to specify the location of the required character.
 - Move the cursor to **ALL DELETE** and press the **ENTER** button to delete all the entered text line.
 - Press the **DEFAULT** button to delete the last entered character or indicated with the cursor in the text line.
 - To insert a character in the entered text line, move the cursor to the text box to select the required place and press ▼ then perform step 2.
2. Press the **ENTER** button.
 - The selected character will be displayed in the **TEXT CHANGE** box.
3. Repeat until finish your original text.
4. Select **OK** and press the **ENTER** button to set the entered text.
 - Select **CANCEL** or press the **MENU/RETURN** buttons to return to the previous menu.

MENU LOCK

You can lock the **MENU** button function and the password will be asked to display the menu every time.

- **OFF** Deactivate the **MENU LOCK** system.
- **ON** Activate the **MENU LOCK** system.

NOTE:

- The factory default password is “AAAA”.
- The factory default password is valid until you change the password in **MENU LOCK PASSWORD** menu.
- When the projector is initialized, the **MENU LOCK** will be deactivated.

MENU LOCK PASSWORD

You can change the password for **MENU LOCK** system to your original.

1. Press the **ENTER** button.
2. Enter the original password.
 - Use **▲ ▼ ◀ ▶** to specify the location of the required character, and press the **ENTER** button.

MENU LOCK PASSWORD

█

A	B	C	D	E	F	G	H	I	J	K	L	M	ALL DELETE		
N	O	P	Q	R	S	T	U	V	W	X	Y	Z			
a	b	c	d	e	f	g	h	i	j	k	l	m			
n	o	p	q	r	s	t	u	v	w	x	y	z			
0	1	2	3	4	5	6	7	8	9	SPACE					
!	"	#	\$	%	&	'	*	+	-	/	=	?@	\	^	
_	`		~	()	<	>	[]	{	}	,	.	:	;

OK CANCEL

3. Repeat step 2 until you finish the text line.
 - You can enter up to 16 characters.
 - Move the cursor to **ALL DELETE** and press the **ENTER** button to delete all the entered text line.
 - Press the **DEFAULT** button to delete the last entered character or indicated with the cursor in the text line.
 - To insert a character in the entered text line, move the cursor to the text box to select the required place and press **▼** then perform step 2.
4. Select **OK** and press the **ENTER** button to set the password.

CONTROL DEVICE SETUP

NOTE:

- If you disable both of the control panel and remote control buttons, you cannot return to the standby mode. Use this function with utmost care.
- If you press a disabled button, you will be asked to perform the security password operation. The password screen will disappear after 10 seconds without any operation.

CONTROL PANEL

You can disable the control panel buttons on the projector body. Press **◀** or **▶** to switch the option.

- **ENABLE** Enable the control panel buttons.
- **DISABLE** Disable the control panel buttons. The confirmation screen will be displayed. Select **OK** by pressing the **◀**, and the **ENTER** button.

NOTE:

- You can enable the disabled control panel buttons by performing the control panel button operation. While pressing the **ENTER** button, press the **MENU** button for 2 seconds.

REMOTE CONTROLLER

You can disable the remote control buttons. Press **◀** or **▶** to switch the option.

- **ENABLE** Enable the remote control buttons.
- **DISABLE** Disable the remote control buttons. The confirmation screen will be displayed. Select **OK** by pressing the **◀**, and the **ENTER** button.

NETWORK menu

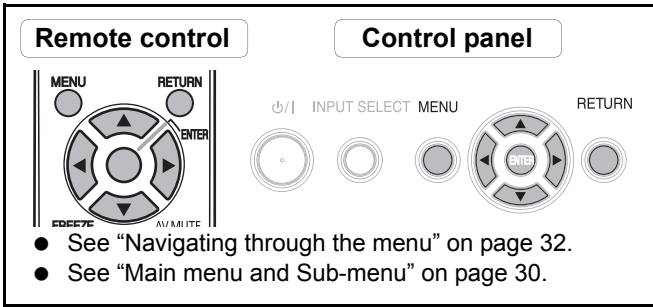

NOTE:

- See more detailed instructions in the contents of the **CD-ROM** which is provided with the projector.

Items in NETWORK menu

In **NETWORK** menu, the following items are available.

- **WIRED LAN**
- **WIRELESS LAN** (PT-F300NTU only)
- **NAME CHANGE**
- **PASSWORD**
- **PASSWORD CHANGE**
- **NETWORK STANDBY**
- **NETWORK CONTROL**
- **LIVE MODE CUT IN**
- **COMPUTER SEARCH**
- **MULTI-LIVE**
- **STATUS**
- **INITIALIZE**

NOTE:

- When you activated the security system in **SECURITY** menu, you need to perform the security password operation to initialise via network.

TEMP, LAMP and FILTER Indicators

Managing the indicated problems

If a problem should occur with the projector, the **TEMP**, **LAMP** and/or **FILTER** indicators will inform you. Manage the indicated problems as follow.

1. Confirm the status of all indicators and projector, and switch off the projector in proper way.
2. Find out the cause of the problem by status of the **TEMP**, **LAMP** and/or **FILTER** indicators.
3. Follow the instruction for each indication below and solve the problem.
4. Turn on the projector in the correct way and confirm the indicator is not indicating a problem any longer.

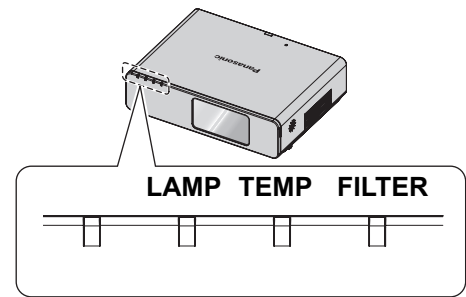

NOTE:

- If no problem is found or the problem remains, do not turn on the projector. Instead contact an Authorized Service Center.

LAMP indicator

Indicator	● Illuminating red	● Flashing red		
Problem	RUNTIME of STATUS in the PROJECTOR SETUP menu has reached 5 000 hours.	LAMP circuit failure, abnormal function or lamp unit is damaged.		
Cause	Lamp unit will run out soon and needs to be replaced.	The MAIN POWER is switched on again before the lamp unit is cooled enough.	Lamp circuit failure, abnormal function.	Lamp unit is damaged.
Remedy	See "Replacing the Lamp unit" on page 48.	Let the lamp unit cool down and turn on the MAIN POWER after 90 seconds.	Contact an Authorized Service Center.	See "Replacing the Lamp unit" on page 48.

TEMP indicator

Indicator	● Illuminating red while projecting and the alert will be displayed. ● Flashing red and power is turned off		
Problem	The temperature inside and/or outside the projector is abnormally high.		
Cause	The ventilation openings are covered.	The room temperature is too high.	The projector is located at high elevations (above 1 400 - 2 700 m).
Remedy	Remove the object(s) from the ventilation openings or clear around the projector.	Reinstall the projector in temperature controlled place. See page 58.	Turn on the projector* ¹ and set the HIGH ALTITUDE MODE to ON . See page 42.

*1. The projector will perform only 2 minutes with OFF setting at high elevation.

FILTER indicator

When the **FILTER** indicator is flashing green, the Auto Cleaning Filter (ACF) is normally rolling up.

Indicator	● Illuminating red	● Flashing red	● Flashing orange	● Illuminating orange
Problem	REMAINING FILTER has turned red. See page 41.	Detect no ACF or abnormal ACF.	The ACF cannot operate properly.	REMAINING FILTER has turned yellow. See page 41.
Cause	ACF has been run out.	ACF is not attached or the attached ACF is dysfunctional.	Foreign object is blocking the ACF operation.	ACF is running out.
Remedy	See "Replacing the Auto Cleaning Filter (ACF)" on page 49.	Attach the ACF or replace to new ACF.	Remove the foreign object or contact an Authorized Service Center.	Prepare the ACF for replacement.

Care and Replacement

Cleaning the projector

Before cleaning the projector

- Switch off the **MAIN POWER** and disconnect the power plug from the wall outlet.
- Unplug all the cables from the projector.

Cleaning the outer surface of the projector

Wipe off dirt and dust gently with a soft cloth.

- If it is difficult to remove the dirt, soak a cloth with water, wring the cloth well and then wipe the projector. Dry off the projector with dry cloth.
- If you use a chemical treated wipe, follow the instructions supplied with it.

Cleaning the lens and front glass surface

Wipe off dirt and dust gently with a lint-free cloth.

- Make sure no dirt or dust remains on the surface of the lens. It will be enlarged and projected onto a screen.

Replacing the Lamp unit

Before replacing the Lamp unit



- Switch off the **MAIN POWER** and disconnect the power plug from the wall outlet.
- Wait for more than 1 hour and make sure the lamp unit and the surroundings are cooled enough.
- Prepare a Phillips-head screwdriver.
- Contact an Authorized Service Center to purchase a replacement lamp unit (ET-LAF100).
- When the projector is mounted on the ceiling, do not work directly under the projector or put your face closer to the projector.

NOTE:

- Prior to replacing the lamp unit, allow it to cool down to prevent the risk of burns, damage and other hazards.
- Do not attempt replacement with an unauthorized lamp unit.

When to replace the lamp unit

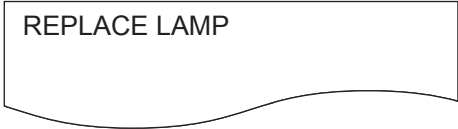
The lamp unit is consumable and the brightness decreases by duration of usage. The **LAMP** indicator will inform you of the replacement timing at 5 000 hours, and at 6 000 hours, the projector will be turned off. Those figures are rough guidance and might be shortened by the usage conditions, characteristics of the lamp unit, environmental conditions, and so on. You can check the duration of usage time using **RUNTIME** of **STATUS** in the **PROJECTOR SETUP** menu.

Indication	On screen	LAMP indicator
		
Over 5 000 hours	"REPLACE LAMP" is displayed on the upper left of the screen for 10 minutes.	Illuminates red.
Over 6 000 hours	"REPLACE LAMP" is displayed on the upper left of the screen, and it will stay until you respond. To clear the screen, press any button.	

NOTE:

- The guide times, 5 000 and 6 000 hours, are rough estimates based on certain conditions and are not a guaranteed time.
- For more information about the lamp unit, such as guaranteed time, see the instructions which is provided with the lamp unit.

Replacement procedure

Removing and replacing the lamp unit

1. Use a Phillips-head screwdriver to loosen the 2 lamp unit cover fixing screws on the back of the projector until the screws turn freely, and remove the lamp unit cover.

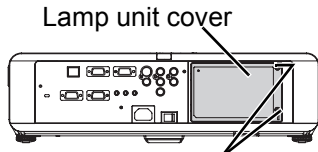

Lamp unit cover fixing screws

2. Use a Phillips-head screwdriver to loosen the 2 lamp unit fixing screws.
3. Hold the handles of the lamp unit and release the lamp unit lock.
4. Pull the used lamp unit gently from the projector.

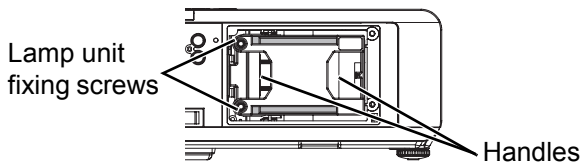

5. Replace the new lamp unit in correct direction.
 - **RUNTIME** of **STATUS** in the **PROJECTOR SETUP** menu will be reset to "0" automatically.

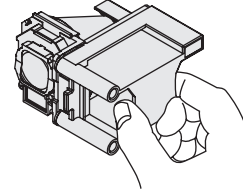

6. Press in the lamp unit until it clicks and make sure the unit is installed securely.
7. Tighten the 2 lamp unit fixing screws securely with a Phillips-head screwdriver.

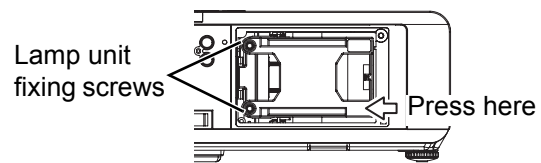

8. Attach the lamp unit cover and tighten the 2 lamp unit cover fixing screws securely with a Phillips-head screwdriver.

Replacing the Auto Cleaning Filter (ACF)

Before replacing the ACF

- Wait until the cooling fan stops and the power indicator turn to red.
- Disconnect the power cord from the wall outlet.
- Prepare a Phillips-head screwdriver.
- Contact an Authorized Service Center to purchase a replacement ACF (ET-ACF100).

When to replace the ACF

ACF is consumable product and effects on ventilation. The **FILTER** indicator will inform you of the replacement timing. You can check the remaining amount of the ACF in **REMAINING FILTER** of **STATUS** in **PROJECTOR SETUP** menu.

NOTE:

- See "WARNING MESSAGE" on page 38.
- See "REMAINING FILTER" on page 41.
- See "FILTER indicator" on page 47.
- The ACF operational sound may be heard.
- While the ACF is operating, the **FILTER** indicator will flash in green.
- When the **FILTER** indicator illuminate in orange, the remaining time of the ACF is less than 200 hours. This is rough estimated time and it depends on environment of usage. Contact an Authorized Service Center to purchase a replacement ACF.
- If you use the projector at 1 400 m (4 593 ft) above sea level, it may cause malfunction of the ACF.
- If you keep using the projector after the **FILTER** indicator illuminating in red, the indicator will start to flash in red for 10 minutes and the projector will be switched off.

Care and Replacement

Replacement procedure

1. Turn the projector upside down and place it gently on a soft cloth.
2. Use a Phillips-head screwdriver to loosen 3 ACF cover fixing screws until the screws turn freely and remove the ACF cover.

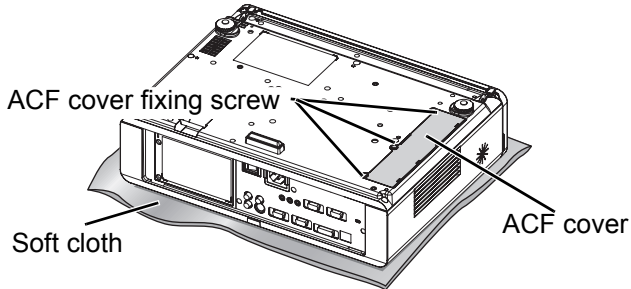

3. Release the lock by pushing in the lock clamp to inside, and slide out the ACF unit from the projector slowly.
4. Insert the new ACF unit into the compartment in correct direction and slightly push down until it clicks. Tighten an ACF fixing screw securely with a Phillips-head screwdriver.
5. Attach the ACF cover and tighten the ACF cover fixing screws securely with a Phillips-head screwdriver.

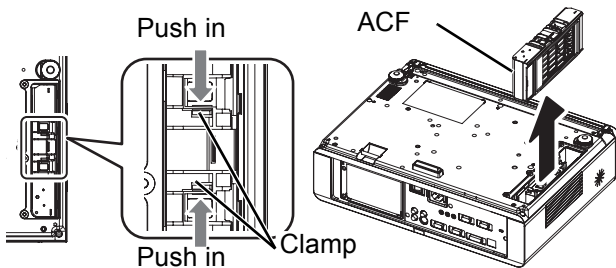

NOTE:

- If the ACF and/or ACF cover are attached incorrectly, the projector may not be turned on.
- Do not switch the power on while the ACF cover removed.
- When you replace the ACF unit, clean the compartment and/or the air exhaust port if you need to.
- The replacement timing of the ACF is 36 000 hours of use at maximum and it depends on environment of usage.

Resetting the REMAINING FILTER

1. Turn on the projector and display the **FILTER COUNTER RESET** in **PROJECTOR SETUP**.
2. Press the **ENTER** button for more than 3 seconds.
 - The confirmation screen will be displayed.
3. Select **OK** by pressing **◀**, then press the **ENTER** button.
4. Display the **STATUS** and confirm the figure.

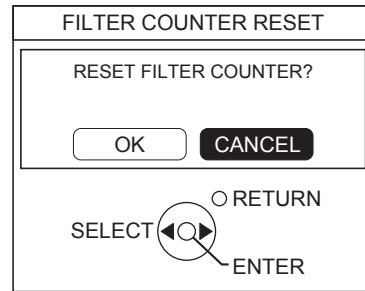

Troubleshooting

Should any problem persist, contact your dealer.

Problem	Cause	Reference page
Power does not turn on.	● The power cord may not be connected.	21
	● The MAIN POWER switch is turned off.	23
	● No electric supply is at the wall outlet.	21
	● TEMP indicator is lit or flashes.	47
	● LAMP indicator is lit or flashes.	47
	● The lamp unit cover has not been securely installed.	49
No picture appears.	● The video signal input source may not be connected to a terminal properly.	-
	● The input selection setting may not be correct.	20
	● The BRIGHTNESS adjustment setting may be at the minimum setting.	26
	● The AV MUTE function may be in use.	33
The picture is fuzzy.	● The AV MUTE function may be in use.	27
	● The lens focus may not have been set correctly.	24
	● The projector may not be at the correct distance from the screen.	15
The color is pale or grayish.	● The lens may be dirty.	9
	● The projector may be tilted too much.	17
The color is pale or grayish.	● COLOR or TINT adjustment may be incorrect.	33
	● The input source which is connected to the projector may not be adjusted correctly.	30
No sound can be heard from the internal speaker.	● COLOR or TINT adjustment may be incorrect.	33
	● The input source which is connected to the projector may not be adjusted correctly.	30
	● The audio signal source may not be connected properly.	19
The control buttons of the projector do not operate.	● A cable may be connected to the VARIABLE AUDIO OUT terminal.	13
	● The volume adjustment may be at the lowest possible setting.	29
	● CONTROL PANEL of CONTROL DEVICE SETUP in SECURITY menu is disabled. If you have a loss of the remote control while the CONTROL PANEL is disabled, press and hold the MENU button for 2 seconds with pressing the ENTER button.	45
The remote control does not operate.	● REMOTE CONTROLLER of CONTROL DEVICE SETUP in SECURITY menu is disabled.	45
	● The batteries may be weak.	-
	● The batteries may not have been inserted correctly.	14
	● The remote control signal receptor on the projector may be obstructed.	25
The picture does not display correctly.	● The remote control unit may be out of the operation range.	25
	● The signal format (TV-SYSTEM) may not have been set correctly.	34
	● There may be a problem with the VCR or other signal source.	-
Picture from a computer does not appear.	● A signal which is not compatible with the projector is being input.	52
	● The cable may be longer than the optional cable.	-
	● The external video output from a laptop computer may not be correct. (You may be able to change the external output settings by pressing the [Fn] + [F3] or [Fn] + [F10] keys simultaneously. The actual method varies depending on the type of computer; refer to the documentation provided with your computer for further details.)	54
Picture from a computer DVI-D graphic board does not appear.	● COMPUTER2 SELECT setting in PROJECTOR SETUP menu is not correct.	41
	● The graphic board driver of the computer needs to be updated to the latest version.	-
Picture from a computer DVI-D graphic board does not appear.	● DVI-D IN setting in DISPLAY OPTION menu may be incorrect setting.	38
	● The computer may need to be restarted after switching DVI-D IN setting in DISPLAY OPTION menu of the projector correctly.	-

Technical Information

List of compatible signals

Mode	Display resolution (dots) ^{*1}	Scanning frequency		Dot clock frequency (MHz)	Picture quality ^{*2}	PnP			Format ^{*3}
		H (kHz)	V (Hz)			RGB2	DVI-D EIDI1	DVI-D EIDI2	
NTSC/NTSC 4.43/ PAL-M/PAL60	720 x 480i	15.7	59.9	-	A				V/S
PAL/PAL-N/SECAM	720 x 576i	15.6	50.0	-	A				
525i (480i)	720 x 480i	15.7	59.9	13.5	A				C/Y
625i (576i)	720 x 576i	15.6	50.0	13.5	A				
525p (480p)	720 x 483	31.5	59.9	27.0	A		●		
625p (576p)	720 x 576	31.3	50.0	27.0	A		●		
1 125 (1 080)/60i	1 920 x 1 080i	33.8	60.0	74.3	A		●		
1 125 (1 080)/50i	1 920 x 1 080i	28.1	50.0	74.3	A		●		
1 125 (1 080)/60p	1 920 x 1 080	66.6	59.9	138.5	A				D/C/Y
1 125 (1 080)/50p	1 920 x 1 080	55.6	49.9	141.5	A				
1 125 (1 080)/60p	1 920 x 1 080p	67.5	60.0	148.5	A		●		
1 125 (1 080)/50p	1 920 x 1 080p	56.3	50.0	148.5	A		●		
750 (720)/60p	1 280 x 720	45.0	60.0	74.3	A		●		
750 (720)/50p	1 280 x 720	37.5	50.0	74.3	A		●		
VESA	640 x 400	31.5	70.1	25.2	A				C
	640 x 400	37.9	85.1	31.5	A				
VGA	640 x 480	31.5	59.9	25.2	A	●		●	D/C
	640 x 480	35.0	66.7	30.2	A	●			
	640 x 480	37.9	72.8	31.5	A	●			
	640 x 480	37.5	75.0	31.5	A	●			C
	640 x 480	43.3	85.0	36.0	A				
SVGA	800 x 600	35.2	56.3	36.0	A	●			
	800 x 600	37.9	60.3	40.0	A	●		●	D/C
	800 x 600	48.1	72.2	50.0	A	●			
	800 x 600	46.9	75.0	49.5	A	●			C
MAC	832 x 624	49.7	74.6	57.3	A	●			
XGA	1 024 x 768	39.6	50.1	51.9	AA				
	1 024 x 768	48.4	60.0	65.0	AA	●		●	
	1 024 x 768	56.5	70.1	75.0	AA	●		●	D/C
	1 024 x 768	60.0	75.0	78.8	AA	●		●	
	1 024 x 768	68.7	85.0	94.5	AA				
MXGA	1 152 x 864	64.0	71.2	94.2	A	●			
	1 152 x 864	67.5	74.9	108.0	A				
	1 152 x 864	76.7	85.0	121.5	A				C
MAC	1 152 x 870	68.7	75.1	100.0	A	●			
MSXGA	1 280 x 960	60.0	60.0	108.0	A	●			
SXGA	1 280 x 1 024	64.0	60.0	108.0	A			●	D/C
	1 280 x 1 024	80.0	75.0	135.0	A	●			
	1 280 x 1 024	91.1	85.0	157.5	B				C
SXGA60+	1 400 x 1 050	64.0	60.0	108.0	A				
	1 400 x 1 050	65.1	59.9	122.4	A	●		●	D/C
UXGA	1 600 x 1 200	75.0	60.0	162.0	B	●			
WIDE750 (720)	1 280 x 720	44.8	59.9	74.5	A	●			C
	1 280 x 720	37.1	49.8	60.5	A				
WXGA768	1 280 x 768	39.6	49.9	65.3	A				
	1 280 x 768	47.8	59.9	79.5	A	●		●	D/C
WXGA800	1 280 x 800	41.3	50.0	68.0	A				
	1 280 x 800	49.1	60.2	69.1	A				C
	1 280 x 800	49.7	59.8	83.5	A	●		●	D/C
WXGA+	1 440 x 900	55.9	59.9	106.5	A	●			
WSXGA+	1 680 x 1 050	65.3	60.0	146.3	A	●			C
WUXGA	1 920 x 1 200	74.6	59.9	154.0	B				

*1. The "i" appearing after the resolution indicates an interlaced signal.

*2. The following symbols are used to indicate picture quality.

AA Maximum picture quality can be obtained.

A Signals are converted by the image processing circuit before picture is projected.

B Some loss of data occurs to make projection easier.

*3. The following symbols are used to indicate the format.

V = VIDEO, S = S-VIDEO, D = DVI, C = COMPUTER, Y = YPBPR

Serial terminal

The serial connector which is on the connector panel of the projector conforms to the RS-232C interface specification, so that the projector can be controlled by a personal computer which is connected to this connector.

Connection

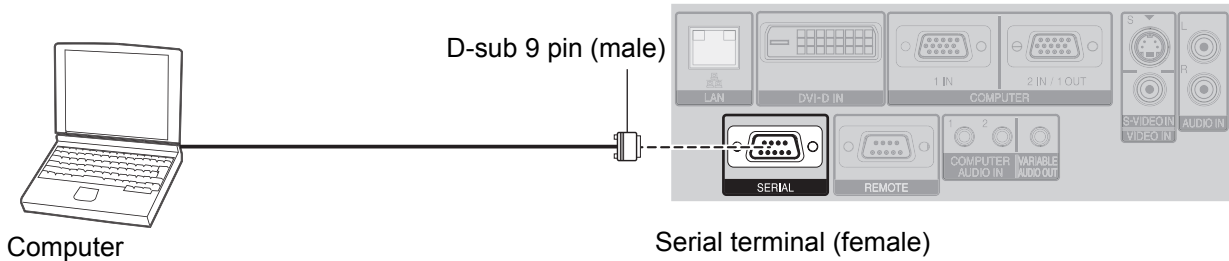

Pin assignments and signal names

	Pin No.	Signal name	Contents
	①		NC
	②	TXD	Transmitted data
	③	RXD	Received data
	④		NC
	⑤	GND	Earth
	⑥		NC
	⑦	RTS	Connected internally
	⑧	CTS	
	⑨		NC

Communication settings

Signal level	RS-232C	Character length	8 bits
Sync. method	Asynchronous	Stop bit	1 bit
Baud rate	9 600 bps	X parameter	None
Parity	None	S parameter	None

Basic format

STX	Command	:	Parameter	ETX
Start byte (02h)	3 bytes	1 byte	1 byte - 4 bytes	End (03h)

The data streaming from the computer will start with STX, and proceed to Command, Parameter and end with ETX. You can add the required parameter.

- The projector can not receive any command for 10 seconds after the lamp is switched on. Wait 10 seconds before sending the command.
- If sending multiple commands, check that a response has been received from the projector for one command before sending the next command.
- When a command which does not require parameters to be sent, the colon (:) is not required.
- If an incorrect command is sent from the personal computer, the ER401 command will be sent from the projector to the personal computer.

Technical Information

Cable specifications

(When connected to a personal computer)

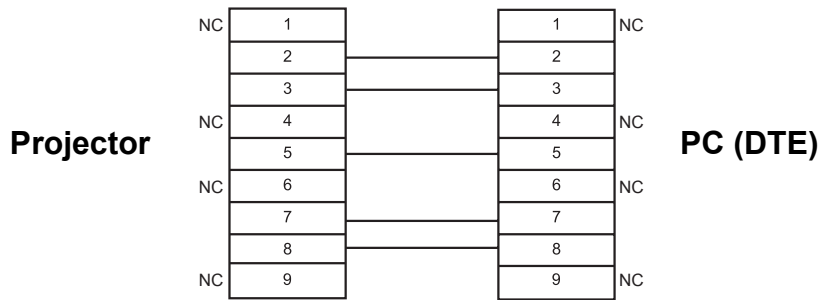

Control commands

Command	Control contents	Remarks
PON	Power ON	In standby mode, all commands other than the PON command are ignored. ● The PON command is ignored during lamp ON control.
POF	Power OFF	If a PON command is received while the cooling fan is operating after the lamp has switched off, the lamp is not turned back on again straight away in order to protect the lamp.
AVL	Volume	Parameter 000 - 063 (Adjustment value 0 - 63)
IIS	INPUT	Parameter: VID = VIDEO RG1 = COMPUTER1 DVI = DVI SVD = S-VIDEO RG2 = COMPUTER2 NWP = NETWORK
Q\$\$	Lamp condition query	Call back 0 = Standby 1 = Lamp ON control active 2 = Lamp ON 3 = Lamp OFF control active
OSH	AV MUTE	Turning off the projection and sound temporarily. Send the command to switch between ON and OFF. Do not send the command consecutively.

Computer connection guidance

You can switch the signals which to output from the **COMPUTER1 OUT** terminal by pressing the computer key command. The key commands are depend on the manufactures. If you select the computer terminals which has no signals while the **INPUT GUIDE** is set to **DETAILED**, the computer connection guidance will be displayed.

Manufacturer	Key command	Manufacturer	Key command	Manufacturer	Key command
Panasonic NEC	Fn + F3	TOSHIBA SHARP HP	Fn + F5	IBM SONY	Fn + F7
				Apple	F7
FUJITSU	Fn + F10	EPSON DELL	Fn + F8	Others	Fn +

NOTE:

- The computer connection guidance will disappear after 5 minutes.
- Please refer the instructions which provided with the computers for more detailed information.

REMOTE terminal

You can remotely operate the projector from the outside the remote control range by connecting to the **REMOTE** terminal.

Pin assignments and signal names

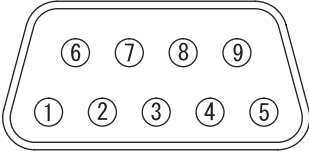
	Pin No.	Signal name	Contents
	①	GND	Ground
	②	POWER	POWER ON
	③	INPUT SEL3	Select input signal 3
	④		NC
	⑤	INPUT SEL1	Select input signal 1
	⑥	INPUT SEL2	Select input signal 2
	⑦		Connect internally
	⑧		
	⑨	ENABLE	Control by external contact

LAMP switching

Pin No.	Settings	
② - ①	Short	Open
Operation	On	Off

Switching input signals

Pin No.	Settings					
③ - ①	Open	Open	Open	Short	Short	Open
⑤ - ①	Open	Short	Open	Open	Short	Short
⑥ - ①	Open	Open	Short	Open	Open	Short
Input signal	COMPUTER1	COMPUTER2	DVI	VIDEO	S-VIDEO	NETWORK

NOTE:

- When pin ① and pin ⑨ are short-circuited, the buttons on the projector's control panel, power and **INPUT SELECT** buttons on the remote control cannot be used. In addition, the RS-232C commands and network functions that correspond to these functions cannot be used either.
- While pin ⑨ is "Open", do not short-circuit pin ①, ②, ③, ⑤ and ⑥. The projector would reject all the signals from the remote control.

DVI-D IN terminal

Pin assignments and signal names

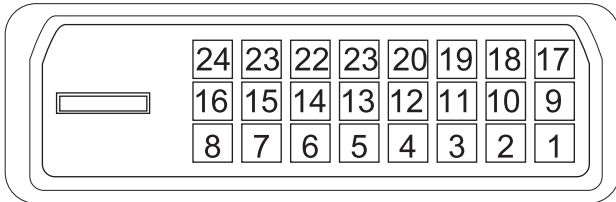

Pin No.	Signal name	Pin No.	Signal name
1	TMDS Data 2-	13	
2	TMDS Data 2+	14	+5V
3	TMDS Data 2/4 shield	15	GND
4		16	Hot Plug Detect
5		17	TMDS Data 0-
6	DDC clock	18	TMDS Data 0+
7	DDC data	19	TMDS Data 0/5 shield
8		20	
9	TMDS Data 1-	21	
10	TMDS Data 1+	22	TMDS clock shield
11	TMDS Data 1/3 shield	23	TMDS clock+
12		24	TMDS clock-

Ceiling mount bracket safeguards

The projector and the ceiling mount bracket are designed sufficiently safety though, make sure the safety cable provided with the projector is installed and attached to the bottom of the projector when mounting on the ceiling for safety and security.

NOTE:

- Even if it is guarantee period, the manufacturer is not responsible for any hazard or damage caused by using a ceiling mount bracket which is not purchased from an authorized distributors, or environmental conditions.
- Make sure to use a torque driver and do not use an electrical screwdriver or an impact screwdriver.
- Installation work of the ceiling mount bracket should only be carried by a qualified technician.
- Remove an unused ceiling mount bracket promptly.

Installing the safety cable

1. Install the ceiling mount bracket according to the installation instructions.
2. Loop the security cable around the ceiling mount bracket with less slack.
 - Lace the cable of the end with a latch through the loop on the other end of the cable.
3. Attach the latch on to the bottom of the projector with a provided screw.
 - Torque: 1.25 ± 0.2 N·m

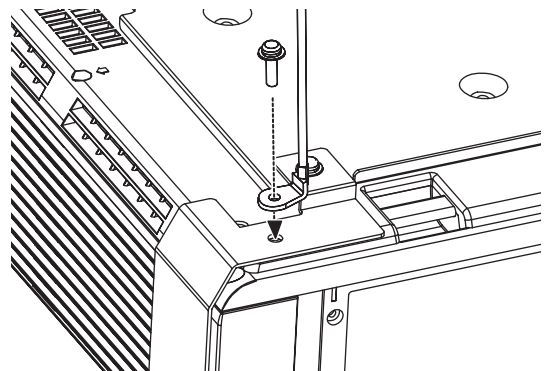
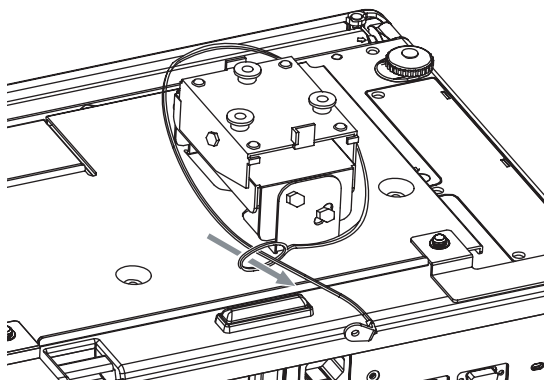

* Indicated sample above is ET-PKF100S.

Screen size and throw distance for 16:9 aspect ratio

All measurements and the calculation results below are approximate and may differ slightly from the actual measurements.

Projection size (16 : 9)			Throw distance (L)	
Screen diagonal (SD)	Screen height (SH)	Screen width (SW)	Minimum distance (LW)	Maximum distance (LT)
33" (0.84 m)	0.41 m (1'4")	0.73 m (2'4")		1.9 m (6'2")
40" (1.02 m)	0.50 m (1'7")	0.89 m (2'11")	1.2 m (3'11")	2.3 m (7'6")
50" (1.27 m)	0.62 m (2')	1.11 m (3'7")	1.5 m (4'11")	2.9 m (9'6")
60" (1.52 m)	0.75 m (2'5")	1.33 m (4'4")	1.7 m (5'6")	3.5 m (11'5")
70" (1.78 m)	0.87 m (2'10")	1.55 m (5'1")	2.0 m (6'6")	4.1 m (13'5")
80" (2.03 m)	1.00 m (3'3")	1.77 m (5'9")	2.3 m (7'6")	4.7 m (15'5")
90" (2.29 m)	1.12 m (3'8")	1.99 m (6'6")	2.6 m (8'6")	5.3 m (17'4")
100" (2.54 m)	1.25 m (4'1")	2.21 m (7'3")	2.9 m (9'6")	5.9 m (19'4")
120" (3.05 m)	1.49 m (4'10")	2.66 m (8'8")	3.5 m (11'5")	7.1 m (23'3")
150" (3.81 m)	1.87 m (6'1")	3.32 m (10'10")	4.4 m (14'5")	8.8 m (28'10")
200" (5.08 m)	2.49 m (8'2")	4.43 m (14'6")	5.9 m (19'4")	11.8 m (38'8")
250" (6.35 m)	3.11 m (10'2")	5.53 m (18'1")	7.4 m (24'3")	14.7 m (48'2")
300" (7.62 m)	3.74 m (12'3")	6.64 m (21'9")	8.9 m (29'2")	17.7 m (58')

Calculation methods

$$SW (m) = SD (") \times 0.0221$$

$$SH (m) = SD (") \times 0.0125$$

$$LW (m) = 0.0297 \times SD (") - 0.045$$

$$LT (m) = 0.0592 \times SD (") - 0.061$$

Technical Information

Specifications

Power supply		AC 100 - 240 V 50 Hz/60 Hz
Power consumption		350 W During standby (when fan is stopped): Approx. 4 W*1
Amps		4.1 A - 1.5 A
LCD panel	Panel size (diagonal)	0.78 type
	Aspect ratio	4 : 3
	Display method	3 transparent LCD panels (RGB)
	Drive method	Active matrix method
	Pixels	786 432 (1 024 x 768) x 3 panels
Lens		Manual zoom (2x)/Manual focus F 1.7 - 2.6, f 24.8 mm - 48.8 mm
Lamp		UHM lamp (250 W)
Luminosity *2		4 000 lm
Operating environment		Temperature 0 °C - 40 °C (32 °F - 104 °F) When the HIGH ALTITUDE MODE (page 42) is set to ON: 0 °C - 35 °C (32 °F - 95 °F) Humidity 20% - 80% (no condensation)
Scanning frequency *3 (for RGB signal)	Horizontal scanning frequency	15 kHz - 91 kHz
	Vertical scanning frequency	50 Hz - 85 Hz
	Dot clock frequency	Less than 150 MHz
COMPONENT (YPbPr) signals		525i (480i), 525p (480p), 625i (576i), 625p (576p), 750 (720)/60p, 750 (720)/50p, 1 125 (1 080)/60i, 1 125 (1 080)/50i, 1 125 (1 080)/60p, 1 125 (1 080)/50p
Color system		7 (NTSC/NTSC 4.43/PAL/PAL-M/PAL-N/PAL60/SECAM)
Projection size		33" - 300" (838.2 mm - 7 620 mm)
Throw distance		1.2 m - 19.7 m (4'0" - 64'7")
Screen aspect ratio		4 : 3
Installation		FRONT/DESK, FRONT/CEILING, REAR/DESK, REAR/CEILING (Menu selection method)
Speaker		1 piece (Monaural) 4 cm (Round)
Max. useable volume output		5.0 W

*1. When NETWORK STANDBY in NETWORK menu is ON: Approx. 25 W

When IN STANDBY MODE of AUDIO SETTING in PROJECTOR SETUP menu is ON: Approx. 35 W

The maximum power consumption during standby: Approx. 35 W.

*2. Measurement, measuring conditions and method of notation all comply with ISO21118 international standards.

*3. See "List of compatible signals" on page 52 for available signals.

Terminals	S-VIDEO IN	Single - line, Mini DIN 4p Y: 1.0 V [p-p], C: 0.286 V [p-p], 75 Ω
	VIDEO IN	Single - line, RCA pin jack 1.0 V [p-p], 75Ω
	COMPUTER1 IN	Single - line, D - sub HD 15-pin (female) R.G.B. 0.7 V [p-p], 75 Ω HD, VD/SYNC TTL high impedance, automatic positive/negative polarity compatible
	COMPUTER2 IN/ 1 OUT	Single - line, D - sub HD 15-pin (female) Selectable for input and output by menu operation. R.G.B. 0.7 V [p-p], 75 Ω HD, VD/SYNC TTL high impedance, automatic positive/negative polarity compatible
	DVI-D IN	Single - line, DVI-D 24-pin (Single link) DVI 1.0 compatible HDCP compatible
	AUDIO IN	Single - line, 0.5V [rms], RCA pin jack x 2 (L - R)
	COMPUTER AUDIO IN	Dual - line, 0.5V [rms], M3 jack (Stereo MINI)
	VARIABLE AUDIO OUT	Single - line, 0.5V [rms], M3 jack (Stereo MINI) Monitor output/stereo compatible 0 V [rms] - 2.0 V [rms] (variable)
	SERIAL	D-sub 9-pin RS-232C compatible
	REMOTE	D-sub 9-pin For external control
	LAN (RJ-45)	Single - line, For network connection 10 Base-T/100Base-TX
Wireless LAN (PT-F300NTU only)	Compatible	IEEE802.11b/IEEE802.11g (Wireless LAN standard protocol)
	Wireless channel	IEEE802.11b/IEEE802.11g: 1 - 13 channels
	Distance	30 m (98'5") Depends on the usage environment
Cabinet	Moulded plastic (PC+ABS)	
Dimensions	Width	432 mm (17")
	Height	128.5 mm (5 - 1/32")
	Length	323 mm (12 - 11/16")
Weight	Approx. 6.2 kg (13.7 lbs.)* ¹	
Certifications	UL60950-1	C-UL
	FCC Class B	ICES-003
Remote control	Power supply	3 V DC (AA battery x 2)
	Operating range	Approx. 15 m (49'2") (when operated directly in front of signal receptor)
	Weight	117 g (4.2 ozs.) (including batteries)
	Dimensions	Width
Length		163 mm (6 - 13/32")
Height		24.5 mm (-15/16") (not including surface projection parts)
Options	Ceiling bracket	ET-PKF100H/ET-PKF100S

*1. Average value. Each product has an individual variable in weight.

Technical Information

Dimensions

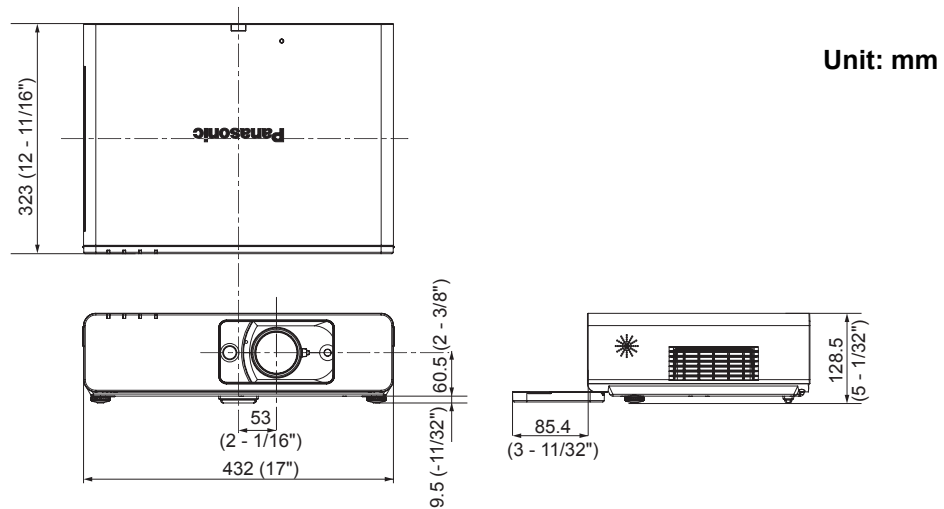

Trademark acknowledgements

- VGA and XGA are trademarks of International Business Machines Corporation.
- S-VGA is a registered trademark of the Video Electronics Standards Association.
- HDMI, the HDMI logo and High-Definition Multimedia Interface are trademarks or registered trademarks of HDMI Licensing LLC.
- The font used in the on-screen displays is a Ricoh bitmap font, which is manufactured and sold by Ricoh Company, Ltd.

All other trademarks are the property of the various trademark owners.

Index

A			
AC IN	13	Pin assignments	56
Accessories	10	E	
Air exhaust port	13	EMULATE	42
Air intake port	12	ENTER	
Ambient Luminance Sensor (ALS)	12	Control panel button	12
ASPECT	36	Remote control button	14
AUDIO IN	13	F	
AUDIO SETTING	42	FILTER COUNTER RESET	43
Auto Cleaning Filter (ACF)		Focus lever	12, 24
Compartment	13	FRAME LOCK	37
FILTER indicator	12	FREEZE	
FILTER indicator status	47	Remote control button	14
Replacing	49	Remote control function	27
AUTO SETUP		Front leg adjusters	13, 16, 24
Menu	39	Front panel cover	12
Remote control button	14	FUNCTION	
Remote control function	25	Remote control button	14
AV MUTE	40	Remote control function	28
Remote control button	14	FUNCTION BUTTON	42
Remote control function	27		
B		H	
BACK COLOR	39	Hand strap	14
BALANCE	42	HIGH ALTITUDE MODE	42
Battery compartment	14	I	
BRIGHTNESS	33	INDEX-WINDOW	
C		Remote control button	14
Calculation methods		Remote control function	27
16:9	57	INITIAL STARTUP	41
4:3	15	INITIALIZE ALL	43
CD-ROM	10	INPUT SELECT	
CINEMA	33	Control panel button	12
Cleaning	48	Function	24, 26
CLOCK PHASE	35	INSTALLATION	
CLOSED CAPTION SETTING	38	Menu	42
COLOR	33	Projection method	16
COLOR TEMPERATURE	34	K	
COMPUTER		KEYSTONE	35
Connection guidance	54	L	
Remote control button	14	LAMP	
Remote control function	26	Indicator	12
COMPUTER AUDIO IN	13	Indicator status	47
COMPUTER1 IN	13	Lamp unit compartment	13
COMPUTER2 IN/1 OUT	13	Replacing	48
COMPUTER2 SELECT	41	LAN	13
Connections	19	LASER	
CONTRAST	33	Remote control button	14
CONTROL DEVICE SETUP	45	Remote control function	28
D		Lens shift lever	12, 17, 24
DAYLIGHT VIEW	34	Lever	
DEFAULT		Focus lever	12
Remote control button	14	Lens shift lever	12
Remote control function	27	Zoom lever	12
DIGITAL CINEMA REALITY	34	M	
DIGITAL ZOOM		MENU	
Remote control button	14	Control panel button	12
Remote control function	26	Navigation	32
Dimensions	60	Remote control button	14
Direct power off	21	Structure	30
Direct power on	21	MENU LOCK	45
DISPLAY OPTION menu	38	MENU LOCK PASSWORD	45
DOT CLOCK	35		
DVI EDID	38		
DVI SIGNAL LEVEL	38		
DVI-IN	13, 38		

Index

N		SHIFT	35
Navigation buttons		SIGNAL	41
	Control panel button	SIGNAL SEARCH	39
	Navigating	Speaker	12
	Remote control button	Specifications	58
NETWORK		STARTUP LOGO	39
	Remote control button	STATUS	41
	Remote control function	S-VIDEO IN	13
NO SIGNAL SHUT-OFF		SXGA MODE	39
NOISE REDUCTION			
O		T	
ON-SCREEN DISPLAY		TEMP	
OTHER FUNCTIONS		Indicator	12
		Indicator status	47
		TEST PATTERN	43
		TEXT CHANGE	44
		TEXT DISPLAY	44
		Throw distance	
		16:10	15
		16:9	57
		Throwing angle	16
		TINT	33
		Troubleshooting	51
		TV-SYSTEM	34
P		V	
PASSWORD		VARIABLE AUDIO OUT	13
PASSWORD CHANGE		VIDEO	
PICTURE menu		Remote control button	14
PICTURE MODE		Remote control function	26
POSITION menu		VIDEO IN	13
Power		VOLUME	
	Control panel button	Controlling	42
	Indicator	Remote control button	14
	Indicator status	Remote control function	29
	Remote control button		
Power cord		W	
	Accessories	WHITE BALANCE BLUE	33
	Connecting	WHITE BALANCE GREEN	33
Power cord secure lock		WHITE BALANCE RED	33
	Accessories	WIDE MODE	39
	Attaching		
Projection lens		Z	
PROJECTOR SETUP menu		Zoom lever	12, 24
R			
REMAINING FILTER			
REMOTE			
	LAMP switching		
	Pin assignments		
	Switching input signals		
Remote control			
	Accessories		
	Indicator		
	Signal emitter		
	Signal receptor		
RETURN			
	Control panel button		
	Remote control button		
RGB/YPbPr			
RUNTIME			
S			
Safety cable			
	Accessories		
	Safeguards		
Screen size			
	16:10		
	16:9		
Security lock			
SECURITY menu			
SERIAL			
	Basic format		
	Cable specifications		
	Communication settings		
	Connection		
	Control commands		
	Pin assignments		
SHARPNESS			

Avis important concernant la sécurité

Cher client Panasonic:

Ce mode d'emploi vous donne toutes les informations concernant l'utilisation de ce projecteur. Nous espérons qu'il vous aidera à utiliser au mieux votre nouvel appareil, et que votre projecteur à cristaux liquides Panasonic vous donnera entière satisfaction. Le numéro

de série du produit se trouve au bas du produit. Le noter dans l'espace prévu ci-dessous et conserver ce manuel pour le cas où des réparations seraient nécessaires à l'avenir.

Numéro de modèle: PT-F300NTU/PT-F300U

Numéro de série:

ADVERTENCIA: POUR REDUIRE LES RISQUES DE FEU OU DE CHOC ÉLECTRIQUE, NE PAS EXPOSER CE PRODUIT À L'EAU OU À L'HUMIDITÉ.

Alimentation: Ce projecteur LCD est conçu pour fonctionner sur secteur de 100 V - 240 V, 50 Hz/60 Hz seulement.

CAUTION: Le cordon d'alimentation secteur fourni avec le projecteur peut être utilisé uniquement pour une alimentation électrique de 125 V, 7 A maximum. Si on veut l'utiliser avec une tension ou un courant plus forts, on doit se procurer un autre cordon d'alimentation de 250 V. Si on utilise le cordon fourni sous ces conditions, risque de provoquer un incendie.



Le symbole de la flèche en forme d'éclair, dans un triangle, avertit l'utilisateur de la présence de «tensions dangereuses» à l'intérieur du produit qui peuvent être de force suffisante pour constituer un risque de choc électrique aux personnes.



Le point d'exclamation dans un triangle avertit l'utilisateur de la présence d'instructions importantes concernant l'utilisation et l'entretien (réparation) dans la littérature accompagnant le produit.

CAUTION: Cet appareil est équipé d'une fiche de courant à trois broches avec mise à la terre. Ne pas retirer la broche de mise à la masse de la fiche. Cette fiche ne pourra être utilisée que dans une prise avec mise à la terre. Ceci est une précaution sécuritaire. S'il est impossible d'insérer la fiche dans la prise, s'adresser à un électricien. Ne pas annuler la protection de la fiche à mise à la terre.

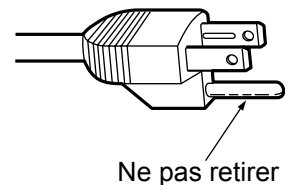

Pursuant to at the directive 2004/108/EC, article 9(2)
Panasonic Testing Centre
Panasonic Service Europe, a division of Panasonic Marketing Europe GmbH
Winsbergring 15, 22525 Hamburg, F.R. Germany

NOTICE:

- Ce produit possède une lampe à décharge haute intensité (DHI) qui contient du mercure. Son élimination peut être réglementée dans votre s à cause de considérations environnementales. Pour d'amples informations sur la mise au rebut ou le recyclage, veuillez contacter vos autorités locales ou aller au site Web de l'Electronics Industries Alliance: <http://www.eiae.org>

Avis important concernant la sécurité

AVERTISSEMENT:

Cet équipement a été soumis à des tests qui ont démontré que celui-ci respectait les limites spécifiées pour les appareils numériques de la classe B aux termes de la partie 15 des règles de la FCC (Federal Communications Commission U.S.A.). Ces limites ont pour objet de fournir une protection raisonnable contre les interférences nuisibles dans le cas d'une installation en milieu résidentiel. Cet équipement produit, utilise et peut rayonner de l'énergie de haute fréquence, et s'il n'est pas installé et utilisé conformément aux instructions fournies avec celui-ci, peut provoquer des interférences nuisibles aux communications radio. En outre, même en cas d'utilisation conforme, il n'est pas garanti qu'aucune interférence ne saurait survenir avec certaines installations. Si cet équipement s'avère nuire à la bonne réception d'émissions de radiophonie ou de télévision, ce que l'on pourra déterminer en mettant l'équipement successivement hors tension puis sous tension, il est conseillé de tenter de remédier au problème par l'une des méthodes suivantes:

- Réorientez ou déplacez l'antenne du récepteur;
- Éloignez l'équipement du récepteur;
- Branchez l'équipement dans une prise de courant située sur un circuit autre que celui qui alimente la prise de courant du récepteur;
- Demandez conseil à votre distributeur ou à un technicien de radio/télévision expérimenté.

FCC CAUTION: Pour assurer la bonne conformité, utilisez uniquement des câbles d'interface blindés lorsque vous connectez des ordinateurs ou des périphériques. Toute modification non autorisée de cet équipement annulera le droit de l'utilisateur à utiliser cet équipement.

Si le port sériel est utilisé pour connecter un ordinateur personnel afin de commander le projecteur depuis l'extérieur, il faut utiliser le câble d'interface sériel en option RS-232C avec une âme en ferrite. Tout changement ou modification non autorisé à cet équipement annule l'autorité de faire fonctionner cet appareil.

Avertissement de la FCC relative à l'exposition RF : (si fourni avec un appareil sans fil)

- Cet équipement est conforme aux limitations concernant l'exposition aux radiations établies par la FCC dans un environnement non contrôlé.
- Cet équipement a été approuvé pour un fonctionnement mobile et requiert de respecter une distance minimum de 20 cm entre l'antenne(s) et toutes les parties de votre corps (sauf les extrémités des mains, poignets et pieds) durant les modes de fonctionnement sans fil.
- Cet équipement ne peut pas être utilisé avec d'autres transmetteurs installés, qui peuvent être capable de transmission simultanée.

ADVERTENCIA:

- Ne peut être utilisé dans une salle d'ordinateurs telle que définie dans la norme ANSI/NFPA 75 Standard for Protection of Electronic Computer/Data Processing Equipment.
- Pour l'équipement branché en permanence, un dispositif de dis connexion d'accès facile doit être incorporé dans le câble d'installation du bâtiment;
- Pour l'équipement bran cable, une prise secteur d'accès facile doit être installée près de l'équipement.

Déclaration de conformité

Modèle n°: PT-F300NTU/PT-F300U
 Désignation commerciale: **Panasonic**
 Fabricant responsable: Panasonic Corporation of North America
 Adresse: One Panasonic Way, Secaucus, New Jersey 07094
 Téléphone: (888) 411 - 1996
 Email: projectorsupport@us.panasonic.com

Cet appareil est conforme à la partie 15 des règles de la FCC (Federal Communications Commission U.S.A.) ce qui signifie: (1) que l'appareil ne produit pas d'interférences nuisibles, et (2) que l'appareil est capable de supporter sans danger les interférences reçues, y compris celles susceptibles de perturber son fonctionnement.

Information relative à l'élimination des déchets dans les pays extérieurs à l'Union européenne



Ce pictogramme n'est valide qu'à l'intérieur de l'Union européenne. Pour connaître la procédure applicable dans les pays hors Union Européenne, veuillez vous renseigner auprès des autorités locales compétentes ou de votre distributeur.



Précautions de sécurité

AVERTISSEMENT

Si l'on remarque une émission de fumée, d'odeurs suspectes ou de bruits provenant du projecteur, débrancher la fiche du cordon d'alimentation de la prise de courant.

- Ne pas continuer d'utiliser le projecteur dans ces cas-là, autrement cela peut entraîner un incendie ou des chocs électriques.
- Après s'être assuré que de la fumée ne se dégage plus, s'adresser à un centre technique agréé et de-mander que les réparations nécessaires soient faites.
- Le fait de réparer le projecteur soi-même est très dangereux, et ne doit jamais être fait.

Ne pas installer ce projecteur dans un endroit qui n'est pas assez résistant pour supporter le poids du projecteur.

- Si l'emplacement d'installation n'est pas assez résistant, le projecteur risque de tomber et causer de graves blessures et (ou) des dommages.

Demander à un technicien qualifié d'installer le projecteur par exemple s'il est installé au plafond.

- Si l'installation n'est pas faite correctement, cela peut entraîner des blessures ou des chocs électriques.
- Ne pas utiliser un support de montage au plafond qui n'est pas agréé.

Si de l'eau ou des objets étrangers pénètrent dans le projecteur, si le projecteur tombe, ou si le boîtier est endommagé, débrancher immédiatement la fiche du cordon d'alimentation de la prise de courant.

- Si l'on continue d'utiliser le projecteur dans cette condition, cela peut entraîner un incendie ou des chocs électriques.
- S'adresser à un centre technique agréé pour que les réparations nécessaires puissent être faites.

La prise doit être montée à proximité de l'appareil et doit être facilement accessible.

- Débranchez immédiatement le cordon d'alimentation de la prise si un problème survient.

Ne pas surcharger la prise de courant.

- Si l'alimentation est surchargée (par exemple, par l'utilisation de trop d'adaptateurs), cela risque de faire surchauffer le projecteur et peut entraîner un incendie.

Ne jamais entreprendre toute modification quelconque ou démontage du projecteur.

- Des hautes tensions qui peuvent causer de graves blessures sont présentes à l'intérieur du projecteur.
- Pour toute inspection, réglage ou réparation, s'adresser à un centre technique agréé.

Nettoyer la fiche du cordon d'alimentation régulièrement afin d'éviter toute accumulation de poussière.

- Si de la poussière s'accumule sur la fiche du cordon d'alimentation, l'humidité peut endommager l'isolant et entraîner un incendie. Débrancher la fiche du cordon d'alimentation de la prise de courant et l'essuyer avec un tissu sec.
- Si le projecteur n'est pas utilisé pendant une période prolongée, débrancher la fiche du cordon d'alimentation de la prise de courant.

Ne pas manipuler le cordon d'alimentation avec les mains mouillées.

- Cela peut entraîner des chocs électriques.

Brancher la fiche du cordon d'alimentation fermement dans la prise de courant.

- Ne pas utiliser de cordon d'alimentation autre que celui fourni.
- Si la fiche n'est pas complètement insérée, cela peut entraîner des chocs électriques ou la faire surchauffer.
- Si la fiche est endommagée ou la plaque de la prise desserrée, celles-ci ne devraient pas être utilisées.

Ne pas placer le projecteur sur des surfaces instables.

- Si le projecteur est placé sur une surface qui est inclinée ou instable, il risque de tomber ou de se renverser et cela peut causer des blessures ou des dommages.

Ne pas placer le projecteur dans l'eau ou ne pas le laisser se mouiller.

- Sinon cela peut causer un incendie ou des chocs électriques.

Faire attention à ne pas endommager le cordon d'alimentation.

- Ne pas endommager le cordon d'alimentation, ne pas le modifier, ne pas le placer sous des objets lourds, ne pas le chauffer, ne pas le placer près d'objets chauffants, ne pas le tordre, ne pas le plier ou le tirer excessivement et ne pas le rouler en boule.
- Si le cordon d'alimentation est endommagé, cela peut entraîner un incendie et des chocs électriques.
- Si le cordon d'alimentation est endommagé, le faire réparer par un centre technique agréé.

Ne pas placer le projecteur sur des matériaux comme du tapis ou du tissu éponge.

- Cela peut provoquer une surchauffe du projecteur, pouvant entraîner des brûlures, un incendie ou endommager le projecteur.

Ne pas placer des récipients de liquide sur le projecteur.

- Si de l'eau se renverse sur le projecteur ou pénètre dans celui-ci, il y aura risque d'incendie ou d'électrocution.
- Si de l'eau entre à l'intérieur du projecteur, entrer en contact avec un centre technique agréé.

Ne pas mettre d'objets étrangers dans le projecteur.

- Ne pas insérer d'objets métalliques ou inflammables dans les orifices de ventilation ou les faire tomber sur le projecteur, car cela peut causer un incendie ou des chocs électriques.

Veiller à ce que les bornes + et – des piles n'entrent pas en contact avec des objets métalliques tels que colliers ou épingles à cheveux.

- Sinon, les piles risquent de fuir, de surchauffer, d'exploser ou de prendre feu.
- Ranger les piles dans un sac en plastique, et ne pas les ranger à proximité d'objets métalliques.

Précautions de sécurité

Ne jamais entrer en contact direct avec le liquide des piles.

- Le liquide risquerait en effet de causer de sérieuses blessures cutanées. Rincer immédiatement à l'eau courante toute trace du liquide des piles puis consulter au plus vite un médecin.
- Toute pénétration du liquide dans l'oeil risque de même de causer la cécité ou d'autres lésions graves. Eviter dans ce cas à tout prix de vous frotter les yeux, et rincez-les immédiatement à l'eau courante avant de consulter au plus vite un médecin.

Pendant un orage, ne pas toucher le projecteur ou le câble.

- Il y a risque d'électrocution.

Ne pas utiliser l'appareil dans un bain ou une douche.

- Il y a risque d'incendie ou d'électrocution.

Veillez à ce que le faisceau lumineux n'éclaire pas directement votre peau pendant que vous utilisez le projecteur.

- Une lumière intense est émise par l'objectif du projecteur. Si vous vous placez dans ce faisceau lumineux, celui-ci risquera de vous blesser ou de vous abîmer la peau.

Ne pas regarder directement dans l'objectif pendant que le projecteur fonctionne.

- Une lumière intense est émise par l'objectif du projecteur. Si l'on regarde directement dans cette lumière, elle risque de causer des blessures et de graves lésions aux yeux.
- Veiller particulièrement à ce que les enfants ne regardent pas dans l'objectif. En outre, éteindre le projecteur si on le laisse sans surveillance.

Ne pas placer les mains ou autres objets près de l'orifice de sortie d'air.

- De l'air chaud sort par l'orifice de sortie d'air. Ne pas placer les mains, le visage ou d'autres objets qui ne peuvent résister à la chaleur près de cette sortie d'air [laisser un espace d'au moins 50 cm], sinon des brûlures ou des dommages risqueraient de s'ensuivre.

Le remplacement de la lampe ne doit être effectué que par un technicien qualifié.

- La lampe a une pression interne élevée. Si elle est manipulée incorrectement, une explosion peut s'ensuivre.
- La lampe peut être facilement endommagée si elle est heurtée contre des objets durs ou si on la laisse tomber et des blessures et des mauvais fonctionnements peuvent s'ensuivre.

Lors du remplacement de la lampe, la laisser refroidir pendant au moins une heure avant de la manipuler.

- Le couvercle de la lampe devient très chaud, et on risque de se brûler si on le touche.

Avant de remplacer la lampe, veiller à débrancher la fiche du cordon d'alimentation de la prise de courant.

- Il y a risque d'électrocution ou d'explosion.

Ne pas laisser des enfants ou des animaux domestiques toucher la télécommande.

- Après avoir utilisé la télécommande, la ranger hors de portée des enfants ou des animaux domestiques.

MISES EN GARDE

Ne pas obstruer les orifices d'entrée et de sortie d'air.

- Cela risque de faire surchauffer le projecteur, et causer un incendie ou endommager le projecteur.
- Ne pas installer le projecteur dans des endroits étroits, mal ventilés tels que des placards ou des étagères.
- Ne pas placer le projecteur sur des tissus ou du papier, ces matériaux peuvent être aspirés dans l'orifice d'entrée d'air.

Ne pas installer le projecteur dans des endroits humides ou poussiéreux ou dans des endroits où le projecteur peut entrer en contact avec des fumées grasses ou de la vapeur.

- L'utilisation du projecteur dans de telles conditions peut causer un incendie, des chocs électriques ou une détérioration du boîtier en plastique. Une détérioration du plastique risquerait en effet d'entraîner une chute du projecteur en cas d'installation au plafond.

Ne jamais utiliser le projecteur dans un environnement à hautes températures, par exemple à proximité d'un radiateur ou directement soumis aux rayons du soleil.

- Le non-respect de cette mise en garde risquerait de causer un incendie, un dysfonctionnement ou une détérioration du plastique.

Ne pas utiliser le projecteur à l'air libre.

- Ce projecteur a été conçu pour une utilisation en intérieurs.

Pour débrancher le cordon d'alimentation, tenir la fiche et non pas le cordon.

- Si le cordon d'alimentation est tiré, le cordon sera endommagé et cela peut causer un incendie, des courts-circuits ou des chocs électriques sérieux.

Débrancher toujours tous les câbles avant de déplacer le projecteur.

- Le fait de déplacer le projecteur avec des câbles branchés peut endommager les câbles, ce qui pourrait causer un incendie ou des chocs électriques.

Ne pas placer d'objets lourds sur le projecteur.

- Cela peut déséquilibrer le projecteur et le faire tomber, ce qui peut entraîner des dommages ou des blessures.

Ne pas court-circuiter, chauffer ou démonter les piles, et ne pas les mettre dans l'eau ou dans le feu.

- Si l'on insère des piles d'un type différent, elles risqueront d'exploser ou de fuir, ce qui peut causer un incendie, des blessures ou une contamination du logement des piles et de la zone environnante.

Lorsqu'on insère les piles, veiller à ce que les polarités (+ et -) soient bien respectées.

- Si l'on insère les piles incorrectement, elles risqueront d'exploser ou de fuir, ce qui peut causer un incendie, des blessures ou une contamination du logement des piles et de la zone environnante.

Utiliser uniquement les piles spécifiées.

- Si l'on insère des piles d'un type différent, elles risqueront d'exploser ou de fuir, ce qui peut causer un incendie, des blessures ou une contamination du logement des piles et de la zone environnante.

Ne jamais mélanger des piles neuves et usagées.

- Si des piles usagées et neuves sont mélangées, elles risquent d'exploser ou de fuir, ce qui peut causer un incendie, des blessures ou une contamination du logement des piles et de la zone environnante.

Retirer rapidement les piles de la télécommande.

- Si vous laissez des piles usagées dans la télécommande pendant une longue période, cela risque de provoquer des fuites, une hausse anormale de la température interne ou une explosion.

Si le projecteur ne doit pas être utilisé pendant une longue durée débrancher la fiche électrique de la prise de courant et ôter les piles de la télécommande.

- Si de la poussière s'accumule sur la fiche du cordon d'alimentation, l'humidité ainsi créée risquera d'endommager l'isolation, ce qui peut provoquer un incendie.
- Si les piles restent dans la télécommande, il existe un risque de détérioration par insulation et de fuite électrique ou d'explosion pouvant causer un incendie.

Ne pas peser de tout son poids sur ce projecteur.

- On risque de tomber ou de casser l'appareil, ce qui peut causer des blessures.
- Veiller tout particulièrement à ce que les enfants ne se tiennent pas debout ou ne s'asseyent pas sur le projecteur.

Débrancher la fiche du cordon d'alimentation de la prise de courant comme mesure de sécurité avant d'effectuer tout nettoyage.

- Sinon cela peut causer des chocs électriques.

Nous faisons tous les efforts possibles afin de préserver l'environnement. Prière de rapporter l'appareil, s'il n'est pas réparable, à votre revendeur ou à un centre de recyclage.

Précautions lors du transport

Ne pas soumettre le projecteur à des vibrations ou des chocs excessifs.

- L'objectif du projecteur doit être manipulé avec soin.
- Placer le couvercle sur l'objectif lors du transport du projecteur.

Lors du transport du projecteur, bien le tenir par le bas.

- Ne pas tenir le projecteur par les pieds de réglage ou le couvercle supérieur pour le déplacer car cela pourrait l'endommager.

Précautions lors de l'installation

Éviter de l'installer dans les endroits sujets à des vibrations ou à des chocs.

- Les pièces internes peuvent être endommagées, ce qui peut causer des pannes ou des accidents.

Éviter d'installer le projecteur à des endroits sujets à des changements de température brusques, à proximité d'un climatiseur ou d'un matériel d'éclairage.

- La durée de vie de la lampe risquerait d'être réduite, ou le projecteur risquerait de s'éteindre. « Indicateur TEMP » à la page 41.

Ne pas installer le projecteur près de lignes d'alimentation électrique à haute tension ou de moteurs.

- Le projecteur peut être soumis à des interférences électromagnétiques.

Si le projecteur est installé au plafond, demander à un technicien qualifié de faire tous les travaux d'installation.

- Il faut acheter le kit d'installation séparé (numéro de modèle: ET-PKF100H, ET-PKF100S). En outre, tous les travaux d'installation doivent être exécutés uniquement par un technicien qualifié.
- Voir « Protections du support de montage au plafond » à la page 56 pour plus de détails à propos de l'installation du câble de sécurité.

Si l'on utilise ce projecteur à un endroit élevé 1 400 - 2 700 m (4 593 - 8 858 ft), régler MODE HAUTEALITUDE sur HAUT. Voir « MODE HAUTE ALTITUDE » à la page 42.

- Le non-respect de ces consignes peut entraîner un dysfonctionnement ou peut raccourcir la durée de vie de la lampe ou d'autres composants.

Précautions lors de l'utilisation

Afin d'obtenir la meilleure qualité d'image

- Fermer les rideaux ou les volets de toutes les fenêtres et éteindre les lampes fluorescentes situées à proximité de l'écran afin que la lumière extérieure ou la lumière des lampes intérieures n'éclaire pas l'écran.

Ne pas toucher aux surfaces de l'objectif ou du verre avant avec les mains nues.

- Si la surface de l'objectif est salie par des empreintes digitales ou autre, celles-ci seraient agrandies et projetées sur l'écran. De plus, refermer le **Couvercle du panneau avant** lorsque le projecteur n'est pas utilisé.

Précautions de sécurité

Affichage à cristaux liquides

- Ne pas projeter la même image pendant une longue durée, car elle risquerait de former une après-image sur l'affichage à cristaux liquides. Affichez l'écran blanc de la mire pendant plus d'une heure pour la supprimer. Voir « MIRE DE TEST » à la page 43.
- L'affichage à cristaux liquides du projecteur a été fabriqué en utilisant une technologie de haute précision afin d'offrir une image très détaillée. Il est possible que parfois quelques pixels figés apparaissent sur l'écran sous forme de points fixes bleus, verts ou rouges. Il est alors recommandé d'éteindre le projecteur puis de le rallumer environ 1 heure après. Bien noter que ceci n'affecte pas le bon fonctionnement de votre LCD.

Ce projecteur est équipé d'une lampe au mercure sous haute pression, dont les principales caractéristiques ont:

- La luminosité de la lampe dépend de la durée d'utilisation.
- Les chocs et éclats risquent d'endommager ou de réduire la durée de vie de la lampe.
- Un risque d'explosion réduit existe pendant la durée d'utilisation du projecteur.
- La lampe risque d'exploser si son utilisation dépasse la durée recommandée de remplacement de la lampe.
- Si la lampe explose, elle émet un gaz interne semblable à de la fumée.
- La durée de vie de la lampe dépend de ses caractéristiques, des conditions d'utilisation et de l'environnement d'installation. Par exemple, une utilisation en continu du projecteur pendant plus de 10 heures, ou des fréquences mises en marche/arrêt risquent d'avoir un effet particulièrement négatif sur la durée de vie de la lampe.

Composants optiques

- En cas d'utilisation quotidienne du projecteur pendant 6 heures ou plus, les composants optiques devront être remplacés en moins d'1 an.

Sécurité

Suivez les mesures de sécurité lors de l'utilisation du projecteur pour prévenir les éventuels incidents suivants.

- La fuite d'informations enregistrées personnelles.
- Les activités malhonnêtes accomplies par une tierce partie non digne de confiance.
- L'utilisation du projecteur par une tierce partie non de confiance (pour éviter une telle situation, vous pouvez verrouiller le projecteur).

Instructions de sécurité

- Le réseau de connexion doit être sécurisé par un pare-feu et autres.
- Modifiez fréquemment votre mot de passe.
- Ne pas utiliser de mot de passe trop facile à deviner.
- Le mot de passe ne vous sera jamais demandé par le Centre de dépannage agréé.
- Ne révélez jamais votre mot de passe.
- Attribuer un mot de passe au projecteur et restreindre son accès uniquement aux utilisateurs autorisés.

Remplacement de l'unité de la lampe

■ Avant de remplacer le l'Unité de la lampe



- Eteindre l'**MAIN POWER** puis débrancher le cordon principal de la prise du secteur.
- Attendez au moins 1 heure que la lampe et les composants contigus soient suffisamment froids.
- Préparer un tournevis cruciforme.
- Contacter un centre de service après-vente agréé pour acheter une unité de la lampe (ET-LAF100) de rechange.
- Lorsque le projecteur est fixé au plafond, ne pas travailler directement sous le projecteur, ni placer sa tête trop près du projecteur.

REMARQUE:

- Avant de remplacer la lampe, la laisser refroidir pour éviter les risques de brûlures, les dommages et autres dangers.
- Ne pas essayer de la remplacer par une lampe non autorisée.

■ Délai de remplacement de l'Unité de la lampe

L'unité de la lampe est un consommable et sa luminosité diminue avec la durée d'utilisation. L'indicateur **LAMP** vous informera des délais de remplacement de 5000 heures, et coupera le projecteur à 6000 heures. Ces valeurs sont fournies avant tout à titre indicatif et peuvent être réduites en fonction des conditions d'utilisation réelles, des caractéristiques de l'unité de la lampe, de la température ambiante, etc. Vous pouvez vérifier la durée d'utilisation à l'aide de **DUREE D'UTILISATION** dans le menu **RÉGLAGE PROJECTEUR**.

Indication	A l'écran	Indicateur LAMP
		
Plus de 5000 heures	« REPLACER LA LAMPE » est affiché en haut à gauche de l'écran pendant 10 secondes.	
Plus de 6000 heures	« REPLACER LA LAMPE » s'affiche en haut à gauche de l'écran, et attend votre réponse. Pour le supprimer immédiatement, appuyer sur n'importe quelle touche.	S'allume en rouge.

REMARQUE:

- Les durées indiquées, de 5000 et 6000 heures, sont des estimations basées sur certaines conditions et ne représentent en aucun cas des durées garanties.
- Pour plus d'informations à propos des caractéristiques de l'unité de la lampe, telles que la durée de garantie, se reporter aux instructions fournies avec l'unité de la lampe.

Remplacement de l'unité de la lampe

■ Procédure de remplacement

● Retirer et remplacer la lampe

1. Dévisser à l'aide d'un tournevis cruciforme les 2 vis de fixation du couvercle de la lampe à l'arrière du projecteur jusqu'à ce qu'elles tournent librement, puis retirer le couvercle de la lampe.

Couvercle de la l'unité de la lampe

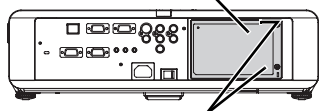

Vis de fixation du couvercle de l'unité de la lampe

2. Dévisser les 2 vis de fixation de l'unité de la lampe à l'aide du tournevis cruciforme.
3. Tenir l'unité de la lampe par la poignée puis débloquer le verrou de la lampe.
4. Extraire doucement l'unité de la lampe du projecteur.

Vis de fixation de l'unité de la lampe

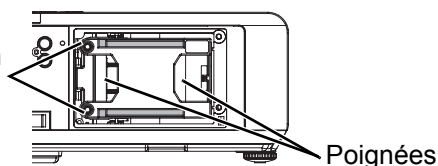

Poignées

5. Remettre la nouvelle unité de la lampe à son emplacement.

- **DUREE D'UTILISATION** sera automatiquement réinitialisée à "0"

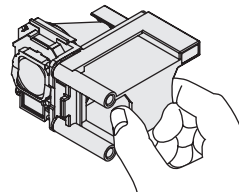

6. Appuyer sur l'unité de la lampe jusqu'à ce qu'elle s'encliquète et s'assurer qu'elle soit bien fixée en place.
7. Resserrer les 2 vis de fixation de l'unité de la lampe à l'aide du tournevis cruciforme.

Vis de fixation de l'unité de la lampe

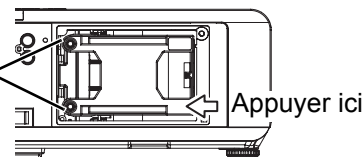

Appuyer ici

8. Fixer le couvercle de la lampe puis resserrer les 2 vis du couvercle de la lampe à l'aide du tournevis cruciforme.

Protections du support de montage au plafond

Bien que le projecteur et le support de fixation au plafond soient de conception suffisamment solide, veuillez à fixer le câble de sûreté fourni au projecteur en cas de fixation au plafond.

REMARQUE:

- Pendant toute la durée de la garantie, le fabricant ne pourrait en aucun cas être tenu pour responsable de tout danger ou dommages causés soit par l'utilisation d'un support au plafond non conforme, acheté auprès de distributeurs non autorisés, soit par ses conditions d'utilisation.
- N'utiliser qu'un tournevis dynamométrique durant l'installation, et ne jamais utiliser un tournevis électrique ou un tournevis à frapper.
- Les travaux d'installation du support au plafond ne devront être effectués que par un technicien qualifié.
- Démonter au plus vite tout support au plafond qui ne sera plus utilisé.

■ Installation du câble de sécurité

1. Installer le support de montage au plafond en suivant les consignes d'installation.
2. Faire passer la boucle du câble à l'aide d'un verrou en le bouclant par l'autre extrémité.
 - Attacher une des extrémités du câble à l'aide d'un verrou en le bouclant par l'autre extrémité.
3. Fixer le verrou au bas du projecteur à l'aide de la vis fournie.
 - Couple: 1.25±0.2 N·m

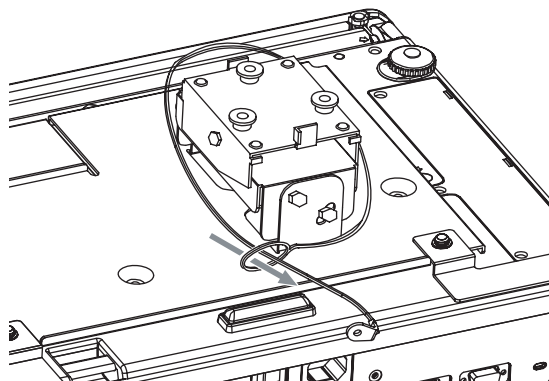

*Ceci vaut pour le ET-PKF100S.

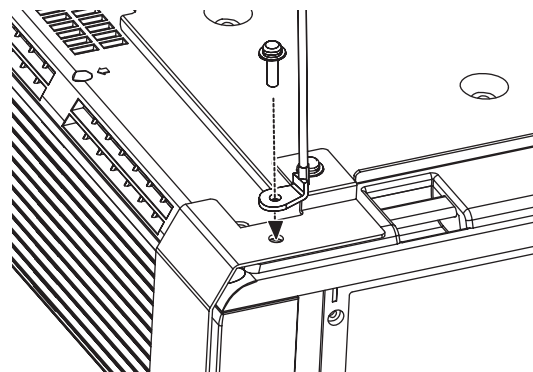

NOTE:

This product contains a CR Coin Cell Lithium Battery which contains Perchlorate Material - special handling may apply.

See www.dtsc.ca.gov/hazardouswaste/perchlorate.

Panasonic Corporation

Web Site : <http://panasonic.net/avc/projector/>

© Panasonic Corporation 2008

Panasonic Projector Systems Company

Unit of Panasonic Corporation of North America

One Panasonic Way, Secaucus, NJ 07094

TEL: (201) 392 - 6591

Technical Support:

TEL: (888) 411 - 1996

FAX: (201) 348 - 7523

E-Mail: projectorsupport@us.panasonic.com

Panasonic Canada Inc.

5770 Ambler Drive, Mississauga, Ontario L4W 2T3

TEL: (905) 624 - 5010

Panasonic Puerto Rico, Inc.

Ave. 65 de Infanteria, Km 9.5 San Gabriel Industrial Park, Carolina, Puerto Rico 00985

TEL: (787) 750 - 4300

Printed in Japan
S0908-1118B