

***myprojectorlamps.com***

**The most trusted, dependable name  
in projector lamp sales.**



<http://www.myprojectorlamps.com>



<http://www.myprojectorlamps.ca>



<http://www.myprojectorlamps.eu>

The following projector manual has not been modified or altered in any way.

# Panasonic®

## Operating Instructions

DLP™ Based Projector **Commercial Use**

Model No. **PT-DZ6710U**

**PT-DZ6700U**

**PT-DW6300U**

**PT-D6000U**

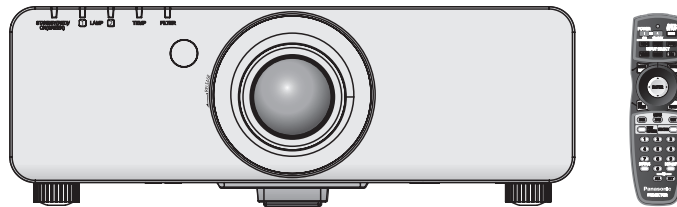

Before operating this product, please read the instructions carefully and save this manual for future use.  
The information of these instructions are shared use with multiple models of DZ6710 series, DZ6700 series, DW6300 series and D6000 series.

TQBJ0295

**ENGLISH**

# Important Safety Notice

## Dear Panasonic Customer:

The following information should be read and understood as it provides details, which will enable you to operate the projector in a manner which is both safe to you and your environment, and conforms to legal requirements regarding the use of projectors. Before connecting, operating or adjusting this projector, please read these instructions completely and save this booklet with the projector for future reference. We hope it will help you to get the most out of your new product, and that you will be pleased with your Panasonic DLP™Based Projector.

The serial number of your product may be found on its bottom. You should note it in the space provided below and retain this booklet in case service is required.

Model number: **PT-DZ6710U/PT-DZ6700U/PT-DW6300U/PT-D6000U**

Serial number:

**WARNING:** TO REDUCE THE RISK OF FIRE OR ELECTRIC SHOCK, DONOT EXPOSE THIS PRODUCT TO RAIN OR MOISTURE.

**Power Supply:** This LCD Projector is designed to operate on 100 V - 240 V, 50 Hz/60 Hz AC, house current only.

**CAUTION:** The AC power cord which is supplied with the projector as an accessory can only be used for power supplies up to 125 V, 7 A. If you need to use higher voltages or currents than this, you will need to obtain a separate 250 V power cord. If you use the accessory cord in such situations, fire may result.



The lightning flash with arrowhead symbol, within an equilateral triangle, is intended to alert the user to the presence of uninsulated "dangerous voltage" within the product's enclosure that may be of sufficient magnitude to constitute a risk of electric shock to persons.



The exclamation point within an equilateral triangle is intended to alert the user to the presence of important operating and maintenance (servicing) instructions in the literature accompanying the product.

**CAUTION:** This equipment is equipped with a three-pin grounding-type power plug. Do not remove the grounding pin on the power plug. This plug will only fit a grounding-type power outlet. This is a safety feature. If you are unable to insert the plug into the outlet, contact an electrician. Do not defeat the purpose of the grounding plug.

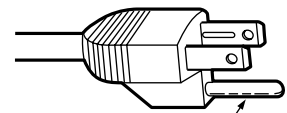

Do not remove

Pursuant to at the directive 2004/108/EC, article 9(2)  
Panasonic Testing Center  
Panasonic Service Europe, a division of Panasonic Marketing Europe GmbH  
Winsbergring 15, 22525 Hamburg, F.R. Germany

**NOTICE:**

- This product has a High Intensity Discharge (HID) lamp that contains mercury. Disposal may be regulated in your community due to environmental considerations. For disposal or recycling information, please contact your local authorities, or the Electronic Industries Alliance: <http://www.eiae.org>

**WARNING:**

This equipment has been tested and found to comply with the limits for a Class B digital device, pursuant to Part 15 of the FCC Rules. These limits are designed to provide reasonable protection against harmful interference in a residential installation. This equipment generates, uses and can radiate radio frequency energy and, if not installed and used in accordance with the instructions, may cause harmful interference to radio communications. However, there is no guarantee that interference will not occur in a particular installation. If this equipment does cause harmful interference to radio or television reception, which can be determined by turning the equipment off and on, the user is encouraged to try to correct the interference by one or more of the following measures:

- Reorient or relocate the receiving antenna.
- Increase the separation between the equipment and receiver.
- Connect the equipment into an outlet on a circuit different from that to which the receiver is connected.
- Consult the dealer or an experienced radio/TV technician for help.

**FCC CAUTION:** To assure continued compliance, follow the attached installation instructions and use only shielded interface cables when connecting to computer and/or peripheral devices. Any changes or modifications not expressly approved by Panasonic Corp. of North America could void the user's authority to operate this device.

**WARNING:**

- Not for use in a computer room as defined in the Standard for the Protection of Electronic Computer/Data Processing Equipment, ANSI/NFPA 75.
- For permanently connected equipment, a readily accessible disconnect device shall be incorporated in the building installation wiring.
- For pluggable equipment, the socket-outlet shall be installed near the equipment and shall be easily accessible.

**Declaration of Conformity**

Model Number: **PT-DZ6710U/PT-DZ6700U/PT-DW6300U/PT-D6000U**  
 Trade Name: **Panasonic**  
 Responsible party: Panasonic Corporation of North America  
 Address: One Panasonic Way, Secaucus, New Jersey 07094  
 Telephone number: (888) 411 - 1996  
 E-mail: [projectorsupport@us.panasonic.com](mailto:projectorsupport@us.panasonic.com)

This device complies with Part 15 of the FCC Rules. Operation is subject to the following two conditions: (1) This device may not cause harmful interference, and (2) this device must accept any interference received, including interference that may cause undesired operation.

## Important Safety Notice

---

### Information on Disposal in other Countries outside the European

These symbols are only valid in the European Union.

If you wish to discard this product, please contact your local authorities or dealer and ask for the correct method of disposal.



EU



# Contents

## Quick steps

**1. Set up your projector**  
See "Setting up" on page 16.



**2. Connect with other devices**  
See the functional instructions in the CD-ROM that is provided with the projector.



**3. Prepare the Remote control**  
See "Remote control" on page 14.



**4. Start projecting**  
See "Projecting" on page 19.



**5. Adjust the image**  
See "Menu Navigation" on page 24.

## Important Information

<b>Important Safety Notice</b> .....	<b>2</b>
<b>Precautions with regard to safety</b> .....	<b>6</b>
WARNINGS .....	6
CAUTIONS .....	7
Cautions when transporting .....	9
Cautions when installing .....	9
Cautions on use .....	9
Others .....	10
Security .....	10
Accessories .....	11

## Preparation

<b>About Your Projector</b> .....	<b>12</b>
Projector body .....	12
Remote control .....	14

## Getting Started

<b>Setting up</b> .....	<b>16</b>
Projection method .....	16
Removing and attaching the projection lens .....	17
Power cord .....	18

## Basic Operation

<b>Projecting</b> .....	<b>19</b>
Projecting a image .....	19
<b>Remote control operation</b> .....	<b>21</b>
Operating range .....	21
Setting up the image position automatically .....	21
Switching the input signal .....	22
Stopping the projection .....	22
Clearing the screen .....	22
Changing the picture aspect ratio .....	22
Displaying the internal test pattern .....	22
Using an assigned function .....	23
Displaying the status of the projector .....	23
Resetting to the factory default .....	23
<b>Menu Navigation</b> .....	<b>24</b>
Main menu and Sub-menu .....	24
Navigating through the menu .....	27

## Maintenance

<b>Monitor Lamp indicators</b> .....	<b>28</b>
Managing the indicated problems .....	28
<b>Replacement</b> .....	<b>30</b>
Replacing the Lamp unit .....	30
Replacing the Auto Cleaning Filter (ACF) .....	31
<b>Troubleshooting</b> .....	<b>33</b>

## Appendix

<b>Technical Information</b> .....	<b>34</b>
List of compatible signals .....	34
Specifications .....	36
Dimensions .....	38
Trademark acknowledgements .....	38
<b>Index</b> .....	<b>39</b>
<b>Avis important concernant la sécurité</b> .....	<b>41</b>
<b>Précautions de sécurité</b> .....	<b>43</b>
AVERTISSEMENT .....	43
MISES EN GARDE .....	44
Précautions lors du transport .....	45
Précautions lors de l'installation .....	46
Précautions lors de l'utilisation .....	46
Autres .....	46
Sécurité .....	47
<b>Remplacement</b> .....	<b>48</b>

# Precautions with regard to safety

## WARNINGS

**If you notice smoke, strange smells or noise coming from the projector, disconnect the power plug from the wall outlet.**

- Do not continue to use the projector in such cases, otherwise fire or electric shocks could result.
- Check that no more smoke is coming out, and then contact an Authorized Service Center for repairs.
- Do not attempt to repair the projector yourself, as this can be dangerous.

**Do not install this projector in a place which is not strong enough to take the full weight of the projector.**

- If the installation location is not strong enough, it may fall down or tip over, and severe injury or damage could result.

**Installation work (such as ceiling suspension) should only be carried out by a qualified technician.**

- If installation is not carried out correctly, there is the danger that injury or electric shocks may occur.
- Do not use other than an authorized ceiling mount bracket.

**If foreign objects or water get inside the projector, or if the projector is dropped or the cabinet is broken, disconnect the power plug from the wall outlet.**

- Continued use of the projector in this condition may result in fire or electric shocks.
- Contact an Authorized Service Center for repairs.

**The wall outlet shall be installed near the equipment and shall be easily accessible.**

- Unplug the power plug from the wall outlet immediately when problem occurred.

**Do not overload the wall outlet.**

- If the power supply is overloaded (for example, by using too many adapters), overheating may occur and fire may result.

**Never attempt to modify or disassemble the projector.**

- High voltages can cause fire or electric shocks.
- For any inspection, adjustment and repair work, please contact an Authorized Service Center.

**Clean the power plug regularly to prevent it from becoming covered in dust.**

- If dust builds up on the power plug, the resulting humidity can damage the insulation, which could result in fire. Pull the power plug out from the wall outlet and wipe it with a dry cloth.
- If not using the projector for an extended period of time, pull the power plug out from the wall outlet.

**Do not handle the power plug with wet hands.**

- Failure to observe this may result in electric shocks.

**Insert the power plug securely into the wall outlet.**

- Do not use other than the provided power cord.
- If the plug is not inserted correctly, electric shocks or overheating could result.
- Do not use plugs which are damaged or wall outlets which are coming loose from the wall.

**Do not place the projector on top of surfaces which are unstable.**

- If the projector is placed on top of a surface which is sloped or unstable, it may fall down or tip over, and injury or damage could result.

**Do not place the projector into water or let it become wet.**

- Failure to observe this may result in fire or electric shocks.

**Do not do anything that might damage the power cord or the power plug.**

- Do not damage the power cord, make any modifications to it, place it near any hot objects, bend it excessively, twist it, pull it, place heavy objects on top of it or wrap it into a bundle.
- If the power cord is used while damaged, electric shocks, short-circuits or fire may result.
- Ask an Authorized Service Center to carry out any repairs to the power cord that might be necessary.

**Do not place the projector on soft materials such as carpets or sponge mats.**

- Doing so may cause the projector to overheat, which can cause burns, fire or damage to the projector.

**Do not place liquid containers on top of the projector.**

- If water spills onto the projector or gets inside it, fire or electric shocks could result.
- If any water gets inside the projector, contact an Authorized Service Center.

**Do not insert any foreign objects into the projector.**

- Do not insert any metal objects or flammable objects into the projector or drop them onto the projector, as doing so can result in fire or electric shocks.

**Do not allow the + and - terminals of the batteries to come into contact with metallic objects such as necklaces or hairpins.**

- Failure to observe this may cause the batteries to leak, overheat, explode or catch fire.
- Store the batteries in a plastic bag and keep them away from metallic objects.

## Precautions with regard to safety

### Do not touch the leaked liquid from the batteries.

- If you touch the leaked liquid, it may hurt your skin. Immediately wash away the liquid with water and seek medical advice.
- If you get the leaked liquid in your eye, it may cause blindness or damage. Never rub your eye, and immediately wash away the liquid with water and seek medical advice.

### During a thunderstorm, do not touch the projector or the cable.

- Electric shocks can result.

### Do not use the projector in a bath or shower.

- Fire or electric shocks can result.

### Do not place your skin into the light beam while the projector is being used.

- Strong light is emitted from the projector's lens. If you place directly into this light, it can hurt or damage your skin.

### Do not look into the lens while the projector is being used.

- Strong light is emitted from the projector's lens. If you look directly into this light, it can hurt and damage your eyes.

### Do not disassemble the lamp unit.

- If the lamp section breaks, it may cause injury.

### Do not place your hands or other objects close to the air outlet port.

- Heated air comes out of the air outlet port. Do not place your hands or face, or objects which cannot withstand heat close to this port [allow at least 50 cm (20") of space], otherwise burns or damage could result.

### Replacement of the lamp should be carried out by a qualified technician.

- The lamp has high internal pressure. If improperly handled, explosion might result.
- The lamp can easily become damaged if struck against hard objects or dropped, and injury or malfunctions may result.

### When replacing the lamp, allow it to cool for at least one hour before handling it.

- The lamp cover gets very hot, and touching it can cause burns.

### Before replacing the lamp, be sure to disconnect the power plug from the wall outlet.

- Electric shocks or explosions can result if this is not done.

### Do not allow infants or pets to touch the remote control unit.

- Keep the remote control unit out of the reach of infants and pets after using it.

### After removing the battery from remote control unit, keep it away from the reach of children.

- The battery can cause death by suffocation if swallowed.
- If the battery is swallowed, seek medical advice immediately.

### Insulate the battery using tape or similar before disposal.

- If the battery comes into contact with metallic objects or other batteries, it may catch fire or explode.

### When installing to a ceiling, be sure to use the accessory wire (install in a different location to the ceiling mount bracket) and the eye bolts as an extra preventative measure to stop the projector from falling down.

- If the projector is not secure enough, accidents may result.

### Do not place sets directly on top of each other.

- If this is not observed, accidents may result.

### Do not use the projector while the projection lens cover is still attached to the projection lens.

- If this is not observed, fire may occur.

## CAUTIONS

### Do not cover the air inlet port or the air outlet port.

- Doing so may cause the projector to overheat, which can cause fire or damage to the projector.
- Do not place the projector in narrow, badly ventilated places such as closets or bookshelves.
- Do not place the projector on cloth or papers, as these materials could be drawn into the air inlet port.

### Do not set up the projector in humid or dusty places or in places where the projector may come into contact with oily smoke or steam.

- Using the projector under such conditions may result in fire, electric shocks or plastic deterioration. The plastic deterioration may cause the falling down of the projector which is mounted on the ceiling.



## Precautions with regard to safety

**Do not set up the projector in a high temperature environment, such as near a heater or in direct sunlight.**

- Failure to observe this may result in fire, malfunction or plastic deterioration.

**Do not set up the projector outdoors.**

- The projector is designed for indoor use only.

**When disconnecting the power cord, hold the plug, not the cord.**

- If the power cord itself is pulled, the cord will become damaged, and fire, short-circuits or serious electric shocks may result.

**Always disconnect all cables before moving the projector.**

- Moving the projector with cables still attached can damage the cables, which could cause fire or electric shocks to occur.

**Do not place any heavy objects on top of the projector.**

- Failure to observe this may cause the projector to become unbalanced and fall, which could result in damage or injury.

**Do not short-circuit, heat or disassemble the batteries or place them into water or fire.**

- Failure to observe this may cause the batteries to overheat, leak, explode or catch fire, and burns or other injury may result.

**When inserting the batteries, make sure the polarities (+ and -) are correct.**

- If the batteries are inserted incorrectly, they may explode or leak, and fire, injury or contamination of the battery compartment and surrounding area may result.

**Use only the specified batteries.**

- If incorrect or different kind of batteries are used, they may explode or leak, and fire, injury or contamination of the battery compartment and surrounding area may result.

**Do not mix old and new batteries.**

- If the batteries are used mixing old and new, they may explode or leak, and fire, injury or contamination of the battery compartment and surrounding area may result.

**Remove the used batteries from the remote control promptly.**

- If you leave used batteries in the remote control for an extended period of time, it may cause liquid leaking, abnormal internal temperature rising or explosion.

**If not using the projector for an extended period of time, disconnect the power plug from the wall outlet and remove the batteries from the remote control.**

- If dust builds up on the power plug, the resulting humidity may damage the insulation, which could result in fire.
- Keeping or leaving the remote control with batteries inside may cause insulation deterioration, electrical leakage or explosion which could result in fire.

**Do not use the old lamp unit.**

- The lamp section may break.

**Do not put your weight on this projector.**

- You could fall or the projector could break, and injury may result.
- Be especially careful not to let young children stand or sit on the projector.

**Disconnect the power plug from the wall outlet as a safety precaution before carrying out any cleaning.**

- Electric shocks can result if this is not done.

**If the lamp has broken, ventilate the room immediately. Do not touch or bring your face close to the broken pieces.**

- Failure to observe this may cause the user to absorb the gas which was released when the lamp broke and which contains nearly the same amount of mercury as fluorescent lamps, and the broken pieces may cause injury.
- If you believe that you have absorbed the gas or that the gas has got into your eyes or mouth, seek medical advice immediately.
- Ask your dealer about the replacement of the lamp unit and check the inside of the projector.

**Ask an Authorized Service Center to clean inside the projector at least once a year.**

- If dust is left to build up inside the projector without being cleaned out, it can result in fire or problems with operation.
- It is a good idea to clean the inside of the projector before the season for humid weather arrives. Ask your nearest Authorized Service Center to clean the projector when required. Please discuss with the Authorized Service Center regarding cleaning costs.

**Do not use chemical treated wipes when cleaning.**

- Using chemical treated wipes may result in plastic distortion or deterioration.

## Precautions with regard to safety

**Do not reach for the openings beside the optical lens, during horizontal or vertical movements of the lens.**

- Failure to observe this may cause injury.

**Replacement of the lamp unit should only be carried out after it has completely cooled off.**

- Failure to observe this may cause burns.

**We are constantly making efforts to preserve and maintain a clean environment. Please take non repairable units back to your dealer or a recycling company.**

## Cautions when transporting

**Do not subject the projector to excessive vibration or shocks.**

- The projector lens need to be handled with care.
- Cover the lens with the lens cover when transporting the projector.

**When transporting the projector, hold the body at the bottom securely.**

- Do not hold the adjuster legs or the top cover to move the projector, as this may damage the projector.

**Be sure to always remove the lens during transport.**

- The projection lens is susceptible to vibrations and impacts.

## Cautions when installing

**Avoid setting up in places which are subject to vibration or shocks.**

- The internal parts can be damaged, which may cause malfunctions or accidents.

**Avoid setting up in places which are subject to sudden temperature changes, such as near an air conditioner or lighting equipment.**

- The life of the lamp may be shortened or the projector may be turned off. See "TEMP indicator" on page 28.

**Do not set up the projector near high-voltage power lines or near motors.**

- The projector may be subject to electromagnetic interference.

**If installing the projector to the ceiling, ask a qualified technician to carry out all installation work.**

- You will need to purchase the separate installation kit (Model No. ET-PKF100H, ET-PKF100S). Furthermore, all installation work is should only be carried out by a qualified technician.

**If using this projector at high elevations 1 400 - 2 700 m (4 593 - 8 858 ft) sea level, set the HIGH ALTITUDE MODE to ON.**

- Failure to observe this may result in malfunctions or the life of the lamp or the other components may be shortened.

**Be sure to install the projection lens cover after installing the projection lens.**

- If this not done, dust will collect inside the projector and problems with the projector will result.

## Cautions on use

**In order to get the best picture quality**

- Draw curtains or blinds over any windows and turn off any lights near the screen to prevent outside light or light from indoor lamps from shining onto the screen.
- In rare cases, wafture can occur on the screen affected by the warm air from the exhaust port depending on the environment. Make sure that there is no equipment in front of the set which will recirculate the exhaust air from the set or other nearby equipment.

**Do not touch the surfaces of the lens or the front glass with your bare hands.**

- If the surface of the lens becomes dirty from fingerprints or anything else, this will be magnified and projected onto the screen. Moreover, when not using the projector, close the front panel cover.

## Precautions with regard to safety

### The projector has a high pressure mercury lamp and that is characterized as follows.

- The brightness of the lamp depends on the duration of use.
- The lamp may explode or shorten the lamp life by shocks or chipping damage.
- The lamp may explode only occasionally after using the projector.
- The lamp may explode if using the projector after the instructed lamp replacement timing.
- When the lamp exploded, it emits internal smoke-like gas.
- The lamp life is depends on individual lamp characteristics, usage condition and the installation environment. Especially the consecutive use of the projector for more than 22 hours, or the frequent switching on or off may greatly affect on the lamp life.
- Provide a lamp for replacement in advance.

### Optical components

- If you use the projector consecutively 22 hours every day, the optical components may need to be replaced in less than 1 year.

### Do not use projectors with the adjustable feet or projection lens cover removed.

- If this is not observed, the sets may not operate correctly or accidents may result.

### DLP chips

- The DLP chips are made using extremely high-precision technology. Note that in rare cases, pixels may be missing or always lit, but this is not a malfunction.

## Others

### Disposal

- When disposing of the product, contact your nearest municipality or dealer to confirm the correct procedure for disposal.

### Connection to external device

- When connecting the projector to a computer or external device, use the power cord supplied with the corresponding device and a commercially available shielded interface cable.

## Security

### Take the safety measures for use of the projector that should cover the following envisioned incidents.





- The leakage of your personal registered information.
- Dishonest operation by an untrusted third party.
- Locking out or prevent anyone else from using the projector by an untrusted third party.

### Security instruction

- The connecting network must be secured by firewall or others.
- Change your password regularly.
- Do not use password too simple to guess.
- The Authorized Service Center will never ask you for the password.
- Do not share your password with anyone else.
- Password the projector and restrict access to authorized users only.

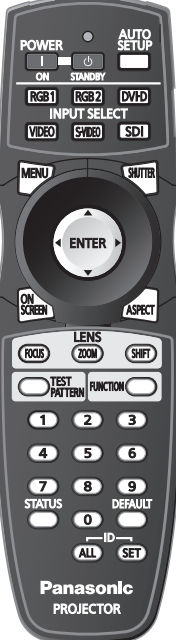
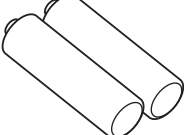
## Accessories

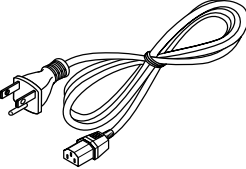
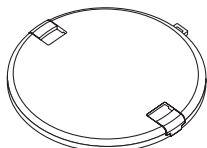
Make sure the following accessories are provided with your projector.

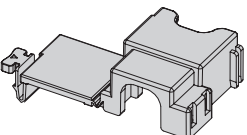
<p><b>Remote control (x1)</b> N2QAYB000371</p> 	<p><b>AA batteries for remote control (x2)</b></p> 	<p><b>Safety cable</b> TTRA0214 Attachment screw (x1) Safety cable (x1)</p> 	<p><b>Power cord (x1)</b> K2CG3FZ00008</p> 
<p><b>Projector lens cover (x1)</b> TKKL5244-1</p> 	<p><b>CD-ROM (x1)</b> TQBH9013</p> 	<p><b>Power cord secure lock (x1)</b> TTRA0182</p> 	

\* The protectors for enclosed products, such as a plug cover or foam cartons, must be treated properly.

\* Contact to an Authorized Service Center for lost accessories.

# About Your Projector

## Projector body

### Top, front and bottom view

#### Indicators

- Power indicator
- Lamp1 (**LAMP1**) indicator (page 28)
- Lamp2 (**LAMP2**) indicator (page 28)
- Temperature (**TEMP**) indicator (page 28)
- Filter (**FILTER**) indicator (page 29)

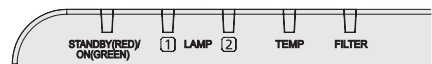

Lamp unit compartment (page 30)

Air exhaust port

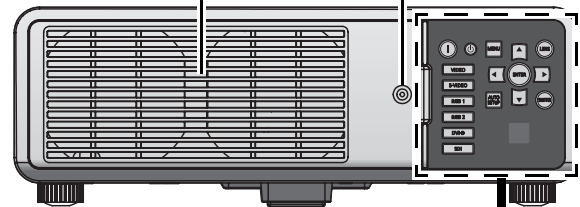

Projection lens  
Focus ring

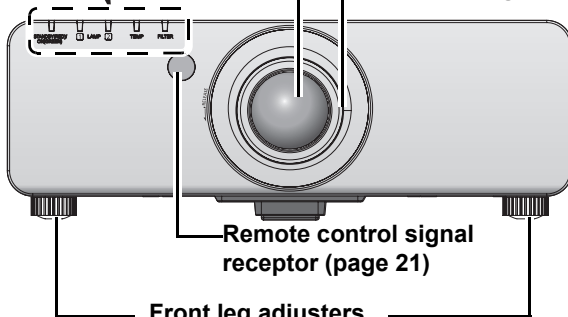

Remote control signal receptor (page 21)

Front leg adjusters  
Screw up/down to adjust the projection angle.

**POWER ON button**  
Starts the projection while in the standby mode. (page 20)

**POWER STANDBY button**  
Returns to the standby mode. (page 20)

**MENU button**  
Displays and clears the main menu, and returns to the previous menu when the menu is displayed. (page 27)

**LENS button**  
This button is used together with ▲ ▼ ◀ ▶ to adjust focus, zoom and shift by the projection lens. (page 19)

#### Burglar hook port

Attach a commercial burglar prevention cable.

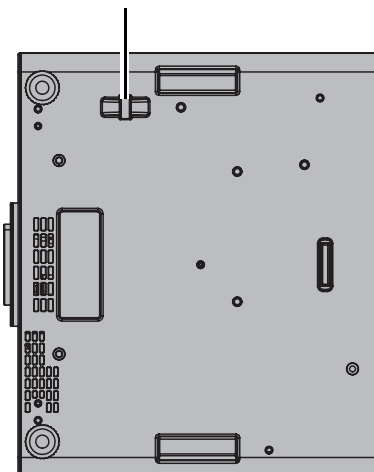

**Input select buttons**  
These buttons select the **RGB1, RGB2, DVI-D, VIDEO, S-VIDEO** and **SDI** (PT-DZ6710U only) terminals. (page 19)

**AUTO SETUP button**  
Pressing this button while projecting an image automatically corrects the picture positioning on the screen. While the auto setup feature is active, a message "**PROGRESS**" appears on the screen. (page 21)

**Remote control signal receptor (page 21)**

**SHUTTER button**  
Pressing this button toggles the projector's internal mechanical shutter to black out the projector. (page 22)

**Navigation and ENTER buttons**  
Navigate through the menu items with ▲ ▼ ◀ ▶, and activate them with the **ENTER** button. (page 27)

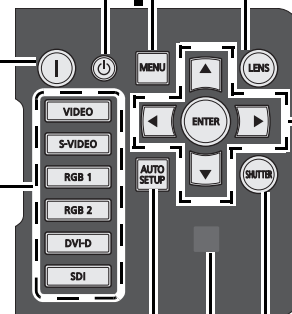

#### NOTE:

- Do not cover the ventilation openings or place anything within 50 cm (20") of them as this may cause damage or injury.
- While the projector is not in use, keep the projector lens cover attached to protect the lens.

**Side views**

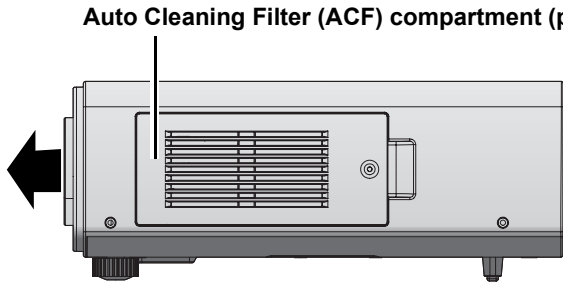
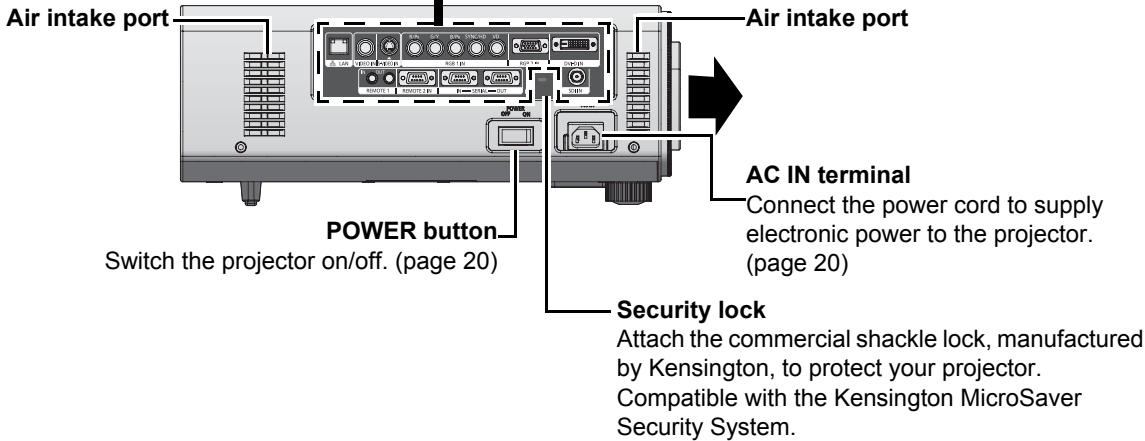
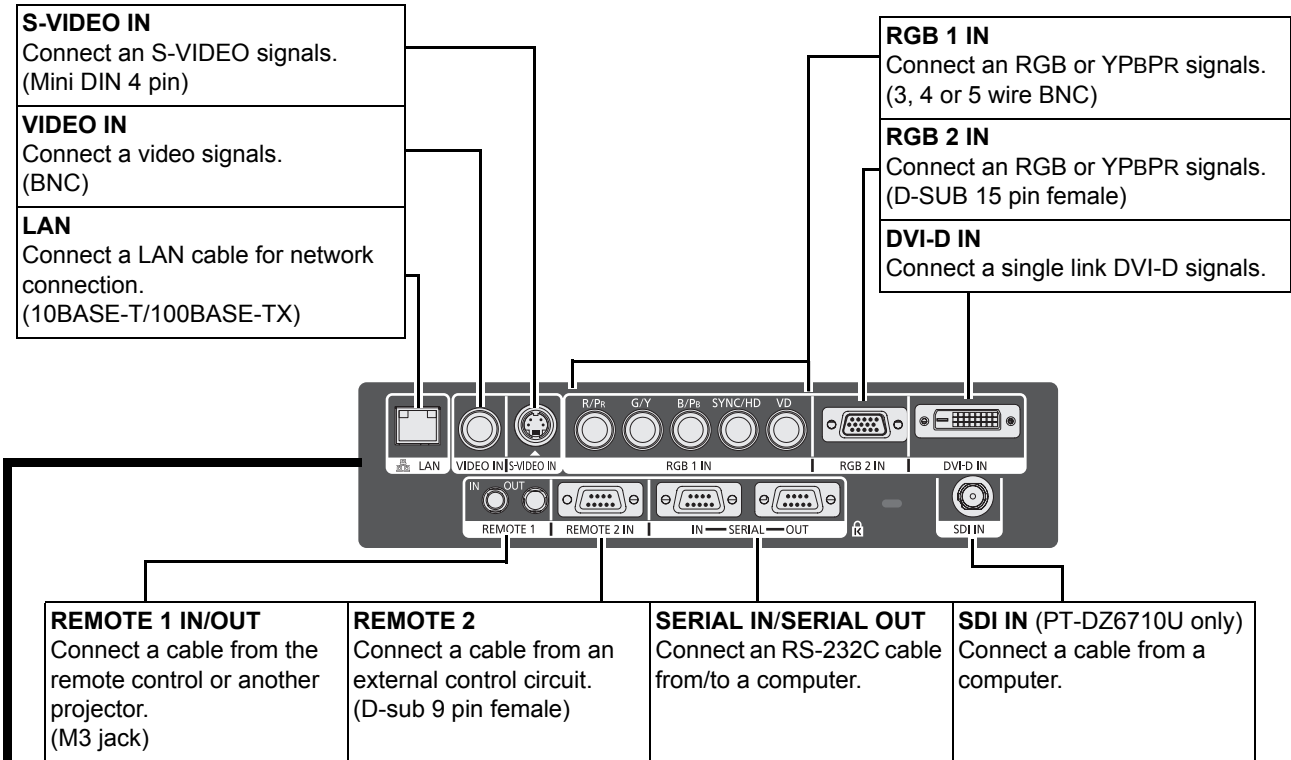







**NOTE:**

- Switch on the **POWER** button of the projector body that is located near the terminals before using the control buttons.
- Do not cover the ventilation openings or place anything within 50 cm (20") of them as this may cause damage or injury.

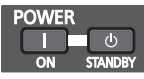



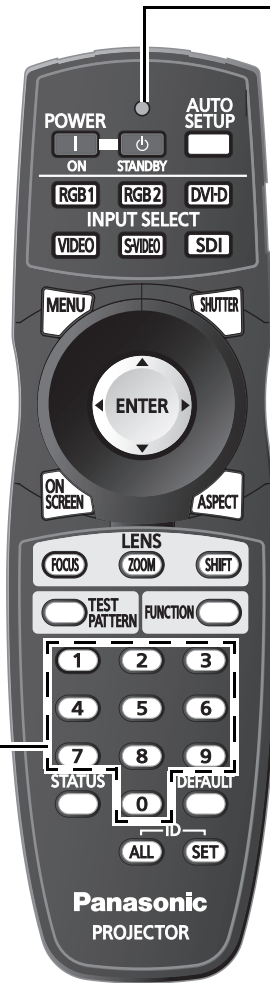

# About Your Projector

## Remote control

Preparation

<b>POWER ON and POWER STANDBY buttons</b>
<p><b>POWER ON:</b> Starts the projection while in the standby mode.</p> <p><b>POWER STANDBY:</b> Returns to the standby mode. (page 19)</p>

<b>INPUT SELECT buttons</b>
<p>These buttons select the <b>RGB1</b>, <b>RGB2</b>, <b>DVI-D</b>, <b>VIDEO</b>, <b>S-VIDEO</b> and <b>SDI</b> terminals. (page 22)</p>

<b>MENU buttons</b>
<p>Displays and clears the main menu, and returns to the previous menu when the menu is displayed. (page 27)</p>

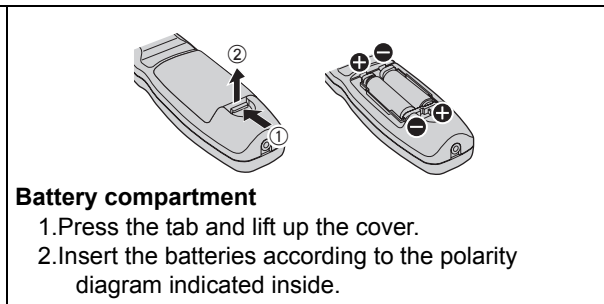
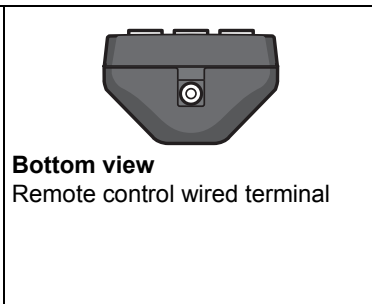
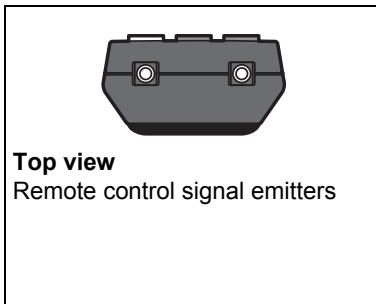
<b>ON SCREEN button</b>
<p>Displays and clears the on screen indications. (page 22)</p>

<b>TEST PATTERN button</b>
<p>Displays the test pattern. (page 22)</p>

<b>Numeric (0 - 9) buttons</b>
<p>Enter ID number of the remote control, adjustment values of menu items and by service personnel. (page 15)</p>
<b>STATUS button</b>
<p>Displays projector information. (page 23)</p>

<b>Navigation and ENTER buttons</b>
<p>Navigate through the menu items with <b>▲ ▼ ◀ ▶</b>, and activate them with the <b>ENTER</b> button. (page 27)</p>



<b>Remote control indicator</b>
<p>Flashes by pressing any buttons. (page 21)</p>
<b>AUTO SETUP</b>
<p>Pressing this button while projecting an image automatically corrects the picture positioning on the screen. While the auto setup feature is active, a message <b>"PROGRESS"</b> appears on the screen. (page 21)</p>
<b>SHUTTER button</b>
<p>Pressing this button toggles the projector's internal mechanical shutter to black out the projector. (page 22)</p>

<b>ASPECT button</b>
<p>Switches the image aspect ratio. (page 22)</p>

<b>LENS buttons</b>
<p>These buttons are used together with <b>▲ ▼ ◀ ▶</b> to adjust focus, zoom and shift by the projection lens. (page 19)</p>

<b>FUNCTION button</b>
<p>Assign the frequently use functions from options for shortcut. (page 23)</p>

<b>DEFAULT button</b>
<p>Restores the default factory setting. (page 23)</p>

<b>ID buttons</b>
<p><b>ALL:</b> Makes the remote control available to control any ID projectors.</p> <p><b>SET:</b> Specifies the ID of the remote control. (page 15)</p>



**NOTE:**

- Switch on the **POWER** button of the projector body that is located near the terminals before using the remote control.
- Do not drop the remote control.
- Avoid contact with liquids or moisture.
- Use manganese batteries or alkaline batteries with the remote control.
- Do not attempt to modify or disassemble the remote control. Contact an Authorized Service Center for repairs.
- Do not keep pressing the remote control buttons as this may shorten battery life.
- See "Remote control operation" on page 21.

## Setting projector ID number to remote control

Each projector can be assigned a unique 2 digits ID number, and the remote control 2 digits ID number must be set to match the intended projector. The default setting of the projector ID is **ALL**. Set the ID of the projector in advance from the menu items.

1. Press the **ID SET** button.
  - Displays the projector ID number on the screen.
2. Within 5 seconds, enter the same number of the required projector by pressing the numeric buttons.
  - ID number range: 01 - 64

### NOTE:

- Do not press the **ID SET** button accidentally or carelessly because the ID number on the remote control can be set even when no projector is around.
- If you do not enter the 2 digits ID number within 5 seconds after the **ID SET** button has been pressed, the ID will remain at the number that was set before the **ID SET** button was pressed.
- Your specified ID will be erased if the batteries of the remote control are left exhausted. When the batteries are replaced, set the same ID number again.

## Using a wired remote control

When multiple projectors are connected as part of the system, connect to units with a M3 stereo mini jack commercial cable to simultaneously control multiple main units with a single remote control through the **REMOTE 1 IN/OUT** terminal. It is effective to use the wired remote control in the environment in which an obstacle stands in the light path or where devices are susceptible to outside light.

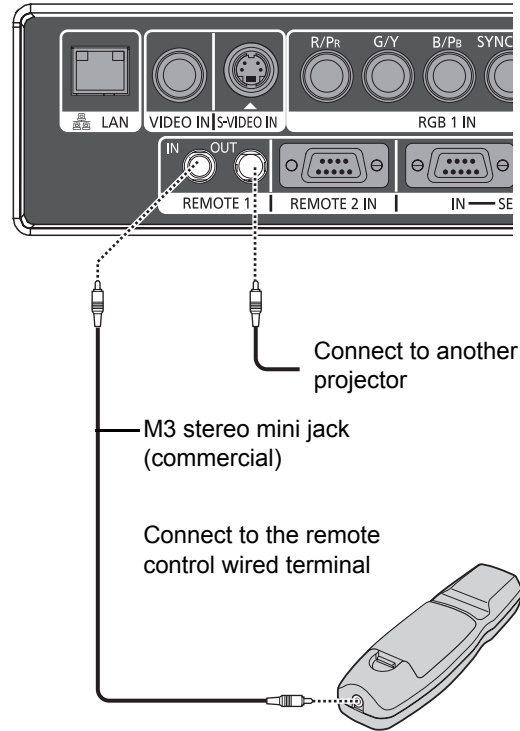

### NOTE:

- Use 2 core shielded cable of length of 15 m or less. If the length of the cable exceeds 15 m (49'2"), the shielding of the cable may not be sufficient and the remote control may not work.



# Setting up

## Projection method

You can use the projector with any of the following 4 projection methods. To set the desired method in the projector,

### ■ Setting on a desk/floor and projecting from front

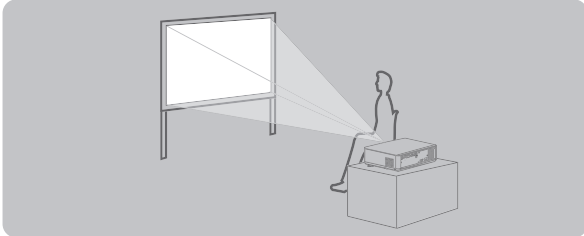

**INSTALLATION:** FRONT/FLOOR  
**COOLING CONDITION:** FLOOR SETTING

### ■ Setting on a desk/floor and projecting from rear

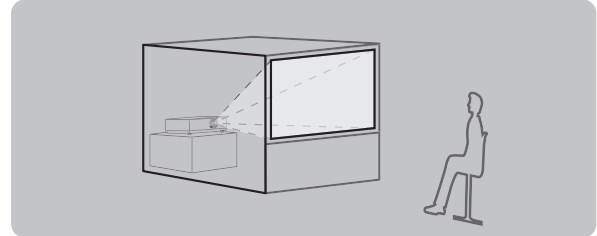

**INSTALLATION:** REAR/FLOOR  
**COOLING CONDITION:** FLOOR SETTING

### ■ Mounting on the ceiling and projecting from front

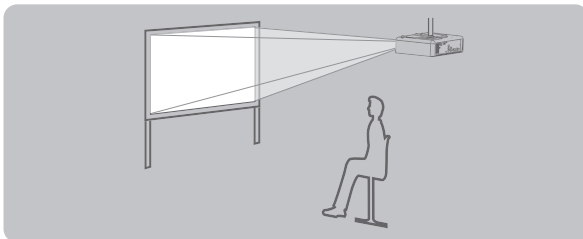

**INSTALLATION:** FRONT/CEILING  
**COOLING CONDITION:** CEILING SETTING

### ■ Mounting on the ceiling and projecting from rear

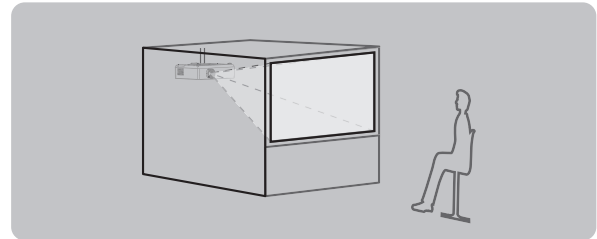

**INSTALLATION:** REAR/CEILING  
**COOLING CONDITION:** CEILING SETTING

#### NOTE:

- A translucent screen is required for rear projection.
- See more detailed setting up instructions, **INSTALLATION** and **COOLING CONDITION** in **PROJECTOR SETUP** menu on the functional instructions in the CD that is provided with the projector.
- Do not place or use a projector on top of another projector.
- Do not cover the ventilation openings or place anything within 50 cm (20") of them as this may cause damage or injury.

## Removing and attaching the projection lens

### Removing the projection lens from the projector

1. Switch off the **POWER** button on the projector.
2. Rotate the lens cover counterclockwise and remove.

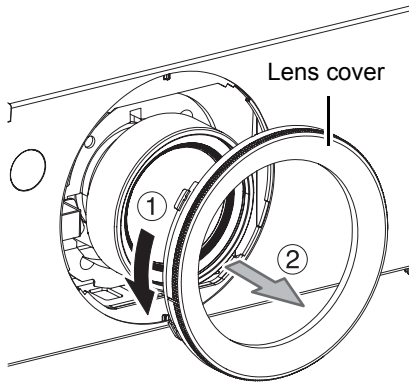

3. While pressing the lens release button, rotate the projection lens counterclockwise, and remove the projection lens.

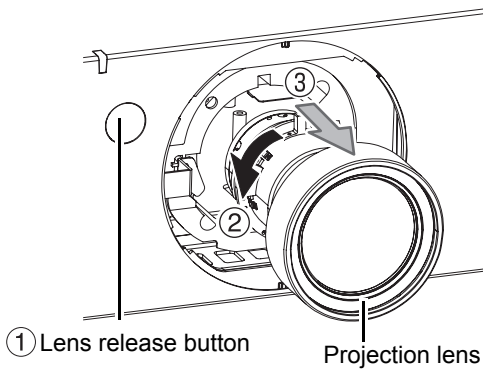

### Attaching the projection lens to the projector

1. Switch off the **POWER** button on the projector.
  - When the lens cover is attached, rotate counterclockwise and remove.
2. Align the guide of the projection lens with the guide groove in the projector, and then insert the lens.

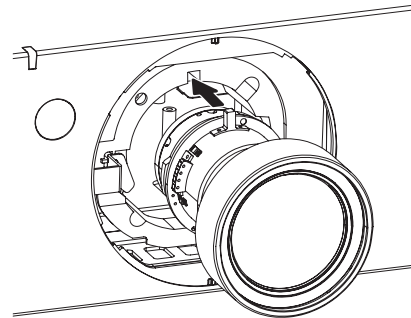

3. Rotate the projection lens clockwise until it clicks into place.

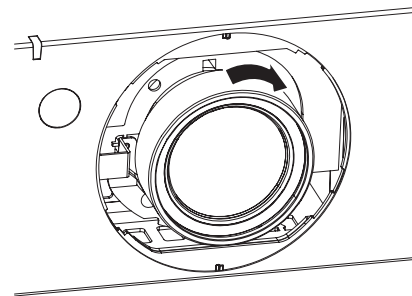

4. Place the lens cover back to the projector, and rotate clockwise to attach.

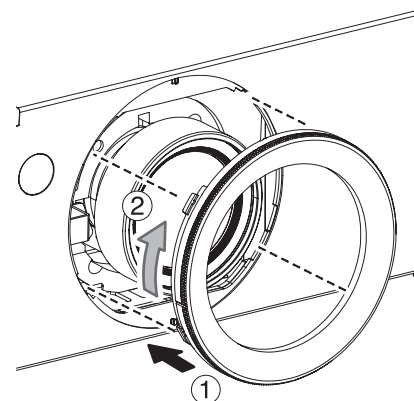

**NOTE:**

- Do not touch the lens signal contact. Dust or dirt may cause defective contact.
- Do not touch the surface of the projection lens with your bare hands.
- Store the replaced lens where it will be free from vibration and impact.

**NOTE:**

- Make sure the projection lens is attached securely by rotating the projection lens counterclockwise.

## Power cord

### Connecting

1. Make sure the shape of the power plug and the **AC IN** terminal on the back of the projector match, then push the plug all the way in.

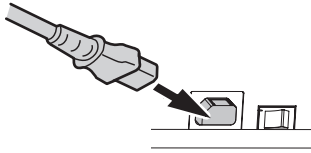

2. Align the side of the power cord secure lock with the side guide rail of the **AC IN** terminal of the projector and slide it in.

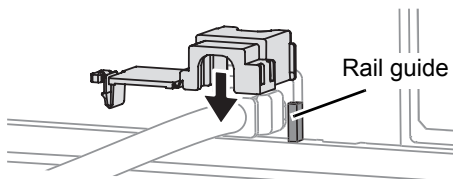

3. Place the latch to the latch catcher and press until it clicks.

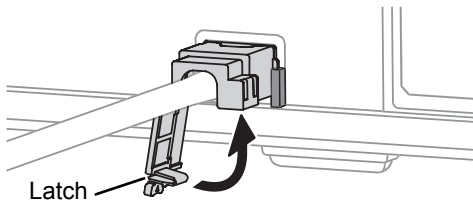

4. Connect the power cord to a wall outlet.

### Disconnecting

1. Unplug the power cord from the wall outlet.
2. Depress the latch and slide the cover off.

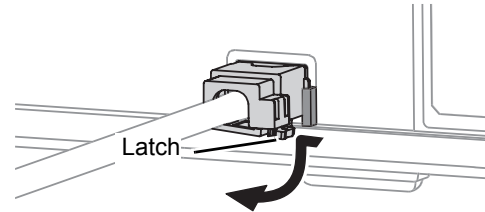

3. Slide the power cord secure lock up along the side guide rail and remove.

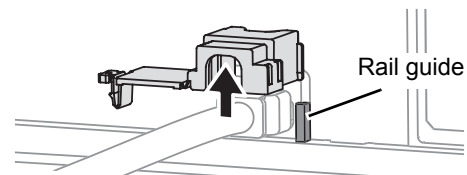

4. Hold the plug and unplug the power cord from the **AC IN** terminal on the back of the projector.
  - Power indicator lights in orange if the internal cooling fan is still operating by internal power supply.

#### NOTE:

- Do not use other than the provided power cord.
- Ensure all the input devices are connected and turned off before connecting the power cord.
- Do not force the connector as this may damage the projector and/or the power cord.
- Dirt or dust build-up around plugs may cause fire or electrical hazards.
- Switch off the power to the projector when not in use.
- If the projector is switched on again while the internal cooling fan is still operating by the internal power supply, it may take a while to start the projection.

# Projecting

## Projecting a image

### Switching on the projector

When using an optional lens, install a projection lens before switch on the projector.

1. Connect the supplied power cord (220 - 240 V AC, 50 Hz/60 Hz) to the **AC IN** terminal.
2. Remove the projection lens cover from the lens.
3. Switch the **POWER** switch on that is on the side of the projector.
  - The power indicator lamp on the projector will flash in red. After a short period, the indicator will illuminate and the projector will enter standby mode.

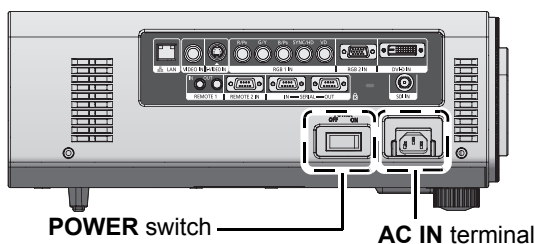

4. Press the **POWER ON** button
  - The power indicator lamp illuminates in green and soon the image is projected on the screen.

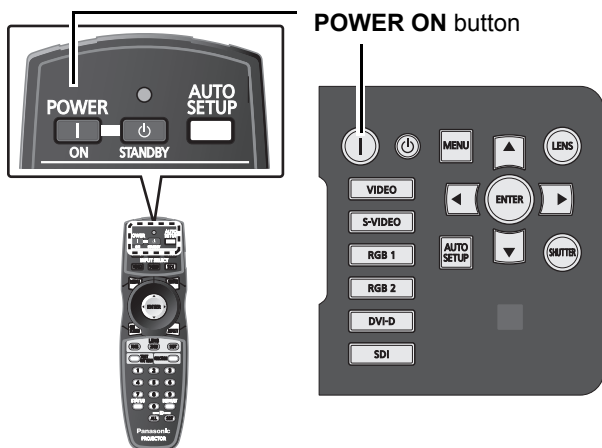

#### NOTE:

- If the projector is powered up at about 0 °C (32 °F), a warm-up period of approximately 5 minutes may be necessary to start projection. The temperature monitor (**TEMP**) lamp lights up during the warm-up period. When the warm-up is completed, the temperature monitor (**TEMP**) lamp turns off and the image is projected on the screen.
- If the temperature of the operating environment is low and warm-up takes more than 5 minutes, the projector will judge that a problem has occurred and the power will be turned off automatically. If this happens, increase the temperature around the projector so that it is 0 °C (32 °F) or higher, and then turn on the **POWER** switch and press the **POWER ON** button again.

### Making adjustment and selection

It is recommended that the projector be allowed to warm up for at least 30 minutes before any adjustments are made to the focus.

1. Roughly adjust the focus of the lens.
2. Select and set the projection scheme of **INSTALLATION** setting in **PROJECTOR SETUP** menu.
3. Select the input signal by pressing the **INPUT SELECT** buttons.
4. Adjust the vertical tilt of the projector with the front leg adjusters.
5. Adjust the shift position of the projection.
  - If the input signal is RGB signal, additionally press the **AUTO SETUP** button to adjust the position of the image.
6. Zoom the lens so the image fills the screen.
7. Readjust the focus.
8. Readjust the zoom so that the image size fits in the screen.

### Adjusting focus, zoom and shift

<b>Control buttons of the projector</b>	Pressing the <b>LENS</b> button changes the setup screen in order of <b>FOCUS</b> , <b>ZOOM</b> and <b>SHIFT</b> . Press <b>▲ ▼ ◀ ▶</b> to adjust.
<b>Remote control buttons</b>	Press <b>FOCUS</b> , <b>ZOOM</b> or <b>SHIFT</b> button to display the setup screen. Press <b>▲ ▼ ◀ ▶</b> to adjust.

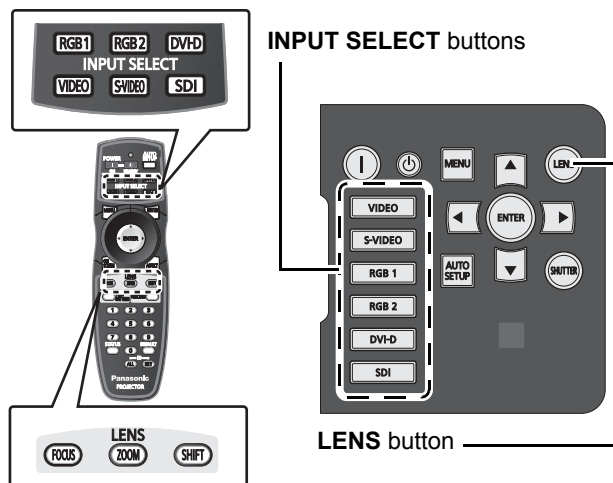

#### CAUTION:

- Be careful not to catch your fingers between the lens and shroud when shifting the lens.

#### NOTE:

- The setup screen will be displayed with the optional fixed lens though, it will not be functioning.
- Pressing **▲ ▼ ◀ ▶** for 3 seconds or more, performance the adjustment faster.

# Projecting

## Switching off the projector

1. Press the **POWER STANDBY** button.
  - The confirmation screen will be displayed.

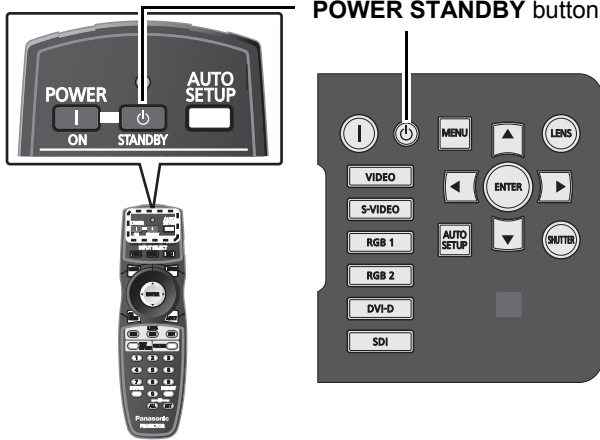

2. Select **OK** and press the **ENTER** button, or press the **POWER STANDBY** button again.
  - The projection of the image stops, and the power indicator of the projector lights up orange. The cooling fan keeps running.
3. When the power indicator of the projector turns to red, switch the **POWER** switch to **OFF**.
  - When the power indicator of the projector turns to red, the cooling fan stops.
  - While the cooling fan is still running, never turn off the **POWER** switch, nor unplug the power cord from the wall outlet.

### NOTE:

- In the cooling state after the power is turned off, the lamp will not light up even if the power is turned on. To light up the lamp, turn on the power supply again when the lamp has been cooled sufficiently. Failure to observe this may shorten the lamp life.

## Direct power off function

The power supplied internally causes the cooling fan to continue operating and cool off in the event that the power has failed or even after the power cord is accidentally disconnected immediately after the power has been turned off.

### NOTE:

- When the lamp has been cooled by the direct power off function, it sometimes takes longer than usual for the lamp to light up again.
- While the cooling fan is operating, do not place the projector inside a box or bag.

## Lens home position

1. Press and hold the **LENS** button of the control button on the projector or **SHIFT** button of the remote control for 3 seconds or more.
  - The **HOME POSITION** setup screen will be displayed for 5 seconds.
2. Press the **ENTER** button before the setup screen disappeared.
  - While the lens returning to the home position, a message "PROGRESS" appears on the screen.

### NOTE:

- The home position for the projection lens is the lens position when the lens is being replaced or when the projector is being stored away, and it is not the optical center of the screen.

## Adjustment range after lens position (optical shift)

Do not move the lens beyond the bounds of the shift range as this may cause a change in the focus. This limitation is to protect the parts of the projector. Using the standard projection position as the reference, the optical axis shift function makes it possible to adjust the projection position in the ranges shown in the figures below.

### PT-DZ6710U/PT-DZ6700U/PT-D6000U

Standard projection position

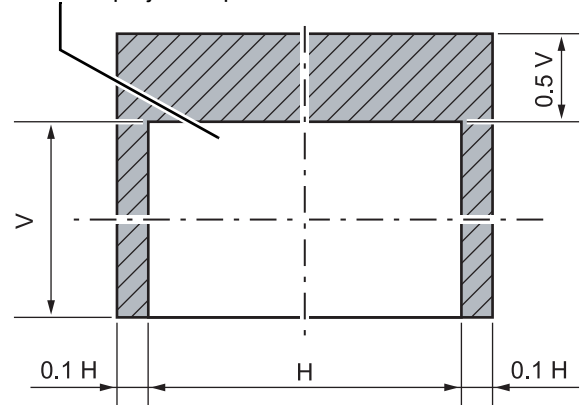

### PT-DW6300U

Standard projection position

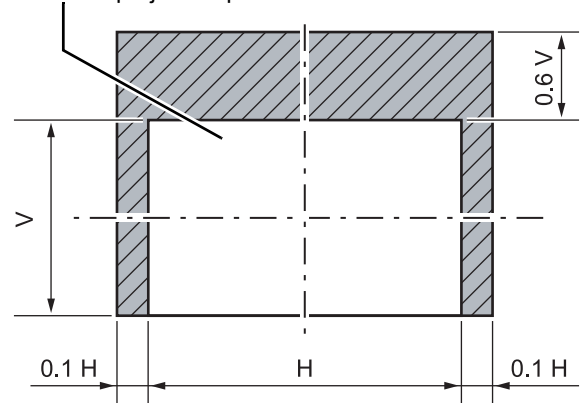

# Remote control operation

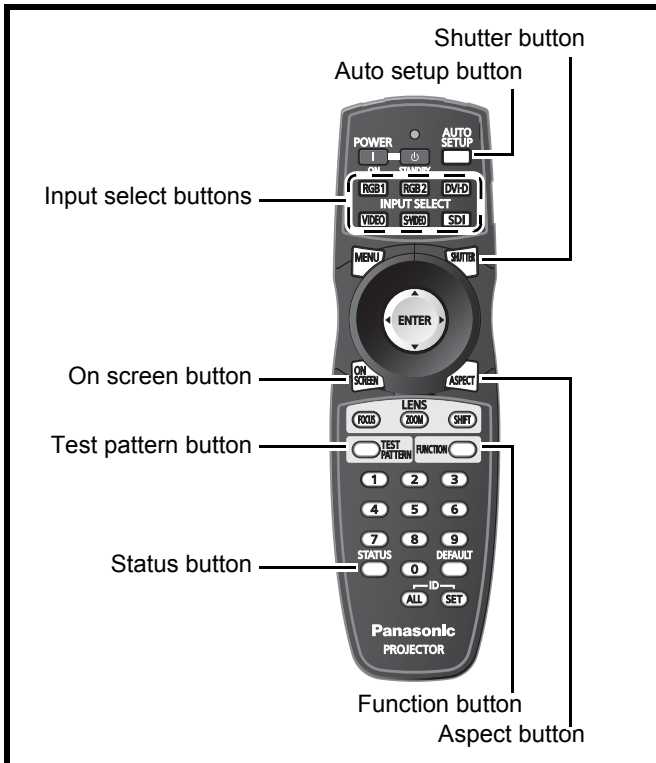

## Operating range

You can operate the projector with the remote control within the remote range 30 m (98'5"), approximately  $\pm 30^\circ$  horizontally and  $\pm 15^\circ$  vertically.

### ● Facing to the projector

Ensure the remote control emitter is facing to the remote control signal receptor on front/back of the projector and press the required buttons to operate.

### ● Facing to the screen

Ensure the remote control emitter is facing to the screen and press the required buttons to operate the projector. The signal will be reflected off the screen. The operating range may differ due to the screen material. This function may not be effective with a translucent screen.

### NOTE:

- Do not let strong light shine onto the signal receptor. The remote control may malfunction under strong light such as fluorescent.
- If there are any obstacles between the remote control and the remote control signal receptor, the remote control may not operate correctly.

## Setting up the image position automatically



The automatic setup function can be used to automatically adjust the resolution, clock phase and picture position when analogue RGB signals consisting of bitmap images such as computer signals are being input, or to automatically adjust the picture position when DVI-D signals are being input.

1. Input an analogue RGB image signal.
2. Press the **AUTO SETUP** button.
3. Displays a message "**PROGRESS**".
4. Displays a message "**COMPLETE**" when ended.
  - When the performance is not completed and ended, displays "**INCOMPLETE**".

### NOTE:

- The automatic setup function does not work with video format signals such as signals output from a DVD player.
- It is recommended to supply images with a bright white frame at the outermost periphery containing characters etc. that are clear in white and black contrast when the system is in automatic adjustment mode.
- Avoid supplying images that involve halftones or gradation such as photographs and computer graphics.
- The clock phase adjustment may have been shifted even when the adjustment ended normally. In this case, manually adjust **CLOCK PHASE** in **POSITION** menu.
- If an image with blurred edges or a dark image is input, "**INCOMPLETE**" may appear or adjustment may not be performed properly even if "**COMPLETE**" appears. In this case, manually adjust **INPUT RESOLUTION** in **ADVANCED MENU**, **CLOCK PHASE** and **SHIFT** in **POSITION** menu.
- For specific signals and landscape signals such as 16:9, see **AUTO SETUP** in **DISPLAY OPTION** menu of the functional instructions that is in the provided CD-ROM.
- Automatic adjustment may not be available depending on the machine type of the computer.
- Automatic adjustment may not be available for synchronisation signal of C-SYNC and G-SYNC.
- Image may be distorted for several seconds during automatic adjustment. This is not a malfunction.
- For every supplied signal, adjustment is required.
- Automatic adjustment can be cancelled by pressing the **MENU** button during the course of automatic adjustment.
- Even for an RGB signal for which automatic setup is possible, if automatic setup is performed while moving images are being input, "**INCOMPLETE**" may appear, or adjustment may not be performed properly even if "**COMPLETE**" appears.

## Remote control operation

### Switching the input signal



You can use the remote control to switch the signals that are being input and projected.

<b>RGB1</b>	Switches to <b>RGB 1 IN.</b>
<b>RGB2</b>	Switches to <b>RGB 2 IN.</b>
<b>DVI-D</b>	Switches to <b>DVI-D IN.</b>
<b>VIDEO</b>	Switches to <b>VIDEO IN.</b>
<b>S-VIDEO</b>	Switches to <b>S-VIDEO IN.</b>
<b>SDI*1</b>	Switches to <b>SDI IN.</b>

\*1. **SDI** is only for PT-DZ6710U.

### Stopping the projection



If the projector is not used for a certain period of time during the meeting intermission, for example, a shutter mode is available that allows the user to hide images temporarily.

- Press the **SHUTTER** button to block the projected light by the internal shutter, and press again to resume.

### Clearing the screen



Press the **ON SCREEN** button to electronically mute the on-screen menus to avoid disrupting the program.

- Press the **ON SCREEN** button again to displays

### Changing the picture aspect ratio



You can toggle through an appropriate set of aspect ratios for a given input signal. The setting will change each time the **ASPECT** button is pressed.



#### Appearance sample

**S-VIDEO** signal

- **VID AUTO ▶ S1 AUTO ▶ VID AUTO(PRI.) ▶ THROUGH ▶ 16:9 ▶ 4:3 ▶ H-FIT ▶ V-FIT ▶ HV-FIT ▶ VID AUTO**

#### NOTE:

- The appearance of setting options vary according to input signals. See **ASPECT** in **POSITION** menu of the functional instructions that is in the provided CD-ROM.

### Displaying the internal test pattern



The projector has 7 types of internal test patterns to check the condition of the set.

1. Display an input signal image.
2. Press the **TEST PATTERN** button.
3. Press **◀ ▶** to select the required test pattern.

#### NOTE:

- See **TEST PATTERN** menu of the functional instructions that is in the provided CD-ROM.

## Using an assigned function



You can assign a selected function to the **FUNCTION** button. Following functions are assignable.

Options	Functions
<b>DISABLE</b>	Deactivate the <b>FUNCTION</b> button.
<b>SUB MEMORY LIST</b>	Display the assigned <b>SUB MEMORY LIST</b> .
<b>SYSTEM SELECTOR</b>	Switches the <b>SYSTEM SELECTOR</b> options.
<b>SYSTEM DAYLIGHT VIEW</b>	Switches the <b>SYSTEM DAYLIGHT VIEW</b> setting.
<b>FREEZE</b>	Freezes the image.
<b>SIDE BY SIDE</b>	Start the <b>SIDE BY SIDE</b> mode.

**NOTE:**

- See **FUNCTION** in **PROJECTOR SETUP** menu and each corresponding menu items of the functional instructions that is in the provided CD-ROM.

## Displaying the status of the projector



Pressing this button displays several pages of projector status information.

**NOTE:**

- See **STATUS** in **PROJECTOR SETUP** menu and “Accessing with the web browser” in Technical Information of the functional instructions that is in the provided CD-ROM.

## Resetting to the factory default



If an adjustment item is selected and press the **DEFAULT** button, the adjustment value will return to the factory default setting.



# Menu Navigation

## Main menu and Sub-menu

The menu options are structured and categorized. You can navigate through the menu with ▲ ▼ ◀ ▶ buttons. See "Navigating through the menu" on page 27.

- Some default settings vary by the selected input signal.
- Sub-menu items vary according to the selected input signal.
- Some settings are adjustable without any signals.
- See the functional indications in the CD-ROM that is provided with the projector.



### PICTURE

#### PICTURE MODE

STANDARD	CINEMA
NATURAL	DYNAMIC
GRAPHIC	

#### CONTRAST

(Default: 0)

#### BRIGHTNESS

(Default: 0)

#### COLOR

(Default: 0)

#### TINT

(Default: 0)

#### COLOR TEMPERATURE

DEFAULT	USER
MIDDLE	HIGH

#### WHITE GAIN

(Default: 10)

#### SYSTEM DAYLIGHT VIEW

OFF	1
2	3

#### SHARPNESS

(Default: 6)

#### NOISE REDUCTION

1	2
3	OFF

#### AI

ON	OFF
----	-----

#### SYSTEM SELECTOR

AUTO	NTSC	NTSC 4.43	PAL
PAL-M	PAL-N	SECAM	PAL60
RGB	YCBCR	VGA60	480p
480pRGB	YPBPR	1080/60i	1035/60i
720/60p	1080/24p	1080/50i	1080/30p
1080/25p	1080/24sF	720/50p	480i
576i			



### POSITION

#### SHIFT

#### ASPECT

DEFAULT	VID AUTO	S1 AUTO
VID AUTO(PRI.)		THROUGH
16:9	4:3	H-FIT
V-FIT	HV-FIT	

#### ZOOM

INTERNAL	FULL
----------	------

### CLOCK PHASE

(Default: 16)

### GEOMETRY

(PT-DZ6710U only)

OFF	KEYSTONE
CURVED	PC

#### GEOMETRY:KEYSTONE

VERTICAL KEYSTONE
VERTICAL SUB KEYSTONE
HORIZONTAL KEYSTONE
HORIZONTAL SUB KEYSTONE
LINEARITY

#### GEOMETRY:CURVED

LENS THROW RATIO
VERTICAL KEYSTONE
HORIZONTAL KEYSTONE
VERTICAL ARC
HORIZONTAL ARC
VERTICAL BALANCE
HORIZONTAL BALANCE

### KEYSTONE

(PT-DZ6700U/PT-DW6300U/PT-D6000U only)

VERTICAL KEYSTONE
VERTICAL SUB KEYSTONE
LINEARITY



### ADVANCED MENU

#### DIGITAL CINEMA REALITY

AUTO	OFF
25p FIXED	30p FIXED

#### BLANKING

UPPER	LOWER
LEFT	RIGHT

#### INPUT RESOLUTION

TOTAL DOTS	DISPLAY DOTS
TOTAL LINES	DISPLAY LINES

#### CLAMP POSITION

#### EDGE BLENDING

OFF	ON
-----	----

#### GAMMA

2.2	1.8	2
-----	-----	---

#### BRIGHT ADJUST

BRIGHT INSIDE	BRIGHT OUTSIDE
OUTSIDE AREA	

#### RASTER POSITION

VERTICAL	HORIZON
----------	---------



### DISPLAY LANGUAGE

ENGLISH	РУССКИЙ
DEUTSCH	한국어
FRANÇAIS	中文
ESPAÑOL	日本語
ITALIANO	



**DISPLAY OPTION**

**COLOR MATCHING**

OFF 3 COLORS  
7 COLORS MEASURED

**COLOR CORRECTION**

OFF USER

**CONTRAST MODE**

NORMAL HIGH

**SCREEN SETTING**

**SCREEN FORMAT**

16:10 16:9 4:3

**SCREEN POSITION**

**AUTO SIGNAL**

ON OFF

**AUTO SETUP**

DEFAULT WIDE  
USER

**DVI-D IN**

**DVI EDID**

EDID3 EDID1 EDID2(PC)

**DVI SIGNAL LEVEL**

0-255:PC 16-235

**SDI IN**

64-940 4-1019

**ON-SCREEN DISPLAY**

**OSD POSITION**

1 2 3  
4 5 6  
7 8 9

**OSD DESIGN**

1 2 3  
4 5 6

**OSD MEMORY**

ON OFF

**INPUT GUIDE**

ON OFF

**WARNING MESSAGE**

ON OFF

**BACK COLOR**

BLACK BLUE  
LOGO1 LOGO2

**STARTUP LOGO**

LOGO2 NONE  
LOGO1

**FREEZE**

**SIDE BY SIDE**

VIDEO S-VIDEO  
RGB1 RGB2  
DVI-D SDI  
OFF



**PROJECTOR SETUP**

**PROJECTOR ID**

ALL 1 - 64

**INSTALLATION**

FRONT/FLOOR FRONT/CEILING  
REAR/FLOOR REAR/CEILING

**HIGH ALTITUDE MODE**

OFF ON

**COOLING CONDITION**

FLOOR SETTING  
VERTICAL DOWN SETTING  
CEILING SETTING  
VERTICAL UP SETTING

**LAMP SELECT**

DUAL SINGLE  
LAMP1 LAMP2

**LAMP RELAY**

OFF 00:00 - 23:00

**LAMP POWER**

HIGH LOW

**STANDBY MODE**

NORMAL ECO

**RS-232C**

(IN) BAUDRATE  
(IN) PARITY  
(OUT) BAUDRATE  
(OUT) PARITY  
RESPONSE(ID ALL)  
GROUP  
RESPONSE(ID GROUP)

**REMOTE2 MODE**

DEFAULT USER

**STATUS**

**FILTER COUNTER RESET**

**NO SIGNAL SHUT-OFF**

DISABLE  
15 MIN. 20 MIN. 25 MIN. 30 MIN.  
35 MIN. 40 MIN. 45 MIN. 50 MIN.  
55 MIN. 60 MIN.

**FUNCTION BUTTON**

DISABLE  
SUB MEMORY LIST  
SYSTEM SELECTOR  
SYSTEM DAYLIGHT VIEW  
FREEZE  
SIDE BY SIDE

**DAY AND TIME**

TIME ZONE ADJUST CLOCK

**SAVE ALL USER DATA**

**LOAD ALL USER DATA**

**INITIALIZE**

**SERVICE PASSWORD**



**TEST PATTERN**

**TEST PATTERN**



**SIGNAL LIST**

REGISTERED SIGNAL STATUS  
SUB MEMORY LIST

## Menu Navigation



### SECURITY

---

#### SECURITY PASSWORD

OFF                      ON

---

#### SECURITY PASSWORD CHANGE

---

#### DISPLAY SETTING

OFF                      TEXT  
LOGO1                      LOGO2

---

#### TEXT CHANGE

---

#### MENU LOCK

OFF                      ON

---

#### MENU LOCK PASSWORD

---

#### CONTROL DEVICE SETUP

CONTROL PANEL  
ENABLE                      DISABLE

REMOTE CONTROLLER  
ENABLE                      DISABLE

---



### NETWORK

---

#### NETWORK SETUP

HOST NAME                      DHCP  
IP ADDRESS                      SUBNET MASK  
DEFAULT GATEWAY                      STORE

---

#### NETWORK CONTROL

WEB CONTROL  
PJLink CONTROL  
COMMAND CONTROL  
COMMAND PORT  
STORE

---

#### NETWORK STATUS

DHCP                      IP ADDRESS  
SUBNET MASK                      DEFAULT GATEWAY  
DNS1                      DNS2  
MAC ADDRESS

---

## Navigating through the menu

### ■ Displaying the Main menu

Press the **MENU** button to display the main menu.

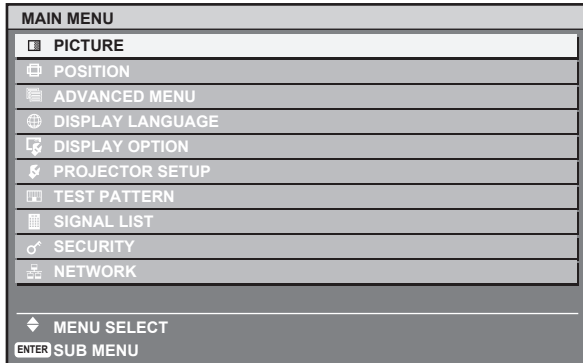

### ■ Adjusting with the bar scale items

The triangle mark under the bar indicates factory default setting and the square indicates the current setting.

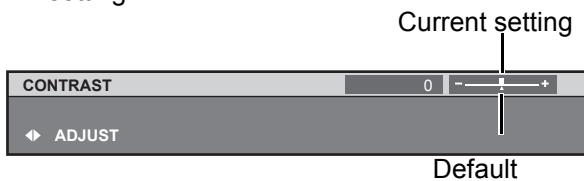

### ■ Returning to the previous menu

Press the **MENU** button to return to the previous menu. Press repeatedly to escape from the menu mode and return to the projection.

### ■ Operating procedure

1. Press **▲ ▼** to scroll to the required main menu item and press the **ENTER** button to select.
  - The selected item is highlighted in orange and the sub-menu is displayed.
  - See "Main menu and Sub-menu" on page 24.

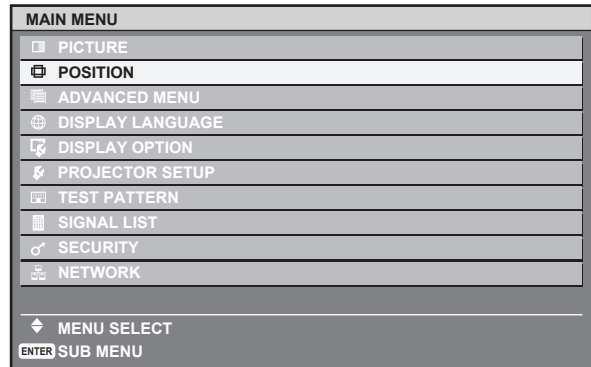

2. Press **▲ ▼** to scroll to the required sub-menu item and press **◀ ▶** or the **ENTER** button to adjust.
  - The selected item is called up and the other menu items disappear from the screen. Called up item will disappear after 5 seconds and return to the menu mode.
  - If there is a lower level, the next level will be displayed.

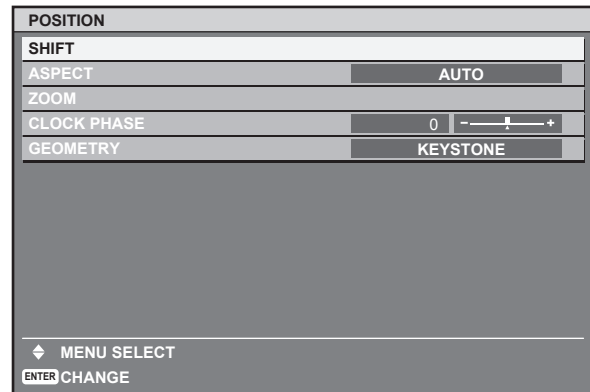

3. Press **◀ ▶** to adjust or set the selected item.
  - For items using a bar scale, the current settings are displayed on the left of the bar scale.
  - You can cycle through the options of an item by pressing **◀ ▶**.



4. Press the **MENU** button to return to the previous menu.

# Monitor Lamp indicators

## Managing the indicated problems

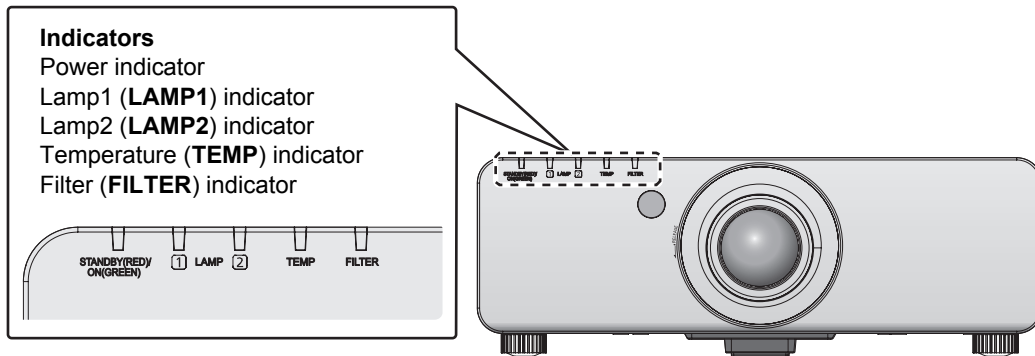

If a problem should occur with the projector, the indicators will inform you. Manage the indicated problems as follow.

1. Confirm the status of all indicators and projector, and switch off the projector in proper way.
2. Find out the cause of the problem by status of each indicator.
3. Follow the instruction for each indication below and solve the problem.
4. Turn on the projector in the correct way and confirm the indicator is not indicating a problem any longer.

### NOTE:

- If no problem is found or the problem remains, do not turn on the projector. Instead contact an Authorized Service Center.

### LAMP1/LAMP2 indicator

Lamp indication	Information	Check point	Remedial measure
Lighting in red	Indicates the time for replacing the lamp unit	<ul style="list-style-type: none"> <li>• Did you notice a “<b>REPLACE LAMP</b>” message on the screen when turning on the projector power supply?</li> </ul>	<ul style="list-style-type: none"> <li>• This lamp monitor lights up when the lamp unit used hours have reached 1 800 hours. Request the dealer to replace the lamp unit.</li> </ul>
Blinking in red once	Lamp unit is not installed.	<ul style="list-style-type: none"> <li>• Check the lamp unit compartment.</li> </ul>	<ul style="list-style-type: none"> <li>• Install the lamp unit.</li> <li>• When lamp unit is installed and still having the indicator lights, contact to the dealer.</li> </ul>
Blinking in red 3 times	Error is detected in the lamp circuit.	<ul style="list-style-type: none"> <li>• Did you turn the power back on immediately after turning it off?</li> <li>• Some error has arisen in the lamp circuit.</li> <li>• Check for fluctuation (or drop) in the source voltage.</li> </ul>	<ul style="list-style-type: none"> <li>• Wait until the lamp has cooled off, and then turn on the power.</li> <li>• Turn off the <b>POWER</b> switch of the projector in proper way and contact the dealer.</li> </ul>

### TEMP indicator

Lamp indication	Information	Check point	Remedial measure
Lighting in red	Warm-up status	<ul style="list-style-type: none"> <li>• Did you turn on the power when the ambient temperature was lower than approx. 0 °C (32 °F)?</li> </ul>	<ul style="list-style-type: none"> <li>• Wait about 5 minutes in the current status.</li> <li>• Install the unit in a location having an ambient temperature from 0 °C (32 °F) - 45 °C (113 °F).</li> </ul>
	High temperature inside. (WARNING)	<ul style="list-style-type: none"> <li>• Check the ventilation port is blocked.</li> </ul>	<ul style="list-style-type: none"> <li>• Remove the object that is blocking the ventilation port.</li> <li>• Move the projector to a temperature of 0 °C (32 °F) - 45 °C (113 °F) and the humidity of 20 % to 80 % (no condensation).</li> <li>• Turn off the <b>POWER</b> switch of the projector in proper way and contact the dealer.</li> </ul>
Blinking in red twice	High temperature inside. (Standby condition)	<ul style="list-style-type: none"> <li>• Is the room air temperature too high?</li> <li>• Was the temperature warning indication displayed?</li> </ul>	
Blinking in red 3 times	Cooling fan has been stopped.		<ul style="list-style-type: none"> <li>• Turn off the <b>POWER</b> switch of the projector in proper way and contact the dealer.</li> </ul>

## **FILTER indicator**

The **FILTER** indicates the Auto Cleaning Filter (ACF) unit status.

Lamp indication	Information	Check point	Remedial measure
Lighting in red	The ACF unit has run out.	<ul style="list-style-type: none"> <li>Check the <b>REMAINING FILTER</b> of <b>STATUS</b> in <b>PROJECTOR SETUP</b> menu.</li> </ul>	<ul style="list-style-type: none"> <li>Replace the ACF unit.</li> </ul>
Blinking in red	The ACF unit is not installed.*1	<ul style="list-style-type: none"> <li>Check the ACF unit compartment.</li> </ul>	<ul style="list-style-type: none"> <li>Replace the ACF unit.</li> </ul>
Lighting in orange	The ACF unit remains few. The remaining use time of the ACF unit is approximately 200 hours.*2	<ul style="list-style-type: none"> <li>Check the <b>REMAINING FILTER</b> of <b>STATUS</b> in <b>PROJECTOR SETUP</b> menu.</li> </ul>	<ul style="list-style-type: none"> <li>Request the dealer to purchase the new ACF unit.</li> </ul>
Blinking in orange	The ACF unit cannot operate properly.	<ul style="list-style-type: none"> <li>Is foreign object blocking the ACF unit operation?</li> </ul>	<ul style="list-style-type: none"> <li>Remove the foreign object from the ACF unit.</li> <li>When the foreign object still remained, contact the dealer.</li> </ul>

\*1. When the ACF unit is not installed, displays "**THE AIR FILTER HAS NOT BEEN INSTALLED PROPERLY.**" message and power off with the indicator blinking in red.

\*2. 200 hours is the roughly guided time.

### **NOTE:**

- When the **FILTER** indicator is flashing green, the Auto Cleaning Filter (ACF) is normally rolling up.
- When the ACF unit is operating, operational sound may be heard.
- In a dusty environment, the guided remaining use time will be shorter. Contact the dealer to purchase the new ACF unit earlier.
- If using the projector at high elevations 1 400 - 2 700 m (4 593 - 8 858 ft) sea level and **HIGH ALTITUDE MODE** in **PROJECTOR SETUP** menu is **OFF**, it may cause malfunction of the ACF unit.

# Replacement

## Replacing the Lamp unit

### Before replacing the Lamp unit

- Turn off the **POWER** switch of the projector in proper way and disconnect the power plug from the wall outlet.
- Wait for more than 1 hour and make sure the lamp unit and the surroundings are cooled enough.
- Prepare a Phillips-head screwdriver.
- Contact the dealer to purchase a replacement lamp unit (ET-LAD60:1 bulb unit, ET-LAD60W: 2 bulb units).
- When the projector is mounted on the ceiling, do not work directly under the projector or put your face closer to the projector.

#### CAUTION:

- The lamp may explode or shorten the lamp life by shocks or chipping damage.

#### NOTE:

- Prior to replacing the lamp unit, allow it to cool down to prevent the risk of burns, damage and other hazards.
- Do not attempt replacement with an unauthorized lamp unit.

### When to replace the lamp unit

The lamp unit is consumable and the brightness decreases by duration of usage. The **LAMP1/LAMP2** indicators will inform you of the replacement timing at 1 800 hours, and at 2 000 hours, the projector will be turned off. Those figures are rough guidance and might be shortened by the usage conditions, characteristics of the lamp unit, environmental conditions, and so on. You can check the duration of usage time using **LAMP1/LAMP2** of **STATUS** in the **PROJECTOR SETUP** menu.

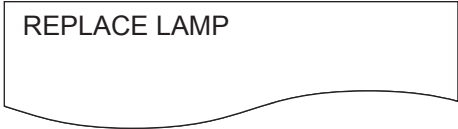
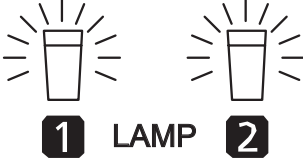
Indication	On screen	LAMP indicator
Over 1 800 hours		
Over 2 000 hours	<p>“REPLACE LAMP” is displayed on the upper left of the screen for 10 minutes. Press any button to clear the screen, or disappears after 10 minutes.</p> <p>“REPLACE LAMP” is displayed on the upper left of the screen, and it will stay until you respond. To clear the screen, press any button.</p>	Lights in red

#### CAUTION:

- If you keep using the lamp unit after 2 000 hours, it cause the damage of the projector. Automatically the projector will be powered off after 10 minutes.

#### NOTE:

- The guide times, 1 800 and 2 000 hours, are rough estimates based on certain conditions and are not a guaranteed time.
- For more information about the lamp unit, such as guaranteed time, see the instructions which is provided with the lamp unit.

## Replacement procedure

### Removing and replacing the lamp unit

1. Use a Phillips-head screwdriver to loosen the 1 lamp unit cover fixing screw on the back of the projector until the screws turn freely, and remove the lamp unit cover.
  - Slide the lamp unit cover to the buttons and pull to remove.

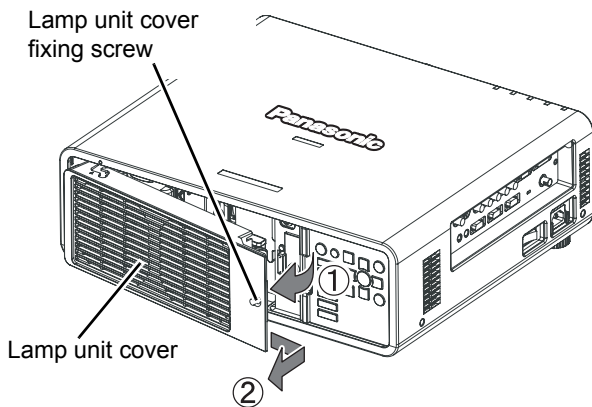

2. Use a Phillips-head screwdriver to remove the 3 lamp unit fixing screws.
3. Hold the handles of the lamp unit and pull the used lamp unit gently from the projector.

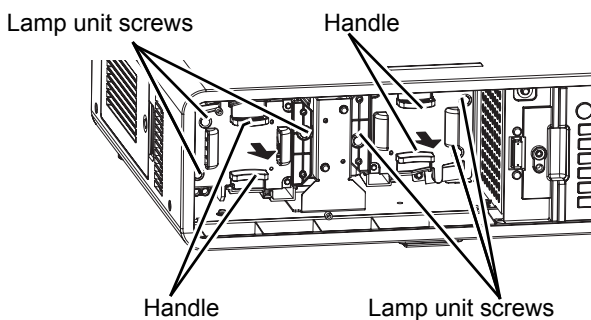

4. Hold the handle of the new lamp unit and replace it in correct direction.
5. Press in the lamp unit until it clicks and make sure the unit is installed securely.
6. Tighten the 3 lamp unit fixing screws securely with a Phillips-head screwdriver.

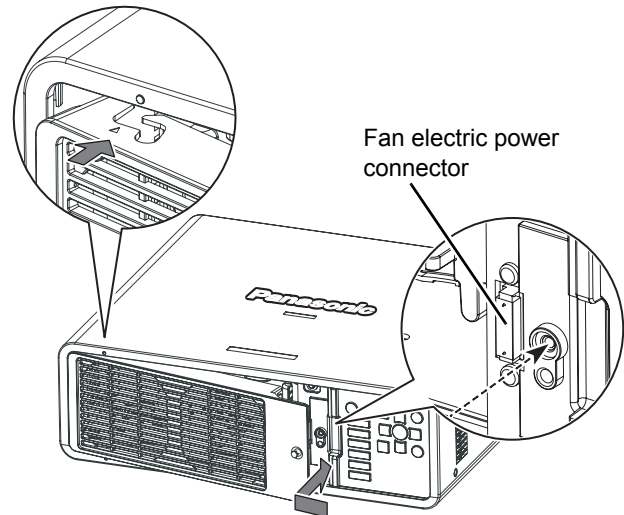

7. Attach the lamp unit cover and tighten the 1 lamp unit cover fixing screw securely with a Phillips-head screwdriver.
  - Slide the lamp unit cover to the hinge side and push in to attach securely.
  - Make sure the fan electric power connector of the lamp unit cover is inserted securely to the projector's connector.

## Replacing the Auto Cleaning Filter (ACF)

### Before replacing the ACF

- Wait until the cooling fan stops and turn off the **POWER** switch of the projector in proper way.
- Disconnect the power cord from the wall outlet.
- Contact an Authorized Service Center to purchase a replacement ACF (ET-ACF100).

### When to replace the ACF

The ACF unit is consumable product and effects on ventilation. The **FILTER** indicator will inform you of the replacement timing. You can check the remaining amount of the ACF unit in **REMAINING FILTER** of **STATUS** in **PROJECTOR SETUP** menu.



# Replacement

## Replacement procedure

1. Loosen 1 ACF cover fixing screw until the screws turn freely and remove the ACF cover.

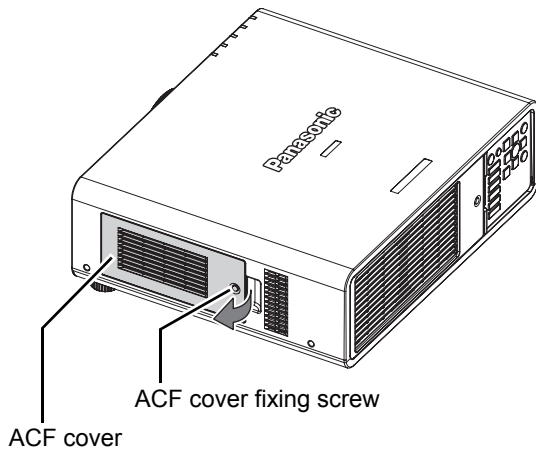

2. Slide out the ACF unit from the projector slowly.
  - When you replace the ACF unit, clean the compartment and/or the air exhaust port if you need to.
3. Insert the new ACF unit into the compartment in correct direction and slightly push until it clicks.

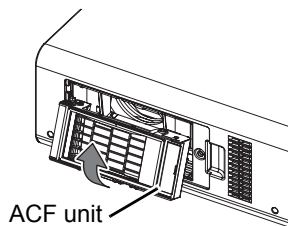

4. Attach the ACF cover and tighten 1 ACF cover fixing screw securely.

### NOTE:

- If the ACF and/or ACF cover are attached incorrectly, the projector may not be turned on.
- Do not switch the power on while the ACF cover removed.
- The replacement timing of the ACF is 36 000 hours of use at maximum and it depends on environment of usage.

## Resetting the REMAINING FILTER

1. Turn on the projector and display the **FILTER COUNTER RESET** in **PROJECTOR SETUP** menu.
2. Press the **ENTER** button.
  - The confirmation screen will be displayed.
3. Select **OK** by pressing **◀**, then press the **ENTER** button.
4. Display the **STATUS** in **PROJECTOR SETUP** menu and confirm the **REMAINING FILTER**.

### NOTE:

- See **FILTER COUNTER RESET** and **STATUS** in **PROJECTOR SETUP** menu of the functional instructions that is in the provided CD-ROM.

# Troubleshooting

Should any problem persist, contact your dealer.

Problem	Cause	Reference page *1
<b>Power does not turn on.</b>	<ul style="list-style-type: none"> <li>● The power cord may not be connected.</li> <li>● The <b>POWER</b> switch is turned off.</li> <li>● No electric supply is at the wall outlet.</li> <li>● <b>TEMP</b> indicator is lit or flashes.</li> <li>● <b>LAMP1/LAMP2</b> indicator is lit or flashes.</li> <li>● The lamp unit cover has not been securely installed.</li> <li>● The circuit breakers have tripped.</li> </ul>	18 20 20 28 28 31 -
<b>No picture appears.</b>	<ul style="list-style-type: none"> <li>● The video signal input source may not be connected to a terminal properly.</li> <li>● The input selection setting may not be correct.</li> <li>● The <b>BRIGHTNESS</b> adjustment setting may be at the minimum setting.</li> <li>● The input source which is connected to the projector may have a problem.</li> <li>● The shutter function may be in use.</li> </ul>	CD-ROM 22 CD-ROM 22
<b>The picture is fuzzy.</b>	<ul style="list-style-type: none"> <li>● The lens focus may not have been set correctly.</li> <li>● The projector may not be at the correct distance from the screen.</li> <li>● The lens may be dirty.</li> <li>● The projector may be tilted too much.</li> </ul>	19 CD-ROM - CD-ROM
<b>The color is pale or grayish.</b>	<ul style="list-style-type: none"> <li>● <b>COLOR</b> or <b>TINT</b> adjustment may be incorrect.</li> <li>● The input source which is connected to the projector may not be adjusted correctly.</li> <li>● RGB cable is damaged.</li> </ul>	CD-ROM - -
<b>The control buttons of the projector do not operate.</b>	<ul style="list-style-type: none"> <li>● <b>CONTROL PANEL</b> of <b>CONTROL DEVICE SETUP</b> in <b>SECURITY</b> menu is disabled. If you have a loss of the remote control while the <b>CONTROL PANEL</b> is disabled, press and hold the <b>MENU</b> button for 2 seconds with pressing the <b>ENTER</b> button.</li> </ul>	CD-ROM
<b>The remote control does not operate.</b>	<ul style="list-style-type: none"> <li>● <b>REMOTE CONTROLLER</b> of <b>CONTROL DEVICE SETUP</b> in <b>SECURITY</b> menu is disabled.</li> <li>● The batteries may be weak.</li> <li>● The batteries may not have been inserted correctly.</li> <li>● The remote control signal receptor on the projector may be obstructed.</li> <li>● The remote control unit may be out of the operation range.</li> <li>● Strong light such as fluorescent shine onto the signal receptor.</li> <li>● The remote control ID setting is incorrect.</li> </ul>	CD-ROM - 14 21 21 - CD-ROM
<b>The picture does not display correctly.</b>	<ul style="list-style-type: none"> <li>● The color format may not have been set correctly.</li> <li>● There may be a problem with the VCR or other signal source.</li> <li>● A signal which is not compatible with the projector is being input.</li> </ul>	CD-ROM - 34
<b>Picture from a computer does not appear.</b>	<ul style="list-style-type: none"> <li>● The cable may be longer than the optional cable.</li> <li>● The external video output from a laptop computer may not be correct. (You may be able to change the external output settings by pressing the [Fn] + [F3] or [Fn] + [F10] keys simultaneously. The actual method varies depending on the type of computer; refer to the documentation provided with your computer for further details.)</li> </ul>	- -
<b>Picture from a computer DVI-D graphic board does not appear.</b>	<ul style="list-style-type: none"> <li>● The graphic board driver of the computer needs to be updated to the latest version.</li> <li>● <b>DVI-D IN</b> setting in <b>DISPLAY OPTION</b> menu may be incorrect setting.</li> <li>● The computer may need to be restarted after switching <b>DVI-D IN</b> setting in <b>DISPLAY OPTION</b> menu of the projector correctly.</li> </ul>	- CD-ROM -

\*1. CD-ROM: See the functional instructions in the provided CD-ROM.

# Technical Information

## List of compatible signals

Mode	Display resolution (dots) <sup>*1</sup>	Scanning frequency		Dot clock frequency	Picture quality <sup>*2</sup>	PnP <sup>*3</sup>			Format <sup>*4</sup>
		H (kHz)	V (Hz)	(MHz)		RGB2	DVI-D EID11	DVI-D EID12	
NTSC/NTSC 4.43/ PAL-M/PAL60	720 x 480i	15.7	59.9	-	A				V/S
PAL/PAL-N/SECAM	720 x 576i	15.6	50.0	-	A				R/Y
525i (480i)	720 x 480i	15.7	59.9	13.5	A				
625i (576i)	720 x 576i	15.6	50.0	13.5	A				D/R/Y
525p (480p)	720 x 483	31.5	59.9	27.0	A		●		
625p (576p)	720 x 576	31.3	50.0	27.0	A		●		
1 125 (1 080)/60i	1 920 x 1 080i	33.8	60.0	74.3	AA <sup>*5</sup>		●		
1 125 (1 080)/50i		28.1	50.0	74.3	AA <sup>*5</sup>		●		
1 125 (1 080)/24p	1 920 x 1 080	27.0	24.0	74.3	AA <sup>*5</sup>		●		
1 125 (1 080)/24sF	1 920 x 1 080i	27.0	24.0	74.3	AA <sup>*5</sup>				
1 125 (1 080)/25p	1 920 x 1 080	28.1	25.0	74.3	AA <sup>*5</sup>		●		
1 125 (1 080)/30p		33.8	30.0	74.3	AA <sup>*5</sup>				
1 125 (1 080)/60p	1 920 x 1 080p	67.5	60.0	148.5	AA <sup>*5</sup>		●		
1 125 (1 080)/50p		56.3	50.0	148.5	AA <sup>*5</sup>		●		
750 (720)/60p	1 280 x 720	45.0	60.0	74.3	AA <sup>*6</sup>		●		
750 (720)/50p		37.5	50.0	74.3	AA <sup>*6</sup>		●		
VGA400	640 x 400	31.5	70.1	25.2	A				D/R
		37.9	85.1	31.5	A				
VGA480	640 x 480	31.5	59.9	25.2	A	●	●	●	
		35.0	66.7	30.2	A				
		37.9	72.8	31.5	A	●		●	
		37.5	75.0	31.5	A	●		●	
SVGA	800 x 600	43.3	85.0	36.0	A				
		35.2	56.3	36.0	A	●		●	
		37.9	60.3	40.0	A	●		●	
		48.1	72.2	50.0	A	●		●	
		46.9	75.0	56.3	A	●		●	
MAC16	832 x 624	49.7	74.6	57.3	A	●		●	
XGA	1 024 x 768	39.6	50.0	51.9	AA <sup>*7</sup>				
		48.4	60.0	65.0	AA <sup>*7</sup>	●		●	
		56.5	70.1	75.0	AA <sup>*7</sup>	●		●	
		60.0	75.0	78.8	AA <sup>*7</sup>	●		●	
		65.5	81.6	86.0	AA <sup>*7</sup>				
		68.7	85.0	94.5	AA <sup>*7</sup>				
		80.0	100.0	105.0	AA <sup>*7</sup>				
MXGA	1 152 x 864	96.7	120.0	130.0	AA <sup>*7</sup>				
		64.0	71.2	94.2	A				
		67.5	74.9	108.0	A				
MAC21	1 152 x 870	76.7	85.0	121.5	A				
1 280 x 768	1 280 x 960	68.7	75.1	100.0	A	●		●	
		39.6	49.9	65.3	AA <sup>*6</sup>				
1 280 x 800	1 280 x 800	47.8	59.9	79.5	AA <sup>*6</sup>				
		41.3	50.0	68.0	AA <sup>*6</sup>				
MSXGA	1 280 x 960	49.7	59.8	83.5	AA <sup>*6</sup>				
		60.0	60.0	108.0	A				
SXGA	1 280 x 1 024	64.0	60.0	108.0	A	●		●	
		80.0	75.0	135.0	A	●		●	
		91.1	85.0	157.5	A <sup>*8</sup>				
SXGA+	1 400 x 1 050	65.2	60.0	122.6	A	●		●	
		82.2	75.0	155.9	A <sup>*8</sup>				
WXGA+	1 440 x 900	55.9	59.9	106.5	A				
UXGA	1 600 x 1 200	75.0	60.0	162.0	A <sup>*8</sup>	●		●	

Mode	Display resolution (dots) <sup>*1</sup>	Scanning frequency		Dot clock frequency	Picture quality <sup>*2</sup>	PnP <sup>*3</sup>			Format <sup>*4</sup>
		H (kHz)	V (Hz)	(MHz)		RGB2	DVI-D EIDI1	DVI-D EIDI2	
WSXGA+	1 680 x 1 050	65.3	60.0	146.3	A				D/R
1 920 x 1 080 <sup>*10</sup>	1 920 x 1 080	66.6	59.9	138.5	AA <sup>*5</sup>				
WUXGA	1 920 x 1 200	74.0	60.0	154.0	AA <sup>*5</sup>	●		●	

\*1. The "i" appearing after the resolution indicates an interlaced signal.

\*2. The following symbols are used to indicate picture quality.

AA Maximum picture quality can be obtained.

A Signals are converted by the image processing circuit before picture is projected.

B Some loss of data occurs to make projection easier.

\*3. Marked signals are indicated in

\*4. The following symbols are used to indicate the format.

V = VIDEO, S = S-VIDEO, D = DVI, R = RGB, Y = YPBPR

\*5. PT-DW6300U/PT-D6000U: A

\*6. PT-DZ6710U/PT-DZ6700U/PT-D6000U: A

\*7. PT-DZ6710U/PT-DZ6700U/PT-DW6300U: A

\*8. PT-DW6300U/PT-D6000U: B

\*9. RGB signals only and DVI-D is not compatible.

\*10. VESA CVT-RB (Reduced Blanking) compatible.

## NOTE:

- Projecting an interlaced signal may cause flicker in screen.

## Display dots of each model

PT-DZ6710U	1 920 x 1 200
PT-DZ6700U	1 920 x 1 200
PT-DW6300U	1 280 x 800
PT-D6000U	1 024 x 768

# Technical Information

## Specifications

<b>Power supply</b>		AC 120 V 60 Hz																																
<b>Power consumption</b>		<ul style="list-style-type: none"> <li>PT-DZ6710U/PT-DZ6700U: 820 W</li> <li>PT-DW6300U/PT-D6000U: 780 W</li> </ul>																																
		During standby (when fan is stopped): Approx. 8 W <sup>*1</sup>																																
<b>Amps</b>		<ul style="list-style-type: none"> <li>PT-DZ6710U/PT-DZ6700U: 8 A</li> <li>PT-DW6300U/PT-D6000U: 7.2 A</li> </ul>																																
<b>DLP™ chip</b>	<b>Panel size (diagonal)</b>	<ul style="list-style-type: none"> <li>PT-DZ6710U/PT-DZ6700U: 0.67 type</li> </ul>	<ul style="list-style-type: none"> <li>PT-DW6300U: 0.65 type</li> <li>PT-D6000U: 0.7 type</li> </ul>																															
	<b>Aspect ratio</b>	<ul style="list-style-type: none"> <li>PT-DZ6710U/PT-DZ6700U/PT-DW6300U: 16 : 10</li> <li>PT-D6000U: 4:3</li> </ul>																																
	<b>Display method</b>	1 unit DLP™ chip, DLP™ type																																
	<b>Pixels</b>	<ul style="list-style-type: none"> <li>PT-DZ6710U/PT-DZ6700U: 2 304 000 (1 920 x 1200)</li> <li>PT-DW6300U: 1 024 000 (1 280 x 800)</li> <li>PT-D6000U: 786 432 (1 024 x 768)</li> </ul>																																
<b>Lens</b>	<b>Motorized zoom</b>	1.8 - 2.4:1	<ul style="list-style-type: none"> <li>Lens is optional for the projectors that "L" follows in model number.</li> </ul>																															
	<b>Motorized focus</b>	<ul style="list-style-type: none"> <li>F 1.7 - 2.0, f 25.6 mm - 33.8 mm</li> <li>PT-DZ6710U/PT-DZ6700U: f = 26.8 - 35.7</li> <li>PT-DW6300U/PT-D6000U: f = 25.6 - 33.8</li> </ul>																																
<b>Lamp</b>		UHM lamp (300 W) x 2																																
<b>Luminosity<sup>*2</sup></b>		<ul style="list-style-type: none"> <li>PT-DZ6710U/PT-DZ6700U/PT-DW6300U: 6 000 lm (ANSI)</li> <li>PT-D6000U: 6 500 lm (ANSI)</li> </ul> <p>Average value of the lens that is provided with the projector.</p>	<ul style="list-style-type: none"> <li>Lens is optional for the projectors that "L" follows in model number.</li> </ul>																															
<b>Operating environment</b>		<p>Temperature: 0 °C - 45 °C (32 °F - 113 °F)</p> <p>Humidity: 20% - 80% (no condensation)</p>																																
<b>Scanning frequency<sup>*3</sup></b>	<b>VIDEO/S-VIDEO</b>	H: 15.75 kHz/15.63 kHz, V: 50 Hz/60 Hz																																
	<b>RGB</b>	<p>H: 15 - 91 kHz, V: 50 - 85 Hz Panasonic Intelligent Auto Scanning (PIAS)</p> <p>Dot clock frequency</p> <ul style="list-style-type: none"> <li>PT-DZ6710U/PT-DZ6700U: 162 MHz or less</li> <li>PT-DW6300U/PT-D6000U: 150 MHz or less</li> </ul>																																
	<b>DVI-D</b>	<p>480p, 576p, 720/60p, 720/59.94p, 720/50p, 1 080/60p, 1 080/59.94p, 1 080/50p, 1 080/60i, 1 080/59.94i, 1 080/50i, 1 080/24sF, 1 080/23.98sF, 1 080/30p, 1 080/29.97p, 1 080/25p, 1 080/24p, 1 080/23.98p</p> <p>Displayable resolution: VGA - WUXGA (non interlace)</p> <p>Dot clock frequency: 25 - 162 MHz</p> <p>WUXGA signal is applicable with VESA CVT-RB (Reduced Blanking).</p>																																
	<b>YPBPR</b>	<table border="0"> <tr> <td>• 480i</td> <td>H: 15.73 kHz, V: 59.94 Hz</td> <td>• 576i</td> <td>H: 15.63 kHz, V: 50 Hz</td> </tr> <tr> <td>• 480p</td> <td>H: 31.5 kHz, V: 59.94 Hz</td> <td>• 576p</td> <td>H: 31.25 kHz, V: 50 Hz</td> </tr> <tr> <td>• 720/50p</td> <td>H: 37.5 kHz, V: 50 Hz</td> <td>• 720/60p</td> <td>H: 45 kHz, V: 60 Hz</td> </tr> <tr> <td>• 1 035/60i</td> <td>H: 33.75 kHz, V: 60 Hz</td> <td>• 1 080/50i</td> <td>H: 28.13 kHz, V: 50 Hz</td> </tr> <tr> <td>• 1 080/60i</td> <td>H: 33.75 kHz, V: 60 Hz</td> <td>• 1 080/24p</td> <td>H: 27 kHz, V: 24 Hz</td> </tr> <tr> <td>• 1 080/25p</td> <td>H: 28.13 kHz, V: 25 Hz</td> <td>• 1 080/30p</td> <td>H: 33.75 kHz, V: 30 Hz</td> </tr> <tr> <td>• 1 080/24sF</td> <td>H: 27 kHz, V: 48 Hz</td> <td>• 1 080/50p</td> <td>H: 56.25 kHz, V: 50 Hz</td> </tr> <tr> <td>• 1 080/60p</td> <td>H: 67.5 kHz, V: 60 Hz</td> <td></td> <td></td> </tr> </table> <p>HD/SYNC, VD terminals are not compliant with 3 value composite SYNC.</p>		• 480i	H: 15.73 kHz, V: 59.94 Hz	• 576i	H: 15.63 kHz, V: 50 Hz	• 480p	H: 31.5 kHz, V: 59.94 Hz	• 576p	H: 31.25 kHz, V: 50 Hz	• 720/50p	H: 37.5 kHz, V: 50 Hz	• 720/60p	H: 45 kHz, V: 60 Hz	• 1 035/60i	H: 33.75 kHz, V: 60 Hz	• 1 080/50i	H: 28.13 kHz, V: 50 Hz	• 1 080/60i	H: 33.75 kHz, V: 60 Hz	• 1 080/24p	H: 27 kHz, V: 24 Hz	• 1 080/25p	H: 28.13 kHz, V: 25 Hz	• 1 080/30p	H: 33.75 kHz, V: 30 Hz	• 1 080/24sF	H: 27 kHz, V: 48 Hz	• 1 080/50p	H: 56.25 kHz, V: 50 Hz	• 1 080/60p	H: 67.5 kHz, V: 60 Hz	
• 480i	H: 15.73 kHz, V: 59.94 Hz	• 576i	H: 15.63 kHz, V: 50 Hz																															
• 480p	H: 31.5 kHz, V: 59.94 Hz	• 576p	H: 31.25 kHz, V: 50 Hz																															
• 720/50p	H: 37.5 kHz, V: 50 Hz	• 720/60p	H: 45 kHz, V: 60 Hz																															
• 1 035/60i	H: 33.75 kHz, V: 60 Hz	• 1 080/50i	H: 28.13 kHz, V: 50 Hz																															
• 1 080/60i	H: 33.75 kHz, V: 60 Hz	• 1 080/24p	H: 27 kHz, V: 24 Hz																															
• 1 080/25p	H: 28.13 kHz, V: 25 Hz	• 1 080/30p	H: 33.75 kHz, V: 30 Hz																															
• 1 080/24sF	H: 27 kHz, V: 48 Hz	• 1 080/50p	H: 56.25 kHz, V: 50 Hz																															
• 1 080/60p	H: 67.5 kHz, V: 60 Hz																																	
<b>Color system</b>		7 (NTSC/NTSC 4.43/PAL/PAL-M/PAL-N/PAL60/SECAM)																																
<b>Projection size</b>		50" - 600" (1 270 mm - 12 700 mm)																																
<b>Screen aspect ratio</b>		<ul style="list-style-type: none"> <li>PT-DZ6710U/PT-DZ6700U/PT-DW6300U: 16 : 10</li> <li>PT-D6000U: 4:3</li> </ul>																																
<b>Installation</b>		FRONT/FLOOR, FRONT/CEILING, REAR/FLOOR, REAR/CEILING (Menu selection method)																																
<b>Contrast ratio</b>		2 000 : 1 (When CONTRAST MODE in DISPLAY OPTION menu is set to HIGH)																																

Terminals	<b>S-VIDEO IN</b>	1 set, Mini DIN 4p Y: 1.0 V [p-p], C: 0.286 V [p-p], 75 Ω, compatible with S1 signal
	<b>VIDEO IN</b>	1 set, BNC pin jack 1.0 V [p-p], 75 Ω
	<b>RGB 1 IN</b>	1 set, BNC x 5 <ul style="list-style-type: none"> <li>● RGB signal 0.7 V [p-p], 75 Ω <ul style="list-style-type: none"> <li>• G-SYNC: 1.0 V [p-p], 75 Ω</li> <li>• HD/SYNC: TTL high impedance, automatic positive/negative polarity compatible</li> <li>• VD: TTL high impedance, automatic positive/negative polarity compatible</li> </ul> </li> <li>● YPBPR signal <ul style="list-style-type: none"> <li>• Y: 1.0 V [p-p] Synchronisation signal included</li> <li>• PBPR: 0.7 V [p-p], 75 Ω</li> </ul> </li> </ul>
	<b>RGB 2 IN</b>	1 set of high density, D-sub 15p (female) <ul style="list-style-type: none"> <li>● RGB signal 0.7 V [p-p], 75 Ω (G-SYNC: 1.0 V [p-p], 75 Ω) <ul style="list-style-type: none"> <li>• HD/SYNC: TTL high impedance, automatic positive/negative polarity compatible</li> <li>• VD: TTL high impedance, automatic positive/negative polarity compatible</li> </ul> </li> <li>● YPBPR signal <ul style="list-style-type: none"> <li>• Y: 1.0 V [p-p] Synchronisation signal included</li> <li>• PBPR: 0.7 V [p-p], 75 Ω</li> </ul> </li> </ul>
	<b>DVI-D IN</b>	1 set, DVI-D 24-pin (Single link), DVI 1.0 compatible, HDCP compatible
	<b>SERIAL</b>	1 set, D-sub 9-pin (female), RS-232C compatible, computer control use
	<b>REMOTE1</b>	1 set, M3 pin jack, wired remote control use, multiple connection use
	<b>REMOTE2</b>	1 set, D-sub 9-pin, external control use
	<b>LAN</b>	1 set, RJ-45, network connection use, PLink™ compatible, 10 Base-T/100Base-TX
	<b>SDI</b>	1 set, BNC pin jack <ul style="list-style-type: none"> <li>• SD-SDI (Y, Cb, Cr, 4:2:2)</li> <li>• SMPTE259M: 480i, 576i</li> <li>• SMPTE292M: 720/50p, 720/60p, 1 035/60i, 1 080/50i, 1 080/60i, 1 080/25p, 1 080/24p, 1 080/24sF, 1 080/30p</li> </ul>
<b>Cabinet</b>		Moulded plastic
<b>Power cord length</b>		3.0 m (9'10")
<b>Dimensions</b>		Width 498 mm (19- 19/32") Height 175 mm (6 - 7/8") Length 448 mm (17 - 5/8")
<b>Weight</b>		Approx. 16 kg (35.3 lbs.)*4
<b>Remote control</b>	<b>Power supply</b>	3 V DC (AA battery x 2)
	<b>Operating range</b>	Approx. 30 m (98'5") (when operated directly in front of signal receptor)
	<b>Weight</b>	120 g (4.2 ozs.) (including batteries)
	<b>Dimensions</b>	Width 51 mm (2") Length 176 mm (6 - 29/32") Height 22.7 mm (-7/8") (not including surface projection parts)
<b>Options</b>	<b>Ceiling bracket</b>	ET-PKD56H (High ceiling), ET-PKD55S (Low ceiling)
	<b>Projection lens</b>	ET-DLE150, ET-DLE250, ET-DLE350, ET-DLE450, ET-DLE055
	<b>Lamp unit</b>	ET-LAD60 (1 bulb), ET-LAD60W (2 bulbs)
	<b>ACF unit</b>	ET-ACF100

\*1. When STANDBY MODE in PROJECTOR SETUP menu is NORMAL: Approx. 8 W  
When STANDBY MODE in PROJECTOR SETUP menu is ECO: Approx. 0.2 W

\*2. Measurement, measuring conditions and method of notation all comply with ISO21118 international standards.

\*3. See "List of compatible signals" on page 34 for available signals.

\*4. Average value. Each product has an individual variable in weight.

## Technical Information

### Dimensions

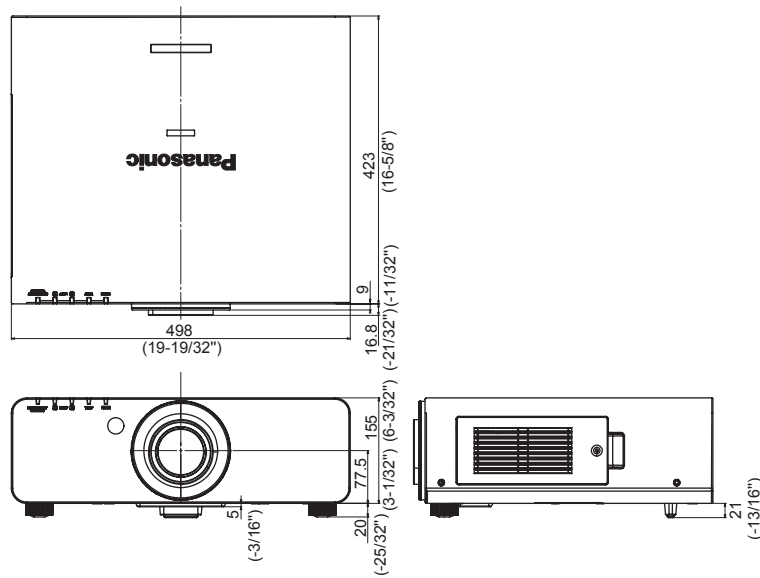

Unit: mm (inch)

### Trademark acknowledgements

- VGA and XGA are trademarks of International Business Machines Corporation.
- S-VGA is a registered trademark of the Video Electronics Standards Association.
- The font used in the on-screen displays is a Ricoh bitmap font, which is manufactured and sold by Ricoh Company, Ltd.

All other trademarks are the property of the various trademark owners.

# Index

<b>A</b>		
Accessories .....	11	
Air exhaust port .....	12	
Air intake port .....	13	
ASPECT		
Remote control button .....	14	
Remote control function .....	22	
Auto Cleaning Filter (ACF) .....	13	
AUTO SETUP		
Control panel button .....	12	
Remote control button .....	14	
Remote control function .....	21	
<b>B</b>		
Battery .....	11	
Compartment .....	14	
Burglar hook port .....	12	
<b>C</b>		
CD-ROM .....	11	
Accessories .....	11	
Menu .....	24	
<b>D</b>		
DEFAULT		
Remote control button .....	14	
Remote control function .....	23	
Dimensions .....	38	
Direct power off .....	20	
DISPLAY LANGUAGE .....	24	
DVI-D		
Control panel button .....	12	
Remote control button .....	14	
Terminal .....	13	
<b>E</b>		
ENTER		
Control panel button .....	12	
Menu navigation .....	27	
Remote control button .....	14	
<b>F</b>		
FILTER		
Compartment .....	13	
Indicator .....	12	
Indicator status .....	29	
Replacing .....	31	
FOCUS		
Adjusting .....	19	
Remote control button .....	14	
Focus ring .....	12	
Front leg adjusters .....	12	
FUNCTION		
Remote control button .....	14	
Remote control function .....	23	
<b>I</b>		
ID		
Remote control button .....	14	
Setting .....	15	
INPUT SELECT		
Control panel button .....	12	
Remote control buttons .....	14	
Remote control function .....	22	
INSTALLATION		
Projection method .....	16	
<b>L</b>		
LAMP		
Indicator status .....	28	
Lamp unit compartment .....	12	
LAMP1/LAMP2 indicators .....	12	
Replacing .....	30	
LAN		
Terminal .....	13	
LENS		
Control panel button .....	12	
Projection lens .....	12	
Projector lens cover .....	11	
Remote control button .....	14	
Lens home position .....	20	
<b>M</b>		
Mains lead		
AC IN terminal .....	13	
Accessories .....	11	
Connecting .....	18	
MENU		
CD-ROM .....	24	
Control panel button .....	12	
Navigation .....	27	
Remote control button .....	14	
Structure .....	24	
<b>N</b>		
Navigation buttons		
Control panel .....	12	
Navigation .....	27	
Remote control buttons .....	14	
Numeric (0 - 9) buttons		
Remote control buttons .....	14	
<b>O</b>		
ON SCREEN		
Remote control button .....	14	
Remote control function .....	22	
<b>P</b>		
POWER		
Switch .....	13	
Switching on/off .....	19	
Power cord secure lock		
Accessories .....	11	
Attaching .....	18	
POWER ON		
Control panel button .....	12	
Remote control button .....	14	
Switching on/off .....	19	
POWER STANDBY		
Control panel button .....	12	
Remote control button .....	14	
Projector lens cover		
Accessories .....	11	
<b>R</b>		
Remote control .....	14	
Accessories .....	11	
Signal receptor .....	12	
Wired connection .....	15	
REMOTE1		
Terminal .....	13	
Wired connection .....	15	
REMOTE2		
Terminal .....	13	



# Index

---

RGB1	
Control panel button .....	12
Remote control button .....	14
Terminal .....	13

RGB2	
Control panel button .....	12
Remote control button .....	14
Terminal .....	13

## S

Safety cable	
Accessories .....	11

SDI	
Control panel button .....	12
Remote control button .....	14
Terminal .....	13

Security lock .....	13
---------------------	----

SERIAL	
Terminal .....	13

SHIFT	
Adjusting .....	19
Adjustment range .....	20
Remote control button .....	14

SHUTTER	
Control panel button .....	12
Remote control button .....	14
Remote control function .....	22

Specifications .....	36
----------------------	----

STATUS	
Remote control button .....	14
Remote control function .....	23

S-VIDEO	
Control panel button .....	12
Remote control button .....	14
Terminal .....	13

## T

TEMP	
Indicator .....	12
Indicator status .....	28

TEST PATTERN	
Remote control button .....	14
Remote control function .....	22

Troubleshooting .....	33
-----------------------	----

## V

VIDEO	
Control panel button .....	12
Remote control button .....	14
Terminal .....	13

## Z

ZOOM	
Adjusting .....	19
Remote control button .....	14

# Avis important concernant la sécurité

## Cher client Panasonic:

Ce mode d'emploi vous donne toutes les informations concernant l'utilisation de ce projecteur. Nous espérons qu'il vous aidera à utiliser au mieux votre nouvel produit, et que vous serez satisfait de votre Projecteur à puce DLP™ Panasonic. Le numéro de série se trouve au bas de l'appareil. Le noter dans l'espace prévu cidessous et conserver ce manuel pour le cas où des réparations seraient nécessaires à l'avenir.

Numéro de modèle: **PT-DZ6710U/PT-DZ6700U/PT-DW6300U/PT-D6000U**

Numéro de série:

**ADVERTENCIA:** POUR REDUIRE LES RISQUES DE FEU OU DE CHOC ÉLECTRIQUE, NE PAS EXPOSER CE PRODUIT À L'EAU OU À L'HUMIDITÉ.

**Alimentation:** Ce projecteur LCD est conçu pour fonctionner sur secteur de 100 V - 240 V, 50 Hz/60 Hz seulement.

**CAUTION:** Le cordon d'alimentation secteur fourni avec le projecteur peut être utilisé uniquement pour une alimentation électrique de 125 V, 7 A maximum. Si on veut l'utiliser avec une tension ou un courant plus forts, on doit se procurer un autre cordon d'alimentation de 250 V. Si on utilise le cordon fourni sous ces conditions, risque de provoquer un incendie.

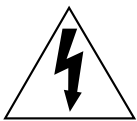

Le symbole de la flèche en forme d'éclair, dans un triangle, avertit l'utilisateur de la présence de «tensions dangereuses» à l'intérieur du produit qui peuvent être de force suffisante pour constituer un risque de choc électrique aux personnes.



Le point d'exclamation dans un triangle avertit l'utilisateur de la présence d'instructions importantes concernant l'utilisation et l'entretien (réparation) dans la littérature accompagnant le produit.

**CAUTION:** Cet appareil est équipé d'une fiche de courant à trois broches avec mise à la terre. Ne pas retirer la broche de mise à la masse de la fiche.  
Cette fiche ne pourra être utilisée que dans une prise avec mise à la terre. Ceci est une précaution sécuritaire. S'il est impossible d'insérer la fiche dans la prise, s'adresser à un électricien. Ne pas annuler la protection de la fiche à mise à la terre.

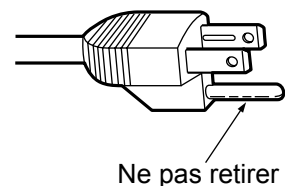

Pursuant to at the directive 2004/108/EC, article 9(2)  
Panasonic Testing Centre  
Panasonic Service Europe, a division of Panasonic Marketing Europe GmbH  
Winsbergring 15, 22525 Hamburg, F.R. Germany

### NOTICE:

- Ce produit possède une lampe à décharge haute intensité (DHI) qui contient du mercure. Son élimination peut être réglementée dans votre s à cause de considérations environnementales. Pour d'amples informations sur la mise au rebut ou le recyclage, veuillez contacter vos autorités locales ou aller au site Web de l'Electronics Industries Alliance: <http://www.eiae.org>

## Avis important concernant la sécurité

### AVERTISSEMENT:

Cet équipement a été soumis à des tests qui ont démontré que celui-ci respectait les limites spécifiées pour les appareils numériques de la classe B aux termes de la partie 15 des règles de la FCC (Federal Communications Commission U.S.A.). Ces limites ont pour objet de fournir une protection raisonnable contre les interférences nuisibles dans le cas d'une installation en milieu résidentiel. Cet équipement produit, utilise et peut rayonner de l'énergie de haute fréquence, et s'il n'est pas installé et utilisé conformément aux instructions fournies avec celui-ci, peut provoquer des interférences nuisibles aux communications radio. En outre, même en cas d'utilisation conforme, il n'est pas garanti qu'aucune interférence ne saurait survenir avec certaines installations. Si cet équipement s'avère nuire à la bonne réception d'émissions de radiophonie ou de télévision, ce que l'on pourra déterminer en mettant l'équipement successivement hors tension puis sous tension, il est conseillé de tenter de remédier au problème par l'une des méthodes suivantes:

- Réorientez ou déplacez l'antenne du récepteur;
- Éloignez l'équipement du récepteur;
- Branchez l'équipement dans une prise de courant située sur un circuit autre que celui qui alimente la prise de courant du récepteur;
- Demandez conseil à votre distributeur ou à un technicien de radio/télévision expérimenté.

**FCC CAUTION:** Pour assurer la bonne conformité, utilisez uniquement des câbles d'interface blindés lorsque vous connectez des ordinateurs ou des périphériques. Toute modification non autorisée de cet équipement annulera le droit de l'utilisateur à utiliser cet équipement.

Si le port sériel est utilisé pour connecter un ordinateur personnel afin de commander le projecteur depuis l'extérieur, il faut utiliser le câble d'interface sériel en option RS-232C avec une âme en ferrite. Tout changement ou modification non autorisé à cet équipement annule l'autorité de faire fonctionner cet appareil.

### ADVERTENCIA:

- Ne peut être utilisé dans une salle d'ordinateurs telle que définie dans la norme ANSI/NFPA 75 Standard for Protection of Electronic Computer/Data Processing Equipment.
- Pour l'équipement branché en permanence, un dispositif de dis connexion d'accès facile doit être incorporé dans le câble d'installation du bâtiment;
- Pour l'équipement bran cable, une prise secteur d'accès facile doit être installée près de l'équipement.

### Déclaration de conformité

Modèle n°: **PT-DZ6710U/PT-DZ6700U/PT-DW6300U/PT-D6000U**

Désignation commerciale: **Panasonic**

Fabricant responsable: Panasonic Corporation of North America

Adresse: One Panasonic Way, Secaucus, New Jersey 07094

Téléphone: (888) 411 - 1996

Email: [projectorsupport@us.panasonic.com](mailto:projectorsupport@us.panasonic.com)

Cet appareil est conforme à la partie 15 des règles de la FCC (Federal Communications Commission U.S.A.) ce qui signifie: (1) que l'appareil ne produit pas d'interférences nuisibles, et (2) que l'appareil est capable de supporter sans danger les interférences reçues, y compris celles susceptibles de perturber son fonctionnement.

### Information relative à l'élimination des déchets dans les pays extérieurs à l'Union européenne



Ce pictogramme n'est valide qu'à l'intérieur de l'Union européenne. Pour connaître la procédure applicable dans les pays hors Union Européenne, veuillez vous renseigner auprès des autorités locales compétentes ou de votre distributeur.



EU

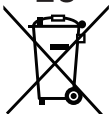

# Précautions de sécurité

## AVERTISSEMENT

**Si l'on remarque une émission de fumée, d'odeurs suspects ou de bruits provenant du projecteur, débrancher la fiche du cordon d'alimentation de la prise de courant.**

- Ne pas continuer d'utiliser le projecteur dans ces cas-là, autrement cela peut entraîner un incendie ou des chocs électriques.
- Après s'être assuré que de la fumée ne se dégage plus, s'adresser à un centre technique agréé et de-mander que les réparations nécessaires soient faites.
- Le fait de réparer le projecteur soi-même est très dangereux, et ne doit jamais être fait.

**Ne pas installer ce projecteur dans un endroit qui n'est pas assez résistant pour supporter le poids du projecteur.**

- Si l'emplacement d'installation n'est pas assez résistant, le projecteur risque de tomber et causer de graves blessures et (ou) des dommages.

**Demander à un technicien qualifié d'installer le projecteur par exemple s'il est installé au plafond.**

- Si l'installation n'est pas faite correctement, cela peut entraîner des blessures ou des chocs électriques.
- Ne pas utiliser un support de montage au plafond qui n'est pas agréé.

**Si de l'eau ou des objets étrangers pénètrent dans le projecteur, si le projecteur tombe, ou si le boîtier est endommagé, débrancher immédiatement la fiche du cordon d'alimentation de la prise de courant.**

- Si l'on continue d'utiliser le projecteur dans cette condition, cela peut entraîner un incendie ou des chocs électriques.
- S'adresser à un centre technique agréé pour que les réparations nécessaires puissent être faites.

**La prise doit être montée à proximité de l'appareil et doit être facilement accessible.**

- Débranchez immédiatement le cordon d'alimentation de la prise si un problème survient.

**Ne pas surcharger la prise de courant.**

- Si l'alimentation est surchargée (par exemple, par l'utilisation de trop d'adaptateurs), cela risque de faire surchauffer le projecteur et peut entraîner un incendie.

**Ne jamais entreprendre toute modification quelconque ou démontage du projecteur.**

- Des hautes tensions qui peuvent causer de graves blessures sont présentes à l'intérieur du projecteur.
- Pour toute inspection, réglage ou réparation, s'adresser à un centre technique agréé.

**Nettoyer la fiche du cordon d'alimentation régulièrement afin d'éviter toute accumulation de poussière.**

- Si de la poussière s'accumule sur la fiche du cordon d'alimentation, l'humidité peut endommager l'isolant et entraîner un incendie. Débrancher la fiche du cordon d'alimentation de la prise de courant et l'essuyer avec un tissu sec.
- Si le projecteur n'est pas utilisé pendant une période prolongée, débrancher la fiche du cordon d'alimentation de la prise de courant.

**Ne pas manipuler le cordon d'alimentation avec les mains mouillées.**

- Cela peut entraîner des chocs électriques.

**Brancher la fiche du cordon d'alimentation fermement dans la prise de courant.**

- Ne pas utiliser de cordon d'alimentation autre que celui fourni.
- Si la fiche n'est pas complètement insérée, cela peut entraîner des chocs électriques ou la faire surchauffer.
- Si la fiche est endommagée ou la plaque de la prise desserrée, celles-ci ne devraient pas être utilisées.

**Ne pas placer le projecteur sur des surfaces instables.**

- Si le projecteur est placé sur une surface qui est inclinée ou instable, il risque de tomber ou de se renverser et cela peut causer des blessures ou des dommages.

**Ne pas placer le projecteur dans l'eau ou ne pas le laisser se mouiller.**

- Sinon cela peut causer un incendie ou des chocs électriques.

**Faire attention à ne pas endommager le cordon d'alimentation.**

- Ne pas endommager le cordon d'alimentation, ne pas le modifier, ne pas le placer sous des objets lourds, ne pas le chauffer, ne pas le placer près d'objets chauffants, ne pas le tordre, ne pas le plier ou le tirer excessivement et ne pas le rouler en boule.
- Si le cordon d'alimentation est endommagé, cela peut entraîner un incendie et des chocs électriques.
- Si le cordon d'alimentation est endommagé, le faire réparer par un centre technique agréé.

**Ne pas placer le projecteur sur des matériaux comme du tapis ou du tissu éponge.**

- Cela peut provoquer une surchauffe du projecteur, pouvant entraîner des brûlures, un incendie ou endommager le projecteur.

**Ne pas placer des récipients de liquide sur le projecteur.**

- Si de l'eau se renverse sur le projecteur ou pénètre dans celui-ci, il y aura risque d'incendie ou d'électrocution.
- Si de l'eau entre à l'intérieur du projecteur, entrer en contact avec un centre technique agréé.

**Ne pas mettre d'objets étrangers dans le projecteur.**

- Ne pas insérer d'objets métalliques ou inflammables dans les orifices de ventilation ou les faire tomber sur le projecteur, car cela peut causer un incendie ou des chocs électriques.

**Veiller à ce que les bornes + et – des piles n'entrent pas en contact avec des objets métalliques tels que colliers ou épingles à cheveux.**

- Sinon, les piles risquent de fuir, de surchauffer, d'exploser ou de prendre feu.
- Ranger les piles dans un sac en plastique, et ne pas les ranger à proximité d'objets métalliques.

## Précautions de sécurité

### Ne jamais entrer en contact direct avec le liquide des piles.

- Le liquide risquerait en effet de causer de sérieuses blessures cutanées. Rincer immédiatement à l'eau courante toute trace du liquide des piles puis consulter au plus vite un médecin.
- Toute pénétration du liquide dans l'oeil risque de même de causer la cécité ou d'autres lésions graves. Eviter dans ce cas à tout prix de vous frotter les yeux, et rincez-les immédiatement à l'eau courante avant de consulter au plus vite un médecin.

### Pendant un orage, ne pas toucher le projecteur ou le câble.

- Il y a risque d'électrocution.

### Ne pas utiliser l'appareil dans un bain ou une douche.

- Il y a risque d'incendie ou d'électrocution.

### Veillez à ce que le faisceau lumineux n'éclaire pas directement votre peau pendant que vous utilisez le projecteur.

- Une lumière intense est émise par l'objectif du projecteur. Si vous vous placez dans ce faisceau lumineux, celui-ci risquera de vous blesser ou de vous abîmer la peau.

### Ne pas regarder directement dans l'objectif pendant que le projecteur fonctionne.

- Une lumière intense est émise par l'objectif du projecteur. Si l'on regarde directement dans cette lumière, elle risque de causer des blessures et de graves lésions aux yeux.
- Veiller particulièrement à ce que les enfants ne regardent pas dans l'objectif. En outre, éteindre le projecteur si on le laisse sans surveillance.

### Ne pas placer les mains ou autres objets près de l'orifice de sortie d'air.

- De l'air chaud sort par l'orifice de sortie d'air. Ne pas placer les mains, le visage ou d'autres objets qui ne peuvent résister à la chaleur près de cette sortie d'air [laisser un espace d'au moins 50 cm], sinon des brûlures ou des dommages risqueraient de s'ensuivre.

### Le remplacement de la lampe ne doit être effectué que par un technicien qualifié.

- La lampe a une pression interne élevée. Si elle est manipulée incorrectement, une explosion peut s'ensuivre.
- La lampe peut être facilement endommagée si elle est heurtée contre des objets durs ou si on la laisse tomber et des blessures et des mauvais fonctionnements peuvent s'ensuivre.

### Lors du remplacement de la lampe, la laisser refroidir pendant au moins une heure avant de la manipuler.

- Le couvercle de la lampe devient très chaud, et on risque de se brûler si on le touche.

### Avant de remplacer la lampe, veiller à débrancher la fiche du cordon d'alimentation de la prise de courant.

- Il y a risque d'électrocution ou d'explosion.

### Ne pas laisser des enfants ou des animaux domestiques toucher la télécommande.

- Après avoir utilisé la télécommande, la ranger hors de portée des enfants ou des animaux domestiques.

### Après avoir retiré la pile de la télécommande, la tenir hors de portée des enfants.

- La pile risque en effet de causer une mort par asphyxie si elle est avalée.
- Demander immédiatement l'avis d'un médecin si la pile a été avalée par quelqu'un.

### Isoler la pile avec du ruban adhésif ou autre matériau similaire avant de la mettre au rebut.

- La pile risquerait en effet de prendre feu ou même d'exploser en cas de contact avec d'autres objets métalliques ou des piles.

### En cas d'installation au plafond, s'assurer d'utiliser le fil accessoire (à installer à un endroit différent que le support de montage au plafond) ainsi que les oeillets correspondants, en tant que mesure de sécurité supplémentaire visant à empêcher toute chute du projecteur.

- Des accidents pourraient en effet être causés par une mauvaise fixation du projecteur.

### Ne pas placer plusieurs kits les uns sur les autres.

- Des accidents pourraient être causés par un non-respect de cette mise en garde.

### N'utilisez pas le projecteur lorsque le couvercle de l'objectif est encore attaché à l'objectif.

- Dans le cas contraire, un incendie risque de se produire.

## MISES EN GARDE

### Ne pas obstruer les orifices d'entrée et de sortie d'air.

- Cela risque de faire surchauffer le projecteur, et causer un incendie ou endommager le projecteur.
- Ne pas installer le projecteur dans des endroits étroits, mal ventilés tels que des placards ou des étagères.
- Ne pas placer le projecteur sur des tissus ou du papier, ces matériaux peuvent être aspirés dans l'orifice d'entrée d'air.

### Ne pas installer le projecteur dans des endroits humides ou poussiéreux ou dans des endroits où le projecteur peut entrer en contact avec des fumées grasses ou de la vapeur.

- L'utilisation du projecteur dans de telles conditions peut causer un incendie, des chocs électriques ou une détérioration du boîtier en plastique. Une détérioration du plastique risquerait en effet d'entraîner une chute du projecteur en cas d'installation au plafond.

### Ne jamais utiliser le projecteur dans un environnement à hautes températures, par exemple à proximité d'un radiateur ou directement soumis aux rayons du soleil.

- Le non-respect de cette mise en garde risquerait de causer un incendie, un dysfonctionnement ou une détérioration du plastique.

### Ne pas utiliser le projecteur à l'air libre.

- Ce projecteur a été conçu pour une utilisation en intérieurs.

### Pour débrancher le cordon d'alimentation, tenir la fiche et non pas le cordon.

- Si le cordon d'alimentation est tiré, le cordon sera endommagé et cela peut causer un incendie, des courts-circuits ou des chocs électriques sérieux.

### Débrancher toujours tous les câbles avant de déplacer le projecteur.

- Le fait de déplacer le projecteur avec des câbles branchés peut endommager les câbles, ce qui pourrait causer un incendie ou des chocs électriques.

### Ne pas placer d'objets lourds sur le projecteur.

- Cela peut déséquilibrer le projecteur et le faire tomber, ce qui peut entraîner des dommages ou des blessures.

### Ne pas court-circuiter, chauffer ou démonter les piles, et ne pas les mettre dans l'eau ou dans le feu.

- Si l'on insère des piles d'un type différent, elles risqueront d'exploser ou de fuir, ce qui peut causer un incendie, des blessures ou une contamination du logement des piles et de la zone environnante.

### Lorsqu'on insère les piles, veiller à ce que les polarités (+ et -) soient bien respectées.

- Si l'on insère les piles incorrectement, elles risqueront d'exploser ou de fuir, ce qui peut causer un incendie, des blessures ou une contamination du logement des piles et de la zone environnante.

### Utiliser uniquement les piles spécifiées.

- Si l'on insère des piles d'un type différent, elles risqueront d'exploser ou de fuir, ce qui peut causer un incendie, des blessures ou une contamination du logement des piles et de la zone environnante.

### Ne jamais mélanger des piles neuves et usagées.

- Si des piles usagées et neuves sont mélangées, elles risquent d'exploser ou de fuir, ce qui peut causer un incendie, des blessures ou une contamination du logement des piles et de la zone environnante.

### Retirer rapidement les piles de la télécommande.

- Si vous laissez des piles usagées dans la télécommande pendant une longue période, cela risque de provoquer des fuites, une hausse anormale de la température interne ou une explosion.

### Si le projecteur ne doit pas être utilisé pendant une longue durée débrancher la fiche électrique de la prise de courant et ôter les piles de la télécommande.

- Si de la poussière s'accumule sur la fiche du cordon d'alimentation, l'humidité ainsi créée risquera d'endommager l'isolation, ce qui peut provoquer un incendie.
- Si les piles restent dans la télécommande, il existe un risque de détérioration par insulation et de fuite électrique ou d'explosion pouvant causer un incendie.

**Nous faisons tous les efforts possibles afin de préserver l'environnement. Prière de rapporter l'appareil, s'il n'est pas réparable, à votre revendeur ou à un centre de recyclage.**

### Ne jamais réutiliser une lampe usagée.

- La lampe risquerait en effet d'exploser.

### Ne pas peser de tout son poids sur ce projecteur.

- On risque de tomber ou de casser l'appareil, ce qui peut causer des blessures.
- Veiller tout particulièrement à ce que les enfants ne se tiennent pas debout ou ne s'asseyent pas sur le projecteur.

### Débrancher la fiche du cordon d'alimentation de la prise de courant comme mesure de sécurité avant d'effectuer tout nettoyage.

- Sinon cela peut causer des chocs électriques.

### Si la lampe s'est cassée, ventiler immédiatement la pièce. Ne pas toucher ni approcher le visage des morceaux cassés.

- Le non respect de cette consigne peut entraîner l'absorption du gaz par l'utilisateur. Ce gaz se dégage lorsque la lampe est cassée et il contient presque autant de mercure qu'une lampe fluorescente, de plus les morceaux cassés peuvent provoquer des blessures.
- Si vous pensez avoir inhalé du gaz ou que du gaz a pénétré dans votre bouche ou dans vos yeux, contactez un médecin immédiatement.
- S'adresser au revendeur pour le remplacement de la lampe et l'inspection de l'intérieur du projecteur.

### Demander à un centre technique agréé de nettoyer l'intérieur du projecteur au moins une fois par an.

- S'il n'est pas nettoyé et que de la poussière s'accumule à l'intérieur du projecteur, cela peut causer un incendie ou des problèmes de fonctionnement.
- Il est recommandé de nettoyer l'intérieur du projecteur avant l'arrivée de la saison humide. Demander au centre technique agréé le plus proche de nettoyer le projecteur lorsque cela est requis. Se renseigner auprès du centre technique agréé pour le coût du nettoyage.

### Ne pas utiliser de chiffons traités chimiquement pour le nettoyage.

- L'utilisation de chiffons traités chimiquement peut provoquer la déformation ou la détérioration du plastique.

### Ne pas toucher les ouvertures situées derrière l'objectif pendant les mouvements horizontaux ou verticaux de celui-ci.

- Sinon des blessures pourraient en résulter.

### Le remplacement de la lampe ne doit être effectué qu'après que celle-ci ait complètement refroidi.

- Sinon des brûlures pourraient en résulter.

## Précautions lors du transport

### Ne pas soumettre le projecteur à des vibrations ou des chocs excessifs.

- L'objectif du projecteur doit être manipulé avec soin.
- Placer le couvercle sur l'objectif lors du transport du projecteur.

### Lors du transport du projecteur, bien le tenir par le bas.

- Ne pas tenir le projecteur par les pieds de réglage ou le couvercle supérieur pour le déplacer car cela pourrait l'endommager.

### Veillez toujours retirer l'objectif pendant le transport.

- L'objectif de projection est sensible aux vibrations et aux impacts.

## Précautions de sécurité

### Précautions lors de l'installation

**Éviter de l'installer dans les endroits sujets à des vibrations ou à des chocs.**

- Les pièces internes peuvent être endommagées, ce qui peut causer des pannes ou des accidents.

**Éviter d'installer le projecteur à des endroits sujets à des changements de température brusques, à proximité d'un climatiseur ou d'un matériel d'éclairage.**

- La durée de vie de la lampe risquerait d'être réduite, ou le projecteur risquerait de s'éteindre. « Indicateur TEMP » à la page 41.

**Ne pas installer le projecteur près de lignes d'alimentation électrique à haute tension ou de moteurs.**

- Le projecteur peut être soumis à des interférences électromagnétiques.

**Si le projecteur est installé au plafond, demander à un technicien qualifié de faire tous les travaux d'installation.**

- Il faut acheter le kit d'installation séparé (numéro de modèle: ET-PKF100H, ET-PKF100S). En outre, tous les travaux d'installation doivent être exécutés uniquement par un technicien qualifié.

**Si l'on utilise ce projecteur à un endroit élevé 1 400 - 2 700 m (4 593 - 8 858 ft), réglez MODE HAUTE ALTITUDE sur OUI.**

- Le non-respect de ces consignes peut entraîner un dysfonctionnement ou peut raccourcir la durée de vie de la lampe ou d'autres composants.

**Veillez installer le couvercle de l'objectif de projection après avoir installé l'objectif de projection.**

- Dans le cas contraire, de la poussière risquerait de s'accumuler à l'intérieur du projecteur et de causer des problèmes.

### Précautions lors de l'utilisation

**Afin d'obtenir la meilleure qualité d'image**

- Fermer les rideaux ou les volets de toutes les fenêtres et éteindre les lampes fluorescentes situées à proximité de l'écran afin que la lumière extérieure ou la lumière des lampes intérieures n'éclaire pas l'écran.
- Dans certains cas peu fréquents, dépendant avant tout des conditions de projection, il est possible que des parasites se forment à l'écran en raison de l'air chaud s'échappant du port d'évacuation d'air. S'assurer qu'il n'y a aucun appareil capable de faire recirculer l'air chaud évacué du projecteur en face de celui-ci ou d'un autre appareil proche.

**Ne pas toucher aux surfaces de l'objectif ou du verre avant avec les mains nues.**

- Si la surface de l'objectif est salie par des empreintes digitales ou autre, celles-ci seraient agrandies et projetées sur l'écran. De plus, refermer le **Couvercle du panneau avant** lorsque le projecteur n'est pas utilisé.

**Composants optiques**

- En cas d'utilisation quotidienne du projecteur pendant 12 heures ou plus, les composants optiques devront être remplacés en moins d'1 an.

**Ne jamais utiliser le projecteur lorsque les pieds réglables ou l'objectif de projection sont retirés.**

- Sinon, l'appareil pourrait ne pas fonctionner correctement ou des accidents pourraient en résulter.

**Puces DLP**

- Les puces DLP sont fabriquées à l'aide d'une technologie de très haute précision. Veuillez noter qu'en de rares cas, des pixels peuvent manquer ou être toujours allumés, mais il ne s'agit pas d'un dysfonctionnement.

**Ce projecteur est équipé d'une lampe au mercure sous haute pression, dont les principales caractéristiques ont:**

- La luminosité de la lampe dépend de la durée d'utilisation.
- Les chocs et éclats risquent d'endommager ou de réduire la durée de vie de la lampe.
- Un risque d'explosion réduit existe pendant la durée d'utilisation du projecteur.
- La lampe risque d'exploser si son utilisation dépasse la durée recommandée de remplacement de la lampe.
- Si la lampe explose, elle émet un gaz interne semblable à de la fumée.
- La durée de vie de la lampe dépend de ses caractéristiques, des conditions d'utilisation et de l'environnement d'installation. La durée de vie de la lampe peut être particulièrement raccourcie par une utilisation continue de plus de 22 heures ou des mises en marche/arrêt fréquentes.
- Prévoyez une lampe de rechange d'avance.

### Autres

**Mise au rebut**

- Lors de la mise au rebut du produit, contacter la municipalité ou le distributeur le plus proche afin de vérifier la procédure appropriée de mise au rebut.

**Connexion à un appareil externe**

- Lors de la connexion du projecteur à un ordinateur ou à un appareil externe, utilisez le cordon d'alimentation fourni avec l'appareil correspondant et un câble d'interface blindé disponible dans le commerce.

## Sécurité

**Suivez les mesures de sécurité lors de l'utilisation du projecteur pour prévenir les éventuels incidents suivants.**

- La fuite d'informations enregistrées personnelles.
- Les activités malhonnêtes accomplies par une tierce partie non digne de confiance.
- L'utilisation du projecteur par une tierce partie non de confiance (pour éviter une telle situation, vous pouvez verrouiller le projecteur).

### Instructions de sécurité

- Le réseau de connexion doit être sécurisé par un parefeu et autres.

### Modifiez fréquemment votre mot de passe.

- Ne pas utiliser de mot de passe trop facile à deviner.
- Le mot de passe ne vous sera jamais demandé par le Centre de dépannage agréé.
- Ne jamais révéler votre mot de passe.
- Attribuer un mot de passe au projecteur et restreindre son accès uniquement aux utilisateurs autorisés.

### Instructions de sécurité

- Le réseau de connexion doit être sécurisé par un pare-feu et autres.
- Modifiez fréquemment votre mot de passe.
- Ne pas utiliser de mot de passe trop facile à deviner.
- Le mot de passe ne vous sera jamais demandé par le Centre de dépannage agréé.
- Ne révélez jamais votre mot de passe.
- Attribuer un mot de passe au projecteur et restreindre son accès uniquement aux utilisateurs autorisés.



# Remplacement

## ■ Avant de remplacer le l'Unité de la lampe

- Mettez l'**POWER** du projecteur en position appropriée et débranchez la fiche de la prise du secteur.
- Attendez plus d'1 heure et vérifiez que la lampe et l'environnement aient suffisamment refroidi.
- Préparer un tournevis cruciforme.
- Contactez le distributeur pour acheter une lampe de rechange (ET-LAD60 : 1 ampoule, ET-LAD60W : 2 ampoules).
- Lorsque le projecteur est monté au plafond, ne travaillez pas directement sous le projecteur et n'en approchez pas le visage.

### ATTENTION:

- Les chocs et éclats risquent de réduire la durée de vie de la lampe ou de la faire exploser.

### REMARQUE:

- Avant de remplacer la lampe, laissez-la refroidir afin d'éviter tout risque de brûlure, de dégâts ou d'autres dangers.
- N'essayez pas de la remplacer par une lampe non agréée.

## ■ Délai de remplacement de l'unité de la lampe

La lampe est un consommable et sa luminosité diminue à mesure que la durée d'utilisation augmente. Les témoins **LAMP1/LAMP2** vous informeront du moment de remplacement à 1 800 heures, et à 2 000 heures, le projecteur s'éteindra. Ces chiffres sont des valeurs approximatives et pourraient s'avérer inférieures selon les conditions d'utilisation, les caractéristiques de la lampe, les conditions environnementales, etc. Vous pouvez vérifier la durée d'utilisation à l'aide de **LAMPE1/LAMPE2** de **ÉTAT** dans le menu **RÉGLAGE PROJECTEUR**.

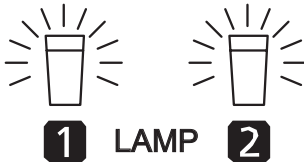
Indication	A l'écran	LAMP Indicateur
Plus de 1 800 heures		
Plus de 2 000 heures	<p>«<b>REEMPLACER LA LAMPE</b>» est affiché dans la partie supérieure gauche de l'écran et y demeure jusqu'à ce que vous répondiez.</p> <p>Pour effacer l'écran, appuyez sur n'importe quelle touche.</p>	S'allume en rouge.

### ATTENTION:

- Si vous continuez à utiliser la lampe au-delà de 2 000 heures, elle endommagera le projecteur. Le projecteur sera mis hors tensions après 10 minutes.

### REMARQUE:

- Les durées indiquées, de 1 800 et 2 000 heures, sont des estimations basé sur certaines conditions et ne représentent en aucun cas des durées garanties.
- Pour de plus amples informations sur la lampe, telle que la durée de fonctionnement garantie, voir les instructions fournies avec la lampe.

## ■ Procédure de remplacement

### ● Retirer et remplacer la lampe

1. Utilisez un tournevis cruciforme pour desserrer la vis de fixation du couvercle de la lampe à l'arrière du projecteur jusqu'à ce que les vis tournent librement, puis retirez le couvercle de la lampe.
  - Faites glisser le couvercle de la lampe jusqu'aux boutons et tirez dessus pour l'ôter.

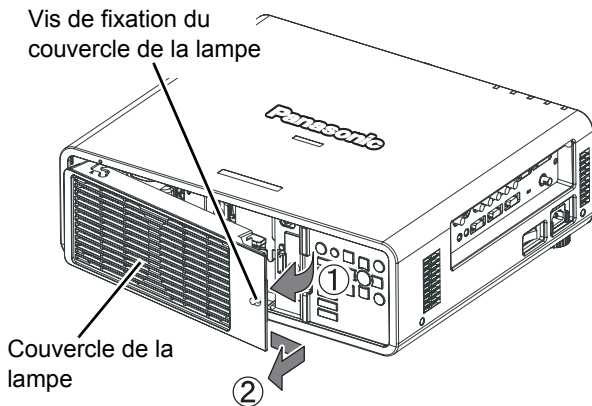

2. Utilisez un tournevis cruciforme pour retirer les 3 vis de fixation de la lampe.
3. Tenez les poignées de la lampe et tirez doucement la lampe usagée hors du projecteur.

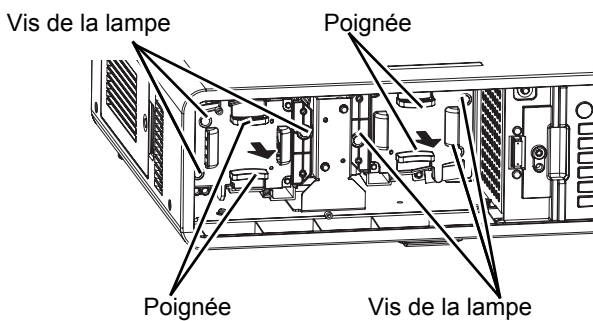

4. Tenez la poignée de la nouvelle lampe et replacez-la dans la direction correcte.
5. Appuyez sur la lampe jusqu'à ce qu'elle fasse entendre un déclic et vérifiez qu'elle est bien en place.
6. Serrez fermement les 3 vis de fixation de la lampe à l'aide d'un tournevis cruciforme.

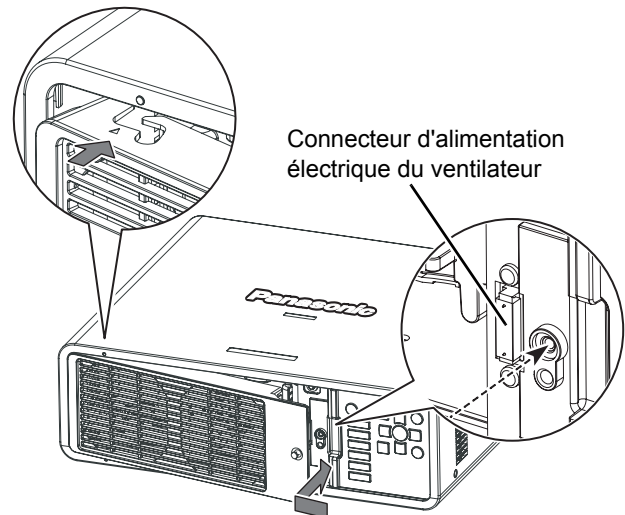

7. Montez le couvercle de la lampe et serrez fermement la vis de fixation du couvercle de la lampe à l'aide d'un tournevis cruciforme.
  - Faites glisser le couvercle de la lampe du côté de la charnière et poussez-le pour le monter fermement.
  - Vérifiez que le connecteur d'alimentation électrique du ventilateur est bien introduit sur le connecteur du projecteur.

**NOTE:**

This product contains a CR Coin Cell Lithium Battery which contains Perchlorate Material - special handling may apply.

See [www.dtsc.ca.gov/hazardouswaste/perchlorate](http://www.dtsc.ca.gov/hazardouswaste/perchlorate).

---

# Panasonic Corporation

Web Site : <http://panasonic.net/avc/projector/>

© Panasonic Corporation 2009

---

**Panasonic Projector Systems Company**

Unit of Panasonic Corporation of North America

One Panasonic Way, Secaucus, NJ 07094

TEL: (201) 392 - 6591

**Technical Support:**

TEL: (888) 411 - 1996

FAX: (201) 348 - 7523

E-Mail: [projectorsupport@us.panasonic.com](mailto:projectorsupport@us.panasonic.com)

**Panasonic Canada Inc.**

5770 Ambler Drive, Mississauga, Ontario L4W 2T3

TEL: (905) 624 - 5010

**Panasonic Puerto Rico, Inc.**

Ave. 65 de Infanteria, Km 9.5 San Gabriel Industrial Park, Carolina, Puerto Rico 00985

TEL: (787) 750 - 4300

Printed in Japan

S0209-1039B

TQBJ0295

