

myprojectorlamps.com

**The most trusted, dependable name
in projector lamp sales.**



<http://www.myprojectorlamps.com>



<http://www.myprojectorlamps.ca>



<http://www.myprojectorlamps.eu>

The following projector manual has not been modified or altered in any way.

Panasonic®

Operating Instructions

3-chip DLP®-based Projector

Commercial Use

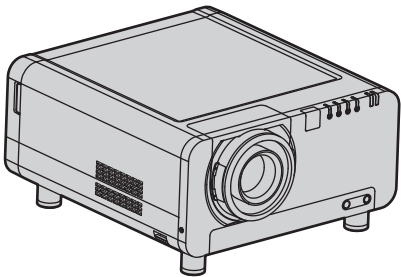

Models No.

PT-D12000U

PT-DZ12000U



Read these instructions completely before operating this unit.

Dear Panasonic Customer:

This instruction booklet provides all the necessary operating information that you might require. We hope it will help you to get the most performance out of your new product, and that you will be pleased with your Panasonic DLP® based projector.

The serial number of your product may be found on an attached label. You should note it in the space provided below and retain this booklet in case service is required.

Model number: **PT-D12000U/PT-DZ12000U**

Serial number:

Contents

Be sure to read the “IMPORTANT SAFETY NOTICE” and the “Precautions with regard to safety”. (pp. 4-9)

IMPORTANT SAFETY NOTICE	4
Precautions with regard to safety	6
Before Using	10
Location and function of each part	12
Using the remote control unit	17
Installation	19
Connection	27
Installation of (optional) input modules	30
How to install and remove the projection lens (optional)	36

Getting Started

Projection	37
How to adjust the lens	40
Registration of input signal data	45
Basic operations using the remote control	48
On-screen menus	51
Adjusting the picture	54
Adjusting the position	60
How to use ADVANCED MENU	64
Setting the DISPLAY LANGUAGE	69

Basic Operation

Display Option settings	70
Projector setup	77
P IN P	85
Displaying the internal test pattern	87
Setting the security	88
How to use network functions	91
Using the PJLink™ protocol	105
Using the serial terminals	106
Using the Remote 2 terminal	110

Special Features

Monitor Lamp Indicators	111
Cleaning and replacement of air filter	112
Replacement of lamp unit	114
Notes when installing the ceiling mount bracket	116
Before asking for service ... try to check the following points again.	117
Self-diagnosis display	118
Specifications	120
Appendix	122
Dimensions	125
Index	126

Information

IMPORTANT SAFETY NOTICE

WARNING: TO REDUCE THE RISK OF FIRE OR ELECTRIC SHOCK, DO NOT EXPOSE THIS PRODUCT TO RAIN OR MOISTURE.

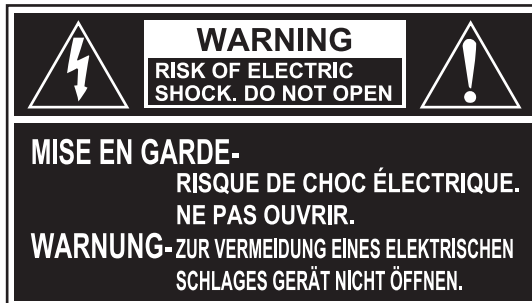

The lightning flash with arrowhead symbol, within an equilateral triangle, is intended to alert the user to the presence of uninsulated “dangerous voltage” within the Product’s enclosure that may be of sufficient magnitude to constitute a risk of electric shock to persons.



The exclamation point within an equilateral triangle is intended to alert the user to the presence of important operating and maintenance (servicing) instructions in the literature accompanying the product.

CAUTION:

This equipment is equipped with a three-pin grounding-type power plug. Do not remove the grounding pin on the power plug. This plug will only fit a grounding-type power outlet. This is a safety feature. If you are unable to insert the plug into the outlet, contact an electrician. Do not defeat the purpose of the grounding plug.

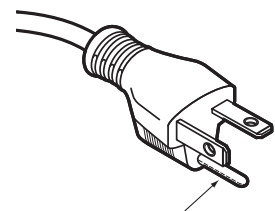

Do not remove

WARNING: This equipment has been tested and found to comply with the limits for a Class B digital device, pursuant to part 15 of the FCC Rules. These limits are designed to provide reasonable protection against harmful interference in a residential installation. This equipment generates, uses and can radiate radio frequency energy and, if not installed and used in accordance with the instructions, may cause harmful interference to radio communications. However, there is no guarantee that interference will not occur in a particular installation. If this equipment does cause harmful interference to radio or television reception, which can be determined by turning the equipment off and on, the user is encouraged to try to correct the interference by one or more of the following measures:

- Reorient or relocate the receiving antenna.
- Increase the separation between the equipment and receiver.
- Connect the equipment into an outlet on a circuit different from that to which the receiver is connected.
- Consult the dealer or an experienced radio/TV technician for help.

FCC CAUTION: To assure continued compliance, use only shielded interface cables when connecting to computer or peripheral devices. Any unauthorized changes or modifications to this equipment could void the user's authority to operate.

WARNING: Not for use in a computer room as defined in the Standard for the Protection of Electronic Computer/Data Processing Equipment, ANSI/NFPA 75.

Declaration of Conformity

Model Number:	PT-D12000U/PT-DZ12000U
Trade Name:	Panasonic
Responsible Party:	Panasonic Corporation of North America One Panasonic Way, Secaucus, New Jersey 07094
Telephone Number:	(888) 411-1996
Email:	projectorsupport@us.panasonic.com

This device complies with Part 15 of the FCC Rules. Operation is subject to the following two conditions: (1) This device may not cause harmful interference, and (2) this device must accept any interference received, including interference that may cause undesired operation.

NOTICE: This product has a High Intensity Discharge (HID) lamp that contains mercury. Disposal may be regulated in your community due to environmental considerations. For disposal or recycling information, please contact your local authorities, or the Electronic Industries Alliance: <http://www.eiae.org>

Precautions with regard to safety

WARNING

- **If a problem occurs (such as no image) or if you notice smoke or a strange smell coming from the projector, turn off the power and disconnect the power cord from the wall outlet.**
 - Do not continue to use the projector in such cases, otherwise fire or electric shocks could result.
 - Check that no more smoke is coming out, and then contact an Authorized Service Center for repairs.
 - Do not attempt to repair the projector yourself, as this can be dangerous.
- **Do not install this projector in a place which is not strong enough to take the full weight of the projector.**
 - If the installation location is not strong enough, it may fall down or tip over, and severe injury or damage could result.
 - Installation work (such as ceiling suspension) should only be carried out by a qualified technician.
 - If installation is not carried out correctly, there is the danger that injury or electric shocks may occur.
- **If foreign objects or water get inside the projector, or if the projector is dropped or the cabinet is broken, turn off the power and disconnect the power cord from the wall outlet.**
 - Continued use of the projector in this condition may result in fire or electric shocks.
 - Contact an Authorized Service Center for repairs.
- **Do not cover the air filter, the air inlet and exhaust vents.**
 - Doing so may cause the projector to overheat, which can cause fire or damage to the projector.
- **Do not overload the wall outlet.**
 - If the power supply is overloaded (for example, by using too many adapters), overheating may occur and fire may result.
- **Do not remove the cover or modify it in any way.**
 - High voltages which can cause fire or electric shocks are present inside the projector.
 - For any inspection, adjustment and repair work, please contact an Authorized Service Center.
- **Clean the power cord plug regularly to prevent it from becoming covered in dust.**
 - If dust builds up on the power cord plug, the resulting humidity can damage the insulation, which could result in fire. Pull the power cord out from the wall outlet and wipe it with a dry cloth.
 - If not using the projector for an extended period of time, pull the power cord plug out from the wall outlet.
- **Do not do anything that might damage the power cord or the power cord plug.**
 - Do not damage the power cord, make any modifications to it, place it near any hot objects, bend it excessively, twist it, pull it, place heavy objects on top of it or wrap it into a bundle.
 - If the power cord is used while damaged, electric shocks, short-circuits or fire may result.
 - Ask an Authorized Service Center to carry out any repairs to the power cord that might be necessary.
- **Do not handle the power cord plug with wet hands.**
 - Failure to observe this may result in electric shocks.
- **Insert the power cord plug securely into the wall outlet.**
 - If the plug is not inserted correctly, electric shocks or overheating could result.
 - Do not use plugs which are damaged or wall outlets which are coming loose.

- **Do not place the projector on top of surfaces which are unstable.**
 - If the projector is placed on top of a surface which is sloped or unstable, it may fall down or tip over, and injury or damage could result.
- **Do not place the projector into water or let it become wet.**
 - Failure to observe this may result in fire or electric shocks.
- **Do not disassemble the lamp unit.**
 - If the lamp section breaks, it may cause injury.
- **Do not place liquid containers on top of the projector.**
 - If water spills onto the projector or gets inside it, fire or electric shocks could result.
 - If any water gets inside the projector, contact an Authorized Service Center.
- **Do not insert any foreign objects into the projector.**
 - Do not insert any metal objects or flammable objects into the projector or drop them onto the projector, as doing so can result in fire or electric shocks.
- **After removing the battery from remote control unit, keep it away from the reach of children.**
 - The battery can cause death by suffocation if swallowed.
 - If the battery is swallowed, seek medical advice immediately.
- **Do not allow the + and - terminals of the battery to come into contact with metallic objects such as necklaces or hairpins.**
 - Failure to observe this may cause the battery to leak, overheat, explode or catch fire.
 - Store the battery in a plastic bag and keep it away from metallic objects.
- **Insulate the battery using tape or similar before disposal.**
 - If the battery comes into contact with metallic objects or other batteries, it may catch fire or explode.
- **Replacement of the lamp unit should be carried out by a qualified technician.**
 - The lamp unit has high internal pressure. If improperly handled, failure might result.
 - The lamp unit can easily become damaged if struck against hard objects or dropped, and injury or malfunctions may result.
- **When installing to a ceiling, be sure to use the accessory wire (install in a different location to the ceiling mount bracket) and the eye bolts as an extra preventative measure to stop the projector from falling down.**
 - If the projector is not secure enough, accidents may result.
- **Do not place sets directly on top of each other.**
 - If this is not observed, accidents may result.
- **Do not use the projector while the projection lens cover is still attached to the projection lens (sold separately).**
 - If this is not observed, fire may occur.
- **Do not look into the lens while the projector is being used.**
 - Strong light is emitted from the projector's lens. If you look directly into this light, it can hurt and damage your eyes.
- **Do not place your skin into the light beam while the projector is being used.**
 - Strong light is emitted from the projector's lens. If you place directly into this light, it can hurt or damage your skin.

CAUTION

- **Do not set up the projector in humid or dusty places or in places where the projector may come into contact with smoke or steam.**
 - Using the projector under such conditions may result in fire or electric shocks.
- **When disconnecting the power cord, hold the plug, not the cord.**
 - If the power cord itself is pulled, the cord will become damaged, and fire, short-circuits or serious electric shocks may result.
- **Always disconnect all cables before moving the projector.**
 - Moving the projector with cables still attached can damage the cables, which could cause fire or electric shocks to occur.
- **Do not place any heavy objects on top of the projector.**
 - Failure to observe this may cause the projector to become unbalanced and fall, which could result in damage or injury.
- **Do not short-circuit, heat or disassemble the battery or place it into water or fire.**
 - Failure to observe this may cause the battery to overheat, leak, explode or catch fire, and burns or other injury may result.
- **When inserting the battery, make sure the polarities (+ and -) are correct.**
 - If the battery is inserted incorrectly, it may explode or leak, and fire, injury or contamination of the battery compartment and surrounding area may result.
- **Use only the specified battery.**
 - If an incorrect battery is used, it may explode or leak, and fire, injury or contamination of the battery compartment and surrounding area may result close to this port, otherwise burns or damage could result.
- **Do not bring your hands or other objects close to the air outlet port.**
 - Heated air comes out of the air outlet port. Do not bring your hands or face, or objects which cannot withstand heat.
- **Do not use the old lamp unit.**
 - The lamp section may break.
- **Replacement of the lamp unit should only be carried out after it has completely cooled off, otherwise burns may result.**
- **Disconnect the power cord plug from the wall outlet as a safety precaution before carrying out any cleaning.**
 - Electric shocks can result if this is not done.
- **If the lamp has broken, ventilate the room immediately. Do not touch or bring your face close to the broken pieces.**
 - Failure to observe this may cause the user to absorb the gas which was released when the lamp broke and which contains nearly the same amount of mercury as fluorescent lamps, and the broken pieces may cause injury.
 - If you believe that you have absorbed the gas or that the gas has got into your eyes or mouth, seek medical advice immediately.
 - Ask your dealer to replace the lamp unit and check the inside of the projector.

■ Ask an Authorized Service Center to clean inside the projector at least once a year.

- If dust is left to build up inside the projector without being cleaned out, it can result in fire or problems with operation.
- It is a good idea to clean the inside of the projector before the season for humid weather arrives. Ask your nearest Authorized Service Center to clean the projector when required. Please discuss with the Authorized Service Center regarding cleaning costs.





■ Do not reach for the openings beside the optical lens, during horizontal or vertical movements of the lens there is a injury hazard.**■ An effort to keep our environment clean, please bring the non-repairable unit to your Dealer or a Recycling Company.****■ Do not use projectors with the adjustable feet or projection lens cover removed.**

- If this is not observed, the sets may not operate correctly or accidents may result.

Before Using

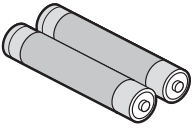
Accessories

Check that all of the accessories shown below have been included with your projector.

Remote Control [N2QAYB000076 × 1]	Batteries for Remote Control (AA)	Power cord		Drop-prevention bracket	
		For 240 V [K2CG3YY00035 × 1]	For 120 V [K2CH3YY00001 × 1]	Eye bolt [TPAHE86 × 4]	Wire [TTRA0143 × 4]
					

Caution when moving the projector

The projection lens is susceptible to vibrations and impacts. Be sure to always remove the lens during transport.

Cautions regarding setup

Be sure to observe the following precautions when installing the product.

- **Be sure to install the projection lens cover after installing the projection lens.**
If this is not done, dust will collect inside the projector and problems with the projector will result.
- **Avoid installing the product in a place exposed to vibrations or impacts.**
If the projector is installed in a place where vibrations are transmitted from a source of driving power and others or mounted in a car, vibrations or impacts may be transmitted to the product to damage the internal parts, causing failure. Install the product in a place free from vibrations and impacts.
- **Do not install the projector near high-voltage power lines or power sources.**
The product may be exposed to interference if it is installed in the vicinity of high-voltage electrical power lines or power sources.
- **Do not place the projector on a vinyl sheet or carpet.**
If a vinyl sheet sucked up and blocks the air filter intake port, the internal temperature of the projector may increase, which triggers the protection circuit, turning off the power.
- **Be sure to ask a specialized technician when to install the product to a ceiling.**
If the product is to be installed hanging from the ceiling, purchase an optional hanging attachment (for high ceiling: Model No. ET-PKD100H) (for low ceiling: Model No. ET-PKD100S) and call a specialized technician for installation.
- **Do not operate the projector over 2 700 m (8881.5') above sea level. When operating between 1 400 m (4605.3') and 2 700 m (8881.5') above sea level, set the "ALTITUDE MODE", described on page 78, to "ON".**
Otherwise the life of the product may be shortened.
- **When installing and using the projector at an angle that exceeds 30° from the horizontal in the vertical direction, set "DIRECTION", described on page 78, to "VERTICAL".**

Notes on use

■ To view clear images:

- The audience cannot enjoy high-contrast and clear images if outside light or the illumination interferes the screen surface. Draw window curtains or blinds, turn off the lightings near the screen or take other proper measures.
- In rare cases, wafture can occur on the screen affected by the warm air from the exhaust port depending on the environment. Make sure that there is no equipment in front of the set which will recirculate the exhaust air from the set or other nearby equipment.

■ Do not touch the surface of the projection lens with bare hand.

If fingerprints or stains are left on the projection lens surface, they are magnified and projected on the screen. Keep your hands away from the lens. Cover the lens with the supplied lens cap when the projector is not used.

■ DLP chips

The DLP chips are made using extremely high-precision technology. Note that in rare cases, pixels may be missing or always lit, but this is not a malfunction.

■ Lamp

A mercury lamp with high internal pressure is used for the light source of this product. A high-pressure mercury lamp has the following characteristics:

- It may burst with a loud sound or end its life cycle by not illuminating because of given impacts, flaws, or deterioration due to used hours.
- The life cycle of a mercury lamp varies according to the individual difference or conditions of use. In particular, turning the power on and off frequently and/or repeatedly will greatly affect the life cycle.
- In rare cases, it may burst shortly after projection starts.
- The possibility of explosion increases when the lamp is used beyond the replacement time.
- When the lamp bursts, the gas inside will be emitted and may appear like smoke.
- Provide a lamp for replacement in advance.

■ Maintenance

Be sure to remove the power cord plug from the receptacle before cleaning.

• Use soft and dry cloth to clean the cabinet

Use a soft cloth moistened in warm water to clean away oil. Do not use solvents such as benzene, thinner, and alcohol, detergents for kitchens, or a chemical cloth. If using such solvents, the outer case may become deformed, and the paint may peel off.

• Do not clean the lens surface with fuzzy or dusty cloth.

If dust adheres to the lens, it will be magnified and projected on the screen. Use a soft and clean cloth to wipe off dust.

Caution:

When connecting the projector to a PC or external device, use the power cord supplied with the corresponding device and a commercially available shielded interface cable.

Disposal

When disposing of the product, contact your nearest municipality or dealer to confirm the correct procedure for disposal.

Attention on security

If you use the network function of this product, there is the likelihood of being subjected to the following damage.

- Personal information being leaked via this product
- Unauthorized operation of this product by a malicious third party
- Interfering or stopping of this product by a malicious third party

Be sure to take sufficient security measures. (pp. 88-94)

- Use a password that is as difficult to guess as possible.
- Change your password regularly.
- Panasonic and its affiliate companies would never directly inquire about your password.

In the event that somebody does make a direct inquiry, do not let the person know your password.

- Use a network for which security measures such as a firewall have been implemented.
- Set a password, and place restrictions on the users who can log in.

Location and function of each part

Remote control unit

■ Front

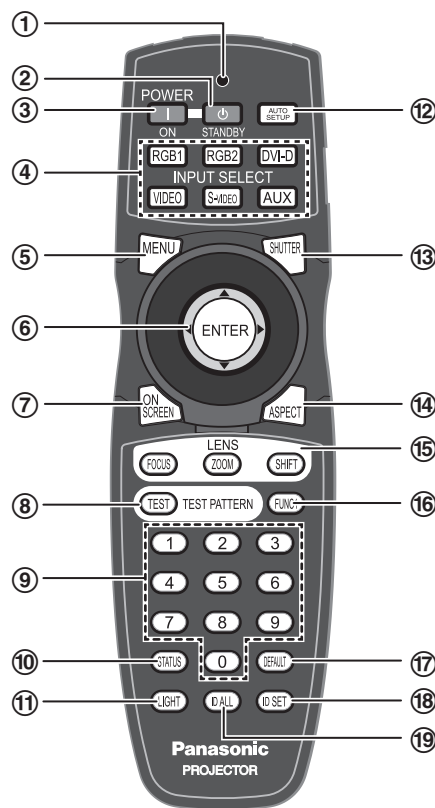

① Remote control operation indicator lamp

This LED flashes when any button is pressed. If it doesn't, check the side Lock switch and the batteries.

② POWER STANDBY button (pp. 37, 39)

When the projector is operating, use this key to enter the Standby mode.

③ POWER ON button (p. 38)

When the projector is in standby mode with the MAIN POWER switch of the projector at the "I" side, this button switches the projector to projection mode.

④ Input select (RGB1, RGB2, DVI-D, VIDEO, S-VIDEO, AUX) button (p. 48)

These buttons select the RGB1, RGB2, DVI-D, VIDEO, S-VIDEO and AUX (optional input module) input ports.

⑤ MENU button (pp. 51, 53)

Use this button to return to the previous screen when the sub menu is displayed. If you hold it down for at least 3 seconds while the on-screen indication is OFF, the OFF state is canceled.

⑥ Arrow ▲ ▼ ◀ ▶ buttons (pp. 53, 88)

Use these buttons to select menu items, change settings, adjust levels, and to enter the "SECURITY" password.

ENTER button (p. 53)

Press to activate a menu selection or to initiate a function.

⑦ ON SCREEN button (p. 48)

This buttons toggles the display of the onscreen menus.

⑧ TEST PATTERN button (p. 49)

Use this button together with the arrow keys to display the internal test patterns.

⑨ Numeric (0-9) buttons (pp. 18, 84)

These buttons are used in systems with multiple projectors to enter projector ID numbers. They may also be used to enter user-adjustment values and by service personnel.

⑩ STATUS button (p. 48)

Press this button to display projector information. It can also be used to send information about the projector's status via E-mail.

⑪ LIGHT button (p. 49)

Press this button to illuminate the remote control buttons. The backlight will be extinguished 10 seconds after the last key press.

■ Side

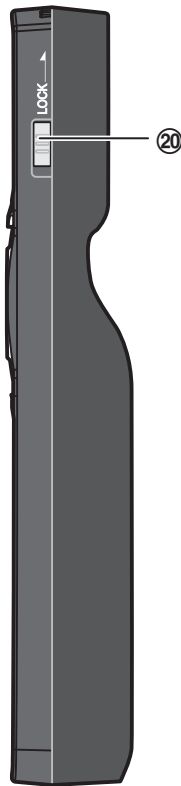

■ Top

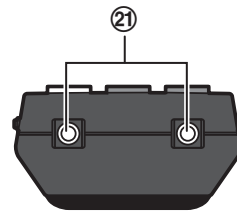

■ Bottom

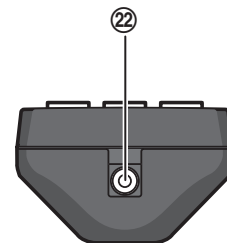

- ⑫ **AUTO SET UP button** (p. 49)
Pressing this button while projecting an image automatically corrects the picture positioning on the screen. While the auto setup feature is active, a message “PROGRESS...” appears on the screen.
- ⑬ **SHUTTER button** (p. 48)
Pressing this button toggles the projector’s internal mechanical shutter to black out the projected image.
- ⑭ **ASPECT button** (p. 50)
Toggles through the aspect ratio settings appropriate for the current input signal.
- ⑮ **LENS (FOCUS, ZOOM, SHIFT) button** ... (p. 40)
These buttons are used together with the arrow keys to adjust the projection lens.
- ⑯ **Function 1 (FUNC1) button** (p. 49)
This button function can be assigned on the “FUNC1” line of the “PROJECTOR SETUP” page, found on the Main Menu page.
- ⑰ **DEFAULT button** (p. 53)
Press this button when you want to restore the setting of the item selected in the menu to the factory default value.
- ⑱ **ID SET button** (pp. 18, 77)
When two or more main units are used in the system, this button specifies the ID of the remote control.

- ⑲ **ID ALL button** (pp. 18, 77)
When two or more projectors are used in the system, this button allows all projectors to be controlled regardless of their current ID assignments.
- ⑳ **LOCK button**
This switch locks the remote to prevent unintended operation and to prevent the batteries from becoming spent during shipment.
- ㉑ **Remote control transmitter window**
Operate the remote control aiming at the remote control receiver window on the main unit.
- ㉒ **Remote control wired terminal** (p. 18)
To use the wired output terminal, connect the remote control and the main unit with the cable (sold separately).

Note

- The AUX input select button is enabled only when an optional input module is installed.

Projector Main Unit

■ Front

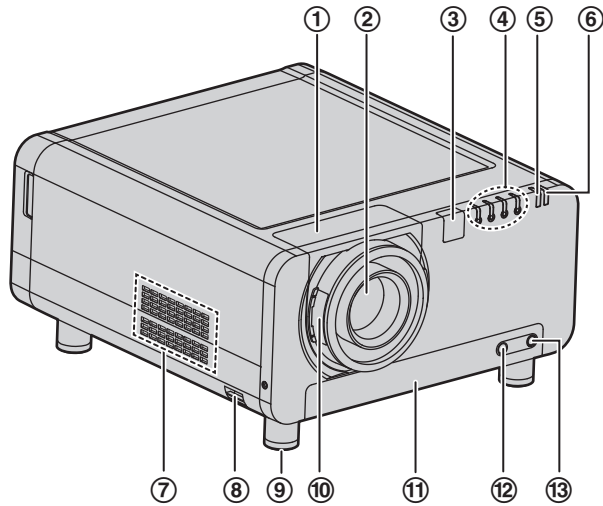

■ Rear

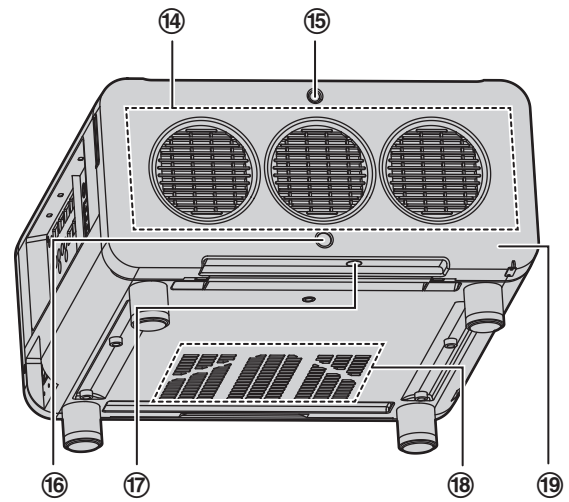

- ① **Projection lens cover** (p. 36)
- ② **Projection lens (optional)**
Lens for projecting images on the screen.
- ③ **Remote control receiver window (front)**
..... (p. 17)
This window receives the signal beam emitted from the remote control.
- ④ **LAMP (LAMP1, LAMP2, LAMP3, LAMP4) monitor** (p. 111)
These LEDs indicate the status of each lamp - GREEN for "In Use", RED for "End-of-Life", and BLINKING RED for "Error Condition".
- ⑤ **Temperature monitor (TEMP)** (p. 111)
These LEDs illuminate and flash to indicate lamp warmup intervals, abnormal internal temperatures, or cooling fan errors.
- ⑥ **Power indicator lamp** (p. 37)
The lamp lights in red when the MAIN POWER switch is turned to "I". It turns to green when the POWER ON button of the remote control or the main unit is pressed.
- ⑦ **Air intake vents**
During installation, ensure adequate airflow to these vents.
- ⑧ **Burglar hook**
Attach a commercial burglar prevention cable to this hook port.
- ⑨ **Adjustable feet** (p. 20)
Use these feet to adjust the tilt of the projector. (Adjustable feet are provided at the front and rear, right and left.)
- ⑩ **Projection lens cover lock button** (p. 36)
Press these side buttons to unlock the lens cowling, pulling it forward to remove. Centering the lens first may ease removal.
- ⑪ **Air filter** (p. 112)
- ⑫ **Air filter cleaning monitor** (pp. 81, 112)
This blinks blue while the air filter is being cleaned. It lights red when there is a problem with the air filter.
- ⑬ **Filter cleaning unit fixing screw** (p. 112)
This is used to secure the air filter cover.
- ⑭ **Air exhaust vents**
During installation do not allow these vents to become blocked.
- ⑮ **Lamp unit cover screw** (p. 115)
This is used to secure the lamp unit cover.
- ⑯ **Remote control receiver window (rear)** · (p. 17)
This also receives the signal beam coming from the remote control.
- ⑰ **Remote control receiver window (bottom)**
..... (p. 17)
This also receives the signal beam coming from the remote control.
- ⑱ **Air intake vents**
During installation, ensure adequate airflow to these vents.
- ⑲ **Lamp unit cover** (p. 115)
This hinged panel swings down for lamp replacement.

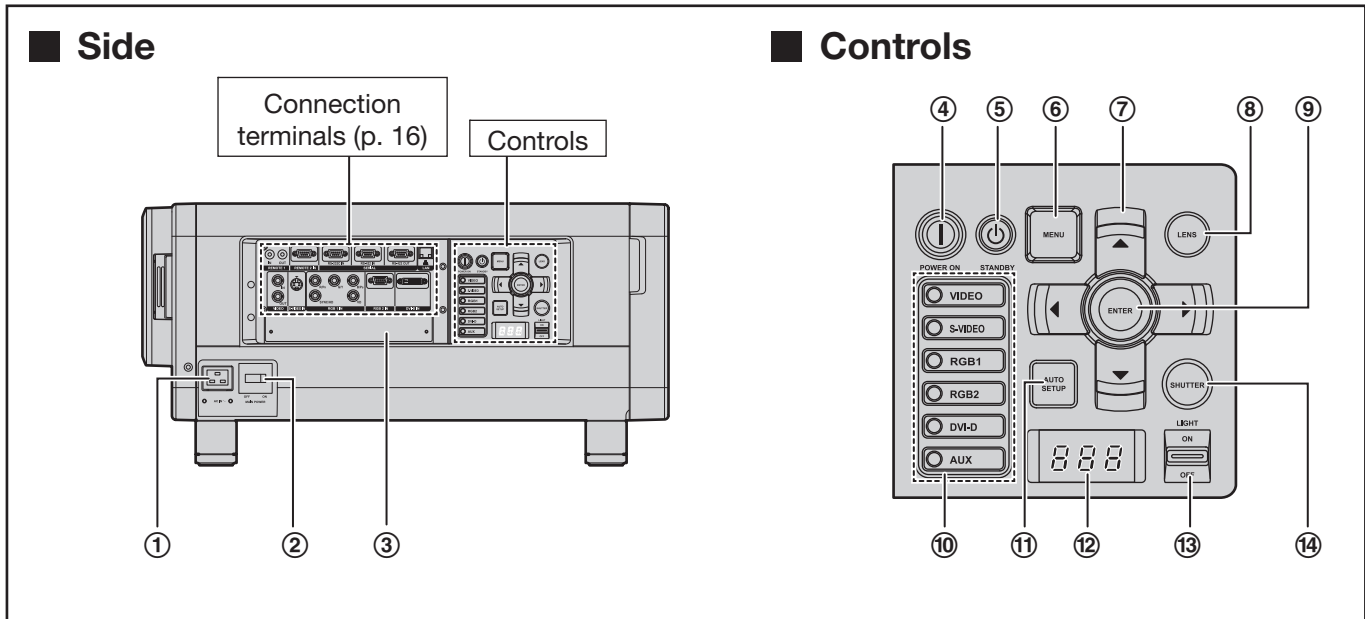

- ① **AC IN terminal** (p. 37)
Connect the supplied line power cord into this receptacle.
Do not connect any other cable to this socket.
- ② **MAIN POWER switch** (pp. 37-39)
Use this switch to turn on “I” and off “O” the commercial line power applied to the projector.
- ③ **Slot cover** (p. 31)
Install the optional input modules here.
- ④ **POWER ON (I) button** (pp. 37, 38)
When the projector is in standby mode with the MAIN POWER switch of the projector at the “I” side, this button switches the projector to projection mode.
- ⑤ **POWER STANDBY (⏻) button** (pp. 37, 39)
When the projector is in use, pressing this button twice puts the projector into the Standby mode.
- ⑥ **MENU button** (pp. 51, 53)
Use this button to return to the previous screen when the sub menu is displayed. If you hold it down for at least 3 seconds while the on-screen indication is OFF, the OFF state is canceled.
- ⑦ **Arrow ▲▼◀▶ buttons** (pp. 53, 88)
Use these buttons to select menu items, change settings, adjust levels, and to enter the “SECURITY” password.

- ⑧ **LENS button** (p. 40)
Toggles through the lens Zoom, Focus, and Shift (H & V) adjustment modes.
- ⑨ **ENTER button** (p. 53)
Press to activate a menu selection or to initiate a function.
- ⑩ **Input select (VIDEO, S-VIDEO, RGB1, RGB2, DVI-D, AUX) button** (p. 48)
Used to select the VIDEO, S-VIDEO, RGB1, RGB2, DVI-D and AUX (optional input module) input ports.
- ⑪ **AUTO SETUP button** (p. 49)
Pressing this button while projecting an image automatically corrects the picture positioning on the screen. While the auto setup feature is active, a message “PROGRESS...” appears on the screen.
- ⑫ **Self-diagnosis display** (pp. 118-119)
- ⑬ **LIGHT ON/OFF button**
This switch is used for illuminating the connection terminals and controls.
- ⑭ **SHUTTER button** (p. 48)
Pressing this button toggles the projector’s internal mechanical shutter to black out the projected image.

Note

- The AUX input select button is enabled only when an optional input module is installed.

■ Connection terminals

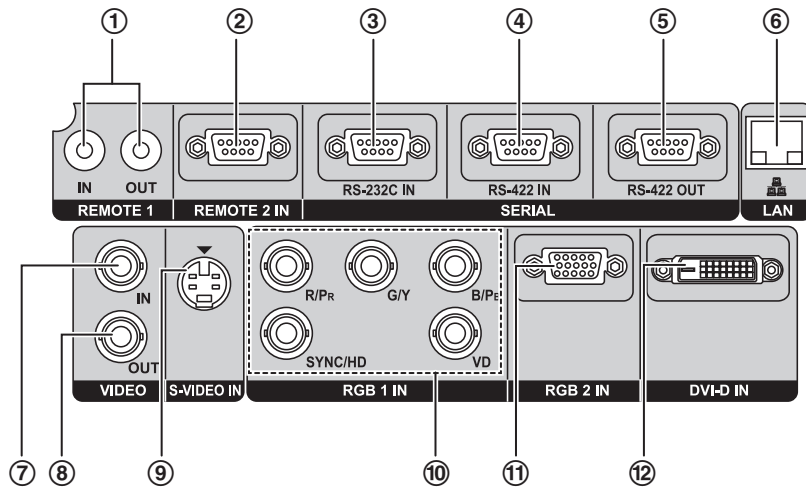

- ① **REMOTE1 IN/OUT terminal** (p. 18)
When two or more main units are used in the system, they can be connected and controlled with a wired remote control cable (M3 jack).
- ② **REMOTE2 IN terminal** (p. 110)
The user can remotely control the main unit by using an external control circuit to this terminal (D-SUB 9-pin female).
- ③ **SERIAL IN terminal** (pp. 28-29, 80, 106-109)
RS-232C compliant input terminal (switching necessary) to connect a PC and to externally control the main unit (D-SUB 9-pin female).
- ④ **SERIAL IN terminal** (pp. 28-29, 80, 106-109)
RS-422 compliant input terminal (switching necessary) to connect a PC and to externally control the main unit (D-SUB 9-pin female).
- ⑤ **SERIAL OUT terminal** (pp. 29, 106-109)
RS-422 compliant output terminal (switching necessary) to loop through signals from the Serial Input terminals (D-SUB 9-pin male).
- ⑥ **LAN terminal (10BASE-T/100BASE-TX)** (pp. 28-29, 93)
The projector can be connected to a network and controlled through its onboard web page.
- ⑦ **VIDEO IN terminal** (p. 28)
An input terminal for video signals. (BNC)
- ⑧ **VIDEO OUT terminal** (p. 28)
An output terminal (active through) for video signals. (BNC)
- ⑨ **S-VIDEO IN terminal** (p. 28)
An input terminal for S-video signals (Mini DIN 4-pin). This terminal complies with S1 signals and automatically toggles between 16:9 and 4:3 according to the size of input signals.
- ⑩ **RGB (YP_BP_R) 1 IN terminal** (pp. 28, 29)
A terminal to input RGB or YP_BP_R signals (3, 4 or 5-wire BNC).
- ⑪ **RGB2 IN terminal** (p. 29)
A terminal to input RGB or YP_BP_R signals (D-SUB 15-pin female).
- ⑫ **DVI-D IN terminal** (pp. 28, 29)
An input terminal for single-link DVI-D signals.

Using the remote control unit

Loading batteries

When loading supplied AA batteries into the battery compartment of the Remote Control, make sure that their polarities are correct.

1. Open battery compartment lid.

- Open the lid in the order ① and then ②.

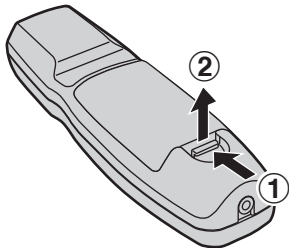

2. Insert the batteries.

- Into battery compartment, with their polarities orientated as indicated (\oplus , \ominus) in the compartment.

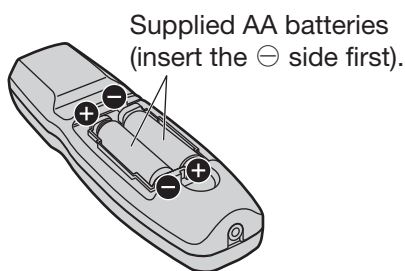

3. Close the battery compartment lid.

- Replace the battery compartment lid over the compartment and slide until it clicks.

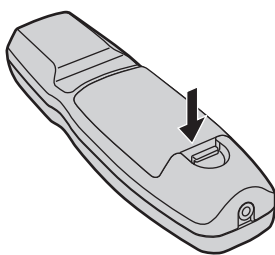

Attention

- Do not drop the Remote Control unit.
- Do not expose Remote Control unit to any liquid.
- Do not use NiCd batteries.
- Release the LOCK button before operating the remote control. (p. 13)

Effective range of remote control operation

The Remote Control should normally be aimed at either the front or rear remote control receiver window on the projector (figure 1).

The effective control range is approx. 30 metres from the beam receiver on the front or rear.

Otherwise, it may also be aimed at the screen, which will reflect commands back to the projector's front receiver window as illustrated in figure 2.

- When the Remote Control is aimed at the screen, the effective control range may be reduced due to the optical loss by screen reflection.

Figure 1

- Top View

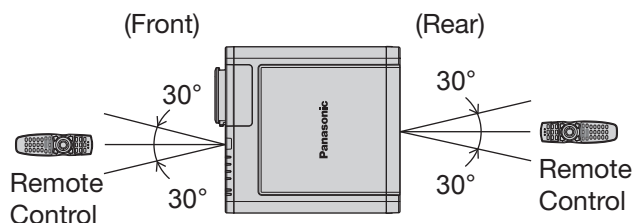

- Side View

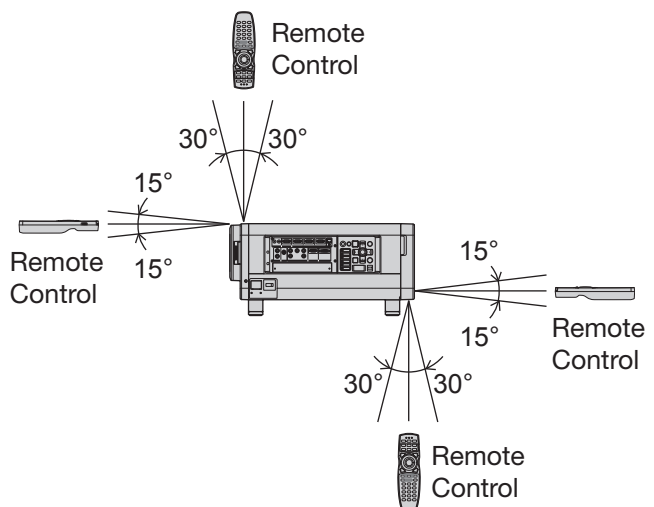
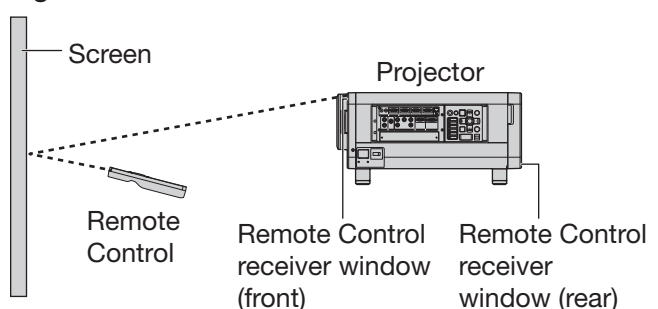

Figure 2



Using the remote control unit (continued)

Note

- The Remote Control may not function properly if line-of-site operation is blocked.
- The Remote Control receiver may not function properly in intense ambient light such as fluorescent lamps. Carefully site the projector so its Remote Control receiver windows will not be directly exposed to intense light.

Setting projector ID number to remote control

Each projector can be assigned a unique ID number, and the handheld remote's number must be set to match the intended projector. (p. 77) **The ID number of the projector is set to "ALL" on shipping, and use the ID ALL button of the remote control when using only a single projector.**

1. **Press ID SET, and the projector(s) will display it's current ID number onscreen. Within 5 seconds, use the numeric keys (0-9) to match the Remote's ID number with that of the desired projector.**

Attention

- Do not press the ID SET button accidentally or carelessly because the ID number on the Remote Control can be set even when no projector is around.
- If you do not enter the two-digit ID number within 5 seconds after the ID SET button has been pressed, the ID number will remain at the number that was set before the ID SET button was pressed.
- Your specified ID number is stored in the remote control unit unless another one is specified later. However, the stored ID will be erased if the batteries of the remote control are left exhausted. When the batteries are replaced, set the same ID number again.
- The ID number can be set to "ALL" or from "1" to "64".

Using a wired remote control

When multiple projectors are connected as part of the system, connect to units with a M3 stereo mini jack cable (sold separately) to simultaneously control multiple main units with a single remote control through the REMOTE1 IN/OUT terminal. It is effective to use the wired remote control in the environment in which an obstacle stands in the light path or where devices are susceptible to outside light.

Connect to the secondary projector

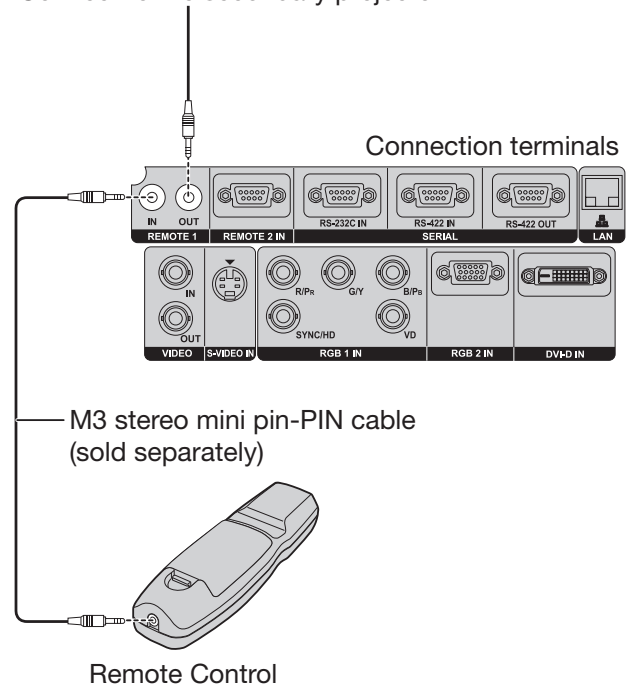

Attention

- Use a two-wire shielded cable with a length of 15 m or less. If the length of the cable exceeds 15 m, the shielding of the cable may not be sufficient and the remote control may not work.

Installation

Examples of system expansion

The projector is provided with a number of terminals and optional accessories to enable various system expansions.

The following are some examples of system expansion:

System 1

The optional high- or low-ceiling mount brackets enable flexible installation.

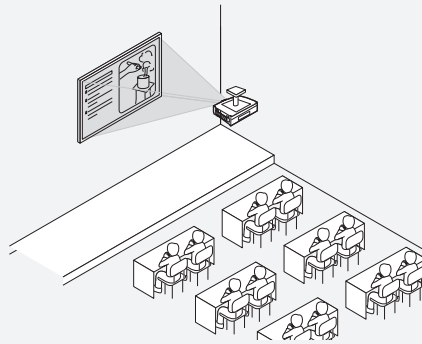
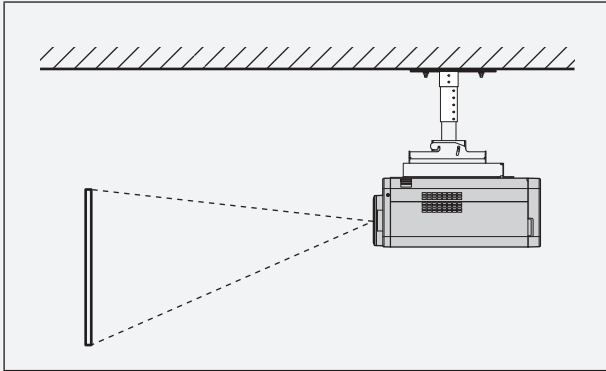

System 2

Connection to a computer via the DVI-D IN terminal or DVI-D input module (optional).

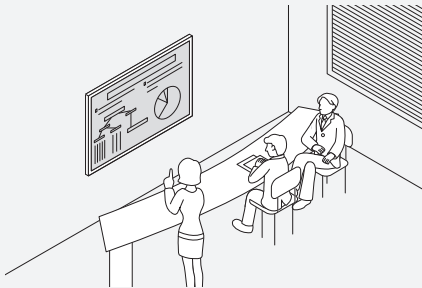
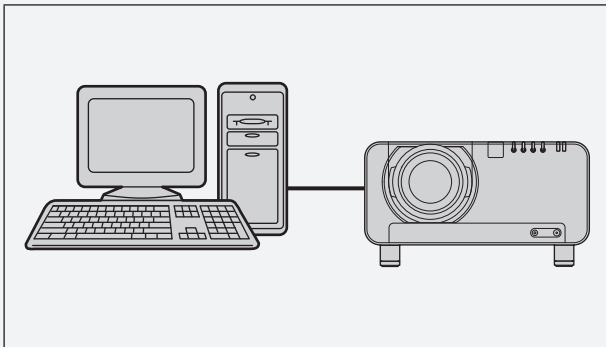

System 3

Built-in keystone and geometric correction can compensate for offset projector mounting and curved screens.

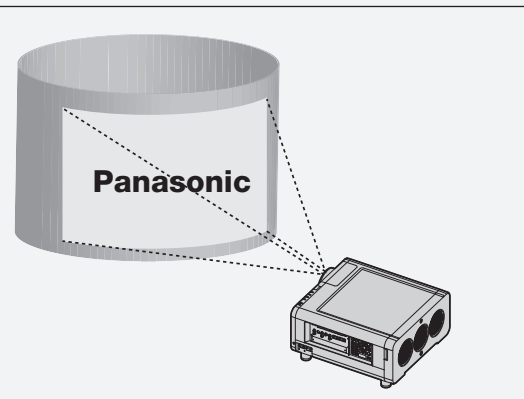
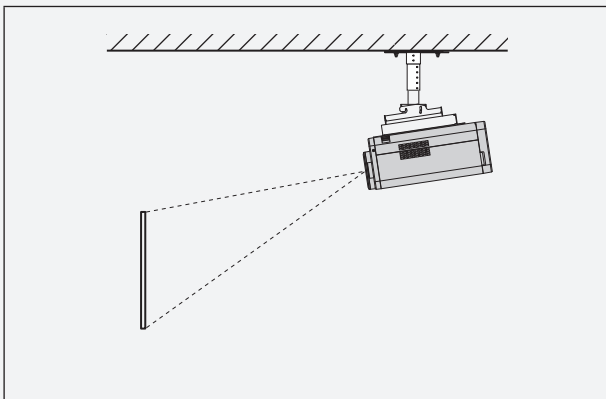

Installation (continued)

Adjusting the feet

The four adjustable feet (p. 14) mounted at the bottom of the projector are level-adjustable (0 mm–15 mm) which can be used when the mounting surface is uneven.



Projection scheme

All four combinations of Front, Rear, Ceiling or Floor mounting are available. Use the INSTALLATION menu to choose the desired projection scheme. (p. 78)

Installation geometry

When planning the projector and screen geometry, refer to the figures below and the information on the next page for reference. After the projector is roughly positioned, picture size and vertical picture positioning can be finely adjusted with the powered zoom lens and lens shifting mechanism.

● When attaching an optional ceiling mount bracket (ET-PKD100H)

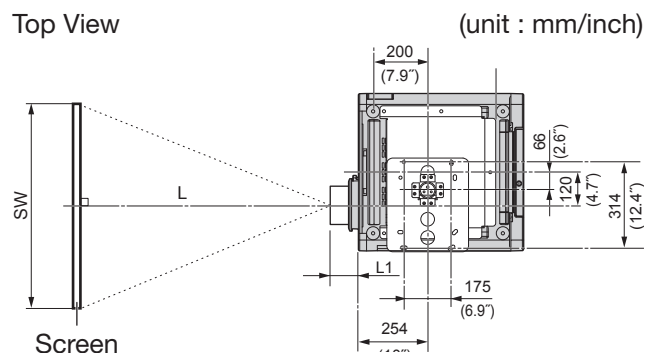
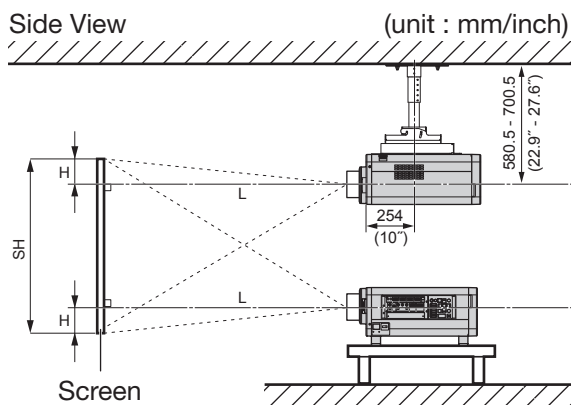

L	Projection distance
SH	Height of the image
SW	Image width
H	Vertical distance between the lens center level and the bottom edge of the projected image

- * For PT-D12000U: $H = 0$ to SH
- For PT-DZ12000U: $H = -0.1 \times SH$ to $1.1 \times SH$
- * However, if the ET-D75LE5 has been installed, the value will be fixed at $H = SH/2$ for both the PT-D12000U and PT-DZ12000U. If the ET-D75LE6 has been installed, the values will be $H = 0.1 \times SH$ to $0.9 \times SH$ for the PT-D12000U, and $H = 0$ to SH for the PT-DZ12000U.

Lens	Lens Protrusion L1 (Approx.)
ET-D75LE1	62.5 (2.5")
ET-D75LE2	47 (1.9")
ET-D75LE3	50.5 (2")
ET-D75LE4	74.4 (2.9")
ET-D75LE5	150.5 (5.9")
ET-D75LE6	160 (6.3")
ET-D75LE8	202.5 (8")

● Projected range using geometric adjustment

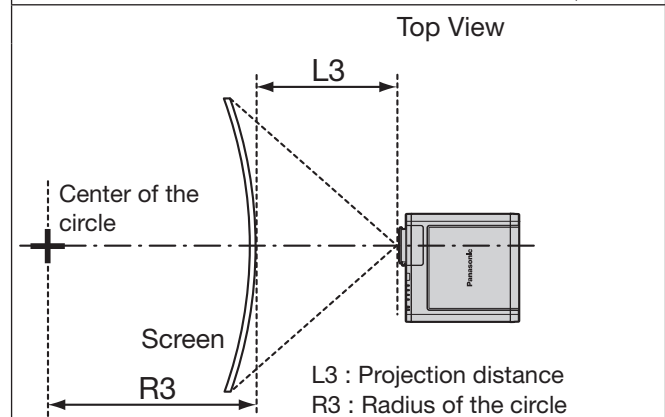
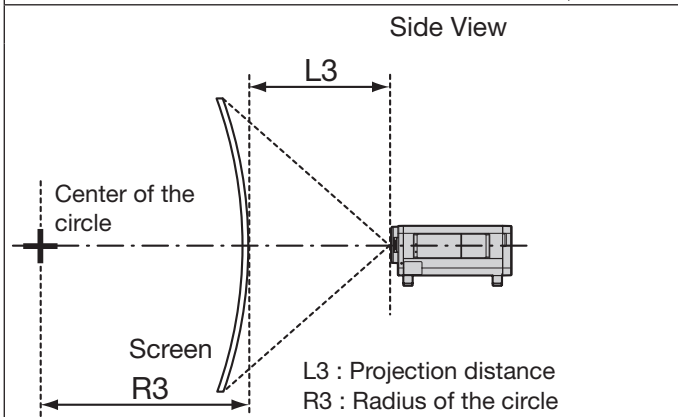
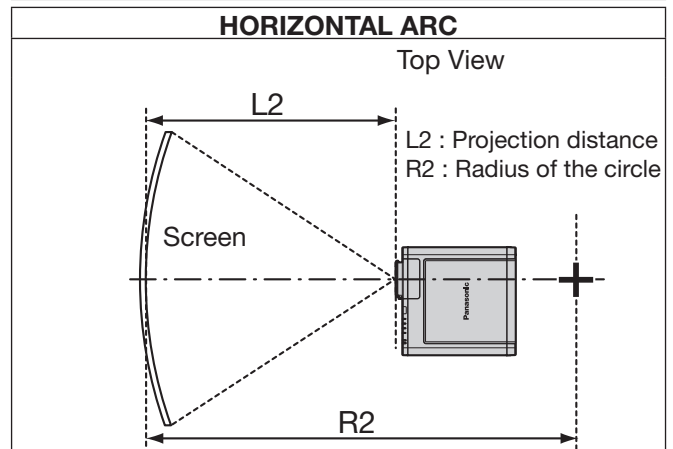
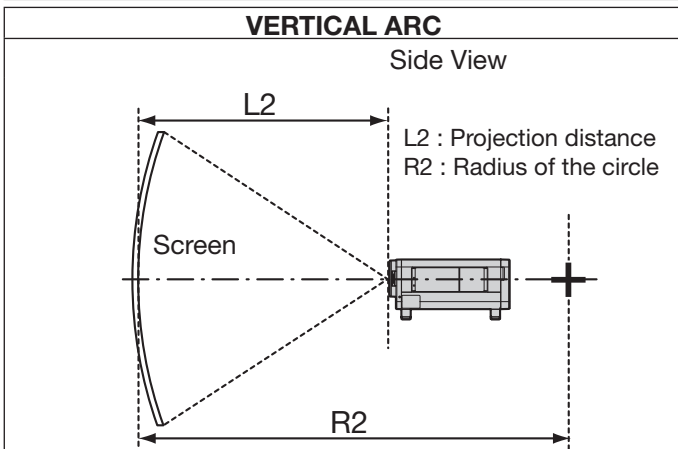
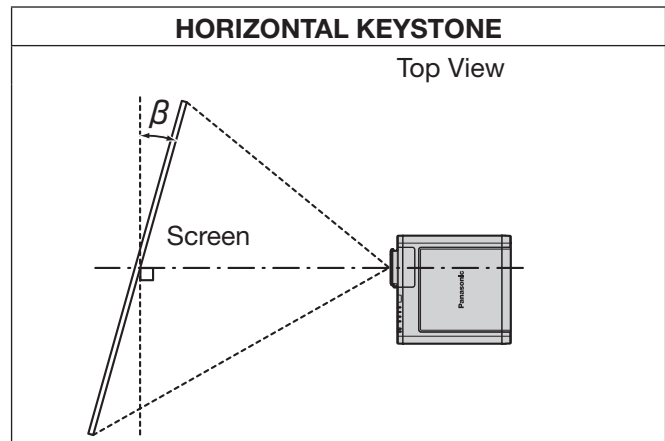
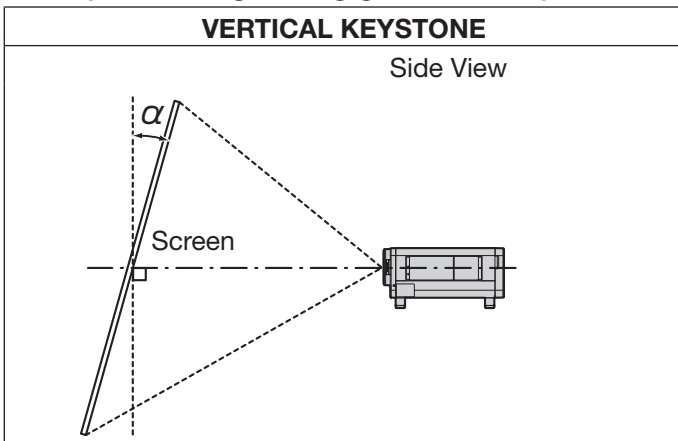

Lens	Keystone correction only		When using arc and keystone correction together				Arc correction only	
	Vertical Keystone Correction Angle $\alpha(^{\circ})$	Horizontal Keystone Correction Angle $\beta(^{\circ})$	Vertical Keystone Correction Angle $\alpha(^{\circ})$	Horizontal Keystone Correction Angle $\beta(^{\circ})$	R2/L2 minimum value	R3/L3 minimum value	R2/L2 minimum value	R3/L3 minimum value
ET-D75LE1	± 40	± 15	± 5	± 5	1.6	3.2	0.8	1.6
ET-D75LE2	± 40	± 15	± 5	± 5	1.2	2.4	0.6	1.2
ET-D75LE3	± 40	± 15	± 10	± 10	0.8	1.6	0.4	0.8
ET-D75LE4	± 40	± 15	± 10	± 15	0.6	1.0	0.3	0.5
ET-D75LE5	± 22	± 15	± 5	± 5	3.0	6.0	1.5	3.0
ET-D75LE6	± 28	± 10	± 5	± 5	2.4	4.8	1.2	2.4
ET-D75LE8	± 40	± 15	± 10	± 15	0.4	0.8	0.2	0.4

Note

- When using geometric adjustment, if the amount of compensation is too great, excessive blurring may result.
- The curved screens illustrated are simply sections of a full circle.

Installation (continued)

Projection distances by the type of projection lenses (optional)

The available lenses have been designed with different projector-distance to screen-width ratios ("throw ratios"). Select the appropriate lens model for your projection distance and screen size. Consult the following tables and Panasonic's online Lens Calculator.

Side View

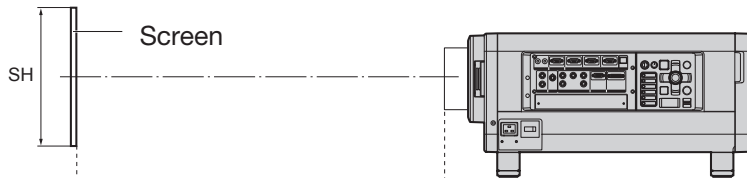

Top View

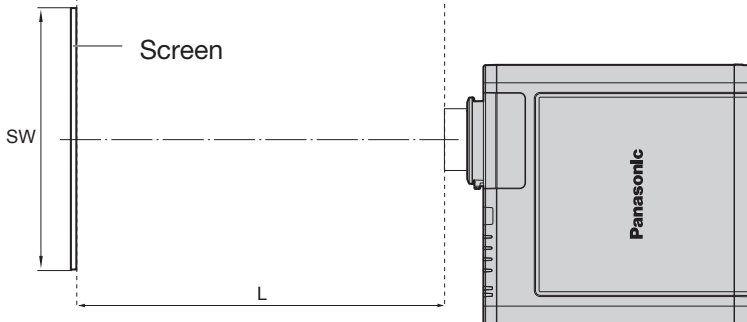

L : Projection distance
SH : Effective screen height
SW : Effective screen width

Note

- The projection distances listed here involve an error of $\pm 5\%$.
- When using geometric adjustment, alter the compensation so that the screen size becomes smaller than the specified size.

Projection distances by the type of projection lenses (for PT-DZ12000U)

For the screen aspect ratio of 16:10 (Units: m (feet/inches))

Lens type			Zoom lens											Fixed-focus lens	
Model number of projection lens			ET-D75LE1	ET-D75LE2	ET-D75LE3	ET-D75LE4	ET-D75LE8	ET-D75LE6							ET-D75LE5
Throw ratio ¹⁾			1.4-1.8 : 1	1.8-2.8 : 1	2.8-4.6 : 1	4.6-7.4 : 1	7.3-13.8 : 1	0.9-1.1 : 1							0.7 : 1
Screen dimensions			Projection distance (L)												
Screen size (inch)	Effective height (SH)	Effective width (SW)	Min.	Max.	Min.	Max.	Min.	Max.	Min.	Max.	Min.	Max.	Min.	Max.	Fixed
70	0.942 (3'1)	1.508 (4'11)	2.01 (6'7)	2.69 (8'9)	2.72 (8'11)	4.10 (13'5)	4.11 (13'5)	6.90 (22'7)	6.91 (22'8)	11.06 (35'3)	10.78 (35'4)	20.56 (67'5)	1.35 (4'5)	1.62 (5'3)	0.99 (3'2)
80	1.077 (3'6)	1.723 (5'7)	2.31 (7'6)	3.09 (10'1)	3.12 (10'2)	4.70 (15'5)	4.71 (15'5)	7.90 (25'11)	7.91 (25'11)	12.66 (41'6)	12.37 (40'7)	23.55 (77'3)	1.55 (5'1)	1.86 (6'1)	1.15 (3'9)
90	1.212 (3'11)	1.939 (6'4)	2.61 (8'6)	3.49 (11'5)	3.52 (11'6)	5.30 (17'4)	5.31 (17'5)	8.91 (29'2)	8.91 (29'2)	14.25 (46'9)	13.97 (45'10)	26.54 (87)	1.76 (5'9)	2.10 (6'10)	1.30 (4'3)
100	1.346 (4'4)	2.154 (7)	2.91 (9'6)	3.89 (12'9)	3.92 (12'10)	5.90 (19'4)	5.91 (19'4)	9.91 (32'6)	9.91 (32'6)	15.85 (52)	15.57 (51)	29.53 (96'10)	1.96 (6'5)	2.34 (7'8)	1.45 (4'9)
120	1.615 (5'3)	2.585 (8'5)	3.51 (11'6)	4.68 (15'4)	4.73 (15'6)	7.10 (23'3)	7.11 (23'3)	11.91 (39)	11.92 (39'1)	19.04 (62'5)	18.76 (61'6)	35.50 (116'5)	2.36 (7'8)	2.82 (9'3)	1.76 (5'9)
150	2.019 (6'7)	3.231 (10'7)	4.40 (14'5)	5.88 (19'3)	5.93 (19'5)	8.90 (29'2)	8.91 (29'2)	14.92 (48'11)	14.93 (48'11)	23.82 (78'1)	23.54 (77'2)	44.47 (145'10)	2.96 (9'8)	3.55 (11'7)	2.22 (7'3)
200	2.692 (8'9)	4.308 (14'1)	5.89 (19'3)	7.87 (25'9)	7.93 (26)	11.91 (39)	11.92 (39'1)	19.94 (65'5)	19.95 (65'5)	31.80 (104'3)	31.52 (103'4)	59.41 (194'10)	3.97 (13)	4.75 (15'7)	2.99 (9'9)
250	3.365 (11)	5.385 (17'8)	7.39 (24'2)	9.87 (32'4)	9.93 (32'6)	14.91 (48'11)	14.92 (48'11)	24.95 (81'10)	24.96 (81'10)	39.77 (130'5)	39.49 (129'6)	74.36 (243'11)	4.98 (16'4)	5.96 (19'6)	3.76 (12'4)
300	4.039 (13'3)	6.462 (21'2)	8.88 (29'1)	11.86 (38'10)	11.93 (39'1)	17.91 (58'9)	17.92 (58'9)	29.97 (98'3)	29.98 (98'4)	47.75 (156'7)	47.47 (155'8)	89.30 (292'11)	5.99 (19'7)	7.17 (23'6)	4.53 (14'10)
350	4.712 (15'5)	7.539 (24'8)	10.37 (34)	13.86 (45'5)	13.93 (45'8)	20.91 (68'7)	20.92 (68'7)	34.98 (114'9)	34.99 (114'9)	55.72 (182'9)	55.44 (181'10)	104.24 (341'11)	6.99 (22'11)	8.37 (27'5)	
400	5.385 (17'8)	8.616 (28'3)	11.86 (38'10)	15.85 (52)	15.94 (52'3)	23.92 (78'5)	23.93 (78'5)	40.00 (131'2)	40.01 (131'3)	63.70 (208'11)	63.42 (208)	119.19 (391)	8.00 (26'2)	9.58 (31'5)	
500	6.731 (22'1)	10.770 (35'4)	14.85 (48'8)	19.84 (65'1)	19.94 (65'5)	29.92 (98'1)	29.93 (98'2)	50.03 (164'1)	50.04 (164'2)	79.65 (261'3)	79.37 (260'4)	149.08 (489'1)	10.01 (32'10)	11.99 (39'4)	
600	8.077 (26'5)	12.923 (42'4)	17.83 (58'5)	23.82 (78'1)	23.94 (78'6)	35.93 (117'10)	35.94 (117'10)	60.06 (197)	60.07 (197)	95.60 (313'7)	95.32 (312'8)	178.96 (587'1)	12.03 (39'5)	14.40 (47'2)	

● For the screen aspect ratio of 16:9 (Units: m (feet/inches))

Lens type			Zoom lens												Fixed-focus lens
Model number of projection lens			ET-D75LE1	ET-D75LE2	ET-D75LE3	ET-D75LE4	ET-D75LE8	ET-D75LE6	ET-D75LE5						
Throw ratio ^{*1}			1.4-1.8 : 1	1.8-2.8 : 1	2.8-4.6 : 1	4.6-7.4 : 1	7.3-13.8 : 1	0.9-1.1 : 1	0.7 : 1						
Screen dimensions			Projection distance (L)												Fixed
Screen size (inch)	Effective height (SH)	Effective width (SW)	Min.	Max.	Min.	Max.	Min.	Max.	Min.	Max.	Min.	Max.	Min.	Max.	Fixed
70	0.872 (2'10")	1.550 (5'1")	2.07 (6'9")	2.77 (9'1")	2.80 (9'2")	4.21 (13'9")	4.23 (13'10")	7.09 (23'3")	7.10 (23'3")	11.37 (37'3")	11.09 (36'4")	21.14 (69'4")	1.39 (4'6")	1.66 (5'5")	1.02 (3'4")
80	0.996 (3'3")	1.771 (5'9")	2.38 (7'9")	3.18 (10'5")	3.21 (10'6")	4.83 (15'10")	4.84 (15'10")	8.13 (26'8")	8.13 (26'8")	13.01 (42'8")	12.73 (41'9")	24.21 (79'5")	1.60 (5'2")	1.91 (6'3")	1.18 (3'10")
90	1.121 (3'8")	1.992 (6'6")	2.68 (8'9")	3.59 (11'9")	3.62 (11'10")	5.45 (17'10")	5.46 (17'10")	9.16 (30)	9.16 (30)	14.65 (48)	14.37 (47'1")	27.29 (89'6")	1.81 (5'11")	2.16 (7'1")	1.34 (4'4")
100	1.245 (4'1")	2.214 (7'3")	2.99 (9'9")	4.00 (13'1")	4.04 (13'3")	6.07 (19'10")	6.08 (19'11")	10.19 (33'5")	10.19 (33'5")	16.29 (53'5")	16.01 (52'6")	30.36 (99'7")	2.01 (6'7")	2.41 (7'10")	1.50 (4'11")
120	1.494 (4'10")	2.657 (8'8")	3.60 (11'9")	4.82 (15'9")	4.86 (15'11")	7.30 (23'11")	7.31 (23'11")	12.25 (40'2")	12.26 (40'2")	19.57 (64'2")	19.29 (63'3")	36.50 (119'9")	2.43 (7'11")	2.90 (9'6")	1.81 (5'11")
150	1.868 (6'1")	3.321 (10'10")	4.53 (14'10")	6.05 (19'10")	6.09 (19'11")	9.15 (30)	9.16 (30)	15.34 (50'3")	15.35 (50'4")	24.49 (80'4")	24.21 (79'5")	45.72 (150)	3.05 (10)	3.65 (11'11")	2.29 (7'6")
200	2.491 (8'2")	4.428 (14'6")	6.06 (19'10")	8.10 (26'6")	8.15 (26'8")	12.24 (40'1")	12.25 (40'2")	20.50 (67'3")	20.50 (67'3")	32.69 (107'3")	32.40 (106'3")	61.08 (200'4")	4.08 (13'4")	4.89 (16)	3.08 (10'1")
250	3.113 (10'2")	5.535 (18'1")	7.59 (24'10")	10.15 (33'3")	10.21 (33'5")	15.33 (50'3")	15.34 (50'3")	25.65 (84'1")	25.66 (84'2")	40.88 (134'1")	40.60 (133'2")	76.44 (250'9")	5.12 (16'9")	6.13 (20'1")	3.87 (12'8")
300	3.736 (12'3")	6.641 (21'9")	9.13 (29'11")	12.19 (39'11")	12.27 (40'3")	18.41 (60'4")	18.42 (60'5")	30.81 (101)	30.81 (101)	49.08 (161)	48.80 (160'1")	91.79 (301'1")	6.15 (20'2")	7.37 (24'2")	4.66 (15'3")
350	4.358 (14'3")	7.748 (25'5")	10.66 (34'11")	14.24 (46'8")	14.32 (46'11")	21.50 (70'6")	21.51 (70'6")	35.96 (117'11")	35.97 (118")	57.28 (187'11")	57.00 (187)	107.15 (351'6")	7.19 (23'7")	8.61 (28'2")	
400	4.981 (16'4")	8.855 (29)	12.19 (39'11")	16.29 (53'5")	16.38 (53'8")	24.58 (80'7")	24.60 (80'8")	41.12 (134'10")	41.12 (134'10")	65.47 (214'9")	65.19 (213'10")	122.51 (401'11")	8.22 (26'11")	9.85 (32'3")	
500	6.226 (20'5")	11.069 (36'3")	15.26 (50)	20.39 (66'10")	20.50 (67'3")	30.76 (100'11")	30.77 (100'11")	51.42 (168'8")	51.43 (168'8")	81.87 (268'7")	81.59 (267'8")	153.23 (502'8")	10.29 (33'9")	12.33 (40'5")	
600	7.472 (24'6")	13.283 (43'6")	18.33 (60'1")	24.49 (80'4")	24.61 (80'8")	36.93 (121'1")	36.94 (121'2")	61.73 (202'6")	61.74 (202'6")	98.26 (322'4")	97.98 (321'5")	183.95 (603'6")	12.36 (40'6")	14.81 (48'7")	

● For the screen aspect ratio of 4:3 (Units: m (feet/inches))

Lens type			Zoom lens												Fixed-focus lens
Model number of projection lens			ET-D75LE1	ET-D75LE2	ET-D75LE3	ET-D75LE4	ET-D75LE8	ET-D75LE6	ET-D75LE5						
Throw ratio ^{*1}			1.6-2.2 : 1	2.2-3.3 : 1	3.3-5.6 : 1	5.6-8.9 : 1	8.8-16.5 : 1	1.1-1.3 : 1	0.8 : 1						
Screen dimensions			Projection distance (L)												Fixed
Screen size (inch)	Effective height (SH)	Effective width (SW)	Min.	Max.	Min.	Max.	Min.	Max.	Min.	Max.	Min.	Max.	Min.	Max.	Fixed
70	1.067 (3'6")	1.422 (4'7")	2.29 (7'6")	3.06 (10)	3.09 (10'1")	4.65 (15'3")	4.66 (15'3")	7.83 (25'8")	7.83 (25'8")	12.54 (41'1")	12.25 (40'2")	23.32 (76'6")	1.54 (5)	1.84 (6)	1.13 (3'8")
80	1.219 (3'11")	1.626 (5'4")	2.63 (8'7")	3.51 (11'6")	3.55 (11'7")	5.33 (17'5")	5.34 (17'6")	8.96 (29'4")	8.97 (29'5")	14.34 (47)	14.06 (46'1")	26.71 (87'7")	1.77 (5'9")	2.11 (6'11")	1.31 (4'3")
90	1.372 (4'6")	1.829 (6)	2.96 (9'8")	3.96 (12'11")	4.00 (13'1")	6.01 (19'8")	6.02 (19'9")	10.10 (33'1")	10.10 (33'1")	16.15 (52'11")	15.87 (52)	30.09 (98'8")	2.00 (6'6")	2.38 (7'9")	1.48 (4'10")
100	1.524 (5)	2.032 (6'8")	3.30 (10'9")	4.41 (14'5")	4.45 (14'7")	6.69 (21'11")	6.70 (21'11")	11.23 (36'10")	11.24 (36'10")	17.96 (58'11")	17.67 (57'11")	33.47 (109'9")	2.22 (7'3")	2.66 (8'8")	1.66 (5'5")
120	1.829 (6)	2.438 (7'11")	3.98 (13)	5.32 (17'5")	5.36 (17'7")	8.05 (26'4")	8.06 (26'5")	13.50 (44'3")	13.51 (44'3")	21.57 (70'9")	21.28 (69'9")	40.24 (132)	2.68 (8'9")	3.20 (10'5")	2.00 (6'6")
150	2.286 (7'6")	3.048 (10)	4.99 (16'4")	6.67 (21'10")	6.72 (22)	10.09 (33'1")	10.10 (33'1")	16.91 (55'5")	16.92 (55'6")	26.98 (88'6")	26.70 (87'7")	50.39 (165'3")	3.36 (11)	4.02 (13'2")	2.53 (8'3")
200	3.048 (10)	4.064 (13'4")	6.68 (21'10")	8.93 (29'3")	8.99 (29'5")	13.49 (44'3")	13.50 (44'3")	22.59 (74'1")	22.59 (74'1")	36.01 (118'1")	35.73 (117'2")	67.31 (220'10")	4.50 (14'9")	5.39 (17'8")	3.40 (11'1")
250	3.810 (12'6")	5.080 (16'8")	8.37 (27'5")	11.18 (36'8")	11.25 (36'10")	16.89 (55'4")	16.90 (55'5")	28.27 (92'8")	28.27 (92'8")	45.04 (147'9")	44.76 (146'10")	84.23 (276'4")	5.64 (18'6")	6.76 (22'2")	4.27 (14)
300	4.572 (15)	6.096 (20)	10.06 (33)	13.44 (44'1")	13.52 (44'4")	20.29 (66'6")	20.30 (66'7")	33.94 (111'4")	33.95 (111'4")	54.07 (177'4")	53.79 (176'5")	101.14 (331'9")	6.78 (22'2")	8.12 (26'7")	5.14 (16'10")
350	5.334 (17'6")	7.112 (23'4")	11.75 (38'6")	15.70 (51'6")	15.79 (51'9")	23.69 (77'8")	23.70 (77'9")	39.62 (129'11")	39.63 (130)	63.10 (207)	62.82 (206'1")	118.06 (387'4")	7.92 (25'11")	9.49 (31'1")	
400	6.096 (20)	8.128 (26'8")	13.44 (44'1")	17.96 (58'11")	18.05 (59'2")	27.09 (88'10")	27.10 (88'10")	45.30 (148'7")	45.31 (148'7")	72.13 (236'7")	71.85 (235'8")	134.98 (442'10")	9.06 (29'8")	10.85 (35'7")	
500	7.620 (25)	10.160 (33'4")	16.82 (55'2")	22.47 (73'8")	22.58 (74)	33.89 (111'2")	33.90 (111'2")	56.65 (185'10")	56.66 (185'10")	90.18 (295'10")	89.91 (294'11")	168.81 (553'10")	11.34 (37'2")	13.58 (44'6")	
600	9.144 (30)	12.192 (40)	20.20 (66'3")	26.98 (88'6")	27.12 (88'11")	40.69 (133'5")	40.70 (133'6")	68.01 (223'1")	68.02 (223'1")	108.24 (355'1")	107.96 (354'2")	202.65 (664'10")	13.62 (44'8")	16.32 (53'6")	

*1: "Throw ratio" is the approximate measurement range of the screen width to the projection distance.

Installation (continued)

■ Projection distances by the type of projection lenses (for PT-D12000U) ● For the screen aspect ratio of 4:3 (Units: m (feet/inches))

Lens type			Zoom lens												Fixed-focus lens
Model number of projection lens			ET-D75LE1	ET-D75LE2	ET-D75LE3	ET-D75LE4	ET-D75LE8	ET-D75LE6	ET-D75LE5						
Throw ratio ^{*1}			1.5-2.0 : 1	2.0-3.0 : 1	3.0-5.0 : 1	5.0-8.0 : 1	7.9-15.0 : 1	1.0-1.2 : 1	0.8 : 1						
Screen dimensions			Projection distance (L)												Fixed
Screen size (inch)	Effective height (SH)	Effective width (SW)	Min.	Max.	Min.	Max.	Min.	Max.	Min.	Max.	Min.	Max.	Min.	Max.	Fixed
70	1.067 (3'6")	1.422 (4'7")	2.07 (6'9")	2.77 (9'1")	2.80 (9'2")	4.21 (13'9")	4.23 (13'10")	7.09 (23'3")	7.10 (23'3")	11.37 (37'3")	11.09 (36'4")	21.14 (69'4")	1.39 (4'6")	1.66 (5'5")	1.02 (3'4")
80	1.219 (3'11")	1.626 (5'4")	2.38 (7'9")	3.18 (10'5")	3.21 (10'6")	4.83 (15'10")	4.84 (15'10")	8.13 (26'8")	8.13 (26'8")	13.01 (42'8")	12.73 (41'9")	24.21 (79'5")	1.60 (5'2")	1.91 (6'3")	1.18 (3'10")
90	1.372 (4'6")	1.829 (6'0")	2.68 (8'9")	3.59 (11'9")	3.62 (11'10")	5.45 (17'10")	5.46 (17'10")	9.16 (30")	9.16 (30")	14.65 (48")	14.37 (47'1")	27.29 (89'6")	1.81 (5'11")	2.16 (7'1")	1.34 (4'4")
100	1.524 (5")	2.032 (6'8")	2.99 (9'9")	4.00 (13'1")	4.04 (13'3")	6.07 (19'10")	6.08 (19'11")	10.19 (33'5")	10.19 (33'5")	16.29 (53'5")	16.01 (52'6")	30.36 (99'7")	2.01 (6'7")	2.41 (7'10")	1.50 (4'11")
120	1.829 (6'0")	2.438 (7'11")	3.60 (11'9")	4.82 (15'9")	4.86 (15'11")	7.30 (23'11")	7.31 (23'11")	12.25 (40'2")	12.26 (40'2")	19.57 (64'2")	19.29 (63'3")	36.50 (119'9")	2.43 (7'11")	2.90 (9'6")	1.81 (5'11")
150	2.286 (7'6")	3.048 (10")	4.53 (14'10")	6.05 (19'10")	6.09 (19'11")	9.15 (30")	9.16 (30")	15.34 (50'3")	15.35 (50'4")	24.49 (80'4")	24.21 (79'5")	45.72 (150")	3.05 (10")	3.65 (11'11")	2.29 (7'6")
200	3.048 (10")	4.064 (13'4")	6.06 (19'10")	8.10 (26'6")	8.15 (26'8")	12.24 (40'1")	12.25 (40'2")	20.50 (67'3")	20.50 (67'3")	32.69 (107'3")	32.40 (106'3")	61.08 (200'4")	4.08 (13'4")	4.89 (16")	3.08 (10'1")
250	3.810 (12'6")	5.080 (16'8")	7.59 (24'10")	10.15 (33'3")	10.21 (33'5")	15.33 (50'3")	15.34 (50'3")	25.65 (84'1")	25.66 (84'2")	40.88 (134'1")	40.60 (133'2")	76.44 (250'9")	5.12 (16'9")	6.13 (20'1")	3.87 (12'8")
300	4.572 (15")	6.096 (20")	9.13 (29'11")	12.19 (39'11")	12.27 (40'3")	18.41 (60'4")	18.42 (60'5")	30.81 (101")	30.81 (101")	49.08 (161")	48.80 (160'1")	91.79 (301'1")	6.15 (20'2")	7.37 (24'2")	4.66 (15'3")
350	5.334 (17'6")	7.112 (23'4")	10.66 (34'11")	14.24 (46'8")	14.32 (46'11")	21.50 (70'6")	21.51 (70'6")	35.96 (117'11")	35.97 (117'11")	57.28 (187'11")	57.00 (187")	107.15 (351'6")	7.19 (23'7")	8.61 (28'2")	
400	6.096 (20")	8.128 (26'8")	12.19 (39'11")	16.29 (53'5")	16.38 (53'8")	24.58 (80'7")	24.60 (80'8")	41.12 (134'10")	41.12 (134'10")	65.47 (214'9")	65.19 (213'10")	122.51 (401'11")	8.22 (26'11")	9.85 (32'3")	
500	7.620 (25")	10.160 (33'4")	15.26 (50")	20.39 (66'10")	20.50 (67'3")	30.76 (100'11")	30.77 (100'11")	51.42 (168'8")	51.43 (168'8")	81.87 (268'7")	81.59 (267'8")	153.23 (502'8")	10.29 (33'9")	12.33 (40'5")	
600	9.144 (30")	12.192 (40")	18.33 (60'1")	24.49 (80'4")	24.61 (80'8")	36.93 (121'1")	36.94 (121'2")	61.73 (202'6")	61.74 (202'6")	98.26 (322'4")	97.98 (321'5")	183.95 (603'6")	12.36 (40'6")	14.81 (48'7")	

● For the screen aspect ratio of 16:9 (Units: m (feet/inches))

Lens type			Zoom lens												Fixed-focus lens
Model number of projection lens			ET-D75LE1	ET-D75LE2	ET-D75LE3	ET-D75LE4	ET-D75LE8	ET-D75LE6	ET-D75LE5						
Throw ratio ^{*1}			1.5-2.0 : 1	2.0-3.0 : 1	3.0-5.0 : 1	5.0-8.0 : 1	8.0-15.0 : 1	1.0-1.2 : 1	0.8 : 1						
Screen dimensions			Projection distance (L)												Fixed
Screen size (inch)	Effective height (SH)	Effective width (SW)	Min.	Max.	Min.	Max.	Min.	Max.	Min.	Max.	Min.	Max.	Min.	Max.	Fixed
70	0.872 (2'10")	1.550 (5'1")	2.26 (7'4")	3.02 (9'10")	3.06 (10")	4.60 (15'1")	4.61 (15'1")	7.74 (25'4")	7.75 (25'5")	12.40 (40'8")	12.12 (39'9")	23.06 (75'7")	1.52 (4'11")	1.82 (5'11")	1.12 (3'8")
80	0.996 (3'3")	1.771 (5'9")	2.60 (8'6")	3.47 (11'4")	3.51 (11'6")	5.27 (17'3")	5.28 (17'3")	8.86 (29")	8.87 (29'1")	14.18 (46'6")	13.90 (45'7")	26.41 (86'7")	1.75 (5'8")	2.09 (6'10")	1.29 (4'2")
90	1.121 (3'8")	1.992 (6'6")	2.93 (9'7")	3.92 (12'10")	3.95 (12'11")	5.95 (19'6")	5.96 (19'6")	9.99 (32'9")	9.99 (32'9")	15.97 (52'4")	15.69 (51'5")	29.76 (97'7")	1.97 (6'5")	2.36 (7'8")	1.47 (4'9")
100	1.245 (4'1")	2.214 (7'3")	3.27 (10'8")	4.36 (14'3")	4.40 (14'5")	6.62 (21'8")	6.63 (21'9")	11.11 (36'5")	11.11 (36'5")	17.76 (58'3")	17.47 (57'3")	33.10 (108'7")	2.20 (7'2")	2.63 (8'7")	1.64 (5'4")
120	1.494 (4'10")	2.657 (8'8")	3.93 (12'10")	5.26 (17'3")	5.30 (17'4")	7.96 (26'1")	7.97 (26'1")	13.35 (43'9")	13.36 (43'9")	21.33 (69'11")	21.04 (69")	39.79 (130'6")	2.65 (8'8")	3.17 (10'4")	1.98 (6'5")
150	1.868 (6'1")	3.321 (10'10")	4.94 (16'2")	6.60 (21'7")	6.64 (21'9")	9.98 (32'8")	9.99 (32'9")	16.72 (54'10")	16.73 (54'10")	26.68 (87'6")	26.40 (86'7")	49.83 (163'5")	3.33 (10'11")	3.98 (13")	2.50 (8'2")
200	2.491 (8'2")	4.428 (14'6")	6.61 (21'8")	8.83 (28'11")	8.89 (29'2")	13.34 (43'9")	13.35 (43'9")	22.34 (73'3")	22.34 (73'3")	35.61 (116'9")	35.33 (115'10")	66.56 (218'4")	4.45 (14'7")	5.33 (17'5")	3.36 (11")
250	3.113 (10'2")	5.535 (18'1")	8.28 (27'1")	11.06 (36'3")	11.13 (36'6")	16.70 (54'9")	16.71 (54'9")	27.95 (91'8")	27.96 (91'8")	44.54 (146'1")	44.26 (145'2")	83.29 (273'3")	5.58 (18'3")	6.68 (21'10")	4.22 (13'10")
300	3.736 (12'3")	6.641 (21'9")	9.95 (32'7")	13.29 (43'7")	13.37 (43'10")	20.07 (65'10")	20.08 (65'10")	33.57 (110'1")	33.57 (110'1")	53.47 (175'5")	53.19 (174'6")	100.02 (328'1")	6.71 (22")	8.03 (26'4")	5.08 (16'8")
350	4.358 (14'3")	7.748 (25'5")	11.62 (38'1")	15.52 (50'11")	15.61 (51'2")	23.43 (76'10")	23.44 (76'10")	39.18 (128'6")	39.19 (128'6")	62.40 (204'8")	62.12 (203'9")	116.75 (383")	7.84 (25'8")	9.38 (30'9")	
400	4.981 (16'4")	8.855 (29")	13.29 (43'7")	17.76 (58'3")	17.85 (58'6")	26.79 (87'10")	26.80 (87'11")	44.80 (146'11")	44.80 (146'11")	71.33 (234")	71.05 (233'1")	133.48 (437'11")	8.96 (29'4")	10.73 (35'2")	
500	6.226 (20'5")	11.069 (36'3")	16.63 (54'6")	22.22 (72'10")	22.33 (73'3")	33.51 (109'11")	33.52 (109'11")	56.03 (183'9")	56.03 (183'9")	89.19 (292'7")	88.91 (291'8")	166.95 (547'8")	11.22 (36'9")	13.43 (44")	
600	7.472 (24'6")	13.283 (43'6")	19.97 (65'6")	26.69 (87'6")	26.82 (87'11")	40.24 (132")	40.25 (132")	67.26 (220'8")	67.26 (220'8")	107.04 (351'2")	106.77 (350'3")	200.41 (657'6")	13.47 (44'2")	16.14 (52'11")	

*1: "Throw ratio" is the approximate measurement range of the screen width to the projection distance.

If the projector is used with a screen size not listed in this manual, check the diagonal dimension (inch) of your screen and calculate the projection distance using the following formulas.

■ Calculation formulas for projection distance by lens types (for PT-DZ12000U)

Model number of projection lens		Throw ratio	Aspect ratio	Projection distance (L) formula (Units: m)
Zoom lens	ET-D75LE1	1.4-1.8 : 1	16:10	Minimal distance : $L = 0.0298 \times \text{Screen diagonal (inch)} - 0.0760$ Maximal distance: $L = 0.0399 \times \text{Screen diagonal (inch)} - 0.1004$
		1.4-1.8 : 1	16:9	Minimal distance : $L = 0.0307 \times \text{Screen diagonal (inch)} - 0.0760$ Maximal distance: $L = 0.0410 \times \text{Screen diagonal (inch)} - 0.1004$
		1.6-2.2 : 1	4:3	Minimal distance : $L = 0.0338 \times \text{Screen diagonal (inch)} - 0.0760$ Maximal distance: $L = 0.0451 \times \text{Screen diagonal (inch)} - 0.1004$
	ET-D75LE2	1.8-2.8 : 1	16:10	Minimal distance : $L = 0.0400 \times \text{Screen diagonal (inch)} - 0.0795$ Maximal distance: $L = 0.0601 \times \text{Screen diagonal (inch)} - 0.1064$
		1.8-2.8 : 1	16:9	Minimal distance : $L = 0.0412 \times \text{Screen diagonal (inch)} - 0.0795$ Maximal distance: $L = 0.0617 \times \text{Screen diagonal (inch)} - 0.1064$
		2.2-3.3 : 1	4:3	Minimal distance : $L = 0.0453 \times \text{Screen diagonal (inch)} - 0.0795$ Maximal distance: $L = 0.0680 \times \text{Screen diagonal (inch)} - 0.1064$
	ET-D75LE3	2.8-4.6 : 1	16:10	Minimal distance : $L = 0.0601 \times \text{Screen diagonal (inch)} - 0.0958$ Maximal distance: $L = 0.1003 \times \text{Screen diagonal (inch)} - 0.1216$
		2.8-4.6 : 1	16:9	Minimal distance : $L = 0.0617 \times \text{Screen diagonal (inch)} - 0.0958$ Maximal distance: $L = 0.1031 \times \text{Screen diagonal (inch)} - 0.1216$
		3.3-5.6 : 1	4:3	Minimal distance : $L = 0.0680 \times \text{Screen diagonal (inch)} - 0.0958$ Maximal distance: $L = 0.1136 \times \text{Screen diagonal (inch)} - 0.1216$
	ET-D75LE4	4.6-7.4 : 1	16:10	Minimal distance : $L = 0.1003 \times \text{Screen diagonal (inch)} - 0.1158$ Maximal distance: $L = 0.1595 \times \text{Screen diagonal (inch)} - 0.1013$
		4.6-7.4 : 1	16:9	Minimal distance : $L = 0.1031 \times \text{Screen diagonal (inch)} - 0.1158$ Maximal distance: $L = 0.1639 \times \text{Screen diagonal (inch)} - 0.1013$
		5.6-8.9 : 1	4:3	Minimal distance : $L = 0.1136 \times \text{Screen diagonal (inch)} - 0.1158$ Maximal distance: $L = 0.1806 \times \text{Screen diagonal (inch)} - 0.1013$
	ET-D75LE8	7.3-13.8 : 1	16:10	Minimal distance : $L = 0.1595 \times \text{Screen diagonal (inch)} - 0.3862$ Maximal distance: $L = 0.2989 \times \text{Screen diagonal (inch)} - 0.3598$
		7.3-13.8 : 1	16:9	Minimal distance : $L = 0.1640 \times \text{Screen diagonal (inch)} - 0.3862$ Maximal distance: $L = 0.3072 \times \text{Screen diagonal (inch)} - 0.3598$
		8.8-16.5 : 1	4:3	Minimal distance : $L = 0.1806 \times \text{Screen diagonal (inch)} - 0.3862$ Maximal distance: $L = 0.3383 \times \text{Screen diagonal (inch)} - 0.3598$
	ET-D75LE6	0.9-1.1 : 1	16:10	Minimal distance : $L = 0.0201 \times \text{Screen diagonal (inch)} - 0.0566$ Maximal distance: $L = 0.0241 \times \text{Screen diagonal (inch)} - 0.0736$
		0.9-1.1 : 1	16:9	Minimal distance : $L = 0.0207 \times \text{Screen diagonal (inch)} - 0.0566$ Maximal distance: $L = 0.0248 \times \text{Screen diagonal (inch)} - 0.0736$
		1.1-1.3 : 1	4:3	Minimal distance : $L = 0.0228 \times \text{Screen diagonal (inch)} - 0.0566$ Maximal distance: $L = 0.0273 \times \text{Screen diagonal (inch)} - 0.0736$
Fixed-focus lens	ET-D75LE5	0.7 : 1	16:10	$L = 0.0154 \times \text{Screen diagonal (inch)} - 0.0835$
		0.7 : 1	16:9	$L = 0.0158 \times \text{Screen diagonal (inch)} - 0.0835$
		0.8 : 1	4:3	$L = 0.0174 \times \text{Screen diagonal (inch)} - 0.0835$

Installation (continued)

Calculation formulas for projection distance by lens types (for PT-D12000U)

Model number of projection lens	Throw ratio	Aspect ratio	Projection distance (L) formula (Units: m)
Zoom lens	ET-D75LE1	1.5-2.0 : 1	4:3 Minimal distance : $L = 0.0307 \times \text{Screen diagonal (inch)} - 0.0760$ Maximal distance: $L = 0.0410 \times \text{Screen diagonal (inch)} - 0.1004$
			16:9 Minimal distance : $L = 0.0334 \times \text{Screen diagonal (inch)} - 0.0760$ Maximal distance: $L = 0.0446 \times \text{Screen diagonal (inch)} - 0.1004$
	ET-D75LE2	2.0-3.0 : 1	4:3 Minimal distance : $L = 0.0412 \times \text{Screen diagonal (inch)} - 0.0795$ Maximal distance: $L = 0.0617 \times \text{Screen diagonal (inch)} - 0.1064$
			16:9 Minimal distance : $L = 0.0448 \times \text{Screen diagonal (inch)} - 0.0795$ Maximal distance: $L = 0.0672 \times \text{Screen diagonal (inch)} - 0.1064$
	ET-D75LE3	3.0-5.0 : 1	4:3 Minimal distance : $L = 0.0617 \times \text{Screen diagonal (inch)} - 0.0958$ Maximal distance: $L = 0.1031 \times \text{Screen diagonal (inch)} - 0.1216$
			16:9 Minimal distance : $L = 0.0672 \times \text{Screen diagonal (inch)} - 0.0958$ Maximal distance: $L = 0.1123 \times \text{Screen diagonal (inch)} - 0.1216$
	ET-D75LE4	5.0-8.0 : 1	4:3 Minimal distance : $L = 0.1031 \times \text{Screen diagonal (inch)} - 0.1158$ Maximal distance: $L = 0.1639 \times \text{Screen diagonal (inch)} - 0.1013$
			16:9 Minimal distance : $L = 0.1123 \times \text{Screen diagonal (inch)} - 0.1158$ Maximal distance: $L = 0.1786 \times \text{Screen diagonal (inch)} - 0.1013$
	ET-D75LE8	7.9-15.0 : 1	4:3 Minimal distance : $L = 0.1640 \times \text{Screen diagonal (inch)} - 0.3862$ Maximal distance: $L = 0.3072 \times \text{Screen diagonal (inch)} - 0.3598$
		8.0-15.0 : 1	16:9 Minimal distance : $L = 0.1786 \times \text{Screen diagonal (inch)} - 0.3862$ Maximal distance: $L = 0.3346 \times \text{Screen diagonal (inch)} - 0.3598$
	ET-D75LE6	1.0-1.2 : 1	4:3 Minimal distance : $L = 0.0207 \times \text{Screen diagonal (inch)} - 0.0566$ Maximal distance: $L = 0.0248 \times \text{Screen diagonal (inch)} - 0.0736$
			16:9 Minimal distance : $L = 0.0225 \times \text{Screen diagonal (inch)} - 0.0566$ Maximal distance: $L = 0.0270 \times \text{Screen diagonal (inch)} - 0.0736$
Fixed-focus lens	ET-D75LE5	0.8 : 1	4:3 $L = 0.0158 \times \text{Screen diagonal (inch)} - 0.0835$
		16:9 $L = 0.0172 \times \text{Screen diagonal (inch)} - 0.0835$	

Installation dimensions diagram

Figure 1 : Dimensions applying when one unit is used

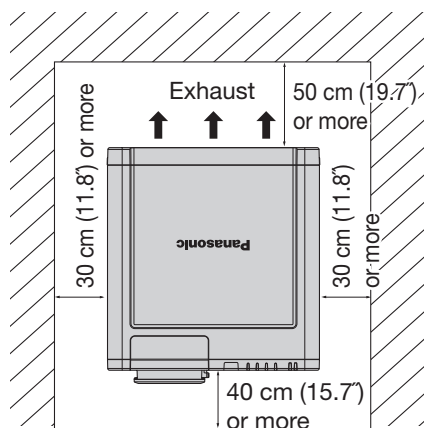

Figure 2 : Dimensions applying when two units are used

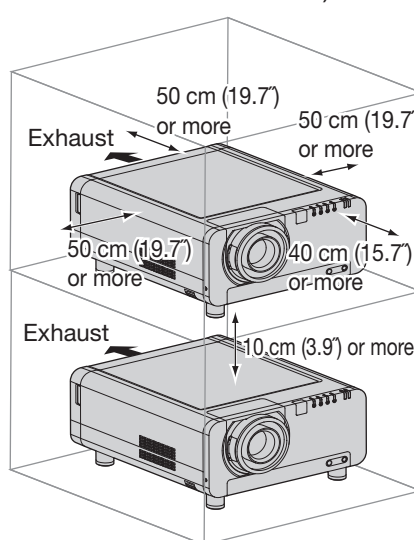
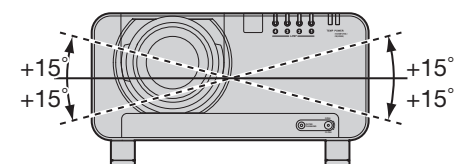

Figure 3 : Maximum rotation allowable



Attention

- Leave a clearance of at least 50 cm (19.7") so that the ventilation opening on the rear panel will not be blocked.
- Set up the projector so that air can flow freely around the rear of the projector. In addition, leave a space of 30 cm (11.8") or more at the sides so that the hot air coming out from the air outlet vents does not get drawn in through the air intake vents.
- Set up the projector with a space of 40 cm or more at the front so that the air filter can be replaced.
- When the projector is to be placed inside a box and used, ensure the structure has a duct or the like to discharge air from the box, leave the clearances shown in Fig. 2, and ensure the temperature during operation remains within the 0 °C to 35 °C range.

Connection

Before starting connection

- Before connection, read carefully the instruction manual for the device to be connected.
- Turning off the power switch of the devices before connecting cables.
- If any connection cable is not supplied with the device, or if no optional cable is available for connection of the device, prepare a necessary system connection cable to suit the device.
- Video signals containing too much jitter may cause the images on the screen to randomly wobble or wafture. In this case, a time base corrector (TBC) must be connected.
- The projector accepts the following signals: video, S-Video, analog RGB, DVI-D and signals which are compatible with the optional input module (p. 30).
- Some PC models cannot be connected to the projector.

● The pin-out and signal names of the S-VIDEO IN terminal are shown in the diagram below.

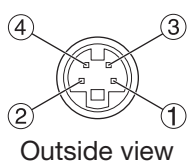

Pin No.	Signal
①	Ground (luminance signal)
②	Ground (color signal)
③	Luminance signal
④	Color signal

● The pin-out and signal names of the RGB2 IN terminal are shown in the diagram below.

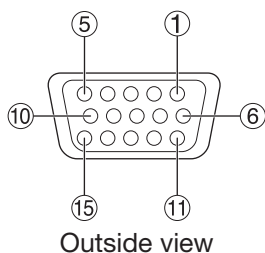

Pin No.	Signal
①	R/P _R
②	G/G • SYNC/Y
③	B/P _B
⑬	HD/SYNC
⑭	VD

④, ⑨, ⑫, and ⑮ are not assigned.
⑤-⑧, ⑩ and ⑪ are GND terminals.

● The pin-out and signal names of the DVI-D IN terminal are shown in the diagram below.

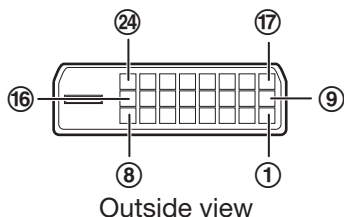

Pin No.	Signal	Pin No.	Signal
①	T.M.D.S data 2-	⑬	
②	T.M.D.S data 2+	⑭	+5V
③	T.M.D.S data 2 / 4 shield	⑮	Ground
		⑯	Hot plug detection
④		⑰	T.M.D.S data 0-
⑤		⑱	T.M.D.S data 0+
⑥	DDC clock	⑲	T.M.D.S data 0 / 5 shield
⑦	DDC data		
⑧		⑳	
⑨	T.M.D.S data 1-	㉑	
⑩	T.M.D.S data 1+	㉒	T.M.D.S clock shield
⑪	T.M.D.S data 1 / 3 shield	㉓	T.M.D.S clock+
⑫		㉔	T.M.D.S clock-

Connection (continued)

Example of connecting with VIDEO devices

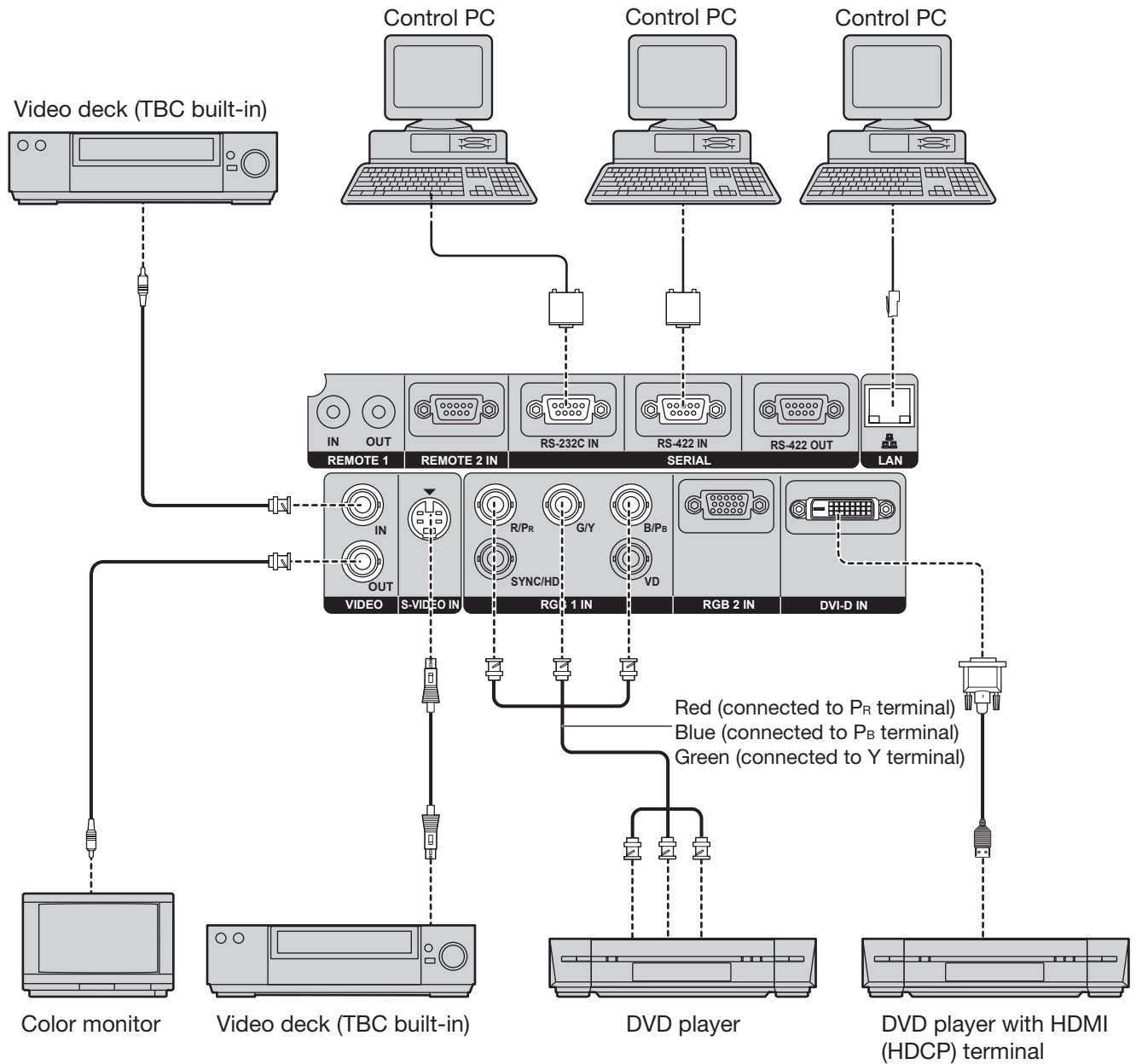

Attention

- When connecting with a video deck, be sure to use the one with a built-in time base corrector (TBC) or use a TBC between the projector and the video deck.
- If nonstandard burst signals are connected, the image may be distorted. If this is the case, connect a TBC between the projector and the video deck.

Note

- The DVI-D signal input terminal supports only a single link.
- The HDMI-DVI-D conversion cable is required to connect an HDMI-compliant device.
- When using the DVI-D input, EDID settings may be required for the connected device. (pp. 73, 74)
- It is possible to connect the DVI-D input terminal with an HDMI- or DVI-D-compliant device, but with some devices the images may not appear or other problems may be encountered in operation.

Example of connecting with personal computers

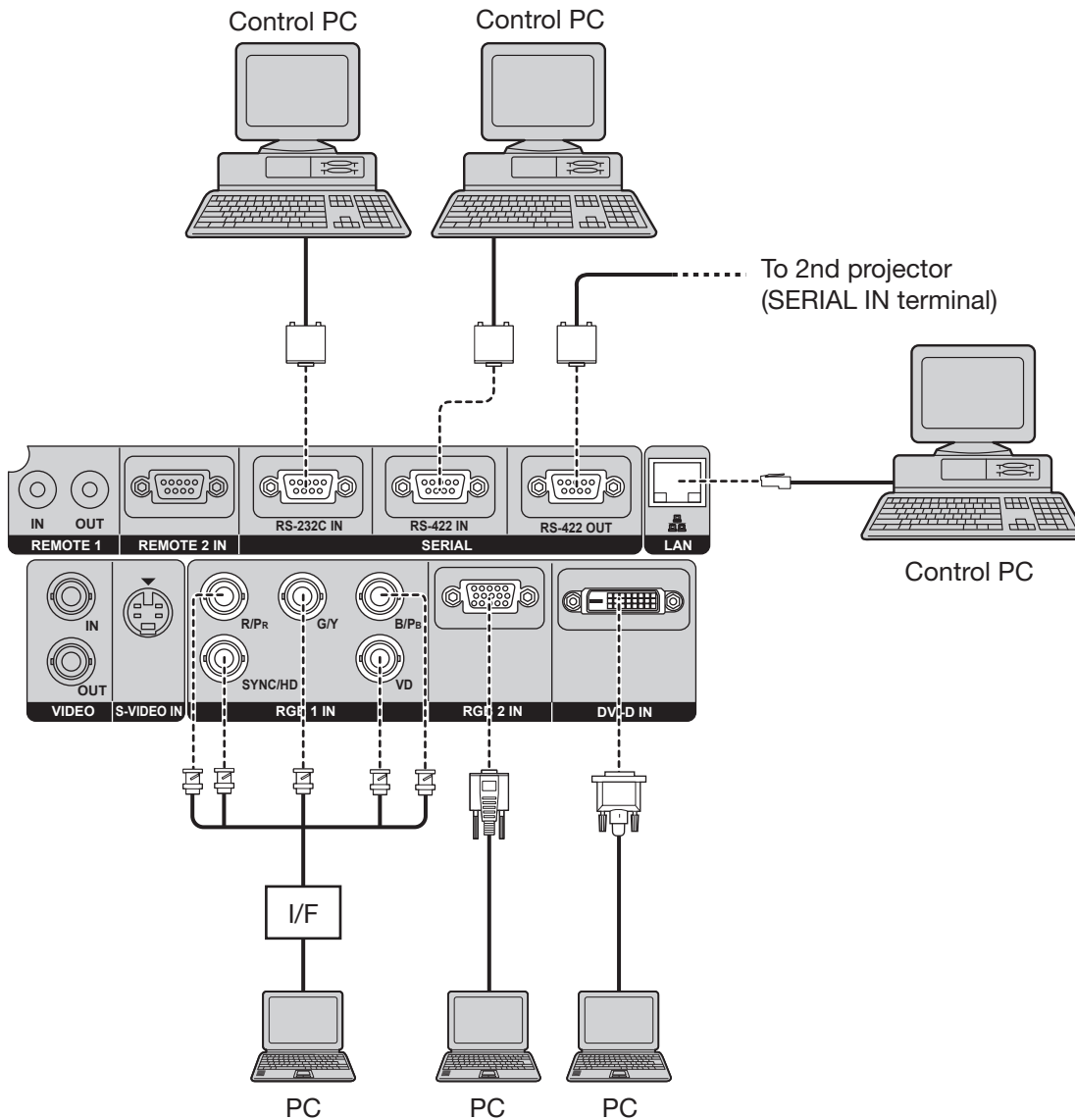

Attention

- When the main power of the main unit is turned off, also turn off the power of the PC.
- When the length of the cable from a PC to the projector is long or when there are many relay devices such as switches, the video may be interrupted or fuzzy. In such a case, use a cable compensator.

Note

- For the specifications of the RGB signals that can be applied from the PC, see the data sheet on pages 122-123.
- If your PC has the resume feature (last memory), the computer may not function properly until the resume capability is disabled.
- When using the DVI-D input, EDID settings may be required for the connected device. (pp. 73, 74)

Installation of (optional) input modules

Installing the input module

Types of the input modules (optional)

Prepare beforehand an input module (optional) compatible with the input signals of the system.

Module	Module model No.	Terminal	Signal formats supported
SD-SDI input module	ET-MD77SD1	BNC input × 1 BNC output × 1	SMPTE259M compliant : 480i, 576i
		RJ-45 input × 1 ^{*1}	10BASE-T/100BASE-TX
HD/SD-SDI input module	ET-MD77SD3	BNC input × 1 BNC output × 1	SMPTE259M compliant : 480i, 576i SMPTE292M compliant : 720/60p, 720/59.94p, 720/50p 1 035/60i, 1 035/59.94i, 1 080/60i, 1 080/59.94i 1 080/50i, 1 080/24sF, 1 080/23.98sF, 1 080/30p 1 080/29.97p, 1 080/25p, 1 080/24p, 1 080/23.98p
		RJ-45 input × 1 ^{*1}	10BASE-T/100BASE-TX
	ET-MD100SD4	BNC input × 2	Single link SD-SDI Signal : 480i, 576i Single link HD-SDI Signal (YP _B Pr 4:2:2) : 720/60p, 720/59.94p, 720/50p, 1 080/60i, 1 080/59.94i, 1 080/50i, 1 080/24sF, 1 080/23.98sF, 1 080/30p, 1 080/29.97p, 1 080/25p, 1 080/24p, 1 080/23.98p Dual link HD-SDI signal (RGB 4:4:4) : 1 920 × 1 080/50i, 1 920 × 1 080/59.94i, 1 920 × 1 080/60i, 1 920 × 1 080/23.98p, 1 920 × 1 080/23.98sF, 1 920 × 1 080/25p, 1 920 × 1 080/24p, 1 920 × 1 080/24sF, 1 920 × 1 080/29.97p, 1 920 × 1 080/30p Dual link HD-SDI signal (X' Y' Z' 4:4:4) : 2 048 × 1 080/23.98p, 2 048 × 1 080/23.98sF, 2 048 × 1 080/24p, 2 048 × 1 080/24sF
DVI-D input module	ET-MD77DV	DVI-D 24p input × 1	HDCP-compliant ^{*2} DVI-D single link, DVI 1.0 compliant 480p, 576p, 720/60p, 720/59.94p, 720/50p 1 080/60i, 1 080/59.94i, 1 080/50i, 1 080/24sF, 1 080/23.98sF 1 080/30p, 1 080/29.97p, 1 080/25p, 1 080/24p, 1 080/23.98p 1 080/60p, 1 080/59.94p, 1 080/50p Displayable resolution VGA - WUXGA ^{*3} (non-interlace) Dot clock frequency 25 - 162 MHz
		RJ-45 input × 1 ^{*1}	10BASE-T/100BASE-TX

*1: The LAN terminal present on the optional input module cannot be used with the PT-D12000U/PT-DZ12000U. Use the LAN terminal that is provided as standard with the projector.

*2: HDCP (High-bandwidth Digital Content Protection)

HDCP is a specification for encoding digital image signals which was developed to protect digital content. The DVI-D/HDMI output signals from the HDCP-compliant equipment have been encoded by the HDCP specifications to ensure content protection, but the DVI-D input module is capable of displaying the digital images properly since it complies with the HDCP specification.

*3: The WUXGA signals support only VESA CVT-RB (Reduced Blanking) signals.

■ Procedure of installation

Disconnect the power before installing the input module.

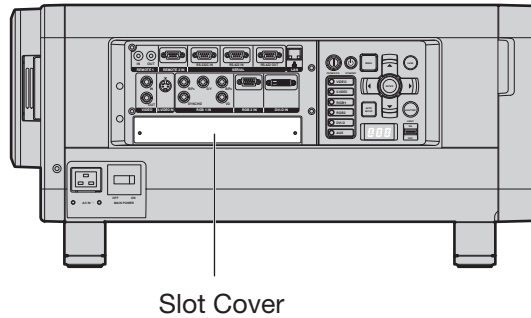

1. Remove the slot cover.

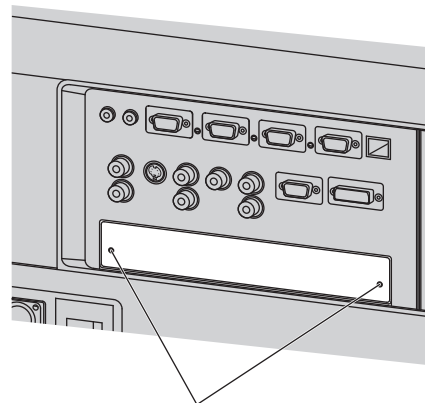

2. Insert the input module.

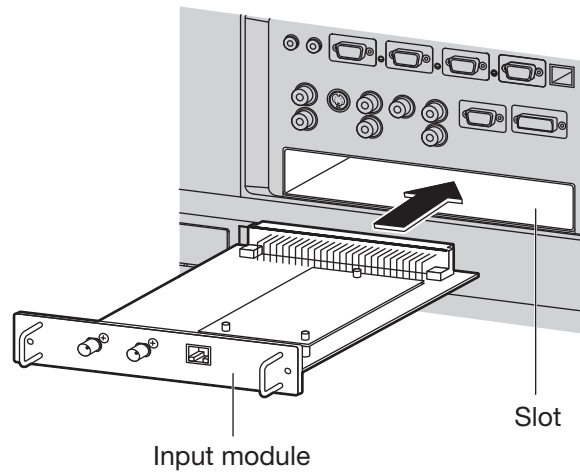

3. Install the two screws.

4. Register the input signal.

- This projector needs to register the type of input signal after the installation of the input module.
- For details on the registration of the input signals, refer to pages 45-47.

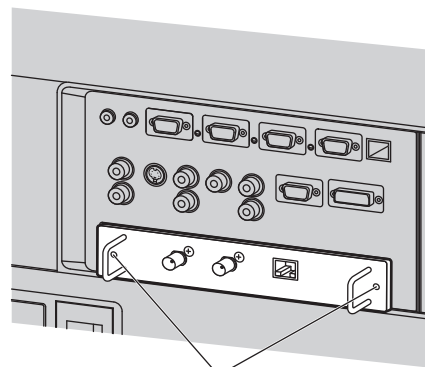

Installation of (optional) input modules (continued)

Connecting signals to the input module

When installing the projector, it is necessary to connect signals to the input module in accordance with the connecting equipment.

Refer to the following diagram to establish proper signal connection.

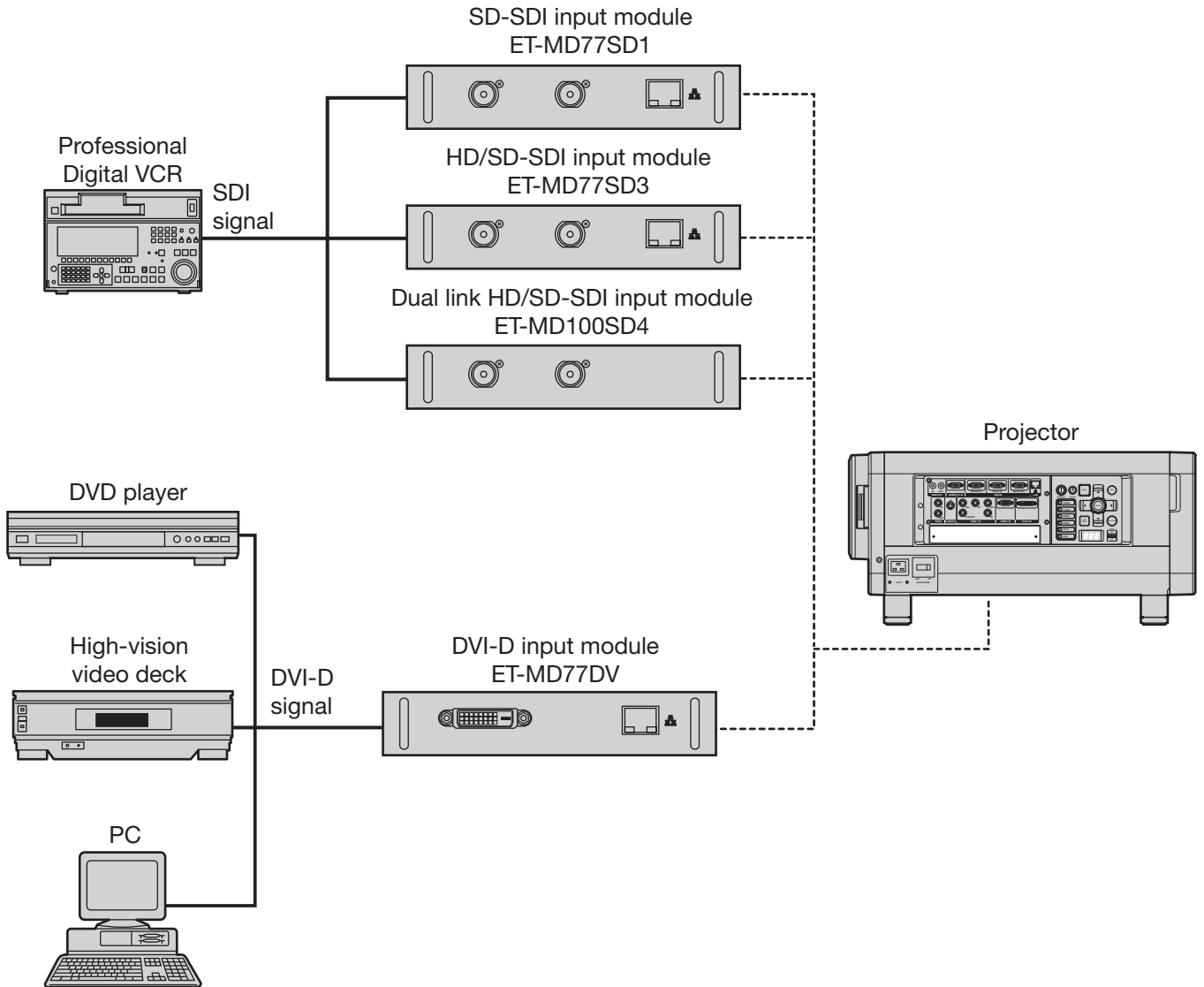

Note

- Insert the input module suitable for the input signal specifications.
- Normally, use SYSTEM SELECTOR in "AUTO". (pp. 58-59)

Connecting the signal to the SD-SDI input module

SD-SDI input module (optional)
ET-MD77SD1 (for 480i/576i)

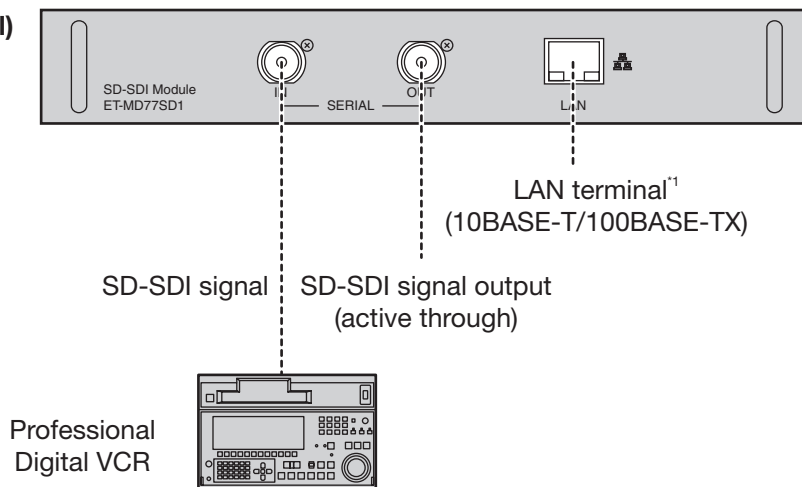

Note

- If a source with an unstable signal is connected, errors in automatic signal recognition may occur. If this happens, use the SYSTEM SELECTOR menu to switch the format to the one which matches the signals being input.
- You can switch the input format mode from the SYSTEM SELECTOR menu. (pp. 58-59)

*1: The LAN terminal present on the optional input module cannot be used with the PT-D12000U/PT-DZ12000U. Use the LAN terminal that is provided as standard with the projector.

Connecting the signal to the HD/SD-SDI input module

HD/SD-SDI input module (optional)
ET-MD77SD3 (for HD/SD)

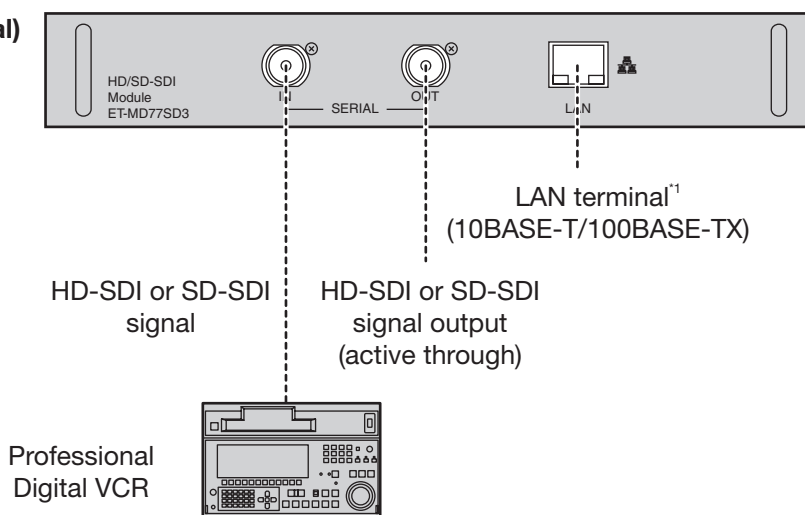

Note

- You can switch the input format mode from the SYSTEM SELECTOR menu. (pp. 58-59)
- If a source with an unstable signal is connected, errors in automatic signal recognition may occur. If this happens, use the SYSTEM SELECTOR menu to switch the format to the one which matches the signals being input.
- To ensure full imaging performance, use a connecting cable with the specifications of Canare 5CFB or higher, or of Belden1694A or higher.
(For example: Canare 5CFB, 5CFTX, 7CFB, Belden1694A, etc.)

*1: The LAN terminal present on the optional input module cannot be used with the PT-D12000U/PT-DZ12000U. Use the LAN terminal that is provided as standard with the projector.

Installation of (optional) input modules (continued)

Connecting the signal to the dual link HD/SD-SDI input module

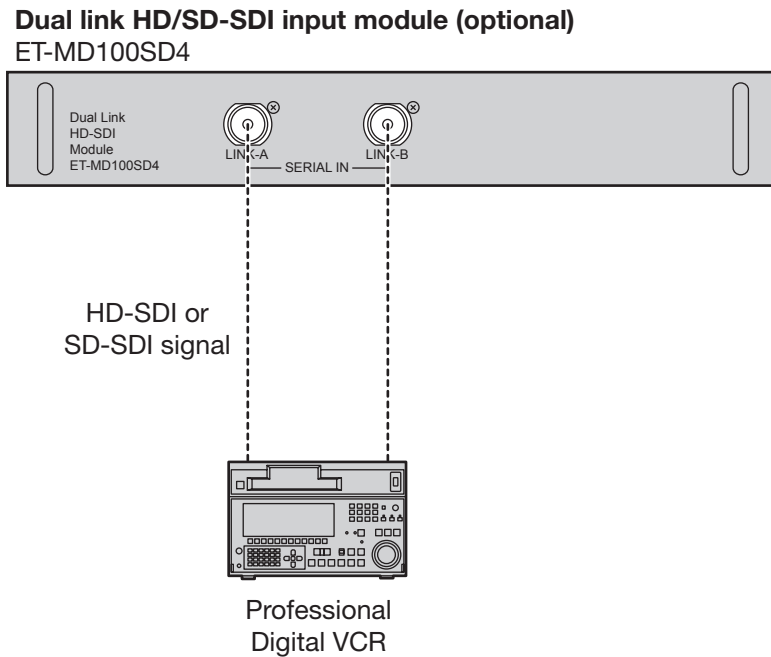

- When connecting a single link signal, connect to the LINK-A terminal.
- When connecting a dual link signal, connect to both the LINK-A and LINK-B terminals.

Note

- You can switch the input format mode from the SYSTEM SELECTOR menu. (pp. 58-59)
- Settings specific to the connected device are required. (pp. 74-75)
- To send the pictures properly, use a connecting cable with the specifications of Canare 5CFB or higher (5CFB, 7CFB, etc.) or of Belden1694A or higher. Also, use a cable that is shorter than 100 m.
- Make sure that the cables used to link LINK-A terminal and LINK-B terminal are of the same type and length. If there is a difference in length greater than 4 m between the two cables, the images will not be projected correctly.
- When connecting to dual link signals, connect directly to the signal output device without connecting through a distributor or other such device. A phase difference may occur between the LINK-A signal and LINK-B signal, which may prevent the image from being correctly projected.
- If the connected signal is unstable, the signal auto-detect function may not operate correctly. In this case, switch to a mode that better suits the signal format from the SYSTEM SELECTOR menu.

Connecting signals to the DVI-D input module

DVI-D input module (optional) ET-MD77DV

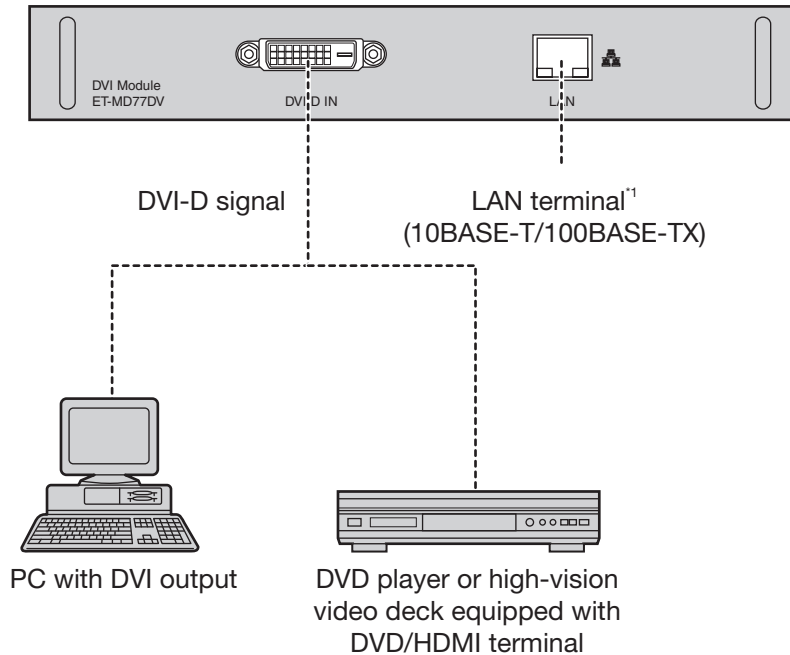

- Pin assignments and signal names of DVI-D input terminal are listed in the table at right.

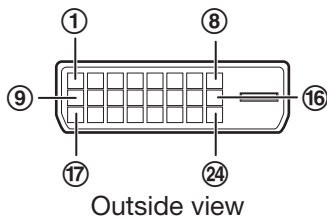

Pin No.	Signal	Pin No.	Signal
①	T.M.D.S data 2-	⑬	
②	T.M.D.S data 2+	⑭	+5V
③	T.M.D.S data 2 / 4 shield	⑮	Ground
		⑯	Hot plug detection
④		⑰	T.M.D.S data 0-
⑤		⑱	T.M.D.S data 0+
⑥	DDC clock	⑲	T.M.D.S data 0 / 5 shield
⑦	DDC data		
⑧		⑳	
⑨	T.M.D.S data 1-	㉑	
⑩	T.M.D.S data 1+	㉒	T.M.D.S clock shield
⑪	T.M.D.S data 1 / 3 shield	㉓	T.M.D.S clock+
⑫		㉔	T.M.D.S clock-

Note

- The DVI-D signal input module supports only a single link.
- The HDMI-DVI-D conversion cable is required to connect an HDMI-compliant device.
- When using the DVI-D input, EDID settings may be required for the connected device. (pp. 73, 74)
- It is possible to connect the DVI-D input module with an HDMI- or DVI-D-compliant device, but with some devices the images may not appear or other problems may be encountered in operation.

*1: The LAN terminal present on the optional input card cannot be used with the PT-D12000U/PT-DZ12000U. Use the LAN terminal that is provided as standard with the projector.

How to install and remove the projection lens (optional)

Adjust the lens shift position so that it is at the home position (p. 41) before installing or removing the projection lens.

Attention

- Remove the dust-proof sponge from the lens fitting of the projector before installing the projection lens. (Keep the dust-proof sponge in a safe place for later use if needed.)
- After removing the projection lens, install the dust-proof sponge to the lens fitting of the projector in order to stop dust from getting inside the projector.

How to install the projection lens

1. While pressing the projection lens cover lock button, pull the cover forward to remove it.

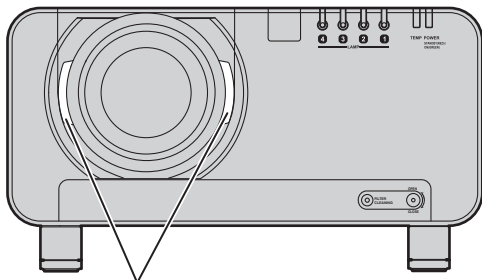

Projection lens cover lock button

2. Align the mark (orange) on the projection lens with the mark on the projector (→), and then insert the lens and turn it clockwise until it clicks into place.

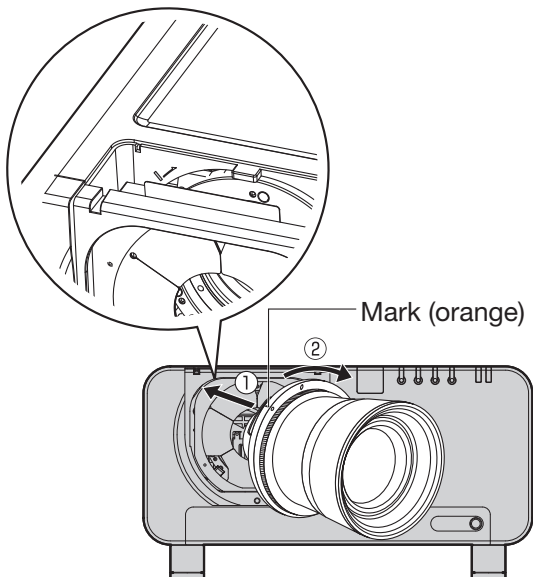

3. Push the projection lens cover in until it clicks into place.

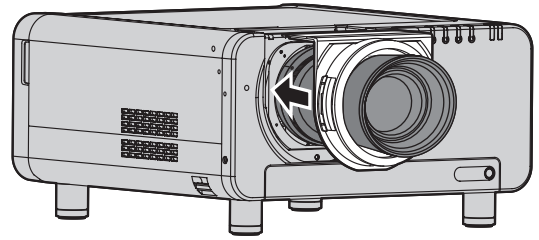

How to remove the projection lens

1. While pressing the projection lens cover lock button, pull the cover forward to remove it.

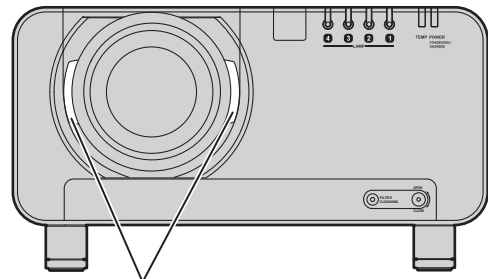

Projection lens cover lock button

2. While holding down the projection lens lock button, turn the projection lens counter clockwise, and then pull it off.

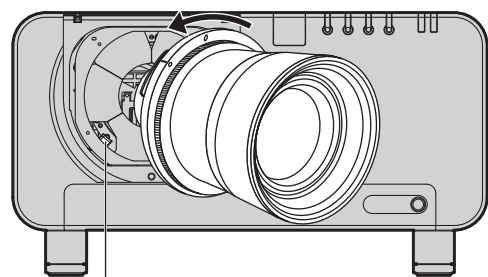

Projection lens lock button

Projection

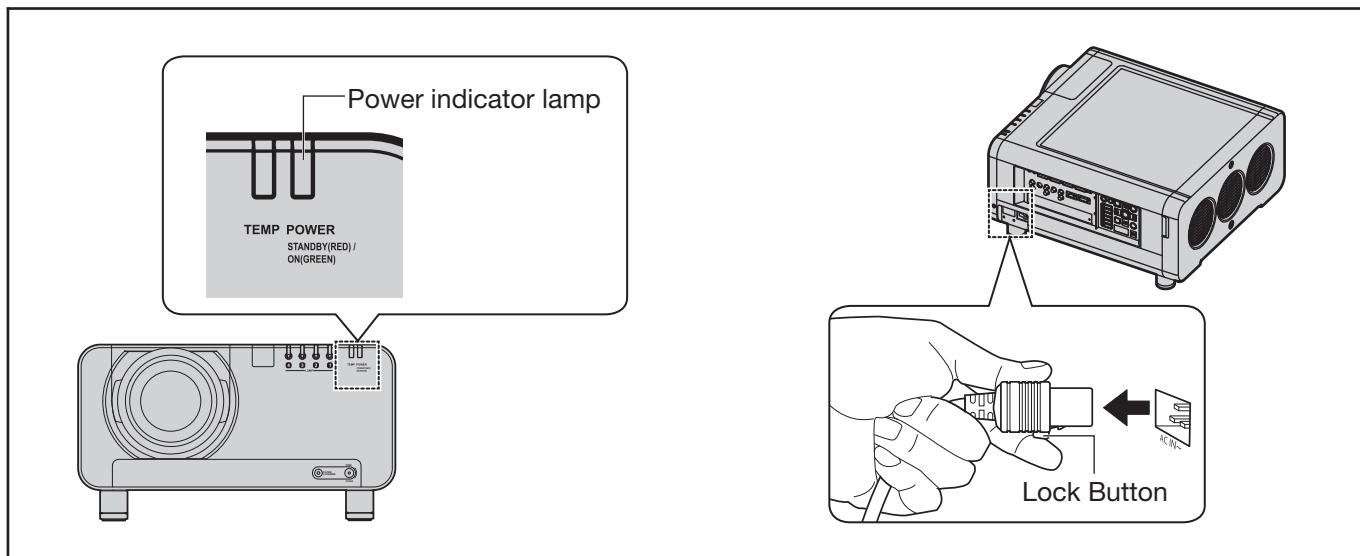

Power indicator lamp

This shows the power supply status. Make sure that you fully understand the operation of the power indicator lamp before operating the projector.

Indicator status		Projector status
Off		Main power is off
Red	Lit	Standby mode POWER ON () button can be pressed so that images can be projected.
Green	Lit	Images are being projected (on)
Orange	Lit	Cooling mode After a short while, the projector will switch to standby mode.

Attention

- While the projector is in cooling mode (when the power indicator lamp is lit orange), the internal fan is running to cool down the projector. Do not turn off the MAIN POWER switch or disconnect the power cord at this time.

Note

- If the POWER ON “|” button is pressed while the projector is still in cooling mode, it may take some time before the projector is ready to project pictures.

Connecting the power cord

Insert the accessory power cord securely into the projector and the electrical outlet.

Be sure to read the “IMPORTANT SAFETY NOTICE” (pp. 4-5) and “Precautions with regard to safety” (pp. 6-9) for details on handling the power cord.

Installation

1. Check the shape of the AC IN terminal on the side of the projector and the shape of the power cord connector, and insert the power cord securely into the AC IN terminal.

2. Insert the power cord plug into an electrical outlet.

Removal

1. Check that the MAIN POWER switch on the projector is at the OFF “○” position, and then disconnect the power cord plug from the electrical outlet.
2. Remove the power cord from the AC IN terminal while pressing the lock button on the power cord connector.

Attention

- Connect all peripheral equipment to the projector before connecting the projector’s power cord. (pp. 28-29)

Projection (continued)

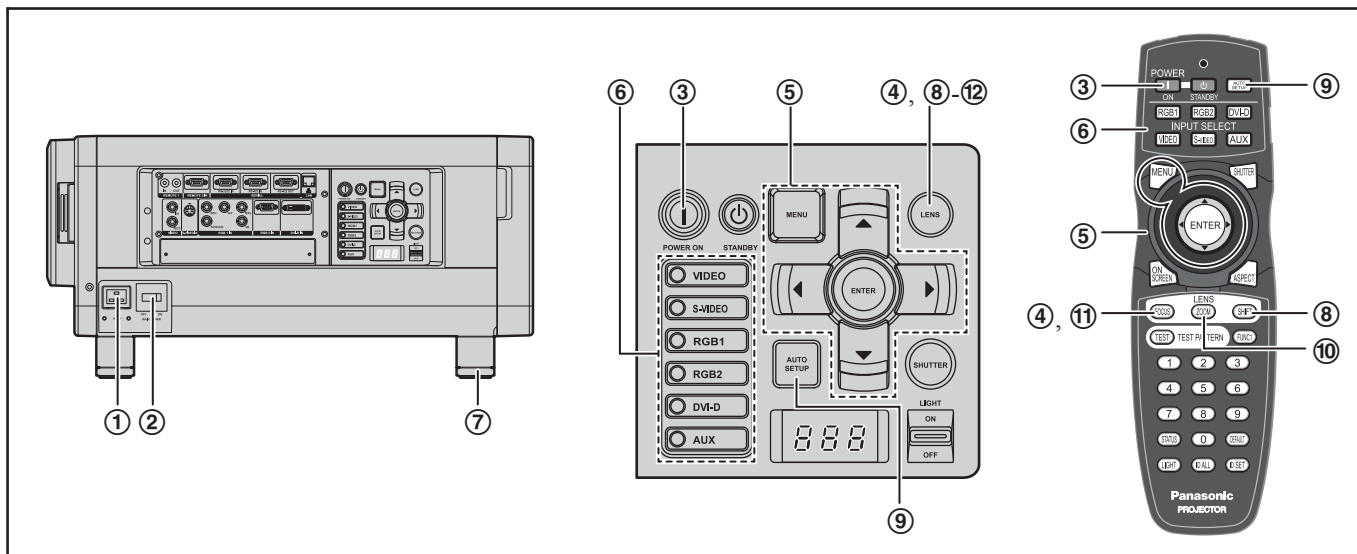

Powering up the projector

- ① **Connect the supplied power cable. (120 V/240 V, 50 Hz/60 Hz)**
- ② **Press the “|” marked side of the MAIN POWER switch to turn on the power.**
 - The power indicator lamp on the projector will flash in red. After a short period, the indicator will illuminate and the projector will enter standby mode.
- ③ **Press POWER ON “|”.**
 - The power indicator lamp illuminates in green and soon the image is projected on the screen.

Note

- If the projector is powered up at about 0 °C, a warm-up period of approximately 5 minutes may be necessary to start projection. The temperature monitor (TEMP) lamp lights up during the warm-up period. When the warm-up is completed, the temperature monitor (TEMP) lamp turns off and the image is projected on the screen.
- If the temperature of the operating environment is low and warm-up takes more than 5 minutes, the projector will judge that a problem has occurred and the power will be turned off automatically. If this happens, increase the temperature around the projector so that it is 0 °C or higher, and then turn on the MAIN POWER switch and the POWER ON “|” switch once more.

Making adjustment and selection

- ④ **Roughly adjust the focus of the lens. (p. 40)**
- ⑤ **Select and set the projection scheme. (p. 78)**
- ⑥ **Select the input signal by pressing the input selector button RGB1, RGB2, DVI-D, VIDEO, S-VIDEO and AUX. (p. 48)**
 - The AUX button is disabled when an optional input module is not connected.
- ⑦ **Adjust the tilt of the main unit in front and rear or right and left. (p. 20)**
- ⑧ **Adjust the H & V Lens shift as required. (p. 40)**
- ⑨ **Press AUTO SETUP if the input signal is RGB signal. (p. 49)**
- ⑩ **Zoom the lens so the image fills the screen. (p. 40)**
- ⑪ **Adjust the focus. (p. 40)**
- ⑫ **Readjust the zoom so that the image size fits in the screen. (p. 40)**

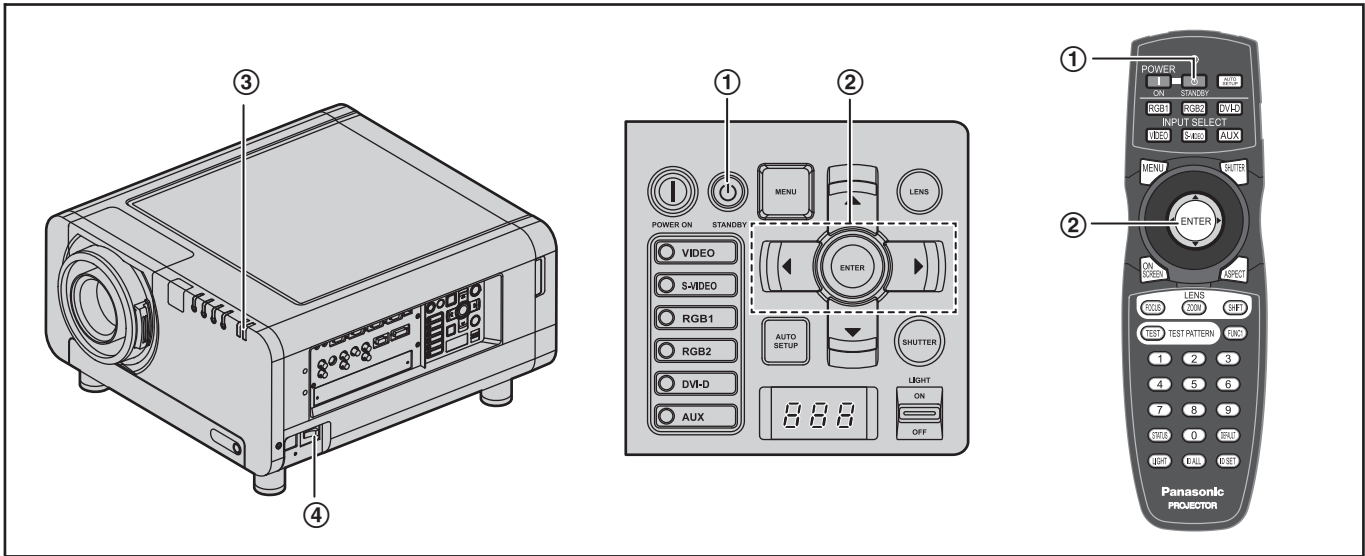

Powering off the projector

① Press POWER STANDBY “”.

- A confirmation screen will appear.

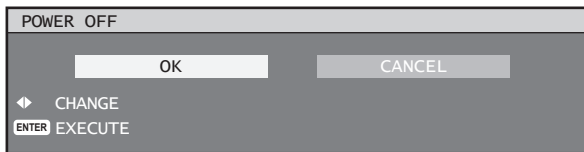

② Press or to select “OK” and press ENTER. (or press POWER STANDBY “” again.)

- The projection of the image stops, and the power indicator lamp of the main unit lights up orange. (The cooling fan keeps running.)

③ Wait until the power indicator lamp of the main unit turns to red (i.e., until the cooling fan stops). (Approx. 3 minutes)

- While the cooling fan is still running, never turn off the MAIN POWER switch, nor unplug the projector from the outlet.

④ Press the “” marked side of the MAIN POWER switch to remove all power from the projector.

Note

- In the cooling state after the power is turned off, the lamp will not light up even if the power is turned on. To light up the lamp, turn on the power supply again when the lamp has been cooled sufficiently.
- The projector consumes approximately 15 W (240 V mode) and 10 W (120 V mode) of power even in standby mode. (Power indicator lamp lit in red)
- If the main power is mistakenly turned off during use, the lamp may not relight after power is restored. Please wait a few moments, then try again.

Be sure to set the date and time when the projector is turned on for the first time after being purchased. For details, refer to “Setting the date and time” on page 83.

How to adjust the lens

How to adjust the focus, zoom and shift

Use the Lens Shift, Zoom, and Focus controls to properly frame the image on the screen.

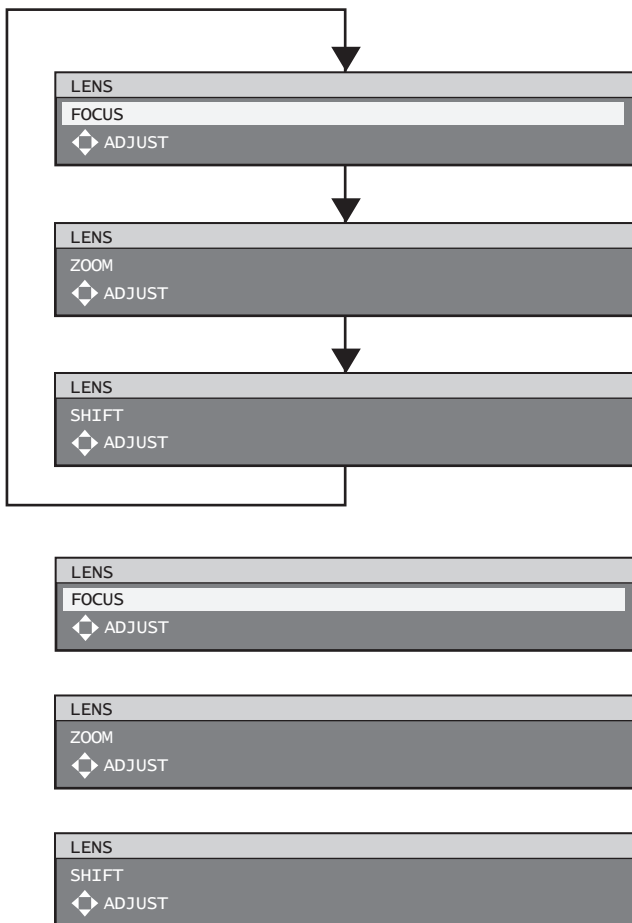

■ At the projector

1. Press LENS on the control panel.

- Pressing the button changes the setup screen in the order of “FOCUS”, “ZOOM” and “SHIFT”.

2. Press ▲▼◀▶ to select an item and adjust it.

■ Using the remote control

1. Press LENS (FOCUS, ZOOM, SHIFT) on the remote control.

2. Press ▲▼◀▶ to select an item and adjust it.

CAUTION:

Be careful not to catch your fingers between the lens and shroud when shifting the lens.

Note

- Only “FOCUS” is displayed with the background colors set with OSD DESIGN, to distinguish the displayed adjustment menu by color, even if the characters cannot be read and look out of focus. (p. 75)
- The zoom adjustment menu will be displayed only when a lens with zoom function is installed.

Adjustment range after lens position (optical shift)

Do not move the lens beyond the bounds of the shift range as this may cause a change in the focus. This limitation is to protect the parts of the projector.

Using the standard projection position as the reference, the optical axis shift function makes it possible to adjust the projection position in the ranges shown in the figures below.

Model number of projection lens		PT-D12000U	PT-DZ12000U
Zoom Lens	ET-D75LE6	<p>Projected screen height, V</p> <p>Standard projection position</p> <p>Projected screen width, H</p>	<p>Projected screen height, V</p> <p>Standard projection position</p> <p>Projected screen width, H</p>
	ET-D75LE1 ET-D75LE2 ET-D75LE3 ET-D75LE4 ET-D75LE8	<p>Projected screen height, V</p> <p>Standard projection position</p> <p>Projected screen width, H</p>	<p>Projected screen height, V</p> <p>Standard projection position</p> <p>Projected screen width, H</p>

Note

- The ET-D75LE5 has a fixed focal point, and so shift adjustment cannot be carried out.

Moving the projection lens position to the home position

- Press and hold **LENS** on the projector's controls or **SHIFT** on the remote control for 3 seconds or more.



- Press **ENTER** while the menu shown above is being displayed. (It will be displayed for about 5 seconds.)

- "PROGRESS..." will appear in the menu, and the projection lens will move to the home position.

Note

- The home position for the projection lens is the lens position when the lens is being replaced or when the projector is being stored away, and it is not the optical center of the screen.

How to adjust the lens (continued)

Lens adjustment to compensate for uneven screen focus

■ About the focus balance

● Relationship between lens orientation and screen focus

If the projection lens is tilted with respect to the plane of the screen, uneven focus will result.

Figure 1: Illustration of influence of lens orientation

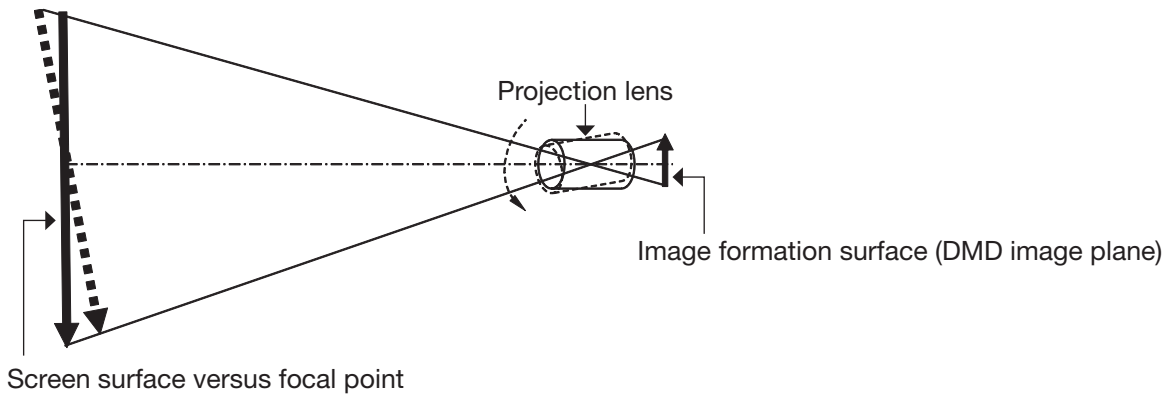

■ Procedure for adjusting the focus balance (tilt compensation in the lens mount)

Three focus adjustment screws on the lens mount may be used to compensate for uneven screen focus.

● Structure of lens mount (Figure 2, Figure 3)

The three adjustment screws allow the lens to be tilted up and down, and three more screws lock down the adjustment.

Figure 2 : Front view of lens mount (when viewed from screen side)

Lens bracket (a) Locking screw

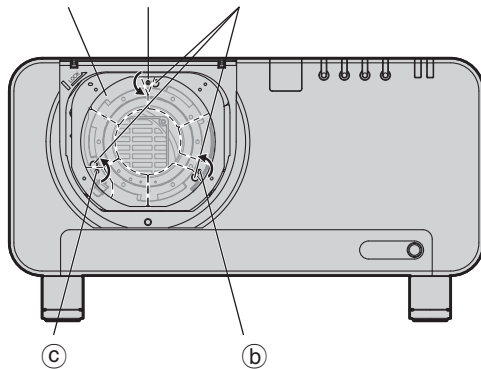

(Adjust the focus adjustment screws (a), (b) and (c) after installing the lens.)

Figure 3 : Cross section view of the lens mount

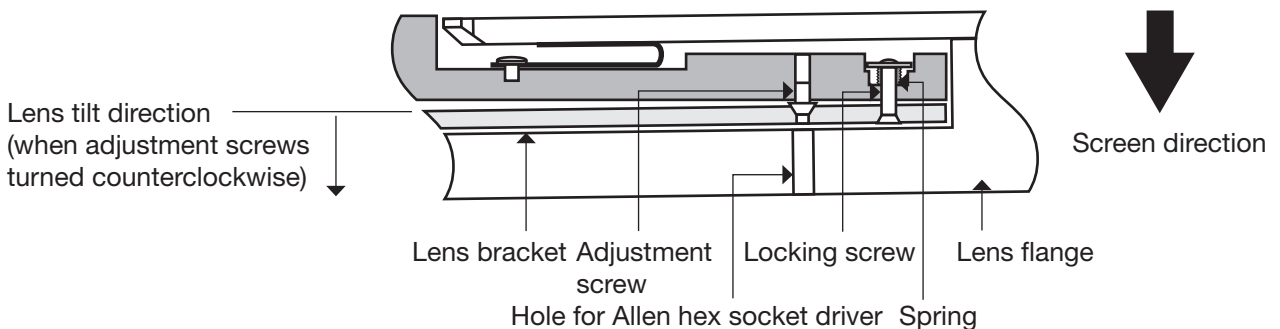

If the lens is heavy or the projector is installed so that it is tilted, the lens may be tilted, resulting in the focus becoming unbalanced.

In such a case, refer to the figure 4 and table below, and follow the procedure below to perform adjustment.

● **Adjustment procedure**

- ① **Display the internal test pattern grid, and defocus the image.**
- ② **Adjust the lens focus till one or more sides of the grid comes into focus. Note the appropriate screws for the out-of-focus sides of the grid as described below.**
- ③ **Remove the lens cover and lens.**
- ④ **Loosen the locking screws for each of the adjustment screws (a), (b) and (c) as needed, following the indications in the example. The screws to be adjusted correspond to the out-of-focus sides of the image.**

Attention

- Be careful because turning a screw more than twice to loosen it will result in the spring becoming detached and the projector needing to be repaired.
 - Make adjustments in up to two places, and fully turn the screw clockwise in at least one place.
- ⑤ **Reinstall the lens. The adjustment screws can be accessed through the lens flange.**
 - ⑥ **Turn the adjustment screws (corresponding to the locking screws loosened in step 4) counterclockwise slightly till the out-of-focus image sides are in focus. (Turning the screws counterclockwise moves the lens bracket and tilts the lens toward the screen.)**
 - ⑦ **Readjust the lens shift position with the remote if needed.**
 - ⑧ **Refocus the image as in steps 1 and 2 above. Fine adjust the focus evenness as needed, as described in step 6.**
 - ⑨ **When adjustment is complete, remove the lens and then tighten the locking screws.**
 - ⑩ **Install the lens and lens cover.**

Tool to be used: Allen hex socket driver or Allen wrench (2.5 mm diagonal hexagon)
 An Allen wrench is supplied with the ET-D75LE6 and ET-D75LE8 optional lens.

Figure 4 : Relation between the adjustment place and adjustment screw

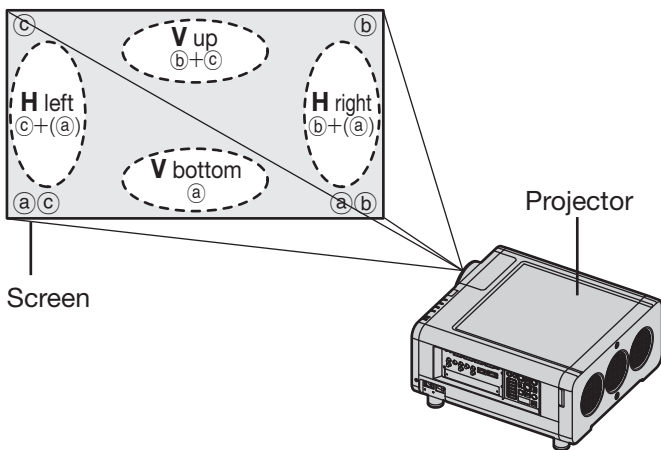

Adjustment place: The place where the just-in-focus point is at the back.

	When optimal focus point is at front of screen for V up	When optimal focus is at front of screen for V bottom	When optimal focus is at front of screen for H left	When optimal focus is at front of screen for H right
(a)	Turn counterclockwise	_____	_____	_____
(b)	_____	Turn counterclockwise	Turn counterclockwise	_____
(c)	_____	Turn counterclockwise	_____	Turn counterclockwise

How to adjust the lens (continued)

● Precautions for projector installation work

When installing the projector without using the adjustable feet, insert metal spacers (10 mm to 20 mm) between the projector base and the installation surface to ensure adequate airflow. Furthermore, use the screw holes (shown in the figure) for ceiling mounting to fix the projector in place. (Screw diameter: M6, set inside screw length: 8 mm maximum)

Note that if the cabinet is touching the installation surface when used, it may take a while until the images stabilize after the power is turned on.

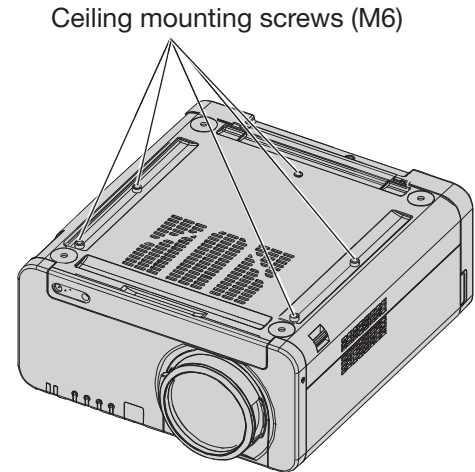
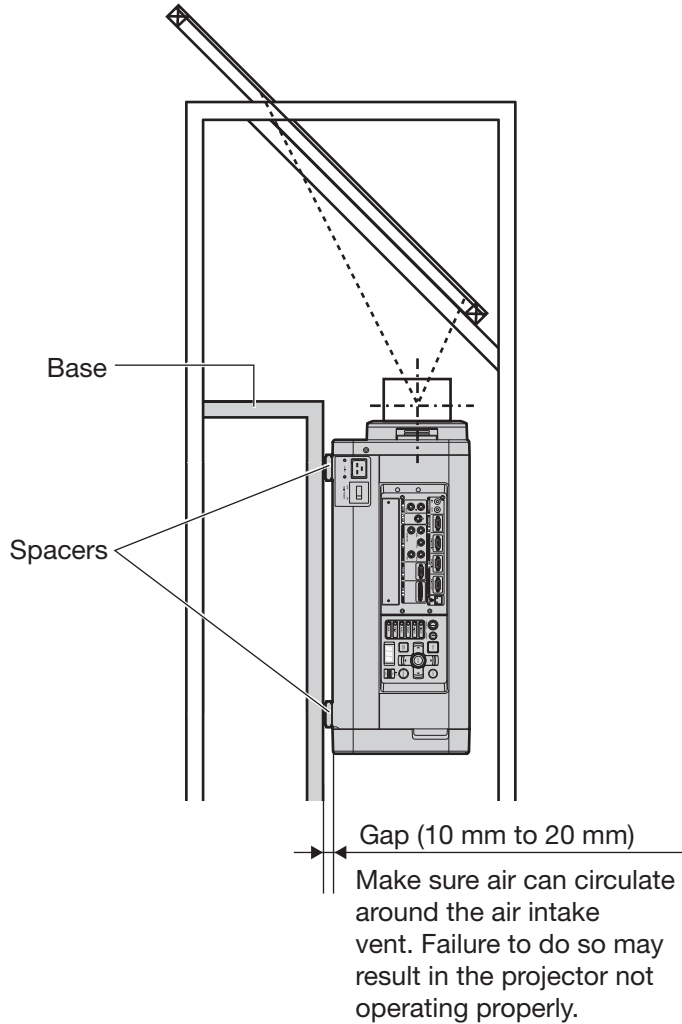

Registration of input signal data

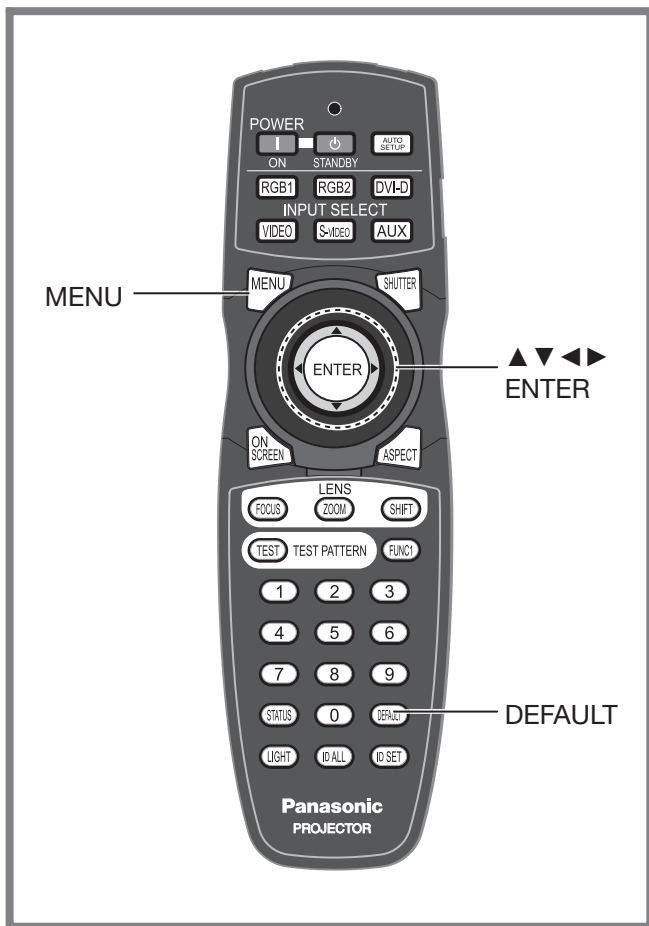

Registration of new data

When a new format input signal is applied to the projector, press MENU on the remote control or operating section of the main unit. When its data has been registered, the “MAIN MENU” screen is displayed.

Note

- The data of 96 input signals can be registered in the projector’s memory.
- Signals appropriate to the optional input cards will also be registered in the memories as they are input.
- The 96 memories are numbered over 12 pages (A to L: 8 data items can be registered on each page), and the data is registered in the unused memory location with the lowest number. If all the memories are filled, the data of the old signals is overwritten in sequence.
- The names of the registered data are automatically determined according to the type of signal and the available memory number, but they can be renamed as described below.
- If a menu is being displayed, the new signals will be registered at the instant they are input.

Renaming the registered signals

The input signal data must be registered because it is not registered on shipment of the projector.



Press to display the MAIN MENU screen.



Press to select “SIGNAL LIST”.

Press to display the “REGISTERED SIGNAL LIST” menu.

- The memories extend over 12 pages (A to L with 8 data items each, giving a total of 96 memories).

MAIN MENU	
PICTURE	
POSITION	
ADVANCED MENU	
DISPLAY LANGUAGE	
DISPLAY OPTION	
PROJECTOR SETUP	
P IN P	
TEST PATTERN	
SIGNAL LIST	
SECURITY	
NETWORK	
MENU SELECT	
ENTER SUB MENU	

1. Press ▲▼◀▶ to select the signal whose details are to be displayed.

REGISTERED SIGNAL LIST		
A1: SVGA72-A1	RGB1	---
A2: SVGA72-A2	RGB1	---
A3: SVGA72-A3	RGB1	---

2. Press ENTER.

- The “REGISTERED SIGNAL STATUS” screen will be displayed.

REGISTERED SIGNAL STATUS	
NAME	SVGA72-A2
MEMORY NO	A2
INPUT	RGB1
FH	48.08kHz
FV	72.17Hz
SYNC. STATE	H(POS)
	V(POS)

- The data items including the input signal name, memory number, input terminal, frequency and sync signal are automatically identified and displayed.
- When MENU is pressed, the “REGISTERED SIGNAL LIST” screen is restored.

3. Press ENTER.

- The “RENAME” screen will be displayed.

Registration of input signal data (continued)

4. Use ▲▼◀▶ to select the characters and numerals one by one, and press ENTER to set them.

RENAME																																																																																											
NAME	SVGA72-A2																																																																																										
MEMORY NO	A2																																																																																										
INPUT	RGB1																																																																																										
fH	48.08kHz																																																																																										
fV																																																																																											
SYNC STATE																																																																																											
<table border="1"> <tr> <td>A</td><td>B</td><td>C</td><td>D</td><td>E</td><td>F</td><td>G</td><td>H</td><td>I</td><td>J</td><td>K</td><td>L</td><td>M</td><td>N</td><td>O</td> </tr> <tr> <td>P</td><td>Q</td><td>R</td><td>S</td><td>T</td><td>U</td><td>V</td><td>W</td><td>X</td><td>Y</td><td>Z</td><td>:</td><td>/</td><td>.</td><td></td> </tr> <tr> <td>a</td><td>b</td><td>c</td><td>d</td><td>e</td><td>f</td><td>g</td><td>h</td><td>i</td><td>j</td><td>k</td><td>l</td><td>m</td><td>n</td><td>o</td> </tr> <tr> <td>p</td><td>q</td><td>r</td><td>s</td><td>t</td><td>u</td><td>v</td><td>w</td><td>x</td><td>y</td><td>z</td><td>/</td><td>+</td><td>-</td><td>*</td> </tr> <tr> <td>0</td><td>1</td><td>2</td><td>3</td><td>4</td><td>5</td><td>6</td><td>7</td><td>8</td><td>9</td><td></td><td>@</td><td>[</td><td>]</td><td></td> </tr> <tr> <td><</td><td>></td><td>BS</td><td>OK</td><td colspan="11">CANCEL</td> </tr> </table>		A	B	C	D	E	F	G	H	I	J	K	L	M	N	O	P	Q	R	S	T	U	V	W	X	Y	Z	:	/	.		a	b	c	d	e	f	g	h	i	j	k	l	m	n	o	p	q	r	s	t	u	v	w	x	y	z	/	+	-	*	0	1	2	3	4	5	6	7	8	9		@	[]		<	>	BS	OK	CANCEL										
A	B	C	D	E	F	G	H	I	J	K	L	M	N	O																																																																													
P	Q	R	S	T	U	V	W	X	Y	Z	:	/	.																																																																														
a	b	c	d	e	f	g	h	i	j	k	l	m	n	o																																																																													
p	q	r	s	t	u	v	w	x	y	z	/	+	-	*																																																																													
0	1	2	3	4	5	6	7	8	9		@	[]																																																																														
<	>	BS	OK	CANCEL																																																																																							

5. Once the name has been changed, press ▲▼◀▶ to select “OK” and then press ENTER.

- After registration, the “REGISTERED SIGNAL STATUS” screen is restored.
- If you would like to cancel the changes to the signal name, use ▲▼◀▶ to select “CANCEL” and then press ENTER. The changes will be cancelled and the displayed signal name will remain as it is.

Clearing Registered Signals data

1. Press ▲▼◀▶ to select the signal whose data is to be cleared.

REGISTERED SIGNAL LIST	
A1:NTSC-A1	VIDEO ----
A2:SVGA72-A2	RGB1 ----
A3: SXGA+60-A3	RGB1 ----
A4:VGA60-A4	RGB1 ----
A5:VGA85-A5	RGB1 ----
A6:NTSC-A6	S-VIDEO ----
A7:1080i/60i-A7	RGB1 ----
A8:1080/24p-A8	RGB1 ----

2. Press DEFAULT.

- The “ENTRY SIGNAL CLEAR” screen will be displayed.
- If the data is not to be cleared, press MENU to return to the “SIGNAL LIST” screen.

ENTRY SIGNAL CLEAR	SURE?
NAME	SVGA72-A2
MEMORY NO	A2
INPUT	RGB1
fH	48.08kHz
fV	72.17Hz
SYNC STATE	H(POS)
	V(POS)

3. Press ENTER.

- The data of the signal selected is cleared.

Sub memory

The projector has a sub-memory function that can be used to store several sets of adjustments for a given registered signal.

Sub-memories should be used when the operator needs to preadjust the picture settings or white balance, or to change the aspect setting when using signals from the same input source.

Sub-memory contains all data that can be adjusted such as screen aspect ratio and image adjustment data (BRIGHTNESS, CONTRAST etc.).

How to register into sub memory

A new input signal must first be registered before it can be saved to a sub-memory.

1. Press ◀▶ on normal screen (menu is not displayed).

- A “Check sub-memory registration” screen will appear if sub-memory has not been registered.
- The screen will show a list of the sub-memories registered for the currently entered signal.
- If “SUB MEMORY” is selected from the “FUNC1” menu in the “PROJECTOR SETUP” menu, you can use the FUNC1 button instead of the ◀▶ buttons. (p. 83)

Check sub-memory registration screen

REGISTER SUB MEMORY?	
NAME	SXGA60-A1
MEMORY NO	A1
INPUT	RGB1
fH	64.00kHz
fV	60.00Hz
SYNC STATE	H(POS)
	V(POS)

SUB MEMORY LIST screen

SUB MEMORY LIST	
1-1:	SXGA60-A1
1-2:	SXGA60-A2
1-3:	---
1-4:	---
1-5:	---
1-6:	---
1-7:	---
1-8:	---

2. Press ▲▼◀▶ to select the SUB MEMORY number stored in the “SUB MEMORY LIST”.

3. Press ENTER.

- A “Change registered signals” screen will appear.

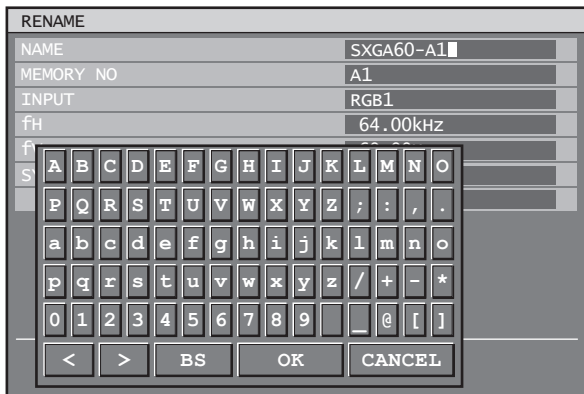

4. Press ENTER.

Note

- To rename a registered signal, perform steps 4 and 5 on page 46.

■ Procedure to switch to sub memory

1. Press ◀▶ on normal screen (when the menu is not displayed).

- The screen will show a list of the sub-memories registered for the currently entered signal.

2. Press ▲▼◀▶ to select the sub-memory signal to be switched in the “SUB MEMORY LIST”.

3. Press ENTER.

- The sub-memory selected in step 2 will now become active.

■ How to erase sub memory

The currently selected SUB MEMORY is deleted by pressing DEFAULT at the “REGISTERED SIGNAL LIST”.

■ On-screen indications

① Input switching / signal switching

This shows the registered signal name on the status screen for signal switching.

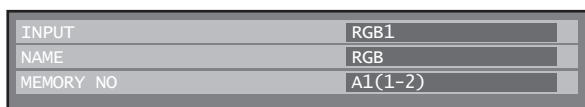

② Details of registered signal

REGISTERED SIGNAL STATUS	
NAME	SXGA60-A1
MEMORY NO	A5 (1-2)
INPUT	RGB1
fH	63.98kHz
fV	60.02Hz
SYNC. STATE	H(POS) V(POS)

- The designation can be set by the sub memory items.

MEMORY NO : A1 (1-2)

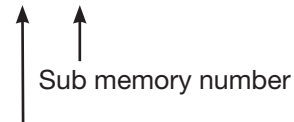

The place in which address code (A1, A2, ..., H7 and H8) signals are registered

Note

Restrictions

- The total number of registered signals (including any corresponding sub-memories) is 96.

Basic operations using the remote control

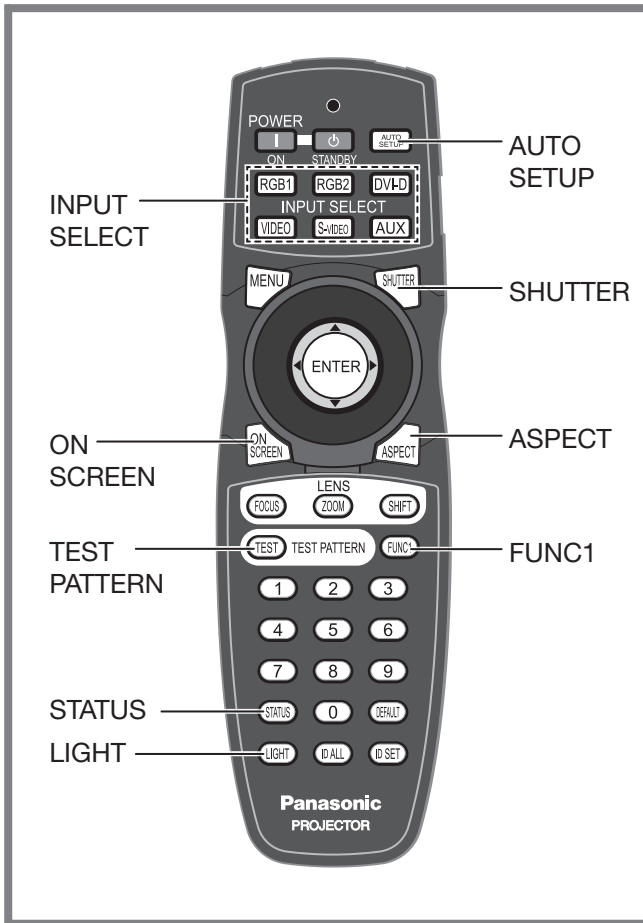

Switching the input signal

You can use the remote control to switch the signals that are being input and projected.

1. Press **INPUT SELECT** on the remote control or the main unit.

- **Press RGB1:**
Switches to RGB1 input.
- **Press RGB2:**
Switches to RGB2 input.
- **Press DVI-D:**
Switches to DVI-D input.
- **Press VIDEO:**
Switches to video input.
- **Press S-VIDEO:**
Switches to S-VIDEO input.
- **Press AUX:**
Switches to optional input module input. (The AUX button to switch the input is disabled when an optional input module is not connected.)

Note

- Refer to “Connection” for details on the input terminals. (pp. 27-29)

Using the **SHUTTER** function

If the projector is not used for a certain period of time during the meeting intermission, for example, a shutter mode is available that allows the user to hide images temporarily.

1. Press **SHUTTER** on the remote control or the main unit.

- The projected light is blocked by the internal shutter.

2. Press **SHUTTER** again.

- Projection resumes.

On-screen display function

This button electronically mutes the onscreen menus to avoid disrupting the program.

1. Press **ON SCREEN** on the remote control.

Status function

Pressing this button displays several pages of projector status information. It can also be used to send information about the projector’s status via e-mail.

1. Press **STATUS** on the remote control.

- The “STATUS” screen will be displayed.

STATUS		1/3
INPUT	RGB2	
NAME	XGA60-A399999	
SIGNAL FREQUENCY	48.36kHz/59.99Hz	
PROJECTOR RUNTIME	76h	
LAMP1	341h / ON /	
LAMP2	334h / ON /	
LAMP3	342h / ON /	
LAMP4	97h / ON /	
INTAKE AIR TEMP.	31°C/87°F	
OPTICS MODULE TEMP.	27°C/80°F	
AROUND LAMP TEMP.	31°C/87°F	
REMOTE2 STATUS	DISABLE	

Note

- Refer to “STATUS” of “PROJECTOR SETUP”. (p. 81)
- Refer to “How to use network function” for details on sending e-mail. (pp. 91-104)

Automatic adjustment (AUTO SETUP)

The automatic setup function can be used to automatically adjust the resolution, clock phase and picture position when analog RGB signals consisting of bitmap images such as computer signals are being input, or to automatically adjust the picture position when DVI-D signals are being input. (The automatic setup function does not work with video format signals such as signals output from a DVD player.) It is recommended to supply images with a bright white frame at the outermost periphery containing characters etc. that are clear in white and black contrast when the system is in automatic adjustment mode. Avoid supplying images that involve halftones or gradation such as photographs and computer graphics.

1. Press AUTO SETUP on the remote control or the main unit.

- A message “COMPLETE” appears if adjustment is ended normally.

Note

- “CLOCK PHASE” may have been shifted even when the adjustment ended normally. In this case, manually adjust the “CLOCK PHASE”.
- If an image with blurred edges or a dark image is input, “INCOMPLETE” may appear or adjustment may not be performed properly even if “COMPLETE” appears. In this case, manually adjust the items of “INPUT RESOLUTION”, “CLOCK PHASE” and “SHIFT”.
- For specific signals and landscape signals such as 16:9, adjustment should be made according to “AUTO SETUP” in the option menu.
- Automatic adjustment may not be available depending on the machine type of the personal computer.
- Automatic adjustment may not be available for synchronization signal of C-SYNC and G-SYNC.
- Image may be distorted for several seconds during automatic adjustment. This is not a malfunction.
- For every supplied signal, adjustment is required.
- Automatic adjustment can be canceled by pressing the MENU button during the course of automatic adjustment.
- Even for an RGB signal for which automatic setup is possible, if automatic setup is performed while moving images are being input, “INCOMPLETE” may appear, or adjustment may not be performed properly even if “COMPLETE” appears.

Turning on button illumination

Button illumination for the remote control can be turned on.

1. Press LIGHT on the remote control.

Note

- If no operations are carried out for approximately 10 seconds, button illumination will turn off automatically.

Using the FUNC1 button

“DISABLE”, “P IN P” (pp. 85-86), “SUB MEMORY” (pp. 46-47), “SYSTEM SELECTOR” (pp. 58-59), “SYSTEM DAYLIGHT VIEW” (pp. 56-57), or “FREEZE” (p. 83) operations can be assigned to the FUNC1 button on the remote control so that it can be used as an easy shortcut button.

Note

- Refer to “Setting FUNC1” for details. (p. 83)

Displaying the internal test pattern

The projector has eight types of internal test patterns to check the condition of the set.

To display test patterns, follow the steps below.

1. Press TEST PATTERN.
2. Press ◀▶ to select “TEST PATTERN”.

Note

- Setting is also possible by using an on-screen menu. Refer to “Displaying the internal test pattern” for details. (p. 87)
- Adjustment of the image, picture quality, position, size and other factors will not be reflected in test patterns. Be sure to display an actual input signal before performing these adjustments.

Changing the picture aspect ratio

You can toggle through an appropriate set of aspect ratios for a given input signal.

1. Press **ASPECT** on the remote control.

- The setting will change as follows each time ASPECT is pressed.

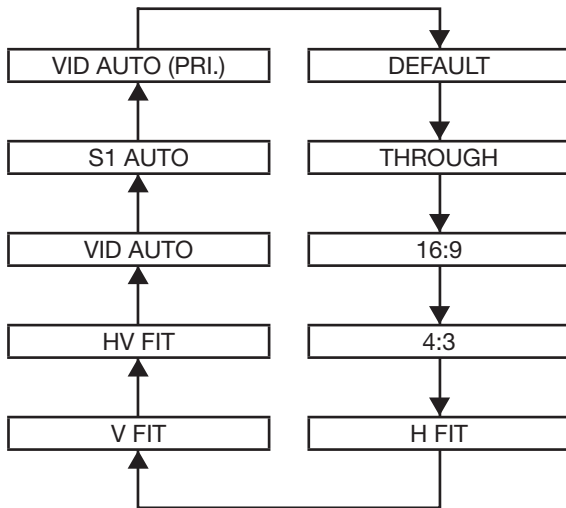

Note

- Some aspect ratios may not be available for selection depending on the input signal. Refer to “Adjusting the aspect ratio” for details. (p. 61)

On-screen menus

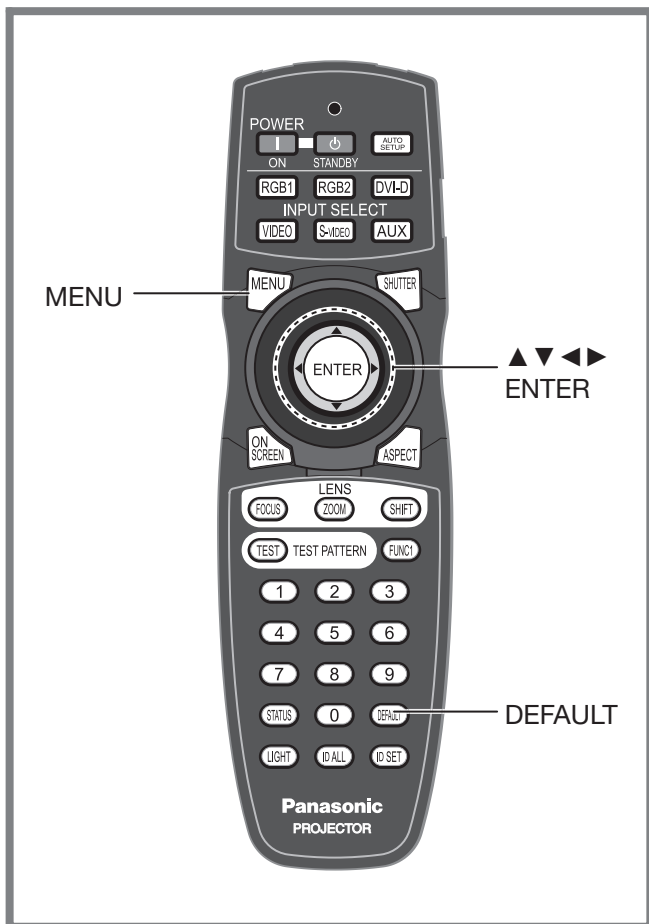

MAIN MENU

The main menu consists of the following 11 menu items. When a main menu item is selected, the screen changes to a sub-menu selection screen.

Icon	MAIN MENU item
	PICTURE
	POSITION
	ADVANCED MENU
	DISPLAY LANGUAGE
	DISPLAY OPTION
	PROJECTOR SETUP
	P IN P
	TEST PATTERN
	SIGNAL LIST
	SECURITY
	NETWORK

SUB MENU

The sub-menu screen appears, and you can set and adjust the various items in the sub-menu.

PICTURE (pp. 54-59)

PICTURE	
PICTURE MODE	STANDARD
CONTRAST	0
BRIGHTNESS	0
COLOR	0
TINT	0
COLOR TEMPERATURE	DEFAULT
GAMMA	DEFAULT
SYSTEM DAYLIGHT VIEW	OFF
SHARPNESS	0
NOISE REDUCTION	OFF
DYNAMIC IRIS	OFF
SYSTEM SELECTOR	AUTO1
◆ MENU SELECT	
◆ CHANGE	ENTER REGISTER

Note

- The factory default values may vary depending on the PICTURE menu.

Menus are extensively used for configuring, adjusting or reconfiguring the projector.



Press to display the MAIN MENU screen.



Select the item to be set.

Press to display the menu of the desired item.

MAIN MENU	
	PICTURE
	POSITION
	ADVANCED MENU
	DISPLAY LANGUAGE
	DISPLAY OPTION
	PROJECTOR SETUP
	P IN P
	TEST PATTERN
	SIGNAL LIST
	SECURITY
	NETWORK
◆ MENU SELECT	
ENTER SUB MENU	

- Some menu items may not be valid for certain signal formats applied to the projector. The menu items that cannot be adjusted or used are shown in gray characters, and they cannot be selected.

On-screen menus (continued)

POSITION (pp. 60-63)

POSITION	
SHIFT	
ASPECT	DEFAULT
ZOOM	
CLOCK PHASE	0
GEOMETRY	OFF
◆ MENU SELECT	
ENTER SUB MENU	

ADVANCED MENU (pp. 64-68)

ADVANCED MENU	
DIGITAL CINEMA REALITY	AUTO
BLANKING	
INPUT RESOLUTION	
CLAMP POSITION	
EDGE BLENDING	OFF
FRAME DELAY	DEFAULT
RASTER POSITION	
◆ MENU SELECT	
◆ CHANGE	

DISPLAY LANGUAGE (p. 69)

DISPLAY LANGUAGE	
<input checked="" type="radio"/> ENGLISH	
<input type="radio"/> DEUTSCH	
<input type="radio"/> FRANÇAIS	
<input type="radio"/> ESPAÑOL	
<input type="radio"/> ITALIANO	
<input type="radio"/> 日本語	
<input type="radio"/> 中文	
<input type="radio"/> РУССКИЙ	
<input type="radio"/> 한국어	
◆ SELECT	
ENTER SET	

DISPLAY OPTION (pp. 70-76)

DISPLAY OPTION	
COLOR MATCHING	OFF
LARGE SCREEN CORRECTION	OFF
SCREEN SETTING	
RGB IN	
DVI-D IN	
AUX DVI IN	
AUX SDI IN	
ON-SCREEN DISPLAY	
BACK COLOR	BLACK
STARTUP LOGO	LOGO3
◆ MENU SELECT	
◆ CHANGE	

PROJECTOR SETUP (pp. 77-84)

PROJECTOR SETUP 1/2	
PROJECTOR ID	ALL
INSTALLATION	FRONT-FLOOR
ALTITUDE MODE	ON
DIRECTION	HORIZONTAL
LAMP SELECT	QUAD
LAMP RELAY	OFF
RS-232C	
REMOTE2 MODE	DEFAULT
STATUS	
AIR FILTER CLEANING	
AUTO POWER OFF	DISABLE
FUNCI	
◆ MENU SELECT	
◆ CHANGE	

PROJECTOR SETUP 2/2	
DATE AND TIME	
SAVE ALL USER DATA	
LOAD ALL USER DATA	
INITIALIZE	
SERVICE PASSWORD	

P IN P (pp. 85-86)

TEST PATTERN (p. 87)

SIGNAL LIST (pp. 45-47)

SECURITY (pp. 88-90)

SECURITY	
SECURITY PASSWORD	OFF
SECURITY PASSWORD CHANGE	
DISPLAY SETTING	OFF
TEXT CHANGE	
CONTROL DEVICE SETUP	
◆ MENU SELECT	
◆ CHANGE	

NETWORK (pp. 91-104)

NETWORK	
NETWORK STANDBY	OFF
NETWORK SETUP	
NETWORK CONTROL	
NETWORK STATUS	
◆ MENU SELECT	
◆ CHANGE	

Using the menu screens

1. Press MENU.

- The “MAIN MENU” appears on the screen.

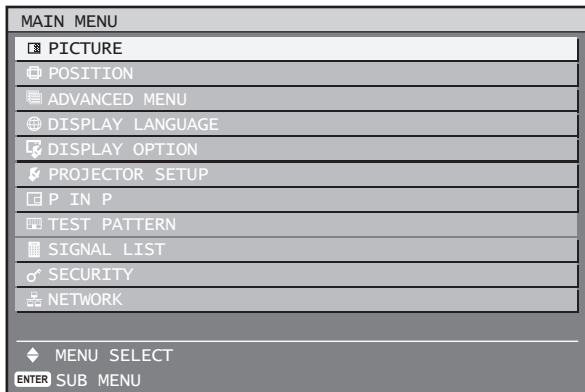

2. Press ▲ ▼ to select the desired item.

- The selected item is displayed with the colors set by OSD DESIGN. (p. 75)

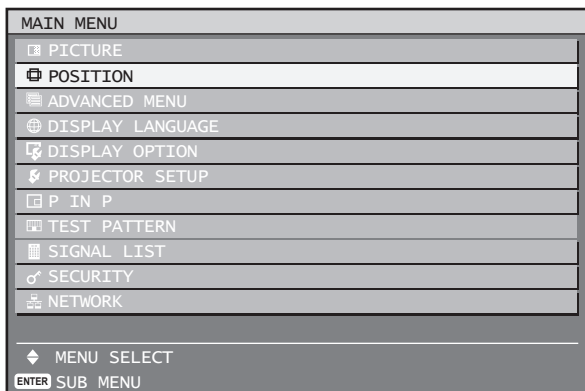

3. Press ENTER to establish your selection.

- The submenu for the selected option will now open.

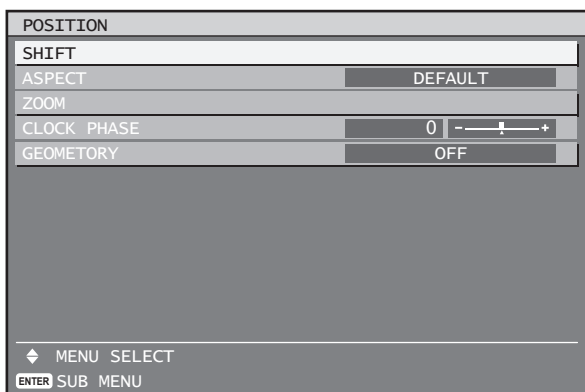

4. Press ▲ ▼ button to highlight the desired adjustment item, then press ◀ ▶ to change or adjust the parameter value.

- For some items, an individual adjustment screen containing a bar scale will appear as shown in the diagram below when ◀ ▶ is pressed.



- If no button is pressed for approx. 5 seconds while the individual adjustment screen is displayed, the screen will return to the previous page.

Returning to the previous screen

- When the “MENU” is on the screen, pressing the MENU button returns to the previous page.
- When the “MAIN MENU” is on the screen, pressing MENU clears all menus from the screen.

Menu items setting

- The bottom prompt line differs on each menu depending on the selected menu option:
- A prompt “◀ ▶ CHANGE” appears when changing the setting.
- A prompt “◀ ▶ ADJUST” appears for a separate bar graph.
- If there are more adjustments (items) available for a menu item, a page number will appear at the top-right of the screen.

Resetting to the factory default

If an adjustment item is selected and DEFAULT is pressed, the adjustment value will return to the factory default setting.

1. Press DEFAULT.

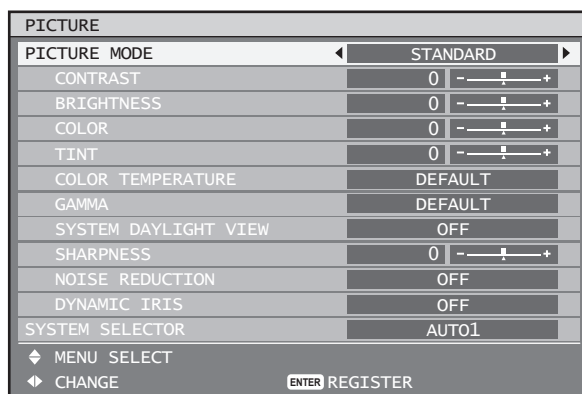

Adjusting the picture

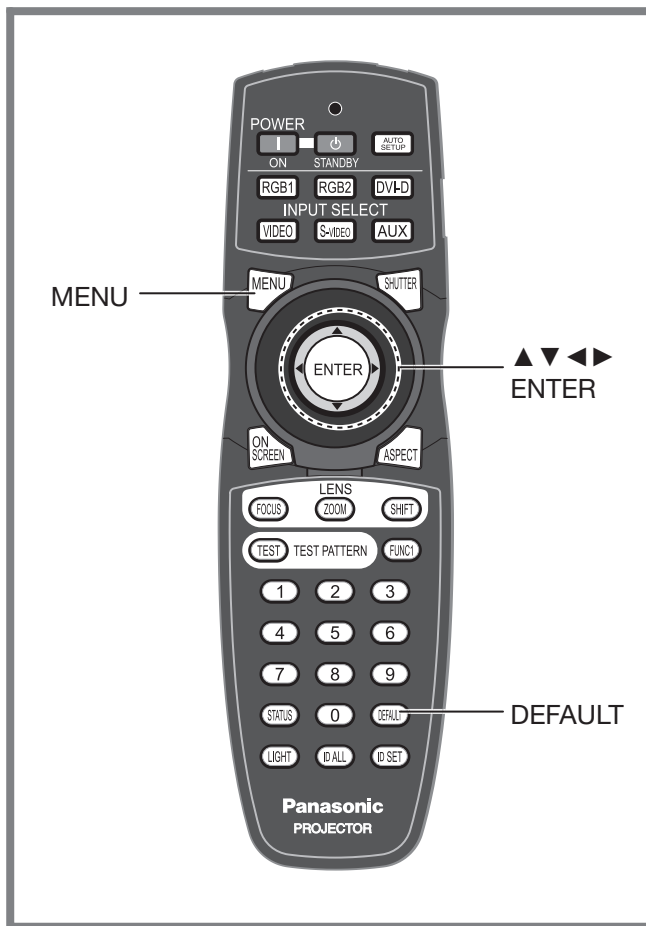

Switching the picture mode

The user can switch to the desired picture mode suitable for the image source and the environment in which this projector is used.

1. Press **▲▼** to select “**PICTURE MODE**”.

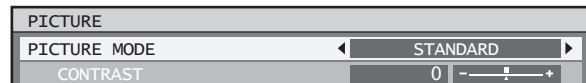

2. Press **◀▶** to switch “**PICTURE MODE**”.

- The setting will change as follows each time **◀▶** is pressed.

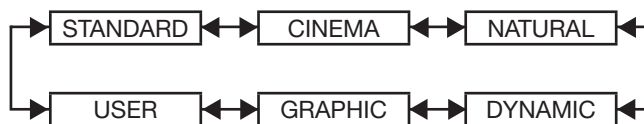

- **STANDARD:**
The picture becomes suitable for moving images in general.
- **CINEMA:**
The picture becomes suitable for movie sources.
- **NATURAL:**
The picture complies with sRGB.
- **DYNAMIC:**
The light output is maximized for use in bright areas.
- **GRAPHIC:**
The picture becomes suitable for input from the personal computer.
- **USER:**
The COLOR TEMPERATURE and GAMMA settings can be adjusted.

Note

- Factory defaults are “GRAPHIC” for RGB system and “STANDARD” for moving images.
- When ENTER is pressed while “PICTURE MODE” has been selected, the current Picture Mode page settings are saved and will be used as the presets when new signals are input. The data will be saved for all items in the PICTURE menu except for the SYSTEM SELECTOR setting.

You can adjust pictures to suit your preference.

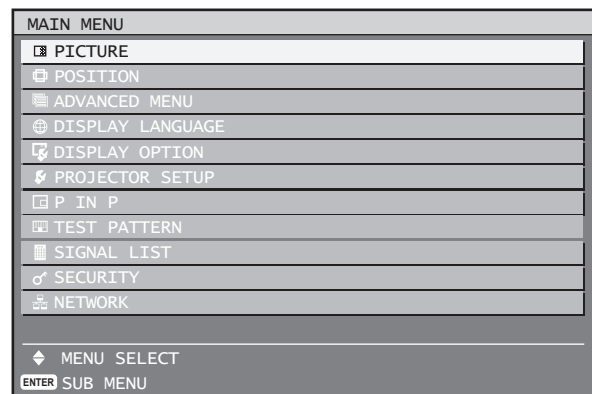
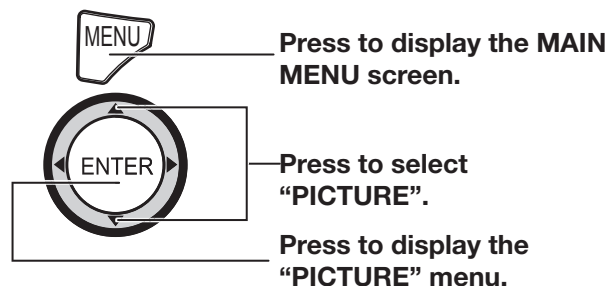

- Some menu items may not be valid for certain signal formats applied to the projector.

Adjusting Contrast

Adjusts the Contrast (white level).

1. Press **▲▼** to select “**CONTRAST**”.

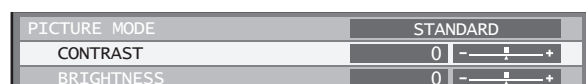

2. Press ◀▶ or ENTER.

- The “CONTRAST” individual adjustment screen will be displayed.



3. Press ◀▶ to adjust the level.

Operation	Adjustment	Adjustment range
Press ▶ button.	Raises the picture brightness and the picture becomes clearer.	Maximum value 31
Press ◀ button.	Lowers the picture brightness and weakens the picture.	Minimum value -31

Attention

- If you need to adjust the “BRIGHTNESS”, it should be adjusted before other adjustments are made.

Adjusting Brightness

Adjusts the brightness (black level) of the picture.

1. Press ▲▼ to select “BRIGHTNESS”.



2. Press ◀▶ or ENTER.

- The “BRIGHTNESS” individual adjustment screen will be displayed.



3. Press ◀▶ to adjust the level.

Operation	Adjustment	Adjustment range
Press ▶ button.	Increases the brightness of the dark (black) parts of the screen.	Maximum value 31
Press ◀ button.	Reduces the brightness of the dark (black) parts of the screen.	Minimum value -31

Adjusting Color

This adjusts the depth of the colors.

1. Press ▲▼ to select “COLOR”.



2. Press ◀▶ or ENTER.

- The “COLOR” individual adjustment screen will be displayed.



3. Press ◀▶ to adjust the level.

Operation	Adjustment	Adjustment range
Press ▶ button.	Deepens colors.	Maximum value 50
Press ◀ button.	Weakens colors.	Minimum value -50

Adjusting Tint

This adjusts skin tones in the pictures.

1. Press ▲▼ to select “TINT”.



2. Press ◀▶ or ENTER.

- The “TINT” individual adjustment screen will be displayed.

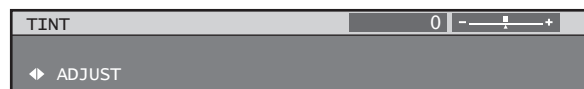

3. Press ◀▶ to adjust the level.

Operation	Adjustment	Adjustment range
Press ▶ button.	Adjusts skin tone toward reddish-purple.	Maximum value 31
Press ◀ button.	Adjusts skin tone toward greenish color.	Minimum value -31

Adjusting the color temperature

Used to set the projector’s white point. Three presets and two user-definable modes are available. A colorimeter should be used if available.

- Carry out this adjustment while the signals to be adjusted are being projected.

1. Press ▲▼ to select “COLOR TEMPERATURE”.



2. Press ◀▶ or ENTER.

- The “COLOR TEMPERATURE” individual adjustment screen will be displayed.



Adjusting the picture (continued)

3. Press ◀▶ to switch “COLOR TEMPERATURE”.

- The setting will change as follows each time ◀▶ is pressed.

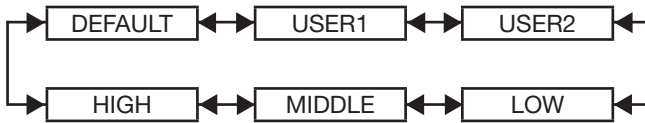

- When any setting other than “OFF” has been selected for color matching, the COLOR TEMPERATURE setting is fixed at “USER1”.
- “DEFAULT” cannot be selected when the picture mode has been set to “USER”.

■ To further adjust toward the desired white balance

4. Select “USER1” or “USER2” in Step 3.

5. Press ENTER.

- The “WHITE BALANCE” screen will be displayed.



6. Press ▲▼ to select “WHITE BALANCE HIGH” or “WHITE BALANCE LOW”.

7. Press ENTER.

- The “WHITE BALANCE HIGH” RGB settings are used to set the projector’s white point color temperature. The “WHITE BALANCE LOW” RGB settings are used to adjust the color temperature of the black levels.

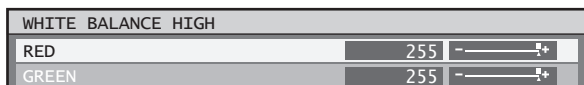

8. Press ▲▼ to select “RED”, “GREEN” or “BLUE”.

9. Press ◀▶ to adjust the level.

Item	Operation	Adjustment	Adjustment range
RED	Press ▶ button.	Deepens red.	Maximum value HIGH : 255 LOW : 127
	Press ◀ button.	Weakens red.	
GREEN	Press ▶ button.	Deepens green.	Minimum value HIGH : 0 LOW : -127
	Press ◀ button.	Weakens green.	
BLUE	Press ▶ button.	Deepens blue.	Default HIGH : 255 LOW : 0
	Press ◀ button.	Weakens blue.	

Note

- All colors will not be displayed properly unless adequate adjustment is made. If the adjustment does not look suitable, you can press DEFAULT to return the setting for the selected item only to the factory default setting.
- The color temperature cannot be adjusted for the internal test pattern (p. 87). Be sure to project the input signal when adjusting the color temperature.

Gamma setting

This switches the gamma mode.

1. Press ▲▼ to select “GAMMA”.



2. Press ◀▶ or ENTER.

- The “GAMMA” individual adjustment screen will be displayed.



3. Press ◀▶ to switch “GAMMA”.

- The setting will change as follows each time ◀▶ is pressed.

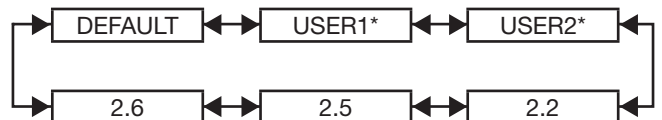

- * “USER1” and “USER2” can hold user-defined gamma curves uploaded to the projector through the RS-232 terminal. Additional Gamma settings can be made available for selection from a sub-menu. Consult your dealer for more information.

Note

- “DEFAULT” cannot be selected when the picture mode has been set to “USER”.

System daylight view setting

This corrects images so that they appear vivid when projected under bright lighting.

1. Press ▲▼ to select “SYSTEM DAYLIGHT VIEW”.



2. Press ◀▶ or ENTER.

- The “SYSTEM DAYLIGHT VIEW” individual adjustment screen will be displayed.



3. Press ◀▶ to switch “SYSTEM DAYLIGHT VIEW”.

- The setting will change as follows each time ◀▶ is pressed.

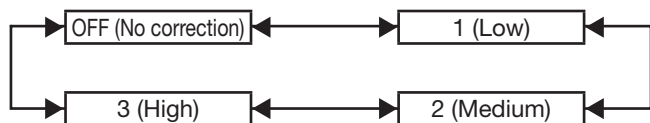

3. Press ◀▶ to switch “NOISE REDUCTION”.

- The setting will change as follows each time ◀▶ is pressed.

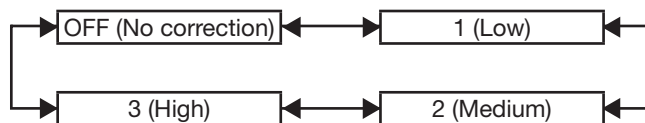

Sharpness setting

This adjusts the sharpness of the pictures.

1. Press ▲▼ to select “SHARPNESS”.



2. Press ◀▶ or ENTER.

- The “SHARPNESS” individual adjustment screen will be displayed.



3. Press ◀▶ to adjust the level.

Operation	Adjustment	Adjustment range
Press ▶ button.	Contours become sharper.	0 to 15
Press ◀ button.	Contours become softer.	

Note

- The possible setting range will vary depending on the input signal.

Noise reduction setting

This can be used to adjust pictures if they contain interference as a result of poor quality of the input signal.

1. Press ▲▼ to select “NOISE REDUCTION”.



2. Press ◀▶ or ENTER.

- The “NOISE REDUCTION” individual adjustment screen will be displayed.



Note

- When “FRAME DELAY” is set to “SHORT”, the noise reduction setting function cannot be used.

Dynamic iris setting

Pictures with the optimum contrast will be displayed by automatically providing aperture compensation and signal compensation to suit the pictures concerned.

1. Press ▲▼ to select “DYNAMIC IRIS”.



2. Press ◀▶ or ENTER.

- The “DYNAMIC IRIS” individual adjustment screen will be displayed.



3. Press ◀▶ to switch “DYNAMIC IRIS”.

- The setting will change as follows each time ◀▶ is pressed.



■ To further adjust the selected compensation amount

4. Select “USER” in step 3.

5. Press ENTER.

- The “DYNAMIC IRIS” screen will be displayed.



6. Use ▲▼ to select the item to be adjusted, and then use ◀▶ to adjust the amount of correction.

Adjusting the picture (continued)

AUTO IRIS (Automatic aperture adjustment)

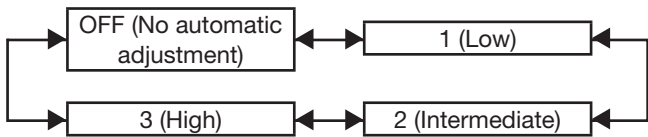

MANUAL IRIS (Fixed aperture adjustment)

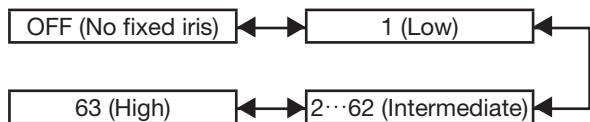

DYNAMIC GAMMA (signal compensation amount adjustment)

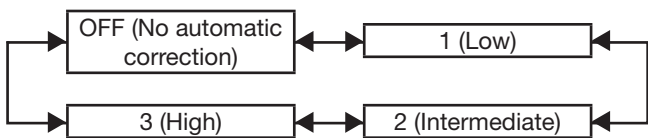

Note

- The contrast is set to the maximum level when “DYNAMIC IRIS” is set to “3”.

Registering the picture mode settings as presettings

The picture settings that have been made in the PICTURE MODE screen can be registered.

- Select “PICTURE MODE” in the “PICTURE” screen to carry out this operation.

1. Press ENTER.

- A confirmation screen will appear.

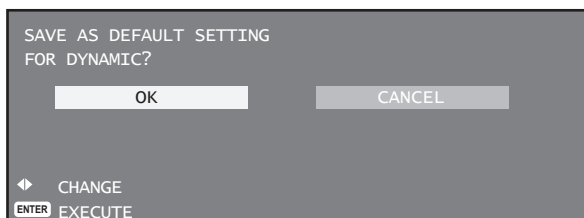

2. Press ◀▶ to select “OK”.

3. Press ENTER.

Note

- If the registered picture mode is selected after registering the picture mode settings as presettings, the new signals will be displayed with the registered adjustments.

Setting the system selector

This enables the projector to automatically recognize input signals. Furthermore, if unstable signals are input, the system format can be selected manually.

1. Press ▲▼ to select “SYSTEM SELECTOR”.



2. Press ENTER.

- The “SYSTEM SELECTOR” screen will be displayed.

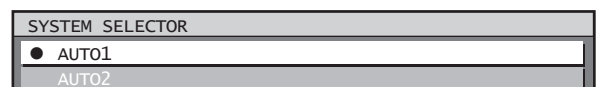

3. Press ▲▼ to switch “SYSTEM SELECTOR”, and then press ENTER.

- The system formats that can be selected differ depending on the input signals.

S-video / Video terminal input signal

Select from AUTO1, AUTO2, NTSC, NTSC4.43, PAL, PALM, PAL-N, SECAM, and PAL60.

Note

- Press the DEFAULT button to return to “AUTO1”.
- “AUTO1” automatically selects from NTSC, PAL, SECAM, NTSC4.43, and PAL60. “AUTO2” automatically selects from NTSC, PAL-M, and PAL-N.

RGB1 / RGB2 / DVI-D terminal input signal

Select from RGB and YPbPr.

Note

- Refer to the types of signals compatible with the projector. (pp. 122-123)

Input module

ET-MD77SD1:

Select from AUTO, 480i and 576i.

ET-MD77SD3:

Select from AUTO, 1 080/60i, 1 035/60i, 720/60p, 1 080/24p, 1 080/50i, 1 080/30p, 1 080/25p, 1 080/24sF, 720/50p, and 480i, 576i.

ET-MD100SD4:

When single link SDI signals

Select from AUTO YCbCr, 1 080/60i, 1 035/60i, 720/60p, 1 080/24p, 1 080/50i, 1 080/30p, 1 080/25p, 1 080/24sF, 720/50p, 480i, and 576i.

When dual link SDI signals

Select from AUTO RGB, AUTO X'Y'Z', 1 920/24p/RGB, 2 048/24p/RGB, 2 048/24p/XYZ, 1 920/24sF/RGB, 2 048/24sF/RGB, 2 048/24sF/XYZ, 1 920/25p/RGB, 1 920/30p/RGB, 1 920/50i/RGB, and 1 920/60i/RGB.

Note

- Press the DEFAULT button to return to AUTO YCbCr or AUTO RGB.
- “AUTO RGB” automatically selects from 1 920/24p/RGB, 2 048/24p/RGB, 1 920/24sF/RGB, 2 048/24sF/RGB, 1 920/25p/RGB, 1 920/30p/RGB, 1 920/50i/RGB, and 1 920/60i/RGB. “AUTO X'Y'Z” automatically selects from 2 048/24p/XYZ and 2 048/24sF/XYZ.

To display pictures complying with the sRGB standard

sRGB is the international color reproduction standard (IEC61966-2-1) established by IEC (International Electrotechnical Commission).

To reproduce colors more faithfully in compliance with the sRGB standard, perform the following setting procedure.

1. Set **“COLOR MATCHING”** adjustment to **“OFF”**. (p. 70)
2. Display the **“PICTURE”** screen. (p. 54)
3. Press **▲ ▼** to select **“PICTURE MODE”**.

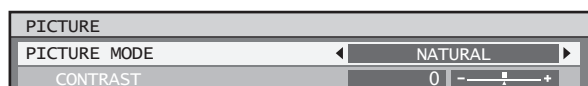

4. Press **◀ ▶** to select **“NATURAL”**.
5. Press **▲ ▼** to select **“COLOR”**.



6. Press **DEFAULT** on the remote control to restore the factory default.

7. Follow the same procedure (steps 5-6) to restore the factory default for **“TINT”**, **“COLOR TEMPERATURE”** and **“GAMMA”**.

Note

- sRGB is only enable when RGB signals are being input.

Adjusting the position

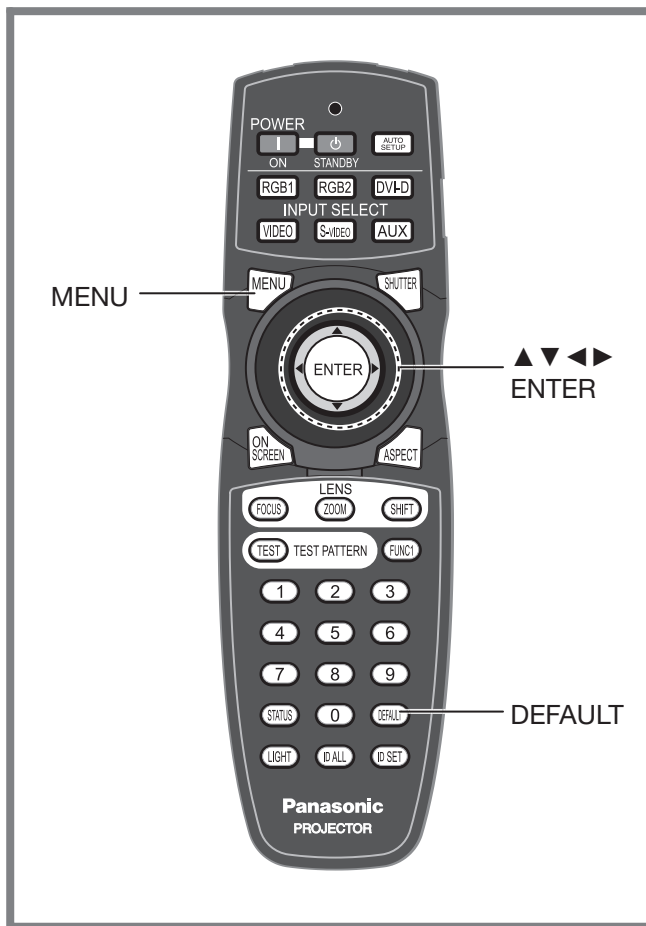

Shift adjustment

This function allows the user to adjust the raster position vertically or horizontally if the position of the image projected on the screen is displaced even when the projector is properly aligned with the screen, and the internal test patterns are correctly framed.

1. Press ▲▼ to select “SHIFT”.

POSITION	
SHIFT	
ASPECT	DEFAULT

2. Press ENTER.

- The “SHIFT” screen will be displayed.

SHIFT	
V	12
H	212

3. Press ▲▼◀▶ to adjust the position.

- For horizontal (right and left) adjustment

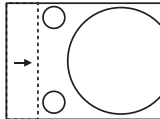
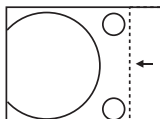
Operation	Adjustment
Press ► button.	The picture position moves to the right. 
Press ◀ button.	The picture position moves to the left. 

- For vertical (up and down) adjustment

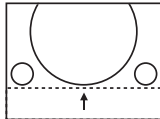
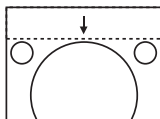
Operation	Adjustment
Press ▲ button.	The picture position moves up. 
Press ▼ button.	The picture position moves down. 

4. Press MENU three times.

- The on-screen indications disappear and the normal screen appears again.

You can adjust the position as required.

MENU — Press to display the MAIN MENU screen.

ENTER — Press to select “POSITION”.

ENTER — Press to display the “POSITION” menu.

MAIN MENU	
PICTURE	
POSITION	
ADVANCED MENU	
DISPLAY LANGUAGE	
DISPLAY OPTION	
PROJECTOR SETUP	
P IN P	
TEST PATTERN	
SIGNAL LIST	
SECURITY	
NETWORK	
MENU SELECT	
ENTER	SUB MENU

Adjusting the aspect ratio

This changes the aspect ratio of the projected image. This changes the aspect ratio for the screen range selected with "SCREEN SETTING". Set "SCREEN SETTING" first. (p. 72)

1. Press ▲ ▼ to select "ASPECT".



2. Press ◀ ▶ or ENTER.

- The "ASPECT" individual adjustment screen will be displayed.



3. Press ◀ ▶ to switch "ASPECT".

- The setting will change as follows each time ◀ ▶ is pressed.

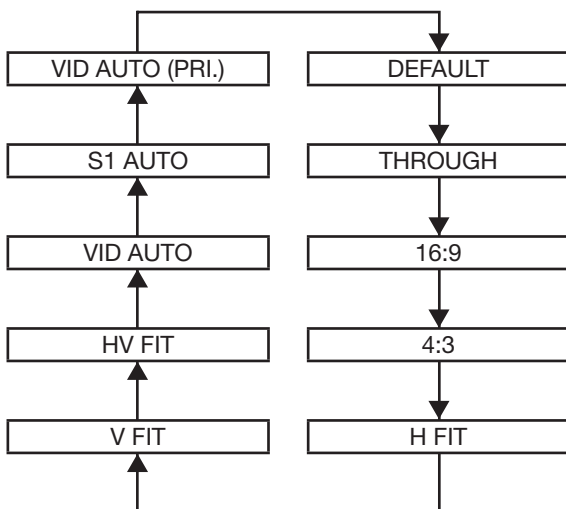

- DEFAULT:** Pictures are displayed without changing the aspect ratio of the input signals.
- THROUGH:** Pictures are displayed without changing the resolution of the input signals.
- 16:9:** When standard signals^{*1} are input, the pictures are displayed with the aspect ratio converted to 16:9. When wide signals are input^{*2}, the pictures are displayed without changing the aspect ratio.
- 4:3:** When standard signals are input^{*1}, the pictures are displayed without changing the aspect ratio. When wide signals are input^{*2}, the PT-D12000U displays pictures with the aspect ratio converted to 4:3. The PT-DZ12000U displays pictures reduced to fit a 4:3 screen without changing the input aspect ratio.
- H FIT:** The display will use the full width of the screen range selected with "SCREEN SETTING". When signals have a vertical aspect ratio that is larger than the screen aspect selected with "SCREEN SETTING", the pictures will be displayed with their bottom areas cut off.

- V FIT:**

The display will use the full height of the screen range selected with "SCREEN SETTING".

- HV FIT:**

The pictures are displayed in the full screen range selected with "SCREEN SETTING". If the aspect ratios of the input signals and screen range differ, conversion to the screen aspect set with "SCREEN SETTING" is performed and then the pictures are displayed.

- VID AUTO:**

The projector identifies the video ID (VID) embedded in the picture signals and displays the picture by automatically switching the screen sizes between 4:3 and 16:9. This function is effective for the NTSC signal input.

- S1 AUTO:**

The projector identifies the S1 signal and displays the picture by automatically switching the screen sizes between 4:3 and 16:9. This function is effective for S-Video NTSC signals.

- VID AUTO (PRI.):**

The projector identifies the abovementioned VID or S1 signals and displays the picture by automatically choosing the screen sizes of 4:3 or 16:9 according to the VID if it is detected or S1 signals if a VID is not detected. This function is effective for S-Video NTSC signals.

*1: Standard signals are input signals with an aspect ratio of 4:3 or 5:4.

*2: Wide-screen signals are input signals with an aspect ratio of 16:10, 16:9, 15:9 or 15:10.

Note

- Some size modes are not available for certain types of input signals. For NTSC signals, "DEFAULT" cannot be selected.
- If an aspect ratio which is different from the aspect ratio for the input signals is selected, the pictures will appear differently from the originals. Be careful of this when selecting the aspect ratio.
- If using this projector in places such as cafes or hotels to display programmes for a commercial purpose or for public presentation, note that adjusting the aspect ratio or using the zoom function to change the screen pictures may be an infringement of the rights of the original copyright owner for that programme under copyright protection laws.
- If conventional (normal) 4:3 pictures which are not wide-screen pictures are displayed on a wide screen, the edges of the pictures may not be visible or they may become distorted. Such pictures should be viewed as with an aspect ratio of 4:3 in the original format intended by the creator of the pictures.

Adjusting the position (continued)

Adjusting the zoom ratio

This adjusts the size of the projected pictures.

1. Press ▲ ▼ to select “ZOOM”.



2. Press ENTER.

- The “ZOOM” screen will be displayed.

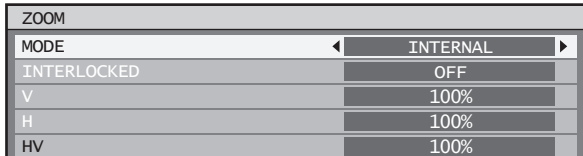

3. Press ▲ ▼ to select “MODE”.

4. Press ◀ ▶ to switch “MODE”.

- The setting will change as follows each time ◀ ▶ is pressed.



- **INTERNAL:**
Enlarges the size of the pictures to within the default aspect ratio.
- **FULL:**
Enlarges the size of the pictures using the whole of the display area selected with “SCREEN FORMAT”.

5. Press ▲ ▼ to select “INTERLOCKED”.

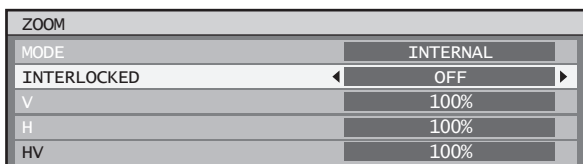

6. Press ◀ ▶ to switch “INTERLOCKED”.

- The setting will change as follows each time ◀ ▶ is pressed.



- **OFF :**
The “V” and “H” settings are used as the vertical and horizontal zoom ratios respectively.
- **ON :**
The zoom ratio is set to the “HV” setting. This allows the pictures to be zoomed at equal vertical and horizontal ratios.

Note

- When “ASPECT” is set to “THROUGH”, “ZOOM” will not appear.
- When other than “DEFAULT” is selected for “ASPECT”, the “MODE” selection setting will not appear.

Clock phase adjustment

Clock phase adjustment achieves the best image when the screen flickers or halos are observed around contours.

1. Press ▲ ▼ to select “CLOCK PHASE”.

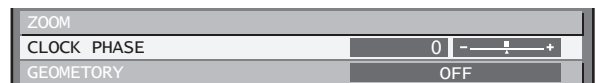

2. Press ◀ ▶ or ENTER.

- The “CLOCK PHASE” individual adjustment screen will be displayed.



3. Press ◀ ▶ to adjust the level.

- The value changes from 0 to 31. Adjust so that the amount of interference is at a minimum.

Note

- No optimal value may be obtained if the output of the PC to which the signal input is applied is unstable.
- No optimal value may be obtained if the total number of dots is not correct.
- The clock phase can be adjusted only when RGB signal input is applied with RGB1 and RGB2 IN.

Adjusting the geometry

Square video can be projected onto a special shaped screen using unique image processing technology.

1. Press ▲ ▼ to select “GEOMETRY”.



2. Press ◀ ▶ to switch “GEOMETRY”.

- The setting will change as follows each time ◀ ▶ is pressed.

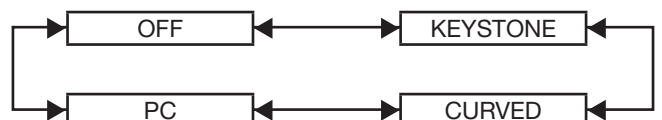

- **OFF:**
Geometry correction is not performed.
- **KEYSTONE:**
This adjusts projected images when they are distorted to a trapezoid.
- **CURVED:**
This adjusts projected images when they are distorted to a curved surface.
- **PC:**
This is for performing geometry correction from a PC.

3. Select “KEYSTONE” or “CURVED” in Step 2, and then press ENTER.

- The “GEOMETRY:KEYSTONE” or “GEOMETRY:CURVED” screen will be displayed.

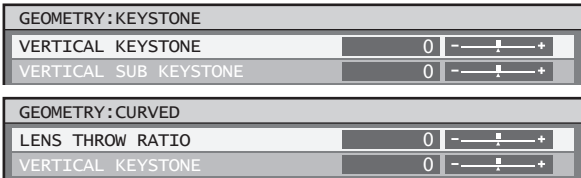

4. Press ▲ ▼ to select the desired adjustment item, and press ◀ ▶ to adjust the correction amount.

- You can adjust the projection images as shown below.

KEYSTONE menu:

- VERTICAL KEYSTONE

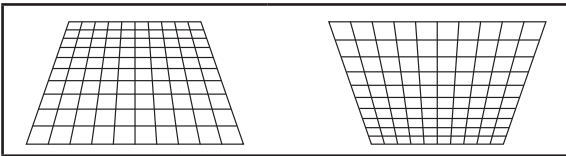

- VERTICAL SUB KEYSTONE

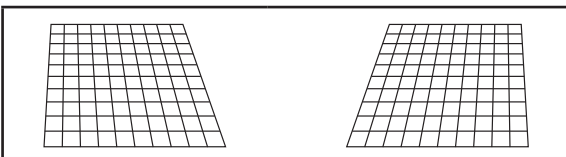

- HORIZONTAL KEYSTONE

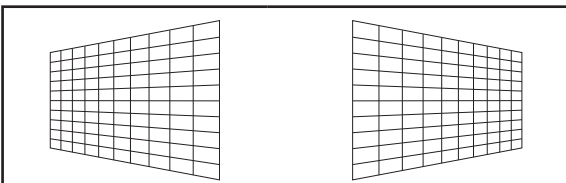

- HORIZONTAL SUB KEYSTONE

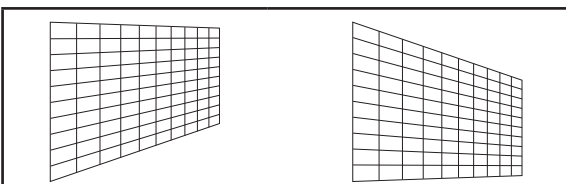

- LINEARITY

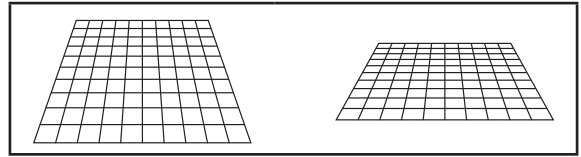

CURVED menu:

- LENS THROW RATIO
Set to the throw ratio being used (the projection distance divided by the screen width). (pp. 22-24)
- VERTICAL KEYSTONE

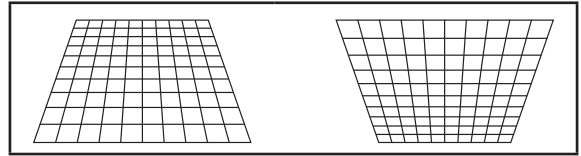

- HORIZONTAL KEYSTONE

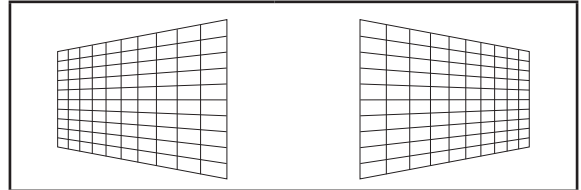

- VERTICAL ARC

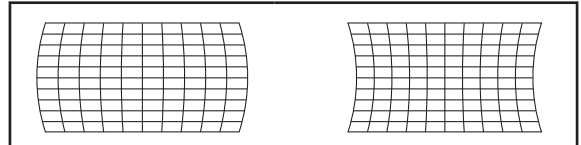

- HORIZONTAL ARC

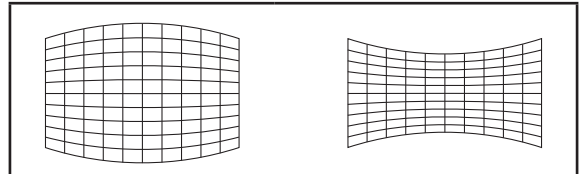

- VERTICAL BALANCE

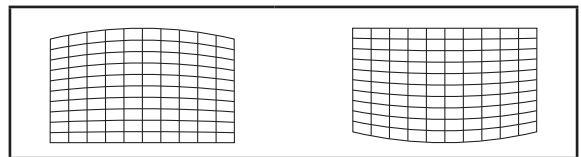

- HORIZONTAL BALANCE

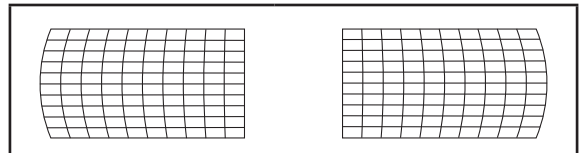



Note

- If vertical keystone correction is set, menus and logos may be projected outside of the actual image area.
- If both edge blending adjustment and geometry correction are used, set the geometry correction to curved-surface correction or PC. If geometry correction is set to keystone-distortion correction, edge blending adjustment cannot be made correctly. (p. 66)

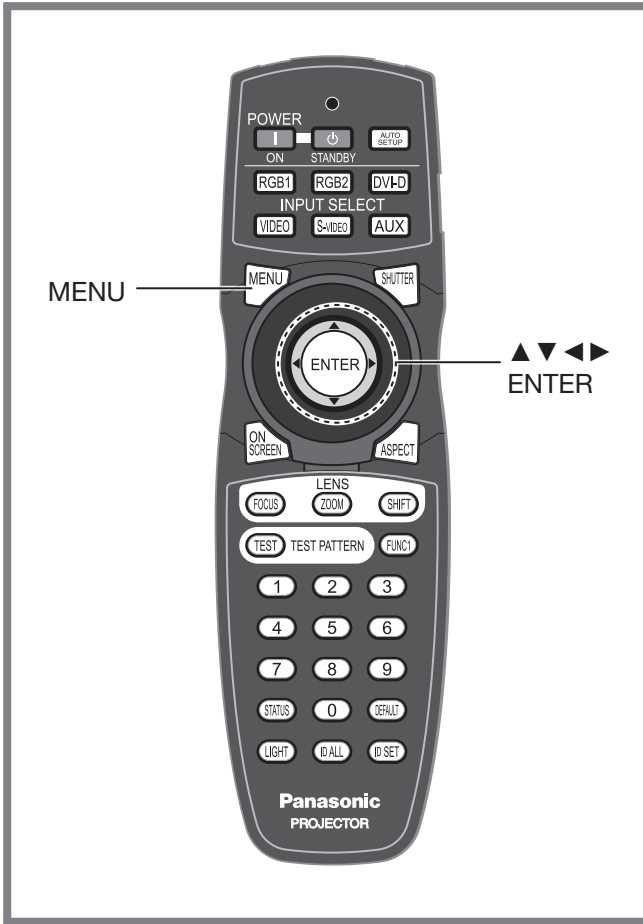
How to use ADVANCED MENU



Fine settings are possible.

-  Press to display the **MAIN MENU** screen.
-  Press to select **"ADVANCED MENU"**.
-  Press to display the **"ADVANCED MENU" menu**.

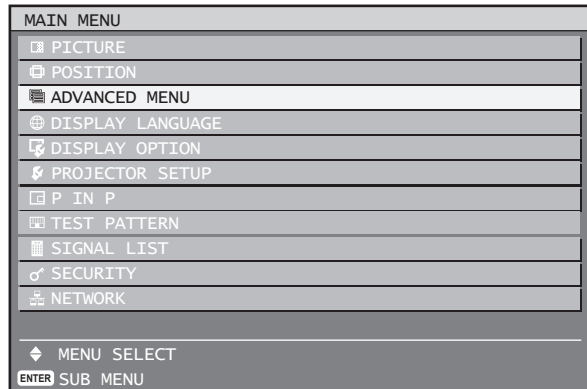

Digital cinema reality

Increase the vertical resolution when the PAL (or SECAM) 576i signal input or the NTSC 480i, 1 080/50i and 1 080/60i signal input is applied.

1. Press ▲▼ to select "DIGITAL CINEMA REALITY".



2. Press ◀▶ or ENTER.

- The "DIGITAL CINEMA REALITY" individual adjustment screen will be displayed.



3. Press ◀▶ to switch "DIGITAL CINEMA REALITY".

- The setting will change as follows each time ◀▶ is pressed.

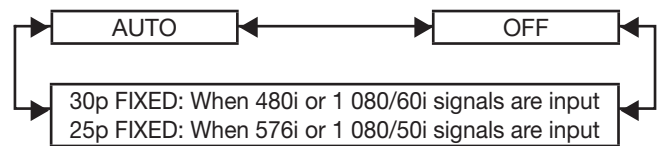

- **AUTO:**
Performs automatic detection and cinema processing. (factory default)
- **OFF:**
Unforced cinema processing
- **25p FIXED:**
Forced cinema processing (2:2 pulldown) is performed when a 576i or 1 080/50i signal is input.
- **30p FIXED:**
Forced cinema processing (2:2 pulldown) is performed when a 480i or 1 080/60i signal is input.

Note

- In DIGITAL CINEMA REALITY mode, the image quality will be deteriorated if 30p FIXED or 25p FIXED is selected when the signal is not a 2:2 pulldown signal.

Blanking adjustment

Blanking adjustment fine-tunes the images projected by the video deck or other devices when the noise appears on the edges of the screen or if a part of the image lies slightly offscreen.

1. Press ▲▼ to select "BLANKING".

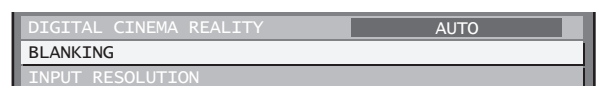

2. Press ENTER.

- The "BLANKING" adjustment screen will be displayed.



3. Press ▲ ▼ to select the desired item for adjustment.

4. Press ◀ ▶ to adjust blanking.

- The adjustment value for the PT-D12000U can be changed within a range of 0 to 525 vertically and 0 to 700 horizontally.
- The adjustment value for the PT-DZ12000U can be changed within a range of 0 to 600 vertically and 0 to 960 horizontally.

When correcting the upper blanking of the screen (top)	
Press ◀ button to move the blanking zone upward; ▶ button to downward.	
When correcting the lower blanking of the screen (bottom)	
Press ▶ button to move the blanking zone upward; ◀ button to downward.	
When correcting the left hand blanking of the screen (left)	
Press ▶ button to move the blanking zone to the right; ◀ button to the left.	
When correcting the right hand blanking of the screen (right)	
Press ◀ button to move the blanking zone to the right; ▶ button to the left.	

Adjusting the input resolution

Input resolution adjustment achieves the best image when the screen flickers or halo is observed around the contour. Set the values appropriately for the signal resolution that is being used.

1. Press ▲ ▼ to select "INPUT RESOLUTION".



2. Press ENTER.

- The "INPUT RESOLUTION" screen will be displayed.

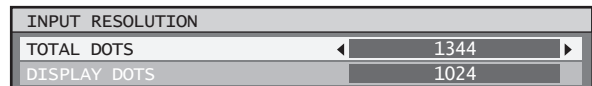

3. Press ▲ ▼ to select "TOTAL DOTS", "DISPLAY DOTS", "TOTAL LINES" or "DISPLAY LINES", and the press ◀ ▶ to adjust it.

- Each item automatically displays a value in response to the type of the input signal. If vertical stripes appear on the screen or the image is partly missing, increase or decrease the displayed value while observing the screen to achieve the optimal value.

Note

- The abovementioned vertical stripes will not appear on the screen when all signals are input.
- The picture may be distorted during the adjusting operation, but this is not a fault.
- The input resolution can be adjusted only when RGB signal input is applied with RGB1 and RGB2 IN.

Adjusting the clamp position

Use the clamp position adjustment to achieve the optimal value when dark areas of the image are crushed or displayed in green.

1. Press ▲ ▼ to select "CLAMP POSITION".

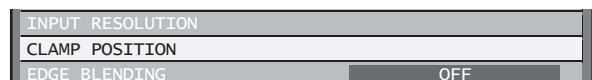

How to use ADVANCED MENU (continued)

2. Press ENTER.

- The “CLAMP POSITION” screen will be displayed.



3. Press ◀▶ to adjust.

- The value changes from 0 to 255.
- The optimal value for the clamp position adjustment**
If dark areas are crushed:
The optimal value is the point where the dark area is best improved.
If the dark areas are displayed in green:
The optimal value is the point where the green areas become black and the crushing effect is rectified.

Note

- The clamp position can be adjusted only when the RGB signal input is applied with RGB1 and RGB2 IN.

Edge blending adjustment

The built-in edge blending feature allows multiple projector images to be seamlessly overlapped.

1. Press ▲▼ to select “EDGE BLENDING”.

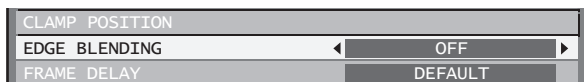

2. Press ◀▶ to switch “EDGE BLENDING”.

- The setting will change as follows each time ◀▶ is pressed.

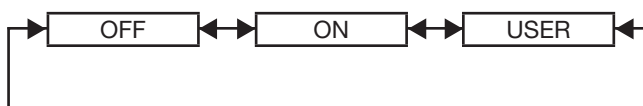

- OFF:**
When the multi-screens are not going to be used.
- ON:**
When the default linear blending ramps are sufficient.
- USER:**
When a user-defined blending ramp is required. These ramps can be defined and uploaded to the projector through the RS-232 port. Consult your dealer for details.

3. Press ENTER.

- The “EDGE BLENDING” screen will be displayed.



4. Press ▲▼ to specify the area to be adjusted.

- To blend the top edge: set “UPPER” to “ON”.
- To blend the bottom edge: set “LOWER” to “ON”.
- To blend the left edge: set “LEFT” to “ON”.
- To blend the right edge: set “RIGHT” to “ON”.

5. Press ◀▶ to toggle “ON” and “OFF”.

6. Press ◀▶ to adjust the overlap width and the starting point.

■ To display the adjustment marker

7. Press ▲▼ to select “MARKER”.



8. Press ◀▶ to select “ON”.

- A marker for adjusting the overlap position appears. The optimal point is the position where the red line of one frame overlaps the green line of the other frame. The blending widths of each projector must be set to the same value. Optimal blending cannot be achieved if the widths are different.

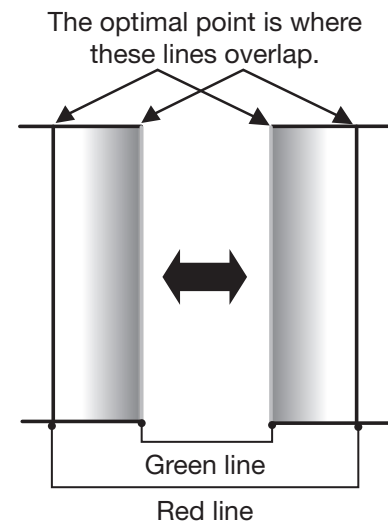

9. Press ▲▼ to select “BRIGHT ADJUST”.



10. Press ENTER.

- The “BRIGHT ADJUST” screen will be displayed.

BRIGHT ADJUST	
BRIGHT INSIDE	
BRIGHT OUTSIDE	

11. Press ▲▼ to select “BRIGHT INSIDE”.

12. Press ENTER.

- The “BRIGHT INSIDE” adjustment screen will be displayed.

BRIGHT INSIDE	
INTERLOCKED	ON
WHITE	0
RED	0
GREEN	0
BLUE	0

- When “INTERLOCKED” is set to “OFF”, individual adjustment of “RED”, “GREEN” and “BLUE” will be possible.

13. Press ▲▼ to select an item, and press ◀▶ to adjust the setting.

- Once adjustment is complete, press MENU to return to “BRIGHT ADJUST”.

14. Press ▲▼ to select the part of “UPPER”, “LOWER”, “RIGHT”, “LEFT”.

15. Use ◀▶ to adjust the width for correcting the “BRIGHT INSIDE” setting (0 to 255).

16. Press ▲▼ to select “BRIGHT OUTSIDE”.

BRIGHT INSIDE	
BRIGHT OUTSIDE	
OUTSIDE AREA	

17. Press ENTER.

- The “BRIGHT OUTSIDE” adjustment screen will be displayed.

BRIGHT OUTSIDE	
INTERLOCKED	ON
WHITE	0
RED	0
GREEN	0
BLUE	0

- When “INTERLOCKED” is set to “OFF”, individual adjustment of “RED”, “GREEN” and “BLUE” will be possible.

18. Press ▲▼ to select an item, and press ◀▶ to adjust the setting.

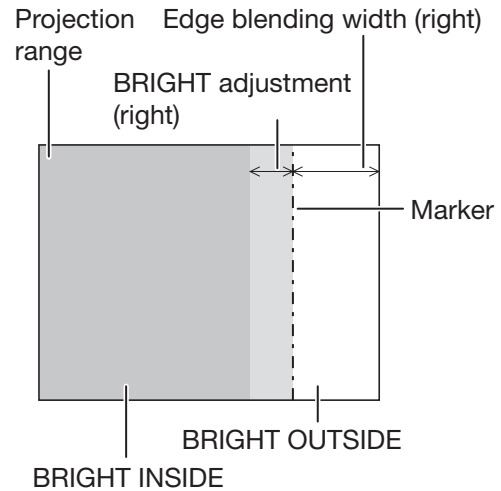

Note

- The Bright Inside adjustments are used to match the projector’s main-screen-area black levels to the level within the blended area. The Bright Outside adjustments may be used to fine adjust the thin borders on either side of the blend area, but are often not needed.
- When a rear screen or screen with a high gain is used, the blended areas may appear to be discontinuous depending on the viewing position.

Frame delay

When 1 080/60i, 1 080/50i and 1 080/24sF signals are being input, this simplifies image processing so that the video frame delay is shortened.

1. Press ▲▼ to select “FRAME DELAY”.

EDGE BLENDING	OFF
FRAME DELAY	DEFAULT
RASTER POSITION	

How to use ADVANCED MENU (continued)

2. Press ◀▶ to switch “FRAME DELAY”.

- The setting will change as follows each time ◀▶ is pressed.

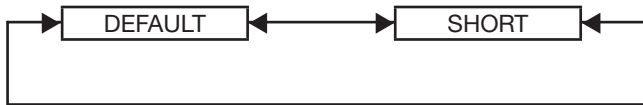

• DEFAULT:

This is the standard setting.

• SHORT:

Shortens the delay at the expense of some picture quality.

Note

- When “FRAME DELAY” is set to “SHORT”, deterioration in the picture quality will occur. Furthermore, the noise reduction function cannot be used.

Raster position

When the scaler is set such that the image is smaller than the display area, the image can be moved to any position inside the display area.

1. Press ▲▼ to select “RASTER POSITION”.

EDGE BLENDING	OFF
FRAME DELAY	DEFAULT
RASTER POSITION	

2. Press ENTER.

- The “RASTER POSITION” screen will be displayed.

RASTER POSITION	
V	0
H	0

3. Press ▲▼◀▶ to adjust the position.

■ PT-D12000U

When 5:4 pictures are displayed (when SXGA signals are input)	
Pressing ▶ button will move the image to the right.	
Pressing ◀ button will move the image to the left.	

When 16:9 pictures are displayed (when HDTV or 480p pictures are input or 16:9 is selected in the SIZE mode)

Pressing ▲ button will move the image upward.

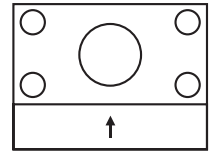

Pressing ▼ button will move the image downward.

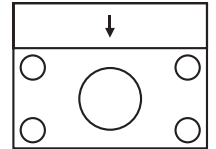

■ PT-DZ12000U

When 4:3 pictures are displayed

Pressing ▶ button will move the image to the right.

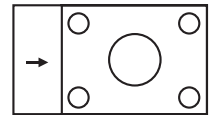

Pressing ◀ button will move the image to the left.

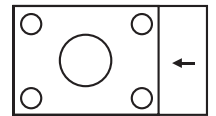

4. Press MENU three times.

- The on-screen indications disappear and the normal screen appears again.

Setting the DISPLAY LANGUAGE

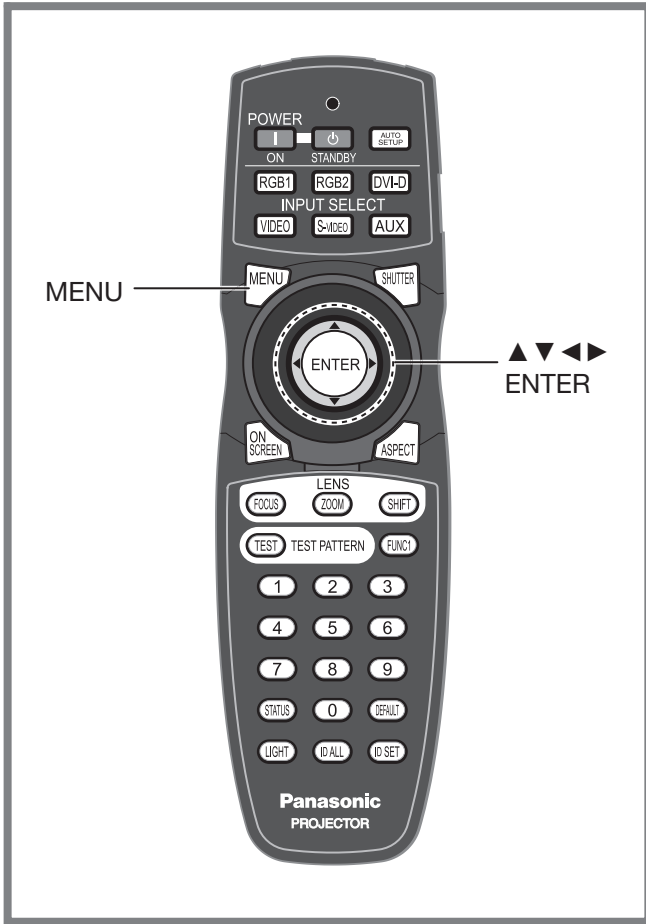

Changing the display language

This lets you switch the on-screen display language.

1. Press ▲ ▼ to select the desired language.

DISPLAY LANGUAGE	
●	ENGLISH
	DEUTSCH
	FRANÇAIS
	ESPAÑOL
	ITALIANO
	日本語
	中文
	РУССКИЙ
	한국어

2. Press ENTER to establish your selection.

- Menus, setting items, adjustment screens, and control button names will be displayed in the language the user chooses.
- The available languages are: English, German (DEUTSCH), French (FRANÇAIS), Spanish (ESPAÑOL), Italian (ITALIANO), Japanese (日本語), Chinese (中文), Russian (РУССКИЙ), and Korean (한국어).

Note

- The on-screen display of the projector is set to the English language on shipping.

This lets you switch the display language.

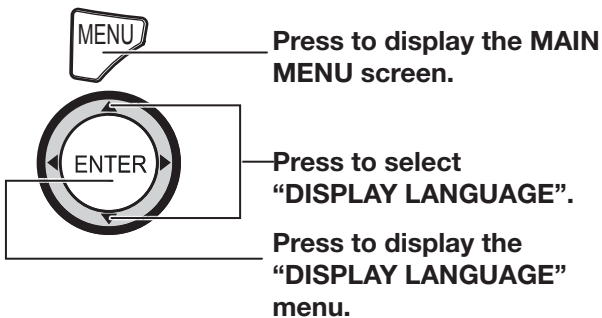

MAIN MENU	
□	PICTURE
⊕	POSITION
≡	ADVANCED MENU
⊕	DISPLAY LANGUAGE
⊕	DISPLAY OPTION
⚙	PROJECTOR SETUP
□	P IN P
⊕	TEST PATTERN
≡	SIGNAL LIST
♂	SECURITY
⊕	NETWORK
⚡	MENU SELECT
ENTER	SUB MENU

Display Option settings

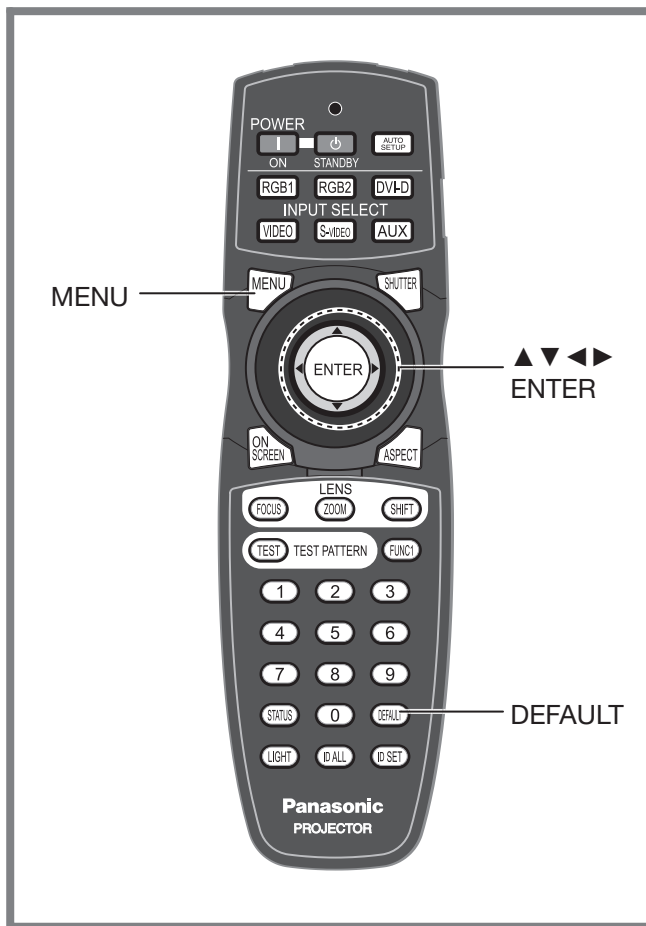

Adjusting color matching

When multiple sets are used simultaneously, this projector allows the user to correct the difference of colors among the sets.

1. Press ▲▼ to select “COLOR MATCHING”.



2. Press ◀▶ to switch “COLOR MATCHING”.

- The setting will change as follows each time ◀▶ is pressed.

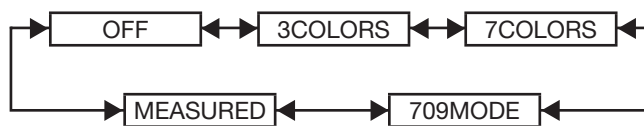

- OFF:** Color matching adjustment is not carried out.
- 3COLORS:** It is possible to adjust the 3colors of “RED”, “GREEN” and “BLUE”.
- 7COLORS:** It is possible to adjust the 7colors of “RED”, “GREEN”, “BLUE”, “CYAN”, “MAGENTA”, “YELLOW” and “WHITE”.
- 709MODE:** Refer to “Adjusting the color matching using a colorimeter” on the next page for details on this mode.
- MEASURED:** Refer to “Adjusting the color matching using a colorimeter” on the next page for details on this mode.

■ If “3COLORS” or “7COLORS” was selected in step 2.

3. Press ENTER.

- The “3COLORS” or “7COLORS” screen will be displayed.



4. Press ▲▼ to select “RED”, “GREEN” and “BLUE” (if “7COLORS” was selected, select “RED”, “GREEN”, “BLUE”, “CYAN”, “MAGENTA”, “YELLOW”, and “WHITE”).

This menu can be used to make a variety of picture and projector settings.

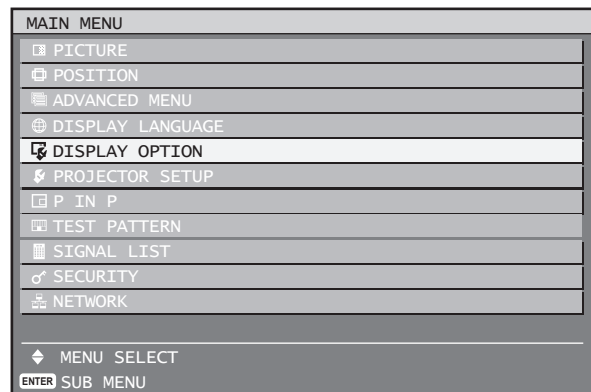
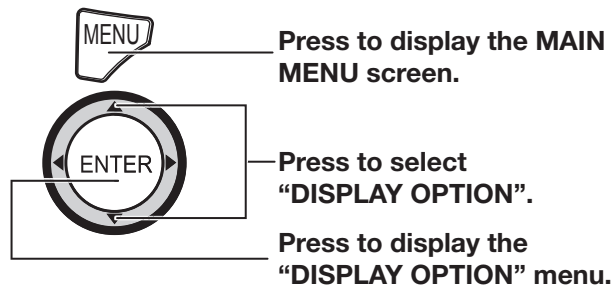

5. Press ENTER.

- The “3COLORS:RED”, “3COLORS:GREEN” or “3COLORS:BLUE” screen will be displayed. If you selected “7COLORS”, the “7COLORS:RED”, “7COLORS:GREEN”, “7COLORS:BLUE”, “7COLORS:CYAN”, “7COLORS:MAGENTA”, “7COLORS:YELLOW”, or “7COLORS:WHITE” screen will be displayed.

3COLORS: RED	
RED	2048
GREEN	0
BLUE	0

6. Press ◀▶ to adjust the values.

- These values can be adjusted from 0 (off) to 2 048 (full gain). The color value being adjusted is added or subtracted from the adjustment color listed at the top of the menu (e.g. 3COLORS: RED)

Note

- The effects of correcting the adjustment color: When tuning the correction color that is the same as the adjustment color: the brightness of the adjustment color changes.
RED: RED is added to or reduced from the adjustment color.
GREEN: GREEN is added to or reduced from the adjustment color.
BLUE: BLUE is added to or reduced from the adjustment color.
- This adjustment should be carried out by a person who is familiar with the projector or by a service person because a high level of skill is required to make successful adjustment.
- Pressing DEFAULT will restore the factory defaults for all items.
- When any setting other than “OFF” has been selected for color matching, the “COLOR TEMPERATURE” setting is fixed at “USER1”.

Adjusting the color matching using a colorimeter

The “RED”, “GREEN”, “BLUE”, “CYAN”, “MAGENTA”, “YELLOW” and “WHITE” colors can be changed to the desired hues using a colorimeter which is capable of measuring the chromaticity coordinates and luminance.

■ Inputting the current luminance and chromaticity coordinates

1. Press ▲▼ to select “COLOR MATCHING”.

DISPLAY OPTION	
COLOR MATCHING	OFF
LARGE SCREEN CORRECTION	OFF

2. Press ◀▶ to select “MEASURED” or “709MODE”.

3. Press ENTER.

- The “MEASURED MODE” screen will be displayed.

MEASURED MODE	
MEASURED DATA	
TARGET DATA	
AUTO TESTPATTERN	ON

4. Press ▲▼ to select “MEASURED DATA”.

5. Press ENTER.

- The “MEASURED DATA” screen will be displayed.

MEASURED DATA		1/2
BLACK	Y(RELATIVE)	1
	x	0.35
	y	0.36
RED	Y(RELATIVE)	1400
	x	0.67
	y	0.33
GREEN	Y(RELATIVE)	5099
	x	0.35
	y	0.63
BLUE	Y(RELATIVE)	500
	x	0.15
	y	0.05

6. Use the colorimeter to measure the luminance (Y) and chromaticity coordinates (x, y) (If the projector is new, these values will not need to be changed).

7. Press ▲▼ to select the colors, and press ◀▶ to select their values.

8. After all the data has been input, press MENU.

- The “MEASURED MODE” screen will be displayed.

MEASURED MODE	
MEASURED DATA	
TARGET DATA	
AUTO TESTPATTERN	ON

■ Inputting the coordinates of a desired color (only “MEASURED”)

9. Press ▲▼ to select “TARGET DATA”.

10. Press ENTER.

- The “TARGET DATA” screen will be displayed.

TARGET DATA		1/2
RED	x	0.64
	y	0.33
GREEN	x	0.3
	y	0.6
BLUE	x	0.15
	y	0.6
CYAN	x	0.225
	y	0.329
MAGENTA	x	0.321
	y	0.154
YELLOW	x	0.419
	y	0.505

Display Option settings (continued)

11. Press ▲▼ to select the desired colors, and press ◀▶ to input their coordinates. The effects can be confirmed on the colorimeter.

12. After all the data has been input, press MENU.

Note

- If “709MODE” has been selected as the “COLOR MATCHING” setting, the 3 primary colors defined by the ITU-R BT.709 standard will be set as the target data.
- If the target data is outside the color range of the projector, the colors will not be projected correctly.

Large Screen Correction

When viewing images close up on a large screen, you can correct the colors that appear lighter on the screen so that they appear the same as the colors that would appear on a normal-sized screen.

1. Press ▲▼ to select “LARGE SCREEN CORRECTION”.

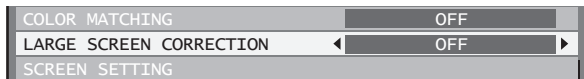

2. Press ◀▶ to switch “LARGE SCREEN CORRECTION”.

- The setting will change as follows each time ◀▶ is pressed.

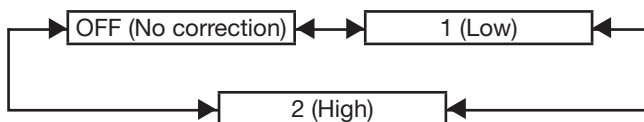

Screen setting

Set this in accordance with the screen you are using. When the projection image aspect ratio is changed, the projector makes corrections to ensure the optimal images for the set screen size.

1. Press ▲▼ to select “SCREEN SETTING”.



2. Press ENTER.

- The “SCREEN SETTING” screen will be displayed.



3. Press ◀▶ to switch “SCREEN FORMAT”.

- The setting will change as follows each time ◀▶ is pressed.

■ PT-DZ12000U



■ PT-D12000U



4. Press ◀▶ to adjust “SCREEN POSITION”.

- In the case of the PT-DZ12000U, you can adjust the setting from -60 to +60. This allows a 16:9 image to be moved up and down within the 16:10 screen.
- In the case of the PT-D12000U, you can adjust the setting from -132 to +131.

Note

- “SCREEN POSITION” cannot be adjusted when “SCREEN FORMAT” is “16:10” (PT-DZ12000U) and “4:3” (PT-D12000U).

RGB IN (Only RGB input)

When unregistered signals are to be input frequently because the unit is used at conferences or other venues, the screen display position can be adjusted automatically without having to press AUTO SETUP on the remote control each time.

Use this setting when adjusting a specific or oblong (16:9, etc.) signal.

1. Press ▲▼ to select “RGB IN”.



2. Press ENTER.

- The “RGB IN” screen will be displayed.



■ AUTO SIGNAL

3. Press ▲▼ to select “AUTO SIGNAL”.

4. Press ◀▶ to switch "AUTO SIGNAL".

- The setting will change as follows each time ◀▶ is pressed.

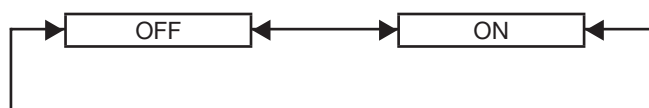

- If unregistered signals are input when "ON" is selected, auto setup will be initiated automatically.

■ AUTO SETUP

5. Press ▲▼ to select "AUTO SETUP".

6. Press ENTER.

- The "AUTO SETUP" screen will be displayed.

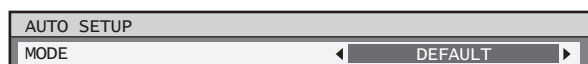

7. Press ◀▶ to switch "MODE".

- The setting will change as follows each time ◀▶ is pressed.

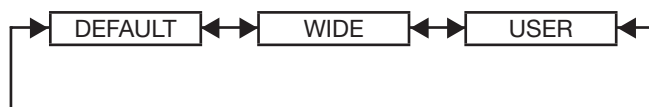

• DEFAULT:

To receive signals of which image aspect is 4:3 or 5:4 (applicable resolution : 640 × 400, 640 × 480, 800 × 600, 832 × 624, 960 × 720, 1 024 × 768, 1 152 × 864, 1 152 × 870, 1 280 × 960, 1 280 × 1 024, 1 600 × 1 200, 1 400 × 1 050)

• WIDE:

To receive signals of which the image aspect is wide (applicable resolution: 720 × 400, 848 × 480, 1 280 × 720, 1 024 × 600, 1 120 × 750, 1 440 × 900, 1 680 × 1 050)

• USER:

To receive signals of specific horizontal resolution (number of horizontally displayed dots)

8. If "User" is selected, press ◀▶ to enter the horizontal resolution of signal source into "DISPLAY DOTS".

9. Press ENTER.

- Execute automatic adjustment. A message "PROGRESS..." appears during automatic adjustment. When the adjustment is complete, the system returns to the input screen.

DVI-D IN

Change this setting if video does not display normally when the projector and an external device are connected via DVI-D.

1. Press ▲▼ to select "DVI-D IN".

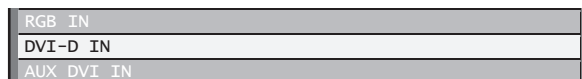

2. Press ENTER.

- The "DVI-D IN" screen will be displayed.



3. Press ◀▶ to switch "DVI EDID".

- The setting will change as follows each time ◀▶ is pressed.

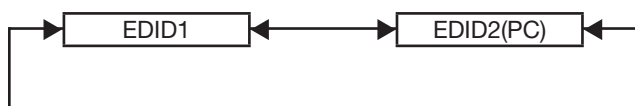

• EDID1 (Input signal formats supported) :

Mainly select this when an external device (DVD player, etc.) for outputting video signals of a moving image system is connected to DVI-D IN.

• EDID2 (Input signal formats supported) :

Mainly use this when an external device (PC, etc.) for outputting video signals of a still image system is connected to DVI-D IN.

4. Press ◀▶ to switch "DVI SIGNAL LEVEL".

- The setting will change as follows each time ◀▶ is pressed.

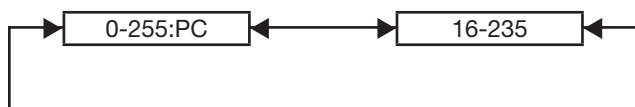

• 0-255:PC:

Select this when, for example, an external device (PC, etc.) is connected via the DVI terminal output.

• 16-235:

Select this when, for example, an external device (DVD player, etc.) is connected via the HDMI terminal output using a conversion cable.

Note

- The optimal setting differs depending on the output setting of the connected external device. Refer to the instruction manual of the external device.
- If the setting is changed, the data for plug and play changes. For the plug and play compatible resolutions, check the compatible signal list (pp. 122-123).

AUX DVI IN (Only when the ET-MD77DV is installed)

Change this setting if video does not display normally when the ET-MD77DV and an external device are connected via DVI-D.

1. Press ▲ ▼ to select “AUX DVI IN”.

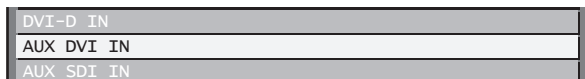

2. Press ENTER.

- The “AUX DVI IN” screen will be displayed.



3. Press ◀ ▶ to switch “AUX DVI EDID”.

- The setting will change as follows each time ◀ ▶ is pressed.

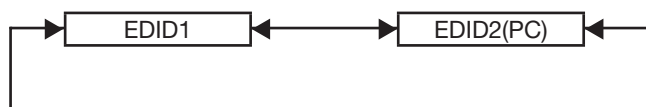

- EDID1 (Input signal formats supported) :**
Mainly select this when an external device (DVD player, etc.) for outputting video signals of a moving image system is connected to AUX DVI IN.
- EDID2 (Input signal formats supported) :**
Mainly use this when an external device (PC, etc.) for outputting video signals of a still image system is connected to AUX DVI IN.

4. Press ◀ ▶ to switch “AUX DVI SIGNAL LEVEL”.

- The setting will change as follows each time ◀ ▶ is pressed.

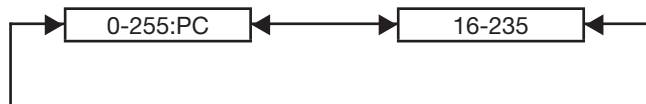

- 0-255:PC :**
Select this when, for example, an external device (PC, etc.) is connected via the DVI terminal output.
- 16-235 :**
Select this when, for example, an external device (DVD player, etc.) is connected via the HDMI terminal output using a conversion cable.

Note

- The optimal setting differs depending on the output setting of the connected external device. Refer to the instruction manual of the external device.
- If the setting is changed, the data for plug and play changes. For the plug and play compatible resolutions, check the compatible signal list (pp. 122-123).

AUX SDI IN

Set this in accordance with the input module (sold separately).

1. Press ▲ ▼ to select “AUX SDI IN”.

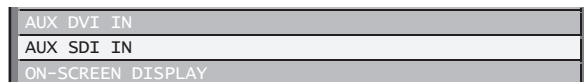

2. Press ENTER.

- The “AUX SDI IN” screen will be displayed.

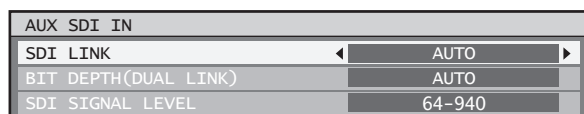

3. Press ▲ ▼ to select the desired item, and press ◀ ▶ to change the setting.

● SDI LINK

Select the single link signal type or dual link signal type. The setting will change as follows each time the button is pressed.

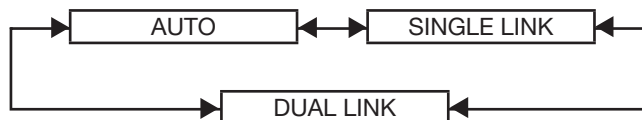

- AUTO:**
Selects the setting automatically.
- SINGLE LINK:**
Fixes the setting to signal link signal.
- DUAL LINK:**
Fixes the setting to dual link signal.

● BIT DEPTH (DUAL LINK)

Select the gradation for the signals to be input. This is only valid for dual link RGB inputs. The setting will change as follows each time the button is pressed.

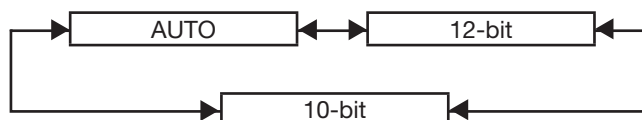

- AUTO:**
Selects 12-bit or 10-bit automatically.
- 12-bit:**
Fixes the setting to 12-bit.
- 10-bit:**
Fixes the setting to 10-bit.

● SDI SIGNAL LEVEL

Set to match the dynamic range (black-to-white) of the input signals. This is only valid when YPbPr and RGB input of HD-SDI. The setting will change as follows each time the button is pressed.

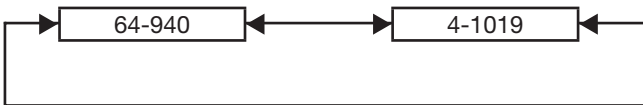

● 64-940:

Default: Black level defined as 64, White level as 940

● 4-1019:

Set this when gray appears black.

On-Screen display setting

The user can specify the on-screen display.

1. Press ▲▼ to select “ON-SCREEN DISPLAY”.

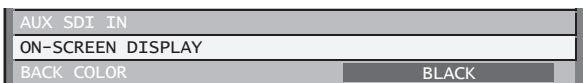

2. Press ENTER.

- The “ON-SCREEN DISPLAY” screen will be displayed.



3. Press ▲▼ to select the desired item, and press ◀▶ to change the setting.

● OSD POSITION

This sets the position of the on-screen display (OSD).

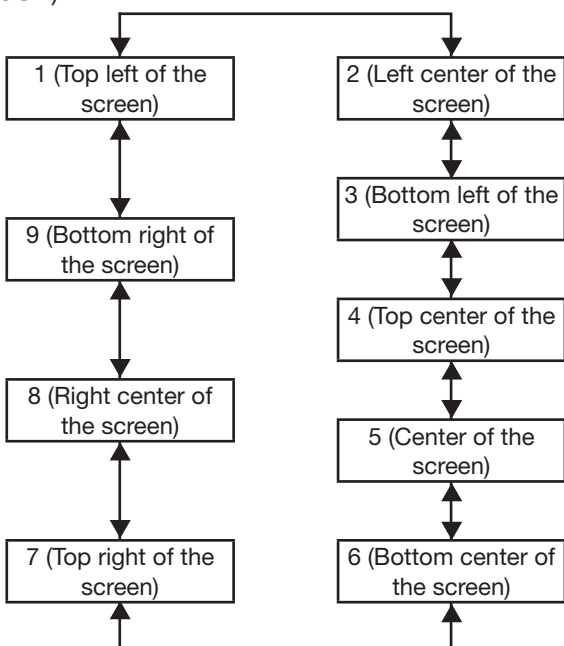

● OSD DESIGN

This sets the color of the on-screen display (OSD).

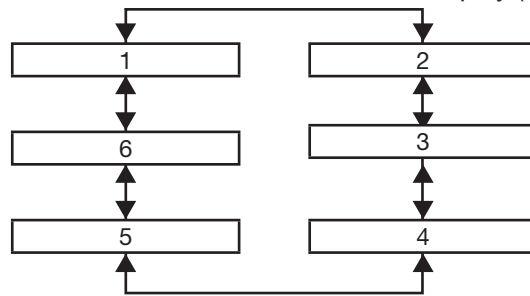

- 1: Displayed in yellow.
- 2: Displayed in blue.
- 3: Displayed in white.
- 4: Displayed in green.
- 5: Displayed in pink.
- 6: Displayed in brown.

● OSD MEMORY

The current menu cursor position will be retained when you return to the page.

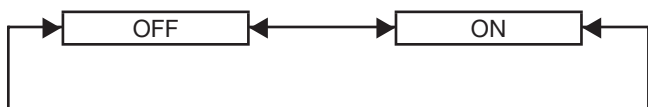

● INPUT GUIDE

This sets whether to display the currently selected input terminal name at the position set for “OSD POSITION”.



● WARNING MESSAGE

This sets the display of warning messages.



Back Color

This sets the color for the projection screen when no signals are being input.

1. Press ▲▼ to select “BACK COLOR”.



Display Option settings (continued)

2. Press ◀▶ to switch “BACK COLOR”.

- The setting will change as follows each time ◀▶ is pressed.

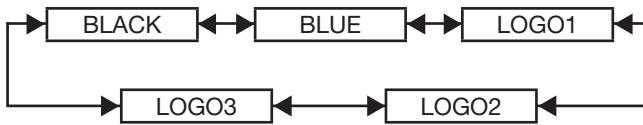

- **BLACK:**
The entire projection area will appear black.
- **BLUE:**
The entire projection area will appear blue.
- **LOGO1:**
The picture registered by the user will be projected in the projection area.
- **LOGO2:**
The picture registered by the user will be projected in the projection area.
- **LOGO3:**
The Panasonic logo is projected.

Note

- Separate software is required in order to create the pictures to use for “LOGO1” and “LOGO2”. Consult your dealer.

Setting the startup logo

This sets the startup logo that is projected when the power is turned on.

1. Press ▲▼ to select “STARTUP LOGO”.



2. Press ◀▶ to switch “STARTUP LOGO”.

- The setting will change as follows each time ◀▶ is pressed.

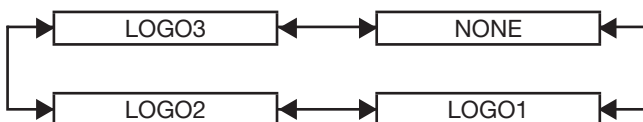

- **LOGO3:**
The Panasonic logo and DIGITAL PROJECTOR logo are projected.
- **NONE:**
No startup logo is projected.
- **LOGO1:**
The picture registered by the user will be projected.
- **LOGO2:**
The picture registered by the user will be projected.

Note

- Separate software is required in order to create the pictures to use for “LOGO1” and “LOGO2”. Consult your dealer.

Projector setup

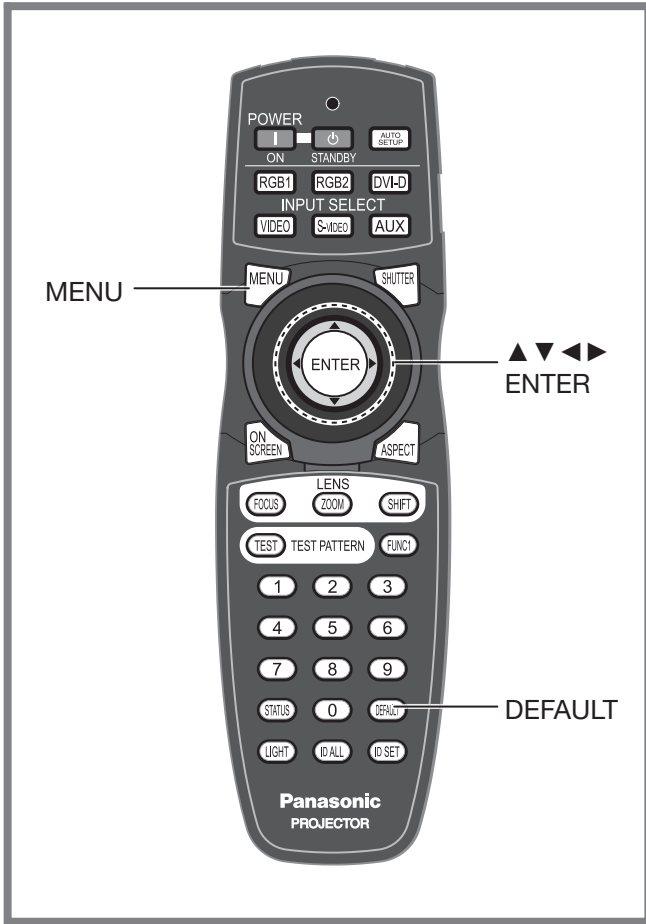

Setting a projector ID

The projector has an ID number setting function that helps the user to control two or more projectors either simultaneously or separately with a single remote control. **The ID number is set to “ALL” by default. Hence the ID number need not be set when only one projector is used.**

1. Press ▲▼ to select “PROJECTOR ID”.

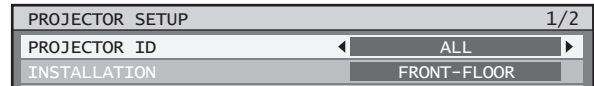

2. Press ◀▶ to switch “PROJECTOR ID”.

- The setting will change as follows each time ◀▶ is pressed.

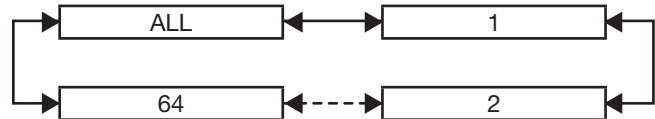

3. Press MENU twice.

- This concludes the setting procedure and the on-screen indications disappear and the normal screen appears again.

Note

- The ID number can be set to “ALL”, or selected from “1” to “64”.
- If the projectors are given ID numbers, their remote controls must be assigned the same ID numbers, respectively.
- If the ID number of a projector is set to “ALL”, it can be controlled by the remote control or the PC with any ID number. If multiple projectors are used and some of them have their IDs set to “ALL”, they cannot be controlled separately from the projectors with other ID numbers. For details on remote control ID setting, see page 18.

This menu can be used to make a variety of picture and projector settings.

MENU

Press to display the **MAIN MENU** screen.

ENTER

Press to select **“PROJECTOR SETUP”**.

Press to display the **“PROJECTOR SETUP”** menu.

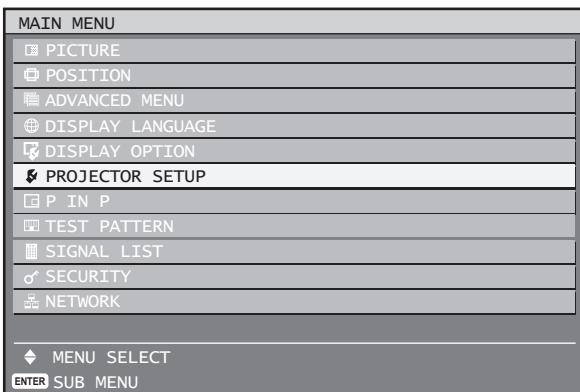

Projector setup (continued)

Installation Setting

A projection scheme can be chosen depending on the installation of the projector. If the picture is shown upside down or in reverse, change the projection scheme.

- Select the setting by displaying the on-screen indications using buttons of the remote control or the control panel on the main unit.

1. Press ▲▼ to select “INSTALLATION”.

PROJECTOR ID	ALL
INSTALLATION	FRONT-FLOOR
ALTITUDE MODE	ON

2. Press ◀▶ to switch “INSTALLATION”.

- The setting will change as follows each time ◀▶ is pressed.

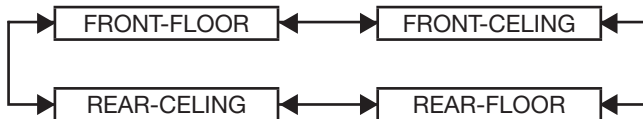

Floor mount front projection (FRONT-FLOOR)

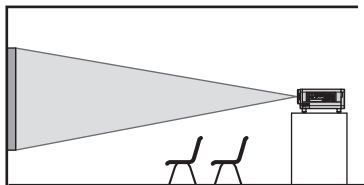

Ceiling mount front projection (FRONT-CEILING)

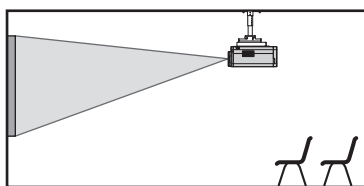

Floor mount rear projection (REAR-FLOOR)

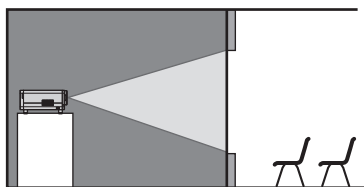

Ceiling mount rear projection (REAR-CEILING)

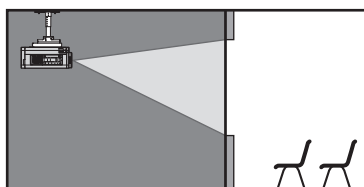

3. Press MENU twice.

- The on-screen indications disappear and the normal screen appears again.

Altitude Mode

When using the projector over 1 400 m above sea level, set to “ON”.

1. Press ▲▼ to select “ALTITUDE MODE”.

INSTALLATION	FRONT-FLOOR
ALTITUDE MODE	ON
DIRECTION	HORIZONTAL

2. Press ◀▶ to switch “ALTITUDE MODE”.

- The setting will change as follows each time ◀▶ is pressed.

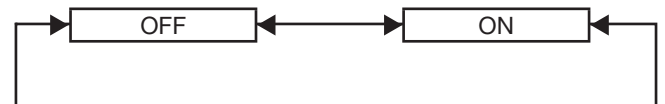

Direction

The fan speed is changed in accordance with the projector orientation (pointed forward, or toward the ceiling or floor)

1. Press ▲▼ to select “DIRECTION”.

ALTITUDE MODE	ON
DIRECTION	HORIZONTAL
LAMP SELECT	QUAD

2. Press ◀▶ to switch “DIRECTION”.

- The setting will change as follows each time ◀▶ is pressed.

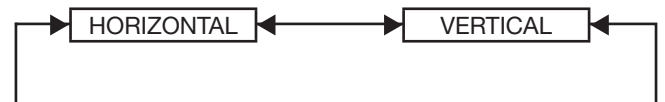

• HORIZONTAL:

This is the standard setup.

• VERTICAL:

Select this if the projector is tilted at a large vertical angle (an angle which exceeds 30° from the horizontal).

Lamp select

This lets you switch the four light source lamps to one of four brightnesses in accordance with the operating conditions and purpose of use.

1. Press ▲▼ to select “LAMP SELECT”.



2. Press ◀▶ to switch “LAMP SELECT”.

- The setting will change as follows each time ◀▶ is pressed.

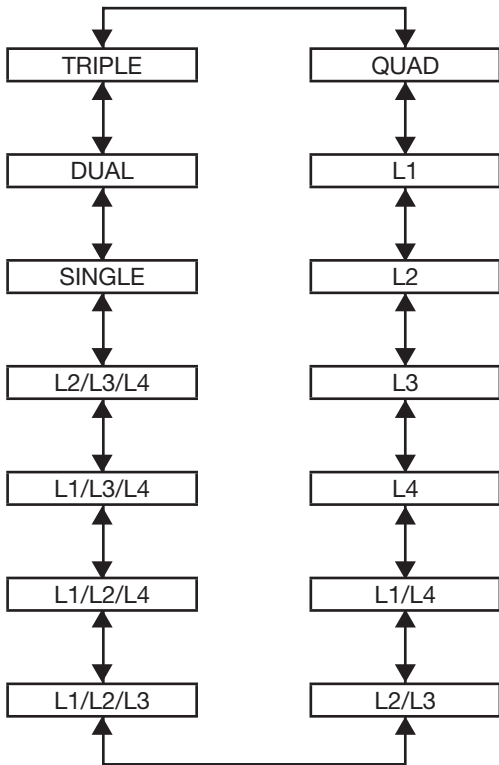

- **“QUAD”** : The four lamps illuminate.
- **“L1”** : One lamp illuminates. (Lamp unit 1 takes priority.)
- **“L2”** : One lamp illuminates. (Lamp unit 2 takes priority.)
- **“L3”** : One lamp illuminates. (Lamp unit 3 takes priority.)
- **“L4”** : One lamp illuminates. (Lamp unit 4 takes priority.)
- **“L1/L4”** : Two lamps illuminate. (Lamp unit 1 and 4 take priority.)
- **“L2/L3”** : Two lamps illuminate. (Lamp unit 2 and 3 take priority.)
- **“L1/L2/L3”** : Three lamps illuminate. (Lamp units 1, 2 and 3 take priority.)
- **“L1/L2/L4”** : Three lamps illuminate. (Lamp units 1, 2 and 4 take priority.)

- **“L1/L3/L4”** : Three lamps illuminate. (Lamp units 1, 3 and 4 take priority.)
- **“L2/L3/L4”** : Three lamps illuminate. (Lamp units 2, 3 and 4 take priority.)
- **“SINGLE”** : One of the lamps illuminates. (The lamp unit with the shortest operating time is selected automatically.)
- **“DUAL”** : Two lamps illuminate. (The lamp units with the shortest operating time out of lamp units 1 and 4 or 2 and 3 are selected automatically.)
- **“TRIPLE”** : Three lamps illuminate. (The lamp unit with the shortest operating time is selected automatically.)

3. Press ENTER.

Note

- For settings other than “QUAD”, any lamp which is malfunctioning or which has a cumulative operating time that exceeds 2 000 hours will be turned off and the other lamps will be turned on. If “QUAD” is selected, any lamp which is malfunctioning or which has a cumulative operating time that exceeds 2 000 hours will be turned off and only the lamps which have a cumulative operating time of less than 2 000 hours will be turned on. In addition, if the cumulative operating times for all lamps exceed 2 000 hours, the projector will switch to standby mode.
- Lamp units which are not turned on should still be installed to the projector.
- When it is time to replace the lamp, the number of the lamps that illuminate will be greater than the specified number of lamps in order to prevent the luminance from dropping.
- The characters in the lamp selection menu will become green when they are selected. Furthermore, the characters may flash depending on the condition of the lamps.
 - Yellow: An error has occurred with the illumination of one or more of the lamps
 - White: Unselected item
 - Red: Lamp where an illumination error has occurred

Projector setup (continued)

Lamp relay

If using the projector for a continuous period of 24 hours or more, this setting can be used to automatically switch the lamps that are turned on in order to reduce the lamp deterioration that can occur as a result of continuous use.

- “LAMP RELAY” will only be enabled when the lamp selection is “SINGLE” (1 lamp), “DUAL” (2 lamps), “TRIPLE” (3 lamps) or “QUAD” (4 lamps).

1. Press ▲ ▼ to select “LAMP RELAY”.

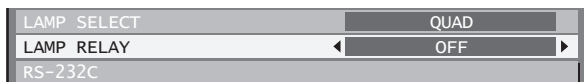

2. Press ◀ ▶ to switch “LAMP RELAY”.

- The time interval for lamps to be switched will change as shown in the diagram below each time ◀ ▶ is pressed.

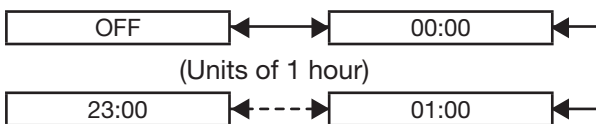

Note

- The lamps will switch at the specified time when the lamp selection is “SINGLE” or “DUAL”.
- When the lamp selection is “TRIPLE”, the lamps will switch a total of three times at two-hour intervals starting from the specified time, and after this the previous operating status will be maintained until the next specified time is reached.
- When the lamp selection is “QUAD”, three lamps will illuminate from the specified time, and the three lamps will switch a total of four times at two-hour intervals from that time. After this, four lamps will illuminate for eight hours from the specified time, and then when the next specified time is reached, switching between three lamps will resume.
- The setting time will be the local time. (p. 83)

RS-232C setting

This sets communication parameters for the projector. (p. 106)

1. Press ▲ ▼ to select “RS-232C”.



2. Press ENTER.

- The “RS-232C” screen will be displayed.

RS-232C	
SERIAL IN	RS-232C
(IN) BAUDRATE	9600
(IN) PARITY	NONE
(OUT) BAUDRATE	9600
(OUT) PARITY	NONE
RESPONSE (ID ALL)	ON
GROUP	MASTER
RESPONSE (ID GROUP)	ON

3. Press ▲ ▼ to select “SERIAL IN”.

4. Press ◀ ▶ to switch “SERIAL IN”.

- The setting will change as follows each time ◀ ▶ is pressed.

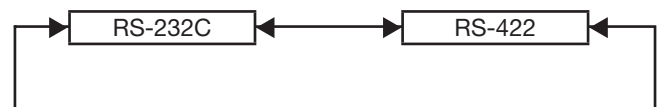

5. Press ▲ ▼ to select communication conditions.

6. Press ◀ ▶ to confirm the setting.

7. Press MENU three times.

- The on-screen indications disappear, and the system returns to the normal screen.

Remote2 mode

This sets the REMOTE2 terminal. (p. 110)

1. Press ▲ ▼ to select “REMOTE2 MODE”.



2. Press ◀ ▶ to switch “REMOTE2 MODE”.

- The setting will change as follows each time ◀ ▶ is pressed.

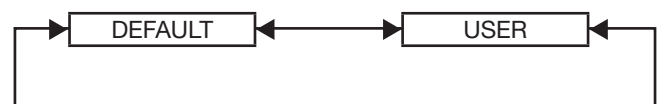

• DEFAULT:

The pin assignment of the REMOTE2 terminal is used as the projector default setting. (p. 110)

• USER:

This is used for changing an optional input module, using the REMOTE2 terminal, or for changing the settings for the REMOTE2 terminal. Any settings you make for pins 2 to 8 become valid once you press the ENTER button.

Status

Displays the status of the projector.

1. Press ▲ ▼ to select “STATUS”.

REMOTE2 MODE	DEFAULT
STATUS	
AIR FILTER CLEANING	

2. Press ENTER.

- The “STATUS” screen will be displayed.

STATUS	1/3
INPUT	RGB2
NAME	XGA60-A399999
SIGNAL FREQUENCY	48.36kHz/59.99Hz
PROJECTOR RUNTIME	76h
LAMP1	341h / ON /
LAMP2	334h / ON /
LAMP3	342h / ON /
LAMP4	97h / ON /
INTAKE AIR TEMP.	31°C/87°F
OPTICS MODULE TEMP.	27°C/80°F
AROUND LAMP TEMP.	31°C/87°F
REMOTE2 STATUS	DISABLE

3. Press ◀ ▶ to move to the next page.

STATUS	2/3
PROJECTOR MODEL	DZ12000
SERIAL NUMBER	SwXXXXX
MAIN VERSION	1.00.00
SUB VERSION	0.04
NETWORK VERSION	1.01

4. Press ◀ ▶ to move to the next page.

STATUS	3/3
ON COUNT	
POWER ON TIMES	8
LAMP1 ON	362
LAMP2 ON	363
LAMP3 ON	366
LAMP4 ON	116
SHUTTER	0(6)
AIR FILTER CLEANING	1(1)
AUX	MD77SD1:SN
NUMBER OF ENTRY SIGNAL	0/96
AC VOLTAGE	NORMAL

- INPUT:** Displays the input selection state.
- NAME:** Displays the input signal name.
- SIGNAL FREQUENCY:** Displays the frequency of the input signal.
- PROJECTOR RUNTIME:** Displays the projector runtime.
- LAMP1:** Displays the lighting time of LAMP1.
- LAMP2:** Displays the lighting time of LAMP2.
- LAMP3:** Displays the lighting time of LAMP3.

- LAMP4:** Displays the lighting time of LAMP4.
- INTAKE AIR TEMP:** Displays the intake air temperature of the projector.
- OPTICS MODULE TEMP.:** Displays the temperature inside the projector.
- AROUND LAMP TEMP.:** Displays the temperature around the lamp of the projector.
- REMOTE2 STATUS:** Displays the control status of REMOTE2.
- PROJECTOR MODEL:** Displays the type of projector.
- SERIAL NUMBER:** Displays the serial number of the projector.
- MAIN VERSION:** Displays the main version of the firmware of the projector unit.
- SUB VERSION:** Displays the sub version of the firmware of the projector unit.
- NETWORK VERSION:** Displays the network version of the projector unit.
- ON COUNT:**
 - POWER ON TIMES:** Displays the number of times the power has been turned on.
 - LAMP1 ON:** Displays the number of times LAMP1 has been lit.
 - LAMP2 ON:** Displays the number of times LAMP2 has been lit.
 - LAMP3 ON:** Displays the number of times LAMP3 has been lit.
 - LAMP4 ON:** Displays the number of times LAMP4 has been lit.
 - SHUTTER:** Displays the number of times the shutter function has been used.
 - AIR FILTER CLEANING:** Displays the number of times the air filter has been cleaned.
- AUX:** Displays the name of the optional input module inserted in the input module.
- NUMBER OF ENTRY SIGNAL:** Displays the number of registered signals.
- AC VOLTAGE:** Displays the AC voltage state.

Cleaning the air filter

This can be used to set air filter cleaning.

1. Press ▲ ▼ to select “AIR FILTER CLEANING”.

STATUS	
AIR FILTER CLEANING	
AUTO POWER OFF	DISABLE

Projector setup (continued)

2. Press ENTER.

- The “AIR FILTER CLEANING” screen will be displayed.
- You can select the automatic cleaning time (“TIME”) and also force cleaning to be carried out immediately (“EXECUTE”).

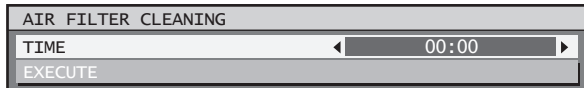

3. Press ▲▼ to select “TIME”.

- Select “TIME” and then set the time for automatic cleaning to be carried out.
- If you would like cleaning to be carried out straight away, select “EXECUTE” and then press ENTER.

4. Press ◀▶ to switch “TIME”.

- The setting will change as follows each time ◀▶ is pressed.

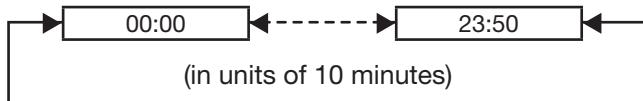

- The default setting is “00:00” (midnight).

Example: When the default setting is in use, automatic cleaning will start at 00:00 if the projector is in projection mode. If the time is set to 7:00, automatic cleaning will start at that time if the projector is in projection mode.

Note

- Contaminants such as oil and cigarette tar cannot be cleaned when air filter cleaning is carried out. Please use the optional “Smoke Cut” filter in these environments.
- The air filter cleaning monitor (FILTER CLEANING) will flash blue while cleaning of the air filter is in progress. If there is a problem with the air filter, the air filter cleaning monitor (FILTER CLEANING) will light red.
- The time taken for cleaning is approximately 30 to 40 seconds.
- The setting time will be the local time. (p. 83)
- If the projector is not in projection mode when the setting time is reached, automatic cleaning will not be carried out.
- Automatic cleaning will not be carried out if 24 hours have not yet elapsed since cleaning was last carried out (either by automatic cleaning or forced cleaning).

Example: If the setting time is 7:00 and forced cleaning is carried out at 9:00, then automatic cleaning will not be carried out at 7:00 on the following day.

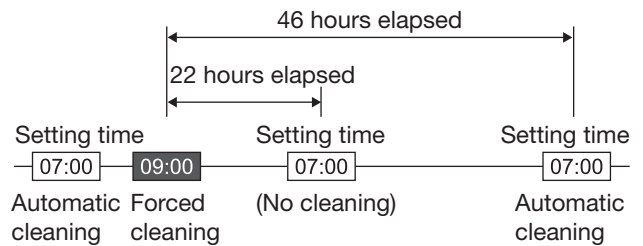

- If the time is set to a time which is within 24 hours from the last time cleaning was carried out, automatic cleaning will not be carried out the next time the setting time is reached. Instead, cleaning will be carried out when the setting time is reached on the following day.

Example: If cleaning was carried out at 10:00, and the cleaning time setting is then changed to 20:00, automatic cleaning will be carried out at 20:00 on the following day.

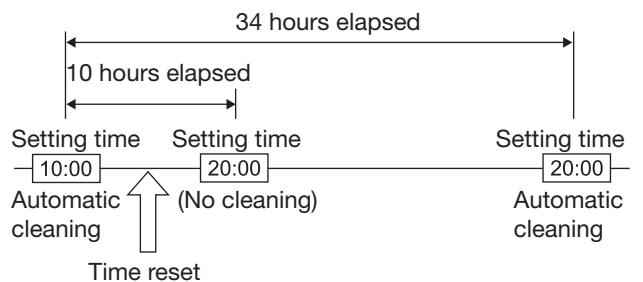

- When projection starts (when the power is turned on), automatic cleaning will be carried out immediately if more than 24 hours have elapsed since cleaning was last carried out.

Auto power off

The projector can be set to automatically enter the standby state if no signal is input before the set time elapses.

1. Press ▲▼ to select “AUTO POWER OFF”.



2. Press ◀▶ to switch “AUTO POWER OFF”.

- The setting will change as follows each time ◀▶ is pressed.

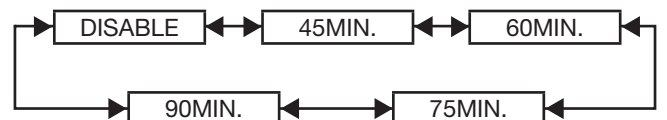

Setting FUNC1

The user can specify the function of the “FUNC1” button on the remote control.

1. Press ▲ ▼ to select “FUNC1”.

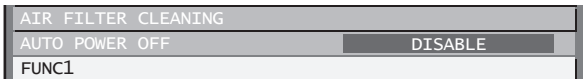

2. Press ENTER.

- The “FUNC1” screen will be displayed.



3. Press ▲ ▼ to select a function.

- **DISABLE:**
Disables the FUNC1 button.
- **P IN P:**
Enables setting of P IN P to “OFF”, “USER 1”, “USER 2”, or “USER 3”. (pp. 85-86)
- **SUB MEMORY:**
The sub memory can be switched. (pp. 46-47)
- **SYSTEM SELECTOR:**
Allows the system selector to be switched. (pp. 58-59)
- **SYSTEM DAYLIGHT VIEW:**
Allows the system daylight view to be switched. (pp. 56-57)
- **FREEZE:**
Allows switching to freeze mode for temporarily stopping video.

4. Press ENTER.

Setting the date and time

This lets you set the time zone and the current date and time for the projector’s internal clock.

1. Press ▲ ▼ to select “DATE AND TIME”.

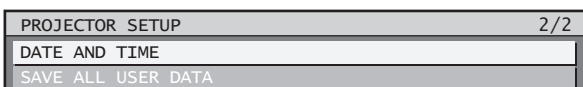

2. Press ENTER.

- The “DATE AND TIME” screen will be displayed.



3. Press ▲ ▼ to select “TIME ZONE”.

4. Press ◀ ▶ to switch “TIME ZONE”.

5. Press ▲ ▼ to select “ADJUST CLOCK”.

6. Press ENTER.

- The “ADJUST CLOCK” screen will be displayed.

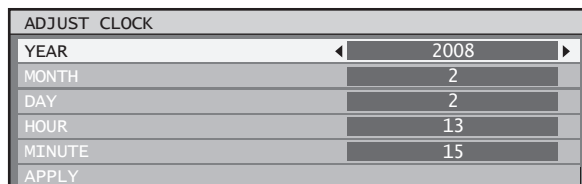

7. Press ▲ ▼ to select the item to be set, and use ◀ ▶ to set the local time.

8. Use ▲ ▼ to select “APPLY”, and then press ENTER.

- This completes setting of the time.

Save all user data

This saves various setting values as a backup to the internal memory of the projector.

1. Press ▲ ▼ to select “SAVE ALL USER DATA”.



2. Press ENTER.

- The “SECURITY PASSWORD” screen will be displayed.

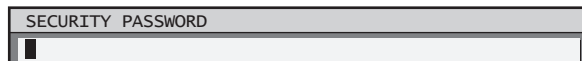

3. Enter the password set for the security password of the security menu.

- A confirmation screen will appear.

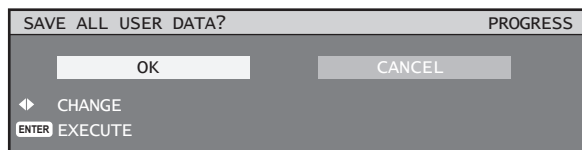

4. Press ◀ ▶ to select “OK”, and press ENTER.

Note

- “NETWORK/E-MAIL” and “LOGO IMAGE” are not saved.

Projector setup (continued)

Load all user data

This loads various setting values that were saved as a backup to the internal memory of the projector.

1. Press ▲▼ to select “LOAD ALL USER DATA”.



2. Press ENTER.

- The “SECURITY PASSWORD” screen will be displayed.



3. Enter the password set for the security password of the security menu.

- A confirmation screen will appear.

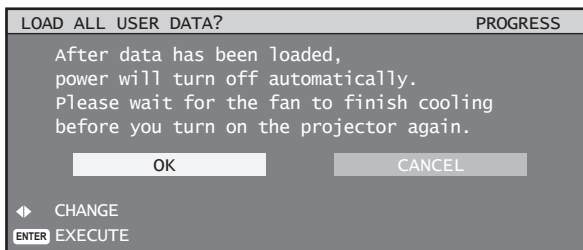

4. Press ◀▶ to select “OK”, and press ENTER.

Note

- If this is executed, the projector enters a standby state in order to reflect the setting values.

Initialize

This returns various setting values to their factory default settings.

1. Press ▲▼ to select “INITIALIZE”.

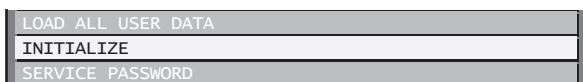

2. Press ENTER.

- The “SECURITY PASSWORD” screen will be displayed.

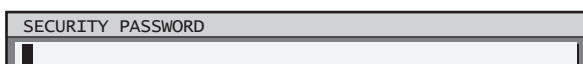

3. Enter the password set for the security password of the security menu.

- The “INITIALIZE” screen will be displayed.



• ALL USER DATA:

This is for use by service personnel. All setting values including “ENTRY SIGNAL”, “NETWORK/E-MAIL”, and “LOGO IMAGE” are returned to their factory default values. A restart will be required to complete the initialization of ALL USER DATA.

• ENTRY SIGNAL:

All setting values saved for each of the input signals are cleared. To clear just some registered signals, perform the procedure described in “Clearing the data of registered signals”. (p. 46)

• NETWORK/E-MAIL:

This returns “NETWORK/E-MAIL” to its factory default value.

• LOGO IMAGE:

The settings for the images registered for LOGO1 and LOGO2 are returned to their factory default images. (p. 76)

4. Press ▲▼ to select the desired initialize item, and press ENTER.

- A confirmation screen will appear.

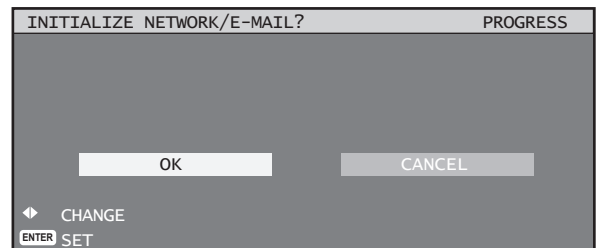

5. Press ◀▶ to select “OK”, and press ENTER.

Service password

This function is used by a service person. Input the password with the numeric buttons (0 to 9) of the remote control and press ENTER to confirm the entry.

P IN P

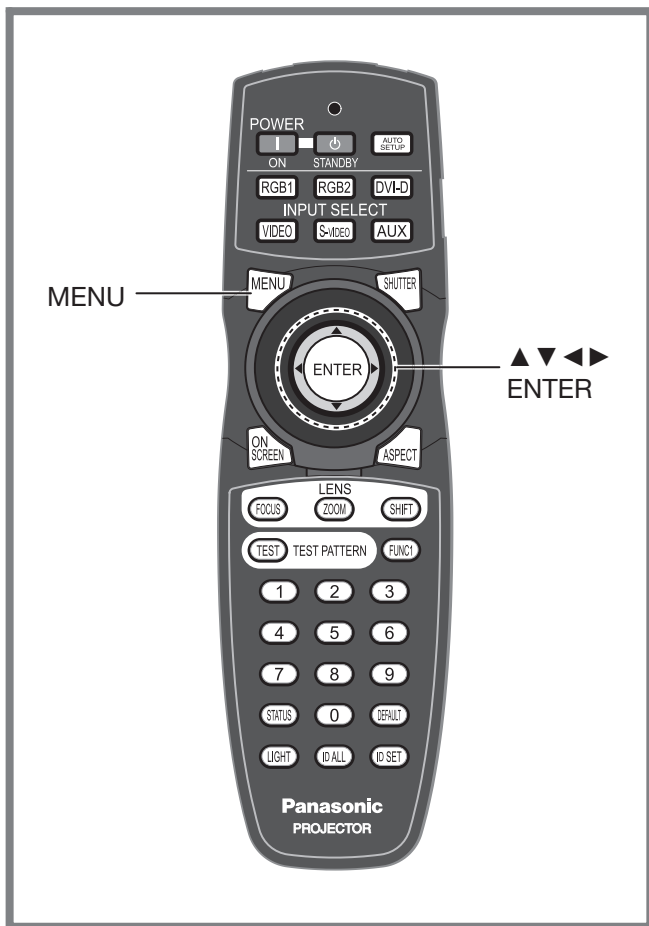

Using the P IN P function

Two videos can be projected simultaneously by placing a separate small sub screen within the main screen.

1. Press ENTER.

- The “P IN P” screen will be displayed.

P IN P	
P IN P MODE	OFF

2. Press ▲ ▼ to select “P IN P MODE”.

P IN P MODE	
OFF	
● USER1	
USER2	
USER3	

3. Press ▲ ▼ to select a function.

- OFF:**
The P IN P function is not used.
- USER1, USER2, USER3:**
The P IN P function is used with the settings that were set in “Setting the P IN P function”.

4. Press ENTER.

Setting the P IN P function

The settings of the P IN P function can be saved to “USER1”, “USER2”, and “USER3”.

1. Refer to “Using the P IN P function” above, and then select from “USER1”, “USER2”, and “USER3”.

- The settings for the user data selected for “P IN P MODE” are displayed.

P IN P	
P IN P MODE	USER1
MAIN WINDOW	VIDEO
SIZE	
POSITION	
SUB WINDOW	RGB2
SIZE	
POSITION	
FRAME LOCK	MAIN WINDOW
TYPE	SUB WINDOW

2. Press ▲ ▼ to select the desired setting item, and press ENTER.

- The sub menu for the selected item appears.

This item is used to set the condition of the Picture-In-Picture.

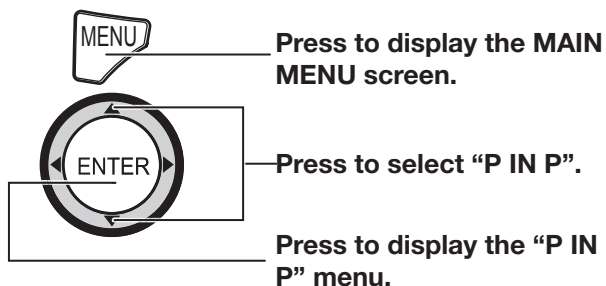

MAIN MENU	
PICTURE	
POSITION	
ADVANCED MENU	
DISPLAY LANGUAGE	
DISPLAY OPTION	
PROJECTOR SETUP	
P IN P	
TEST PATTERN	
SIGNAL LIST	
SECURITY	
NETWORK	
MENU SELECT	
ENTER	SUB MENU

P IN P (continued)

- **MAIN WINDOW:**

The input terminal for the main window is displayed. Press ▲▼ to select an item, and press ENTER to switch to the item.

SIZE: The user can specify the display size of the main window between 10 % and 100 %.

POSITION: The user can specify the display position of the main window on the screen.

- **SUB WINDOW:**

The input terminal for the SUB WINDOW is displayed. Press ▲▼ to select an item, and press ENTER to switch to the item.

SIZE: The user can specify the display size of the subwindow between 10 % and 100 %.

POSITION: The user can specify the display position of the subwindow on the screen.

- **FRAME LOCK:**

The user can select the window to apply frame lock. Press ◀▶ to switch windows.

“MAIN WINDOW”: Frame lock is set for the input signals specified for the main window.

“SUB WINDOW”: Frame lock is set for the input signals specified for the subwindow.

- **TYPE:**

The user can select the window that is displayed by priority when two windows overlap. Press ◀▶ to switch windows.

“MAIN WINDOW”: The main window is displayed by priority.

“SUB WINDOW”: The subwindow is displayed by priority.

Note

- The P IN P function is not available depending on the input signals and the selected input terminals. Refer to “List of P IN P” for details. (p. 124)
- The main window’s picture adjustment values such as the picture mode, gamma selection and color temperature setting for the main window will be applied.
- In the normal screen (when the menu is not displayed), the ◀▶ buttons can be used to switch the size and position of the main window and subwindow when the P IN P function is on. When switching from USER1 to USER2 to USER3 modes, picture disruption will occur.

Displaying the internal test pattern

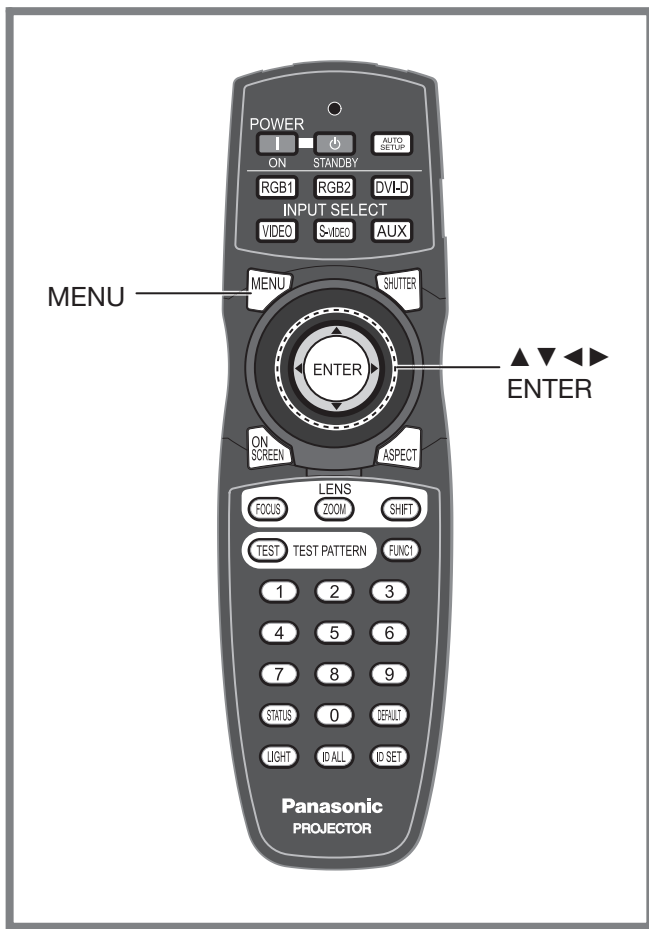

Test pattern

Results of adjustment on the image, picture quality, position, size and other factors will not be reflected in test patterns. Be sure to display the input signal before performing various kinds of setting.

1. Press ◀▶ to search through the various types of test patterns.

■ Cycle of displayed internal test patterns

The setting will change as follows each time ◀▶ is pressed.

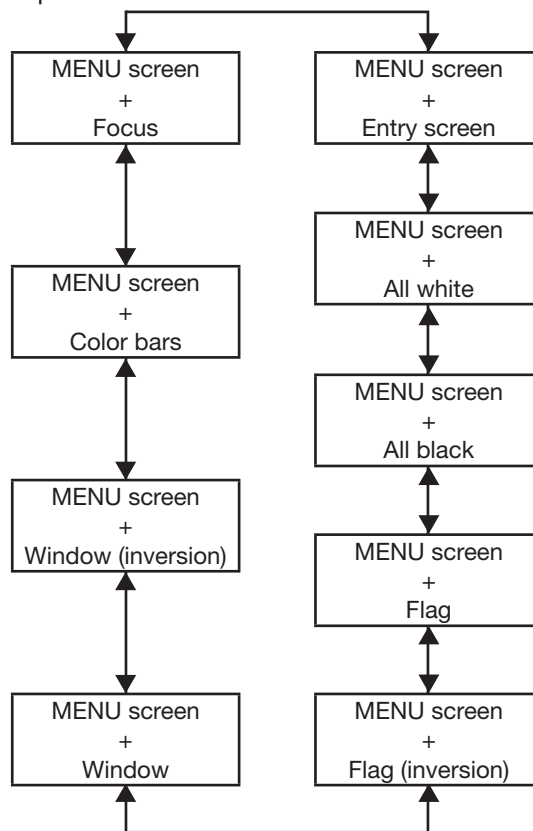

The projector has 8 types of internal test patterns to check the condition of the set.

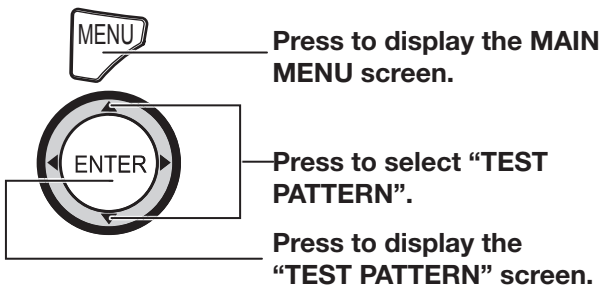

MAIN MENU	
□	PICTURE
⊕	POSITION
≡	ADVANCED MENU
⊕	DISPLAY LANGUAGE
⊕	DISPLAY OPTION
⚙	PROJECTOR SETUP
□	P IN P
⊕	TEST PATTERN
≡	SIGNAL LIST
♂	SECURITY
⊕	NETWORK
⚡	MENU SELECT
ENTER	SUB MENU

Setting the security

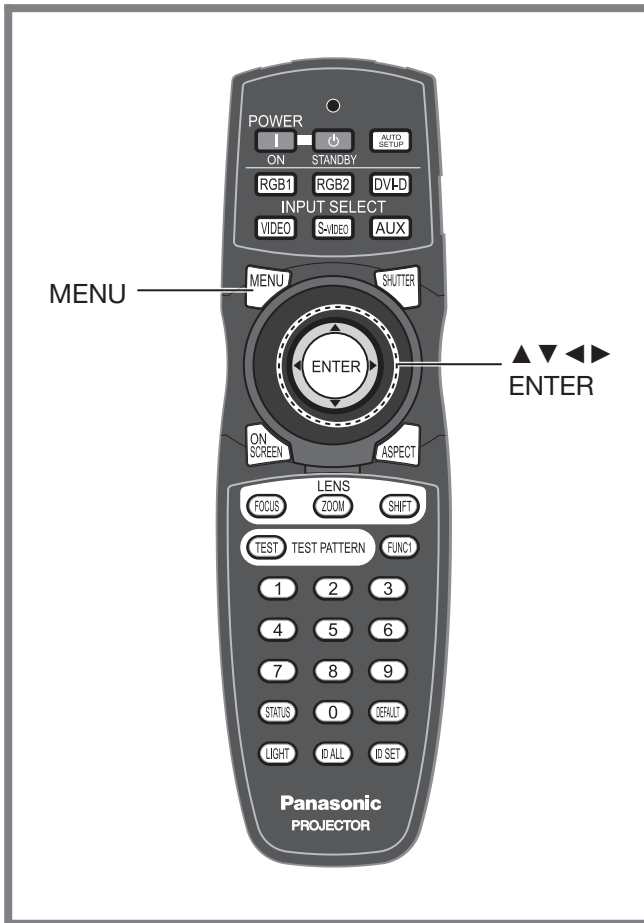

The unit's security function serves to display the password input screen or to set and display the user company's URL under the projected pictures.

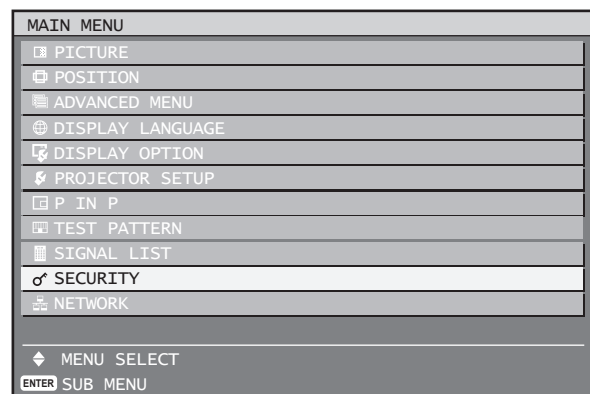
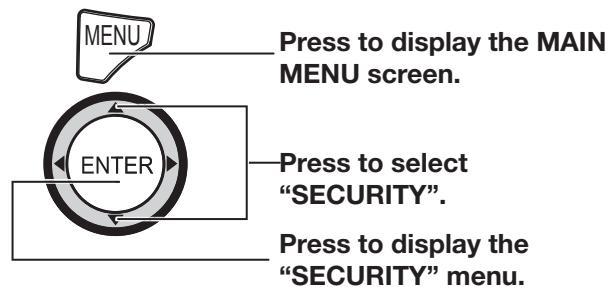

Displaying the security screen

Password settings and text settings can be made after the security screen is displayed.

● If using for the first time

1. Press **▲, ►, ▼, ◀, ▲, ►, ▼** and **◀** in this order.

● If the existing password has been changed
Enter the new password.

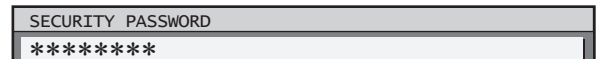

2. Press **ENTER**.

• The "SECURITY" screen will be displayed.

Note

• Only asterisks * will appear on the screen to represent the actual characters of the password when the password is entered.

Setting the security password

The SECURITY PASSWORD screen can be displayed when the power has been turned on. If the correct password is not entered, operations other than using the POWER STANDBY (⏻) button and SHUTTER button and adjusting the lens will not be possible.

1. Press **▲▼** to select "SECURITY PASSWORD".



2. Press **◀►** to switch "SECURITY PASSWORD".

• The setting will change as follows each time **◀►** is pressed.

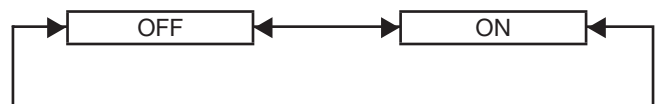

• **ON:**
Password entry is enabled.

• **OFF:**
Password entry is disabled.

Changing the security password

The password can be changed.

1. Press ▲▼ to select “SECURITY PASSWORD CHANGE”.



2. Press ENTER.

- The “SECURITY PASSWORD CHANGE” screen will be displayed.

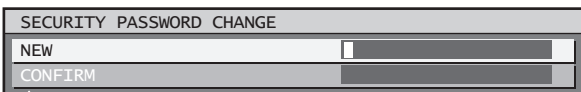

3. Press ▲▼◀▶ to set the password.

- Up to 8 buttons can be set as the password.

4. Press ENTER.

5. For the purposes of confirmation, enter the password again.

6. Press ENTER.

Note

- Only asterisks * will appear on the screen to represent the actual characters of the password when the password is entered.

Setting the text

The set text can be permanently displayed below the pictures being projected.

1. Press ▲▼ to select “DISPLAY SETTING”.



2. Press ◀▶ to switch “DISPLAY SETTING”.

- The setting will change as follows each time ◀▶ is pressed.

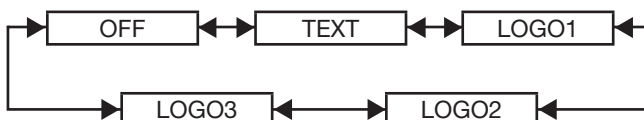

- **OFF:**
The text display is disabled.
- **TEXT:**
The text display is enabled.
- **LOGO1:**
The picture registered by the user will be projected.
- **LOGO2:**
The picture registered by the user will be projected.
- **LOGO3:**
The Panasonic logo is projected.

Note

- Separate software is required in order to create the pictures to use for “LOGO1” and “LOGO2”. Consult your dealer.

Changing the text

When DISPLAY SETTING is enabled, you can change the text that is displayed.

1. Press ▲▼ to select “TEXT CHANGE”.

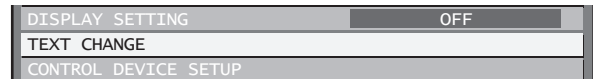

2. Press ENTER.

- The “TEXT CHANGE” screen will be displayed.

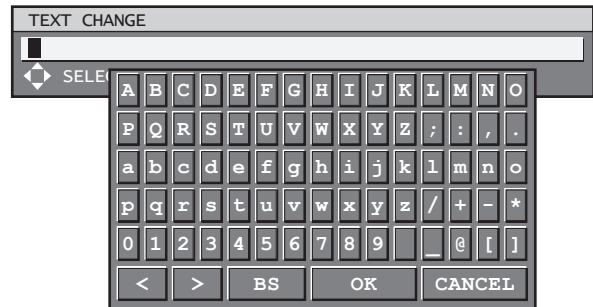

3. Press ◀▶ to select the text position, and press ▲▼ to select the characters of the text.

4. Press ENTER.

- The text is now changed.

Setting the security (continued)

Control device setup

Control from the remote control and main unit controls can be restricted.

1. Press ▲▼ to select “CONTROL DEVICE SETUP”.

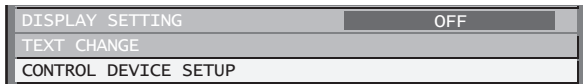

2. Press ENTER.

- The “CONTROL DEVICE SETUP” screen will be displayed.



3. Press ▲▼ to select “CONTROL PANEL” or “REMOTE CONTROLLER”.

- **CONTROL PANEL:**
Restriction of control from the main unit controls can be set.
 - **ENABLE:**
Enables control from the main unit controls.
 - **DISABLE:**
Disables control from the main unit controls.
- **REMOTE CONTROLLER:**
Restriction of control from the remote control can be set.
 - **ENABLE:**
Enables control from the remote control.
 - **DISABLE:**
Disables control from the remote control.

4. Press ENTER.

- The “CONTROL PANEL” or “REMOTE CONTROLLER” screen will be displayed.

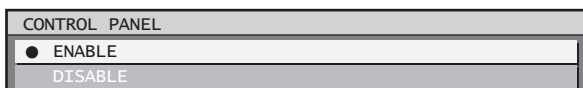

5. Press ▲▼ to select “ENABLE” or “DISABLE”, and then press ENTER.

- A confirmation screen will appear.



6. Press ◀▶ to select “EXECUTE”, and then press ENTER.

Note

- If a setting is reflected, the on-screen menu disappears. To continue operation, press the MENU button to display the main menu.
- If an attempt is made to control the projector from the remote control or main unit controls when “ENABLE” is set, the security password screen appears. To change a setting, enter the security password and change the operation setting. The security password screen disappears if the MENU button is pressed or no operation is performed for 10 seconds.

How to use network functions

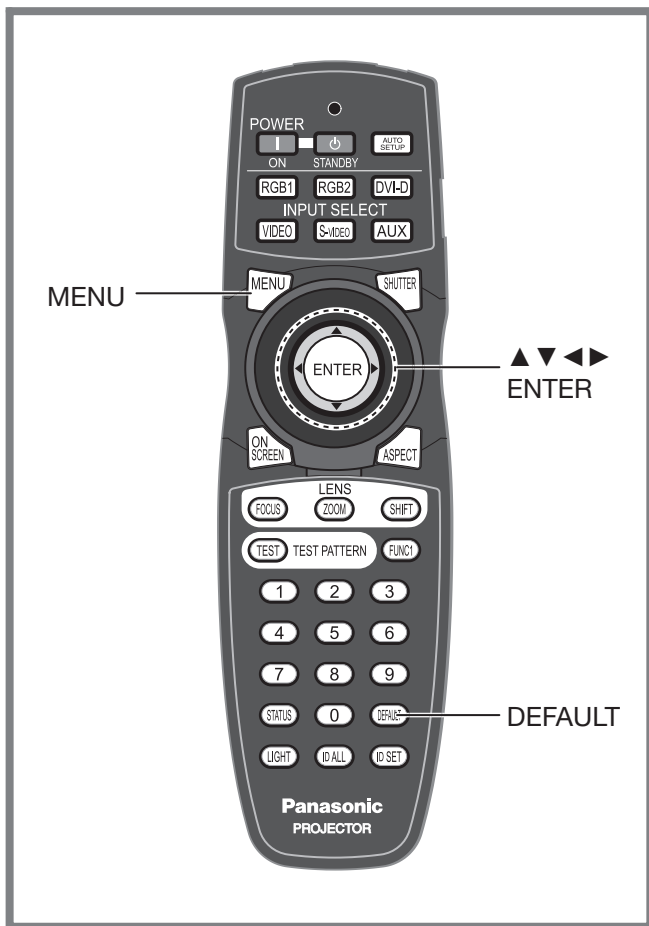

Network standby

When the projector is in a standby state, you can control the power of the projector from a computer connected via a wired LAN.

1. Press **▲▼** to select “**NETWORK STANDBY**”.

NETWORK	
NETWORK STANDBY	OFF
NETWORK SETUP	

2. Press **◀▶** to switch “**NETWORK STANDBY**”.

- The setting will change as follows each time **◀▶** is pressed.

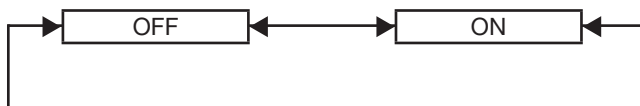

- **ON:**
Enables the network standby function.
- **OFF:**
Disables the network standby function.

Initial setting of network function

Make the initial network function settings before using the network functions.

1. Press **▲▼** to select “**NETWORK SETUP**”.

NETWORK STANDBY	OFF
NETWORK SETUP	
NETWORK CONTROL	

2. Press **ENTER**.

- The “**NETWORK SETUP**” screen will be displayed.

NETWORK SETUP	
HOST NAME	PROJECTOR
DHCP	OFF
IP ADDRESS	192.168.0.8
SUBNET MASK	255.255.255.0
GATEWAY	192.168.0.1
STORE	

3. Press **▲▼** to select items, and press **ENTER** to change the setting.

- **HOST NAME (Display of host name and setting) :**
Change as needed when using a DHCP server.

This allows you to use network functions.

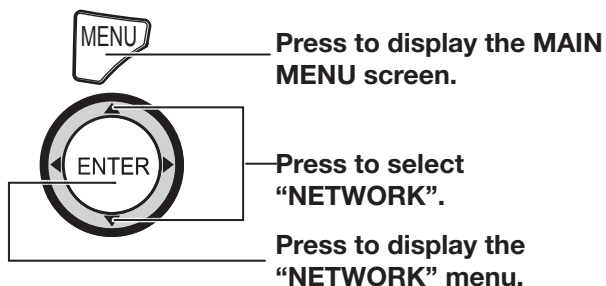

MAIN MENU	
PICTURE	
POSITION	
ADVANCED MENU	
DISPLAY LANGUAGE	
DISPLAY OPTION	
PROJECTOR SETUP	
P IN P	
TEST PATTERN	
SIGNAL LIST	
SECURITY	
NETWORK	
MENU SELECT	
ENTER SUB MENU	

How to use network functions (continued)

- **DHCP (DHCP client function) :**
Set the DHCP item to ON when to acquire an IP address automatically using the DHCP server. Set to OFF if DHCP server is not used. Enter the IP address if DHCP server is not used.
- **IP ADDRESS (Display of IP address and setting) :**
Enter the IP address if DHCP server is not used.
- **SUBNET MASK (Displaying and setting the subnet mask) :**
If not using a DHCP server, enter the subnet mask.
- **GATEWAY (Display of gateway address and setting) :**
Enter the gateway address if DHCP server is not used.
- **STORE:**
Save the current network settings.

4. Press ▲ ▼ to select “STORE”, and then press ENTER.

Note

- Before using the DHCP server, make sure the DHCP server is already functioning.
- For details of IP address, subnet mask, and gateway, ask the network administrator.

Network control

This sets the network control method.

1. Press ▲ ▼ to select “NETWORK CONTROL”.

NETWORK SETUP
NETWORK CONTROL
NETWORK STATUS

2. Press ENTER.

- The “NETWORK CONTROL” screen will be displayed.

NETWORK CONTROL	
WEB CONTROL	ON
WEB PORT	80
PJLink CONTROL	OFF
COMMAND CONTROL	OFF
COMMAND PORT	1024
STORE	

3. Press ▲ ▼ to select items, and press ◀ ▶ to change the setting.

- **WEB CONTROL:**
Set this to ON when you want to perform control with the Web browser. (pp. 93-104)
- **WEB PORT:**
Set the port number to use.
- **PJLink CONTROL:**
Set this to ON when you want to perform control with the PJLink protocol. (p. 105)
- **COMMAND CONTROL:**
Set to ON to control using the control command via the serial terminal. (pp.106-109)
If settings have been made without an administrator password of the Web browser control, add 2-byte “00” instead of STX, and a line-feed code (0Dh) instead of ETX. If settings have been made with an administrator password of the Web browser control, add a 32-byte hash value and “00” instead of STX and a line-feed code (0Dh) instead of ETX. The hash value is created by MD5 combining “admin1:”, password, “.” and random numbers. The random numbers are 8-byte values sent from the projector when connecting.
- **COMMAND PORT:**
Set the port number used for the command control.
- **STORE:**
Save the current network control settings.

Network status

This displays the network status of the main unit.

1. Press ▲ ▼ to select “NETWORK STATUS”.

NETWORK SETUP
NETWORK CONTROL
NETWORK STATUS

2. Press ENTER.

- The “NETWORK STATUS” screen will be displayed.

NETWORK STATUS	
DHCP	OFF
IP ADDRESS	192. 168. 0. 8
SUBNET MASK	255. 255. 255. 0
GATEWAY	192. 168. 0. 1
DNS1	0. 0. 0. 200
DNS2	0. 0. 0. 0
MAC ADDRESS	00:0B:97:41:03:05

Returning the network function setting back to the factory setting

Network function settings such as the IP address, password, and e-mail settings can be return to their factory settings with the initialize menu of the projector setup. (p. 84)

Network connections

The projector is equipped with network functions, and web browser controls can be used to carry out the following operations from a computer.

- Projector settings and adjustments
- Projector status display
- Transmission of E-mail messages if there is a problem with the projector

Note

- A LAN cable is required to use the network function. A cross cable is required when connecting directly to a computer. Straight cables are used when connecting through a switch or router.

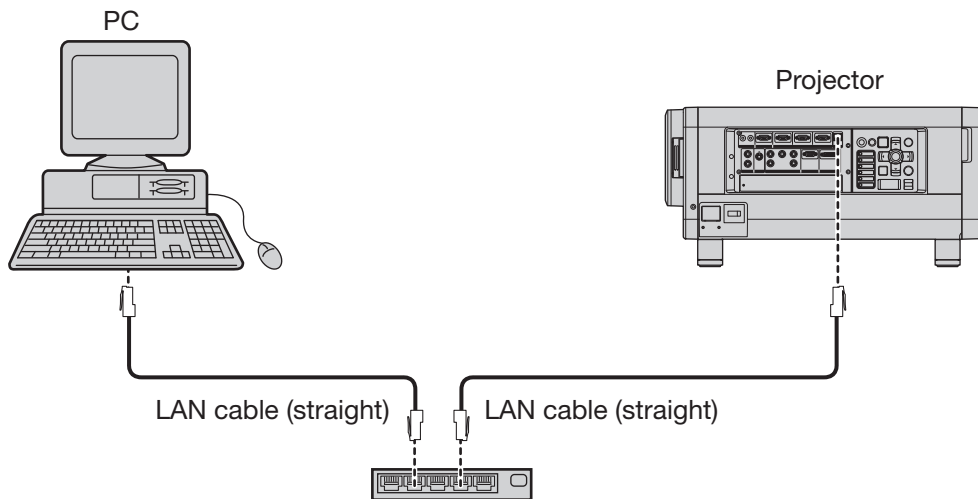

- A Web browser is required to use this function. Make sure that a Web browser is available in the system.
- Use Microsoft Windows 98SE/Me/NT4.0/2000/XP/Vista for the OS of your personal computer.
- The Web browser should be Internet Explorer 6.0 or later or Netscape Communicator 7.0 or later.
- To use the E-mail function, communication with E-mail server must be established. Make sure that E-mail feature is available in your system.
- Use a straight insulated LAN cable which supports category 5 or above.
- The length of LAN cable must be 100 m or shorter.

Name and function of network function parts

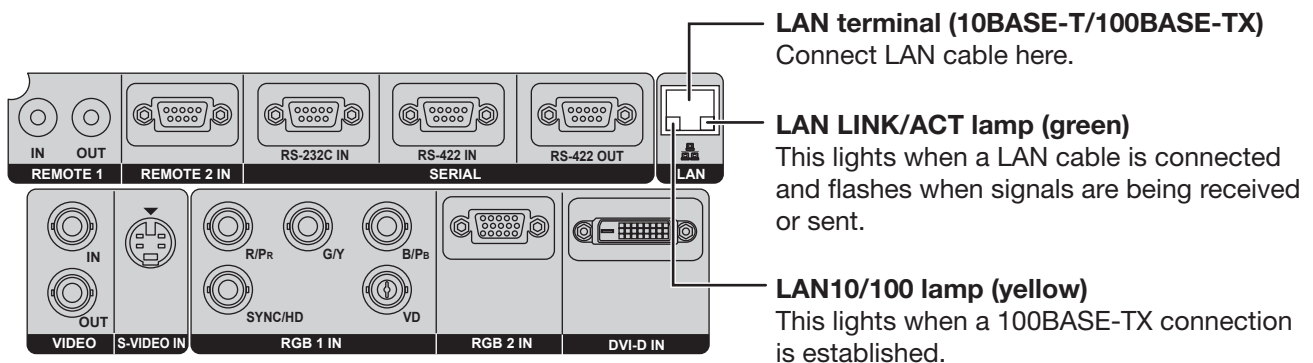

Attention

- If the LAN terminal is touched by electrostatically charged hands (or body), failure may be caused by the discharge of static electricity.
Be careful not to touch metallic part of LAN terminal or LAN cable.
- Connect indoor equipment to the LAN.

How to use network functions (continued)

Accessing from the Web browser

1. Activate the Web browser in the personal computer.
2. Enter the IP address set by the projector into the URL input field of the Web browser.



3. Enter your “User Name” and “Password”.

- The factory default settings are user1 (user privileges) or admin1 (administrator privileges) for the user name and panasonic (lowercase letters) for the password.

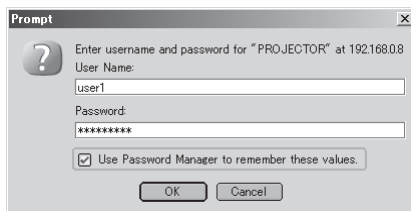

4. Press OK to display the Projector status page.

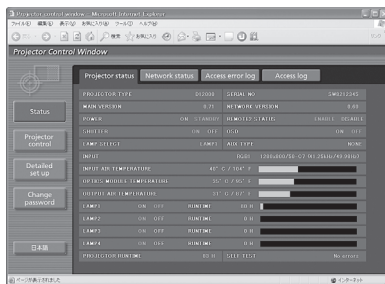

Note

- Avoid activating two or more Web browser simultaneously to work out setting or control actions.
- Change the password first of all.
- Administrator privileges enable the use of all functions. User privileges enable the use of only “Projector status”, “Error information”, “Network status”, “Basic control”, and “Change password”.
- If the password is incorrectly entered three times in a row, the lock is set for several minutes.

Change Password page

Click [Change password].

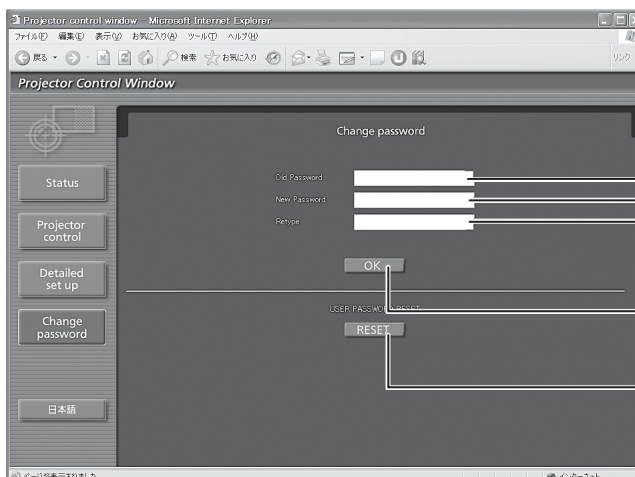

Old password input field

New password input field

New password input field
(re-enter for confirmation)

Button for executing password change

When you log in with administrator privileges, the button for resetting the password for user privileges is displayed.

Basic control page

This page is the first page displayed when the projector is accessed through a web browser. To move from another page, click [Projector control], then [Basic control].

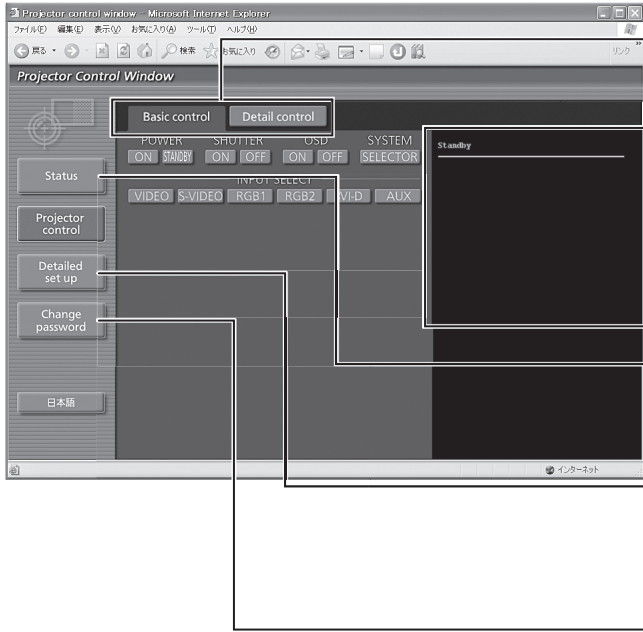

Page selection tabs

Click these to switch pages.

This displays the on-screen status. It is displayed even if the on-screen display of the projector is set to off.

Monitor information button

Click this item, and the status of the projector is displayed.

Detailed set up button

Click this item to display the advanced settings page.

Change password button

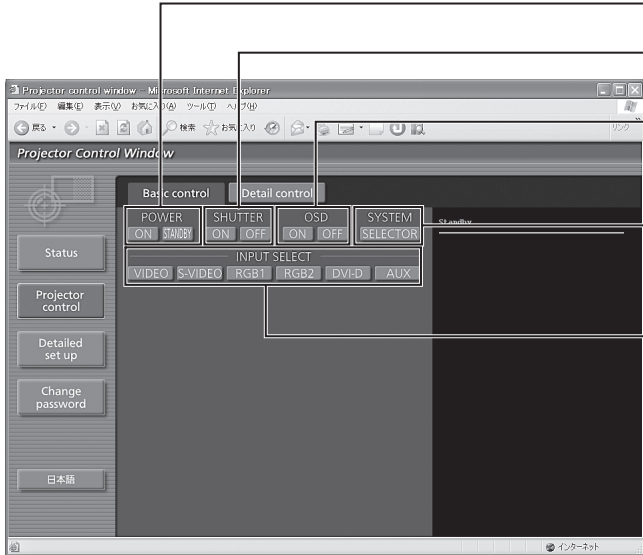

Power On/Off control

SHUTTER control

OSD (On-screen Display) display/non-display

System type switching

Use these to select the input signals.

How to use network functions (continued)

Detail control page

Click [Projector control], then [Detail control] to display the Detail control page.

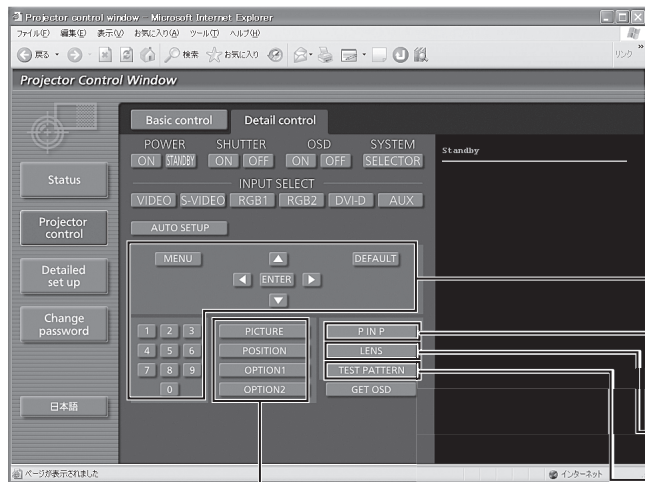

Pressing these buttons controls the projector and updates the on-screen description on the right of the control page when control is finished.

Lens adjustment

Test pattern display

This button updates the on-screen description on the right of the control page with the latest information.

Menu display

Projector status page

Click [Status], then [Projector status] to display the Status information page. This page displays the projector statuses established for the items shown below.

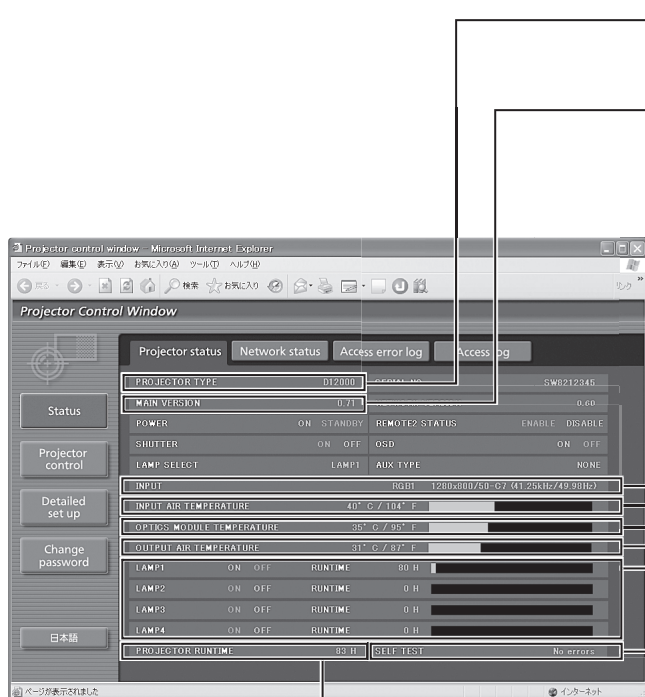

Displays the firmware version of the projector main unit.

Displays the type of projector.

Displays the input switching status.

Displays temperature of projector's intake air.

Displays temperature inside the projector.

Displays temperature of projector exhaust.

Displays the lamp lit hours.

Displays self-diagnosis information.

Displays used hours of the projector.

Error information page

When **SELF TEST** **Error (Detail)** is displayed on the status information screen, click it to display the error details.

- Depending on the nature of the error, the projector may be placed in the standby mode for its own protection.

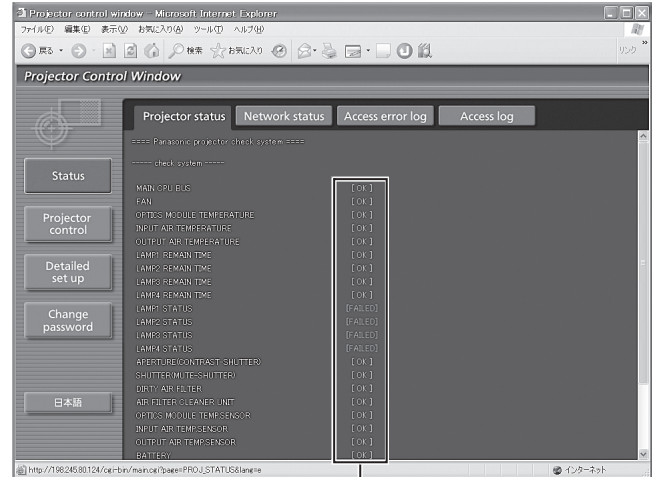
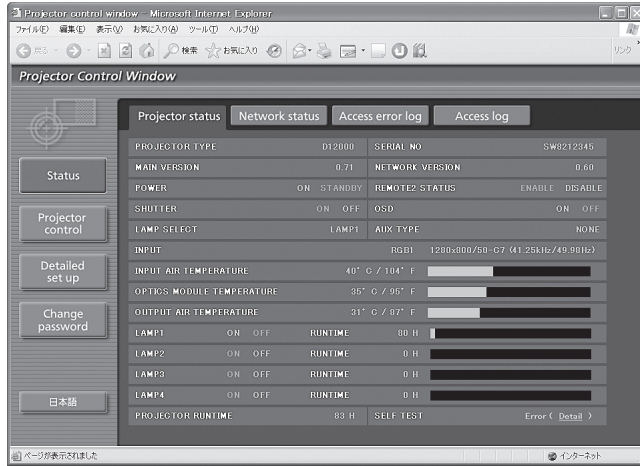

OK: Normal operation
FAILED: Occurrence of trouble

When [FAILED] has appeared for an item

Parameter	Description
MAIN CPU BUS	Trouble has occurred in the microcomputer circuitry. Consult your dealer.
FAN	Trouble has occurred in the fan or its drive circuit. Consult your dealer.
OPTICS MODULE TEMPERATURE	The temperature inside the projector is high. It may be that the projector is being used in an operating environment where the temperature is high such as near a heating appliance.
INPUT AIR TEMPERATURE	The input air temperature is too high. It may be that the projector is being used in an operating environment where the temperature is high such as near a heating appliance.
OUTPUT AIR TEMPERATURE	The temperature around the lamp is too high. It may be that the projector's ventilation holes are blocked.
LAMP REMAIN TIME	The lamp runtime has exceeded the prescribed cumulative time, and it is now time to replace the lamp.
LAMP STATUS	The lamp has failed to light. Wait a short while for the lamp to cool off, and then turn on the power.
APERTURE (CONTRAST-SHUTTER)	Trouble has occurred in the contrast shutter circuitry. Consult your dealer.
SHUTTER (MUTE-SHUTTER)	Trouble has occurred in the shutter circuitry. Consult your dealer.
DIRTY AIR FILTER	The air filter is blocked with dust. Turn off the MAIN POWER switch by following the procedure on page 39, and then clean the air filter. (pp. 112-113)
AIR FILTER CLEANER UNIT	The air filter unit is not installed. Install the air filter unit.
OPTICS MODULE TEMP.SENSOR	Trouble has occurred in the temperature detection sensor inside the projector. Consult your dealer.
INPUT AIR TEMP.SENSOR	Trouble has occurred in the sensor used to detect the input air temperature. Consult your dealer.
OUTPUT TEMP. SENSOR	Trouble has occurred in the sensor used to detect the exhaust air temperature. Consult your dealer.
BATTERY	The backup battery has been run out. Consult your dealer.
CLOGGED FILTER SENSOR	Problem with clogged filter sensor. Consult your dealer.
AC POWER	AC power supply voltage input has dropped. Check that there is sufficient electrical wiring capacity for the projector's power consumption requirements.
LENS SHIFT	Problem with lens shift circuit. Consult your dealer.

How to use network functions (continued)

E-mail setup page

With this projector, if a problem occurs or if the lamp usage time reaches a set value, an e-mail message can be sent to one or more preset e-mail addresses (maximum two addresses). Click [Detailed set up], then [E-mail set up] to display the E-mail setup page.

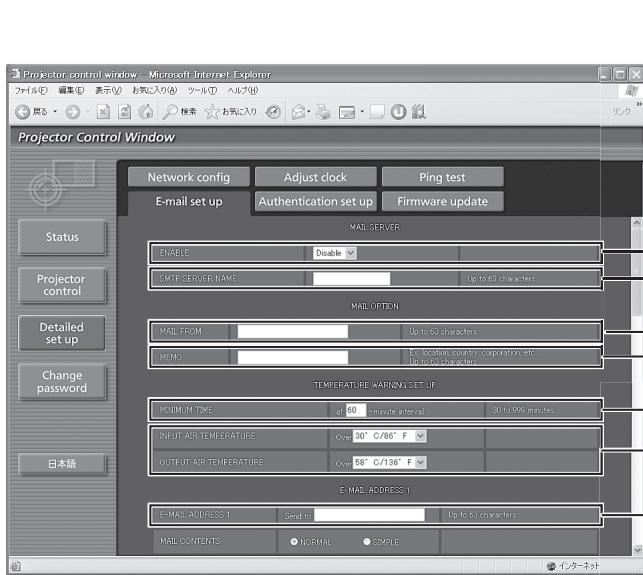

Select "Enable" to use the E-mail function.

Enter the IP address or server name of the E-mail server (SMTP). The DNS server must be set if the server name is entered.

Enter the E-mail address of the projector. (maximum 63 characters)

The user can enter the location of, for example, the installed projector so that the recipient may easily identify the originator of the E-mail. (maximum 63 characters)

The user can modify the minimum time interval of temperature warning mail. The default value is 60 minutes. In this case, the user cannot send another mail for 60 minutes after sending previous temperature warning mail even the set warning temperature is reached again.

The user can modify the threshold temperature for sending temperature warning mail. If the temperature rises above the set value, control sends temperature warning mail.

Enter the E-mail address of your desired recipient.

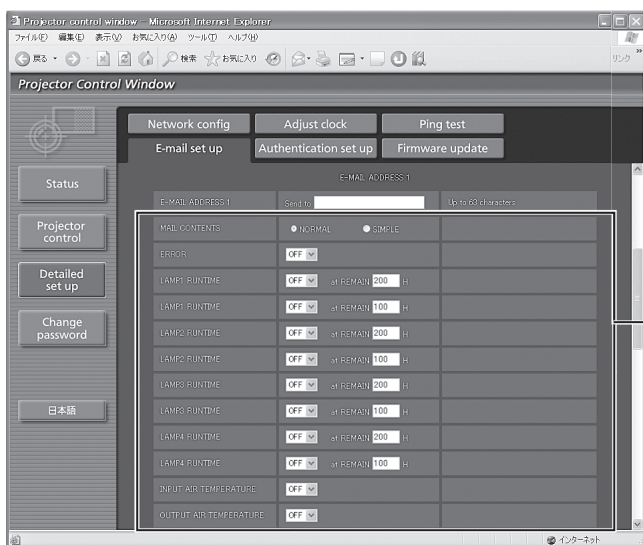

Select the conditions for sending E-mail.

MAIL CONTENTS:

Select "NORMAL" or "SIMPLE".

ERROR:

an error is detected by self-diagnosis.

LAMP1 RUNTIME:

remaining lamp service time has reached the value set in the field.

LAMP2 RUNTIME:

remaining lamp service time has reached the value set in the field.

LAMP3 RUNTIME:

remaining lamp service time has reached the value set in the field.

LAMP4 RUNTIME:

remaining lamp service time has reached the value set in the field.

INPUT AIR TEMPERATURE:

intake air temperature has reached the value set in the field.

OUTPUT AIR TEMPERATURE:

exhaust temperature has reached the value set in the field.

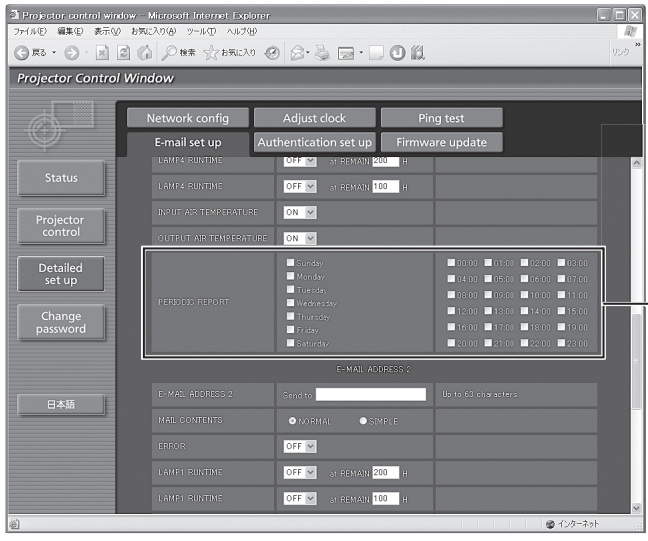

Periodic warning interval setting (E-mail is sent on the checked days of the week/times)

How to use network functions (continued)

E-mail setup page (continued)

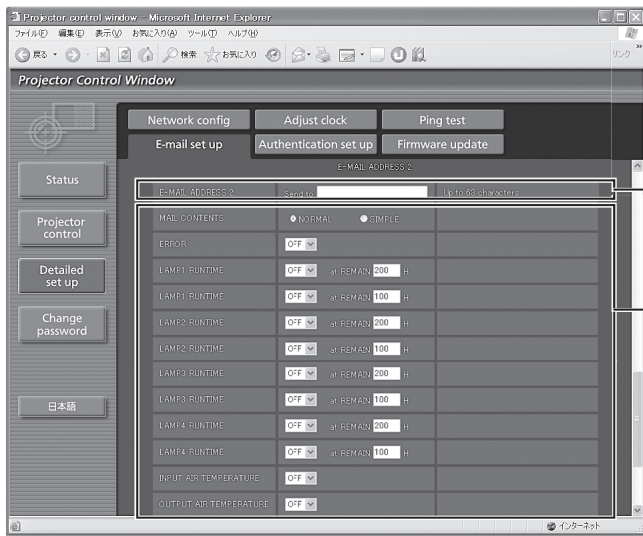

Enter the E-mail address to which the E-mail is to be sent when two E-mail addresses are going to be used. Do not enter it when the second E-mail address is not going to be used.

Select the conditions for sending E-mail to the second E-mail address.

MAIL CONTENTS:
Select "NORMAL" or "SIMPLE".

ERROR:
an error is detected by self-diagnosis.

LAMP1 RUNTIME:
remaining lamp service time has reached the value set in the field.

LAMP2 RUNTIME:
remaining lamp service time has reached the value set in the field.

LAMP3 RUNTIME:
remaining lamp service time has reached the value set in the field.

LAMP4 RUNTIME:
remaining lamp service time has reached the value set in the field.

INPUT AIR TEMPERATURE:
intake air temperature has reached the value set in the field.

OUTPUT AIR TEMPERATURE:
exhaust temperature has reached the value set in the field.

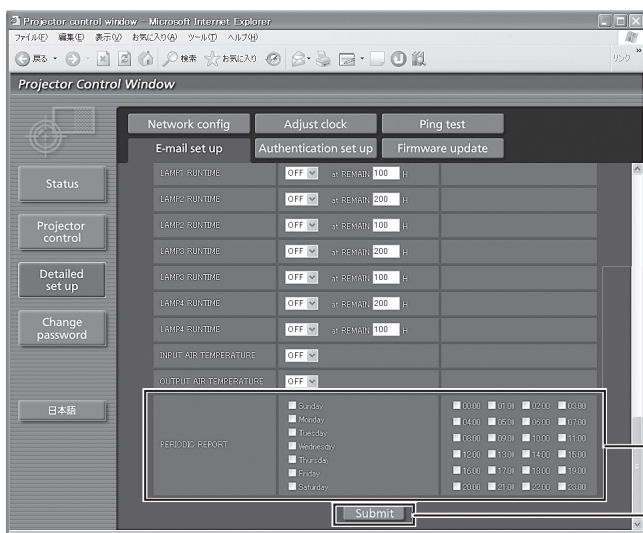

Check these boxes when E-mail is to be sent periodically to the second E-mail address. E-mail will be sent at the times and on the days checked.

Button to update settings

Authentication set up page

The POP server is set on this page when POP authentication is required for mail transmissions. Click [Detailed set up], then [Authentication set up] to display the POP server setup page.

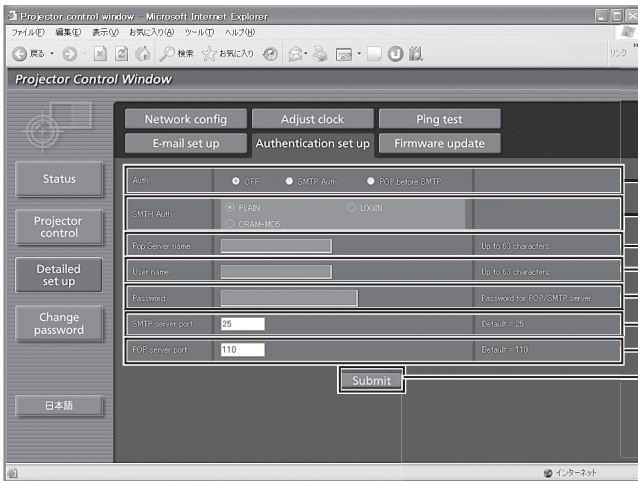

Select the authentication method specified by your Internet service provider.

Set this if SMTP authentication has been selected.

POP server name field
Available input characters:
 Alphanumeric characters (A–Z, a–z, 0–9), hyphen (-), period (.)

POP server user name field

POP server password field

Enter the port number for the SMTP server (normally “25”).

Enter the port number for the POP server (normally “110”).

Button to update settings

Ping test page

This page makes it possible to check whether the network is connected to the E-mail server, POP server, DNS server, etc.

Click [Detailed set up], then [Ping test] to display the Ping test page.

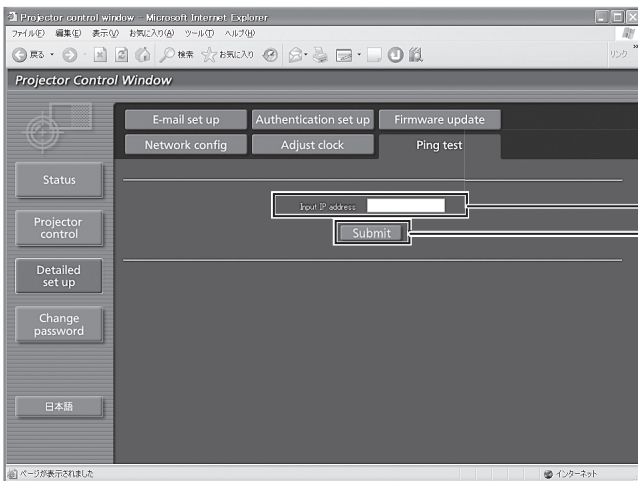

Enter the IP address of the server to be tested.

Button for conducting the test.

```
PING 198.245.80.10 (198.245.80.10): 56 data bytes
64 bytes from 198.245.80.10: icmp_seq=0 ttl=255 time=0.7 ms
64 bytes from 198.245.80.10: icmp_seq=1 ttl=255 time=0.4 ms
64 bytes from 198.245.80.10: icmp_seq=2 ttl=255 time=0.4 ms
64 bytes from 198.245.80.10: icmp_seq=3 ttl=255 time=0.4 ms

--- 198.245.80.10 ping statistics ---
4 packets transmitted, 4 packets received, 0% packet loss
round-trip min/avg/max = 0.4/0.4/0.7 ms
```

Display which appears when the connection was successful.

```
PING 198.245.80.100 (198.245.80.100): 56 data bytes

--- 198.245.80.100 ping statistics ---
4 packets transmitted, 0 packets received, 100% packet loss
```

Display which appears when the connection failed.

How to use network functions (continued)

■ Contents of mail sent

- Mail with the contents shown below is sent when the E-mail settings have been established.

```
=== Panasonic projector report(CONFIGURE) ===
Projector Type      : DZ12000

----- E-mail setup data -----
TEMPERATURE WARNING SETUP
MINIMUM TIME       at [ 60] minutes interval
INPUT AIR TEMPERATURE Over [ 35degC / 95degF ]
OUTPUT AIR TEMPERATURE Over [ 60degC / 140degF ]

ERROR              [ ON ]
LAMP1 RUNTIME      [ OFF ] at REMAIN [ 200] H
LAMP1 RUNTIME      [ OFF ] at REMAIN [ 100] H
LAMP2 RUNTIME      [ OFF ] at REMAIN [ 200] H
LAMP2 RUNTIME      [ OFF ] at REMAIN [ 100] H
LAMP3 RUNTIME      [ OFF ] at REMAIN [ 200] H
LAMP3 RUNTIME      [ OFF ] at REMAIN [ 100] H
LAMP4 RUNTIME      [ OFF ] at REMAIN [ 200] H
LAMP4 RUNTIME      [ OFF ] at REMAIN [ 100] H
INPUT AIR TEMPERATURE [ OFF ]
OUTPUT AIR TEMPERATURE [ OFF ]

PERIODIC REPORT
Sunday [ ON ] Monday [ ON ] Tuesday [ ON ] Wednesday [ ON ]
Thursday [ ON ] Friday [ ON ] Saturday [ ON ]

00:00 [ ON ] 01:00 [ ON ] 02:00 [ ON ] 03:00 [ ON ]
04:00 [ ON ] 05:00 [ ON ] 06:00 [ ON ] 07:00 [ ON ]
08:00 [ ON ] 09:00 [ ON ] 10:00 [ ON ] 11:00 [ ON ]
12:00 [ ON ] 13:00 [ ON ] 14:00 [ ON ] 15:00 [ ON ]
16:00 [ ON ] 17:00 [ ON ] 18:00 [ ON ] 19:00 [ ON ]
20:00 [ ON ] 21:00 [ ON ] 22:00 [ ON ] 23:00 [ ON ]

----- check system -----
MAIN CPU BUS      [ OK ]
FAN               [ OK ]
OPTICS MODULE TEMPERATURE [ OK ]
INPUT AIR TEMPERATURE [ OK ]
OUTPUT AIR TEMPERATURE [ OK ]
LAMP1 REMAIN TIME [ OK ]
LAMP2 REMAIN TIME [ OK ]
LAMP3 REMAIN TIME [ OK ]
LAMP4 REMAIN TIME [ OK ]
```

- Mail with the contents shown below is sent when an error has occurred.

```
=== Panasonic projector report(ERROR) ===
Projector Type      : DZ12000

----- check system -----
MAIN CPU BUS      [ OK ]
FAN               [ OK ]
OPTICS MODULE TEMPERATURE [ OK ]
INPUT AIR TEMPERATURE [ OK ]
OUTPUT AIR TEMPERATURE [ OK ]
LAMP1 REMAIN TIME [ OK ]
LAMP2 REMAIN TIME [ OK ]
LAMP3 REMAIN TIME [ OK ]
LAMP4 REMAIN TIME [ OK ]
LAMP1 STATUS      [ OK ]
LAMP2 STATUS      [ OK ]
LAMP3 STATUS      [ OK ]
LAMP4 STATUS      [ OK ]
APERTURE(CONTRAST-SHUTTER) [ OK ]
SHUTTER(MUTE-SHUTTER) [ OK ]
DIRTY AIR FILTER   [ FAILED ]
AIR FILTER CLEANER UNIT [ OK ]
OPTICS MODULE TEMP.SENSOR [ OK ]
INPUT AIR TEMP.SENSOR [ OK ]
OUTPUT AIR TEMP.SENSOR [ OK ]
BATTERY           [ OK ]
CLOGGED FILTER SENSOR [ OK ]
LENS SHIFT        [ OK ]
COVER OPEN        [ OK ]
AC POWER          [ OK ]
(Error code 00 00 00 00 00 00 00 00 00 00 00 10 00 00 00 00)

Input air temperature      : 27 degC / 80 degF
Optics module temperature  : 34 degC / 93 degF
Output air temperature     : 33 degC / 91 degF
SET RUNTIME                12 H
POWER ON                   12 times
LAMP1 ON                   419 times
LAMP1 HIGH                 314 H
LAMP2 ON                   363 times
LAMP2 HIGH                 252 H
```

Adjust clock page

Click [Detailed set up], then [Adjust clock] to display the Adjust clock page.

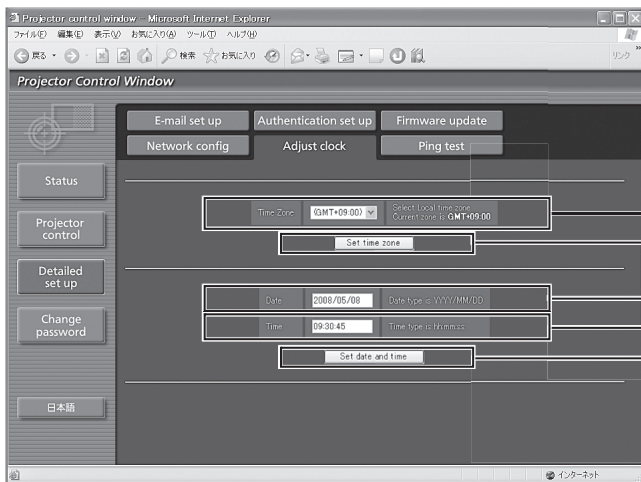

Time zone selection

Button to update time zone setting

New date field

New time field

Button to update time and date settings

Note

- If the time becomes incorrect immediately after setting the correct time, then the battery needs to be changed. Contact the dealer where you bought the projector to have the battery changed.

Network config page

Click [Detailed set up], then [Network config] to display the Network config page.

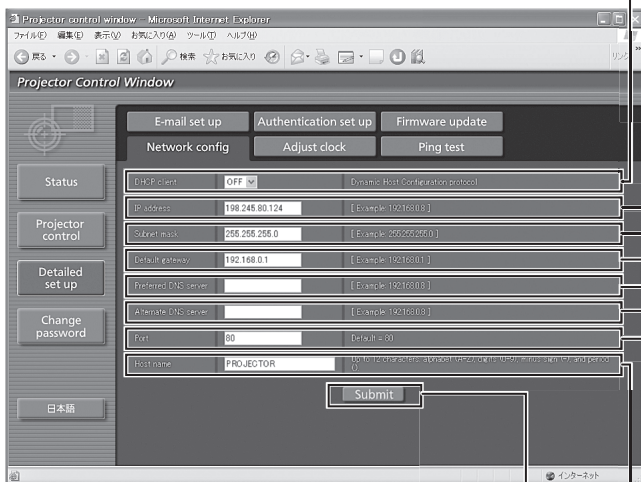

Set this to ON to enable the DHCP client function.

Enter the IP address if DHCP server is not used.

Enter the net mask if DHCP server is not used.

Enter the gateway address if DHCP server is not used.

DNS server address (primary) field
Available input characters:
Numeric characters (0–9), period (.)
(Example: 192.168.0.253)

DNS server address (secondary) field
Available input characters:
Numeric characters (0–9), period (.)
(Example: 192.168.0.254)

Enter the port number here. Number 80 is normally used.

Enter the name of the projector here. Enter the host name here if it is required when the DHCP server is going to be used, for instance.

Button to update settings

How to use network functions (continued)

Firmware update page

(The firmware should be updated only by an individual with the specialized knowledge required to do this.)

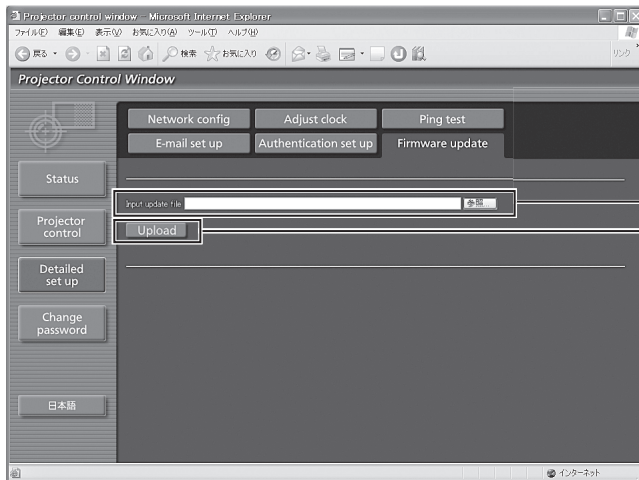

Enter here the filename of the firmware to be updated.

After entering the filename, press the [Upload] button. Data transfer is now commenced. It will require several minutes for the data to be transferred. The time taken will differ depending on the network conditions.

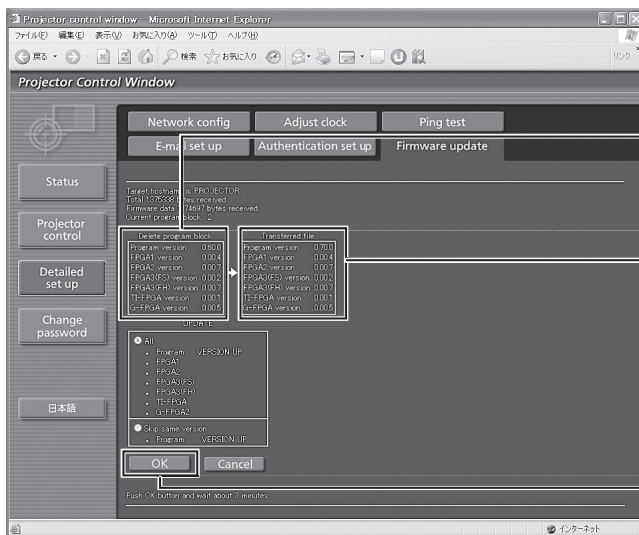

Displays the current version.

Displays the updated version.

Check the updated version against the current version, and if everything is in order, press the [OK] button. Version data rewriting is now commenced. Do not turn off the power while the version data is being rewritten.

Messages such as the ones shown below appear during data rewriting.

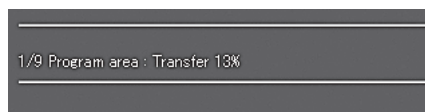
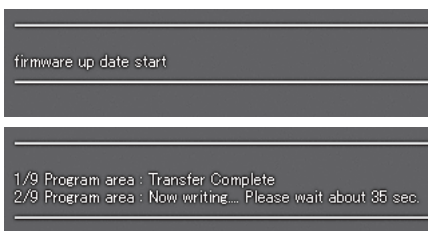

The following message appears upon completion of the version data rewriting.

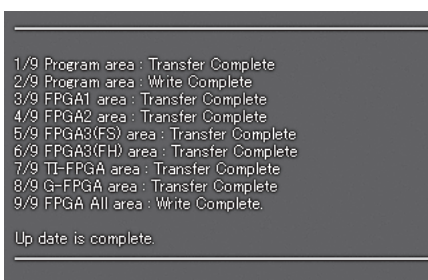

Using the PJLink™ protocol

The network function of the projector supports PJLink™ class 1, and the PJLink™ protocol can be used to perform projector setting and projector status query operations from a PC.

Supported commands

The following table lists the PJLink™ protocol commands that can be used to control the projector.

Command	Control details	Notes
POWR	Power supply control	Parameters 0 = Standby 1 = Power ON
POWR ?	Power supply status query	Parameters 0 = Standby 1 = Power ON 2 = Cool-down in progress 3 = Warm-up in progress
INPT	Input selection	Parameters 11 = RGB1 12 = RGB2 21 = VIDEO 22 = S-VIDEO 31 = DVI-D 32 = AUX (only enabled if ET-MD77DV, ET-MD77SD1, ET-MD77SD3 or ET-MD100SD4 is installed)
INPT ?	Input selection query	
AVMT	Shutter control	Parameters 30 = Shutter mode off (picture mute canceled) 31 = Shutter mode on (picture mute)
AVMT ?	Shutter mode query	
ERST?	Error status query	Parameters 1st byte: Indicates fan errors, range 0--2 2nd byte: Indicates lamp errors, range 0--2 3rd byte: Indicates temperature errors, range 0--2 4th byte: Indicates cover open errors, range 0--2 5th byte: Indicates filter errors, range 0--2 6th byte: Indicates other errors, range 0--2 Definitions for each value from 0 to 2 are as follows. 0 = No error known 1 = Warning 2 = Error
LAMP ?	Lamp status query	Parameters 1st digits (1--5 digits): Lamp 1 cumulative operating time 2nd digit: 0 = Lamp 1 off, 1 = Lamp 1 on 3rd digits (1--5 digits): Lamp 2 cumulative operating time 4th digit: 0 = Lamp 2 off, 1 = Lamp 2 on 5th digits (1--5 digits): Lamp 3 cumulative operating time 6th digit: 0 = Lamp 3 off, 1 = Lamp 1 on 7th digits (1--5 digits): Lamp 4 cumulative operating time 8th digit: 0 = Lamp 4 off, 1 = Lamp 2 on
INST ?	Input selection list query	The following are returned as parameters. "11 12 21 22 31" (If any of the ET-MD77DV, ET-MD77SD1, ET-MD77SD3 or ET-MD100SD4 are installed, "11 12 21 22 31 32" is returned.)
NAME ?	Projector name query	The name set for "HOST NAME" in "NETWORK" is returned.
INF1 ?	Manufacturer name query	"Panasonic" is returned.
INF2 ?	Model name query	"D12000" or "DZ12000" is returned.
INFO ?	Other information query	Information such as version number is returned.
CLSS ?	Class information query	"1" is returned.

■ PJLink™ security authorization

When using PJLink™ with security authorization, either of the password set for administrator privileges and the password set for user privileges with Web browser control can be used as the password for PJLink™. When using PJLink™ without security authorization, set use without the password for administrator privileges and the password for user privileges of Web browser control.

- PJLink™ is a pending trademark in Japan, the United States, and other countries and regions. For specifications regarding PJLink™, refer to the Japan Business Machine and Information System Industries Association website.
URL: <http://pjlink.jbmia.or.jp/>

Using the serial terminals

The main unit is equipped with SERIAL terminals located in its connection terminals, and this terminal is compliant with RS-232C/RS-422. Also a serial output terminal is provided to enable plural projector control.

Examples of connection

■ For RS-232C

● Single projector

D-Sub 9-pin (female)

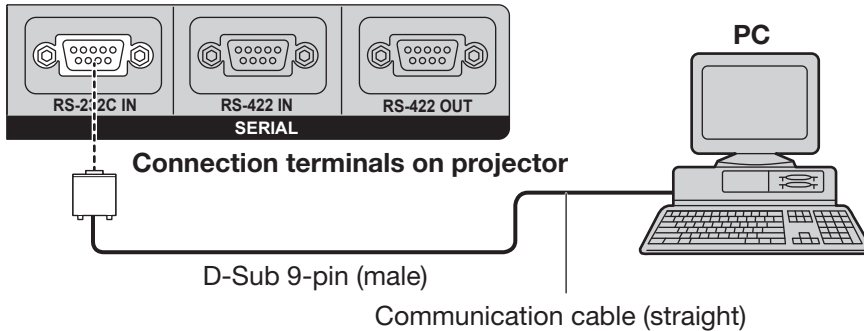

● Multiple projectors

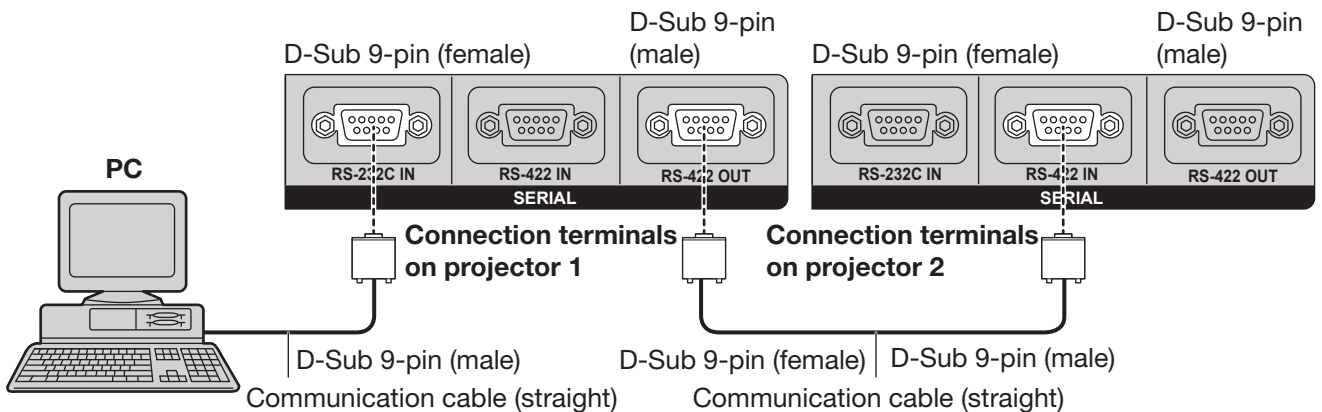

■ Pin assignments and signal names

Pin No.	Signal name	Description
①		NC
②	TXD	Send data
③	RXD	Receive data
④		Connected internally
⑤	GND	Ground
⑥		NC
⑦	CTS	Connected internally
⑧	RTS	
⑨		NC

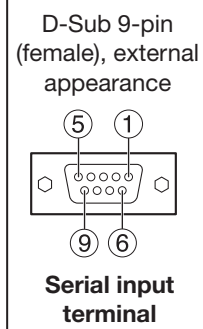

■ Communication conditions (Factory setting)

Signal level	RS-232C-compliant
Synchronization method	Start-stop synchronization
Baud rate	9 600bps
Parity	None
Character length	8 bits
Stop bit	1 bit
X parameter	None
S parameter	None

■ For RS-422

● Single projector

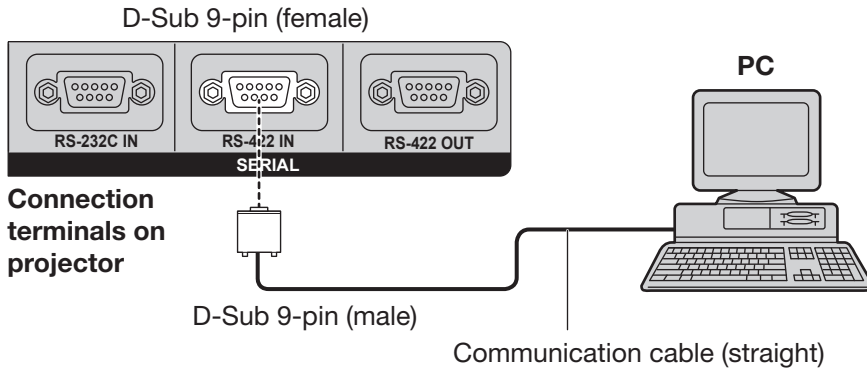

● Multiple projectors

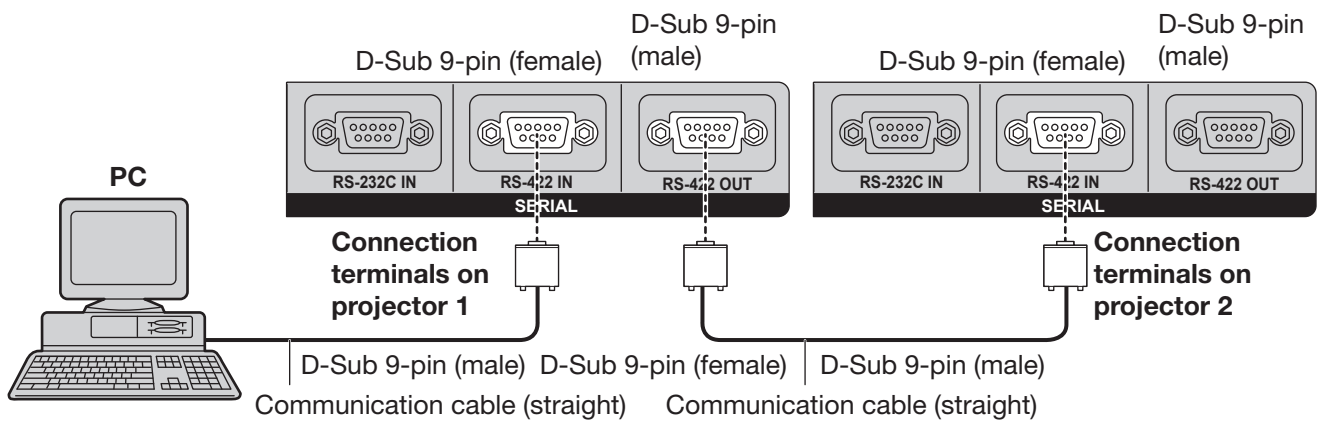

■ Pin assignments and signal names

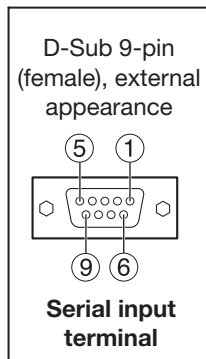

Pin No.	Signal name	Description
①		NC
②	TXD(-)	Data transmit terminal (-)
③	RXD(+)	Data receive terminal (+)
④		Connected internally
⑤		NC
⑥		Connected internally
⑦	TXD(+)	Data transmit terminal (+)
⑧	RXD(-)	Data receive terminal (-)
⑨	FG	GND

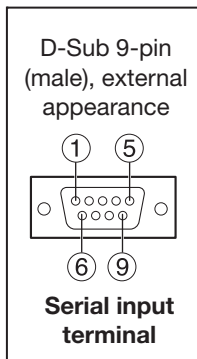

Pin No.	Signal name	Description
①		NC
②	RXD(-)	Data receive terminal (-)
③	TXD(+)	Data transmit terminal (+)
④		Connected internally
⑤		NC
⑥		Connected internally
⑦	RXD(+)	Data receive terminal (+)
⑧	TXD(-)	Data transmit terminal (-)
⑨	FG	GND

■ Communication conditions (Factory setting)

Signal level	RS-422-compliant
Synchronization method	Start-stop synchronization
Baud rate	9 600bps
Parity	None
Character length	8 bits
Stop bit	1 bit
X parameter	None
S parameter	None

Using the serial terminals (continued)

Basic format

Transmission from the computer begins with STX, then the ID, command, parameter, and ETX are sent in this order. Add parameters according to the details of control.

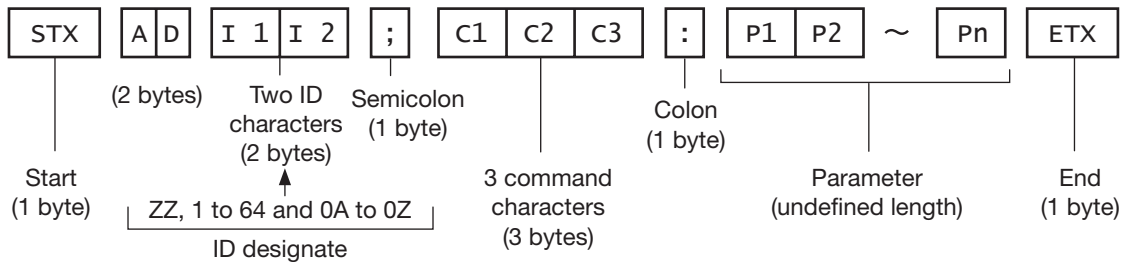

Attention

- No command can be sent or received for 10 to 60 seconds after the lamp starts lighting. Try sending any command after that period has elapsed.
- When transmitting multiple commands, be sure to wait until 0.5 seconds has elapsed after receiving the response from the projector before sending the next command. When sending commands without parameters, a colon (:) is not necessary.

Note

- When the wrong command is sent, the “ER401” or “ER402” status is sent from the projector to the personal computer.
- Projector ID supported on the RS-232C interface is ZZ (ALL) and a group of 1 to 64 and 0A to 0Z.
- The “STX” character code is 02 and the “ETX” character code is 03.
- If a command is sent with a projector ID specified, the projector will return answer back only in the following cases:
 If it coincides with the projector ID
 If the ID specification is ALL and responding (ID ALL) is on
 If the ID specification is Group and responding (ID Group) is on

Control commands

When controlling the projector from a computer, the following commands are available:

Command	Function of command	Remarks
PON	Power “ON”	In standby mode, commands other than “PON” are invalid. • While the lamp is ON and being controlled, a “PON” command will not be accepted.
POF	Power “OFF”	
IIS	Switch input modes	Parameter VID = VIDEO SVD = S-VIDEO DVI = DVI-D RG1 = RGB1 RG2 = RGB2 AUX = AUX
QSL	Query for active lamp mode	Parameter 0 = QUAD, 1 = L1/L4, 2 = L2/L3, 3 = DUAL, 4 = L1/L2/L3, 5 = L1/L2/L4, 6 = L1/L3/L4, 7 = L2/L3/L4, 8 = TRIPLE, 9 = L1, 10 = L2, 11 = L3, 12 = L4, 13 = SINGLE
LPM	Active lamp mode	Parameter 0 = QUAD, 1 = L1/L4, 2 = L2/L3, 3 = DUAL, 4 = L1/L2/L3, 5 = L1/L2/L4, 6 = L1/L3/L4, 7 = L2/L3/L4, 8 = TRIPLE, 9 = L1, 10 = L2, 11 = L3, 12 = L4, 13 = SINGLE

Note

- If you need a detailed command list, please contact your dealer.

Cable specifications

■ Connecting to a PC

- For RS-232C

Projector		Computer (DTE specifications)	
1	NC	NC	1
2			2
3			3
4	NC	NC	4
5			5
6	NC	NC	6
7			7
8			8
9	NC	NC	9

■ When multiple projectors are connected

1st (RS-422 OUT)	2nd (RS-422 IN)
1	1
2	2
3	3
4	4
5	5
6	6
7	7
8	8
9	9

Attention

- To connect the computer to the SERIAL terminal, prepare an adequate communication cable that fits to your personal computer.

Using the Remote 2 terminal

Using the REMOTE 2 terminal provided on the connection terminals of the main unit, it is possible to operate the projector from a control panel etc. furnished in a distant location where infrared remote control signal cannot be received.

Example of a control panel layout

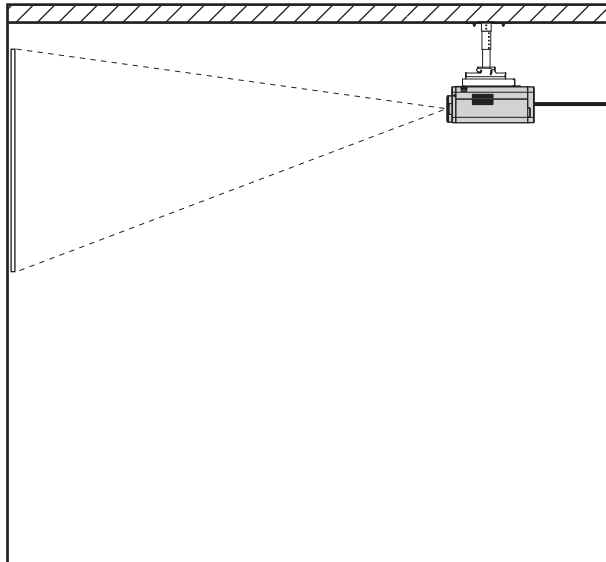

Projector set up in a meeting room

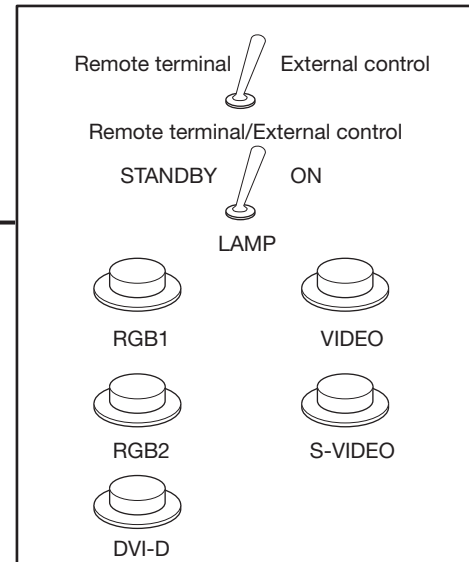

Control panel located in a different room

Pin assignments and control

Be sure to short-circuit Pins ① and ⑨ when controlling.

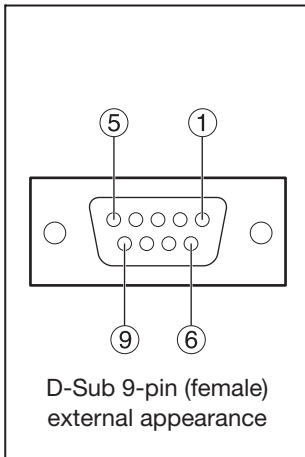

	Names of terminals	Open (H)	Short (L)
①	GND		GND
②	POWER	OFF	ON
③	RGB1	Other	RGB1
④	RGB2	Other	RGB2
⑤	VIDEO	Other	VIDEO
⑥	S-VIDEO	Other	S-VIDEO
⑦	DVI-D	Other	DVI-D
⑧	SHUTTER	OFF	ON
⑨	RST / SET	Controlled by remote control	Controlled by external contact

Note

- The above figure shows the pin assignment and control details when "REMOTE2 MODE" (p. 80) is "DEFAULT". When using "REMOTE2 MODE" with "USER", the pin assignment and control details are those set for "USER".
- When pin ① and pin ⑨ are short-circuited, the following buttons on the projector's control panel and on the remote control cannot be used.
POWER button, SHUTTER button
In addition, the RS-232C commands and network functions that correspond to these functions cannot be used either.
- When pin ① and pin ⑨ are short-circuited and then any one of pins ③ to ⑦ is short-circuited to pin ①, the following buttons on the projector's control panel and on the remote control cannot be used.
POWER button, input selection buttons (RGB1, RGB2, DVI-D, AUX, VIDEO, S-VIDEO), SHUTTER button
In addition, the RS-232C commands and network functions that correspond to these functions cannot be used either.

Monitor Lamp Indicators

Five monitor lamps are provided at the top of main unit front to inform the user of the lamp replacement time and unusual internal temperature. These lamps indicate the degree of abnormality by combination of blinking and/or lighting lamps. Turn off the power and take the proper measure according to the table below.

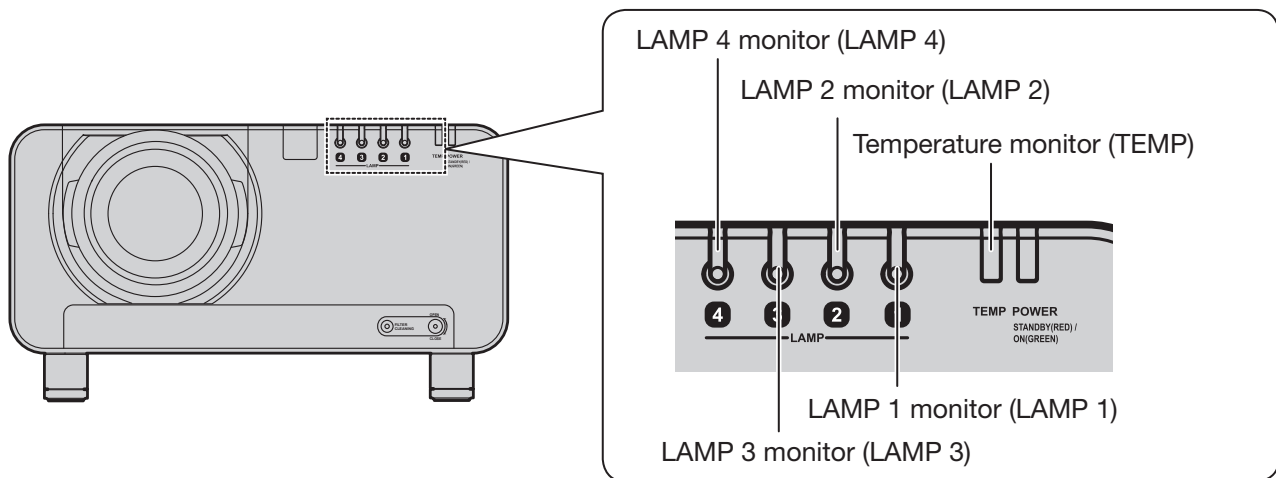

Name of monitor lamp	Lamp indication	Information	Check point	Remedial measure
TEMP monitor	Lighting in red	Warm-up status	<ul style="list-style-type: none"> Did you turn on the power when the ambient temperature was low (approx. 0 °C)? 	<ul style="list-style-type: none"> Wait about five minutes in the current status. Install the unit in a location having an ambient temperature from 0 °C to 45 °C.
		High temperature inside. (WARNING)	<ul style="list-style-type: none"> Check if the ventilation port is blocked. Is the room air temperature too high? Is the air filter blocked with dust? 	<ul style="list-style-type: none"> Remove the object that is blocking the ventilation port. Move the projector to a temperature of 0 °C to 45 °C and the humidity of 10 % to 80 % (no condensation).
	Blinking in red (2 times)	High temperature inside (Standby condition)	<ul style="list-style-type: none"> Was the temperature warning indication displayed? 	<ul style="list-style-type: none"> Turn off the MAIN POWER switch using the procedure on page 39 and clean the air filter. (pp. 112-113)
	Blinking in red (3 times)	Cooling fan has been stopped.		<ul style="list-style-type: none"> Turn off the main power supply (MAIN POWER) switch in the procedure shown on page 39 and consult the distributor.
LAMP monitor	Lighting in red	Indicates the time for replacing the lamp unit.	<ul style="list-style-type: none"> Did you notice a "REPLACE THE LAMP" message on the screen when turning on the projector power supply? 	<ul style="list-style-type: none"> This lamp monitor lights up when the lamp unit used hours have reached 1 800 hours. Request the dealer to replace the lamp unit.
	Blinking in red (3 times)	Error is detected in the lamp circuit.	<ul style="list-style-type: none"> Did you turn the power back on immediately after turning it off? 	<ul style="list-style-type: none"> Wait until the lamp has cooled off, and then turn on the power.
<ul style="list-style-type: none"> Some error has arisen in the lamp circuit. Check for fluctuation (or drop) in the source voltage. 			<ul style="list-style-type: none"> Turn off the MAIN POWER switch using the procedure on page 39 and consult the dealer. 	

Attention

- Be sure to observe the procedure "Powering up the projector" (p. 38) and "Powering off the projector" (p. 39) when performing power supply operation to take a measure to the indication of temperature monitor (TEMP) lamp and lamp monitor (LAMP) lamp.

Cleaning and replacement of air filter

If the air filter is blocked with too much dust, the inside of the projector will become hot and the temperature monitor (TEMP) indicator will flash and the power will turn off. The static electric mesh filter should be replaced and the metal mesh filter and brush inside the filter unit should be cleaned after approximately 2 000 hours of use, although this is a guide only and the actual time will vary depending on the operating conditions.

Procedure of cleaning

1. Turn off the main power and remove the power plug from the receptacle.

- Turn off the main power supply observing the procedure (How to turn "OFF" the power supply) on page 39 and then remove the power plug.

2. Use a Phillips screwdriver to loosen the filter cleaning unit fixing screw at the front of the projector.

- Insert your hand into the base of the air filter and pull the air filter forwards while removing the filter cleaning unit from the projector.

3. Remove the static electric mesh filter from the filter cleaning unit.

- Loosen the static electric mesh filter so that it can be removed, and then remove it.

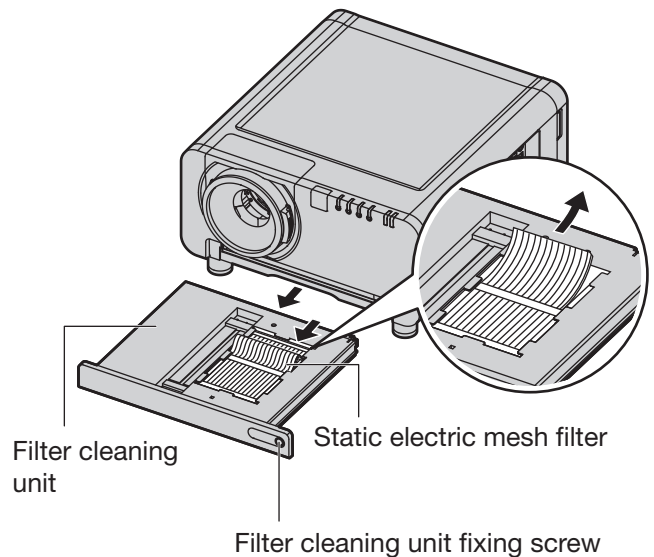

4. Place the filter cleaning unit upside down.

5. Remove the four brush cover fixing screws, and then remove the brush cover and the movable metal mesh filter from the filter cleaning unit.

Brush cover fixing screws (4 places)

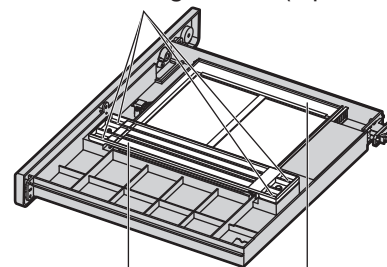

6. Clean the filter cleaning unit, brush and movable metal mesh filter.

- Use a vacuum cleaner to remove any dust blockages.

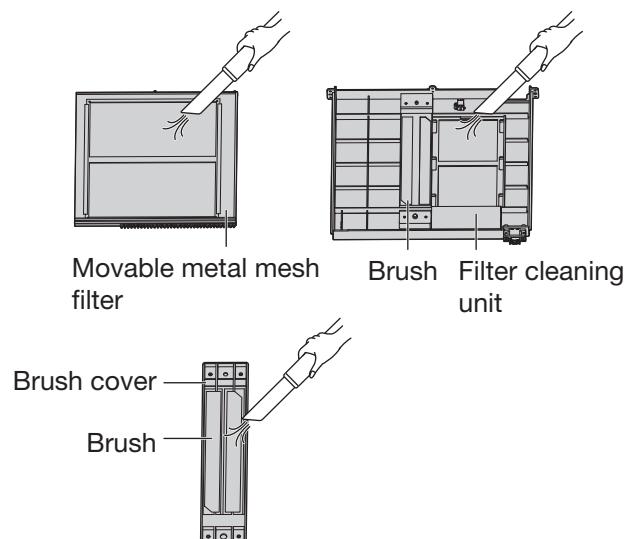

7. Install the movable metal mesh filter to the filter cleaning unit.

- When reassembling, align the edge of the movable metal mesh filter with position (A).
- Hook the movable metal mesh filter onto the gear and the rail.
- The movable metal mesh filter will be set to the correct position after the set is installed and the power is turned on, so it can be installed in the middle position during reassembly without any problem.

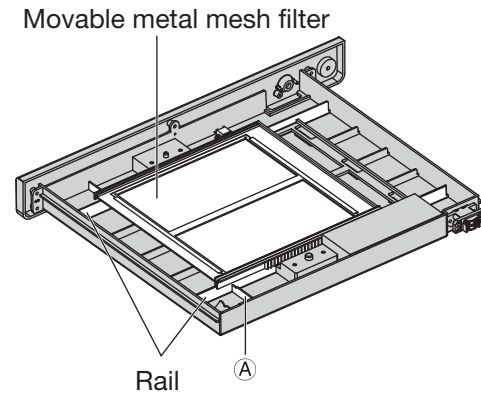

8. Install the brush cover so that it is aligned with the positioning pin guide, and then tighten the four brush cover fixing screws.

Brush cover fixing screws (4 places)

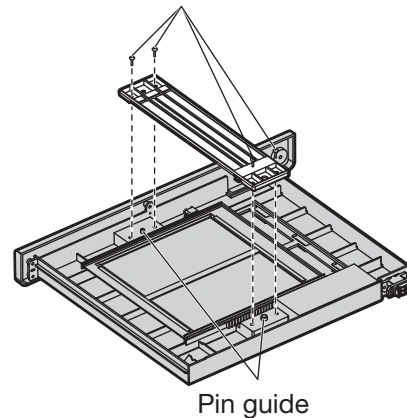

9. Install the new static electric mesh filter to the filter cleaning unit.

10. Insert the filter cleaning unit into the projector, and then securely tighten the filter cleaning unit fixing screw.

- Install the air filter, and then install the filter cleaning unit by carrying out removal step 2 in reverse.

Attention

- The air filter must be installed before using the projector. If the projector is used without the air filter installed, foreign particles and dust will get inside the projector and cause problems with operation.

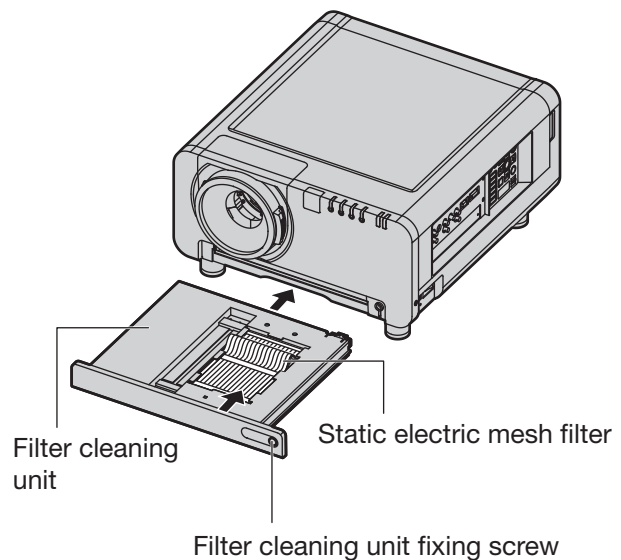

Note

- If cleaning cannot remove the dust completely, then it is a sign to replace the static electric mesh filter. Consult the dealer. In addition, when the lamp unit is replaced, also replace the static electric mesh filter.
- Do not wash the static electric mesh filter with water.
- Use a neutral detergent to clean off any oil from the movable metal mesh filter.

Replacement of lamp unit

WARNING

- Wait until the lamp is cooled sufficiently before replacing the lamp unit.
- Make sure that all four lamp units are installed.
- Replacement of the lamp unit should be carried out by a qualified technician.
- Do not remove any screws (such as the black screws) other than those indicated when replacing the lamp unit. If this is not observed, electric shocks, burns or other injuries may occur.

Precautions on lamp unit replacement

- Be careful when handling a light source lamp. The lamp unit has high internal pressure. If improperly handled, failure might result.
- A used lamp unit may burst if it is handled violently. For disposition of used lamps, request an industrial waste disposal contractor.
- If you continue to use a lamp after the replacement time, the lamp may break.
- Phillips screwdriver is necessary when replacing a lamp unit. Take care not to slip your hand when using a screwdriver.

Attention

- A lamp unit is an optional part. Contact the dealer.
Replacement Lamp Unit model No.: ET-LAD12K (single bulb), ET-LAD12KF (4 bulbs)
Rating: 300 W
- Other lamps than specified above cannot be used. Be sure to use the specified lamp.

Timing of lamp unit replacement

The lamp used for the light source has its due life. The life of the lamp used in the main unit is 2 000 hours. However, it may happen that the lamp becomes dead (will not light) by the time of 2 000 hours depending on the characteristics of individual lamps and working conditions (lamp life is affected by the times of lighting and the intervals between previous lighting and next lighting). Therefore, it is strongly recommended for the user to keep a spare bulb.

If a lamp unit has not been replaced after 2 000 hours of operation have elapsed, the lamp will turn off automatically. When the operating time for all of the lamps reaches 2 000 hours or more, the power will turn off automatically approximately 10 minutes after it is turned on, and the projector will switch to standby mode.

Attention

- Clean and replace the air filter when replacing the lamp units. (pp. 112-113)

■ Indication after 1 800 hours

When lamp unit used hours have reached 1 800 hours, lamp monitor (LAMP1, LAMP2, LAMP3, or LAMP4) light up including standby state.

Further, an on-screen indication will appear for about 30 seconds as shown in the diagram, recommending replacement of lamp unit. (The indication will disappear after about 30 seconds or when either control button on the main unit or remote control button is pressed.)

After 2 000 hours, the on-screen indication will not disappear unless the menu (MENU) button is pressed.

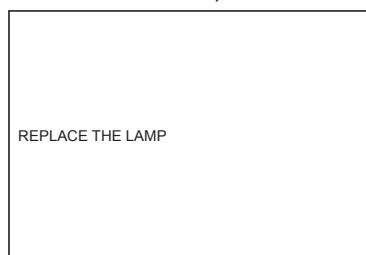

Procedure of lamp unit replacement

1. Turn the main power OFF, following the procedures described in “Powering up the projector” (p. 38) and “Powering off the projector” (p. 39), disconnect the power plug from the AC power source, and wait for one hour or more. Then check that the lamp unit has cooled down.

2. Use a Phillips screwdriver to loosen the lamp unit cover screw at the rear of the projector until the screw turns freely.

3. Open the lamp unit cover and remove it from the projector.

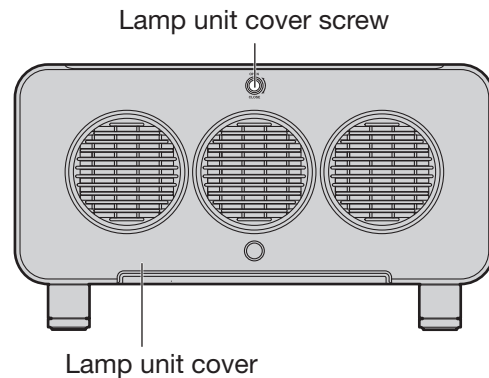

4. Use a Phillips screwdriver to loosen the three fixing screws for the lamp unit to be replaced until the screws turn freely. Hold the handle of the lamp unit and gently pull the lamp unit out from the projector.

CAUTION

The lamp unit and structural parts around the lamp unit will be hot immediately after the projector has been used. You might get burned if you touch it while it is still hot.

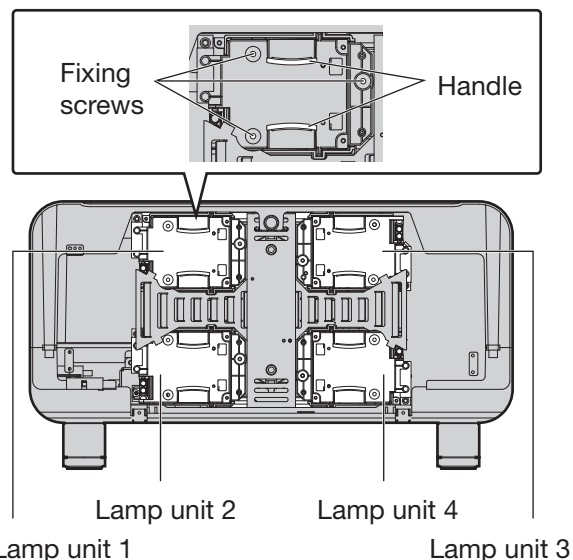

5. Install the new lamp unit.

6. Use a Phillips screwdriver to securely tighten the 3 lamp unit fixing screws for each lamp unit.

7. Install and close the lamp unit cover, and then use a Phillips screwdriver to securely tighten the lamp unit cover screw.

Caution

- Firmly install the lamp unit and lamp unit cover. If not installed firmly, a protection circuit will function and the power will not be turned on.

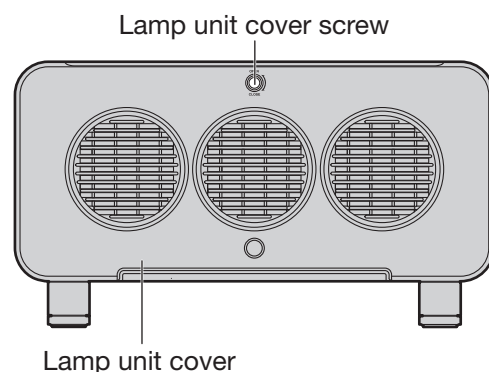

Notes when installing the ceiling mount bracket

When installing the ceiling mount bracket to the projector, install the accessory eye bolts and wires to the projector. (The projector will still be safe if they are not used, however they will help prevent the possibility of accidents caused by the projector falling down if the screws happen to become loose.)

Installation should be carried out by a qualified technician by following the procedure given below.

- Panasonic takes no responsibility for any losses or damage occurring as a result of using a ceiling mount bracket not manufactured by Panasonic, or if damage to the projector occurs as a result of an inappropriate location used for installing the ceiling mount bracket, even if the projector's warranty period has not yet expired.
- Use a torque screwdriver or similar tool to tighten the screws. Do not use tools such as electric screwdrivers or impact screwdrivers.
- Dispose of any used products as soon as possible by asking a qualified technician for assistance.

Attention

- Be sure to use the accessory eye bolts and wires.

Installation procedure

1. Place the projector on a soft cloth with the base facing upward.
2. Turn the four adjustable feet counterclockwise and remove them from the projector.

The adjustable feet will be used if the projector is installed normally, so store them safely.

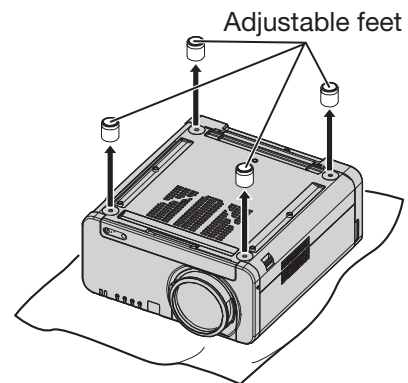

3. Turn the four eye bolts clockwise to install them to the projector.

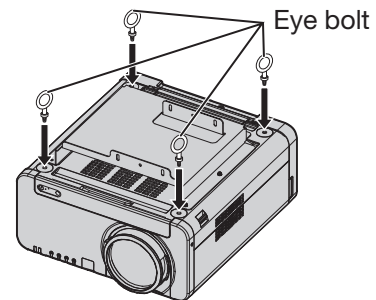

4. Install each of the four wires to the four eye bolts.
5. Pull the four accessory wires from the eye bolts to the ceiling in four directions.

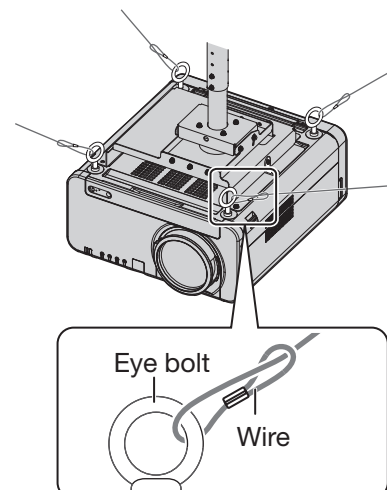

Before asking for service

... try to check the following points again.

Symptoms	Check point	Page
Power does not turn on	• Is the power cord securely plugged in the receptacle?	37
	• Is the MAIN POWER switch put to the "O" position?	38-39
	• Is power supply live at the receptacle?	37
	• Is the temperature monitor (TEMP) lamp on the projector front lighting or blinking?	111
	• Is the lamp monitor (LAMP) lamp on the projector front lighting or blinking?	111
	• Is the lamp unit cover completely attached?	115
	• Was operation of ID setting made in a correctly way?	18, 77
	• Are all four lamp units installed?	114-115
No image appears on screen	• Is the screen image input connected in a correct manner?	28
	• Are the settings of switching input signals correct?	48, 58-59
	• Is the device(s) connected to the projector working normally?	—
	• Is the shutter or freeze function used?	48, 83
Screen image is blurred	• Is the lens in focus?	40
	• Is the projection distance adequate?	22-24
	• Is the lens dirty?	—
	• Is the projector installed in a suitable location?	20-21
Pale color / bad color tint	• Are COLOR and TINT correctly adjusted?	55
	• Is the device(s) connected to the projector adjusted correctly?	—
Remote control does not function	• Are dry batteries consumed?	—
	• Is polarity correct in battery setting?	17
	• Are there any obstacle between the remote control and the beam receiving window?	17
	• Are you trying to operate the remote control beyond the effective range?	17
	• Is the remote 2 (REMOTE2) terminal used for external control?	110
	• Is any external light interfering with the remote control operation?	—
	• Was operation of ID setting made in a correctly way?	18, 77
	• Is the LOCK button of the remote control at the lock position?	13
Abnormal image on the screen	• Is the input selector set to correct position?	48, 58-59
	• Is the correct signaling system selected?	58-59
	• Are there any malfunctions on the source side, such as bad video tape?	—
	• Are you supplying a signal that is not compatible with the projector?	122-123
Images from PC are not projected	• Is the cable too long?	—
	• Is the correct signal destination set for notebook computer screen image?	—
	• Use [Fn] and [F3] keys for setting. (For details, refer to the instruction manual of the computer.)	—
Pictures from the DVI-D output graphics board of a computer are not projected	• Is DVI-D IN or AUX DVI IN set to "EDID2 (PC)"?	73-74
	• The problem may be solved by updating the driver for the graphics board to the latest driver.	—

Self-diagnosis display

There is a self-diagnosis display located on the side of the projector (p. 15) for automatically displaying the corresponding details when an error or warning occurs.

Self-diagnosis display	Details	Remedy
U04	Air filter is blocked	<ul style="list-style-type: none"> Clean the air filter unit.
U11	Intake air temperature warning	<ul style="list-style-type: none"> Ambient temperature is too high.
U12	Optical module temperature warning	
U13	Lamp ambient temperature warning	
U14	Low temperature warning	
U15	The ambient temperature is 40 °C or more, so light output is being limited to protect the projector.	<ul style="list-style-type: none"> If 100% brightness is required, use the projector where the ambient temperature is less than 40 °C (35 °C in high altitude mode).
U21	Intake air temperature error	<ul style="list-style-type: none"> Ambient temperature is too high.
U22	Optical module temperature error	
U23	Lamp ambient temperature error	
U24	Low temperature error	
U41	Lamp 1 operating time warning	<ul style="list-style-type: none"> The lamp replacement period has arrived. Replace the lamp.
U42	Lamp 2 operating time warning	
U43	Lamp 3 operating time warning	
U44	Lamp 4 operating time warning	
U51	Lamp 1 error	<ul style="list-style-type: none"> Lamp has not turned on. Wait for the lamp to cool down and then turn the power back on. If the lamp still does not turn on, contact your dealer.
U52	Lamp 2 error	
U53	Lamp 3 error	
U54	Lamp 4 error	
U61	Lamp 1 : 2 000 hour operating time exceeded	<ul style="list-style-type: none"> The lamp has exceeded its replacement period. Replace the lamp straight away.
U62	Lamp 2 : 2 000 hour operating time exceeded	
U63	Lamp 3 : 2 000 hour operating time exceeded	
U64	Lamp 4 : 2 000 hour operating time exceeded	
U70	Air filter unit not installed	<ul style="list-style-type: none"> Install the air filter unit.
U71	Lamp 1 not installed	<ul style="list-style-type: none"> Install the lamp.
U72	Lamp 2 not installed	
U73	Lamp 3 not installed	
U74	Lamp 4 not installed	
U81	AC power supply voltage drop warning (less than 90 V)	<ul style="list-style-type: none"> AC power supply voltage input has dropped. Check that there is sufficient electrical wiring capacity for the projector's power consumption requirements.
U91	Lamp unit cover is not closed	<ul style="list-style-type: none"> Close the lamp unit cover.
H01	Internal clock battery replacement	<ul style="list-style-type: none"> The battery needs to be replaced. Consult your dealer.
H11	Air intake temperature sensor not found	<ul style="list-style-type: none"> If turning the main power off and back on again does not clear the error display, consult your dealer.
H12	Optical module temperature sensor not found	
H13	Lamp ambient temperature sensor not found	
H18	Clogged filter sensor not found	
F11	Shutter error	
F12	Dynamic iris error	
F13	Air filter unit error	
F21	2.5 V DC error	
F22	3.3 V DC error	
F23	5.0 V DC error	

Self-diagnosis display	Details	Remedy
F41	Lamp 1 memory error	<ul style="list-style-type: none"> • Problem with lamp. Consult your dealer.
F42	Lamp 2 memory error	
F43	Lamp 3 memory error	
F44	Lamp 4 memory error	
F61	Ballast 1 communication error	<ul style="list-style-type: none"> • If turning the main power off and back on again does not clear the error display, consult your dealer.
F62	Ballast 2 communication error	
F63	Ballast 3 communication error	
F64	Ballast 4 communication error	
F80	Resize IC setting error	
F81	FM-R test error	
F82	FM-G test error	
F83	FM-B test error	
F91	FPGA1 configuration error	
F92	FPGA2 configuration error	
F93	Flash ROM error	
F94	RAM error	
F95	FPGA expansion error	
F96	Lens shift error	
F97	Geometry correction board communication error	
FE1	Power supply fan error	
FE2	Lamp 1 fan error	
FE3	Lamp 2 fan error	
FE4	Lamp 3 fan error	
FE5	Lamp 4 fan error	
FE6	Ballast circuit 1 fan error	
FE7	Ballast circuit 3 fan error	
FE8	GB-DMD fan error	
FE9	Center exhaust fan error	
FF0	Left exhaust fan error	
FF1	Right exhaust fan error	
FF2	Red DMD cooling fan error	
FF3	Green DMD cooling fan error	
FF4	Blue DMD cooling fan error	
FF5	Color prism fan error	
FF6	Lamp prism fan error	
FF7	Ballast circuit 2 fan error	
FF8	Ballast circuit 4 fan error	
FF9	G prism fan error	

Note

- The self-diagnosis display and details of the failure may sometimes differ.

Specifications

Model No.		PT-D12000U	PT-DZ12000U	
Power supply		120 - 240 V, 50 Hz/60 Hz		
Power consumption		1 600W–1 500W (about 10 W (120V AC) / 15 W (240V AC) in standby)		
Amps		16 A–9.0 A		
DLP® Chip	Panel size	0.95 inch (aspect ratio 4:3)	0.96 inch (aspect ratio 16:10)	
	Display system	Three-unit DLP® chip, DLP® type		
	Number of pixels	3 × 1 470 000 pixels (1 400 × 1 050 dots)	3 × 2 304 000 pixels (1 920 × 1 200 dots)	
Lens (Powered zoom/ Powered focus control)		Option		
Projection lamp		4 bulbs × 300 W UHM lamp		
Optical output		12 000 lm (ANSI)		
Applicable scanning frequency	For video signal (S-video included)	Horizontally 15.75 kHz/15.63 kHz, vertically 60 Hz/50 Hz		
	For RGB signal	Horizontally 15 kHz–100 kHz, vertically 24 Hz–120 Hz, Panasonic Intelligent Auto Scanning (PIAS) system		
		Dot clock frequency 20 MHz–162 MHz		
	For DVI-D signal	480p, 576p, 720/60p, 720/59.94p, 720/50p, 1 080/60p, 1 080/59.94p, 1 080/50p, 1 080/60i, 1 080/59.94i, 1 080/50i, 1 080/24sF, 1 080/23.98sF, 1 080/30p, 1 080/29.97p, 1 080/25p, 1 080/24p, 1 080/23.98p	Displayable resolution : VGA-WUXGA (non-interlace) Dot clock frequency : 25 MHz-162 MHz • The WUXGA signals support only VESA CVT-RB (Reduced Blanking) signals.	
	For YP _B P _R signal	[480i] horizontally 15.73 kHz, vertically 59.94 Hz [480p] horizontally 31.5 kHz, vertically 59.94 Hz [576i] horizontally 15.63 kHz, vertically 50 Hz [576p] horizontally 31.25 kHz, vertically 50 Hz [720/50p] horizontally 37.5 kHz, vertically 50 Hz [720/60p] horizontally 45 kHz, vertically 60 Hz [1 035/60i] horizontally 33.75 kHz, vertically 60 Hz [1 080/60i] horizontally 33.75 kHz, vertically 60 Hz [1 080/50i] horizontally 28.13 kHz, vertically 50 Hz [1 080/24p] horizontally 27 kHz, vertically 24 Hz [1 080/30p] horizontally 33.75 kHz, vertically 30 Hz [1 080/25p] horizontally 28.13 kHz, vertically 25 Hz [1 080/24sF] horizontally 27 kHz, vertically 48 Hz [1 080/60p] horizontally 67.5 kHz, vertically 60 Hz [1 080/50p] horizontally 56.25 kHz, vertically 50 Hz • HD/SYNC, VD terminals are not compliant with 3 value composite SYNC.		
Color system		7 standards (NTSC/NTSC4.43/PAL/PAL-N/PAL-M/SECAM/PAL60)		
Screen size		70 inch–600 inch ¹		
Screen aspect ratio		4:3	16:10	
Projection scheme		Menu-selectable from front/rear/ceiling mount, and floor mounting		
Contrast ratio (full white/full black)		5 000:1 (when “DYNAMIC IRIS” has been set to “3”)		
Interface ports	Input module connection slot	One system		
	RGB1 input terminal	1 set, BNC × 5 [For YP _B P _R input] Y: 1.0 V[p-p] synchronization signal included, P _B P _R : 0.7 V [p-p] 75 Ω [For RGB input] 0.7 V[p-p] 75 Ω For G-SYNC: 1.0 V [p-p] 75 Ω HD/SYNC: 75 Ω, 1.4–5 Vp-p, positive/negative polarity automatically adjusted VD: 75 Ω, 1.4–5 Vp-p, positive/negative polarity automatically adjusted		

Model No.		PT-D12000U	PT-DZ12000U
Interface ports	RGB2 input terminal	1 set of high-density, D-sub 15p (female) [For YP _B P _R input] Y: 1.0 V [p-p] synchronization signal included, P _B P _R : 0.7 V [p-p] 75 Ω [For RGB input] 0.7 V [p-p] 75 Ω For G-SYNC: 1.0 V [p-p] 75 Ω HD/SYNC: TTL, high-impedance, positive/negative polarity automatically adjusted VD: TTL, high-impedance, positive/negative polarity automatically adjusted • HD/SYNC, and VD terminals are not compliant with 3-value direct SYNC.	
	Video input/output terminal	1 set BNC 1.0 V [p-p] 75 Ω (Active through for Video output)	
	S-video input terminal	1 set Mini DIN 4p Y 1.0 V [p-p] C 0.286 V [p-p] 75 Ω Compliant with S1 signals	
	DVI-D input terminal	1 set DVI 1.0 compliant HDCP (Single link only) compatible	
	LAN terminal	1 set (Used for network connection) 10BASE-T/100BASE-TX PLink™ compatible	
	Serial input terminal	2 sets D-sub 9-pin (female), RS-232C/RS-422 compliant Used for personal computer control	
	Serial output terminal	1 set D-sub 9-pin (male), RS-422 compliant Used for personal computer control	
	Remote1 input/output terminal	1 set each for M3 pin jack Wired remote control, used for link control	
	Remote2 terminal	D-sub 9p (female) Used for external control	
Length of power supply cord		3.0 m (9.1')	
Cabinet		Molded resin	
Outside dimensions		Width: 578 mm (22.8"), Height : 320 mm (12.6"), Depth: 643 mm (25.3")	
Weight		approx. 35 kg (77.1 lb) (without optional projection lens) ²	
Working environment condition		Ambient temperature ³ : 0 °C to 45 °C Ambient humidity: 10 % to 80 % (no condensation)	
Remote control	Power source	3 V DC (two AA dry cells)	
	Operation range	approx. 30 m (98'5") (in front of beam receiver)	
	Mass	134 g (0.31 lb) (including dry cells)	
	Outside dimensions	Width: 51 mm (2"), Thickness: 23 mm (0.9"), Depth: 176 mm (6.9")	
Optional	Hanging attachment (For high ceiling): Hanging attachment (For low ceiling): Projection lens: DVI-D input module: SD-SDI input module: HD/SD-SDI input module: Dual link HD/SD-SDI input module: Replacement Lamp Unit:	ET-PKD100H ET-PKD100S ET-D75LE1, ET-D75LE2, ET-D75LE3, ET-D75LE4, ET-D75LE5, ET-D75LE6, ET-D75LE8 ET-MD77DV ET-MD77SD1 ET-MD77SD3 ET-MD100SD4 ET-LAD12K (single bulb), ET-LAD12KF (4 bulbs)	

*1 70" – 300" for ET-D75LE5

*2 This is the average value. It may differ depending on each product.

*3 When the projector is used in high altitude mode (1 400 to 2 700 m), the ambient temperature is 0 °C to 40 °C. Furthermore, if the ambient temperature becomes 40 °C or more (35 °C in high altitude mode) when using the projector with lamp 4 lit, light output may be reduced by approximately 30% to protect the projector. When a smoke cut filter is used, the ambient temperature is 0 °C to 35 °C. However, use at high altitudes is not possible.

Appendix

Compatible Signals

The following table specifies the types of RGB/YPbPr/DVI-D signals compatible with the projector.
 RGB signals can also be input within the range of fH=15 kHz–100 kHz, fV=24 Hz–120 Hz, dot clock=20 MHz–162 MHz.
 DVI-D signals can also be input within the range of dot clock=25 MHz -162 MHz.

Display mode	Number of displayed dots	Scanning frequency		Dot clock frequency (MHz)	Format	Plug and play		
		H (kHz)	V (Hz)			RGB2	DVI-D EDID1	DVI-D EDID2
NTSC/NTSC4.43/ PAL-M/PAL60	720 × 480i	15.7	59.9		VIDEO/S-VIDEO			
PAL/PAL-N/SECAM	720 × 576i	15.6	50		VIDEO/S-VIDEO			
480i	720 × 480i	15.7	59.9	13.5	YPbPr/RGB			
576i	720 × 576i	15.6	50	13.5	YPbPr/RGB			
480p	720 × 483	31.5	59.9	27	YPbPr/RGB/DVI		○	
576p	720 × 576	31.3	50	27	YPbPr/RGB/DVI		○	
1 080/60i	1 920 × 1 080i	33.8	60	74.3	YPbPr/RGB/DVI		○	
1 080/50i	1 920 × 1 080i	28.1	50	74.3	YPbPr/RGB/DVI		○	
1 080/24p	1 920 × 1 080	27	24	74.3	YPbPr/RGB/DVI		○	
1 080/24sF	1 920 × 1 080i	27	24	74.3	YPbPr/RGB/DVI			
1 080/25p	1 920 × 1 080	28.1	25	74.3	YPbPr/RGB/DVI		○	
1 080/30p	1 920 × 1 080	33.8	30	74.3	YPbPr/RGB/DVI			
1 080/60p	1 920 × 1 080	67.5	60	148.5	YPbPr/RGB/DVI		○	
1 080/50p	1 920 × 1 080	56.3	50	148.5	YPbPr/RGB/DVI		○	
720/60p	1 280 × 720	45	60	74.3	YPbPr/RGB/DVI		○	
720/50p	1 280 × 720	37.5	50	74.3	YPbPr/RGB/DVI		○	
VGA400	640 × 400	31.5	70.1	25.2	RGB/DVI			
	640 × 400	37.9	85.1	31.5	RGB/DVI			
VGA480	640 × 480	31.5	59.9	25.2	RGB/DVI	○	○	○
	640 × 480	35	66.7	30.2	RGB/DVI			
	640 × 480	37.9	72.8	31.5	RGB/DVI	○		○
	640 × 480	37.5	75	31.5	RGB/DVI	○		○
	640 × 480	43.3	85	36	RGB/DVI			
SVGA	800 × 600	35.2	56.3	36	RGB/DVI	○		○
	800 × 600	37.9	60.3	40	RGB/DVI	○		○
	800 × 600	48.1	72.2	50	RGB/DVI	○		○
	800 × 600	46.9	75.0	56.3	RGB/DVI	○		○
	800 × 600	53.7	85.1	56.3	RGB/DVI			
MAC16	832 × 624	49.7	74.6	57.3	RGB/DVI	○		○
XGA	1 024 × 768	39.6	50	51.9	RGB/DVI			
	1 024 × 768	48.4	60	65	RGB/DVI	○		○
	1 024 × 768	56.5	70.1	75	RGB/DVI	○		○
	1 024 × 768	60	75	78.8	RGB/DVI	○		○
	1 024 × 768	65.5	81.6	86	RGB/DVI			
	1 024 × 768	68.7	85	94.5	RGB/DVI			
	1 024 × 768i	35.5	87	44.9	RGB	○		
	1 024 × 768	80	100	105	RGB/DVI			
	1 024 × 768	96.7	120	130	RGB/DVI			
MXGA	1 152 × 864	64	71.2	94.2	RGB/DVI			
	1 152 × 864	67.5	74.9	108	RGB/DVI			
	1 152 × 864	76.7	85	121.5	RGB/DVI			

Display mode	Number of displayed dots	Scanning frequency		Dot clock frequency (MHz)	Format	Plug and play		
		H (kHz)	V (Hz)			RGB2	DVI-D EDID1	DVI-D EDID2
MAC21	1 152 × 870	68.7	75.1	100	RGB/DVI	○		○
1 280 × 768	1 280 × 768	39.6	49.9	65.3	RGB/DVI			
	1 280 × 768	47.8	59.9	79.5	RGB/DVI			
1 280 × 800	1 280 × 800	41.3	50	68	RGB/DVI			
	1 280 × 800	49.7	59.8	83.5	RGB/DVI			
MSXGA	1 280 × 960	60	60	108	RGB/DVI			
SXGA	1 280 × 1 024	52.4	50	88	RGB/DVI			
	1 280 × 1 024	64	60	108	RGB/DVI	○		○
	1 280 × 1 024	72.3	66.3	125	RGB/DVI			
	1 280 × 1 024	78.2	72	135.1	RGB/DVI			
	1 280 × 1 024	80	75	135	RGB/DVI	○		○
	1 280 × 1 024	91.1	85	157.5	RGB/DVI			
SXGA+	1 400 × 1 050	65.2	60	122.6	RGB/DVI	○		○
	1 400 × 1 050	78.8	72	149.3	RGB/DVI			
	1 400 × 1 050	82.2	75	155.9	RGB/DVI			
WXGA+	1 440 × 900	55.9	59.9	106.5	RGB/DVI			
UXGA	1 600 × 1 200	75	60	162	RGB/DVI	○		○
WSXGA+	1 680 × 1 050	65.3	60	146.3	RGB/DVI			
1 920 × 1 080 ^{*1}	1 920 × 1 080	66.6	59.9	138.5	RGB/DVI			
WUXGA ^{*1}	1 920 × 1 200	74	60	154	RGB/DVI	○		○

*1: Only when using VESA CVT RB (Reduced Blanking)

Note

- The number of display dots of the PT-D12000U is 1 400 x 1 050, and the number of display dots of the PT-DZ12000U is 1 920 x 1 200. A signal of a different resolution than the above data is converted to the number of display dots and then displayed.
- Character “i” that follows the number of displayed dots stands for interlace signal.
- Flicker (line flicker) will be caused in images if interlace signals are connected.

List of P IN P

Subwindow		RGB1		RGB2		VIDEO input	S-VIDEO input	DVI		AUX			
		RGB input	YPbPr input	RGB input	YPbPr input			Moving image system ³	RGB system ⁴	ET-MD77SD1	ET-MD77SD3/ ET-MD100SD4 ¹	ET-MD77DV	
Main window		RGB input	YPbPr input	RGB input	YPbPr input	VIDEO input	S-VIDEO input	Moving image system ³	RGB system ⁴	ET-MD77SD1	ET-MD77SD3/ ET-MD100SD4 ¹	Moving image system ²	RGB system ⁴
RGB1	RGB input	x	x	x	x	o	o	o	o	o	o	o	o
	YPbPr input	x	x	x	x	x	x	x	o	x	x	x	o
RGB2	RGB input	x	x	x	x	o	o	o	o	o	o	o	o
	YPbPr input	x	x	x	x	x	x	x	o	x	x	x	o
VIDEO input		o	x	o	x	x	x	x	o	x	x	x	o
S-VIDEO input		o	x	o	x	x	x	x	o	x	x	x	o
DVI	Moving image system ³	o	x	o	x	x	x	x	x	x	x	x	o
	RGB system ⁴	o	o	o	o	o	o	x	x	o	o	o	o
AUX	ET-MD77SD1		o	x	o	x	x	x	o	x	x	x	x
	ET-MD77SD3/ ET-MD100SD4 ¹		o	x	o	x	x	x	o	x	x	x	x
	ET-MD77DV	Moving image system ²	o	x	o	x	x	x	x	o	x	x	x
RGB system ⁴		o	o	o	o	o	o	o	o	x	x	x	x

o: P IN P (Picture in Picture) combinations are enabled

x: P IN P (Picture in Picture) combinations are disabled

*1 Only 480i, 576i, 720/60p, 720/50p, 1 035/60i, 1 080/60i, 1 080/50i, 1 080/24sF, 1 080/30p, 1 080/25p, and 1 080/24p are supported.

*2 Only 480p, 576p, 720/60p, 720/50p, 1 080/60i, 1 080/50i, 1 080/24sF, 1 080/30p, 1 080/25p, 1 080/24p, 1 080/60p, and 1 080/50p are supported.

*3 Only 480p, 576p, 720/60p, 720/50p, 1 080/60i, 1 080/50i, 1 080/24sF, 1 080/24p, 1 080/25p, 1 080/30p, 1 080/50p, and 1 080/60p are supported.

*4 VGA (640 × 480) - WUXGA (1 920 × 1 200)

non-interlace signal, Dot clock frequency : 25 MHz - 162 MHz

- The WUXGA signals support only VESA CVT-RB (Reduced Blanking) signals.

Note

- Noise reduction cannot be used.
- For the PT-DZ12000U, the picture quality of the sub-window may deteriorate when the resolution of the input signals of the sub-window are XGA (1 024 × 768) or better and the size of the sub-window is 50 % or larger.

Dimensions

Outside dimensions

unit : mm (inch)

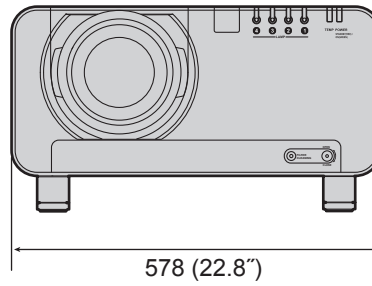
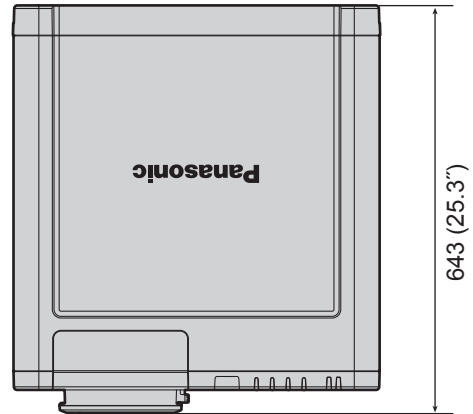
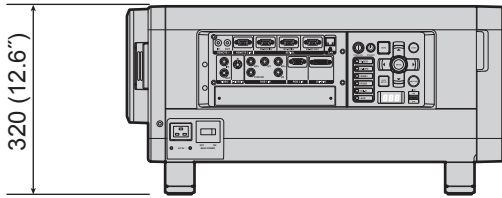

A

Accessories	10
Adjusting Brightness	55
Adjusting Color	55
Adjusting color matching	70
Adjusting Contrast	54
Adjusting the aspect ratio	61
Adjusting the clamp position	65
Adjusting the color temperature	55
Adjusting the feet	20
Adjusting the geometry	62
Adjusting the input resolution	65
Adjusting the zoom ratio	62
Adjusting Tint	55
Air filter cleaning	81
Altitude Mode	78
Automatic adjustment	49
Auto power off	82
AUX DVI IN	74
AUX SDI IN	74

B

Back Color	75
Basic operations on menu screen	53
Before asking for service	117
Blanking adjustment	64

C

Changing the security password	89
Changing the text	89
Cleaning and replacement of air filter	112
Clock phase adjustment	62
Compatible Signals	122
Connecting the power cord	37
Connecting with personal computers	29
Connecting with VIDEO devices	28
Control device setup	90

D

Digital cinema reality	64
Direction	78
DVI-D IN	73
DVI-D input module	35
Dynamic iris setting	57

E

Edge blending adjustment	66
Effective range of remote control operation	17

F

Frame delay	67
-------------	----

G

Gamma setting	56
---------------	----

H

HD/SD-SDI input module	33
How to adjust the lens	40
How to install and remove the projection lens	36

I

Indication of monitor lamp	111
Initialize	84
Installation dimensions diagram	26
Installation Setting	78
Installing the input module	30

L

Lamp relay	80
Lamp select	79
Lamp unit replacement	115
Large Screen Correction	72
List of P IN P	124
Load all user data	84

M

Main menu	51
Maintenance	11

N

Network connections	93
Network control	92
Network function	91
Network standby	91
Network status	92
Noise reduction setting	57
Notes when installing the ceiling mount bracket	116

O

On-screen display function	48
On-Screen display setting	75
Outside dimensions	125

P

P IN P	85
Power indicator lamp	37
Powering off the projector	39
Powering up the projector	38
Projection scheme	20

R	
Raster position	68
Registered signals	45
Registering the picture mode settings as presettings	58
Remote2 mode	80
Remote 2 terminal	110
RGB IN	72
RS-232C setting	80

S	
Save all user data	83
Screen setting	72
SD-SDI input module	33
Self-diagnosis display	118
Serial terminals	106
Service password	84
Setting a projector ID	77
Setting FUNC1	83
Setting projector ID number to remote control	18
Setting the date and time	83
Setting the security password	88
Setting the text	89
Sharpness setting	57
Shift adjustment	60
Specifications	120
sRGB	59
Startup logo	76
Status	81
Status function	48
Sub memory	46
Sub menu	51
Switching the input signal	48
Switching the picture mode	54
System daylight view setting	56
System selector	58

T	
Test pattern	87

U	
Using the PJLink™ protocol	105
Using the SHUTTER function	48

W	
Wired remote control	18

Information on Disposal in other Countries outside the European Union



These symbols are only valid in the European Union.

If you wish to discard these items, please contact your local authorities or dealer and ask for the correct method of disposal.



EU



Note:

Purchase of this equipment includes the rights to use this software (the built-in microcomputer and information recorded on ROMs) but does not grant copyrights. Do not reverse engineer, change or modify the software. The guarantee will not be valid for any malfunctions caused by such actions.

Trademark Acknowledgement

- Digital Light Processing, DLP, and DLP® CHIP are registered trademarks of the Texas Instruments.
- VGA and XGA are trademarks of International Business Machines Corporation.
- S-VGA is a registered trademark of the Video Electronics Standards Association.
- “Microsoft Windows” is a registered trademark of the Microsoft Corporation (U.S.A.) in the U.S. and other countries.
- “Netscape” and “Netscape Navigator” are registered trademarks of the Netscape Communications Corporation in the U.S. and other countries.
- HDMI, the HDMI logo and High-Definition Multimedia Interface are the trademarks or registered trademarks of HDMI Licensing LLC.
- Patent No. 5,717,422
- All other trademarks are the property of the various trademark owners.

NOTES IMPORTANTES CONCERNANT LA SÉCURITÉ

AVERTISSEMENT:
POUR RÉDUIRE LES RISQUES DE FEU OU DE CHOC ÉLECTRIQUE, NE PAS EXPOSER
CE PRODUIT À L'EAU OU À L'HUMIDITÉ

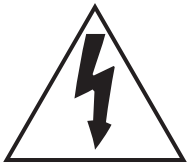
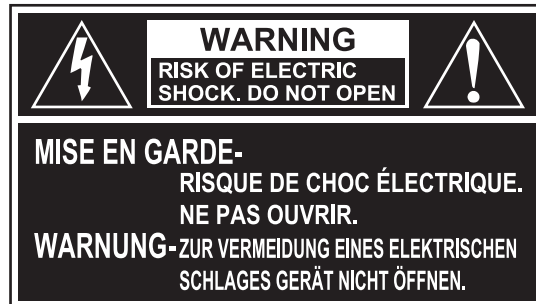

Le symbole de la flèche en forme d'éclair, dans un triangle, avertit l'utilisateur de la présence de "tensions dangereuses" à l'intérieur du produit qui peuvent être de force suffisante pour constituer un risque de choc électrique aux personnes.



Le point d'exclamation dans un triangle avertit l'utilisateur de la présence d'instructions importantes concernant l'utilisation et l'entretien (réparation) dans la littérature accompagnant le produit.

ATTENTION:

Cet appareil est équipé d'une fiche de courant à trois broches avec mise à la terre. Ne pas retirer la broche de mise à la masse de la fiche. Cette fiche ne pourra être utilisée que dans une prise avec mise à la terre. Ceci est une précaution sécuritaire. S'il est impossible d'insérer la fiche dans la prise, s'adresser à un électricien. Ne pas annuler la protection de la fiche à mise à la terre.

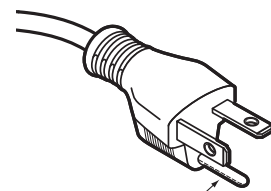

Ne pas retirer

AVERTISSEMENT:

Ne peut être utilisé dans une salle d'ordinateurs telle que définie dans la norme ANSI/NFPA 75 Standard for Protection of Electronic Computer/Data Processing Equipment.

Précautions de sécurité

AVERTISSEMENT

■ **En cas de problème (comme par exemple une absence d'image) ou si vous remarquez que de la fumée ou une odeur suspecte s'échappe du projecteur, couper immédiatement l'alimentation du projecteur, puis débrancher le cordon d'alimentation de la prise du secteur.**

- Ne pas continuer d'utiliser le projecteur dans ces cas, autrement cela peut entraîner un incendie ou des chocs électriques.
- Après s'être assuré que de la fumée ne se dégage plus, s'adresser à un centre technique agréé et demander que les réparations nécessaires soient faites.
- Le fait de réparer le projecteur soi-même est très dangereux, et ne doit jamais être fait.

■ **Ne pas installer ce projecteur dans un endroit qui n'est pas assez résistant pour supporter le poids du projecteur.**

- Si l'emplacement d'installation n'est pas assez résistant, le projecteur risque de tomber et de causer de graves blessures et (ou) des dommages.
- Demander à un technicien qualifié d'installer le projecteur par exemple s'il est installé au plafond.
- Si l'installation n'est pas faite correctement, cela peut entraîner des blessures ou des chocs électriques.

■ **En cas de pénétration de corps étrangers ou d'éclaboussures à l'intérieur du projecteur, de chute du projecteur ou de brisure du boîtier, couper immédiatement l'alimentation, puis débrancher le cordon d'alimentation de la prise du secteur.**

- Si l'on continue d'utiliser le projecteur dans ces conditions, cela peut entraîner un incendie ou des chocs électriques.
- S'adresser à un centre technique agréé pour que les réparations nécessaires puissent être faites.

■ **Ne jamais recouvrir le filtre à air, l'orifice d'admission d'air et les orifices de ventilation.**

- Cela risque de faire surchauffer le projecteur, et causer un incendie ou endommager le projecteur.

■ **Ne pas surcharger la prise du secteur.**

- Si l'alimentation est surchargée (par exemple, par l'utilisation de trop d'adaptateurs), cela risque de faire surchauffer le projecteur et peut entraîner un incendie.

■ **Ne pas retirer le capot ou le modifier.**

- L'intérieur du projecteur, soumis à des tensions élevées, présente en effet un grand danger d'incendies ou de chocs électriques.
- Pour toute inspection, réglage ou réparation, s'adresser à un centre technique agréé.

■ **Nettoyer régulièrement le cordon d'alimentation afin d'éviter qu'il ne se recouvre de trop de poussières.**

- En effet, une trop importante accumulation de poussières au niveau de la fiche du cordon d'alimentation présente un risque d'endommagement de l'isolation électrique de la prise, ce qui pourrait causer un incendie. Retirer le cordon d'alimentation avant de le nettoyer à l'aide d'un linge sec.
- Toujours débrancher le cordon d'alimentation de la prise du secteur lorsque le projecteur ne sera pas utilisé pendant une période prolongée.

■ **Toute manipulation ou procédure risquant d'endommager le cordon ou la fiche du cordon d'alimentation est strictement interdite.**

- Ne jamais endommager le cordon d'alimentation, ou l'altérer de quelque forme que ce soit, le placer à proximité de sources de chaleur, le plier, le tordre excessivement, tirer dessus, placer des objets lourds dessus ou le rembobiner.
- Il est possible que des chocs électriques, des courts-circuits ou un incendie soient produits par tout endommagement du cordon d'alimentation.
- Contacter un centre de service autorisé pour toute réparation du cordon d'alimentation qui s'avèrerait nécessaire.

■ **Ne jamais manipuler la fiche du cordon avec les mains mouillées.**

- Cela peut entraîner des chocs électriques.

■ **Introduire fermement la fiche du cordon d'alimentation dans une prise du secteur.**

- Si la fiche n'est pas complètement insérée, cela peut entraîner des chocs électriques ou la faire surchauffer.
- Ne jamais utiliser des fiches endommagées ou des prises murales incorrectement montées.

■ **Ne pas placer le projecteur sur des surfaces instables.**

- Si le projecteur est placé sur une surface qui est inclinée ou instable, il risque de tomber ou de se renverser et cela pourrait causer des blessures ou des dommages.

■ **Ne pas placer le projecteur dans l'eau et ne pas le laisser se mouiller.**

- Sinon cela peut causer un incendie ou des chocs électriques.

■ **Ne jamais démonter la lampe.**

- Toute rupture de la lampe risquerait en effet de causer de graves blessures.

■ **Ne pas placer des récipients contenant des liquides sur le projecteur.**

- Si de l'eau se renverse sur le projecteur ou pénètre dans celui-ci, il y aura risque d'incendie ou d'électrocution.
- Si de l'eau entre à l'intérieur du projecteur, contacter un centre technique agréé.

■ **Ne pas mettre d'objets étrangers dans le projecteur.**

- Ne pas insérer d'objets métalliques ou inflammables dans les orifices de ventilation ou les faire tomber sur le projecteur, car cela peut causer un incendie ou des chocs électriques.

■ **Après avoir retiré la pile de la télécommande, la tenir hors de portée des enfants.**

- La pile risque en effet de causer une mort par asphyxie si elle est avalée.
- Rechercher immédiatement le secours d'un médecin si la pile a été avalée par quelqu'un.

■ **Ne jamais laisser les bornes + et – de la pile entrer en contact avec des objets métalliques, tels que des colliers ou des barrettes par exemple.**

- En effet, ceci risquerait de causer une fuite du courant de la pile, voire une surchauffe, une explosion ou même un incendie.
- Conserver la pile dans un sac en plastique, à l'écart de tout objet métallique.

■ **Isoler la pile avec du ruban adhésif ou autre matériau similaire avant de la mettre au rebut.**

- La pile risquerait en effet de prendre feu ou même d'exploser en cas de contact avec d'autres objets métalliques ou des piles.

■ **Le remplacement de la lampe ne devrait être confié qu'à un technicien qualifié.**

- L'unité de la lampe est soumise à de très fortes pressions internes. Une mauvaise manipulation risquerait d'entraîner une défaillance.
- La lampe risque en effet de s'endommager très facilement en cas de chute ou de choc violent, ce qui pourrait causer des blessures ou des défaillances.

■ **En cas d'installation au plafond, s'assurer d'utiliser le fil accessoire (à installer à un endroit différent que le support de montage au plafond) ainsi que les oeillets correspondants, en tant que mesure de sécurité supplémentaire visant à empêcher toute chute du projecteur.**

- Des accidents pourraient en effet être causés par une mauvaise fixation du projecteur.

■ **Ne pas placer plusieurs kits les uns sur les autres.**

- Des accidents pourraient être causés par un non-respect de cette mise en garde.

Précautions de sécurité (suite)

- **N'utilisez pas le projecteur lorsque le couvercle de l'objectif est encore attaché à l'objectif (vendu séparément).**
 - Dans le cas contraire, un incendie risque de se produire.
- **Ne pas regarder directement dans l'objectif pendant que le projecteur fonctionne.**
 - Une lumière intense est émise par l'objectif du projecteur. Si l'on regarde directement dans cette lumière, elle risque de causer des blessures et de graves lésions oculaires.
- **Ne placez pas votre peau sur le trajet du faisceau lumineux lorsque vous utilisez le projecteur.**
 - Une lumière intense est émise par l'objectif du projecteur. Si vous vous placez directement dans cette lumière, elle peut vous blesser ou endommager votre peau.

Mise en garde

- **Ne pas installer le projecteur dans des endroits humides ou poussiéreux, ou dans des endroits où le projecteur peut entrer en contact avec des fumées grasses ou de la vapeur.**
 - L'utilisation du projecteur dans de telles conditions pourrait causer un incendie ou des chocs électriques.
- **Si vous désirez débrancher le cordon d'alimentation, tirer sur la fiche et non pas sur le cordon directement.**
 - Le fait de tirer directement sur le cordon d'alimentation risquerait en effet de l'endommager très rapidement et risquerait de causer un incendie, des courts-circuits ou de graves chocs électriques.
- **Débrancher toujours tous les câbles avant de déplacer le projecteur.**
 - Le fait de déplacer le projecteur avec des câbles branchés peut endommager les câbles, ce qui pourrait causer un incendie ou des chocs électriques.
- **Ne pas placer d'objets lourds sur le projecteur.**
 - Cela peut déséquilibrer le projecteur et le faire tomber, ce qui peut entraîner des dommages ou des blessures.
- **Ne jamais court-circuiter, chauffer ou démonter la pile ou la jeter à l'eau ou au feu.**
 - Le non-respect de cette mise en garde risquerait en effet de provoquer une surchauffe, une fuite, une explosion ou une mise à feu de la pile, ce qui risquerait de causer des brûlures ou d'autres blessures graves.
- **Respecter à tout moment la polarité de la pile (+ et -), notamment lors de son insertion.**
 - En effet, si la pile n'est pas correctement placée, ceci risquerait de causer une explosion, une fuite, un incendie, des blessures ou une contamination du compartiment des piles et de ses alentours.
- **N'utiliser que le type de piles spécifié.**
 - L'utilisation d'un type de pile incorrect pourrait entraîner une explosion, une fuite, un incendie, des blessures ou une contamination du compartiment des piles et de ses alentours, ce qui, d'une façon générale, pourrait causer des brûlures ou des dommages matériels.
 -
- **Veillez à ce que le faisceau lumineux n'éclaire pas directement votre peau pendant que vous utilisez le projecteur.**
 - Une lumière intense est émise par l'objectif du projecteur. Si vous vous placez dans ce faisceau lumineux, celui-ci risquera de vous blesser ou de vous abîmer la peau.

■ **Ne jamais placer les mains ou d'autres objets à proximité des orifices d'évacuation de l'air.**

- De l'air chaud sort est émis par les orifices d'évacuation de l'air. Par conséquent, ne jamais placer à proximité les mains, le visage ou d'autres parties de votre corps très sensibles à la chaleur.

■ **Ne jamais réutiliser une lampe usagée.**

- La lampe risquerait en effet d'exploser.

■ **Le remplacement de la lampe ne devrait être effectué qu'après lui avoir laissé le temps de se refroidir, car vous risqueriez de vous brûler sérieusement dans le cas contraire.**

■ **Débrancher le cordon d'alimentation de la prise du secteur à titre préventif avant d'entreprendre tout nettoyage.**

- Sinon cela peut causer des chocs électriques.

■ **Si la lampe est brisée, aérer la salle immédiatement. Ne pas toucher ou approcher le visage des morceaux brisés.**

- Sinon, l'utilisateur risquera d'inhaler le gaz qui s'est dégagé lorsque la lampe s'est brisée, et qui contient à peu près la même quantité de mercure que les lampes fluorescentes, et d'être blessé par les morceaux brisés.
- Si l'on pense avoir inhalé le gaz, ou que le gaz a pénétré dans les yeux ou la bouche, consulter immédiatement un médecin.
- Demander à son revendeur de remplacer l'unité de lampe et de vérifier l'intérieur du projecteur.

■ **Demander à un centre technique agréé de nettoyer l'intérieur du projecteur au moins une fois par an.**

- S'il n'est pas nettoyé et que de la poussière s'accumule à l'intérieur du projecteur, cela peut causer un incendie ou des problèmes de fonctionnement.
- Il est recommandé de nettoyer l'intérieur du projecteur avant l'arrivée de la saison des pluies. Demander au centre technique agréé le plus proche de nettoyer le projecteur lorsque cela est requis. Se renseigner auprès du centre technique agréé pour le coût du nettoyage.

■ **Ne pas introduire les doigts dans les ouvertures situées de chaque côté de l'objectif pendant les déplacements à l'horizontale ou à la verticale, car ceci pourrait causer des blessures.**

■ **Dans le cadre du respect de l'environnement, ramener toute unité non réparable à votre revendeur ou société de recyclage.**





■ **Ne jamais utiliser le projecteur lorsque les pieds réglables ou l'objectif de projection sont retirés.**

- Dans le cas contraire, des accidents ou des défaillances risqueraient de se produire.

Avant l'utilisation

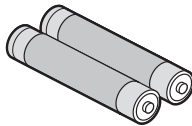
Accessoires

Vérifier que tous les accessoires ci-dessous sont bien compris avec votre projecteur.

Télécommande [N2QAYB000076 × 1]	Piles de la télécommande (AA)	Cordon d'alimentation		Support anti-chutes	
		Pour 240 V [K2CG3YY00035 × 1]	Pour 120 V [K2CH3YY00001 × 1]	Oeillet [TPAHE86 × 4]	Fil [TTRA0143 × 4]
					

Mise en garde concernant les déplacements du projecteur

L'objectif de projection est très sensible aux vibrations et aux impacts. Par conséquent, démonter à chaque fois l'objectif avant tout transport.

Mises en garde concernant la configuration

Respecter les précautions suivantes pendant toute l'installation du produit.

- **Veillez à installer le couvercle de l'objectif de projection après avoir installé l'objectif de projection.**
Dans le cas contraire, de la poussière risquerait de s'accumuler à l'intérieur du projecteur et de causer des problèmes.
- **Eviter d'installer cet appareil à un endroit soumis à de fortes vibrations ou à des impacts violents.**
En effet, si le projecteur est installé à un endroit où des vibrations sont transmises à partir d'une source de puissance ou monté dans une voiture, les vibrations et les impacts pourraient être transmis aux composants du produit et conduire à des défaillances techniques. Installer donc le produit à un emplacement soumis à aucun(e) impact ou vibration.
- **Ne jamais installer le projecteur à proximité de lignes haute tension ou de sources d'alimentation.**
L'appareil risquerait en effet d'être exposé à des interférences en cas d'installation à proximité de lignes haute tension ou de sources d'alimentation.
- **Ne pas placer le projecteur sur une surface ou tapis en vinyle.**
En cas d'aspiration de la surface en vinyle par l'orifice d'aspiration d'air, il y a un risque de blocage de l'arrivée d'air, ce qui entraînera une hausse de la température interne, suivie d'un déclenchement du circuit de protection et de l'arrêt du projecteur.
- **Consulter un technicien spécialisé avant toute installation au plafond.**
Lorsque l'appareil doit être accroché au plafond, il sera nécessaire d'acheter un accessoire de montage au plafond (pour plafonds hauts : N° de modèle ET-PKD100H) (pour plafonds bas : N° de modèle ET-PKD100S) et de contacter un technicien spécialisé pour son installation.
- **Ne jamais utiliser le projecteur à une altitude dépassant les 2 700 m (8881.5') au-dessus du niveau de la mer. Pour des utilisations dépassant les 1 400 m (4605.3') au-dessus du niveau de la mer, configurer le paramètre "MODE ALTITUDE", comme décrit à la page 76, sur la valeur "OUI".**
La durée de vie de l'appareil risquerait d'être raccourcie dans le cas contraire.
- **Lors de l'installation et de l'utilisation du projecteur à un angle supérieur à 30° de l'horizontale en position verticale, régler « SENS INSTALLATION », décrite page 78, sur « VERTICAL ».**

Remarques concernant l'utilisation

■ Pour voir des images trop claires :

- Votre public aura du mal à voir correctement les images à fort contraste et brillance lorsque de la lumière naturelle ou en provenance d'une source de lumière interne vient illuminer directement la surface de l'écran. Par conséquent, tirer les rideaux ou stores des fenêtres, éteindre les sources de lumière proches de l'écran et prendre d'une manière générale toutes les mesures qui s'imposent.
- Dans certains cas peu fréquents, dépendant avant tout des conditions de projection, il est possible que des parasites se forment à l'écran en raison de l'air chaud s'échappant du port d'évacuation d'air. S'assurer qu'aucun appareil capable de recirculer l'air chaud évacué du projecteur en face de celui-ci ou d'un autre appareil proche.

■ Ne jamais toucher la surface de l'objectif de projection avec les mains nues.

Toute trace d'empreintes digitales ou tache laissée sur l'objectif sera en effet agrandie par ce dernier et particulièrement visible sur l'écran pendant les projections. Garder vos mains à distance de l'objectif. Placer le couvercle sur l'objectif lorsqu'il n'est pas utilisé.

■ Puces DLP

Les puces DLP sont fabriquées à l'aide d'une technologie de très haute précision. Veuillez noter qu'en de rares cas, des pixels peuvent manquer ou être toujours allumés, mais il ne s'agit pas d'un dysfonctionnement.

■ Lampe

La source de lumière utilisée dans cet appareil est une lampe au mercure à haute pression interne. Toute lampe au mercure à haute pression présente les caractéristiques suivantes :

- Elle risque d'exploser en émettant un bruit fort ou de ne plus émettre de lumière à la fin de sa durée de vie, en raison des impacts reçus, des défauts ou des détériorations subies pendant son utilisation.
- La durée de vie d'une lampe au mercure dépend fortement des conditions d'utilisation auxquelles elle est soumise. Elles sont tout particulièrement sensibles aux commutations marche/arrêt fréquentes et/ou à répétitions.
- Dans certains cas très rares, elle risque d'exploser quelque temps après le début de la projection.
- La probabilité d'explosion de la lampe augmente plus elle est utilisée au-delà de sa durée d'utilisation.
- Si la lampe explose, le gaz qui se trouve à l'intérieur s'échappe et peut ressembler à de la fumée.
- Préparer une lampe de remplacement à l'avance.

■ Entretien

S'assurer à chaque fois de bien retirer la fiche du cordon d'alimentation de son logement sur l'appareil avant tout nettoyage.

• Utiliser un linge propre et sec pour le nettoyage du boîtier.

Utiliser un linge sec imbibé d'eau tiède pour essuyer toute trace d'huile. Ne pas utiliser de solvants tels que du benzène, un diluant, de l'alcool, des détergents pour cuisine ou un chiffon imbibé de produit chimique. Le boîtier extérieur pourrait être déformé et la peinture pourrait s'écailler.

• Ne jamais nettoyer la surface de l'objectif avec un linge pelucheux ou poussiéreux.

Toute poussière ayant été déposée sur l'objectif sera en effet agrandie et bien visible à l'écran. N'essayer la saleté et la poussière qu'avec un chiffon doux.

MISE EN GARDE:

Lors de la connexion du projecteur à un PC ou à un appareil externe, utiliser le cordon d'alimentation fourni avec l'appareil correspondant ainsi qu'un câble d'interface blindé disponible dans le commerce.

Mise au rebut

Lors de la mise au rebut du produit, contacter la municipalité ou le distributeur le plus proche afin de vérifier la procédure appropriée de mise au rebut.

Remarques concernant la sécurité

Si vous utilisez la fonction réseau de ce produit, il existe une possibilité d'être victime des dommages suivants.

- Fuites d'informations personnelles via ce produit
- Utilisation non autorisée de ce produit par une tierce partie malveillante
- Interférence avec ou arrêt de ce produit par une tierce partie

S'assurer que les mesures de sécurité adéquates ont été prises. (p. 88-94)

- Utiliser un mot de passe aussi difficile à deviner que possible.
- Modifier votre mot de passe régulièrement.
- Panasonic et ses entreprises affiliées ne vous demanderaient jamais directement votre mot de passe.

Dans l'éventualité où quelqu'un vous le demanderait directement, ne révélez pas votre mot de passe à cette personne.

- Utiliser un réseau sur lequel des mesures de sécurité telles qu'un pare-feu ont été mises en œuvre.
- Définir un mot de passe ainsi que des restrictions pour les utilisateurs qui peuvent se connecter.

Remplacement de la lampe

AVERTISSEMENT

- Attendre que la lampe ait eu le temps de se refroidir avant de la remplacer.
- S'assurer que les quatre lampes ont été installées.
- Le remplacement de la lampe doit être effectué par un technicien qualifié.
- Ne retirez aucune autre vis (comme les vis noires) que celles indiquées pour le remplacement de la lampe. Dans le cas contraire, vous vous exposez aux décharges électriques, aux brûlures et autres blessures.

Précautions à prendre lors du remplacement de la lampe

- Faire très attention lors de la manipulation de la lampe. En effet, l'unité de la lampe est soumise à de très fortes pressions internes. Une mauvaise manipulation risquerait d'entraîner une défaillance.
- Une lampe usée risque même d'exploser en cas de manipulation violente. Contacter un prestataire de services spécialisé dans le traitement de déchets industriels pour la mise au rebut des lampes usagées.
- La lampe risque d'exploser en cas d'utilisation dépassant la durée de remplacement.
- Un tournevis cruciforme est nécessaire au remplacement de la lampe. Faire attention aux mouvements de la main lors de l'utilisation du tournevis à proximité de la lampe.

Attention

- L'unité de la lampe est une pièce en option. Consulter votre revendeur pour plus de détails à propos des commandes.
N° de modèle de l'unité de remplacement de la lampe : ET-LAD12K (ampoule simple),
ET-LAD12KF (4 ampoules)
Puissance : 300 W
- Des lampes autres que celles spécifiées ci-dessus ne devront en aucun cas être utilisées. N'utiliser que les types de lampe spécifiés.

Intervalle de remplacement de la lampe

Toute lampe utilisée en tant que source de lumière a une durée de vie limitée. La durée de vie de la lampe utilisée dans ce projecteur est de 2 000 heures. Cependant, il est possible que la lampe soit morte (ne s'allume pas) avant ces 2 000 heures, selon les caractéristiques de chaque lampe et de ses conditions d'utilisation (la durée de vie d'une lampe peut en effet être affectée par le nombre de fois où elle a été allumée et éteinte et par les intervalles qui les séparent). Il est par conséquent fortement conseillé de toujours avoir une ampoule de rechange à portée de main.

Lorsqu'une lampe n'a pas été remplacée après 2 000 heures d'utilisation, cette lampe sera automatiquement éteinte. Si la durée d'utilisation de toutes les lampes dépasse les 2 000 heures, le courant sera automatiquement coupé 10 minutes après le démarrage, et le projecteur passera en mode de veille.

Attention

- Nettoyer et remplacer le filtre à air à chaque remplacement des unités de lampes. (pp. 112-113)

■ Indication après 1 800 heures

Lorsqu'une lampe a été utilisée pendant plus de 1 800 heures, le témoin de la lampe correspondante (LAMP1, LAMP2, LAMP3 ou LAMP4) s'allumera, même en mode de veille.

De plus, un message s'affichera à l'écran pendant environ 30 secondes comme indiqué sur la figure ci-contre, demandant un remplacement de la lampe correspondante. (L'indication de la figure ci-dessous disparaît après environ 30 secondes ou dès qu'on appuie sur une des touches de l'appareil ou de la télécommande.)

Après une durée d'utilisation de 2 000 heures, le message restera affiché en permanence à l'écran, et ne disparaîtra qu'à condition d'appuyer sur la touche du menu (MENU).



Procédure de remplacement de la lampe

1. Couper l'alimentation principale, en suivant les procédures décrites dans « Mise en marche du projecteur » (p. 38) et « Arrêt du projecteur » (p. 39), débrancher la fiche du cordon d'alimentation de la source d'alimentation secteur et attendre une heure ou plus. Ensuite, vérifier la lampe une fois celle-ci refroidie.

2. Dévisser, à l'aide d'un tournevis cruciforme (Phillips), la vis du couvercle de l'unité de la lampe à l'arrière du projecteur jusqu'à ce qu'elle puisse tourner librement.

3. Ouvrir le couvercle de la lampe puis retirer cette dernière du projecteur.

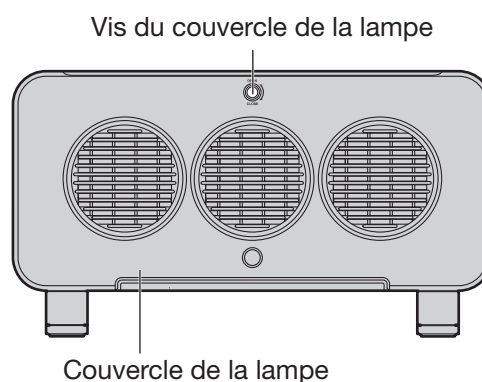

4. Dévisser, à l'aide d'un tournevis cruciforme (Phillips), les trois vis de fixation de la lampe à remplacer jusqu'à ce qu'elles puissent tourner librement. Tout en tenant doucement l'unité de la lampe par sa poignée, continuer à tirer dessus jusqu'à l'extraire complètement du projecteur.

MISE EN GARDE

La lampe ainsi que les pièces se trouvant à proximité sont toujours extrêmement chaudes juste après l'utilisation du projecteur.

Vous risquez de très graves brûlures en cas de non-respect de cette mise en garde.

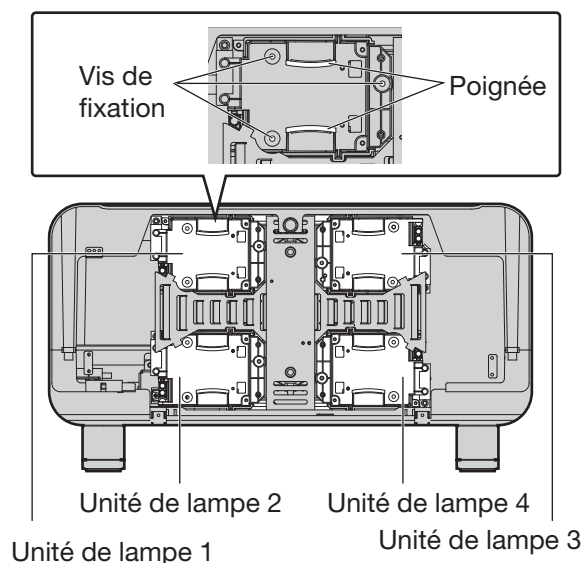

5. Installer la nouvelle unité de lampe.

6. Resserrer à l'aide d'un tournevis cruciforme les 3 vis de fixation de la lampe pour chaque unité de lampe.

7. Installer puis refermer le couvercle de la lampe, avant de revisser à l'aide d'un tournevis cruciforme, les vis de fixation du couvercle.

Mise en garde

- Installer fermement la lampe ainsi que le couvercle de la lampe. En effet, dans le cas contraire, le circuit de protection ne fonctionnera pas correctement et l'appareil ne pourra pas s'allumer.

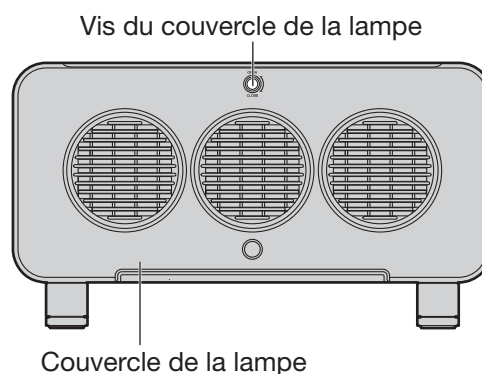

Panasonic[®]

Projectors

Panasonic Projector Systems Company

Unit of Panasonic Corporation of North America

One Panasonic Way, Secaucus, New Jersey 07094
(201) 392-6591

Technical Support:

PHONE: (888) 411-1996

FAX : (201) 348-7523

E-Mail : projectorsupport@us.panasonic.com

Panasonic Canada Inc.

5770 Ambler Drive, Mississauga, Ontario L4W 2T3 (905) 624-5010
© 2008 Matsushita Electric Industrial Co., Ltd. All Rights Reserved.