

***myprojectorlamps.com***

**The most trusted, dependable name  
in projector lamp sales.**



<http://www.myprojectorlamps.com>



<http://www.myprojectorlamps.ca>



<http://www.myprojectorlamps.eu>

The following projector manual has not been modified or altered in any way.

# Panasonic®

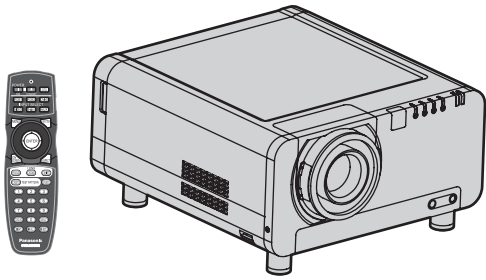

## Operating Instructions

DLP® Based Projector

Commercial Use

Models No.

# PT-D10000U

# PT-DW10000U



Read these instructions completely before operating this unit.

# Dear Panasonic Customer:

This instruction booklet provides all the necessary operating information that you might require. We hope it will help you to get the most performance out of your new product, and that you will be pleased with your Panasonic DLP® based projector.

The serial number of your product may be found on its back. You should note it in the space provided below and retain this booklet in case service is required.

Model number: **PT-D10000U/PT-DW10000U**

---

Serial number:

---

# Contents

Be sure to read the “IMPORTANT SAFETY NOTICE” and the “Precautions with regard to safety”. (pp. 4-9)

IMPORTANT SAFETY NOTICE .....	4
Precautions with regard to safety.....	6
Before Using .....	10
Location and function of each part.....	12
Using the remote control unit .....	17
Installation.....	19
Connection.....	24
Installation of input module (optional) .....	27
How to install and remove the projection lens (optional).....	33

Getting Started

Projection .....	34
How to adjust the lens .....	37
Automatic adjustment (AUTO SETUP) .....	39
Registration of input signal data.....	40
Basic operations using the remote control .....	43
On-screen menus .....	46
Adjusting the picture.....	49
Adjusting the position.....	56
How to use ADVANCED MENU .....	60
Setting the DISPLAY LANGUAGE.....	66

Basic Operation

Option1 settings .....	67
Option2 settings .....	75
Displaying the internal test pattern .....	83
How to use network function .....	84
Using the PJLink™ protocol .....	98
Setting the security .....	99
Using the serial terminals.....	102
Using the Remote 2 terminal .....	106

Special Features

Indication of monitor lamp .....	107
Cleaning and replacement of air filter .....	108
Replacement of lamp unit.....	110
Notes when installing the ceiling mount bracket .....	112
Before asking for service ... try to check the following points again. ....	113
Self-diagnosis display.....	114
Specifications .....	116
Appendix .....	118
Dimensions .....	120
Index .....	121
Français Information.....	123

Information

# IMPORTANT SAFETY NOTICE

**WARNING: TO REDUCE THE RISK OF FIRE OR ELECTRIC SHOCK, DO NOT EXPOSE THIS PRODUCT TO RAIN OR MOISTURE.**

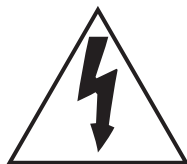
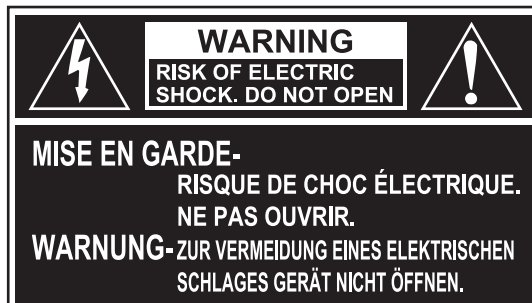

The lightning flash with arrowhead symbol, within an equilateral triangle, is intended to alert the user to the presence of uninsulated “dangerous voltage” within the Product’s enclosure that may be of sufficient magnitude to constitute a risk of electric shock to persons.



The exclamation point within an equilateral triangle is intended to alert the user to the presence of important operating and maintenance (servicing) instructions in the literature accompanying the product.

## CAUTION:

This equipment is equipped with a three-pin grounding-type power plug. Do not remove the grounding pin on the power plug. This plug will only fit a grounding-type power outlet. This is a safety feature. If you are unable to insert the plug into the outlet, contact an electrician. Do not defeat the purpose of the grounding plug.

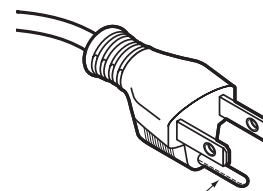

Do not remove

**WARNING:** This equipment has been tested and found to comply with the limits for a Class B digital device, pursuant to part 15 of the FCC Rules. These limits are designed to provide reasonable protection against harmful interference in a residential installation. This equipment generates, uses and can radiate radio frequency energy and, if not installed and used in accordance with the instructions, may cause harmful interference to radio communications. However, there is no guarantee that interference will not occur in a particular installation. If this equipment does cause harmful interference to radio or television reception, which can be determined by turning the equipment off and on, the user is encouraged to try to correct the interference by one or more of the following measures:

- Reorient or relocate the receiving antenna.
- Increase the separation between the equipment and receiver.
- Connect the equipment into an outlet on a circuit different from that to which the receiver is connected.
- Consult the dealer or an experienced radio/TV technician for help.

**FCC CAUTION:** To assure continued compliance, use only shielded interface cables when connecting to computer or peripheral devices. Any unauthorized changes or modifications to this equipment could void the user's authority to operate.

**WARNING:** Not for use in a computer room as defined in the Standard for the Protection of Electronic Computer/Data Processing Equipment, ANSI/NFPA 75.

#### Declaration of Conformity

Model Number: PT-D10000U / PT-DW10000U  
 Trade Name: **Panasonic**  
 Responsible Party: Panasonic North America  
 Address: One Panasonic Way 4B-9 Secaucus, NJ 07094  
 Telephone Number: 1-800-524-1448 or 1-800-526-6610  
 Email: pjscservice@us.panasonic.com

This device complies with Part 15 of the FCC Rules. Operation is subject to the following two conditions: (1) This device may not cause harmful interference, and (2) this device must accept any interference received, including interference that may cause undesired operation.

**NOTICE:** This product has a High Intensity Discharge (HID) lamp that contains a small amount of mercury. It also contains lead in some components. Disposal of these materials may be regulated in your community due to environmental considerations. For disposal or recycling information please contact your local authorities, or the Electronics Industries Alliance: <<http://www.eiae.org>>

# Precautions with regard to safety

## WARNING

- **If a problem occurs (such as no image) or if you notice smoke or a strange smell coming from the projector, turn off the power and disconnect the power cord from the wall outlet.**
  - Do not continue to use the projector in such cases, otherwise fire or electric shocks could result.
  - Check that no more smoke is coming out, and then contact an Authorized Service Center for repairs.
  - Do not attempt to repair the projector yourself, as this can be dangerous.
- **Do not install this projector in a place which is not strong enough to take the full weight of the projector.**
  - If the installation location is not strong enough, it may fall down or tip over, and severe injury or damage could result.
  - Installation work (such as ceiling suspension) should only be carried out by a qualified technician.
  - If installation is not carried out correctly, there is the danger that injury or electric shocks may occur.
- **If foreign objects or water get inside the projector, or if the projector is dropped or the cabinet is broken, turn off the power and disconnect the power cord from the wall outlet.**
  - Continued use of the projector in this condition may result in fire or electric shocks.
  - Contact an Authorized Service Center for repairs.
- **Do not cover the air filter, the air inlet and exhaust vents.**
  - Doing so may cause the projector to overheat, which can cause fire or damage to the projector.
- **Do not overload the wall outlet.**
  - If the power supply is overloaded (for example, by using too many adapters), overheating may occur and fire may result.
- **Do not remove the cover or modify it in any way.**
  - High voltages which can cause fire or electric shocks are present inside the projector.
  - For any inspection, adjustment and repair work, please contact an Authorized Service Center.
- **Clean the power cord plug regularly to prevent it from becoming covered in dust.**
  - If dust builds up on the power cord plug, the resulting humidity can damage the insulation, which could result in fire. Pull the power cord out from the wall outlet and wipe it with a dry cloth.
  - If not using the projector for an extended period of time, pull the power cord plug out from the wall outlet.
- **Do not do anything that might damage the power cord or the power cord plug.**
  - Do not damage the power cord, make any modifications to it, place it near any hot objects, bend it excessively, twist it, pull it, place heavy objects on top of it or wrap it into a bundle.
  - If the power cord is used while damaged, electric Shocks, short-circuits or fire may result.
  - Ask an Authorized Service Center to carry out any repairs to the power cord that might be necessary.
- **Do not handle the power cord plug with wet hands.**
  - Failure to observe this may result in electric shocks.

- **Insert the power cord plug securely into the wall outlet.**
  - If the plug is not inserted correctly, electric shocks or overheating could result.
  - Do not use plugs which are damaged or wall outlets which are coming loose from the wall.
- **Do not place the projector on top of surfaces which are unstable.**
  - If the projector is placed on top of a surface which is sloped or unstable, it may fall down or tip over, and injury or damage could result.
- **Do not place the projector into water or let it become wet.**
  - Failure to observe this may result in fire or electric shocks.
- **Do not disassemble the lamp unit.**
  - If the lamp section breaks, it may cause injury.
- **Do not place liquid containers on top of the projector.**
  - If water spills onto the projector or gets inside it, fire or electric shocks could result.
  - If any water gets inside the projector, contact an Authorized Service Center.
- **Do not insert any foreign objects into the projector.**
  - Do not insert any metal objects or flammable objects into the projector or drop them onto the projector, as doing so can result in fire or electric shocks.
- **After removing the battery from remote control unit, keep it away from the reach of children.**
  - The battery can cause death by suffocation if swallowed.
  - If the battery is swallowed, seek medical advice immediately.
- **Do not allow the + and - terminals of the battery to come into contact with metallic objects such as necklaces or hairpins.**
  - Failure to observe this may cause the battery to leak, overheat, explode or catch fire.
  - Store the battery in a plastic bag and keep it away from metallic objects.
- **Insulate the battery using tape or similar before disposal.**
  - If the battery comes into contact with metallic objects or other batteries, it may catch fire or explode.
- **Replacement of the lamp unit should be carried out by a qualified technician.**
  - The lamp unit has high internal pressure. If improperly handled, failure might result.
  - The lamp unit can easily become damaged if struck against hard objects or dropped, and injury or malfunctions may result.
- **When installing to a ceiling, be sure to use the accessory wire (install in a different location to the ceiling mount bracket) and the eye bolts as an extra preventative measure to stop the projector from falling down.**
  - If the projector is not secure enough, accidents may result.
- **Do not place sets directly on top of each other.**
  - If this is not observed, accidents may result.
- **Do not use the projector while the projection lens cover is still attached to the projection lens (sold separately).**
  - If this is not observed, fire may occur.



## Precautions with regard to safety (continued)

### CAUTION



- **Do not set up the projector in humid or dusty places or in places where the projector may come into contact with smoke or steam.**
  - Using the projector under such conditions may result in fire or electric shocks.
- **When disconnecting the power cord, hold the plug, not the cord.**
  - If the power cord itself is pulled, the cord will become damaged, and fire, short-circuits or serious electric shocks may result.
- **Always disconnect all cables before moving the projector.**
  - Moving the projector with cables still attached can damage the cables, which could cause fire or electric shocks to occur.
- **Do not place any heavy objects on top of the projector.**
  - Failure to observe this may cause the projector to become unbalanced and fall, which could result in damage or injury.
- **Do not short-circuit, heat or disassemble the battery or place it into water or fire.**
  - Failure to observe this may cause the battery to overheat, leak, explode or catch fire, and burns or other injury may result.
- **When inserting the battery, make sure the polarities (+ and -) are correct.**
  - If the battery is inserted incorrectly, it may explode or leak, and fire, injury or contamination of the battery compartment and surrounding area may result.
- **Use only the specified battery.**
  - If an incorrect battery is used, it may explode or leak, and fire, injury or contamination of the battery compartment and surrounding area may result close to this port, otherwise burns or damage could result.
- **Do not look into the lens while the projector is being used.**
  - Strong light is emitted from the projector's lens. If you look directly into this light, it can hurt and damage your eyes.
- **Do not place your skin into the light beam while the projector is being used.**
  - Strong light is emitted from the projector's lens. If you place directly into this light, it can hurt or damage your skin.
- **Do not bring your hands or other objects close to the air outlet port.**
  - Heated air comes out of the air outlet port. Do not bring your hands or face, or objects which cannot withstand heat.
- **Do not use the old lamp unit.**
  - The lamp section may break.
- **Replacement of the lamp unit should only be carried out after it has completely cooled off, otherwise burns may result.**

- **Disconnect the power cord plug from the wall outlet as a safety precaution before carrying out any cleaning.**
  - Electric shocks can result if this is not done.
- **If the lamp has broken, ventilate the room immediately. Do not touch or bring your face close to the broken pieces.**
  - Failure to observe this may cause the user to absorb the gas which was released when the lamp broke and which contains nearly the same amount of mercury as fluorescent lamps, and the broken pieces may cause injury.
  - If you believe that you have absorbed the gas or that the gas has got into your eyes or mouth, seek medical advice immediately.
  - Ask your dealer to replace the lamp unit and check the inside of the projector.
- **Ask an Authorized Service Center to clean inside the projector at least once a year.**
  - If dust is left to build up inside the projector without being cleaned out, it can result in fire or problems with operation.
  - It is a good idea to clean the inside of the projector before the season for humid weather arrives. Ask your nearest Authorized Service Center to clean the projector when required. Please discuss with the Authorized Service Center regarding cleaning costs.
- **Do not reach for the openings beside the optical lens, during horizontal or vertical movements of the lens there is a injury hazard.**
- **An effort to keep our environment clean, please bring the non repairable unit your Dealer or a Recycling Company.**
- **Do not use projectors with the adjustable feet or projection lens cover removed.**
  - If this is not observed, the sets may not operate correctly or accidents may result.

# Before Using

## Accessories

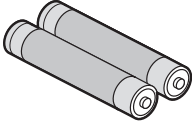
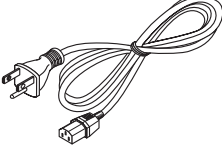
Check that all of the accessories shown below have been included with your projector.

Remote Control [N2QAYB000076 × 1]	Batteries for Remote Control (AA)	Power cord [K2CG3YY00015 × 1]	Drop-prevention bracket	
			Eye bolt [THEA172J × 4]	Wire [TTRA0144 × 4]
				

## Caution when moving the projector

The projection lens is susceptible to vibrations and impacts. Be sure to always remove the lens during transport.

## Cautions regarding setup

Be sure to observe the following precautions when installing the product.

- Be sure to install the projection lens cover when installing the projection lens.**

If this is not done, dust will collect inside the projector and problems with the projector will result.
- Avoid installing the product in a place exposed to vibrations or impacts.**

If the projector is installed in a place where vibrations are transmitted from a source of driving power and others or mounted in a car, vibrations or impacts may be transmitted to the product to damage the internal parts, causing failure. Install the product in a place free from vibrations and impacts.
- Do not install the projector near high-voltage power lines or power sources.**

The product may be exposed to interference if it is installed in the vicinity of high-voltage electrical power lines or power sources.
- Do not place the projector on a vinyl sheet or carpet.**

If a vinyl sheet sucked up and blocks the air filter intake port, the internal temperature of the projector may increase, which triggers the protection circuit, turning off the power.
- Be sure to ask a specialized technician when to install the product to a ceiling.**

If the product is to be installed hanging from the ceiling, purchase an optional hanging attachment (for high ceiling: Model No. ET-PKD100H) (for low ceiling: Model No. ET-PKD100S) and call a specialized technician for installation.
- Do not place the projector over 2 700 m (8881.5´) above sea level. When using it over 1 400 m (4605.3´) above sea level, set the “ALTITUDE”, described on page 76, to “HIGH”.**

Otherwise the life of the product may be shortened.

## Notes on use

### ■ To view clear images:

- The audience cannot enjoy high-contrast and clear images if outside light or the illumination interferes the screen surface. Draw window curtains or blinds, turn off the lightings near the screen or take other proper measures.
- In rare cases, wafture can occur on the screen affected by the warm air from the exhaust port depending on the environment. Make sure that there is no equipment in front of the set which will recirculate the exhaust air from the set or other nearby equipment.

### ■ Do not touch the surface of the projection lens with bare hand.

If fingerprints or stains are left on the projection lens surface, they are magnified and projected on the screen. Keep your hands away from the lens. Cover the lens with the supplied lens cap when the projector is not used.

### ■ Screen

If the screen has stains, flaws or discoloration, clear images cannot be viewed. When handling the screen, be careful not to apply volatile substances or leave flaws or stains on the screen.

### ■ Lamp

A mercury lamp with high internal pressure is used for the light source of this product. A high-pressure mercury lamp has the following characteristics:

- It may burst with a loud sound or end its life cycle by not illuminating because of given impacts, flaws, or deterioration due to used hours.
- The life cycle of a mercury lamp varies according to the individual difference or conditions of use. In particular, turning the power on and off frequently and/or repeatedly will greatly affect the life cycle.
- In rare cases, it may burst shortly after the first lighting.
- The possibility of burst increases when the lamp is used beyond the replacement time.

### ■ Maintenance

Be sure to remove the power cord plug from the receptacle before cleaning.

- **Use soft and dry cloth to clean the cabinet**  
Use a soft cloth moistened in warm water to clean away oil. If a chemical wipe is used, follow its instructions.
- **Do not clean the lens surface with fuzzy or dusty cloth.**  
If dust adheres to the lens, it will be magnified and projected on the screen. Use a soft and clean cloth to wipe off dust.

## Disposal

To discard the product, call the dealer or a specialized dealer.

# Location and function of each part

## Remote control unit

### ■ Front

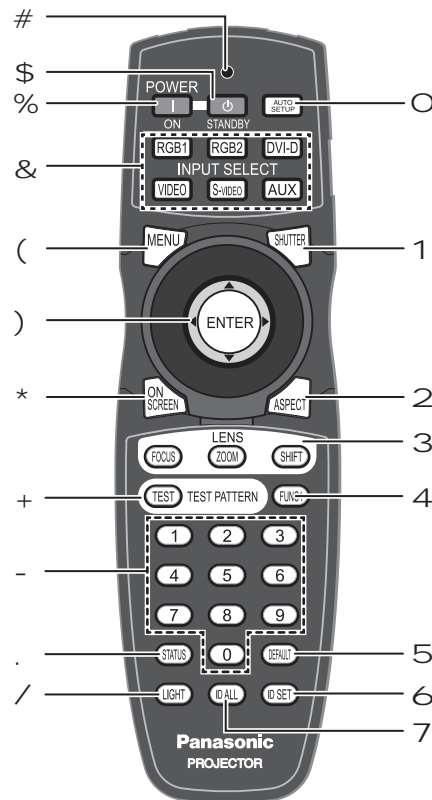

#### # Remote control operation indicator lamp

The lamp flashes when any remote control button is pressed.

#### \$ POWER STANDBY button ..... (pp. 34, 36)

When the projector is in projection mode with the MAIN POWER switch of the projector at the "I" side, this button switches the projector to standby mode.

#### % POWER ON button ..... (pp. 34, 35)

When the projector is in standby mode with the MAIN POWER switch of the projector at the "I" side, this button switches the projector to projection mode.

#### & Input select (RGB1, RGB2, DVI-D, VIDEO, S-VIDEO, AUX) button..... (p. 43)

Use to change the RGB1, RGB2, DVI-D, VIDEO, S-VIDEO and AUX (module input) input ports.

#### ( MENU button..... (pp. 46, 48)

Displays and clears the Main Menu. It can also return to the previous screen when the menu is displayed.

#### ) Arrow ▲ ▼ ◀ ▶ buttons..... (pp. 48, 99)

Use these buttons to select an item on the menu screen, change setting and adjust the level. Also use them to enter the "SECURITY" password.

#### ENTER button ..... (p. 48)

Press this button to enter your menu selection or to run function.

#### \* ON SCREEN button..... (p. 43)

This button turns on and off the on-screen indication function.

#### + TEST PATTERN button ..... (p. 44)

This displays the test pattern.

#### - Numeric (0-9) buttons ..... (pp. 18, 82)

These buttons are used for systems where more than one projector is being used. They are used to enter ID numbers when selecting an ID, and they are also used by service personnel for entering passwords when password entry is needed.

#### . STATUS button..... (p. 43)

Press this button to display projector information. It can also be used to send information about the projector's status via E-mail.

#### / LIGHT button ..... (p. 44)

When this button is pressed, the remote control button light is turned on. The light goes off about 10 seconds after you stop remote control operation.

#### ○ AUTO SET UP button ..... (p. 44)

Pressing this button while projecting an image automatically corrects the picture positioning on the screen. While the auto setup feature is active, a message "PROGRESS..." appears on the screen.

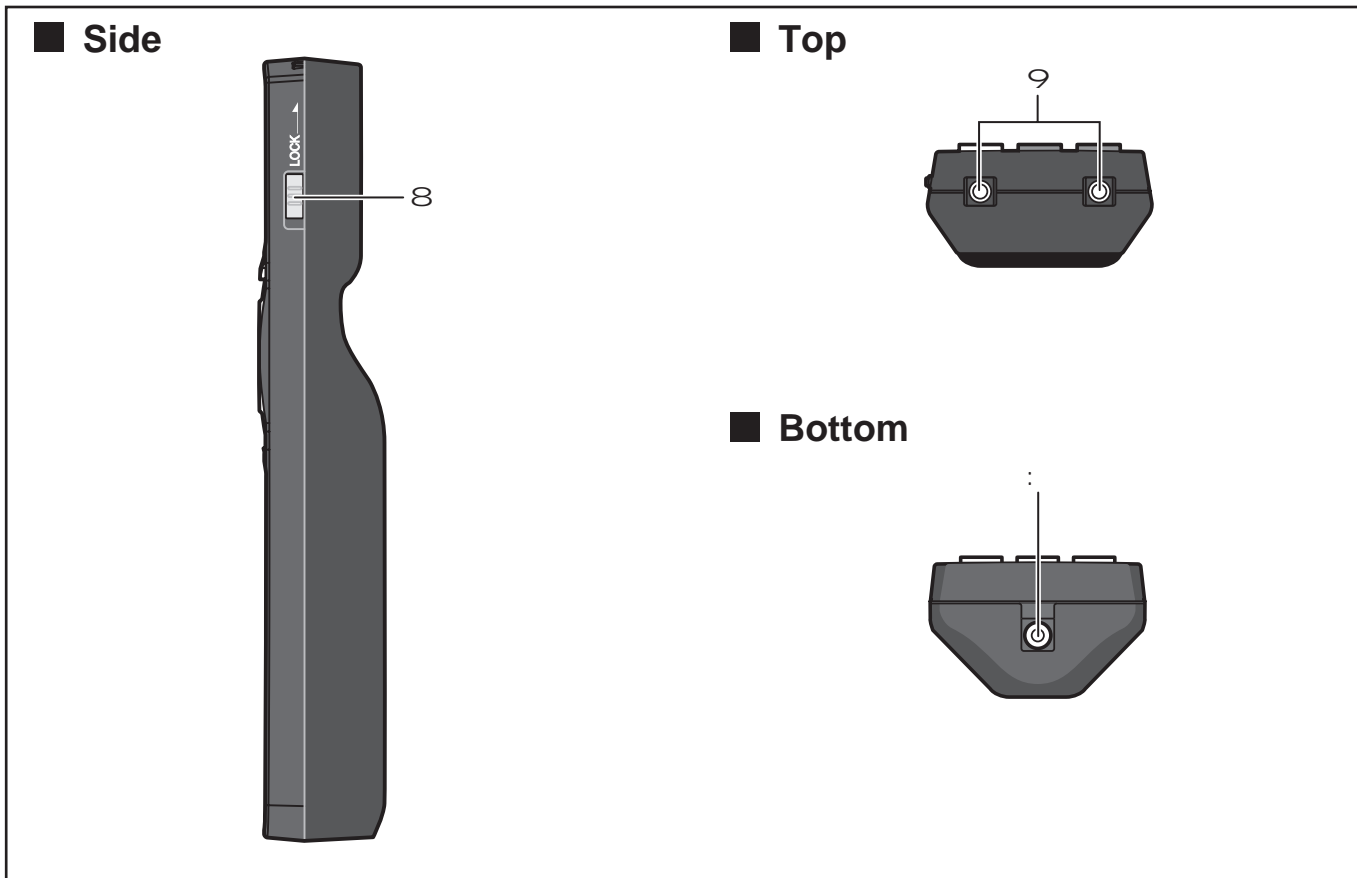

- 1 **SHUTTER button** ..... (p. 43)  
Press this button to black out the image temporarily.
- 2 **ASPECT button**..... (p. 45)  
Switches the image aspect ratio.
- 3 **LENS (FOCUS, ZOOM, SHIFT) button** ..... (p. 37)  
These buttons are used to adjust the projection lens.
- 4 **Function 1 (FUNC1) button**..... (p. 44)  
This button can control the functions set in "FUNC1" of the "OPTION1" screen from MAIN MENU.
- 5 **DEFAULT button** ..... (p. 48)  
Press this button to restore the default factory setting.
- 6 **ID SET button**..... (pp. 18, 75)  
When two or more main units are used in the system, this button specifies the ID of the remote control.
- 7 **ID ALL button** ..... (pp. 18, 75)  
When two or more main units are used in the system, this button switches to the mode to control them simultaneously with a single remote control.

- 8 **LOCK button**  
This button is used to prevent unintentional operation of the projector by accidentally pressing a button, and to prevent the remote control batteries from becoming spent.
- 9 **Remote control transmitter window**  
Operate the remote control aiming at the remote control receiver window on the main unit.
- 10 **Remote control wired terminal**..... (p. 18)  
To use the wired output terminal, connect the remote control and the main unit with the cable (sold separately).

#### Note

- The AUX button to switch the input is disabled when an optional input module is not connected.

## Location and function of each part (continued)

### Projector Main Unit

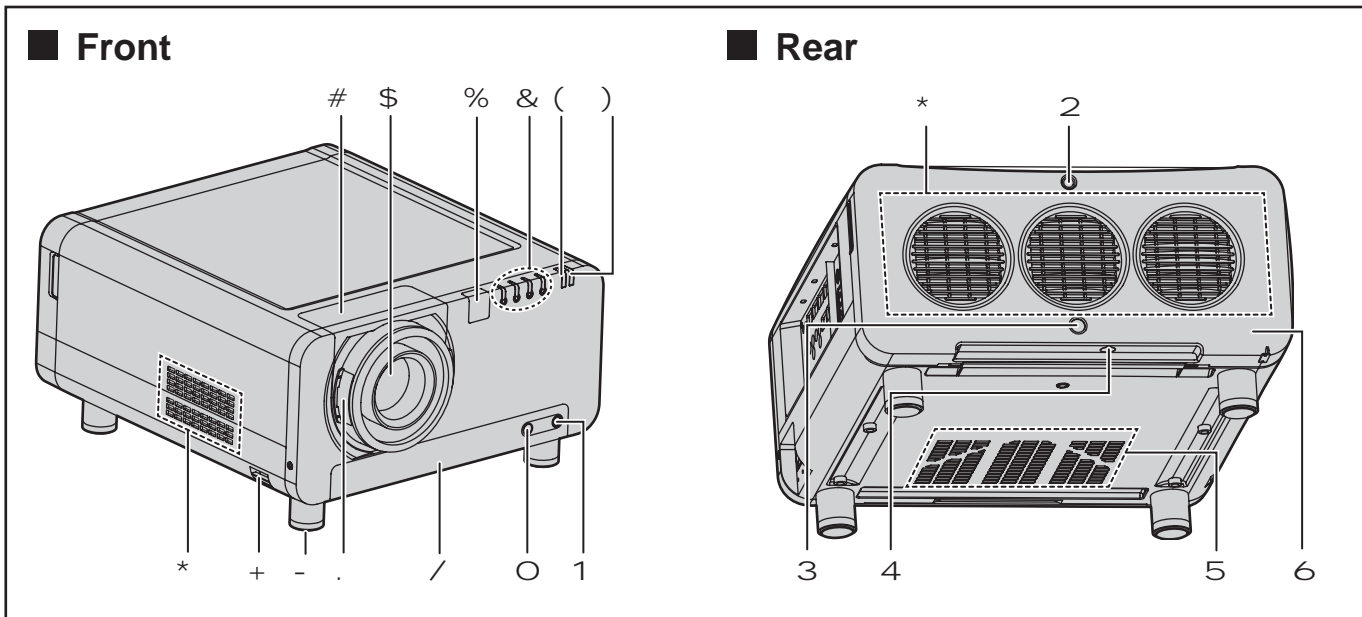

- # **Projection lens cover** ..... (p. 33)
- \$ **Projection lens (optional)**  
Lens for projecting images on the screen.
- % **Remote control receiver window (front)** .. (p. 17)  
This window receives the signal beam emitted from the remote control.
- & **LAMP (LAMP1, LAMP2, LAMP3, LAMP4) monitor** ..... (p. 107)  
These light when it is time to replace the lamp unit. It also blinks if something unusual occurs in the lamp circuit.
- ( **Temperature monitor (TEMP)**..... (p. 107)  
Lighting or blinking of this lamp indicates an abnormal condition of the internal temperature.
- ) **Power indicator lamp** ..... (p. 34)  
The lamp lights in red when the MAIN POWER switch is turned to "I" (on). It turns to green when the POWER ON button of the remote control or the main unit is pressed.
- \* **Air exhaust vents**
- + **Burglar hook**  
Attach a commercial burglar prevention cable to this hook port.
- **Adjustable feet**..... (p. 20)  
Use these feet to adjust the tilt of the projector. (Adjustable feet are provided at the front and rear, right and left.)

- \* **Projection lens cover lock button**..... (p. 33)  
This button toggles between lock and unlock of the detachable cover for the projection lens (optional).
- / **Air filter**..... (p. 108)
- **Air filter cleaning monitor**..... (pp. 80-81, 108)  
This blinks blue while the air filter is being cleaned. It lights red when there is a problem with the air filter.
- 1 **Air filter unit screw**..... (p. 108)  
This is used to secure the air filter cover.
- 2 **Lamp unit cover screw** ..... (p. 111)  
This is used to secure the lamp unit cover.
- 3 **Remote control receiver window (rear)**.... (p. 17)  
This also receives the signal beam coming from the remote control.
- 4 **Remote control receiver window (bottom)** ..... (p. 17)  
This also receives the signal beam coming from the remote control.
- 5 **Air intake vents**  
Do not cover this vents.
- 6 **Lamp unit cover**..... (p. 111)  
The lamp unit is housed.

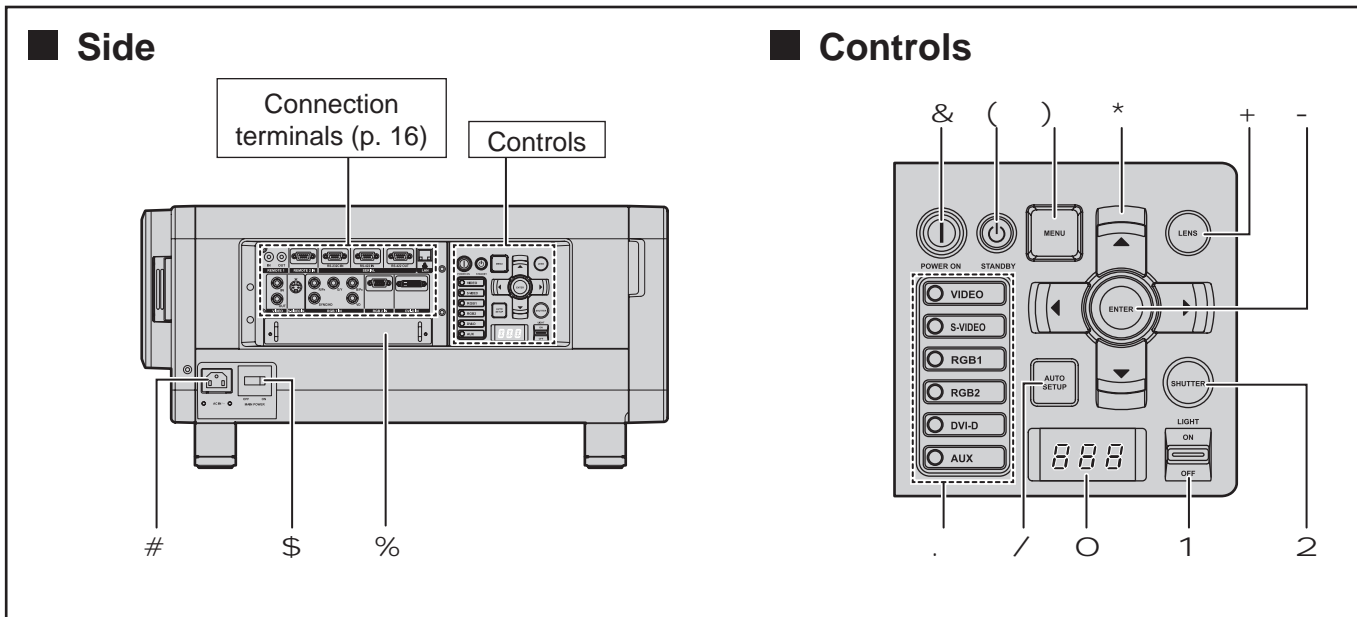

- # **AC IN terminal**..... (p. 34)  
Connect the supplied line power cord into this receptacle.  
Do not connect any other cable to this socket.
- \$ **MAIN POWER switch** ..... (pp. 35, 36)  
Use this switch to turn on “I” and off “o” the commercial line power applied to the projector.
- % **Slot cover** ..... (p. 28)  
Install the input module here.
- & **POWER ON ( I ) button**..... (pp. 34, 35)  
When the projector is in standby mode with the MAIN POWER switch of the projector at the “ I ” side, this button switches the projector to projection mode.
- ( **POWER STANDBY ( ⏻ ) button**..... (pp. 34, 36)  
When the projector is in projection mode with the MAIN POWER switch of the projector at the “ I ” side, this button switches the projector to standby mode.
- ) **MENU button**..... (pp. 46, 48)  
Displays and clears the Main Menu. It can also return to the previous screen when the menu is displayed.  
Menus can be displayed by holding down the MENU button for at least 3 seconds while the on-screen indication function is OFF.
- \* **Arrow ▲▼◀▶ buttons**..... (pp. 48, 99)  
Use to select an item on the menu screen, change setting and adjust the level.  
Also use them to enter the “SECURITY” password.

- + **LENS button**..... (p. 37)  
Switches to the adjustment mode for lens focus, zoom and shift (position).
- **ENTER button** ..... (p. 48)  
Press this button to enter your menu selection or to run function.
- . **Input select (VIDEO, S-VIDEO, RGB1, RGB2, DVI-D, AUX) button**..... (p. 43)  
Use to change the VIDEO, S-VIDEO, RGB1, RGB2, DVI-D and AUX (module input) input ports.
- / **AUTO SETUP button** ..... (p. 44)  
Pressing this button while projecting an image automatically corrects the picture positioning on the screen. While the auto setup feature is active, a message “EXECUTING...” appears on the screen.
- **Self-diagnosis display** ..... (pp. 114-115)
- 1 **LIGHT ON/OFF button**  
This switch is used for illuminating the connection terminals and controls.
- 2 **SHUTTER button** ..... (p. 43)  
Press this button to black out the image temporarily.

#### Note

- The AUX button to switch the input is disabled when an optional input module is not connected.



## Location and function of each part (continued)

### ■ Connection terminals

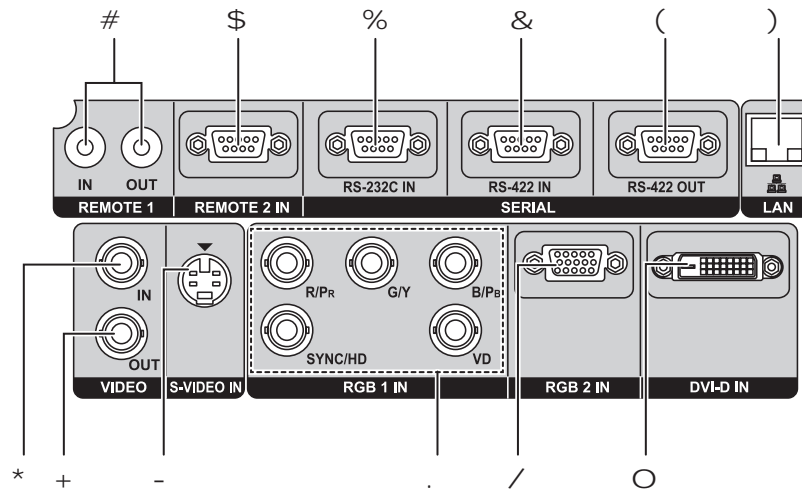

- # **REMOTE1 IN/OUT terminal**.....(p. 18)  
When two or more main units are used in the system, they can be connected and controlled with a wired remote control cable (M3 jack).
- \$ **REMOTE2 IN terminal** .....(p. 106)  
The user can remotely control the main unit by using an external control circuit to this terminal (D-SUB 9-pin female).
- % **SERIAL IN terminal**..... (pp. 25, 26, 79, 102-105)  
This terminal is an RS-232C compliant input terminal (switching necessary) to connect a PC and to externally control the main unit (D-SUB 9-pin female).
- & **SERIAL IN terminal**..... (pp. 25, 26, 79, 102-105)  
This terminal is an RS-422 compliant input terminal (switching necessary) to connect a PC and to externally control the main unit (D-SUB 9-pin female).
- ( **SERIAL OUT terminal**..... (pp. 26, 102-105)  
This terminal is an RS-422 compliant output terminal (switching necessary) to supply signals given to the serial input terminal (D-SUB 9-pin male).
- ) **LAN terminal (10BASE-T/100BASE-TX)** ..... (pp. 25, 26, 85)  
This terminal is used for connecting a LAN cable.
- \* **VIDEO IN terminal**.....(p. 25)  
An input terminal for video signals. (BNC)
- + **VIDEO OUT terminal**.....(p. 25)  
An output terminal (active through) for video signals. (BNC)
- **S-VIDEO IN terminal** .....(p. 25)  
An input terminal for S-video signals (Mini DIN 4-pin). This terminal complies with S1 signals and automatically toggles between 16:9 and 4:3 according to the size of input signals.
- . **RGB (YP<sub>B</sub>P<sub>R</sub>) 1 IN terminal** ..... (pp. 25, 26)  
A terminal to input RGB or YP<sub>B</sub>P<sub>R</sub> signals (BNC).
- / **RGB2 IN terminal**.....(p. 26)  
A terminal to input RGB or YP<sub>B</sub>P<sub>R</sub> signals (D-SUB 15-pin female).
- O **DVI-D IN terminal** ..... (pp. 25, 26)  
An input terminal for DVI-D signals.

# Using the remote control unit

## Loading batteries

When loading supplied AA batteries into the battery compartment of the Remote Control, make sure that their polarities are correct.

### 1. Open battery compartment lid.

- Open the lid in the order # and then \$.

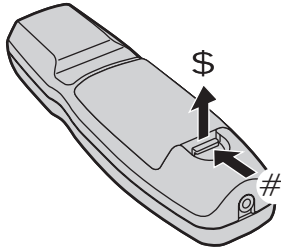

### 2. Insert the batteries.

- Into battery compartment, with their polarities orientated as indicated (+, -) in the compartment.

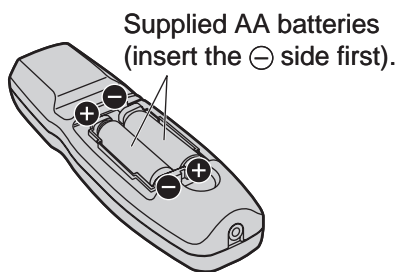

### 3. Close the battery compartment lid.

- Replace the battery compartment lid over the compartment and slide until it clicks.

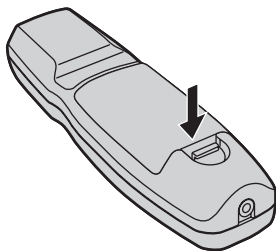

## Attention

- Do not drop the Remote Control unit.
- Do not expose Remote Control unit to any liquid.
- Do not use NiCd batteries.
- Release the LOCK button before operating the remote control. (p. 13)

## Effective range of remote control operation

The Remote Control should normally be aimed at either the front or rear remote control receiver window on the projector (figure 1).

The effective control range is approx. 30 metres from the beam receiver on the front or rear.

Otherwise, it may also be aimed at the screen, which will reflect commands back to the projector's front receiver window as illustrated in figure 2.

- When the Remote Control is aimed at the screen, the effective control range may be reduced due to the optical loss by screen reflection.

Figure 1

- Top View

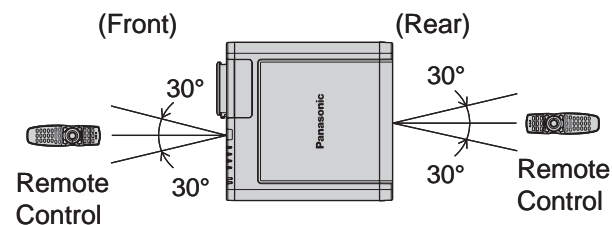

- Side View

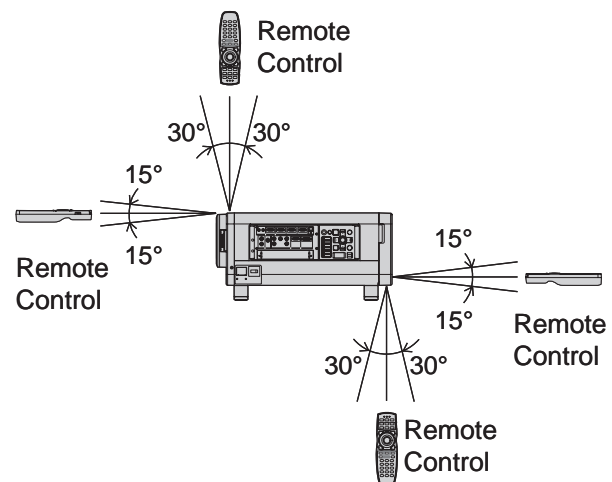
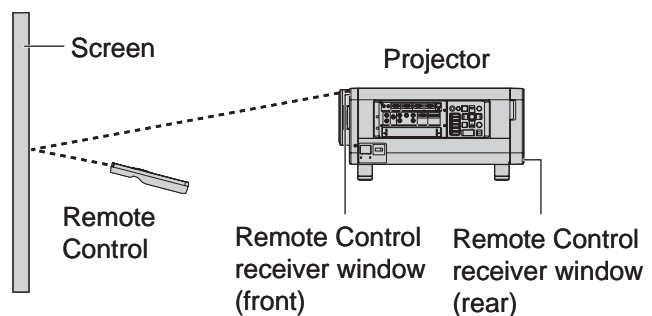

Figure 2



## Using the remote control unit (continued)

### Note

- The Remote Control may not function properly if an object is in the light path.
- The Remote Control receiver may not function properly in intense ambient light such as fluorescent lamps. Carefully site the projector so its Remote Control receiver windows will not be directly exposed to intense light.

## Setting projector ID number to remote control

Every projector has its ID number and the ID number of the controlling projector must be set to the remote control in advance so that the user can operate the remote control. (p. 75) **The ID number of the projector is set to “ALL” on shipping, and use the ID ALL button of the remote control when using only a single projector.**

1. Press ID SET, and then within 5 seconds, press the two numeric (0-9) buttons which correspond to the ID number that has been set for the projector.

### Attention

- Do not press the ID SET button accidentally or carelessly because the ID number on the Remote Control can be set even when no projector is around.
- If you do not enter the two-digit ID number within 5 seconds after the ID SET button has been pressed, the ID number will remain at the number that was set before the ID SET button was pressed.
- Your specified ID number is stored in the remote control unit unless another one is specified later. However, the stored ID will be erased if the batteries of the remote control are left exhausted. When the batteries are replaced, set the same ID number again.

## Using a wired remote control

When multiple main units are connected as part of the system, connect to units with a M3 stereo mini jack cable (sold separately) to simultaneously control multiple main units with a single remote control through the REMOTE1 IN/OUT terminal. It is effective to use the wired remote control in the environment in which an obstacle stands in the light path or where devices are susceptible to outside light.

Connect to the secondary projector

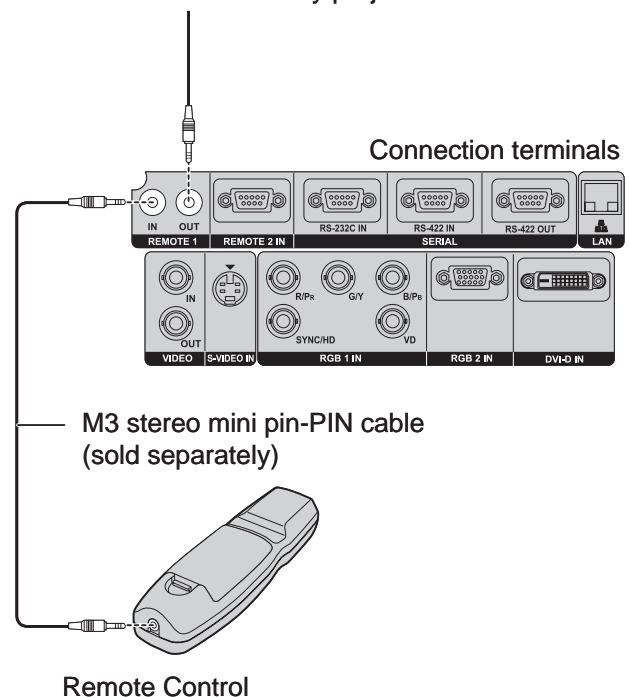

### Attention

- Use a two-wire shielded cable with a length of 15 m or less. If the length of the cable exceeds 15 m, the shielding of the cable may not be sufficient and the remote control may not work.

# Installation

## Examples of system expansion

The projector is provided with a number of terminals and optional accessories to enable various system expansions. Both input and output are provided to all terminals on the main unit. The following are some examples of system expansion:

### System 1

The optional high- or low-ceiling mount bracket flexibly fits the projector in individual site conditions.

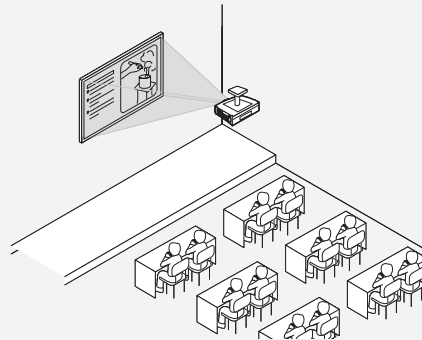
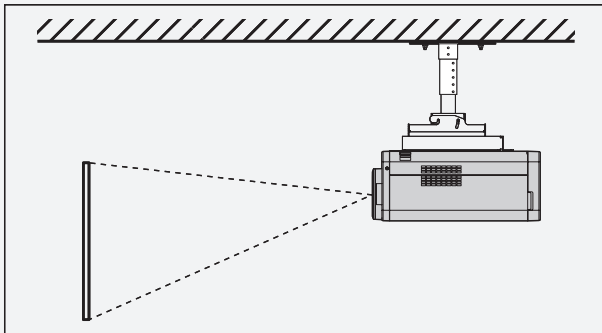

### System 2

Connection to a computer via the DVI-D IN terminal or DVI-D input module (optional).

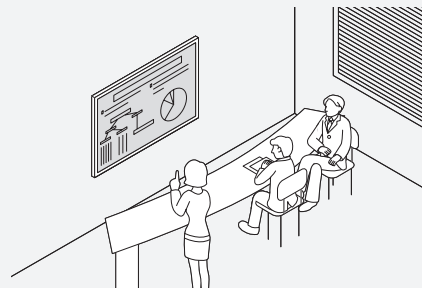
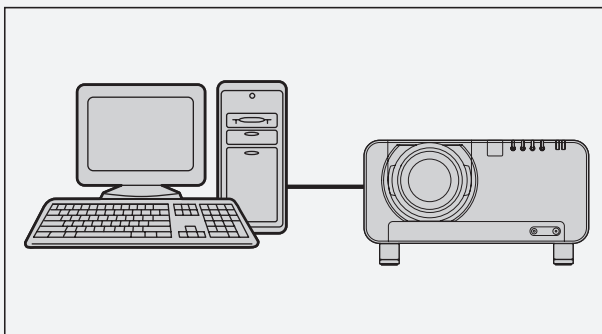

## Installation (continued)

### Adjusting the feet

The four adjustable feet mounted at the bottom of the projector are level-adjustable (0 mm–15 mm) which can be used when the floor surface is not horizontal.

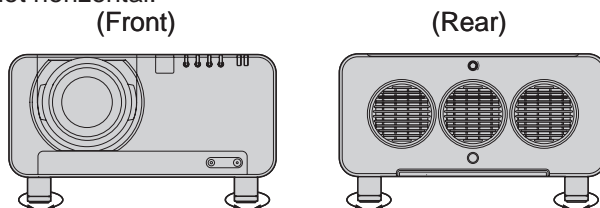

### Projection scheme

This projector can use any of the four projection schemes. Select the most suitable scheme to the situation of your location. Use the OPTION menu on the menu screen to choose the desired projection scheme. (p. 76)

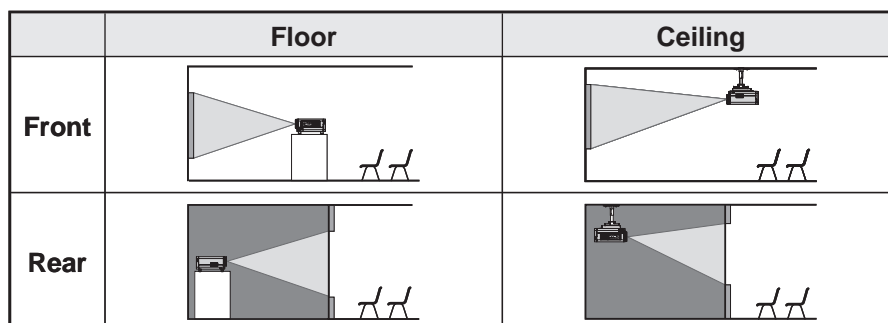

### Installation geometry

When planning the projector and screen geometry, refer to the figures below and the information on the next page for reference. After the projector is roughly positioned, picture size and vertical picture positioning can be finely adjusted with the powered zoom lens and lens shifting mechanism.

#### ● When attaching an optional ceiling mount bracket (ET-PKD100H)

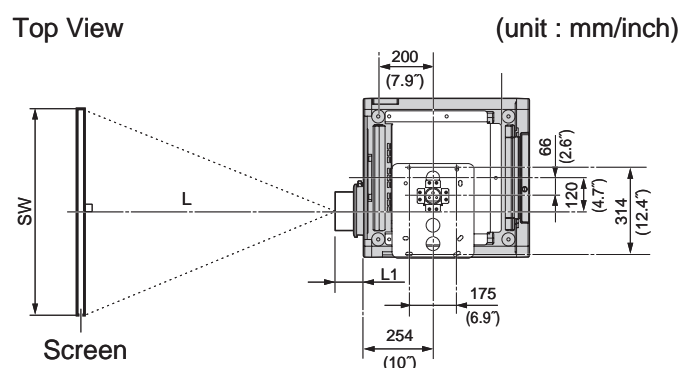
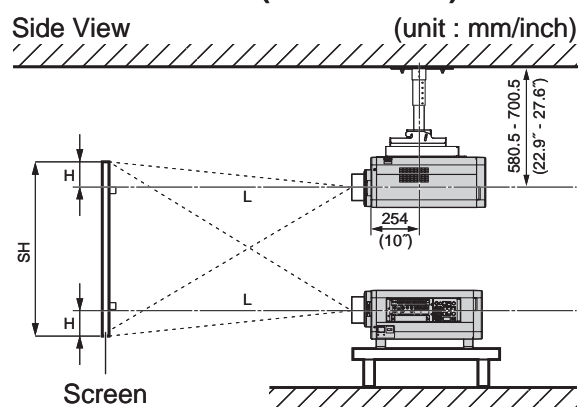

L: Projection distance	SW: Image width
SH: Height of the image	H: Vertical distance between the lens Center level and the bottom edge of the projected image

- \* For PT-D10000U: H = 0 to SH
- For PT-DW10000U: H = -0.1 × SH to 1.1 × SH
- \* However, if the ET-D75LE5 has been installed, the value will be fixed at H=SH/2 for both the PT-D10000U and PT-DW10000U. If the ET-D75LE6 has been installed, the values will be H = 0.1 × SH to 0.9 × SH for the PT-D10000U, and H = 0 to SH for the PT-DW10000U.

Lens	Dimension of L1 (Approx.)
ET-D75LE1	62.5 (2.5")
ET-D75LE2	47 (1.9")
ET-D75LE3	50.5 (2")
ET-D75LE4	74.4 (2.9")
ET-D75LE5	150.5 (5.9")
ET-D75LE6	160 (6.3")
ET-D75LE8	202.5 (8")

## Projection distances by the type of projection lenses (optional)

Every type of optional projection lenses has a different projection distance to achieve the same screen size. Select and purchase a projection lens most suitable to the size of your location referring to the following tables and the projection distances by the type of projection lenses on the next page.

### Side View

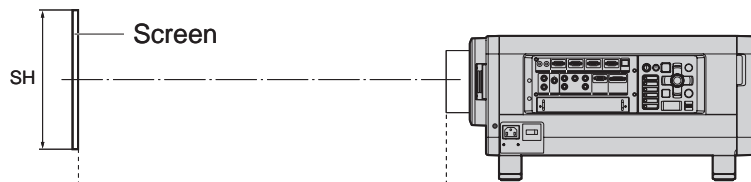

### Top View

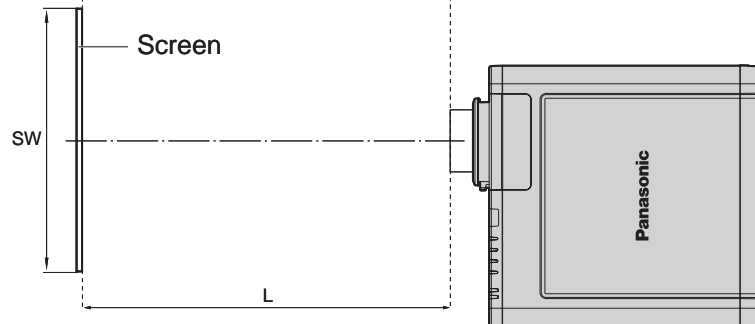

L : Projection distance  
SH : Effective screen height  
SW : Effective screen width

### Note

- The projection distances listed here involve an error of  $\pm 5\%$ .
- Keystone distortions are corrected in the way the screen size becomes smaller than the original one.

## Projection distances by the type of projection lenses (for PT-DW10000U)

- For the screen aspect ratio of 16:9 (Units: m (feet/inches))

Lens type			Zoom lens												Fixed-focus lens
Model number of projection lens			ET-D75LE1	ET-D75LE2	ET-D75LE3	ET-D75LE4	ET-D75LE8	ET-D75LE6	ET-D75LE5						
Throw ratio*1			1.4-1.8 : 1	1.8-2.8 : 1	2.8-4.6 : 1	4.6-7.4 : 1	7.3-13.8 : 1	0.9-1.1 : 1	0.7 : 1						
Screen dimensions			Projection distance (L)												
Screen size (inch)	Effective height (SH)	Effective width (SW)	Min.	Max.	Min.	Max.	Min.	Max.	Min.	Max.	Min.	Max.	Min.	Max.	Fixed
70	0.872 (2'10")	1.550 (5'1")	2.07 (6'9")	2.77 (9'1")	2.80 (9'2")	4.21 (13'9")	4.23 (13'10")	7.09 (23'3")	7.10 (23'3")	11.37 (37'3")	11.09 (36'4")	21.14 (69'4")	1.39 (4'6")	1.66 (5'5")	1.02 (3'4")
80	0.996 (3'3")	1.771 (5'9")	2.38 (7'9")	3.18 (10'5")	3.21 (10'6")	4.83 (15'10")	4.84 (15'10")	8.13 (26'8")	8.13 (26'8")	13.01 (42'8")	12.73 (41'9")	24.21 (79'5")	1.60 (5'2")	1.91 (6'3")	1.18 (3'10")
90	1.121 (3'8")	1.992 (6'6")	2.68 (8'9")	3.59 (11'9")	3.62 (11'10")	5.45 (17'10")	5.46 (17'10")	9.16 (30")	9.16 (30")	14.65 (48")	14.37 (47'1")	27.29 (89'6")	1.81 (5'11")	2.16 (7'1")	1.34 (4'4")
100	1.245 (4'1")	2.214 (7'3")	2.99 (9'9")	4.00 (13'1")	4.04 (13'3")	6.07 (19'10")	6.08 (19'11")	10.19 (33'5")	10.19 (33'5")	16.29 (53'5")	16.01 (52'6")	30.36 (99'7")	2.01 (6'7")	2.41 (7'10")	1.50 (4'11")
120	1.494 (4'10")	2.657 (8'8")	3.60 (11'9")	4.82 (15'9")	4.86 (15'11")	7.30 (23'11")	7.31 (23'11")	12.25 (40'2")	12.26 (40'2")	19.57 (64'2")	19.29 (63'3")	36.50 (119'9")	2.43 (7'11")	2.90 (9'6")	1.81 (5'11")
150	1.868 (6'1")	3.321 (10'10")	4.53 (14'10")	6.05 (19'10")	6.09 (19'11")	9.15 (30")	9.16 (30")	15.34 (50'3")	15.35 (50'4")	24.49 (80'4")	24.21 (79'5")	45.72 (150")	3.05 (10")	3.65 (11'11")	2.29 (7'6")
200	2.491 (8'2")	4.428 (14'6")	6.06 (19'10")	8.10 (26'6")	8.15 (26'8")	12.24 (40'1")	12.25 (40'2")	20.50 (67'3")	20.50 (67'3")	32.69 (107'3")	32.40 (106'3")	61.08 (200'4")	4.08 (13'4")	4.89 (16")	3.08 (10'1")
250	3.113 (10'2")	5.535 (18'1")	7.59 (24'10")	10.15 (33'3")	10.21 (33'5")	15.33 (50'3")	15.34 (50'3")	25.65 (84'1")	25.66 (84'2")	40.88 (134'1")	40.60 (133'2")	76.44 (250'9")	5.12 (16'9")	6.13 (20'1")	3.87 (12'8")
300	3.736 (12'3")	6.641 (21'9")	9.13 (29'11")	12.19 (39'11")	12.27 (40'3")	18.41 (60'4")	18.42 (60'5")	30.81 (101")	30.81 (101")	49.08 (161")	48.80 (160'1")	91.79 (301'1")	6.15 (20'2")	7.37 (24'2")	4.66 (15'3")
350	4.358 (14'3")	7.748 (25'5")	10.66 (34'11")	14.24 (46'8")	14.32 (46'11")	21.50 (70'6")	21.51 (70'6")	35.96 (117'11")	35.97 (118")	57.28 (187'")	57.00 (187')	107.15 (351'6")	7.19 (23'7")	8.61 (28'2")	
400	4.981 (16'4")	8.855 (29")	12.19 (39'11")	16.29 (53'5")	16.38 (53'8")	24.58 (80'7")	24.60 (80'8")	41.12 (134'10")	41.12 (134'10")	65.47 (214'9")	65.19 (213'10")	122.51 (401'11")	8.22 (26'11")	9.85 (32'3")	
500	6.226 (20'5")	11.069 (36'3")	15.26 (50")	20.39 (66'10")	20.50 (67'3")	30.76 (100'11")	30.77 (100'11")	51.42 (168'8")	51.43 (168'8")	81.87 (268'7")	81.59 (267'8")	153.23 (502'8")	10.29 (33'9")	12.33 (40'5")	
600	7.472 (24'6")	13.283 (43'6")	18.33 (60'1")	24.49 (80'4")	24.61 (80'8")	36.93 (121'1")	36.94 (121'2")	61.73 (202'6")	61.74 (202'6")	98.26 (322'4")	97.98 (321'5")	183.95 (603'6")	12.36 (40'6")	14.81 (48'7")	

\*1: "Throw ratio" is the approximate measurement range of the screen width to the projection distance.

## Installation (continued)

### ■ Projection distances by the type of projection lenses (for PT-D10000U)

- For the screen aspect ratio of 4:3 (Units: m (feet/inches))

Lens type			Zoom lens												Fixed-focus lens
Model number of projection lens			ET-D75LE1	ET-D75LE2	ET-D75LE3	ET-D75LE4	ET-D75LE8	ET-D75LE6	ET-D75LE5						
Throw ratio*1			1.5-2.0 : 1	2.0-3.0 : 1	3.0-5.0 : 1	5.0-8.0 : 1	7.9-15.0 : 1	1.0-1.2 : 1	0.8 : 1						
Screen dimensions			Projection distance (L)												Fixed
Screen size (inch)	Effective height (SH)	Effective width (SW)	Min.	Max.	Min.	Max.	Min.	Max.	Min.	Max.	Min.	Max.	Min.	Max.	Fixed
70	1.067 (3'6")	1.422 (4'7")	2.07 (6'9")	2.77 (9'1")	2.80 (9'2")	4.21 (13'9")	4.23 (13'10")	7.09 (23'3")	7.10 (23'3")	11.37 (37'3")	11.09 (36'4")	21.14 (69'4")	1.39 (4'6")	1.66 (5'5")	1.02 (3'4")
80	1.219 (3'11")	1.626 (5'4")	2.38 (7'9")	3.18 (10'5")	3.21 (10'6")	4.83 (15'10")	4.84 (15'10")	8.13 (26'8")	8.13 (26'8")	13.01 (42'8")	12.73 (41'9")	24.21 (79'5")	1.60 (5'2")	1.91 (6'3")	1.18 (3'10")
90	1.372 (4'6")	1.829 (6")	2.68 (8'9")	3.59 (11'9")	3.62 (11'10")	5.45 (17'10")	5.46 (17'10")	9.16 (30")	9.16 (30")	14.65 (48")	14.37 (47'1")	27.29 (89'6")	1.81 (5'11")	2.16 (7'1")	1.34 (4'4")
100	1.524 (5")	2.032 (6'8")	2.99 (9'9")	4.00 (13'1")	4.04 (13'3")	6.07 (19'10")	6.08 (19'11")	10.19 (33'5")	10.19 (33'5")	16.29 (53'5")	16.01 (52'6")	30.36 (99'7")	2.01 (6'7")	2.41 (7'10")	1.50 (4'11")
120	1.829 (6")	2.438 (7'11")	3.60 (11'9")	4.82 (15'9")	4.86 (15'11")	7.30 (23'11")	7.31 (23'11")	12.25 (40'2")	12.26 (40'2")	19.57 (64'2")	19.29 (63'3")	36.50 (119'9")	2.43 (7'11")	2.90 (9'6")	1.81 (5'11")
150	2.286 (7'6")	3.048 (10")	4.53 (14'10")	6.05 (19'10")	6.09 (19'11")	9.15 (30")	9.16 (30")	15.34 (50'3")	15.35 (50'4")	24.49 (80'4")	24.21 (79'5")	45.72 (150")	3.05 (10")	3.65 (11'11")	2.29 (7'6")
200	3.048 (10")	4.064 (13'4")	6.06 (19'10")	8.10 (26'6")	8.15 (26'8")	12.24 (40'1")	12.25 (40'2")	20.50 (67'3")	20.50 (67'3")	32.69 (107'3")	32.40 (106'3")	61.08 (200'4")	4.08 (13'4")	4.89 (16")	3.08 (10'1")
250	3.810 (12'6")	5.080 (16'8")	7.59 (24'10")	10.15 (33'3")	10.21 (33'5")	15.33 (50'3")	15.34 (50'3")	25.65 (84'1")	25.66 (84'2")	40.88 (134'1")	40.60 (133'2")	76.44 (250'9")	5.12 (16'9")	6.13 (20'1")	3.87 (12'8")
300	4.572 (15")	6.096 (20")	9.13 (29'11")	12.19 (39'11")	12.27 (40'3")	18.41 (60'4")	18.42 (60'5")	30.81 (101")	30.81 (101")	49.08 (161")	48.80 (160'1")	91.79 (301'1")	6.15 (20'2")	7.37 (24'2")	4.66 (15'3")
350	5.334 (17'6")	7.112 (23'4")	10.66 (34'11")	14.24 (46'8")	14.32 (46'11")	21.50 (70'6")	21.51 (70'6")	35.96 (117'11")	35.97 (118")	57.28 (187'11")	57.00 (187")	107.15 (351'6")	7.19 (23'7")	8.61 (28'2")	
400	6.096 (20")	8.128 (26'8")	12.19 (39'11")	16.29 (53'5")	16.38 (53'8")	24.58 (80'7")	24.60 (80'8")	41.12 (134'10")	41.12 (134'10")	65.47 (214'9")	65.19 (213'10")	122.51 (401'11")	8.22 (26'11")	9.85 (32'3")	
500	7.620 (25")	10.160 (33'4")	15.26 (50")	20.39 (66'10")	20.50 (67'3")	30.76 (100'11")	30.77 (100'11")	51.42 (168'8")	51.43 (168'8")	81.87 (268'7")	81.59 (267'8")	153.23 (502'8")	10.29 (33'9")	12.33 (40'5")	
600	9.144 (30")	12.192 (40")	18.33 (60'1")	24.49 (80'4")	24.61 (80'8")	36.93 (121'1")	36.94 (121'2")	61.73 (202'6")	61.74 (202'6")	98.26 (322'4")	97.98 (321'5")	183.95 (603'6")	12.36 (40'6")	14.81 (48'7")	

- For the screen aspect ratio of 16:9 (Units: m (feet/inches))

Lens type			Zoom lens												Fixed-focus lens
Model number of projection lens			ET-D75LE1	ET-D75LE2	ET-D75LE3	ET-D75LE4	ET-D75LE8	ET-D75LE6	ET-D75LE5						
Throw ratio*1			1.5-2.0 : 1	2.0-3.0 : 1	3.0-5.0 : 1	5.0-8.0 : 1	8.0-15.0 : 1	1.0-1.2 : 1	0.8 : 1						
Screen dimensions			Projection distance (L)												Fixed
Screen size (inch)	Effective height (SH)	Effective width (SW)	Min.	Max.	Min.	Max.	Min.	Max.	Min.	Max.	Min.	Max.	Min.	Max.	Fixed
70	0.872 (2'10")	1.550 (5'1")	2.26 (7'4")	3.02 (9'10")	3.06 (10")	4.60 (15'1")	4.61 (15'1")	7.74 (25'4")	7.75 (25'5")	12.40 (40'8")	12.12 (39'9")	23.06 (75'7")	1.52 (4'11")	1.82 (5'11")	1.12 (3'8")
80	0.996 (3'3")	1.771 (5'9")	2.60 (8'6")	3.47 (11'4")	3.51 (11'6")	5.27 (17'3")	5.28 (17'3")	8.86 (29")	8.87 (29'1")	14.18 (46'6")	14.18 (45'7")	26.41 (86'7")	1.75 (5'8")	2.09 (6'10")	1.29 (4'2")
90	1.121 (3'8")	1.992 (6'6")	2.93 (9'7")	3.92 (12'10")	3.95 (12'11")	5.95 (19'6")	5.96 (19'6")	9.99 (32'9")	9.99 (32'9")	15.97 (52'4")	15.69 (51'5")	29.76 (97'7")	1.97 (6'5")	2.36 (7'8")	1.47 (4'9")
100	1.245 (4'1")	2.214 (7'3")	3.27 (10'8")	4.36 (14'3")	4.40 (14'5")	6.62 (21'8")	6.63 (21'9")	11.11 (36'5")	11.11 (36'5")	17.76 (57'3")	17.47 (57'3")	33.10 (108'7")	2.20 (7'2")	2.63 (8'7")	1.64 (5'4")
120	1.494 (4'10")	2.657 (8'8")	3.93 (12'10")	5.26 (17'3")	5.30 (17'4")	7.96 (26'1")	7.97 (26'1")	13.35 (43'9")	13.36 (43'9")	21.33 (69'11")	21.04 (69")	39.79 (130'6")	2.65 (8'8")	3.17 (10'4")	1.98 (6'5")
150	1.868 (6'1")	3.321 (10'10")	4.94 (16'2")	6.60 (21'7")	6.64 (21'9")	9.98 (32'8")	9.99 (32'9")	16.72 (54'10")	16.73 (54'10")	26.68 (87'6")	26.40 (86'7")	49.83 (163'5")	3.33 (10'11")	3.98 (13")	2.50 (8'2")
200	2.491 (8'2")	4.428 (14'6")	6.61 (21'8")	8.83 (28'11")	8.89 (29'2")	13.34 (43'9")	13.35 (43'9")	22.34 (73'3")	22.34 (73'3")	35.61 (116'9")	35.33 (115'10")	66.56 (218'4")	4.45 (14'7")	5.33 (17'5")	3.36 (11")
250	3.113 (10'2")	5.535 (18'1")	8.28 (27'1")	11.06 (36'3")	11.13 (36'6")	16.70 (54'9")	16.71 (54'9")	27.95 (91'8")	27.96 (91'8")	44.54 (146'1")	44.26 (145'2")	83.29 (273'3")	5.58 (18'3")	6.68 (21'10")	4.22 (13'10")
300	3.736 (12'3")	6.641 (21'9")	9.95 (32'7")	13.29 (43'7")	13.37 (43'10")	20.07 (65'10")	20.08 (65'10")	33.57 (110'1")	33.57 (110'1")	53.47 (175'5")	53.19 (174'6")	100.02 (328'1")	6.71 (22")	8.03 (26'4")	5.08 (16'8")
350	4.358 (14'3")	7.748 (25'5")	11.62 (38'1")	15.52 (50'11")	15.61 (51'2")	23.43 (76'10")	23.44 (76'10")	39.18 (128'6")	39.19 (128'6")	62.40 (204'8")	62.12 (203'9")	116.75 (383")	7.84 (25'8")	9.38 (30'9")	
400	4.981 (16'4")	8.855 (29")	13.29 (43'7")	17.76 (58'3")	17.85 (58'6")	26.79 (87'10")	26.80 (87'11")	44.80 (146'11")	44.80 (146'11")	71.33 (234")	71.05 (233'1")	133.48 (437'11")	8.96 (29'4")	10.73 (35'2")	
500	6.226 (20'5")	11.069 (36'3")	16.63 (54'6")	22.22 (72'10")	22.33 (73'3")	33.51 (109'11")	33.52 (109'11")	56.03 (183'9")	56.03 (183'9")	89.19 (292'7")	88.91 (291'8")	166.95 (547'8")	11.22 (36'9")	13.43 (44")	
600	7.472 (24'6")	13.283 (43'6")	19.97 (65'6")	26.69 (87'6")	26.82 (87'11")	40.24 (132")	40.25 (132")	67.26 (220'8")	67.26 (220'8")	107.04 (351'2")	106.77 (350'3")	200.41 (657'6")	13.47 (44'2")	16.14 (52'11")	

\*1: "Throw ratio" is the approximate measurement range of the screen width to the projection distance.

If the projector is used with a screen size not listed in this manual, check the diagonal dimension (inch) of your screen and calculate the projection distance using the following formulas.

### ■ Calculation formulas for projection distance by lens types (for PT-DW1000U)

Model number of projection lens		Throw ratio	Aspect ratio	Projection distance (L) formula	Units: m
Zoom lens	ET-D75LE1	1.4-1.8 : 1	16:9	Minimal distance: $L=0.0307 \times \text{Screen diagonal (inch)} - 0.0760$ Maximal distance: $L=0.0410 \times \text{Screen diagonal (inch)} - 0.1004$	
	ET-D75LE2	1.8-2.8 : 1	16:9	Minimal distance: $L=0.0412 \times \text{Screen diagonal (inch)} - 0.0795$ Maximal distance: $L=0.0617 \times \text{Screen diagonal (inch)} - 0.1064$	
	ET-D75LE3	2.8-4.6 : 1	16:9	Minimal distance: $L=0.0617 \times \text{Screen diagonal (inch)} - 0.0958$ Maximal distance: $L=0.1031 \times \text{Screen diagonal (inch)} - 0.1216$	
	ET-D75LE4	4.6-7.4 : 1	16:9	Minimal distance: $L=0.1031 \times \text{Screen diagonal (inch)} - 0.1158$ Maximal distance: $L=0.1639 \times \text{Screen diagonal (inch)} - 0.1013$	
	ET-D75LE8	7.3-13.8 : 1	16:9	Minimal distance: $L=0.1640 \times \text{Screen diagonal (inch)} - 0.3862$ Maximal distance: $L=0.3072 \times \text{Screen diagonal (inch)} - 0.3598$	
	ET-D75LE6	0.9-1.1 : 1	16:9	Minimal distance: $L=0.0207 \times \text{Screen diagonal (inch)} - 0.0566$ Maximal distance: $L=0.0248 \times \text{Screen diagonal (inch)} - 0.0736$	
Fixed-focus lens	ET-D75LE5	0.7 : 1	16:9	$L = 0.0158 \times \text{Screen diagonal (inch)} - 0.0835$	

### ■ Calculation formulas for projection distance by lens types (for PT-D1000U)

Model number of projection lens		Throw ratio	Aspect ratio	Projection distance (L) formula	Units: m
Zoom lens	ET-D75LE1	1.5-2.0 : 1	4:3	Minimal distance: $L=0.0307 \times \text{Screen diagonal (inch)} - 0.0760$ Maximal distance: $L=0.0410 \times \text{Screen diagonal (inch)} - 0.1004$	
			16:9	Minimal distance: $L=0.0334 \times \text{Screen diagonal (inch)} - 0.0760$ Maximal distance: $L=0.0446 \times \text{Screen diagonal (inch)} - 0.1004$	
	ET-D75LE2	2.0-3.0 : 1	4:3	Minimal distance: $L=0.0412 \times \text{Screen diagonal (inch)} - 0.0795$ Maximal distance: $L=0.0617 \times \text{Screen diagonal (inch)} - 0.1064$	
			16:9	Minimal distance: $L=0.0448 \times \text{Screen diagonal (inch)} - 0.0795$ Maximal distance: $L=0.0672 \times \text{Screen diagonal (inch)} - 0.1064$	
	ET-D75LE3	3.0-5.0 : 1	4:3	Minimal distance: $L=0.0617 \times \text{Screen diagonal (inch)} - 0.0958$ Maximal distance: $L=0.1031 \times \text{Screen diagonal (inch)} - 0.1216$	
			16:9	Minimal distance: $L=0.0672 \times \text{Screen diagonal (inch)} - 0.0958$ Maximal distance: $L=0.1123 \times \text{Screen diagonal (inch)} - 0.1216$	
	ET-D75LE4	5.0-8.0 : 1	4:3	Minimal distance: $L=0.1031 \times \text{Screen diagonal (inch)} - 0.1158$ Maximal distance: $L=0.1639 \times \text{Screen diagonal (inch)} - 0.1013$	
			16:9	Minimal distance: $L=0.1123 \times \text{Screen diagonal (inch)} - 0.1158$ Maximal distance: $L=0.1786 \times \text{Screen diagonal (inch)} - 0.1013$	
	ET-D75LE8	7.9-15.0 : 1	4:3	Minimal distance: $L=0.1640 \times \text{Screen diagonal (inch)} - 0.3862$ Maximal distance: $L=0.3072 \times \text{Screen diagonal (inch)} - 0.3598$	
		8.0-15.0 : 1	16:9	Minimal distance: $L=0.1786 \times \text{Screen diagonal (inch)} - 0.3862$ Maximal distance: $L=0.3346 \times \text{Screen diagonal (inch)} - 0.3598$	
	ET-D75LE6	1.0-1.2 : 1	4:3	Minimal distance: $L=0.0207 \times \text{Screen diagonal (inch)} - 0.0566$ Maximal distance: $L=0.0248 \times \text{Screen diagonal (inch)} - 0.0736$	
			16:9	Minimal distance: $L=0.0225 \times \text{Screen diagonal (inch)} - 0.0566$ Maximal distance: $L=0.0270 \times \text{Screen diagonal (inch)} - 0.0736$	
Fixed-focus lens	ET-D75LE5	0.8 : 1	4:3	$L = 0.0158 \times \text{Screen diagonal (inch)} - 0.0835$	
			16:9	$L = 0.0172 \times \text{Screen diagonal (inch)} - 0.0835$	



# Connection

## Before starting connection

- Before connection, read carefully the instruction manual for the device to be connected.
- Turning off the power switch of the devices before connecting cables.
- If any connection cable is not supplied with the device, or if no optional cable is available for connection of the device, prepare a necessary system connection cable to suit the device.
- Video signals containing too much jitter may cause the images on the screen to randomly wobble or wafture. In this case, a time base corrector (TBC) must be connected.
- The projector accepts the following signals: video, S-Video, analog RGB, DVI-D and signals which are compatible with the optional input module (p. 27).
- Some PC models cannot be connected to the projector.

- The pin-out and signal names of the S-VIDEO IN terminal are shown in the diagram below.

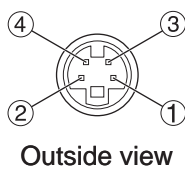

Pin No.	Signal
#	Ground (luminance signal)
\$	Ground (color signal)
%	Luminance signal
&	Color signal

- The pin-out and signal names of the RGB2 IN terminal are shown in the diagram below.

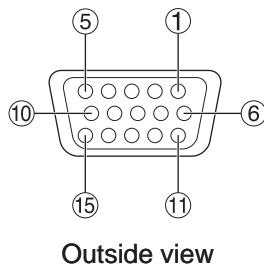

Pin No.	Signal
#	R/P <sub>R</sub>
\$	G/G • SYNC/Y
%	B/P <sub>B</sub>
1	HD/SYNC
2	VD

&, - , O, and 3 are not assigned.  
 ( - + , . and / are GND terminals.

- The pin-out and signal names of the DVI-D IN terminal are shown in the diagram below.

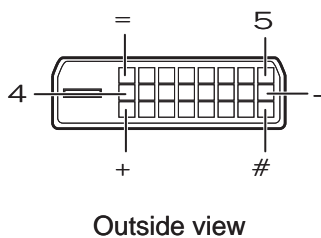

Pin No.	Signal	Pin No.	Signal
#	T.M.D.S data 2-	1	
\$	T.M.D.S data 2+	2	+5V
%	T.M.D.S data 2 / 4 shield	3	Ground
&		4	Hot plug detection
(		5	T.M.D.S data 0-
)	DDC clock	6	T.M.D.S data 0+
*	DDC data	7	T.M.D.S data 0 / 5 shield
+		8	
-	T.M.D.S data 1-	9	
.	T.M.D.S data 1+	:	T.M.D.S clock shield
/	T.M.D.S data 1 / 3 shield	;	T.M.D.S clock+
O		=	T.M.D.S clock-

## Example of connecting with VIDEO devices

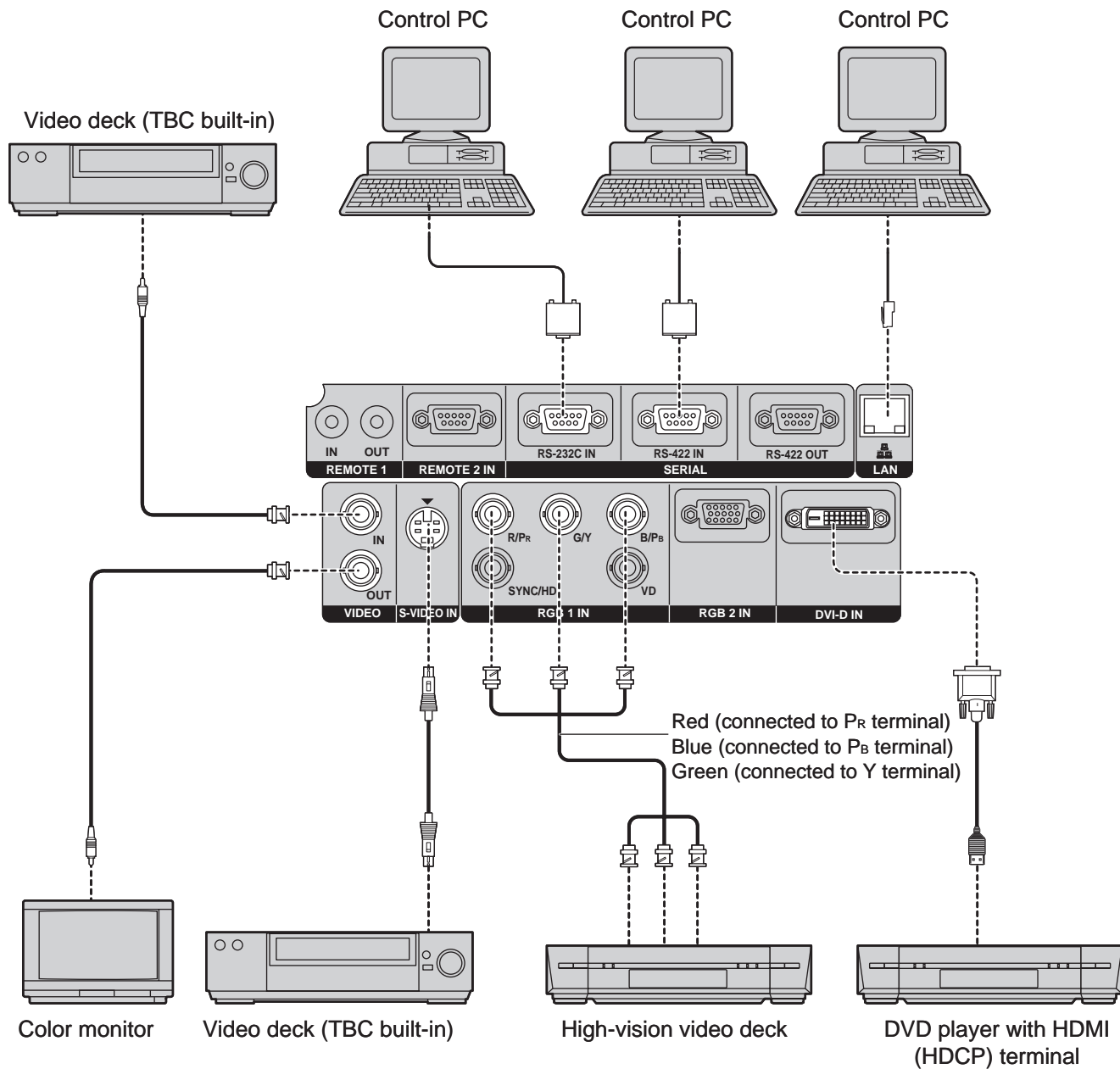

### Attention

- When connecting with a video deck, be sure to use the one with a built-in time base corrector (TBC) or use a TBC between the projector and the video deck.
- If nonstandard burst signals are connected, the image may be distorted. If this is the case, connect a TBC between the projector and the video deck.

### Note

- The DVI-D signal input terminal supports only a single link.
- The HDMI-DVI-D conversion cable is required to connect an HDMI-compliant device.
- The EDID mode setting must be selected so that it corresponds to the device to be connected. (pp. 71, 72)
- It is possible to connect the DVI-D input terminal with an HDMI- or DVI-D-compliant device, but with some devices the images may not appear or other problems may be encountered in operation.

## Connection (continued)

### Example of connecting with personal computers

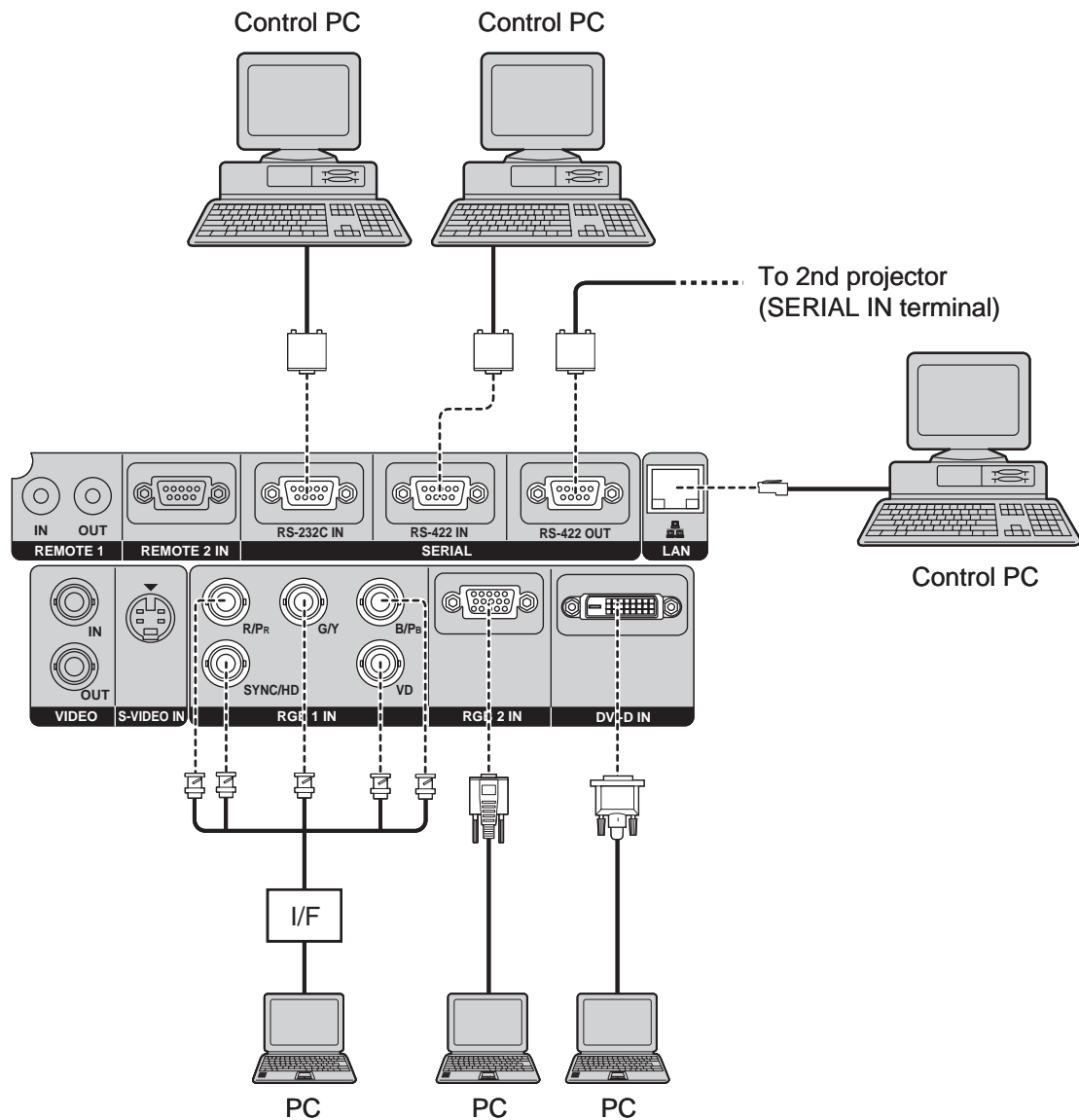

#### Attention

- When the main power of the main unit is turned off, also turn off the power of the PC.

#### Note

- For the specifications of the RGB signals that can be applied from the PC, see the data sheet on page 118.
- If your PC has the resume feature (last memory), the computer may not function properly until the resume capability is disabled.

# Installation of input module (optional)

## Installing the input module

### ■ Types of the input modules (optional)

Prepare beforehand an input module (optional) compatible with the input signals of the system.

Module	Module model No.	Terminal	Signal formats supported
SD-SDI input module	ET-MD77SD1	BNC input x 1 BNC output x 1	SMPTE259M compliant : 480i, 576i
		RJ-45 input x 1 <sup>*1</sup>	10BASE-T/100BASE-TX
HD/SD-SDI input module	ET-MD77SD3	BNC input x 1 BNC output x 1	SMPTE259M compliant : 480i, 576i SMPTE292M compliant : 720/60p, 720/59.94p, 720/50p 1 035/60i, 1 035/59.94i, 1 080/60i, 1 080/59.94i 1 080/50i, 1 080/24sF, 1 080/23.98sF, 1 080/30p 1 080/29.97p, 1 080/25p, 1 080/24p, 1 080/23.98p
		RJ-45 input x 1 <sup>*1</sup>	10BASE-T/100BASE-TX
DVI-D input module	ET-MD77DV	DVI-D 24p input x 1	HDCP-compliant <sup>*2</sup> DVI-D single link, DVI 1.0 compliant EDID1 : 480p, 576p, 720/60p, 720/59.94p, 720/50p 1 080/60i, 1 080/59.94i, 1 080/50i, 1 080/24sF, 1 080/23.98sF 1 080/30p, 1 080/29.97p, 1 080/25p, 1 080/24p, 1 080/23.98p, 1 080/50p, 1 080/59.94p, 1 080/60p EDID2 : Displayable resolution VGA - UXGA (non-interlace) Dot clock frequency 25 - 162 MHz
		RJ-45 input x 1 <sup>*1</sup>	10BASE-T/100BASE-TX

\*1: The LAN terminal of the input module (optional) cannot be used with the PT-D10000U/PT-DW10000U. Use the LAN terminal that is provided as standard with the projector.

\*2: HDCP (High-bandwidth Digital Content Protection)

HDCP is a specification for encoding digital image signals which was developed to protect digital content. The DVI-D/HDMI output signals from the HDCP-compliant equipment have been encoded by the HDCP specifications to ensure content protection, but the DVI-D input module is capable of displaying the digital images properly since it complies with the HDCP specification.

## Installation of input module (optional) (continued)

### ■ Procedure of installation

Disconnect the power before installing the input module.

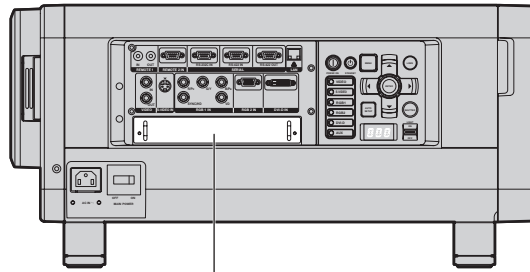

Slot Cover

#### 1. Remove the slot cover.

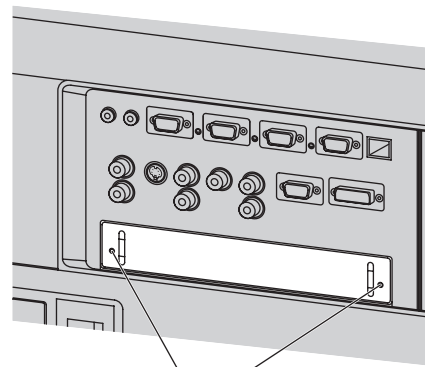

Remove 2 screws.

#### 2. Insert the input module.

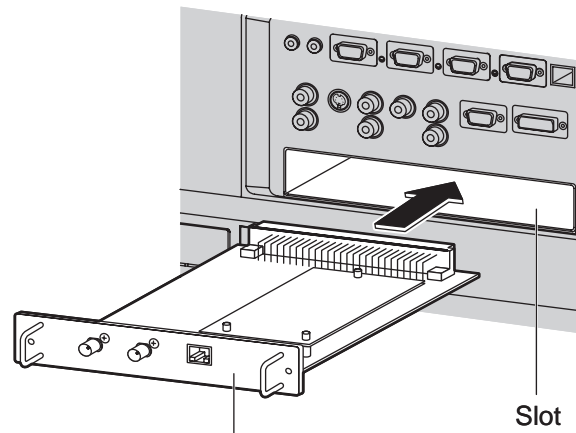

Input module

Slot

#### 3. Fix the input module.

#### 4. Register the input signal.

- This projector needs to register the type of input signal after the installation of the input module.
- For details on the registration of the input signals, refer to pages 40-42.

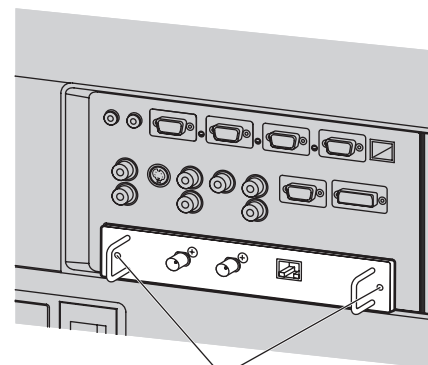

Tighten the two screws.

## Connecting signals to the input module

When installing the projector, it is necessary to connect signals to the input module in accordance with the connecting equipment.

Refer to the following diagram to establish proper signal connection.

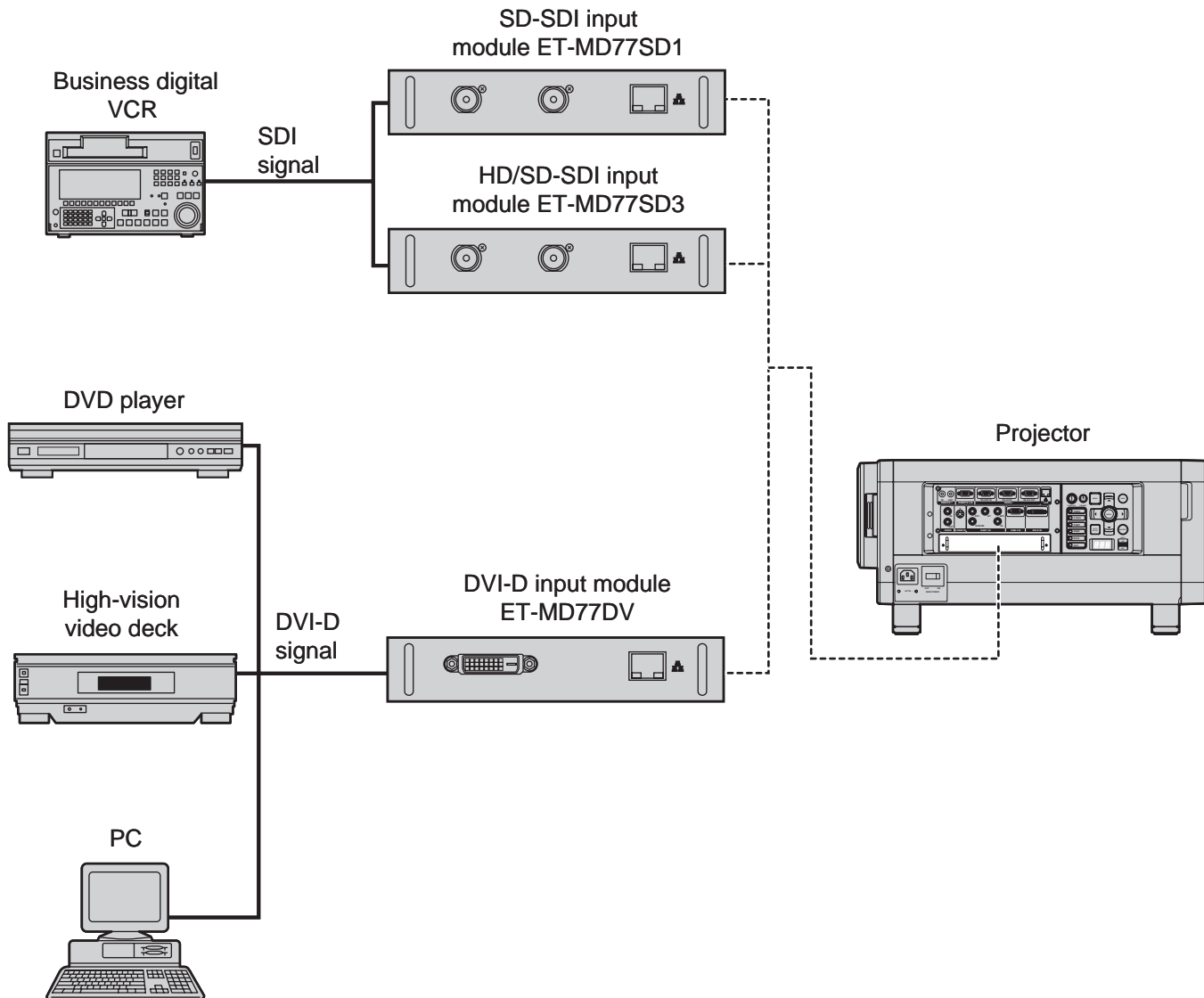

## Installation of input module (optional) (continued)

### Connecting the signal to the SD-SDI input module

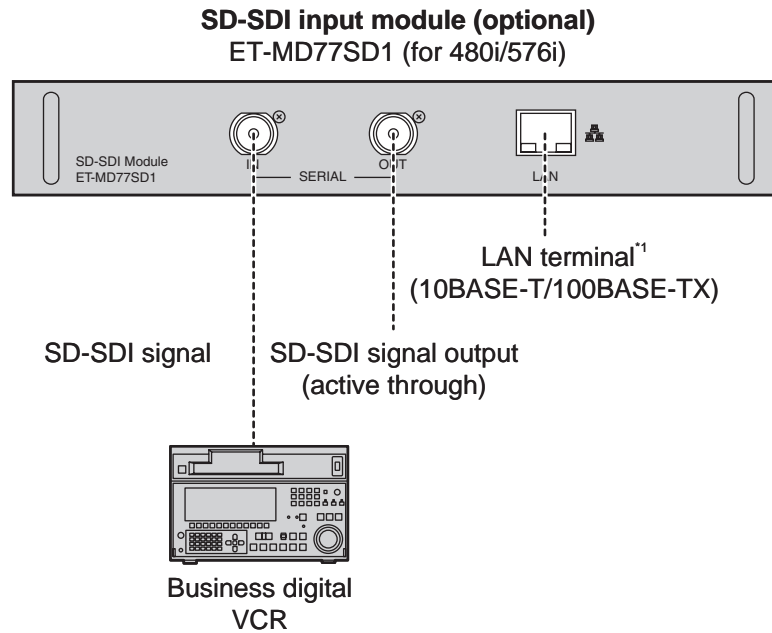

#### Note

- Insert the input module suitable for the input signal specifications.
- Normally, use SYSTEM SELECTOR in "AUTO".
- If a source with an unstable signal is connected, errors in automatic signal recognition may occur. If this happens, use the SYSTEM SELECTOR menu to switch the format to the one which matches the signals being input.
- If using an input module which supports two different signal specifications, use the SYSTEM SELECTOR menu to toggle between the two different types of signal. When this is done, the input signal details will appear on the screen momentarily and then disappear automatically.

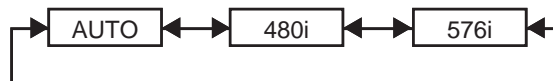

\*1: The LAN terminal of the input module (optional) cannot be used with the PT-D10000U/PT-DW10000U. Use the LAN terminal that is provided as standard with the projector.

## Connecting the signal to the HD/SD-SDI input module

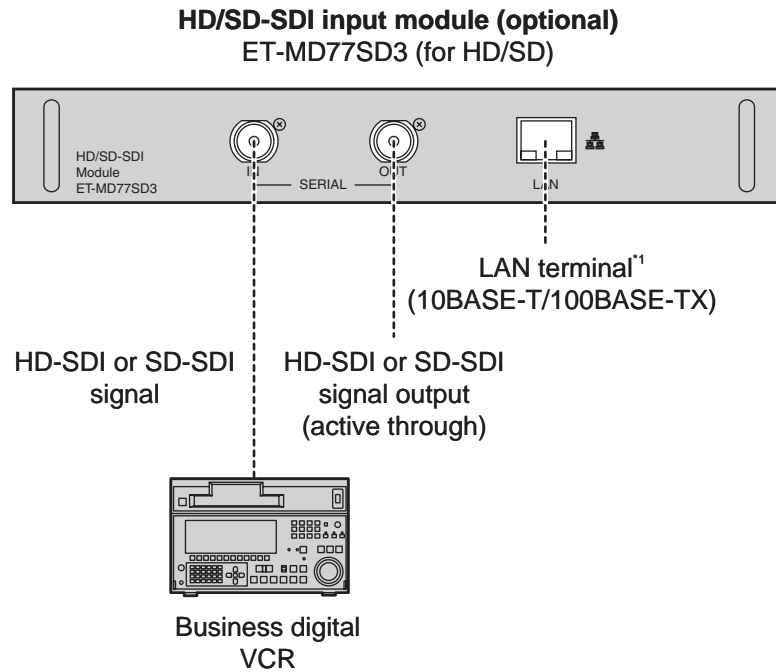

### Note

- Insert the input module that meets the input signal specifications.
- Normally, use SYSTEM SELECTOR in "AUTO".
- If using an input module which supports nine different HD signal specifications (15 formats) (SMPTE292M) or two different SD signal specifications (SMPTE259M), use the SYSTEM SELECTOR menu to toggle between the different input signal formats. When this is done, the input signal details will appear on the screen momentarily and then disappear automatically.

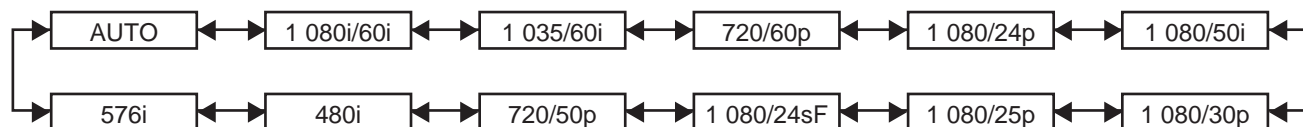

- If a source with an unstable signal is connected, errors in automatic signal recognition may occur. If this happens, use the SYSTEM SELECTOR menu to switch the format to the one which matches the signals being input.
- Use a 5CFB or superior cable for connection to transmit the image information without error. (Example: 5CFB, 5CFTX, 7CFB etc.)

\*1: The LAN terminal of the input module (optional) cannot be used with the PT-D10000U/PT-DW10000U. Use the LAN terminal that is provided as standard with the projector.



## Installation of input module (optional) (continued)

### Connecting signals to the DVI-D input module

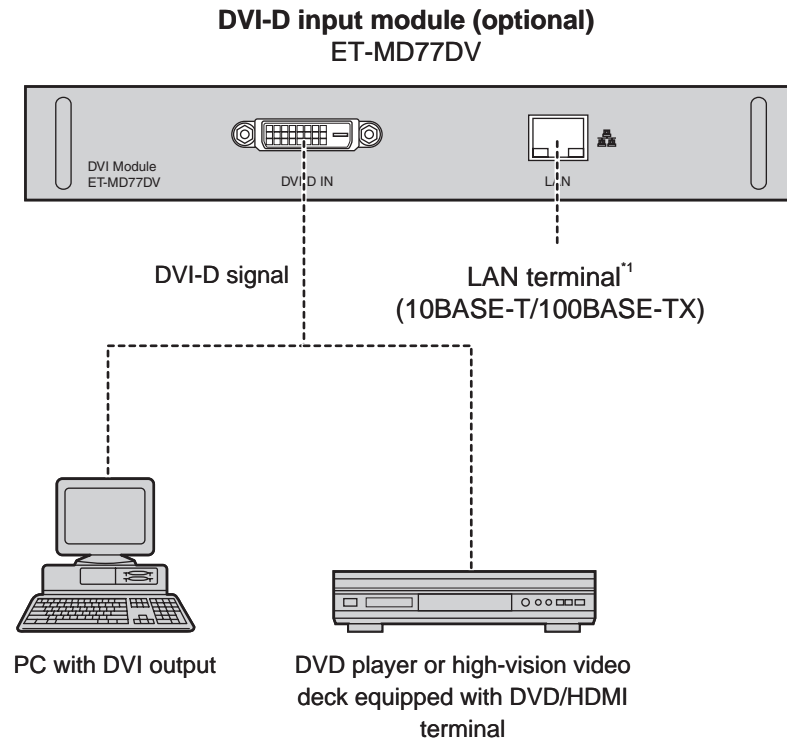

- Pin assignments and signal names of DVI-D input terminal are listed in the table at right.

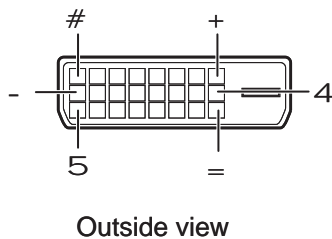

Pin No.	Signal	Pin No.	Signal
#	T.M.D.S data 2-	1	
\$	T.M.D.S data 2+	2	+5V
%	T.M.D.S data 2/ 4 shield	3	Ground
		4	Hot plug detection
&		5	T.M.D.S data 0-
(		6	T.M.D.S data 0+
)	DDC clock	7	T.M.D.S data 0/ 5 shield
*	DDC data		
+		8	
-	T.M.D.S data 1-	9	
.	T.M.D.S data 1+	:	T.M.D.S clock shield
/	T.M.D.S data 1/ 3 shield	;	T.M.D.S clock+
○		=	T.M.D.S clock-

#### Note

- The DVI-D signal input module supports only a single link.
- The HDMI-DVI-D conversion cable is required to connect an HDMI-compliant device.
- The EDID mode setting must be selected so that it corresponds to the device to be connected. (p. 72)
- It is possible to connect the DVI-D input module with an HDMI- or DVI-D-compliant device, but with some devices the images may not appear or other problems may be encountered in operation.

\*1: The LAN terminal of the input module (optional) cannot be used with the PT-D10000U/PT-DW10000U. Use the LAN terminal that is provided as standard with the projector.

# How to install and remove the projection lens (optional)

Adjust the lens shift position so that it is at the home position (p. 38) before installing or removing the projection lens.

## Note

- Remove the dustproof sponge from the lens fitting of the projector before installing the projection lens. (Keep the dust-proof sponge in a safe place for later use if needed.)
- After removing the projection lens, install the dust-proof sponge to the lens fitting of the projector in order to stop dust from getting inside the projector.

## How to install the projection lens

1. While pressing the projection lens cover lock button, pull the cover forward to remove it.

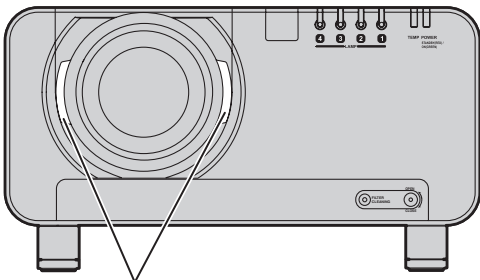

Projection lens cover lock button

2. Align the mark (orange) on the projection lens with the mark on the projector (→), and then insert the lens and turn it clockwise until it clicks into place.

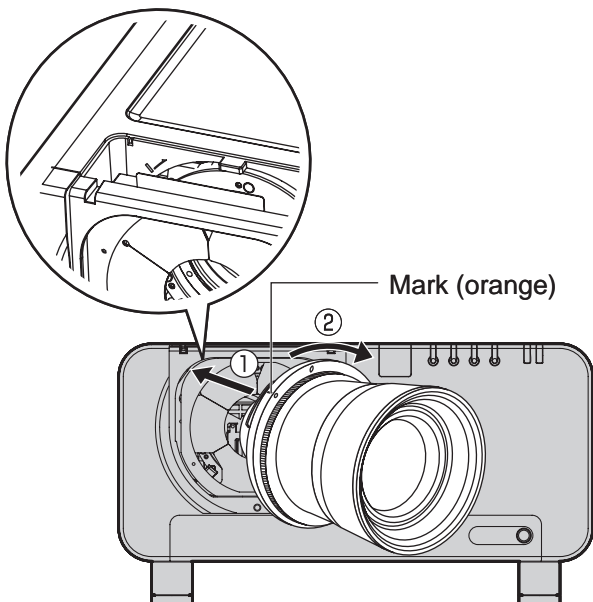

3. Push the projection lens cover in until it clicks into place.

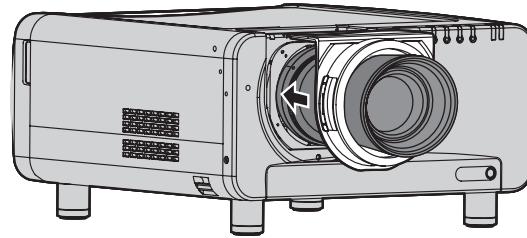

## How to remove the projection lens

1. While pressing the projection lens cover lock button, pull the cover forward to remove it.

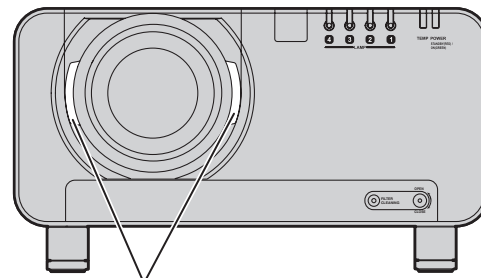

Projection lens cover lock button

2. While holding down the projection lens lock button, turn the projection lens counter clockwise, and then pull it off.

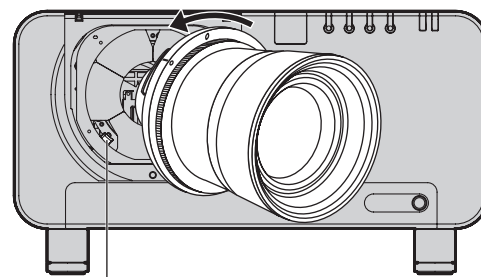

Projection lens lock button

# Projection

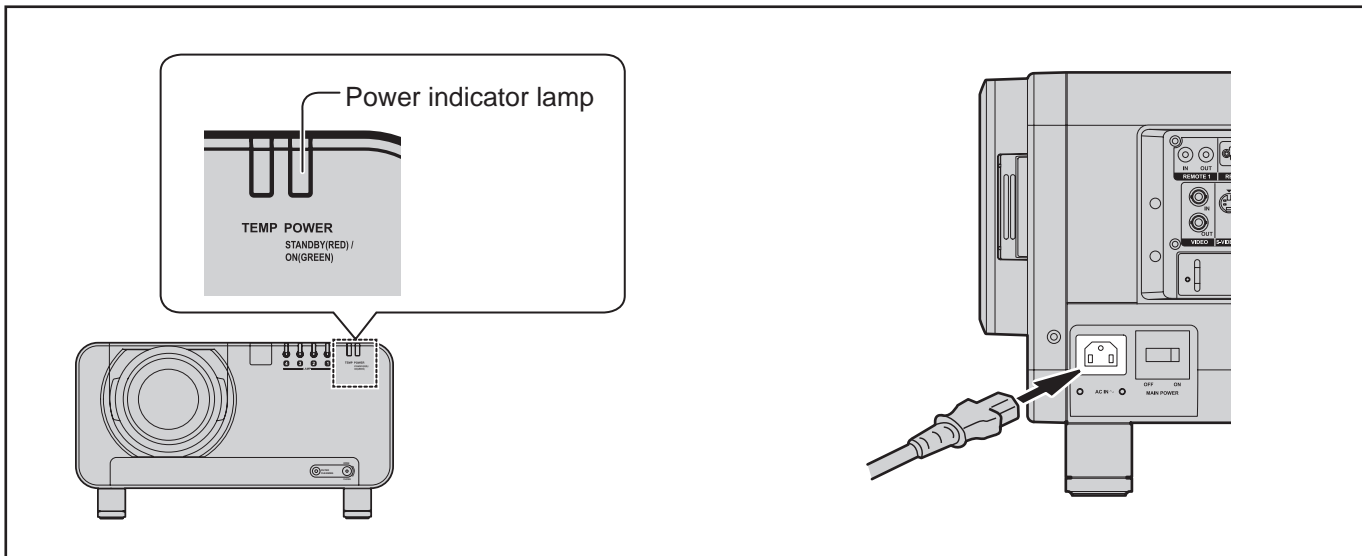

## Power indicator lamp

This shows the power supply status. Make sure that you fully understand the operation of the power indicator lamp before operating the projector.

Indicator status		Projector status
Off		Main power is off
Red	Lit	Standby mode POWER ON ( ) button can be pressed so that images can be projected.
Green	Lit	Images are being projected (on)
Orange	Lit	Standby preparation mode After a short while, the projector will switch to standby mode.

### Attention

- While the projector is in standby preparation mode (when the power indicator lamp is lit orange), the internal fan is running to cool down the projector. Do not turn off the MAIN POWER switch or disconnect the power cord at this time.

### Note

- If the POWER ON “|” button is pressed while the projector is still in standby preparation mode, it may take some time before the projector is ready to project pictures.
- The cooling fan will still be operating and the projector will still be drawing approximately 25 W of power while the projector is in standby mode (when the power indicator lamp is lit red).

## Connecting the power cord

Insert the accessory power cord securely into the projector and the electrical outlet.

Be sure to read the “IMPORTANT SAFETY NOTICE” (pp. 4-5) and “Precautions with regard to safety” (pp. 6-9) for details on handling the power cord.

### Installation

1. Check the shape of the AC IN terminal on the side of the projector and the shape of the power cord connector, and insert the power cord securely into the AC IN terminal.
2. Insert the power cord plug into an electrical outlet.

### Removal

1. Check that the MAIN POWER switch on the projector is at the OFF position, and then disconnect the power cord plug from the electrical outlet.
2. Disconnect the power cord connector from the AC IN terminal of the projector.

### Attention

- Connect all peripheral equipment to the projector before connecting the projector's power cord. (pp. 25-26)

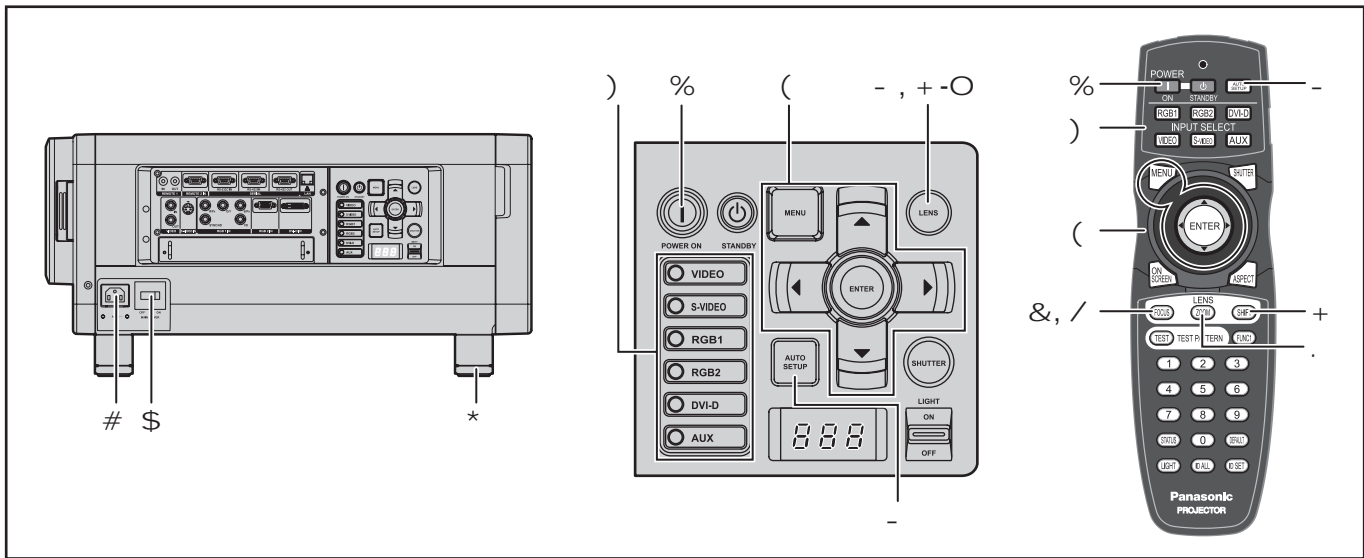

## Powering up the projector

- # **Connect the supplied power cable. (120 V AC, 50 Hz/60 Hz)**
- \$ **Press the “|” marked side of the MAIN POWER switch to turn on the power.**
  - The power indicator lamp on the projector will flash in red. After a short period, the indicator will illuminate and the projector will enter standby mode.
- % **Press POWER ON “|”.**
  - The power indicator lamp illuminates in green and soon the image is projected on the screen.

### Note

- If the projector is powered up at about 0 °C, a warm-up period of approximately 5 minutes may be necessary to start projection. The temperature monitor (TEMP) lamp lights up during the warm-up period. When the warm-up is completed, the temperature monitor (TEMP) lamp turns off and the image is projected on the screen.
- If the temperature of the operating environment is low and warm-up takes more than 5 minutes, the projector will judge that a problem has occurred and the power will be turned off automatically. If this happens, increase the temperature around the projector so that it is 0 °C or higher, and then turn on the MAIN POWER switch and the POWER ON “|” switch once more.

## Making adjustment and selection

- & **Roughly adjust the focus of the lens. (p. 37)**
- ( **Select and set the projection scheme. (p. 76)**
- ) **Select the input signal by pressing the input selector button to toggle through RGB1, RGB2, DVI-D, VIDEO, S-VIDEO and AUX. (p. 43)**
  - The AUX button is disabled when an optional input module is not connected.
- \* **Adjust the tilt of the main unit in front and rear or right and left. (p. 20)**
- + **Adjust the shift. (p. 37)**
- **Press AUTO SETUP if the input signal is RGB signal. (p. 44)**
- . **Fit the image size to the screen size. (p. 37)**
- / **Adjust the focus. (p. 37)**
- O **Display the zoom adjustment menu again and adjust the zoom to fit the image size to the screen size. (p. 37)**

## Projection (continued)

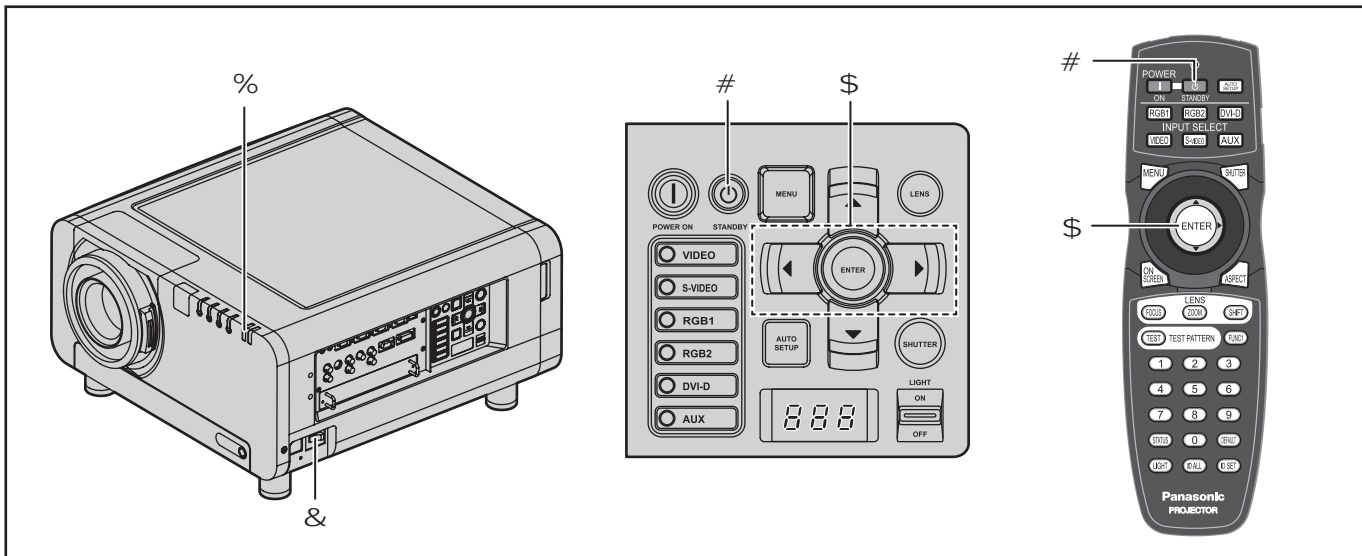

### Powering off the projector

- # Press **POWER STANDBY** “”.
- A confirmation screen will appear.

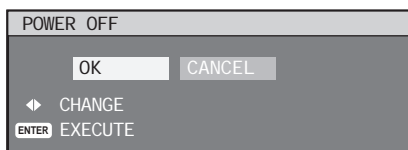

- \$ Press **◀** or **▶** to select “OK” and press **ENTER**.  
(or press **POWER STANDBY** “” again.)

- The projection of the image stops, and the power indicator lamp of the main unit lights up orange. (The cooling fan keeps running.)

- % Wait until the power indicator lamp of the main unit turns to red (i.e., until the cooling fan stops). (Approx. 3 minutes)

- While the cooling fan is still running, never turn off the MAIN POWER switch, nor unplug the projector from the outlet.

- & Press the “” marked side of the **MAIN POWER** switch to remove all power from the projector.

### Note

- Turning on the power supply will not light up the light source lamp if the lamp is in the process of cooling down after turning off the power supply. To light up the lamp, turn on the power supply again when the lamp has been cooled sufficiently.
- The projector consumes approximately 25 W of power even in standby mode. (Power indicator lamp lit in red)
- If you re-power the projector after shutting off the main power inadvertently, the projection lamp may remain unlit. Please turn the power on again after a while.

**Be sure to set the date and time when the projector is turned on for the first time after being purchased. For details, refer to “Setting the date and time” on page 81.**

# How to adjust the lens

## How to adjust the focus, zoom and shift

If the focusing, zooming or positioning of the image projected on the screen is not successful, even though the projector is properly positioned against the screen, you can adjust the focus, the zoom, or the vertical or horizontal position of the image.

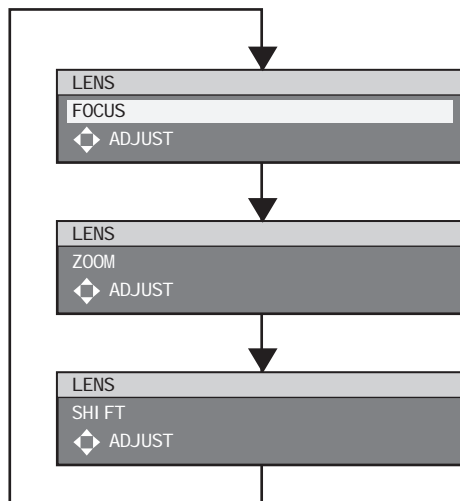

### ■ At the projector

#### 1. Press **LENS** on the control panel on the main unit.

- Pressing the button changes the setup screen in the order of "FOCUS", "ZOOM" and "SHIFT".

#### 2. Press **▲ ▼ ◀ ▶** to select an item and adjust it.

### ■ Using the remote control

#### 1. Press **LENS** on the remote control.

- When the **FOCUS** button is pressed:  
The focus is adjusted.
- When the **ZOOM** button is pressed:  
The zoom is adjusted.
- When the **SHIFT** button is pressed:  
The shift is adjusted.

#### 2. Press **▲ ▼ ◀ ▶** to select an item and adjust it.

### CAUTION:

Be careful not to catch your fingers between the lens and shroud when shifting the lens.

### Note

- The word "FOCUS" will appear in the displayed adjustment menu with a yellow background so that it can be identified by color from the other items in the adjustment menu (even if the lens is out of focus and the letters are difficult to read).
- The zoom adjustment menu will be displayed only when a lens with zoom function is being used.

## How to adjust the lens (continued)

### Adjustment range after lens position (optical shift)

Do not move the lens beyond the bounds of the shift range as this may cause a change in the focus. This limitation is to protect the parts of the projector.

Using the standard projection position as the reference, the optical axis shift function makes it possible to adjust the projection position in the ranges shown in the figures below.

Model number of projection lens		PT-D10000U	PT-DW10000U
Zoom Lens	ET-D75LE6		
	ET-D75LE1 ET-D75LE2 ET-D75LE3 ET-D75LE4 ET-D75LE8		

#### Note

- The ET-D75LE5 has a fixed focal point, and so shift adjustment cannot be carried out.

### Moving the projection lens position to the home position

- Press and hold **LENS** on the projector's controls or **SHIFT** on the remote control for 3 seconds or more.

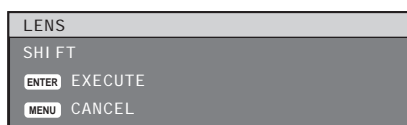

- Press **ENTER** while the menu shown above is being displayed. (It will be displayed for about 5 seconds.)

- "PROGRESS..." will appear in the menu, and the projection lens will move to the home position.

#### Note

- The home position for the projection lens is the lens position when the lens is being replaced or when the projector is being stored away, and it is not the optical center of the screen.

# Automatic adjustment (AUTO SETUP)

## How to adjust the lens for addressing unevenness of focusing

If the image is out of focus in any portion of the screen, adjust the lens by turning the adjustment screws to obtain evenness of focusing.

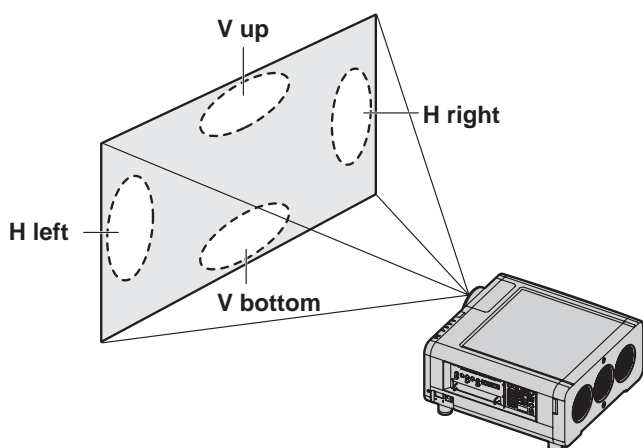
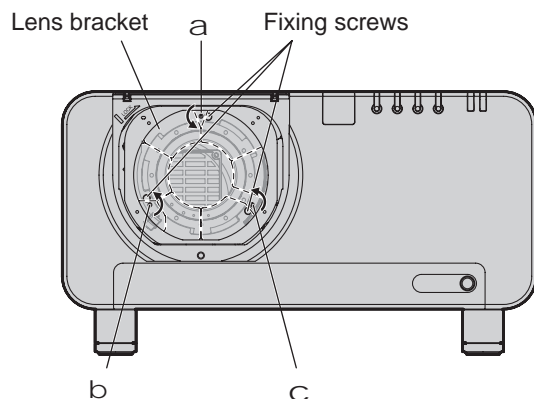

1. Remove the projection lens cover and lens. (p. 33)
2. Loosen the 3 fixing screws that secure the lens bracket about two turns.
  - Tool to be used :  
Allen hex socket driver or Allen wrench (2.5 mm diagonal hexagon)
3. Install the lens removed in step 1.
4. Adjust the lens by turning the adjustment screws a , b and c counterclockwise.
  - Adjust the screws a , b and c after installing the lens.
  - Tool to be used :  
Allen hex socket driver or Allen wrench (2.5 mm diagonal hexagon)

Basic Operation

The instructions within parentheses apply to ceiling mount installation.

	V up is out of focus	V bottom is out of focus	H right is out of focus	H left is out of focus
a	_____ (Turn counterclockwise)	Turn counterclockwise (_____)	_____ (_____)	_____ (_____)
b	Turn counterclockwise (_____)	_____ (Turn counterclockwise)	Turn counterclockwise (_____)	_____ (Turn counterclockwise)
c	Turn counterclockwise (_____)	_____ (Turn counterclockwise)	_____ (Turn counterclockwise)	Turn counterclockwise (_____)

For example: When the image is out of focus in the upper portion of the screen (V up):  
Turn the adjustment screws b and c little by little counterclockwise while checking evenness of focusing in the upper and lower portions.

### Attention

- When moving the projector, return the lens to the home position (p. 38), and then tighten the 3 fixing screws to secure the lens bracket.



# Registration of input signal data

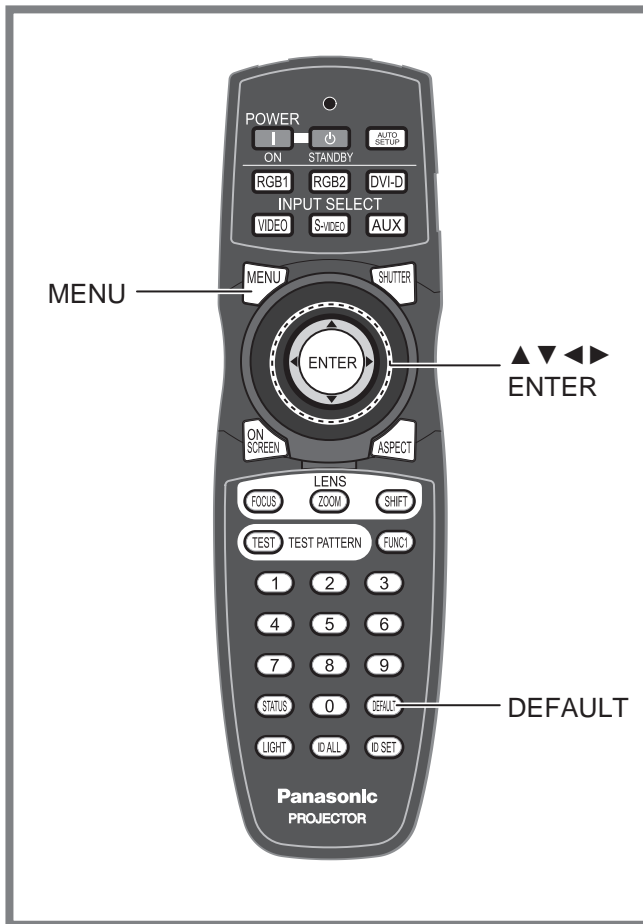

## Registration of new data

When a new signal is supplied, press MENU on the remote control or operating section of the main unit. When its data has been registered, the "MAIN MENU" screen is displayed.

### Note

- The data of 96 input signals can be registered.
- The signals supporting the installed input module are input and their data registered.
- The memories are numbered over 12 pages (A to L: 8 data items can be registered on each page), and the data is registered in the unused memory with the lowest number. If all the memories are used, the data of the old signals is overwritten in sequence.
- The names of the registered data are automatically determined by the input signals and memory numbers.
- If a menu is being displayed, the new signals will be registered at the instant they are input.

## Renaming the registered signals

1. Press ▲▼◀▶ to select the signal whose details are to be displayed.

REGISTERED SIGNAL LIST		
A1: SVGA72-A1	RGB1	---
A2: SVGA72-A2	RGB1	---
A3: SVGA72-A3	RGB1	---
A4: SVGA72-A4	RGB1	---
A5: SVGA72-A5	RGB1	---
A6: SVGA72-A6	RGB1	---
A7: SVGA72-A7	RGB1	---
A8: SVGA72-A8	RGB1	---
SELECT		
ENTER	DETAILS	DEFAULT DELETE

2. Press ENTER.

- The "REGISTERED SIGNAL STATUS" screen will be displayed.

REGISTERED SIGNAL STATUS	
NAME	SVGA72-A2
MEMORY NO	A2
INPUT	RGB1
FH	48.08kHz
FV	72.17Hz
SYNC. STATE	H(POS)
	V(POS)
ENTER	RENAME

- The data items including the input signal name, memory number, input terminal, frequency and sync signal are automatically identified and displayed.
- When MENU is pressed, the "REGISTERED SIGNAL LIST" screen is restored.

The input signal data must be registered because it is not registered on shipment of the projector.

**MENU** — Press to display the **MAIN MENU** screen.

**ENTER** — Press to select **"SIGNAL LIST"**.

**ENTER** — Press to display the **"REGISTERED SIGNAL LIST"** menu.

- The memories extend over 12 pages (A to L with 8 data items each, giving a total of 96 memories).

MAIN MENU	
PICTURE	
POSITION	
ADVANCED MENU	
DISPLAY LANGUAGE	
OPTION1	
OPTION2	
TEST PATTERN	
SIGNAL LIST	
NETWORK	
SECURITY	
MENU SELECT	
ENTER	SUB MENU

**3. Press ENTER.**

- The “RENAME” screen will be displayed.

**4. Use ▲▼◀▶ to select the characters and numerals one by one, and press ENTER to set them.**

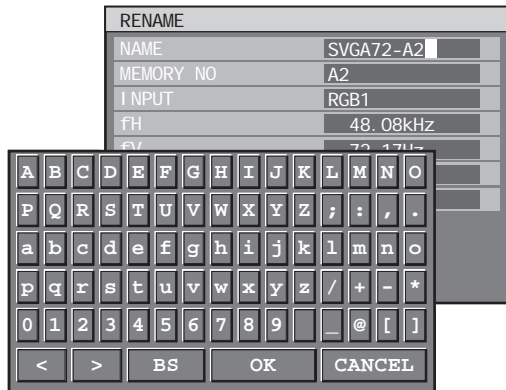

**5. Once the name has been changed, press ▲▼◀▶ to select “OK” and then press ENTER.**

- After registration, the “REGISTERED SIGNAL STATUS” screen is restored.
- If you would like to cancel the changes to the signal name, use ▲▼◀▶ to select “CANCEL” and then press ENTER. The changes will be cancelled and the displayed signal name will remain as it is.

## Clearing the data of registered signals

**1. Press ▲▼◀▶ to select the signal whose data is to be cleared.**

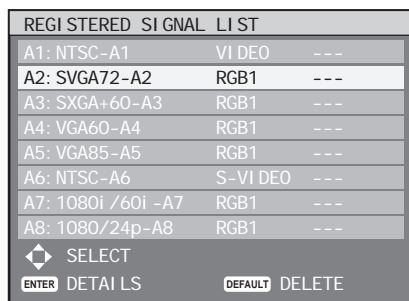

**2. Press DEFAULT.**

- The “ENTRY SIGNAL CLEAR” screen will be displayed.
- If the data is not to be cleared, press MENU to return to the “SIGNAL LIST” screen.

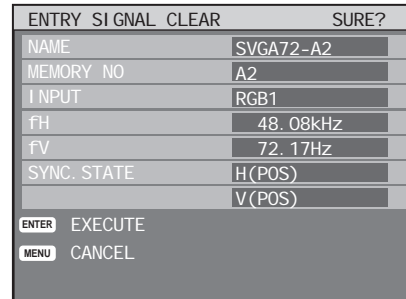

**3. Press ENTER.**

- The data of the signal selected is cleared.

## Sub memory

The projector is provided with a sub memory function to register plural pieces of image adjustment data even they are determined to be the same signal by the frequency and form of the synchronization signal source.

Use this function when the user needs adjustment of picture quality such as aspect switching and white balance using the same signal source.

Sub-memory contains all data that can be adjusted by signals such as screen aspect ratio and image adjustment data (BRIGHT, CONTRAST etc.).

### How to register into sub memory

A new signal cannot be registered into sub memory. A new signal must undergo signal registration.

**1. Press ◀▶ on normal screen (menu is not displayed).**

- A “Check sub-memory registration” screen will appear if sub-memory has not been registered.
- The screen will show a list of the sub-memory registered for the currently entered signal.
- If “SUB MEMORY” is selected from the “FUNC1” menu in the “OPTION 2” menu, you can use the FUNC1 button instead of the ◀▶ buttons. (p. 73)

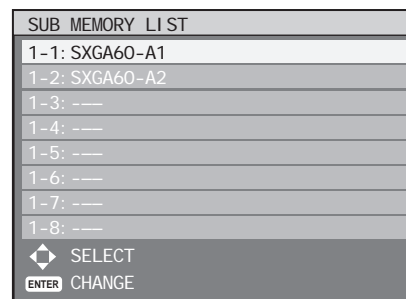

## Registration of input signal data (continued)

2. Press ▲▼◀▶ to select the SUB MEMORY number stored in the “SUB MEMORY LIST”.

3. Press ENTER.

- A “Change registered signals” screen will appear.

REGISTER SUB MEMORY?	
NAME	SXGA60-A1
MEMORY NO	--
INPUT	RGB1
fH	64.00kHz
fV	60.00Hz
SYNC. STATE	H(POS)
	V(POS)
ENTER REGISTER	

4. Press ENTER.

### Note

- To rename a registered signal, perform steps 4 and 5 on page 41.

### Procedure to switch to sub memory

1. Press ◀▶ on normal screen (menu is not displayed).

- The screen will show a list of the sub-memory registered for the currently entered signal.

2. Press ▲▼◀▶ to select the sub-memory signal to be switched in the “SUB MEMORY LIST”.

3. Press ENTER.

- Signal will be switched to the one that was selected in Step 2.

### How to erase sub memory

The currently selected SUB MEMORY is deleted by pressing DEFAULT at the “REGISTERED SIGNAL LIST”.

### On-screen indications

- # Input switching / signal switching  
This shows the registered signal name on the status screen for signal switching.

INPUT	RGB1
NAME	RGB
MEMORY NO	A1(1-2)

\$ Details of registered signal

REGISTERED SIGNAL STATUS	
NAME	SXGA60-A1
MEMORY NO	A1(1-2)
INPUT	RGB1
fH	63.98kHz
fV	60.02Hz
SYNC. STATE	H(POS)
	V(POS)
ENTER RENAME	

- The designation can be set by the sub memory items.
- MEMORY NO : A1 (1-2)

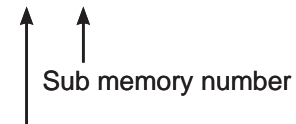

The place in which address code (A1, A2, ..., H7 and H8) signals are registered

### Note

#### Restrictions

- The maximum sub memory items that can be registered for the projector are 96 including the basic signal.

# Basic operations using the remote control

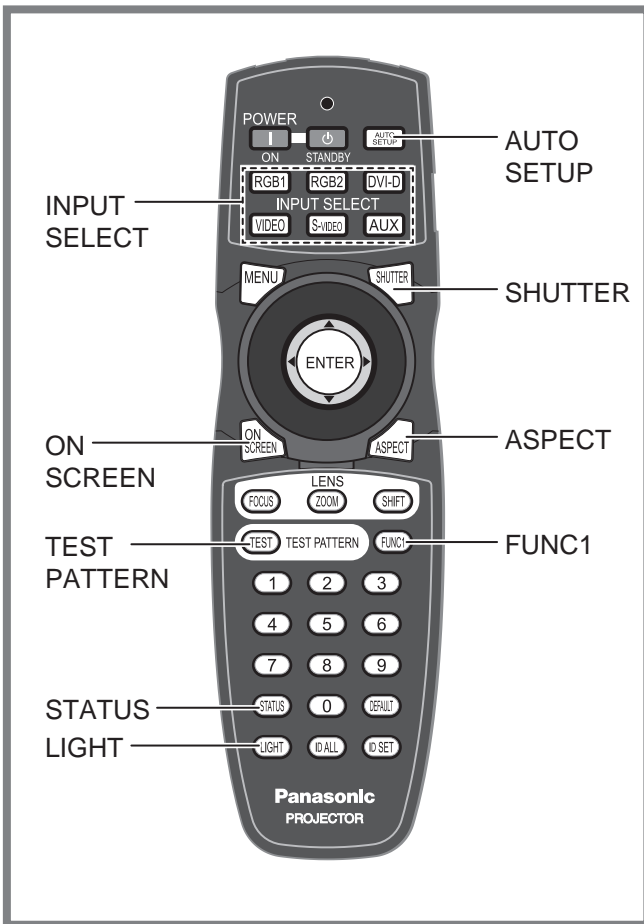

## Switching the input signal

You can use the remote control to switch the signals that are being input and projected.

### 1. Press INPUT SELECT on the remote control or the main unit.

- **Press RGB1:**  
Switches to RGB1 input.
- **Press RGB2:**  
Switches to RGB2 input.
- **Press DVI-D:**  
Switches to DVI-D input.
- **Press VIDEO:**  
Switches to video input.
- **Press S-VIDEO:**  
Switches to S-VIDEO input.
- **Press AUX:**  
Switches to optional input module input. (The AUX button to switch the input is disabled when an optional input module is not connected.)

#### Note

- Refer to “Connection” for details on the input terminals. (pp. 25, 26)

## Using the SHUTTER function

If the projector is not used for a certain period of time during the meeting intermission, for example, a shutter mode is available that allows the user to hide images temporarily.

### 1. Press SHUTTER on the remote control or the main unit.

- The image is turned off.

### 2. Press SHUTTER again.

- The image comes back.

## On-screen display function

This turns the on-screen display function on and off.

### 1. Press ON SCREEN on the remote control.

## Status function

This shows the projector status. It can also be used to send information about the projector's status via e-mail.

### 1. Press STATUS on the remote control.

STATUS	
INPUT :	RGB1
	: 0.00kHz/ 0.00Hz
PROJECTOR RUNTIME :	13h
LAMP1 :	9h/OFF/
LAMP2 :	10h/OFF/
LAMP3 :	9h/OFF/
LAMP4 :	9h/ON/
TEMP :	IN- 27 / OUT- 32 /OPT- 36
VERSION MAIN :	0.55
VERSION NETWORK :	0.09
REMOTE2 :	DI SABLE
ENTER END STATUS VIA E-MAIL	

#### Note

- Refer to “How to use network function” for details. (pp. 84-97)

## Remote control operation (continued)

### Automatic adjustment (AUTO SETUP)

The automatic setup function can be used to automatically adjust the resolution, clock phase and picture position when analog RGB signals consisting of bitmap images such as computer signals are being input, or to automatically adjust the picture position when DVI-D signals are being input. (Automatic adjustment cannot be carried out when moving pictures are being input.)

It is recommended to supply images with a bright white frame at the outermost periphery containing characters etc. that are clear in white and black contrast when the system is in automatic adjustment mode. Avoid supplying images that involve halftones or gradation such as photographs and computer graphics.

#### 1. Press **AUTO SETUP** on the remote control or the main unit.

- A message "COMPLETE" appears if adjustment is ended normally.

#### Note

- "CLOCK PHASE" may have been shifted even when the adjustment ended normally. In this case, manually adjust the "CLOCK PHASE".
- If an image with blurred edges or a dark image is supplied, a message "INCOMPLETE" appears, indicating the automatic adjustment was unsuccessful. In this case, manually adjust the items of "INPUT RESOLUTION", "CLOCK PHASE" and "SHIFT".
- For specific signals and long-sideways (or landscape) signals such as 16:9, adjustment should be made according to "AUTO SETUP" in the option menu.
- Automatic adjustment may not be available depending on the machine type of the personal computer.
- Automatic adjustment may not be available for synchronization signal of C-SYNC and G-SYNC.
- Image may be distorted for several seconds during automatic adjustment. This is not a malfunction.
- For every supplied signal, adjustment is required.
- Automatic adjustment can be cancelled by pressing the MENU button during the course of automatic adjustment.

### Turning on button illumination

Button illumination for the remote control can be turned on.

#### 1. Press **LIGHT** on the remote control.

#### Note

- If no operations are carried out for approximately 10 seconds, button illumination will turn off automatically.

### Using the FUNC1 button

"P IN P" (pp. 72-73), "SUB MEMORY" (p. 41) or "SYSTEM SELECTOR" (p. 54) operations can be assigned to the FUNC1 button on the remote control so that it can be used as an easy shortcut button.

#### Note

- Refer to "Setting FUNC1" for details. (p. 73)

### Displaying the internal test pattern

The projector has eight types of internal test patterns to check the condition of the set.

To display test patterns, follow the steps below.

1. Press **TEST PATTERN**.
2. Press **◀▶** to select "TEST PATTERN".

#### Note

- Setting is also possible by using an on-screen menu. Refer to "Displaying the internal test pattern" for details. (p. 83)
- Results of adjustment on the image, picture quality, position, size and other factors will not be reflected in test patterns. Be sure to display the input signal before performing various kinds of setting.

## Changing the picture aspect ratio

You can change the aspect ratio for projected pictures to match the input signal.

### 1. Press ASPECT on the remote control.

- The setting will change as follows each time ASPECT is pressed.

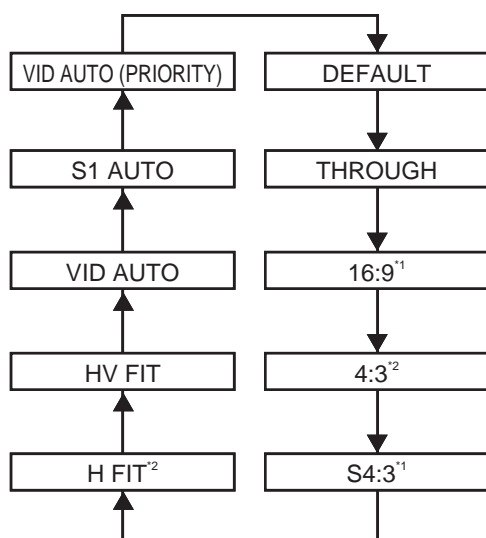

\*1: PT-D10000U Only

\*2: PT-DW10000U Only

#### Note

- Some aspect ratios may not be available for selection depending on the input signal. Refer to "Adjusting the aspect ratio" for details. (p. 57)

# On-screen menus

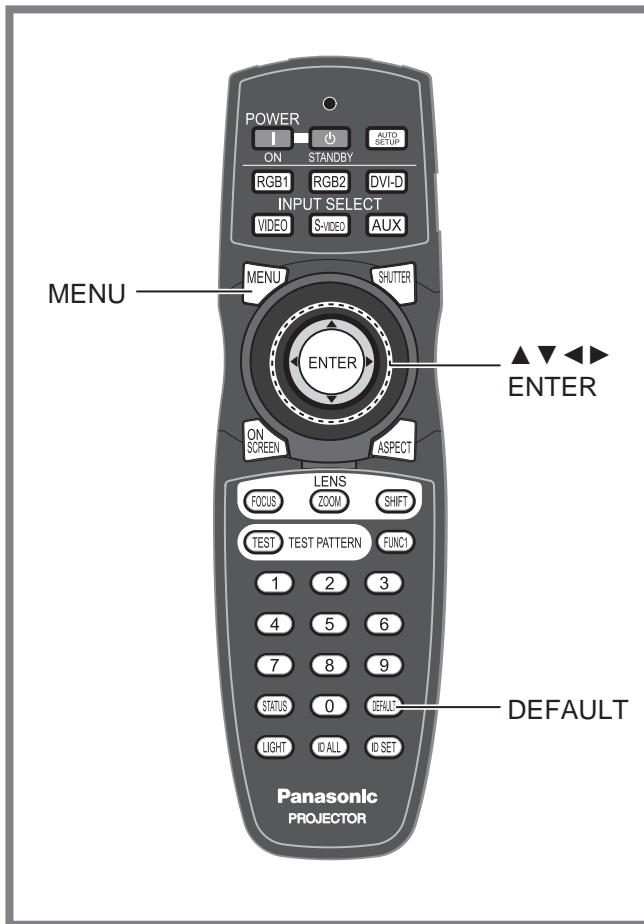

## MAIN MENU

The main menu consists of the following 10 menu items. When a main menu item is selected, the screen changes to a sub-menu selection screen.

Icon	MAIN MENU item
	PICTURE
	POSITION
	ADVANCED MENU
	LANGUAGE
	OPTION 1
	OPTION 2
	TEST PATTERN
	SIGNAL LIST
	NETWORK
	SECURITY

## SUB MENU

The sub-menu screen for the selected main menu item appears, and you can then set and adjust the various items in the sub-menu.

### PICTURE (pp. 49-55)

SUB MENU item
PICTURE MODE
CONTRAST
BRIGHT
COLOR
TINT
COLOR TEMP.
GAMMA
SHARPNESS
NOISE REDUCTION
DYNAMIC IRIS
SYSTEM SELECTOR

#### Note

- The factory default values may vary depending on the PICTURE menu.

Menus are extensively used for configuring, adjusting or reconfiguring the projector.

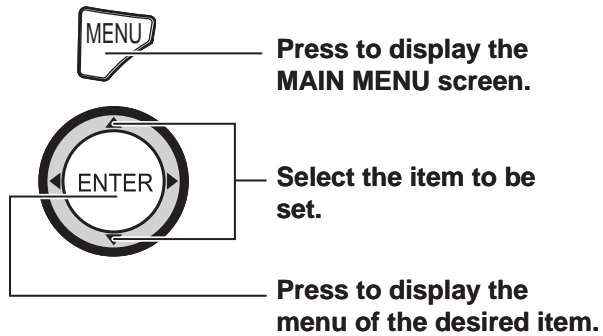

MAIN MENU	
PICTURE	
POSITION	
ADVANCED MENU	
DISPLAY LANGUAGE	
OPTION1	
OPTION2	
TEST PATTERN	
SIGNAL LIST	
NETWORK	
SECURITY	
◆ MENU SELECT	
ENTER	SUB MENU

- Some menu items may not be valid for certain signal formats applied to the projector. The menu items that cannot be adjusted or used are shown in gray characters, and they cannot be selected.

## ■ POSITION (pp. 56-59)

SUB MENU item
SHIFT
ASPECT
ZOOM
CLOCK PHASE
KEystone

## ■ ADVANCED MENU (pp. 60-65)

SUB MENU item
DIGITAL CINEMA REALITY
BLANKING
INPUT RESOLUTION
CLAMP POSITION
EDGE BLENDING
FRAME DELAY
RASTER POSITION

## ■ DISPLAY LANGUAGE (p. 66)

SUB MENU item
ENGLISH
DEUTSCH
FRANÇAIS
ESPAÑOL
ITALIANO
日本語
中文
русский
한국어

## ■ OPTION1 (pp. 67-74)

SUB MENU item
COLOR MATCHING
LARGE SCREEN CORRECTION
AUTO SIGNAL
AUTO SETUP
BACK COLOR
DVI EDID
AUX DVI EDID
P IN P
FUNC1
OSD POSITION
OSD MEMORY

## ■ OPTION2 (pp. 75-82)

SUB MENU item
PROJECTOR ID
INSTALLATION
ALTITUDE
DIRECTION
OUTPUT RESOLUTION (PT-D10000U only)
LAMP SELECT
LAMP RELAY
RS-232C
SYSTEM INFORMATION
AIR FILTER CLEANING
ADJUST DATE
STARTUP LOGO
PASSWORD

## ■ TEST PATTERN (p. 83)

## ■ SIGNAL LIST (pp. 40-42)

## ■ NETWORK (pp. 84-85)

SUB MENU item
HOST NAME
DHCP
IP ADDRESS
PORT
SUBNET MASK
GATEWAY
STATUS
STORE

## ■ SECURITY (pp. 99-101)

SUB MENU item
PASSWORD
PASSWORD CHANGE
TEXT DISPLAY
TEXT CHANGE



## On-screen menus (continued)

### Using the menu screens

#### 1. Press MENU.

- The "MAIN MENU" appears on the screen.

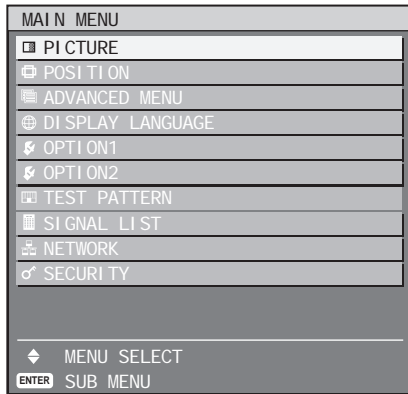

#### 2. Press ▲▼ to select the desired item.

- The item that is currently selected will appear in yellow.



#### 3. Press ENTER to establish your selection.

- The submenu for the selected option will now open.

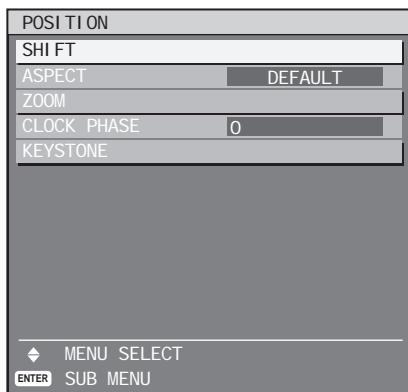

#### 4. Press ▲▼ button to highlight the desired adjustment item, then press ◀▶ to change or adjust the parameter value.

- For some items, an individual adjustment screen containing a bar scale will appear as shown in the diagram below when ◀▶ is pressed.

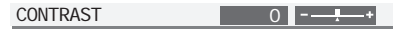

- If no button is operated for approx. 5 seconds while the individual adjustment screen is displayed, the screen will return to the previous page.

#### Returning to the previous screen

- When the "MENU" is on the screen, pressing the MENU button returns to the previous page.
- When the "MAIN MENU" is on the screen, pressing MENU clears all menus from the screen.

#### Menu items setting

- The bottom prompt line differs on each menu depending on the selected menu option:
- A prompt "◀▶ CHANGE" appears when changing the setting.
- A prompt "◀▶ ADJUST" appears for a separate bar graph.
- If there are more adjustments (items) available for a menu item, a page number will appear at the top-right of the screen.

### Resetting to the factory default

If an adjustment item is selected and DEFAULT is pressed, the adjustment value will return to the factory default setting.

#### 1. Press DEFAULT.

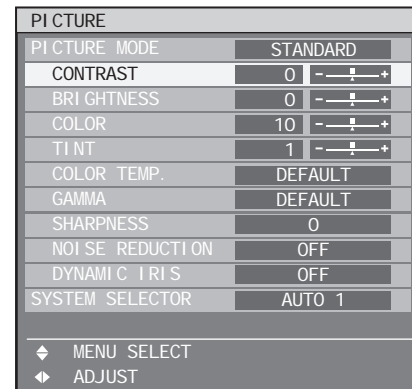

# Adjusting the picture

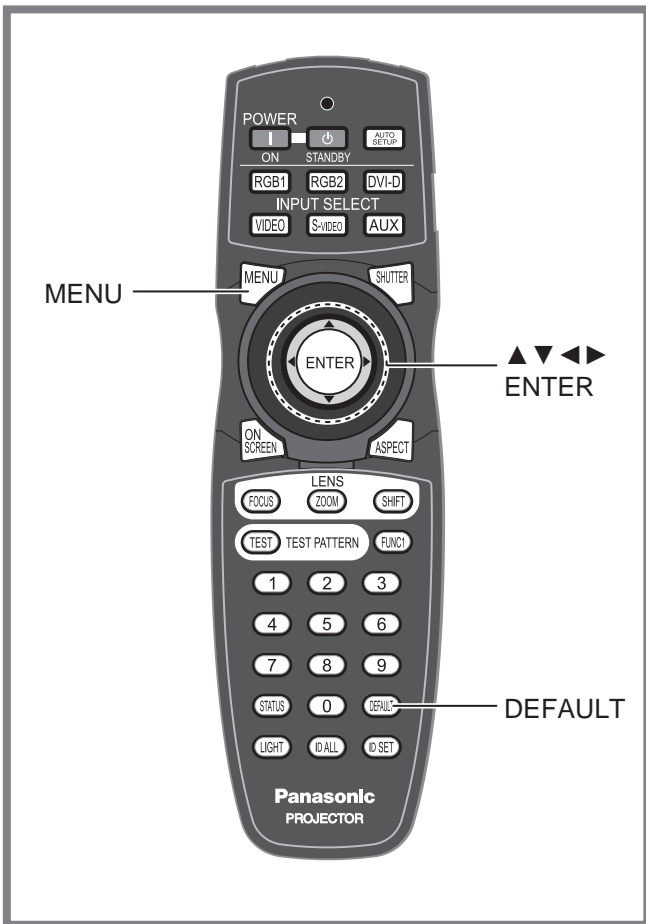

## Switching the picture mode

The user can switch to the desired picture mode suitable for the image source and the environment in which this projector is used.

### 1. Press ▲ ▼ to select “PICTURE MODE”.

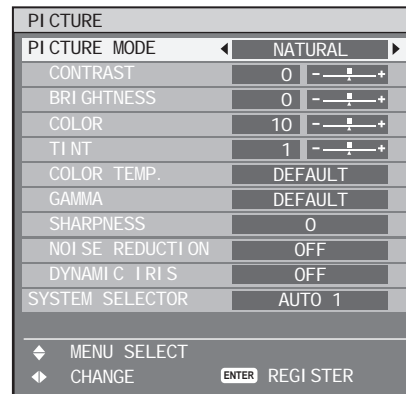

### 2. Press ◀ ▶ to switch “PICTURE MODE”.

- The setting will change as follows each time ◀ ▶ is pressed.

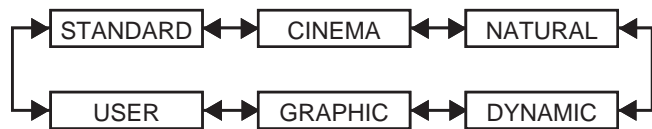

- STANDARD:**  
The picture becomes suitable for moving images in general.
- CINEMA:**  
The picture becomes suitable for movie sources.
- NATURAL:**  
The picture complies with sRGB.
- DYNAMIC:**  
The picture becomes suitable for the use in well-lighted areas.
- GRAPHIC:**  
The picture becomes suitable for input from the personal computer.
- USER:**  
The COLOR TEMP. and GAMMA settings can be adjusted.

#### Note

- Factory defaults are “GRAPHIC” for RGB system and “STANDARD” for moving images.
- When ENTER is pressed while “PICTURE MODE” has been selected, the picture mode which has been selected can be saved and used as the presetting when new signals are input. The data will be saved for all items in the PICTURE menu except for the SYSTEM SELECTOR setting.

You can adjust pictures to suit your preference.



Press to display the **MAIN MENU** screen.

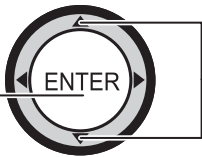

Press to select **“PICTURE”**.

Press to display the **“PICTURE”** menu.

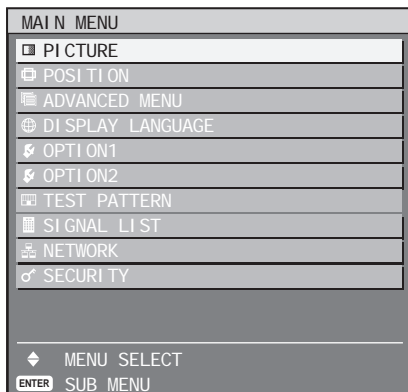

- Some menu items may not be valid for certain signal formats applied to the projector.

## Adjusting the picture (continued)

### Adjusting Contrast

This adjusts the contrast for picture colors.

#### 1. Press ▲▼ to select “CONTRAST”.

PICTURE		
PICTURE MODE	NATURAL	
CONTRAST	0	←— —→+
BRIGHTNESS	0	←— —→+
COLOR	10	←— —→+
TINT	1	←— —→+
COLOR TEMP.	DEFAULT	
GAMMA	DEFAULT	
SHARPNESS	0	
NOISE REDUCTION	OFF	
DYNAMIC IRIS	OFF	
SYSTEM SELECTOR	AUTO 1	
◆ MENU SELECT		
◆ ADJUST		

#### 2. Press ENTER.

- The “CONTRAST” individual adjustment screen will be displayed.

CONTRAST	0	←— —→+
----------	---	--------

#### 3. Press ◀▶ to adjust the level.

Operation	Adjustment	Adjustment range
Press ▶ button.	Raises the picture brightness and the picture becomes clearer.	Maximum value 31
Press ◀ button.	Lowers the picture brightness and weakens the picture.	Minimum value -31

#### Attention

- If you need to adjust the “BRIGHTNESS,” it should be adjusted before other adjustments are made.

### Adjusting Brightness

This adjusts the brightness of dark (black) areas of the pictures.

#### 1. Press ▲▼ to select “BRIGHTNESS”.

PICTURE		
PICTURE MODE	NATURAL	
CONTRAST	0	←— —→+
BRIGHTNESS	0	←— —→+
COLOR	10	←— —→+
TINT	1	←— —→+
COLOR TEMP.	DEFAULT	
GAMMA	DEFAULT	
SHARPNESS	0	
NOISE REDUCTION	OFF	
DYNAMIC IRIS	OFF	
SYSTEM SELECTOR	AUTO 1	
◆ MENU SELECT		
◆ ADJUST		

#### 2. Press ENTER.

- The “BRIGHTNESS” individual adjustment screen will be displayed.

BRIGHTNESS	0	←— —→+
------------	---	--------

#### 3. Press ◀▶ to adjust the level.

Operation	Adjustment	Adjustment range
Press ▶ button.	Increases the brightness of the dark (black) parts of the screen.	Maximum value 31
Press ◀ button.	Reduces the brightness of the dark (black) parts of the screen.	Minimum value -31

### Adjusting Color

This adjusts the depth of the colors.

#### 1. Press ▲▼ to select “COLOR”.

PICTURE		
PICTURE MODE	NATURAL	
CONTRAST	0	←— —→+
BRIGHTNESS	0	←— —→+
COLOR	10	←— —→+
TINT	1	←— —→+
COLOR TEMP.	DEFAULT	
GAMMA	DEFAULT	
SHARPNESS	0	
NOISE REDUCTION	OFF	
DYNAMIC IRIS	OFF	
SYSTEM SELECTOR	AUTO 1	
◆ MENU SELECT		
◆ ADJUST		

#### 2. Press ENTER.

- The “COLOR” individual adjustment screen will be displayed.

COLOR	10	←— —→+
-------	----	--------

#### 3. Press ◀▶ to adjust the level.

Operation	Adjustment	Adjustment range
Press ▶ button.	Deepens colors.	Maximum value 50
Press ◀ button.	Weakens colors.	Minimum value -50

## Adjusting Tint

This adjusts skin tones in the pictures.

### 1. Press ▲▼ to select “TINT”.

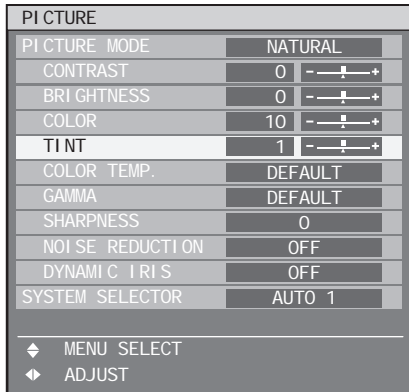

### 2. Press ENTER.

- The “TINT” individual adjustment screen will be displayed.

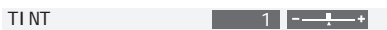

### 3. Press ◀▶ to adjust the level.

Operation	Adjustment	Adjustment range
Press ▶ button.	Adjusts skin tone toward reddish-purple.	Maximum value 31
Press ◀ button.	Adjusts skin tone toward greenish color.	Minimum value -31

## Adjusting the color temperature

This is used to adjust the pictures if white areas appear bluish or reddish.

- Carry out this adjustment while the signals to be adjusted are being projected.

### 1. Press ▲▼ to select “COLOR TEMP.”.

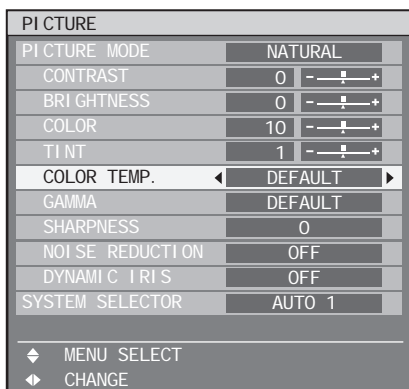

### 2. Press ◀▶ to switch “COLOR TEMP.”.

- The setting will change as follows each time ◀▶ is pressed.

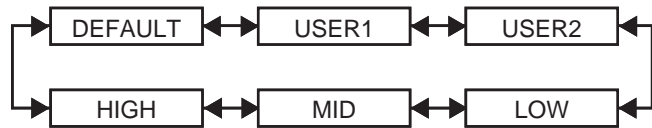

- When any setting other than “OFF” has been selected for color matching, the COLOR TEMP. setting is fixed at “USER1.”
- “DEFAULT” cannot be selected when the picture mode has been set to “USER.”

### ■ To further adjust toward the desired white balance

### 3. Select “USER1” or “USER2” in Step 2.

### 4. Press ENTER.

- The “WHITE BALANCE” screen will be displayed.

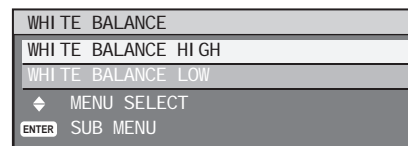

### 5. Press ▲▼ to select “WHITE BALANCE HIGH” or “WHITE BALANCE LOW”.

### 6. Press ENTER.

- The “WHITE BALANCE HIGH (LOW)” screen will be displayed.

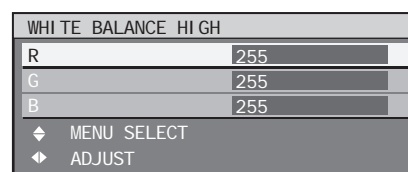

### 7. Press ▲▼ to select “R”, “G” or “B”.

## Adjusting the picture (continued)

### 8. Press ◀▶ to adjust the level.

Item	Operation	Adjustment	Adjustment range
R	Press ▶ button.	Deepens red.	Maximum value HIGH : 255 LOW : 127
	Press ◀ button.	Weakens red.	
G	Press ▶ button.	Deepens green.	Minimum value HIGH : 0 LOW : -127
	Press ◀ button.	Weakens green.	
B	Press ▶ button.	Deepens blue.	Default HIGH : 255 LOW : 0
	Press ◀ button.	Weakens blue.	

#### Note

- All colors will not be displayed properly unless adequate adjustment is made. If the adjustment does not look suitable, you can press DEFAULT to return the setting for the selected item only to the factory default setting.
- The color temperature cannot be adjusted for the internal test pattern (p. 83). Be sure to project the input signal when adjusting the color temperature.

## Gamma setting

This switches the gamma mode.

### 1. Press ▲▼ to select “GAMMA”.

PICTURE	
PICTURE MODE	NATURAL
CONTRAST	0
BRIGHTNESS	0
COLOR	10
TINT	1
COLOR TEMP.	DEFAULT
GAMMA	◀ DEFAULT ▶
SHARPNESS	0
NOISE REDUCTION	OFF
DYNAMIC IRIS	OFF
SYSTEM SELECTOR	AUTO 1
◆ MENU SELECT	
◆ CHANGE	

### 2. Press ◀▶ to switch “GAMMA”.

- The setting will change as follows each time ◀▶ is pressed.

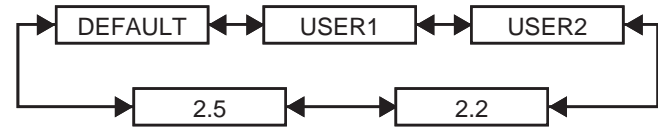

#### Note

- Separate software is required to select “USER1” and “USER2”. Consult your dealer.
- “DEFAULT” cannot be selected when the picture mode has been set to “USER”.

## Sharpness setting

This adjusts the sharpness of the pictures.

### 1. Press ▲▼ to select “SHARPNESS”.

PICTURE	
PICTURE MODE	NATURAL
CONTRAST	0
BRIGHTNESS	0
COLOR	10
TINT	1
COLOR TEMP.	DEFAULT
GAMMA	DEFAULT
SHARPNESS	0
NOISE REDUCTION	OFF
DYNAMIC IRIS	OFF
SYSTEM SELECTOR	AUTO 1
◆ MENU SELECT	
◆ CHANGE	

### 3. Press ◀▶ to adjust the level.

Operation	Adjustment	Adjustment range
Press ▶ button.	Contours become sharper.	0 to 15
Press ◀ button.	Contours become softer.	

#### Note

- The possible setting range will vary depending on the input signal.

## Noise reduction setting

This can be used to adjust pictures if they contain interference as a result of poor quality of the input signal.

### 1. Press ▲▼ to select “NOISE REDUCTION”.

PICTURE	
PICTURE MODE	NATURAL
CONTRAST	0
BRIGHTNESS	0
COLOR	10
TINT	1
COLOR TEMP.	DEFAULT
GAMMA	DEFAULT
SHARPNESS	0
NOISE REDUCTION	OFF
DYNAMIC IRIS	OFF
SYSTEM SELECTOR	AUTO 1
◆ MENU SELECT	
◆ CHANGE	

### 2. Press ◀▶ to switch “NOISE REDUCTION”.

- The setting will change as follows each time ◀▶ is pressed.

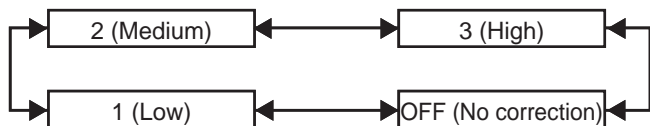

## Dynamic iris setting

Pictures with the optimum contrast will be displayed by automatically providing aperture compensation and signal compensation to suit the pictures concerned.

### 1. Press ▲▼ to select “DYNAMIC IRIS”.

PICTURE	
PICTURE MODE	NATURAL
CONTRAST	0
BRIGHTNESS	0
COLOR	10
TINT	1
COLOR TEMP.	DEFAULT
GAMMA	DEFAULT
SHARPNESS	0
NOISE REDUCTION	OFF
DYNAMIC IRIS	OFF
SYSTEM SELECTOR	AUTO 1
◆ MENU SELECT	
◆ CHANGE	

### 2. Press ◀▶ to switch “DYNAMIC IRIS”.

- The setting will change as follows each time ◀▶ is pressed.

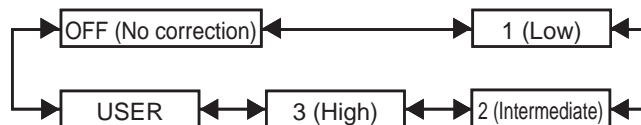

### To further adjust the selected compensation amount

### 3. Select “USER” in step 2.

### 4. Press ENTER.

- The “DYNAMIC IRIS” screen will be displayed.

DYNAMIC IRIS	
AUTO IRIS	OFF
MANUAL IRIS	OFF
DYNAMIC GAMMA	OFF
◆ MENU SELECT	
◆ CHANGE	

### 5. Use ▲▼ to select the item to be adjusted, and then use ◀▶ to adjust the amount of correction.

#### AUTO IRIS (Automatic aperture adjustment)

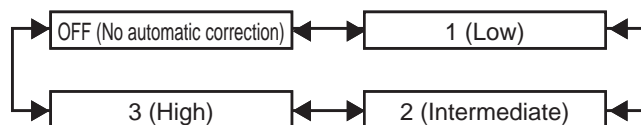

#### MANUAL IRIS (Fixed aperture adjustment)

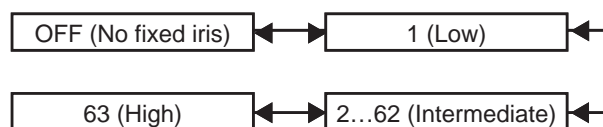

#### DYNAMIC GAMMA (signal compensation amount adjustment)

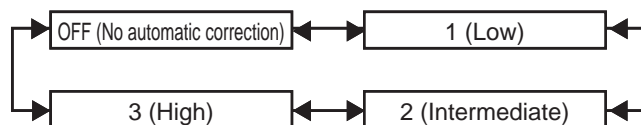

#### Note

- The contrast is set to the maximum level when “DYNAMIC IRIS” is set to “3.”
- When “FRAME DELAY” is set to “SHORT”, the noise reduction setting function cannot be used.

## Adjusting the picture (continued)

### Registering the picture mode settings as presets

The picture settings that have been made in the PICTURE MODE screen can be registered.

- Select "PICTURE MODE" in the "PICTURE" screen to carry out this operation.

#### 1. Press ENTER.

- A confirmation screen will appear.

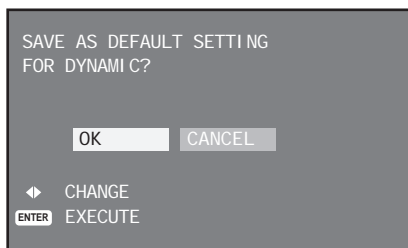

#### 2 Press ◀▶ to select "OK".

#### 3. Press ENTER.

#### Note

- If the registered picture mode is selected after registering the picture mode settings as presets, the new signals will be displayed with the registered adjustments.

### Setting the system format

The SYSTEM SELECTOR setting can be used to switch the system format.

#### 1. Press ▲▼ to select "SYSTEM SELECTOR".

PICTURE	
PICTURE MODE	NATURAL
CONTRAST	0 - - - - +
BRIGHTNESS	0 - - - - +
COLOR	10 - - - - +
TINT	1 - - - - +
COLOR TEMP.	DEFAULT
GAMMA	DEFAULT
SHARPNESS	0
NOISE REDUCTION	OFF
DYNAMIC IRIS	OFF
SYSTEM SELECTOR	◀ AUTO 1 ▶
◆ MENU SELECT	
◀ CHANGE	

#### 2. Press ◀▶ to switch "SYSTEM SELECTOR".

- Refer to "How to change the system format" below for details on the system formats which can be selected.

### How to change the system format

Using the menu screen operation enables the user to make the following changes depending on S-Video / Video input or the currently selected input module. The name of the selected system such as RGB, YPbPr and AUTO is displayed on the top left of the screen and disappears automatically.

#### ■ S-video / Video terminal input signal

##### For the setting of AUTO1:

Selection is automatically made out of NTSC, PAL, SECAM, NTSC4.43 and PAL60.

##### For the setting of AUTO2:

Selection is automatically made out of NTSC, PAL-M and PAL-N.

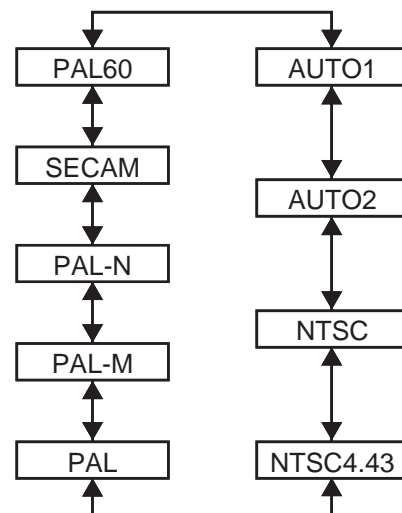

#### ■ Input module

##### ET-MD77SD1:

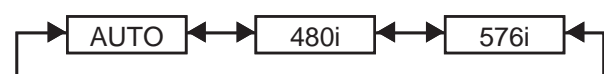

##### ET-MD77SD3:

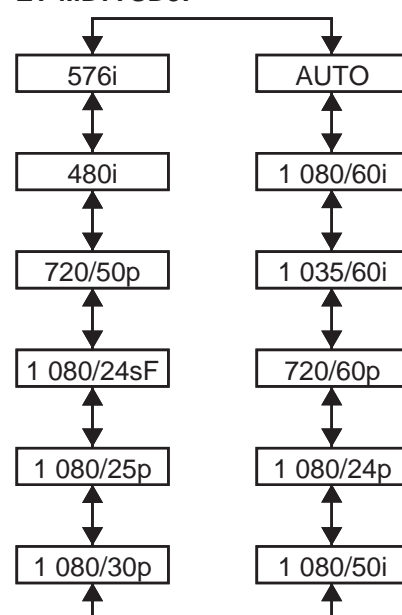

- \* When DEFAULT is pressed, the projector automatically returns to AUTO1 or AUTO.

## ■ RGB1/RGB2/DVI-D terminal input signals

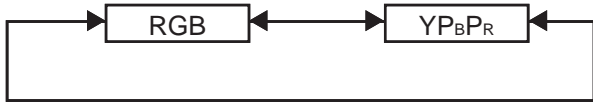

### Note

- Refer to the types of RGB/YPbPr/DVI-D signals compatible with the projector. (p. 118)

## To display pictures complying with the sRGB standard

sRGB is the international color reproduction standard (IEC61966-2-1) established by IEC (International Electrotechnical Commission).

To reproduce colors more faithfully in compliance with the sRGB standard, perform the following setting procedure.

1. Set “COLOR MATCHING” adjustment to “OFF”. (p. 67)
2. Display the “PICTURE” screen. (p. 49)
3. Press ▲▼ to select “PICTURE MODE”.

PICTURE	
PICTURE MODE	NATURAL
CONTRAST	0
BRIGHTNESS	0
COLOR	10
TINT	1
COLOR TEMP.	DEFAULT
GAMMA	DEFAULT
SHARPNESS	0
NOISE REDUCTION	OFF
DYNAMIC IRIS	OFF
SYSTEM SELECTOR	AUTO 1
◆ MENU SELECT	
◆ CHANGE ENTER REGISTER	

4. Press ◀▶ to select “NATURAL”.

5. Press ▲▼ to select “COLOR”.

PICTURE	
PICTURE MODE	NATURAL
CONTRAST	0
BRIGHTNESS	0
COLOR	10
TINT	1
COLOR TEMP.	DEFAULT
GAMMA	DEFAULT
SHARPNESS	0
NOISE REDUCTION	OFF
DYNAMIC IRIS	OFF
SYSTEM SELECTOR	AUTO 1
◆ MENU SELECT	
◆ ADJUST	

6. Press DEFAULT on the remote control to restore the factory default.
7. Follow the same procedure (steps 5-6) to restore the factory default for “TINT”, “COLOR TEMP.” and “GAMMA”.

### Note

- sRGB is only enable when RGB signals are being input.



# Adjusting the position

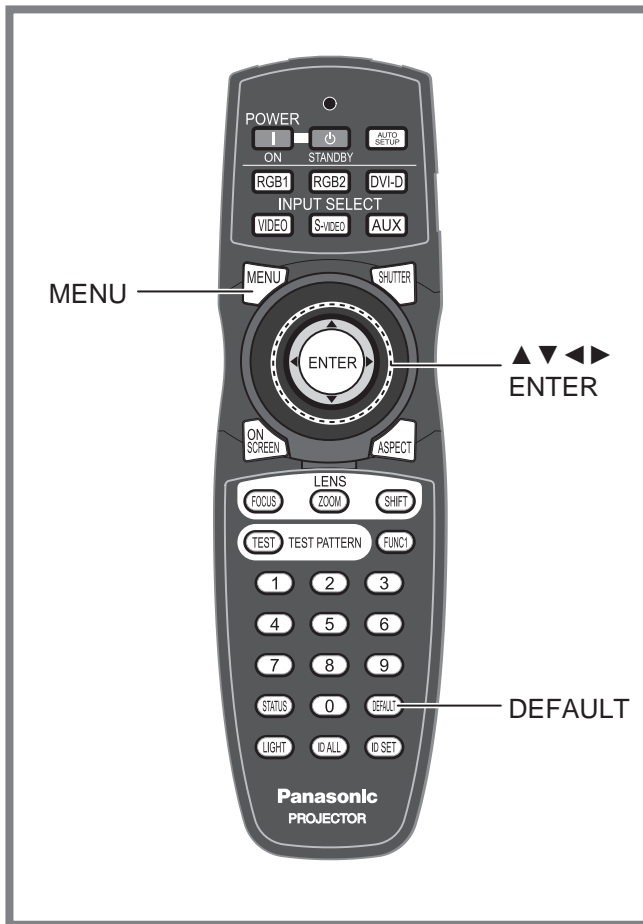

You can adjust the position as required.

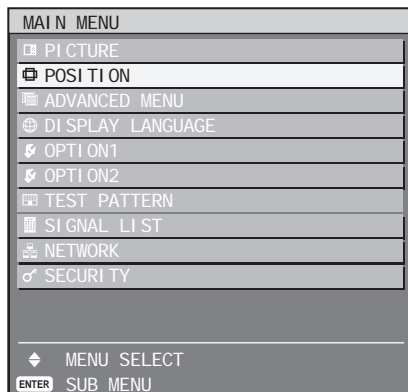
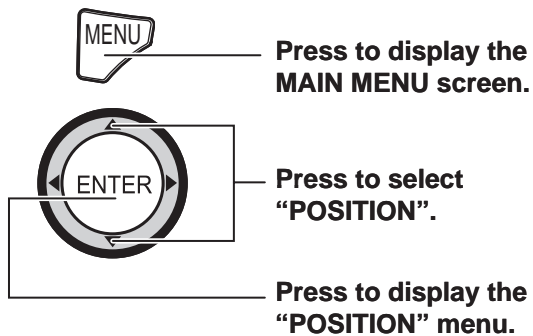

## Shift adjustment

This function allows the user to adjust the picture position vertically or horizontally if the position of the image projected on the screen is displaced when the projector is properly positioned against the screen.

1. Press ▲▼ to select “SHIFT”.

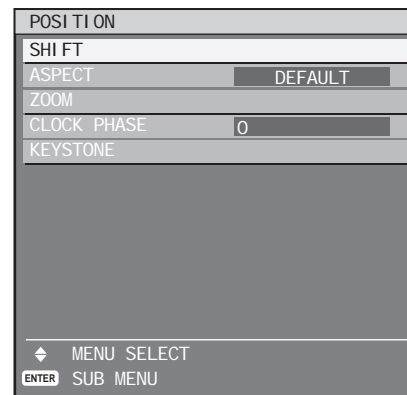

2. Press ENTER.

- The “SHIFT” screen will be displayed.

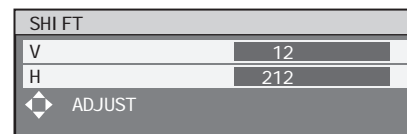

3. Press ▲▼◀▶ to adjust the position.

■ For horizontal (right and left) adjustment

Operation	Adjustment
Press ► button.	The picture position moves to the right.
Press ◀ button.	The picture position moves to the left.

■ For vertical (up and down) adjustment

Operation	Adjustment
Press ► button.	The picture position moves up.
Press ◀ button.	The picture position moves down.

4. Press MENU three times.

- The on-screen indications disappear and the normal screen appears again.

## Adjusting the aspect ratio

This changes the aspect ratio of the pictures.

### 1. Press ▲ ▼ to select “ASPECT”.

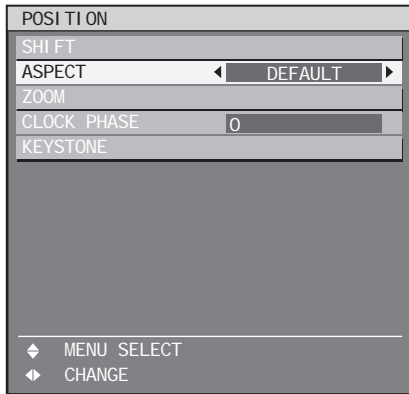

### 2. Press ◀ ▶ to switch “ASPECT”.

- The setting will change as follows each time ◀ ▶ is pressed.

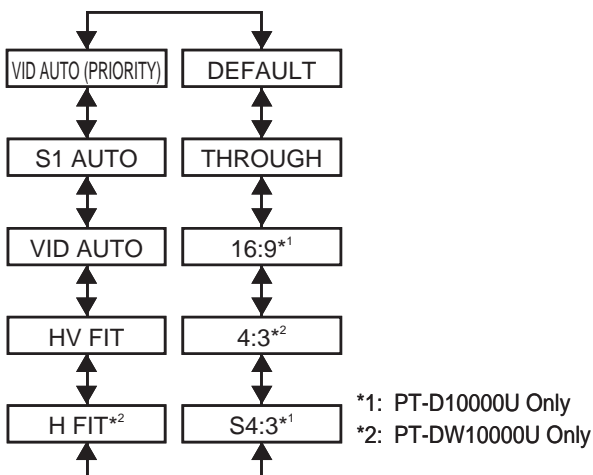

- DEFAULT:**  
Pictures are displayed without changing the aspect ratio of the input signals.
- THROUGH:**  
Pictures are displayed without changing the resolution of the input signals.
- 16:9<sup>\*1</sup>:**  
When standard signals are being input<sup>\*3</sup>, pictures are displayed with the aspect ratio converted to 16:9. When wide-screen signals are being input<sup>\*4</sup>, pictures are displayed with the aspect ratio of the input signals unchanged.
- 4:3<sup>\*2</sup>:**  
When standard signals are being input<sup>\*3</sup>, pictures are displayed with the aspect ratio of the input signals unchanged. When wide-screen signals are being input<sup>\*4</sup>, the PT-D10000U displays the pictures with the aspect ratio converted to 4:3. The PT-DW10000U displays the pictures with the aspect ratio unchanged, but reduces the size of the pictures so that they fit within the 4:3 projection area.

- S4:3<sup>\*1</sup>:**  
Select when using a 16:9 screen.
- H FIT<sup>\*2</sup>:**  
Pictures are displayed using all the panel pixels in the horizontal direction. Signals with an aspect ratio where the pictures are taller than with a ratio of 16:9 will be displayed with their bottom areas cut off.
- HV FIT:**  
Pictures are displayed on the whole panel pixels. If the aspect ratio of the input signals is different from that of the panel, the pictures are displayed by converting it into the panels aspect ratio (4:3 for PT-D10000U and 16:9 for PT-DW10000U).

- VID AUTO:**  
The projector identifies the video ID (VID) embedded in the picture signals and displays the picture by automatically switching the screen sizes between 4:3 and 16:9. This function is effective for the NTSC signal input.

- S1 AUTO:**  
The projector identifies the S1 signal and displays the picture by automatically switching the screen sizes between 4:3 and 16:9. This function is effective for S-Video NTSC signals.

- VID AUTO (PRIORITY):**  
The projector identifies the abovementioned VID or S1 signals and displays the picture by automatically choosing the screen sizes of 4:3 or 16:9 according to the VID if it is detected or S1 signals if a VID is not detected. This function is effective for S-Video NTSC signals.

\*3: Standard signals are input signals with an aspect ratio of 4:3 or 5:4.

\*4: Wide-screen signals are input signals with an aspect ratio of 16:9, 15:9 or 15:10.

#### Note

- Some size modes are not available for certain types of input signals. For NTSC signals, “DEFAULT” cannot be selected.
- If an aspect ratio which is different from the aspect ratio for the input signals is selected, the pictures will appear differently from the originals. Be careful of this when selecting the aspect ratio.
- If using this projector in places such as cafes or hotels to display programmes for a commercial purpose or for public presentation, note that adjusting the aspect ratio or using the zoom function to change the screen pictures may be an infringement of the rights of the original copyright owner for that programme under copyright protection laws.
- If conventional (normal) 4:3 pictures which are not wide-screen pictures are displayed on a wide screen, the edges of the pictures may not be visible or they may become distorted. Such pictures should be viewed as with an aspect ratio of 4:3 in the original format intended by the creator of the pictures.

## Adjusting the position (continued)

### Adjusting the zoom ratio

This adjusts the size of the projected pictures.

#### 1. Press ▲▼ to select “ZOOM”.

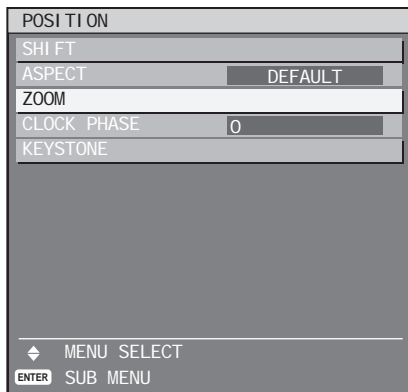

#### 2. Press ENTER.

- The “ZOOM” screen will be displayed.

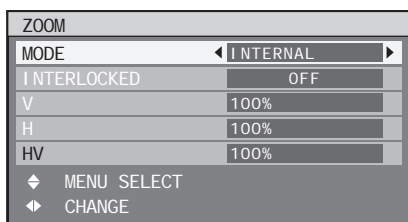

#### 3. Press ▲▼ to select “MODE”.

#### 4. Press ◀▶ to switch “MODE”.

- The setting will change as follows each time ◀▶ is pressed.

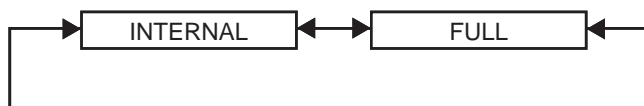

- INTERNAL:**  
Enlarges the size of the pictures to within the default aspect ratio.
- FULL:**  
Enlarges the pictures using the whole of the display area.

#### 5. Press ▲▼ to select “INTERLOCKED”.

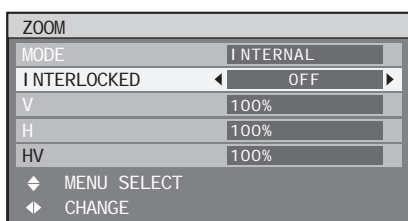

#### 6. Press ◀▶ to switch “INTERLOCKED”.

- The setting will change as follows each time ◀▶ is pressed.

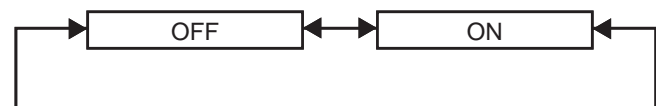

- OFF :**  
The “V” and “H” settings are used as the vertical and horizontal zoom ratios respectively.
- ON :**  
The zoom ratio is set to the “HV” setting. This allows the pictures to be zoomed at equal vertical and horizontal ratios.

#### Note

- When “ASPECT” is set to “THROUGH”, “ZOOM” will not appear.

### Clock phase adjustment

Clock phase adjustment achieves the best image when the screen flickers or halo is observed around the contour.

#### 1. Press ▲▼ to select “CLOCK PHASE”.

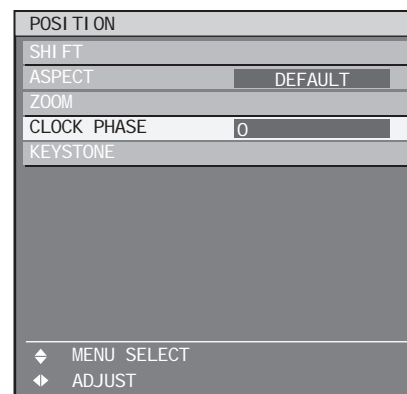

#### 2. Press ◀▶ to adjust the level.

- The value changes from 0 to 31. Adjust so that the amount of interference is at a minimum.

#### Note

- No optimal value may be obtained if the output of the PC to which the signal input is applied is unstable.
- No optimal value may be obtained if the total number of dots is not correct.
- The clock phase can be adjusted only when RGB signal input is applied with RGB1 and RGB2 IN.

## Keystone distortion correction

Keystone distortion can be corrected only along either horizontal bound of the picture.

### 1. Press ▲▼ to select “KEYSTONE”.

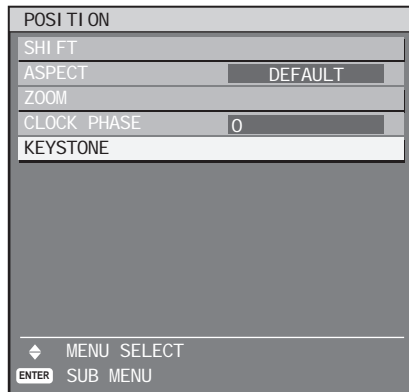

### 2. Press ENTER.

- The “KEYSTONE” screen will be displayed.

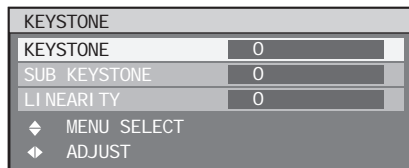

### 3. Press ◀▶ to adjust the “KEYSTONE”.

- The value changes from -127 to 127.

### 4. Press ▲▼ to select “SUB KEYSTONE” or “LINEARITY”.

### 5. Press ◀▶ to adjust “SUB KEYSTONE” or “LINEARITY”.

- The value changes from -127 to 127.

#### Note

- Adjust the “SUB KEYSTONE” or “LINEARITY” after adjusting the “KEYSTONE”.  
The variable range of the “SUB KEYSTONE” or “LINEARITY” changes in response to the adjusted value of the “KEYSTONE”.
- “SUB KEYSTONE” is a function which is used to correct keystone distortion when the lens has been shifted to the left or right. Keystone correction can only be carried out for the area at the top-right of the screen. However, this adjustment cannot be used when “KEYSTONE” is set to “0”.
- Pressing DEFAULT of the remote control will restore the factory default (“KEYSTONE”: 0, “SUB KEYSTONE”: 0, “LINEARITY”: 0).
- The adjusted value is reflected in other input signals.
- Keystone distortion can be corrected to  $\pm 40^\circ$  of the angle of tilt for the projector against the screen. (The range for the angle of elevation is within  $\pm 22^\circ$  when using a lens with a fixed focal point, and it is within  $\pm 28^\circ$  when using an LE6 lens.)

# How to use ADVANCED MENU

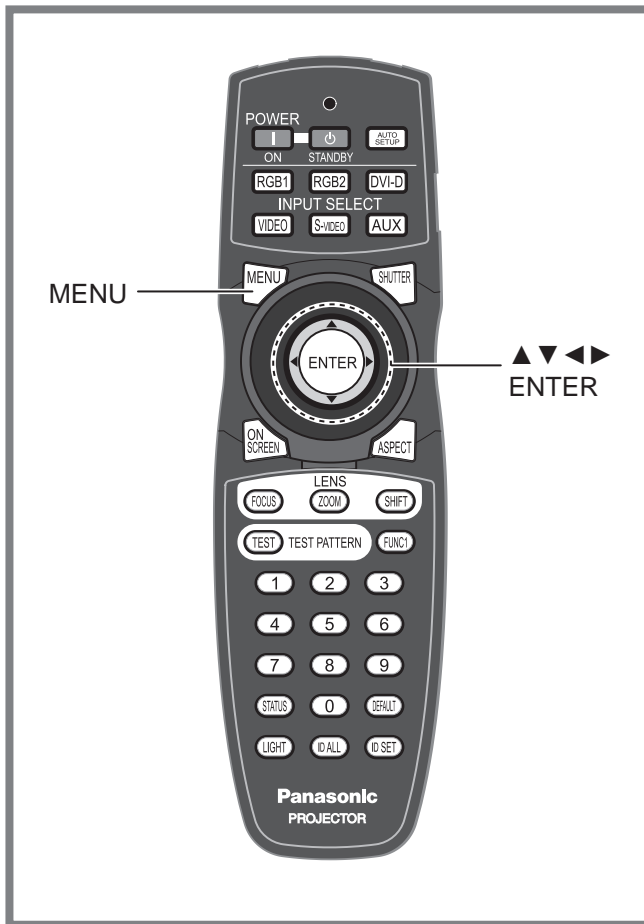

## Digital cinema reality

Increase the vertical resolution when the PAL (or SECAM) 576i signal input or the NTSC 480i, 1 080/50i and 1 080/60i signal input is applied.

### 1. Press ▲▼ to select “DIGITAL CINEMA REALITY”.

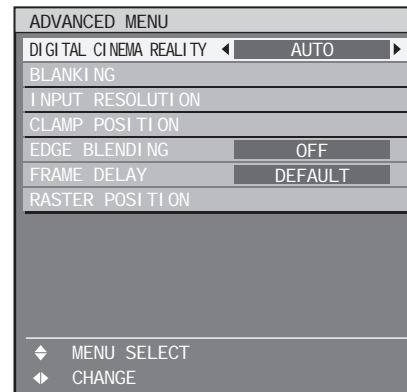

### 2. Press ◀▶ to switch “DIGITAL CINEMA REALITY”.

- The setting will change as follows each time ◀▶ is pressed.

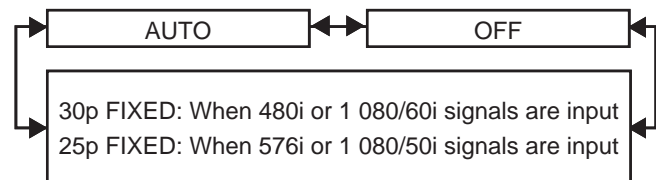

- **AUTO:**  
Performs automatic detection and cinema processing. (factory default)
- **OFF:**  
Unforced cinema processing
- **25p FIXED:**  
Forced cinema processing (2:2 pulldown) is performed when a 576i or 1 080/50i signal is input.
- **30p FIXED:**  
Forced cinema processing (2:2 pulldown) is performed when a 480i or 1 080/60i signal is input.

### Note

- In DIGITAL CINEMA REALITY mode, the image quality will be deteriorated if 30p FIXED or 25p FIXED is selected when the signal is not a 2:2 pulldown signal.

Fine settings are possible.

- MENU** — Press to display the **MAIN MENU** screen.
- ENTER** — Press to select **“ADVANCED MENU”**.
- ENTER** — Press to display the **“ADVANCED MENU”** menu.

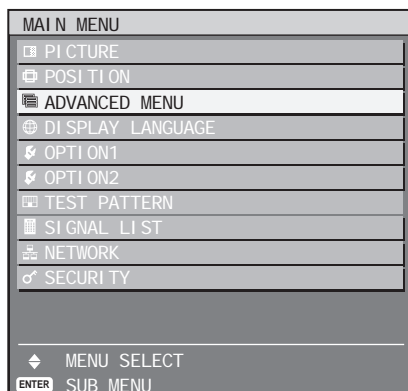

## Blanking adjustment

Blanking adjustment fine-tunes the images projected by the video deck or other devices when the noise appears on the edges of the screen or if a part of the image lies slightly offscreen.

### 1. Press ▲▼ to select “BLANKING”.

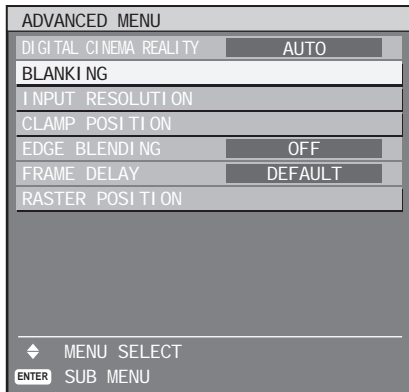

### 2. Press ENTER.

- The “BLANKING” adjustment screen will be displayed.

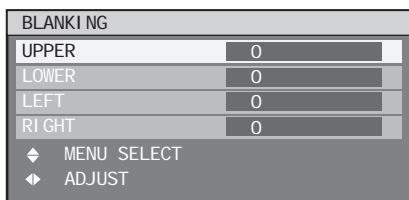

### 3. Press ▲▼ to select the desired item for adjustment.

### 4. Press ◀▶ to adjust blanking.

- The adjustment value for the PT-D10000U can be changed within a range of 0 to 255 vertically and 0 to 700 horizontally.
- The adjustment value for the PT-DW10000U can be changed within a range of 0 to 540 vertically and 0 to 960 horizontally.

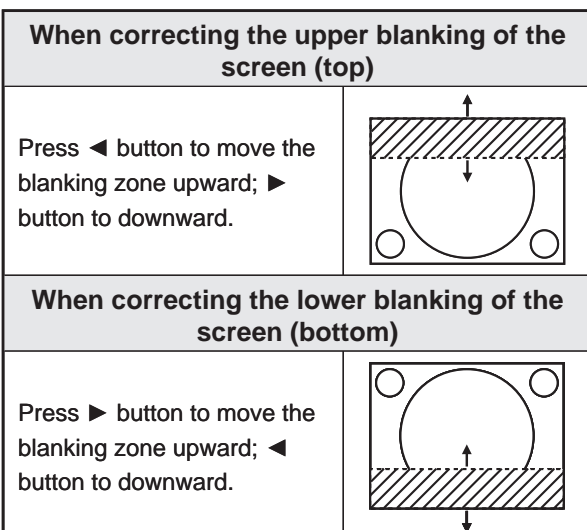

### When correcting the left hand blanking of the screen (left)

Press ▶ button to move the blanking zone to the right; ◀ button to the left.

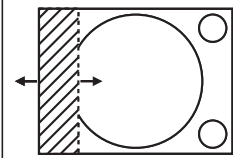

### When correcting the right hand blanking of the screen (right)

Press ◀ button to move the blanking zone to the right; ▶ button to the left.

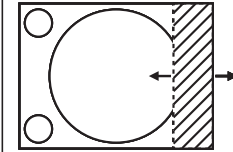

## Adjusting the input resolution

Input resolution adjustment achieves the best image when the screen flickers or halo is observed around the contour.

### 1. Press ▲▼ to select “INPUT RESOLUTION”.

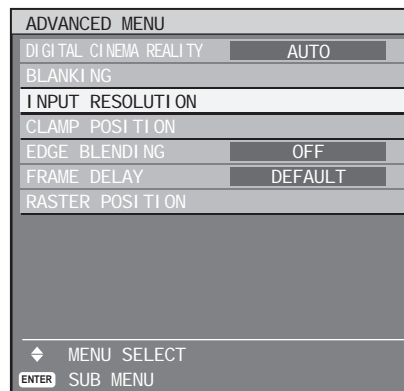

### 2. Press ENTER.

- The “INPUT RESOLUTION” screen will be displayed.

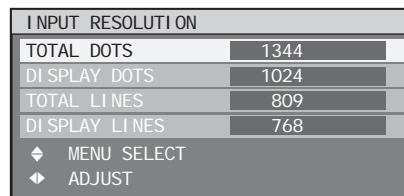

### 3. Press ▲▼ to select “TOTAL DOTS”, “DISPLAY DOTS”, “TOTAL LINES” or “DISPLAY LINES”, and the press ◀▶ to adjust it.

- Each item automatically displays a value in response to the type of the input signal. If vertical stripes appear on the screen or the image is partly missing, increase or decrease the displayed value while observing the screen to achieve the optimal value.

## How to use ADVANCED MENU (continued)

### Note

- The abovementioned vertical stripes will not appear on the screen when all signals are input.
- The picture may be distorted during the adjusting operation, but this is not a fault.
- The input resolution can be adjusted only when RGB signal input is applied with RGB1 and RGB2 IN.

## Adjusting the clamp position

Use the clamp position adjustment to achieve the optimal value when dark areas of the image are crushed or displayed in green.

1. Press ▲▼ to select “CLAMP POSITION”.

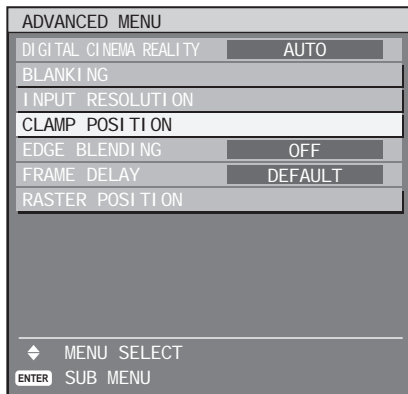

2. Press ENTER.

- The “CLAMP POSITION” screen will be displayed.

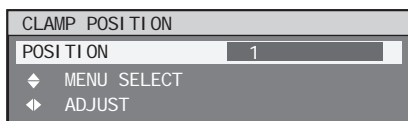

3. Press ◀▶ to adjust.

- The value changes from 1 to 255.
- **The optimal value for the clamp position adjustment**  
If dark areas are crushed:  
The optimal value is the point where the dark area is best improved.  
If the dark areas are displayed in green:  
The optimal value is the point where the green area becomes dark and clear.

### Note

- The clamp position can be adjusted only when the RGB signal input is applied with RGB1 and RGB2 IN.

## Edge blending adjustment

This projector has the function to hide the seams for multi-screens.

1. Press ▲▼ to select “EDGE BLENDING”.

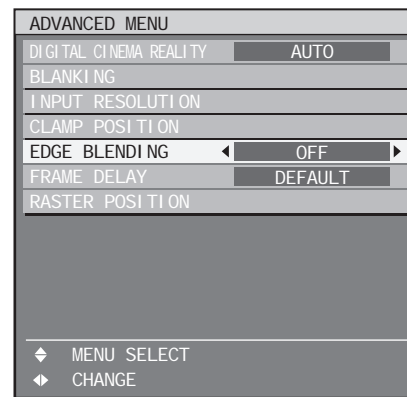

2. Press ◀▶ to switch “EDGE BLENDING”.

- The setting will change as follows each time ◀▶ is pressed.

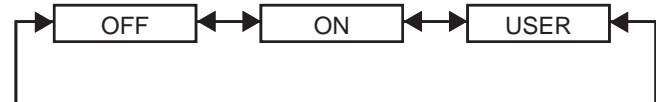

- **OFF:**  
When the multi-screens are not going to be used.
- **ON:**  
When the tilting inside the unit is to be used for the tilting of the edge blending area.
- **USER:**  
When a specific tilting is to be used for the tilting of the edge blending area. (Separate software is required to establish these settings. Consult your dealer.)

3. Press ENTER.

- The “EDGE BLENDING” screen will be displayed.

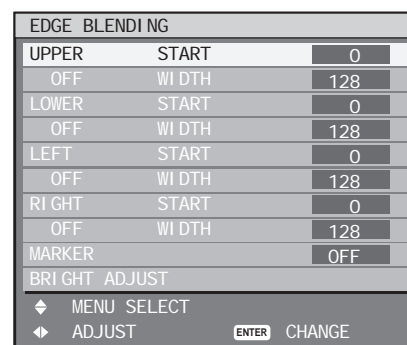

**4. Press ▲▼ to specify the area to be adjusted.**

- To joint the top: set "UPPER" to "ON".
- To joint the bottom: set "LOWER" to "ON".
- To joint the left: set "LEFT" to "ON".
- To joint the right: set "RIGHT" to "ON".

**5. Press ENTER to toggle "ON" and "OFF".**

**6. Press ◀▶ to adjust the compensation width and start position.**

**■ To display the adjustment marker**

**7. Press ▲▼ to select "MARKER".**

EDGE BLENDING		
UPPER	START	0
OFF	WIDTH	128
LOWER	START	0
OFF	WIDTH	128
LEFT	START	0
OFF	WIDTH	128
RIGHT	START	0
OFF	WIDTH	128
MARKER		OFF
BRIGHT ADJUST		
◊ MENU SELECT		
ENTER CHANGE		

**8. Press ENTER to select "ON".**

- A marker for adjusting the picture position appears. The optimal point is the position where the red line of one frame overlaps the green line of the other frame. The correction widths of the jointed frames must be the same value all the time. The optimal joint cannot be achieved if the jointed frames have different correction widths.

The optimal point is where these lines overlap.

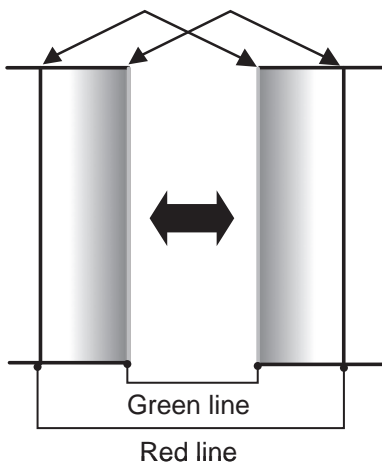

**9. Press ▲▼ to select "BRIGHT ADJUST".**

EDGE BLENDING		
UPPER	START	0
OFF	WIDTH	128
LOWER	START	0
OFF	WIDTH	128
LEFT	START	0
OFF	WIDTH	128
RIGHT	START	0
OFF	WIDTH	128
MARKER		OFF
BRIGHT ADJUST		
◊ MENU SELECT		
ENTER SUB MENU		

**10. Press ENTER.**

- The "BRIGHT ADJUST" screen will be displayed.

BRIGHT ADJUST	
BRIGHT INSIDE	
BRIGHT OUTSIDE	
UPPER	0
LOWER	0
LEFT	0
RIGHT	0
◊ MENU SELECT	
◊ ADJUST	

**11. Press ▲▼ to select "BRIGHT INSIDE".**

**12. Press ENTER.**

- The "BRIGHT INSIDE" adjustment screen will be displayed.

BRIGHT INSIDE	
INTERLOCKED	ON
Wh	0
R	0
G	0
B	0
◊ MENU SELECT	
◊ CHANGE	

- When "INTERLOCKED" is set to "OFF", individual adjustment of "R", "G" and "B" will be possible.

**13. Press ▲▼ to select an item, and press ◀▶ to adjust the setting.**

- Once adjustment is complete, press MENU to return to "BRIGHT ADJUST".

**14. Press ▲▼ to select the part of "UPPER", "LOWER", "RIGHT", "LEFT".**



## How to use ADVANCED MENU (continued)

15. Use ◀▶ to adjust the width for correcting the “BRIGHT INSIDE” setting (0 to 255).

16. Press ▲▼ to select “BRIGHT OUTSIDE”.

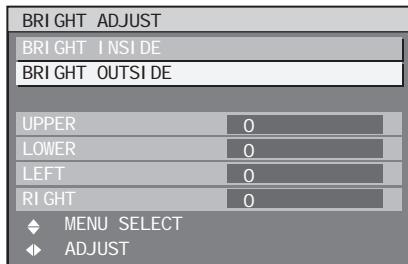

17. Press ENTER.

- The “BRIGHT OUTSIDE” adjustment screen will be displayed.

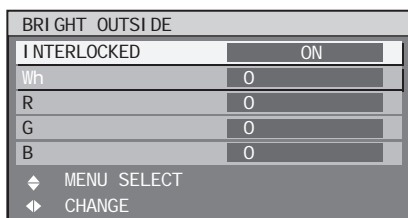

- When “INTERLOCKED” is set to “OFF”, individual adjustment of “R”, “G” and “B” will be possible.

18. Press ▲▼ to select an item, and press ▶◀ to adjust the setting.

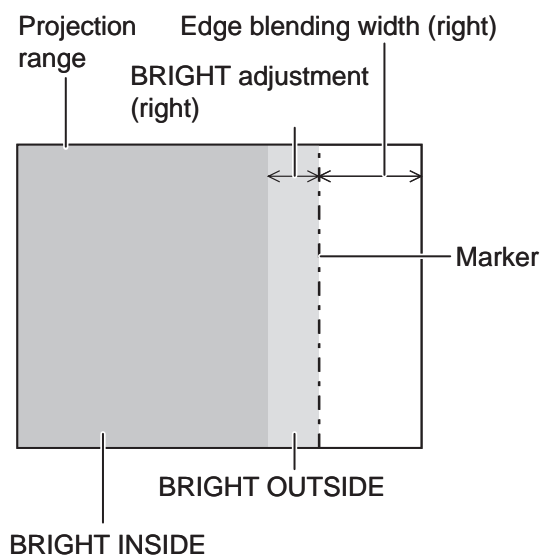

### Note

- The BRIGHT adjustment is a function for making the brightening of the BRIGHT level in those areas where the pictures overlap less conspicuous when multi-screens have been configured using edge blending. The optimal point is where, after the BRIGHT INSIDE has been adjusted, the compensation amount is the same for the BRIGHT levels in the areas where the pictures overlap and where the pictures do not overlap. If, after the BRIGHT INSIDE adjustment, only the vicinity of the borders of the areas where the pictures overlap and where the pictures do not overlap becomes bright, proceed to adjust the top, bottom, left and right widths. Alternatively, if only the vicinity of the borders has darkened as a result of the width adjustments, proceed with the BRIGHT OUTSIDE adjustment.
- When a rear screen or screen with a high gain is used, the joints may appear to be discontinuous depending on the viewing position.

## Frame delay

When 1080/60i, 1080/50i and 1080/24sF signals are being input, this simplifies image processing so that the frame delay for pictures can be shortened.

1. Press ▲▼ to select “FRAME DELAY”.

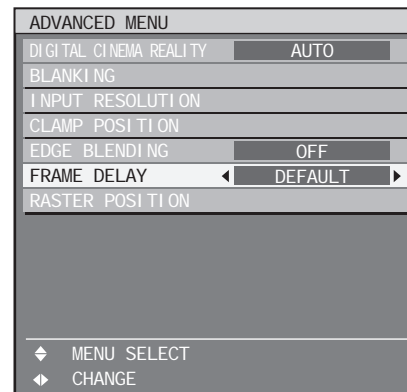

2. Press ▶◀ to switch “FRAME DELAY”.

- The setting will change as follows each time ▶◀ is pressed.

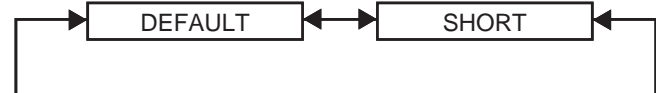

- DEFAULT:**  
This is the standard setting
- SHORT:**  
This causes the pictures to be delayed after the audio.

## Note

- When "FRAME DELAY" is set to "SHORT", deterioration in the picture quality will occur. Furthermore, the noise reduction function cannot be used.

## Raster position

When the whole area where the input picture can be displayed is not used, the picture can be moved to any position inside the display area.

### 1. Press ▲▼ to select "RASTER POSITION".

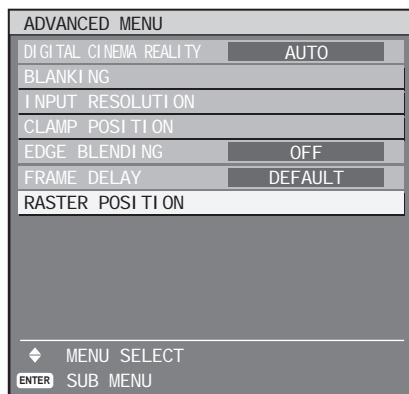

### 2. Press ENTER.

- The "RASTER POSITION" screen will be displayed.

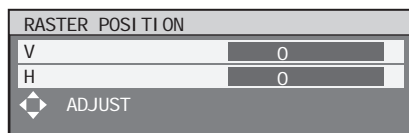

### 3. Press ▲▼◀▶ to adjust the position.

#### ■ PT-D10000U

When 5:4 pictures are displayed (when SXGA signals are input)	
Pressing ▶ button will move the image to the right.	
Pressing ◀ button will move the image to the left.	

When 16:9 pictures are displayed (when HDTV or 480p pictures are input or 16:9 is selected in the SIZE mode)	
Pressing ▲ button will move the image upward.	
Pressing ▼ button will move the image downward.	

#### ■ PT-DW10000U

When 4:3 pictures are displayed	
Pressing ▶ button will move the image to the right.	
Pressing ◀ button will move the image to the left.	

### 4. Press MENU three times.

- The on-screen indications disappear and the normal screen appears again.

# Setting the DISPLAY LANGUAGE

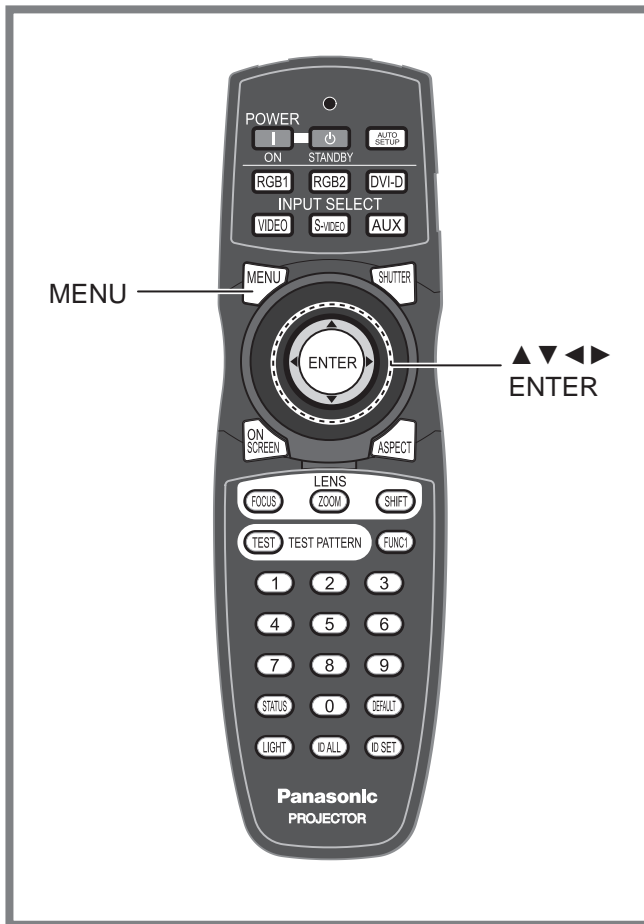

## Changing the display language

This lets you switch the on-screen display language.

### 1. Press ▲▼ to select the desired language.



### 2. Press ENTER to establish your selection.

- When this is selected, the language display will turn a light green.
- Menus, setting items, adjustment screens, and control button names will be displayed in the language the user chooses.
- The available languages are: English, German (DEUTSCH), French (FRANÇAIS), Spanish (ESPAÑOL), Italian (ITALIANO), Japanese (日本語), Chinese (中文), Russian (русский), and Korean (한국어).

#### Note

- The on-screen display of the projector is set to the English language on shipping.

This lets you switch the display language.

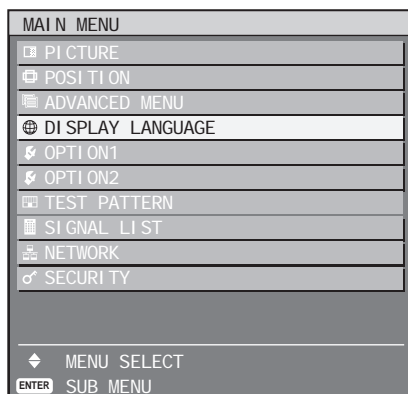
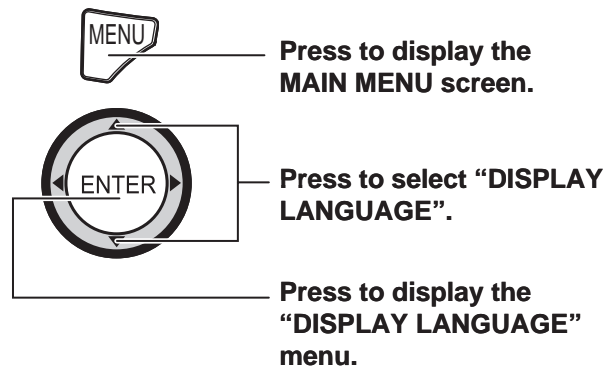

# Option1 settings

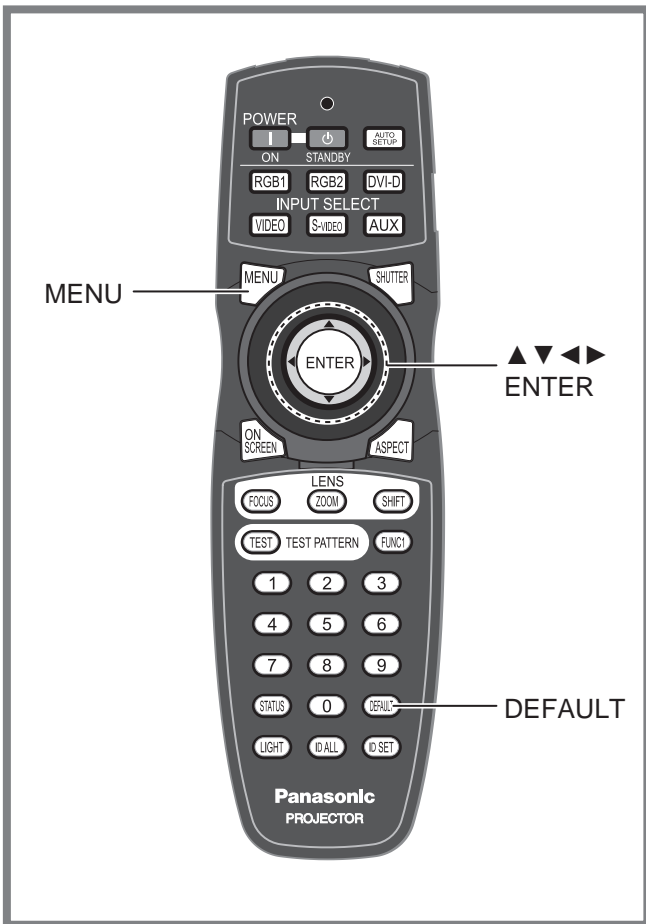

This menu can be used to make a variety of picture and projector settings.



Press to display the **MAIN MENU** screen.



Press to select **"OPTION1"**.

Press to display the **"OPTION1"** menu.

MAIN MENU	
PICTURE	
POSITION	
ADVANCED MENU	
DISPLAY LANGUAGE	
<b>OPTION1</b>	
OPTION2	
TEST PATTERN	
SIGNAL LIST	
NETWORK	
SECURITY	
◆ MENU SELECT	
ENTER SUB MENU	

## Adjusting color matching

When multiple sets are used simultaneously, this projector allows the user to correct the difference of colors among the sets.

### 1. Press ▲▼ to select "COLOR MATCHING".

OPTION1	
COLOR MATCHING	OFF
LARGE SCREEN CORRECTION	OFF
AUTO SIGNAL	OFF
AUTO SETUP	
BACK COLOR	BLUE
DVI EDI D	EDI D2(PC)
AUX DVI EDI D	EDI D2(PC)
P I N P	OFF
FUNC1	P I N P
OSD POSI TION	2
OSD MEMORY	ON
◆ MENU SELECT	
◆ CHANGE	

### 2. Press ◀▶ to switch "COLOR MATCHING".

- The setting will change as follows each time ◀▶ is pressed.

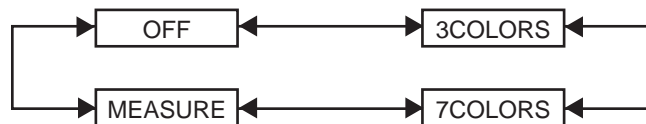

- OFF:**  
Color matching adjustment is not carried out.
- 3COLORS:**  
It is possible to adjust the 3colors of "R (Red)", "G (Green)" and "B (Blue)".
- 7COLORS:**  
It is possible to adjust the 7colors of "R (Red)", "G (Green)", "B (Blue)", "Cy (Cyan)", "Mg (Magenta)", "Ye (Yellow)" and "Wh (White)".
- MEASURE:**  
Refer to "Adjusting the color matching using a colorimeter" on the next page for details on these modes.

## Option1 settings (continued)

### ■ If “3COLORS” or “7COLORS” was selected in step 2.

#### 3. Press ENTER.

- The “COLOR MATCHING: 3COLORS” or “COLOR MATCHING: 7COLORS” screen will be displayed.

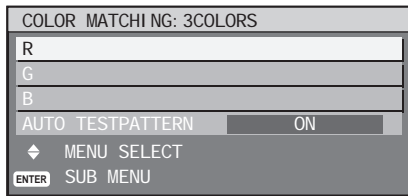

#### 4. Press ▲▼ to select “R”, “G” and “B”.

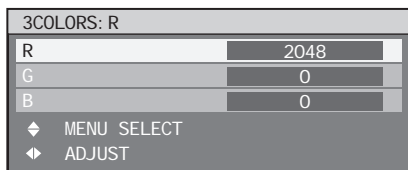

#### 5. Press ENTER.

#### 6. Press ◀▶ to adjust the values.

- These values can be adjusted from 0 to 2048.

### Note

- The effects of correcting the adjustment color:  
When tuning the correction color that is the same as the adjustment color: the brightness of the adjustment color changes.  
When tuning the correction color RED: RED is added to or reduced from the adjustment color.  
When tuning the correction color GREEN: GREEN is added to or reduced from the adjustment color.  
When tuning the correction color BLUE: BLUE is added to or reduced from the adjustment color.
- This adjustment should be carried out by a person who is familiar with the projector or by a service person because a high level of skill is required to make successful adjustment.
- Pressing DEFAULT will restore the factory defaults for all items.
- When any setting other than “OFF” has been selected for color matching, the “COLOR TEMP.” setting is fixed at “USER1”.

## Adjusting the color matching using a colorimeter

The “R (Red)”, “G (Green)”, “B (Blue)”, “Cy (Cyan)”, “Mg (Magenta)”, “Ye (Yellow)” and “Wh (White)” colors can be changed to the desired hues using a colorimeter which is capable of measuring the chromaticity coordinates and luminance.

### ■ Inputting the current luminance and chromaticity coordinates

#### 1. Press ▲▼ to select “COLOR MATCHING”.

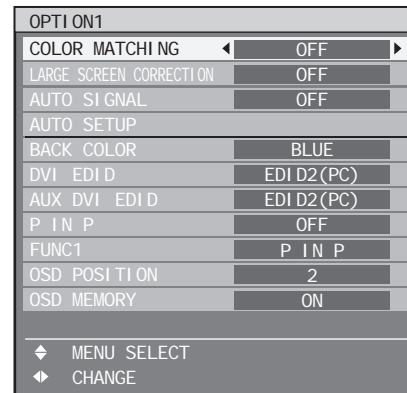

#### 2. Press ◀▶ to select “MEASURE”.

#### 3. Press ENTER.

- The “MEASURE MODE” screen will be displayed.

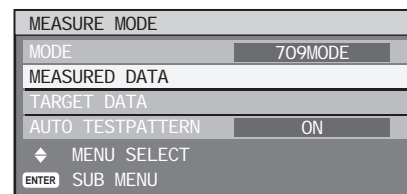

#### 4. Press ▲▼ to select “MEASURED DATA”.

#### 5. Press ENTER.

- The “MEASURED DATA” screen will be displayed.

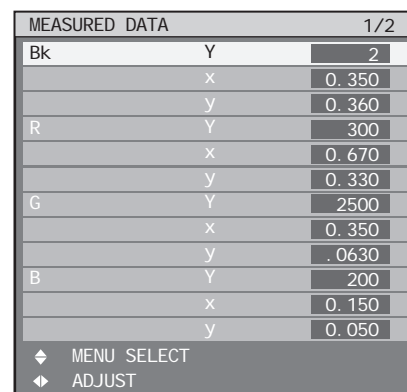

6. Use the colorimeter to measure the luminance (Y) and chromaticity coordinates (x, y).
7. Press ▲ ▼ to select the colors, and press ◀ ▶ to select their values.
8. After all the data has been input, press MENU.
  - The “MEASURE MODE” screen will be displayed.

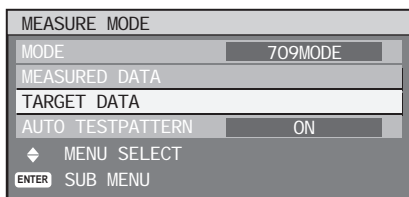

### ■ Inputting the coordinates of a desired color

9. Press ▲ ▼ to select “MODE”.
10. Press ▲ ▼ to select “7COLORS”.
11. Press ▲ ▼ to select “TARGET DATA”.
12. Press ENTER.
  - The “TARGET DATA” screen will be displayed.

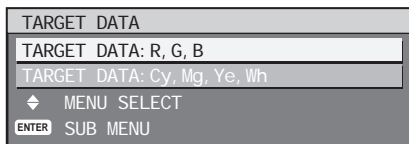

13. Press ▲ ▼ to select “R, G, B” or “Cy, Mg, Ye, Wh”.
14. Press ENTER.
  - The “TARGET DATA: R, G, B (or “Cy, Mg, Ye, Wh”)” screen will be displayed.

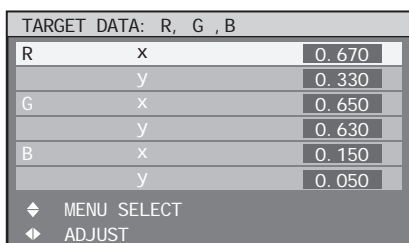

15. Press ▲ ▼ to select the desired colors, and press ◀ ▶ to input their coordinates.

16. After all the data has been input, press MENU.

### Note

- If “3COLORS” or “709MODE” has been selected as the “TARGET MODE” setting, only the 3 colors R, G and B will be input for “TARGET DATA”.
- If “709MODE” has been selected as the “TARGET MODE” setting, the 3 primary colors defined by the ITU-R BT.709 standard will be set as the target data.
- If the target data is outside the color range of the projector, the colors will not be projected correctly.

## Large Screen Correction

If watching images close up on a large screen, you can correct the colors that appear lighter on the screen so that they appear the same as the colors that would appear on a normal-sized screen.

1. Press ▲ ▼ to select “LARGE SCREEN CORRECTION”.

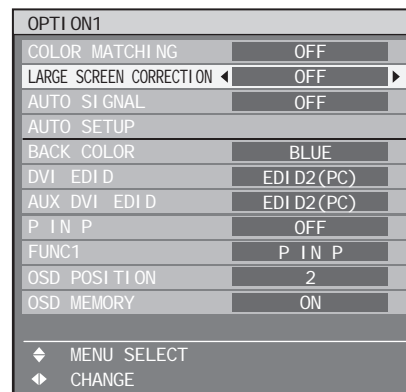

2. Press ◀ ▶ to switch “LARGE SCREEN CORRECTION”.
  - The setting will change as follows each time ◀ ▶ is pressed.

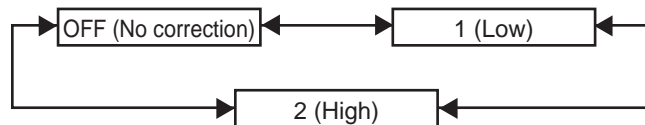

## Option1 settings (continued)

### Auto signal

When unregistered signals are to be input frequently because the unit is used at conferences or other venues, the screen display position can be adjusted automatically without having to press AUTO SETUP on the remote control each time.

#### 1. Press ▲▼ to select “AUTO SIGNAL”.

OPTI ON1	
COLOR MATCHING	OFF
LARGE SCREEN CORRECTION	OFF
AUTO SIGNAL	OFF
AUTO SETUP	
BACK COLOR	BLUE
DVI EDI D	EDI D2(PC)
AUX DVI EDI D	EDI D2(PC)
P I N P	OFF
FUNC1	P I N P
OSD POSI TION	2
OSD MEMORY	ON
◆ MENU SELECT	
◆ CHANGE	

#### 2. Press ◀▶ to switch “AUTO SIGNAL”.

- The setting will change as follows each time ◀▶ is pressed.

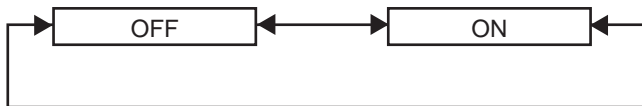

- If unregistered signals are input when “ON” is selected, auto setup will be initiated automatically.

### Automatic adjustment (Only RGB input)

Use this setting when adjusting a specific or oblong (16:9, etc.) signal.

#### 1. Press ▲▼ to select “AUTO SETUP”.

OPTI ON1	
COLOR MATCHING	OFF
LARGE SCREEN CORRECTION	OFF
AUTO SIGNAL	OFF
AUTO SETUP	
BACK COLOR	BLUE
DVI EDI D	EDI D2(PC)
AUX DVI EDI D	EDI D2(PC)
P I N P	OFF
FUNC1	P I N P
OSD POSI TION	2
OSD MEMORY	ON
◆ MENU SELECT	
ENTER SUB MENU	

#### 2. Press ENTER.

- The “AUTO SETUP” screen will be displayed.

AUTO SETUP	
MODE	DEFAULT
◀ CHANGE	
ENTER EXECUTE	

#### 3. Press ◀▶ to switch “MODE”.

- The setting will change as follows each time ◀▶ is pressed.

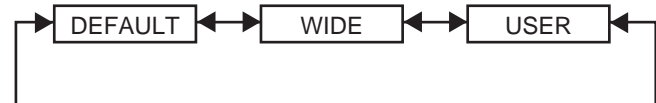

- DEFAULT:**

to receive signals of which image aspect is 4:3 or 5:4 (applicable resolution : 640 × 400, 640 × 480, 800 × 600, 832 × 624, 960 × 720, 1 024 × 768, 1 152 × 864, 1 152 × 870, 1 280 × 960, 1 280 × 1 024, 1 600 × 1 200, 1 400 × 1 050)

- WIDE:**

to receive signals of which image aspect is 16:9 (oblong) (applicable resolution : 720 × 400, 1 280 × 720, 1 280 × 800, 1 280 × 768, 1 376 × 768, 1 600 × 1 024)

- USER:**

to receive signals of specific horizontal resolution (number of horizontally displayed dots)

#### 4. If “User” is selected, press ◀▶ to enter the horizontal resolution of signal source into “DISPLAY DOTS”.

#### 5. Press ENTER.

- Execute automatic adjustment. A message “PROGRESS...” appears during automatic adjustment. When the adjustment is complete, the system returns to the input screen.

## Back Color

This sets the color for the projection screen when no signals are being input.

1. Press ▲▼ to select “BACK COLOR”.

OPTI ON1	
COLOR MATCHI NG	OFF
LARGE SCREEN CORRECTION	OFF
AUTO SI GNAL	OFF
AUTO SETUP	
BACK COLOR	BLUE
DVI EDI D	EDI D2(PC)
AUX DVI EDI D	EDI D2(PC)
P I N P	OFF
FUNC1	P I N P
OSD POSI TI ON	2
OSD MEMORY	ON

◆ MENU SELECT  
◆ CHANGE

2. Press ◀▶ to switch “BACK COLOR”.

- The setting will change as follows each time ◀▶ is pressed.

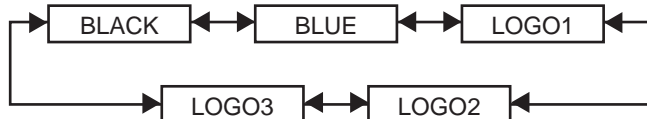

- **BLACK:**  
The entire projection area will appear black.
- **BLUE:**  
The entire projection area will appear blue.
- **LOGO1:**  
The picture registered by the user will be projected in the projection area.
- **LOGO2:**  
The picture registered by the user will be projected in the projection area.
- **LOGO3:**  
The Panasonic logo is projected.

### Note

- Separate software is required in order to create the pictures to use for “LOGO1” and “LOGO2”. Consult your dealer.

## DVI EDID

Select the EDID mode setting that corresponds to the device to be connected.

1. Press ▲▼ to select “DVI EDID”.

OPTI ON1	
COLOR MATCHI NG	OFF
LARGE SCREEN CORRECTION	OFF
AUTO SI GNAL	OFF
AUTO SETUP	
BACK COLOR	BLUE
DVI EDI D	EDI D2(PC)
AUX DVI EDI D	EDI D2(PC)
P I N P	OFF
FUNC1	P I N P
OSD POSI TI ON	2
OSD MEMORY	ON

◆ MENU SELECT  
◆ CHANGE

2. Press ◀▶ to switch “DVI EDID”.

- The setting will change as follows each time ◀▶ is pressed.

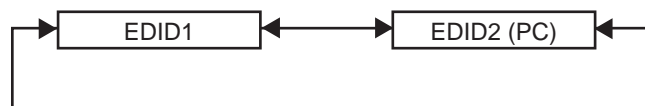

- **EDID1 (Input signal formats supported) :**  
480p, 576p, 720/60p, 720/59.94p, 720/50p, 1 080/60i, 1 080/59.94i, 1 080/50i, 1 080/24sF, 1 080/23.98sF, 1 080/30p, 1 080/29.97p, 1 080/25p, 1 080/24p, 1 080/23.98p, 1 080/50p, 1 080/59.94p, 1 080/60p
- **EDID2 (Input signal formats supported) :**  
Displayable resolution:  
VGA-UXGA (non-interlace)  
Dot clock frequency: 25 MHz - 162 MHz

### Note

- Interlace signals are not supported even when the EDID2 (PC) mode is selected.



## Option1 settings (continued)

### AUX DVI EDID (Only when the optional input module is installed)

Select the EDID mode setting that corresponds to the device to be connected.

#### 1. Press ▲▼ to select “AUX DVI EDID”.

OPTI ON1	
COLOR MATCHING	OFF
LARGE SCREEN CORRECTION	OFF
AUTO SIGNAL	OFF
AUTO SETUP	
BACK COLOR	BLUE
DVI EDID	EDI D2(PC)
AUX DVI EDID	EDI D2(PC)
P IN P	OFF
FUNC1	P IN P
OSD POSITION	2
OSD MEMORY	ON
◆ MENU SELECT	
◆ CHANGE	

#### 2. Press ◀▶ to switch “AUX DVI EDID”.

- The setting will change as follows each time ◀▶ is pressed.

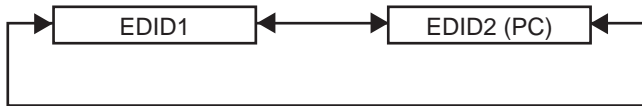

- EDID1 (Input signal formats supported) :**  
480p, 576p, 720/60p, 720/59.94p, 720/50p, 1 080/60i, 1 080/59.94i, 1 080/50i, 1 080/24sF, 1 080/23.98sF, 1 080/30p, 1 080/29.97p, 1 080/25p, 1 080/24p, 1 080/23.98p, 1 080/50p, 1 080/59.94p, 1 080/60p
- EDID2 (Input signal formats supported) :**  
Displayable resolution:  
VGA-UXGA (non-interlace)  
Dot clock frequency: 25 MHz - 162 MHz

#### Note

- Interlace signals are not supported even when the EDID2 (PC) mode is selected.

## P IN P

This item is used to set the condition of the Picture-In-Picture.

#### 1. Press ▲▼ to select “P IN P”.

OPTI ON1	
COLOR MATCHING	OFF
LARGE SCREEN CORRECTION	OFF
AUTO SIGNAL	OFF
AUTO SETUP	
BACK COLOR	BLUE
DVI EDID	EDI D2(PC)
AUX DVI EDID	EDI D2(PC)
P IN P	OFF
FUNC1	P IN P
OSD POSITION	2
OSD MEMORY	ON
◆ MENU SELECT	
◆ CHANGE	

#### 2. Press ◀▶ to switch “P IN P”.

- The setting will change as follows each time ◀▶ is pressed.

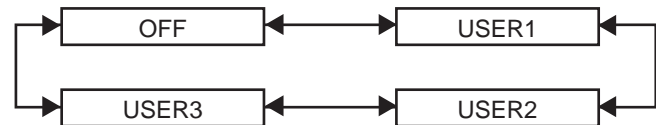

- OFF:**  
P IN P will not be set.
- USER1, USER2, USER3:**  
The input signals to be projected in the main window and sub-window can be set.

#### 3. Press ENTER.

- The “P IN P:USER1”, “P IN P:USER2” or “P IN P:USER3” screen will be displayed.

P IN P: USER1	
MAI N WI NDOW	RGB1
SI ZE	
POSI TI ON	
SUB WI NDOW	VI DEO
SI ZE	
POSI TI ON	
FRAME LOCK	MAI N WI NDOW
TYPE	MAI N WI NDOW
◆ MENU SELECT	
◆ CHANGE	

**4. Press ▲ ▼ to select the item to be set, and press ◀ ▶ to switch the setting.**

**• MAIN WINDOW:**

The input terminal for the main window is displayed. The ◀ ▶ buttons can be used to select the input terminal.

**SIZE:** The user can specify the display size of the main window between 10 % and 100 %.

**POSITION:** The user can specify the display position of the main window on the screen.

**• SUB WINDOW:**

The input terminal for the SUB WINDOW is displayed. The ◀ ▶ buttons can be used to select the input terminal.

**SIZE:** The user can specify the display size of the subwindow between 10 % and 100 %.

**POSITION:** The user can specify the display position of the subwindow on the screen.

**• FRAME LOCK:**

The user can select the window to apply frame lock.

**“MAIN WINDOW”:** Frame lock is set for the input signals specified for the main window.

**“SUB WINDOW”:** Frame lock is set for the input signals specified for the subwindow.

**• TYPE:**

The user can select the window that is displayed by priority when two windows overlap.

**“MAIN WINDOW”:** The main window is displayed by priority.

**“SUB WINDOW”:** The subwindow is displayed by priority.

**Note**

- The P IN P function is not available depending on the input signals and the selected input terminals. Refer to “List of P IN P” for details. (p. 119)
- The main window’s picture adjustment values such as the picture mode, gamma selection and color temperature setting for the main window will be applied.
- In the normal screen (when the menu is not displayed), the ◀ ▶ buttons can be used to switch the size and position of the main window and subwindow when the P IN P function is on.

## Setting FUNC1

The user can specify the function of the “FUNC 1” button on the remote control.

**1. Press ▲ ▼ to select “FUNC1”.**

OPTI ON1	
COLOR MATCHI NG	OFF
LARGE SCREEN CORRECTION	OFF
AUTO SI GNAL	OFF
AUTO SETUP	
BACK COLOR	BLUE
DVI EDI D	EDI D2(PC)
AUX DVI EDI D	EDI D2(PC)
P IN P	OFF
FUNC1	◀ P IN P ▶
OSD POSI TI ON	2
OSD MEMORY	ON
◆ MENU SELECT	
◆ CHANGE	

**2. Press ◀ ▶ to switch “FUNC1”.**

- The setting will change as follows each time ◀ ▶ is pressed.

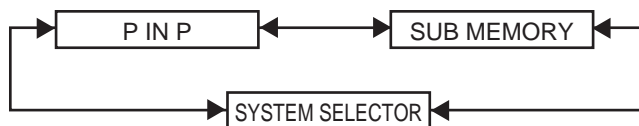

- **P IN P:**  
Enables setting of P IN P to “OFF”, “USER 1”, “USER 2”, or “USER 3. (p. 72)
- **SUB MEMORY:**  
The sub memory can be switched. (p. 41)
- **SYSTEM SELECTOR:**  
Allows the system selector to be switched. (p. 54)

## Option1 settings (continued)

### Position of on-screen indications

The user can specify the position of the on-screen indications.

#### 1. Press ▲▼ to select “OSD POSITION”.

OPTI ON1	
COLOR MATCHI NG	OFF
LARGE SCREEN CORRECTI ON	OFF
AUTO SI GNAL	OFF
AUTO SETUP	
BACK COLOR	BLUE
DVI EDI D	EDI D2(PC)
AUX DVI EDI D	EDI D2(PC)
P I N P	OFF
FUNC1	P I N P
OSD POSI TI ON	2
OSD MEMORY	ON
◆ MENU SELECT	
◆ CHANGE	

#### 2. Press ◀▶ to switch “OSD POSITION”.

- The setting will change as follows each time ◀▶ is pressed.

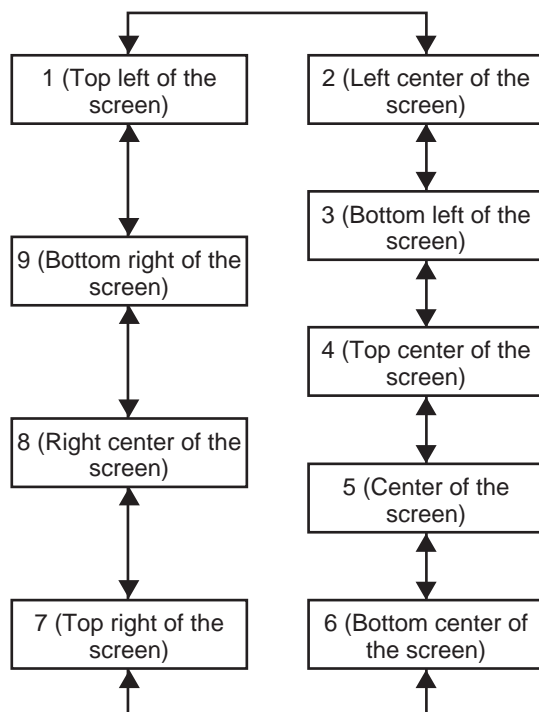

### OSD memory

This lets you save the cursor position in on-screen menus.

#### 1. Press ▲▼ to select “OSD MEMORY”.

OPTI ON1	
COLOR MATCHI NG	OFF
LARGE SCREEN CORRECTI ON	OFF
AUTO SI GNAL	OFF
AUTO SETUP	
BACK COLOR	BLUE
DVI EDI D	EDI D2(PC)
AUX DVI EDI D	EDI D2(PC)
P I N P	OFF
FUNC1	P I N P
OSD POSI TI ON	2
OSD MEMORY	◀ ON ▶
◆ MENU SELECT	
◆ CHANGE	

#### 2. Press ◀▶ to switch “OSD MEMORY”.

- The setting will change as follows each time ◀▶ is pressed.

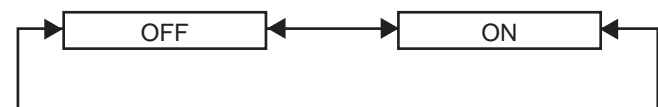

# Option2 settings

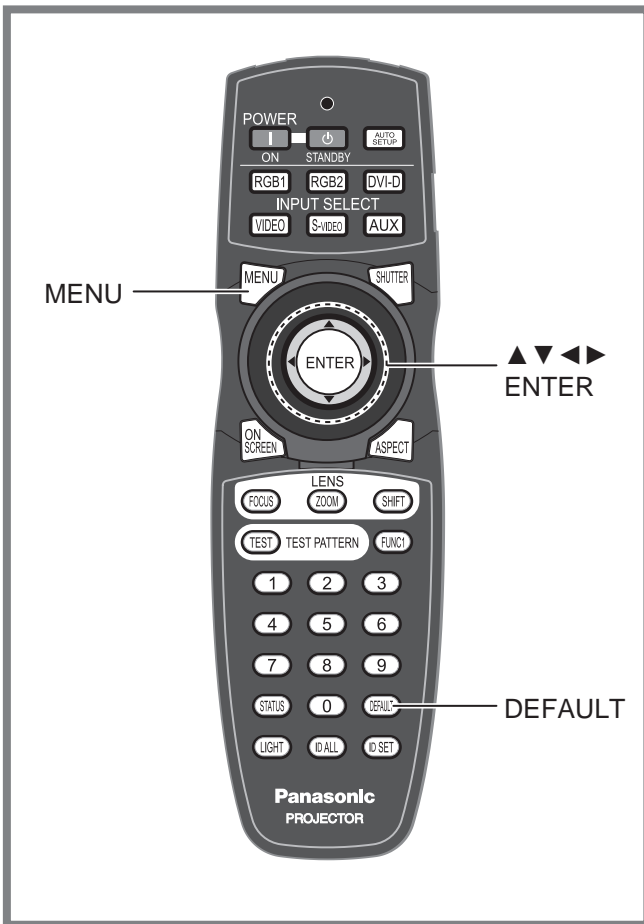

This menu can be used to make a variety of picture and projector settings.

**MENU** — Press to display the **MAIN MENU** screen.

**ENTER** — Press to select **“OPTION2”**.

— Press to display the **“OPTION2”** menu.

MAIN MENU	
PICTURE	
POSITION	
ADVANCED MENU	
DISPLAY LANGUAGE	
OPTI ON1	
<b>OPTI ON2</b>	
TEST PATTERN	
SIGNAL LIST	
NETWORK	
SECURITY	
◆ MENU SELECT	
ENTER SUB MENU	

## Setting a projector ID

The projector has an ID number setting function that helps the user to control two or more projectors either simultaneously or separately with a single remote control. **The ID number is set to “ALL” by default.** Hence the ID number need not be set when only one projector is used.

### 1. Press ▲▼ to select “PROJECTOR ID”.

OPTI ON2	
PROJECTOR ID	2
INSTALLATION	FRONT-F
ALTI TUDE	LOW
DI RECTI ON	H
LAMP SELECT	QUAD
LAMP RELAY	OFF
RS-232C	
SYSTEM I NFORMATION	
AIR FILTER CLEANING	
DATE AND TIME	
STARTUP LOGO	LOGO1
PASSWORD	
◆ MENU SELECT	
◆ CHANGE	

### 2. Press ◀▶ to switch “PROJECTOR ID”.

- The setting will change as follows each time ◀▶ is pressed.



### 3. Press MENU twice.

- This concludes the setting procedure and the on-screen indications disappear and the normal screen appears again.

#### Note

- The ID number can be set to “ALL”, or selected from “1” to “64”.
- If the projectors are given ID numbers, their remote controls must be assigned the same ID numbers, respectively.
- If the ID number of a projector is set to “ALL”, it can be controlled by the remote control or the PC with any ID number. If multiple projectors are used and some of them have their IDs set to “ALL”, they cannot be controlled separately from the projectors with other ID numbers. For details on remote control ID setting, see page 18.

## Option2 settings (continued)

### Installation Setting

A projection scheme can be chosen depending on the installation of the projector. If the picture is shown upside down or in reverse, change the projection scheme.

- Select the setting by displaying the on-screen indications using buttons of the remote control or the control panel on the main unit.

#### 1. Press ▲▼ to select “INSTALLATION”.

OPTI ON2	
PROJECTOR I D	2
I NSTALLATI ON	◀ FRONT-F ▶
ALTI TUDE	LOW
DI RECTI ON	H
LAMP SELE CT	QUAD
LAMP RELAY	OFF
RS-232C	
SYSTEM I NFORMATI ON	
AIR FI LTER CLEANI NG	
DATE AND TI ME	
STARTUP LOGO	LOG01
PASSWORD	
◆ MENU SELE CT	
◆ CHANGE	

#### 2. Press ◀▶ to switch “INSTALLATION”.

- The setting will change as follows each time ◀▶ is pressed.

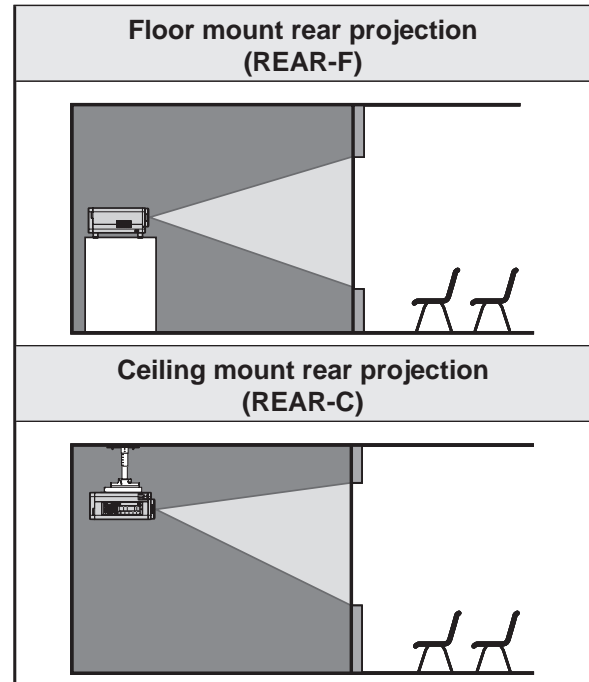
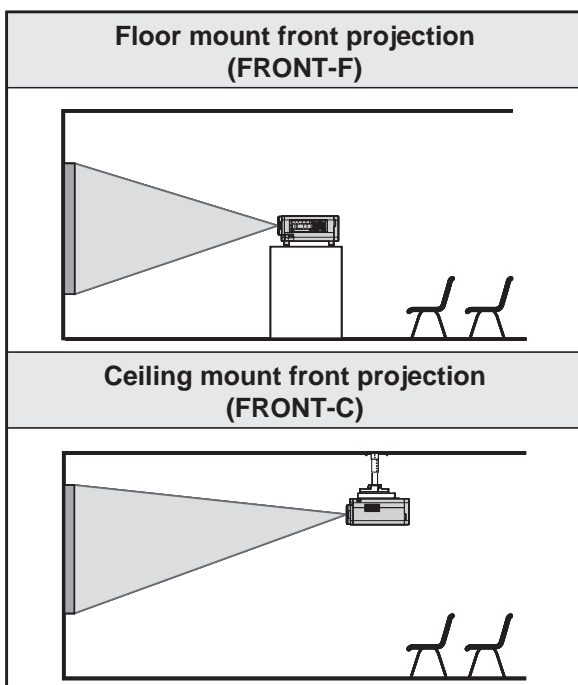
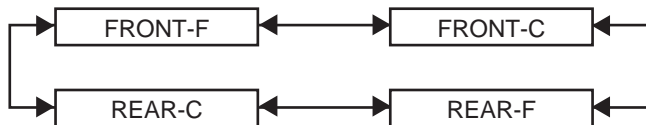

#### 3. Press MENU twice.

- The on-screen indications disappear and the normal screen appears again.

### Altitude

When using the projector over 1 400 m above sea level, set to “HIGH”.

#### 1. Press ▲▼ to select “ALTITUDE”.

OPTI ON2	
PROJECTOR I D	2
I NSTALLATI ON	FRONT-F
ALTI TUDE	◀ LOW ▶
DI RECTI ON	H
LAMP SELE CT	QUAD
LAMP RELAY	OFF
RS-232C	
SYSTEM I NFORMATI ON	
AIR FI LTER CLEANI NG	
DATE AND TI ME	
STARTUP LOGO	LOG01
PASSWORD	
◆ MENU SELE CT	
◆ CHANGE	

#### 2. Press ◀▶ to switch “ALTITUDE”.

- The setting will change as follows each time ◀▶ is pressed.

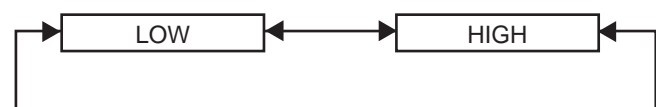

## Direction

The fan is controlled in accordance with the setup angle.

1. Press ▲ ▼ to select “DIRECTION”.

OPTI ON2	
PROJECTOR I D	2
I NSTALLATI ON	FRONT-F
ALTI TUDE	LOW
DI RECTI ON	H
LAMP SELECT	QUAD
LAMP RELAY	OFF
RS-232C	
SYSTEM I NFORMATI ON	
AIR FILTER CLEANI NG	
DATE AND TI ME	
STARTUP LOGO	LOGO1
PASSWORD	
◆ MENU SELECT	
◆ CHANGE	

2. Press ◀ ▶ to switch “DIRECTION”.

- The setting will change as follows each time ◀ ▶ is pressed.

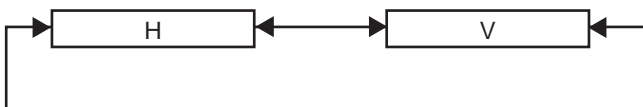

- **H (HORIZONTAL):**  
This is the standard setup.
- **V (VERTICAL):**  
Select this if the projector is tilted at a large vertical angle (an angle which exceeds 30° from the horizontal).

## Output resolution (PT-D10000U only)

Pictures projected onto a screen (for SXGA) with a 5:4 aspect ratio can be displayed with the SXGA resolution.

1. Press ▲ ▼ to select “OUTPUT RESOLUTION”.

OPTI ON2		1/2
PROJECTOR I D	2	
I NSTALLATI ON	FRONT-F	
ALTI TUDE	LOW	
DI RECTI ON	H	
OUTPUT RESOLUTI ON	SXGA+	
LAMP SELECT	QUAD	
LAMP RELAY	OFF	
RS-232C		
SYSTEM I NFORMATI ON		
AIR FILTER CLEANI NG		
DATE AND TI ME		
STARTUP LOGO	LOGO1	
◆ MENU SELECT		
◆ CHANGE		

2. Press ◀ ▶ to switch “OUTPUT RESOLUTION”.

- The setting will change as follows each time ◀ ▶ is pressed.



- **SXGA+ (1 400 × 1 050):**  
For projecting pictures onto a screen with an aspect ratio of 4:3.
- **SXGA (1 280 × 1 024):**  
For projecting pictures onto a screen with an aspect ratio of 5:4.

## Option2 settings (continued)

### Lamp select

This lets you switch the four light source lamps to one of four brightnesses in accordance with the operating conditions and purpose of use.

#### 1. Press ▲▼ to select “LAMP SELECT”.

OPTI ON2	
PROJECTOR ID	2
INSTALLATI ON	FRONT-F
ALTI TUDE	LOW
DI RECTI ON	H
LAMP SELECT	◀ QUAD ▶
LAMP RELAY	OFF
RS-232C	
SYSTEM I NFORMATI ON	
AIR FILTER CLEANI NG	
DATE AND TIME	
STARTUP LOGO LOG01	
PASSWORD	
◆ MENU SELECT	
◆ CHANGE	ENTER EXECUTE

#### 2. Press ◀▶ to switch “LAMP SELECT”.

- The setting will change as follows each time ◀▶ is pressed.

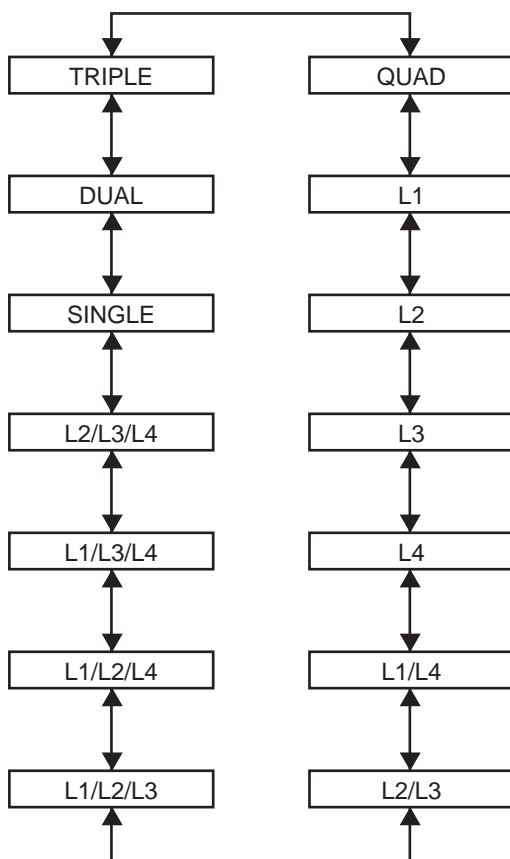

- “**QUAD**” : The four lamps illuminate.
- “**L1**” : One lamp illuminates. (Lamp unit 1 takes priority.)
- “**L2**” : One lamp illuminates. (Lamp unit 2 takes priority.)
- “**L3**” : One lamp illuminates. (Lamp unit 3 takes priority.)
- “**L4**” : One lamp illuminates. (Lamp unit 4 takes priority.)
- “**L1/L4**” : Two lamps illuminate. (Lamp unit 1 and 4 take priority.)
- “**L2/L3**” : Two lamps illuminate. (Lamp unit 2 and 3 take priority.)
- “**L1/L2/L3**” : Three lamps illuminate. (Lamp units 1, 2 and 3 take priority.)
- “**L1/L2/L4**” : Three lamps illuminate. (Lamp units 1, 2 and 4 take priority.)
- “**L1/L3/L4**” : Three lamps illuminate. (Lamp units 1, 3 and 4 take priority.)
- “**L2/L3/L4**” : Three lamps illuminate. (Lamp units 2, 3 and 4 take priority.)
- “**SINGLE**” : One of the lamps illuminates. (The lamp unit with the shortest operating time is selected automatically.)
- “**DUAL**” : Two lamps illuminate. (The lamp units with the shortest operating time out of lamp units 1 and 4 or 2 and 3 are selected automatically.)
- “**TRIPLE**” : Three lamps illuminate. (The lamp unit with the shortest operating time is selected automatically.)

#### 3. Press ENTER.

##### Note

- For settings other than “QUAD”, any lamp which is malfunctioning or which has a cumulative operating time that exceeds 2 000 hours will be turned off and the other lamps will be turned on. If “QUAD” is selected, any lamp which is malfunctioning or which has a cumulative operating time that exceeds 2 000 hours will be turned off and only the lamps which have a cumulative operating time of less than 2 000 hours will be turned on. In addition, if the cumulative operating times for all lamps exceed 2 000 hours, the projector will switch to standby mode.
- Lamp units which are not turned on should still be installed to the projector.
- If the lamp selection is changed, picture is muted during lamp switching execution. (7-25 sec.)

## Lamp relay

If using the projector for a continuous period of 24 hours or more, this setting can be used to automatically switch the lamps that are turned on in order to reduce the lamp deterioration that can occur as a result of continuous use.

### 1. Press ▲▼ to select “LAMP RELAY”.

OPTI ON2	
PROJECTOR ID	2
INSTALLATION	FRONT-F
ALTI TUDE	LOW
DI RECTI ON	H
LAMP SELECT	QUAD
LAMP RELAY	OFF
RS-232C	
SYSTEM I NFORMATION	
AI R FI LTER CLEANI NG	
DATE AND TI ME	
STARTUP LOGO	LOG01
PASSWORD	
◆	MENU SELECT
◆	CHANGE

### 2. Press ◀▶ to switch “LAMP RELAY”.

- The time interval for lamps to be switched will change as shown in the diagram below each time ◀▶ is pressed.

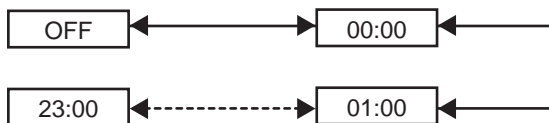

#### Note

- When “SINGLE”, “DUAL” or “TRIPLE” is selected as the “LAMP SELECT” setting, the lamps will switch in accordance with the setting time. If “QUAD” is selected, three lamps will illuminate for 8 hours after the specified time.
- The setting time will be the local time. (p. 81)

## RS-232C setting

This sets communication parameters for the projector.

### 1. Press ▲▼ to select “RS-232C”.

OPTI ON2	
PROJECTOR ID	2
INSTALLATION	FRONT-F
ALTI TUDE	LOW
DI RECTI ON	H
LAMP SELECT	QUAD
LAMP RELAY	OFF
RS-232C	
SYSTEM I NFORMATION	
AI R FI LTER CLEANI NG	
DATE AND TI ME	
STARTUP LOGO	LOG01
PASSWORD	
◆	MENU SELECT
ENTER	SUB MENU

### 2. Press ENTER.

- The “RS-232C” screen will be displayed.

RS-232C	
SERIAL I N	RS-232C
(I N) BAUDRATE	38400
(I N) PARI TY	EVEN
(O UT) BAUDRATE	38400
(O UT) PARI TY	EVEN
VPS SYSTEM	MASTER
GROUP	A
MASTER	
◆	MENU SELECT
◆	CHANGE

### 3. Press ▲▼ to select “SERIAL IN”.

### 4. Press ◀▶ to switch “SERIAL IN”.

- The setting will change as follows each time ◀▶ is pressed.

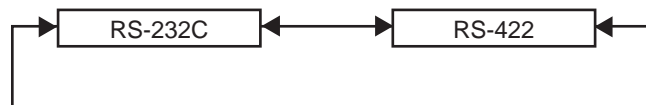

### 5. Press ▲▼ to select communication conditions.

### 6. Press ◀▶ to confirm the setting.

### 7. Press MENU three times.

- The on-screen indications disappear, and the system returns to the normal screen.



## Option2 settings (continued)

### System information

Displays the system information of the projector.

1. Press ▲▼ to select “SYSTEM INFORMATION”.

OPTI ON2	
PROJECTOR ID	2
INSTALLATI ON	FRONT-F
ALTI TUDE	LOW
DI RECTI ON	H
LAMP SELECT	QUAD
LAMP RELAY	OFF
RS-232C	
SYSTEM I NFORMATI ON	
AIR FILTER CLEANI NG	
DATE AND TIME	
STARTUP LOGO	LOG01
PASSWORD	
◆ MENU SELECT	
ENTER SUB MENU	

2. Press ENTER.

- The “SYSTEM INFORMATION” screen will be displayed.

SYSTEM I NFORMATI ON	
ROM VERSION	1.00.00
NETWORK VERSION	1.00
SUB VERSION	1.00
PROJECTOR RUNTIME	1000h
LAMP1 RUNTIME	500h
LAMP2 RUNTIME	500h
LAMP3 RUNTIME	500h
LAMP4 RUNTIME	500h
◆ CHANGE	

3. Press ◀▶ to move to the next page.

SYSTEM I NFORMATI ON	
ON COUNT	
POWER ON TIMES	100
LAMP 1 ON	50
LAMP 2 ON	50
LAMP 3 ON	50
LAMP 4 ON	50
SHUTTER	9( 0)
AIR FILTER CLEANI NG	3( 0)
AUX	MD77DV: DN
NUMBER OF ENTRY SIGNAL	1/96
◆ CHANGE	

### Cleaning the air filter

This can be used to set air filter cleaning.

1. Press ▲▼ to select “AIR FILTER CLEANING”.

OPTI ON2	
PROJECTOR ID	2
INSTALLATI ON	FRONT-F
ALTI TUDE	LOW
DI RECTI ON	H
LAMP SELECT	QUAD
LAMP RELAY	OFF
RS-232C	
SYSTEM I NFORMATI ON	
AIR FILTER CLEANI NG	
DATE AND TIME	
STARTUP LOGO	LOG01
PASSWORD	
◆ MENU SELECT	
ENTER SUB MENU	

2. Press ENTER.

- The “AIR FILTER CLEANING” screen will be displayed.
- You can select the automatic cleaning time (“TIME”) and also force cleaning to be carried out immediately (“EXECUTE”).

AIR FILTER CLEANI NG	
TIME	◀ 00:00 ▶
EXECUTE	
◆ MENU SELECT	
◆ CHANGE	

3. Press ▲▼ to select “TIME”.

- Select “TIME” and then set the time for automatic cleaning to be carried out.
- If you would like cleaning to be carried out straight away, select “EXECUTE” and then press ENTER.

4. Press ◀▶ to switch “TIME”.

- The setting will change as follows each time ◀▶ is pressed.

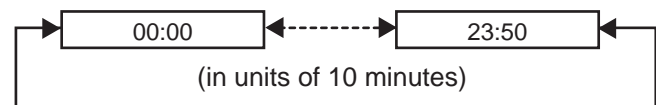

- The default setting is “00:00” (midnight).

Example: When the default setting is in use, automatic cleaning will start at 00:00 if the projector is in projection mode. If the time is set to 7:00, automatic cleaning will start at that time if the projector is in projection mode.

## Note

- The air filter cleaning monitor (FILTER CLEANING) will flash blue while cleaning of the air filter is in progress. If there is a problem with the air filter, the air filter cleaning monitor (FILTER CLEANING) will light red.
- The time taken for cleaning is approximately 30 to 40 seconds.
- The setting time will be the local time. (p. 81)
- Automatic cleaning will not be carried out if the projector is in standby mode.
- If the projector is not in projection mode when the setting time is reached, automatic cleaning will not be carried out.
- Automatic cleaning will not be carried out if 24 hours have not yet elapsed since cleaning was last carried out (either by automatic cleaning or forced cleaning).

Example: If the setting time is 7:00 and forced cleaning is carried out at 9:00, then automatic cleaning will not be carried out at 7:00 on the following day.

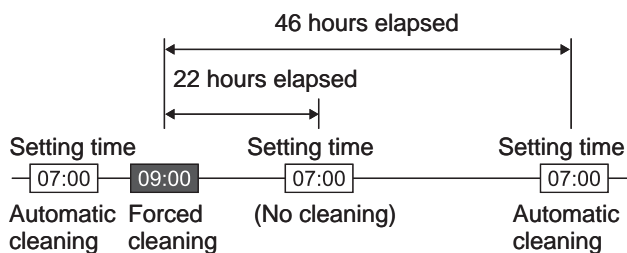

- If the time is set to a time which is within 24 hours from the last time cleaning was carried out, automatic cleaning will not be carried out the next time the setting time is reached. Instead, cleaning will be carried out when the setting time is reached on the following day.

Example: If cleaning was carried out at 10:00, and the cleaning time setting is then changed to 20:00, automatic cleaning will be carried out at 20:00 on the following day.

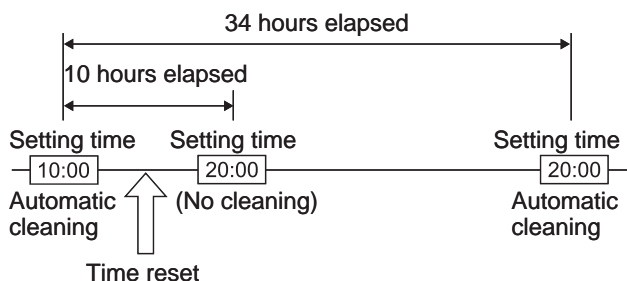

- When projection starts (when the power is turned on), automatic cleaning will be carried out immediately if more than 24 hours have elapsed since cleaning was last carried out.

## Setting the date and time

This lets you set the time zone and the current date and time for the projector's internal clock.

1. Press **▲ ▼** to select "DATE AND TIME".

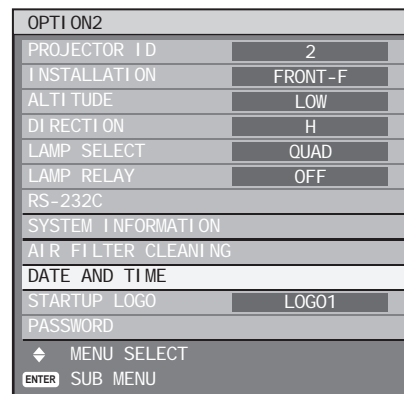

2. Press **ENTER**.

- The "DATE AND TIME" screen will be displayed.

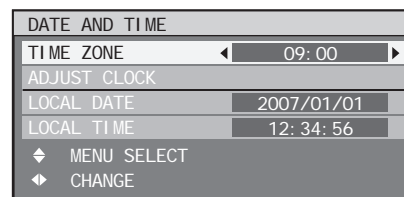

3. Press **▲ ▼** to select "TIME ZONE".

4. Press **◀ ▶** to switch "TIME ZONE".

5. Press **▲ ▼** to select "ADJUST CLOCK".

6. Press **ENTER**.

- The "ADJUST CLOCK" screen will be displayed.

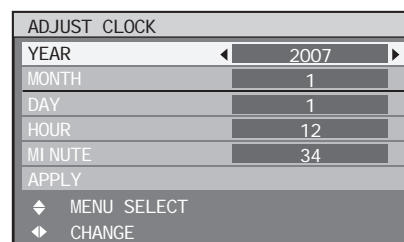

7. Press **▲ ▼** to select the item to be set, and use **◀ ▶** to set the local time.

8. Use **▲ ▼** to select "APPLY", and then press **ENTER**.

- This completes setting of the time.

## Option2 settings (continued)

### Setting the startup logo

This sets the startup logo that is projected when the power is turned on.

#### 1. Press ▲▼ to select “STARTUP LOGO”.

OPTI ON2	
PROJECTOR ID	2
INSTALLATI ON	FRONT-F
ALTI TUDE	LOW
DI RECTI ON	H
LAMP SELECT	QUAD
LAMP RELAY	OFF
RS-232C	
SYSTEM I NFORMATI ON	
AIR FILTER CLEANI NG	
DATE AND TI ME	
STARTUP LOGO	◀ LOG01 ▶
PASSWORD	
◆ MENU SELECT	
◆ CHANGE	

#### 2. Press ◀▶ to switch “STARTUP LOGO”.

- The setting will change as follows each time ◀▶ is pressed.

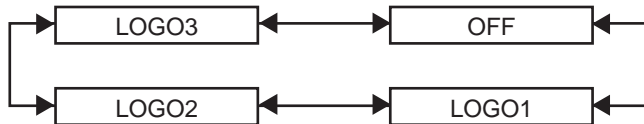

- LOGO3:**  
The Panasonic logo and DIGITAL PROJECTOR logo are projected.
- OFF:**  
No startup logo is projected.
- LOGO1:**  
The picture registered by the user will be projected.
- LOGO2:**  
The picture registered by the user will be projected.

#### Note

- Separate software is required in order to create the pictures to use for “LOGO1” and “LOGO2”. Consult your dealer.

### Password

This function is used by a service person.

Input the password with the numeric buttons (0 to 9) of the remote control and press ENTER to confirm the entry.

# Displaying the internal test pattern

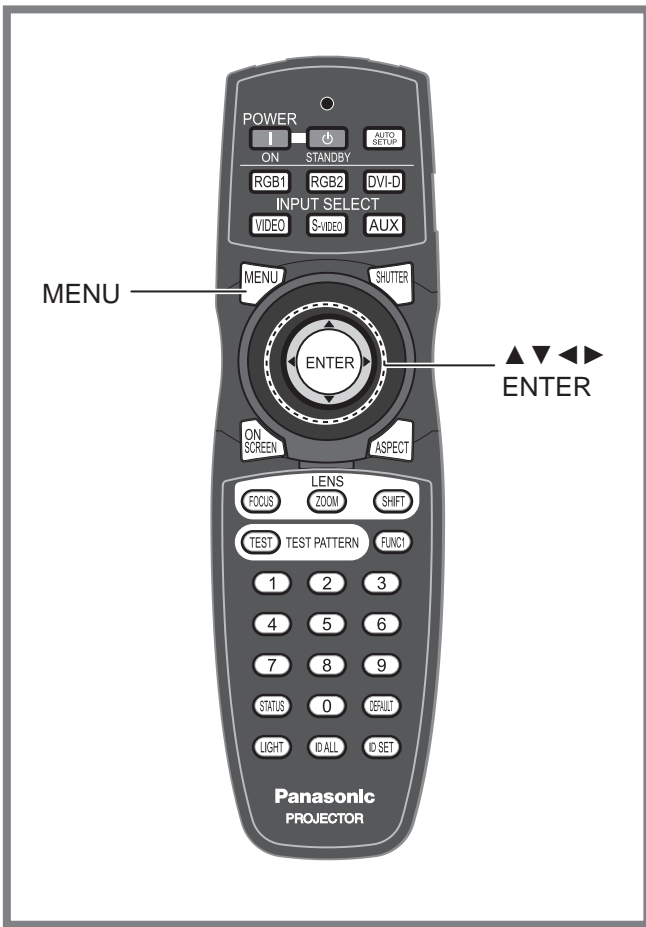

## Test pattern

Results of adjustment on the image, picture quality, position, size and other factors will not be reflected in test patterns. Be sure to display the input signal before performing various kinds of setting.



1. Press ◀▶ to search through the various types of test patterns.

### ■ Cycle of displayed internal test patterns

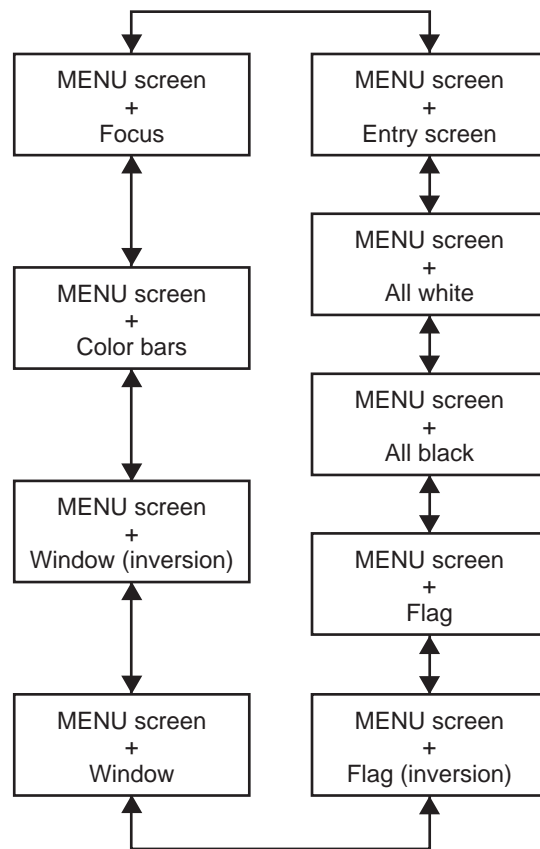
The setting will change as follows each time ◀▶ is pressed.



The projector has 8 types of internal test patterns to check the condition of the set.

-  Press to display the **MAIN MENU** screen.
-  Press to select **"TEST PATTERN"**.
-  Press to display the **"TEST PATTERN"** screen.

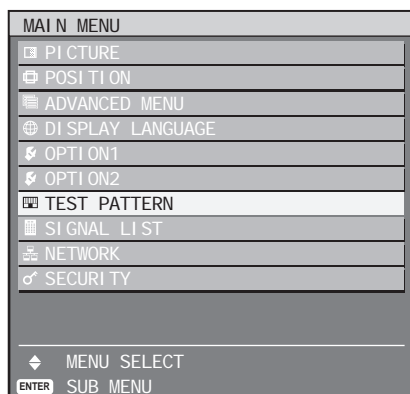

# How to use network function

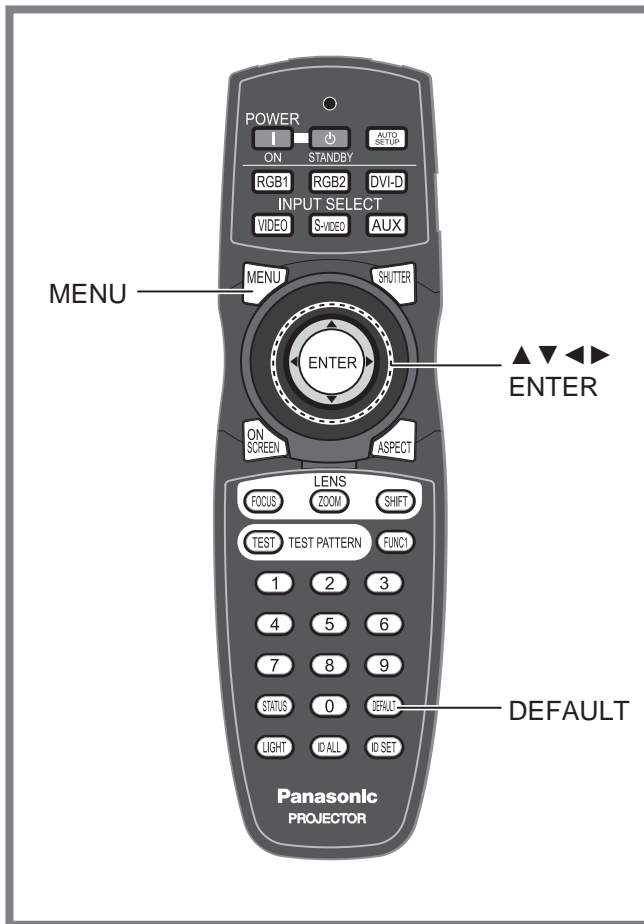

## Initial setting of network function

Make the initial network function settings before using the network functions.

1. Press ▲▼ to select items, and press ENTER to change the setting.

NETWORK	
HOST NAME	PROJECTOR
DHCP	OFF
IP ADDRESS	192.168. 0. 8
PORT	80
SUBNET MASK	255. 255. 255. 0
GATEWAY	192.168. 0. 1
STATUS	
STORE	
◆ MENU SELECT	
ENTER	ADJUST

- **HOST NAME (Display of host name and setting) :**  
Make alteration when to use the DHCP server.
- **DHCP (DHCP client function) :**  
Set the DHCP item to ON when to acquire an IP address automatically using the DHCP server. Set to OFF if DHCP server is not used. Enter the IP address if DHCP server is not used.
- **IP ADDRESS (Display of IP address and setting) :**  
Enter the IP address if DHCP server is not used.
- **PORT (Display and setting of the port number for connection with the Web browser.) :**  
Number 80 is normally used.
- **SUBNET MASK (Displaying and setting the subnet mask) :**  
If not using a DHCP server, enter the subnet mask.
- **GATEWAY (Display of gateway address and setting) :**  
Enter the gateway address if DHCP server is not used.

2. Press ▲▼ to select “STORE”, and press ENTER.

### Note

- Before using the DHCP server, make sure the DHCP server is already functioning.
- For details of IP address, net mask, and gateway, ask the network administrator.

This allows you to use network functions.

- Press to display the **MAIN MENU** screen.
- Press to select **“NETWORK”**.
- Press to display the **“NETWORK”** menu.

MAIN MENU	
PICTURE	
POSITION	
ADVANCED MENU	
DISPLAY LANGUAGE	
OPTION1	
OPTION2	
TEST PATTERN	
SIGNAL LIST	
NETWORK	
SECURITY	
◆ MENU SELECT	
ENTER	SUB MENU

## Returning the network function setting back to the factory setting

The user can return all settings of network function such as IP address, password and E-mail setting to the factory setting.

### 1. Press ▲ ▼ to select “STORE”.

NETWORK	
HOST NAME	PROJECTOR
DHCP	OFF
IP ADDRESS	192.168. 0. 8
PORT	80
SUBNET MASK	255.255.255. 0
GATEWAY	192.168. 0. 1
STATUS	
STORE	
◆ MENU SELECT	
ENTER	STORE

### 2. Hold down DEFAULT for 3 seconds.

- A confirmation screen will be displayed.  
To cancel, press MENU. The “NETWORK SETTING” screen will be displayed.

WOULD YOU LIKE TO CANCEL ALL NETWORK SETTINGS BACK TO FACTORY SHIPMENT STATUS?	
OK	CANCEL
◆ CHANGE	
ENTER	EXECUTE

### 3. Press ENTER.

- The IP address, password, E-mail settings and all the other network function settings are returned to the factory defaults.

## How to use network function (continued)

### Network connections

The projector is equipped with network functions, and web browser controls can be used to carry out the following operations from a computer.

- Projector settings and adjustments
- Projector status display
- Transmission of E-mail messages if there is a problem with the projector

#### Note

- A LAN cable is required to use the network function.

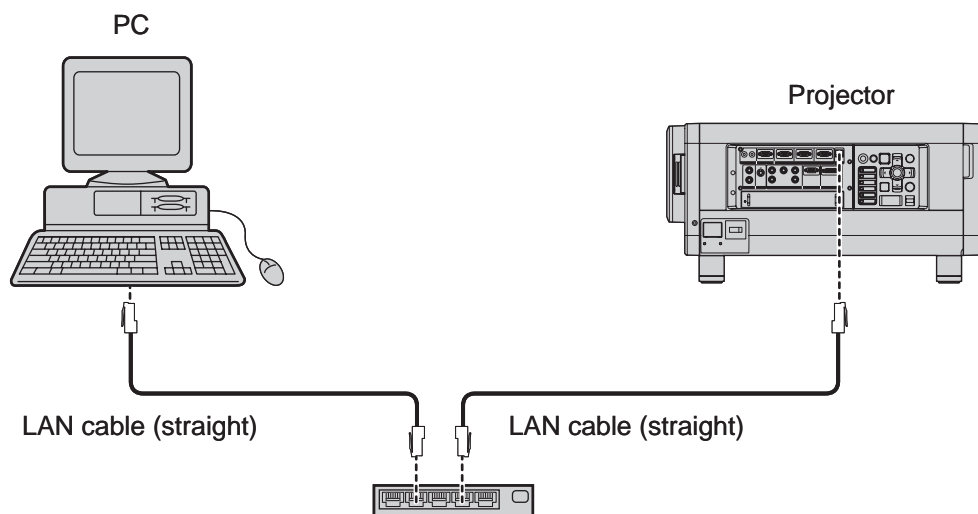

- A Web browser is required to use this function. Make sure that a Web browser is available in the system.
- Use Microsoft Windows 98SE/Me/NT4.0/2000/XP for the OS of your personal computer.
- The Web browser should be Internet Explorer 6.0 or later or Netscape Communicator 7.0 or later.
- To use the E-mail function, communication with E-mail server must be established. Make sure that E-mail feature is available in your system.
- Use a straight insulated LAN cable which supports category 5 or above.
- The length of LAN cable must be 100 m or shorter.

### Name and function of network function parts

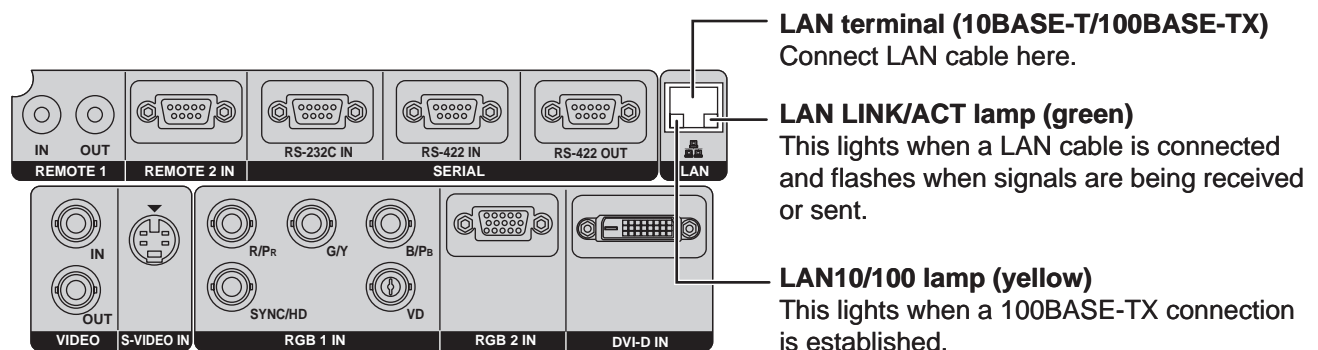

#### Attention

- If the LAN terminal is touched by electrostatically charged hands (or body), failure may be caused by the discharge of static electricity.  
Be careful not to touch metallic part of LAN terminal or LAN cable.

## Accessing from the Web browser

1. Activate the Web browser in the personal computer.
2. Enter the IP address set by the projector into the URL input field of the Web browser.



3. Enter your “User Name” and “Password”.

- At the time of shipment from the factory, the “User Name” is set to “user1” and the “Password” is set to “panasonic” (lowercase).

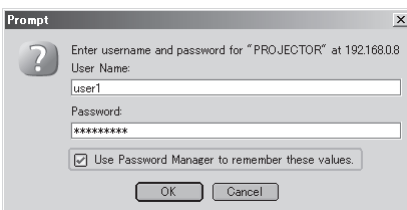

4. Press OK and the top page will appear.

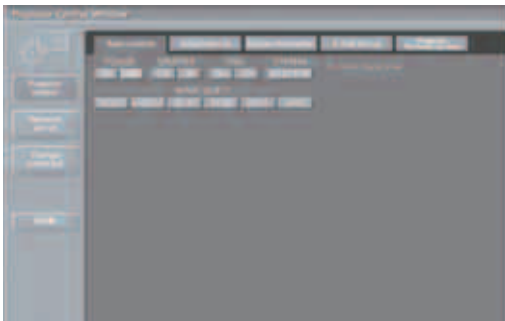

### ■ Password change page

Click [Change password].

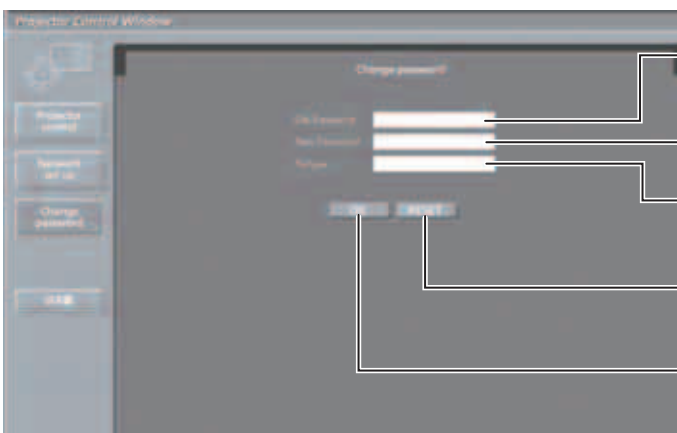

Old password input field

New password input field

New password input field  
(re-enter for confirmation)

Button for erasing all entered  
characters

Button for executing password  
change

### Note

- Avoid activating two or more Web browser simultaneously to work out setting or control actions.
- Change the password first of all.



## How to use network function (continued)

### ■ Basic control page

This page is the first page displayed when the projector is accessed through a web browser. To move from another page, click [Projector control], then [Basic control].

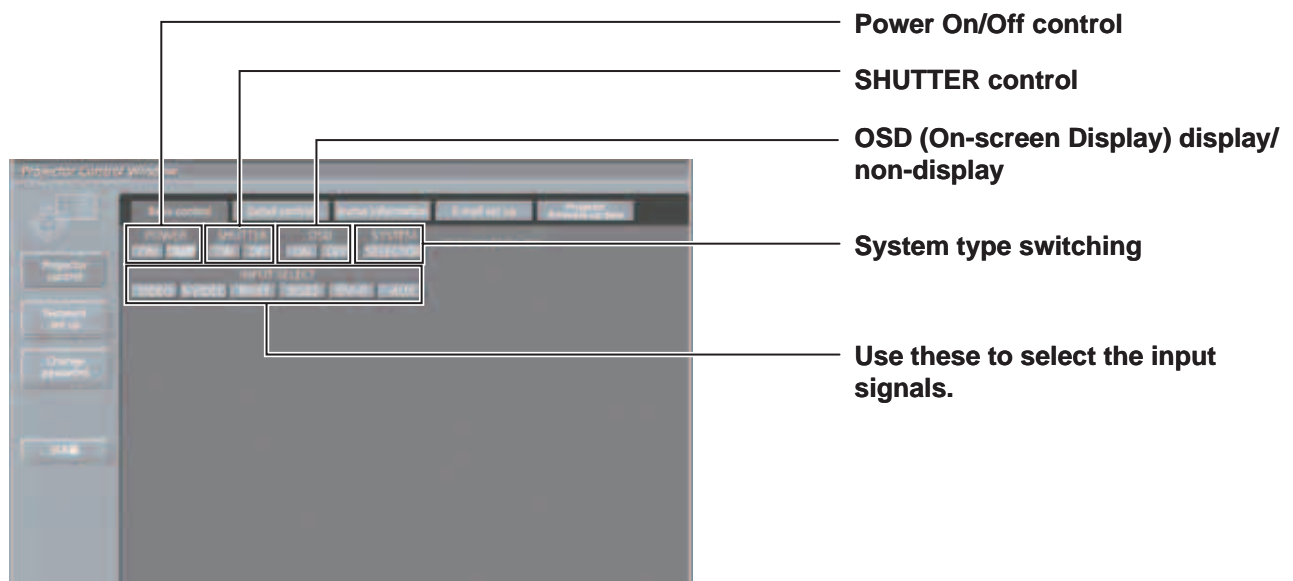
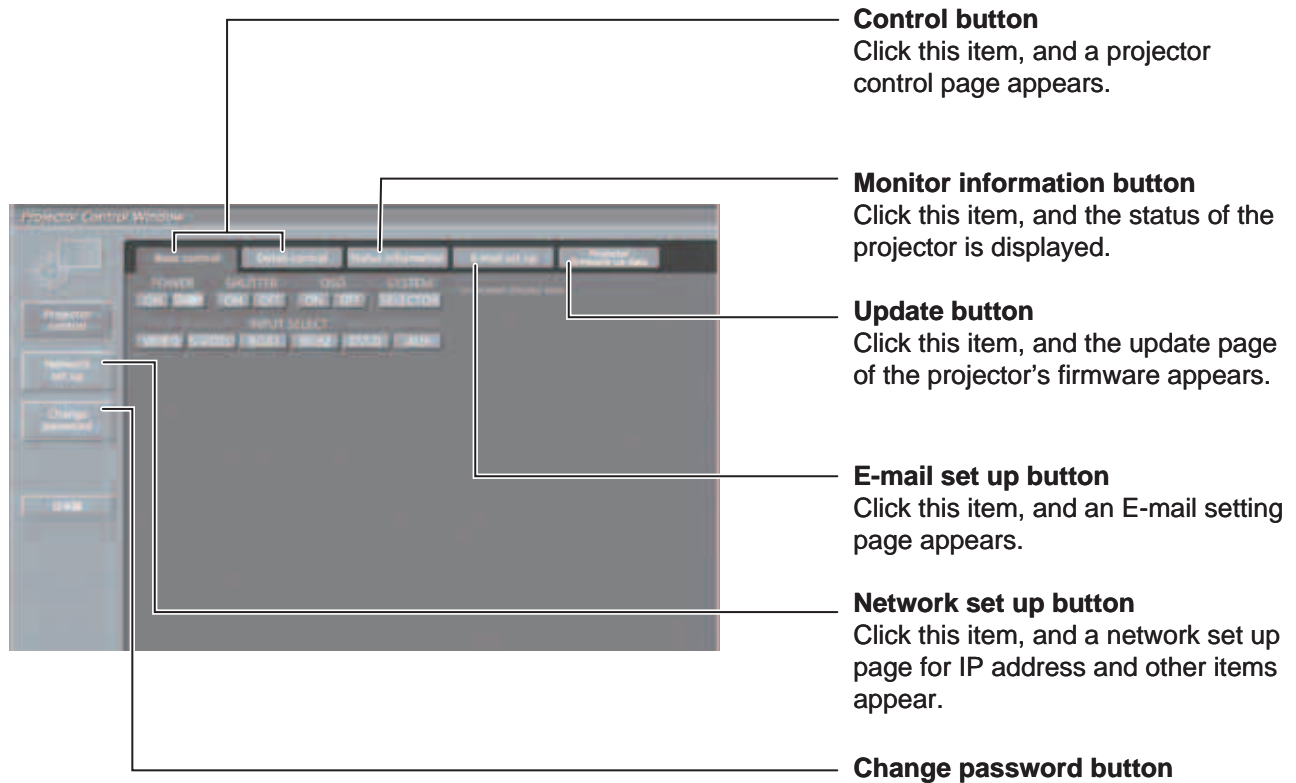

## ■ Detail control page

Click [Projector control], then [Detail control] to display the Detail control page.

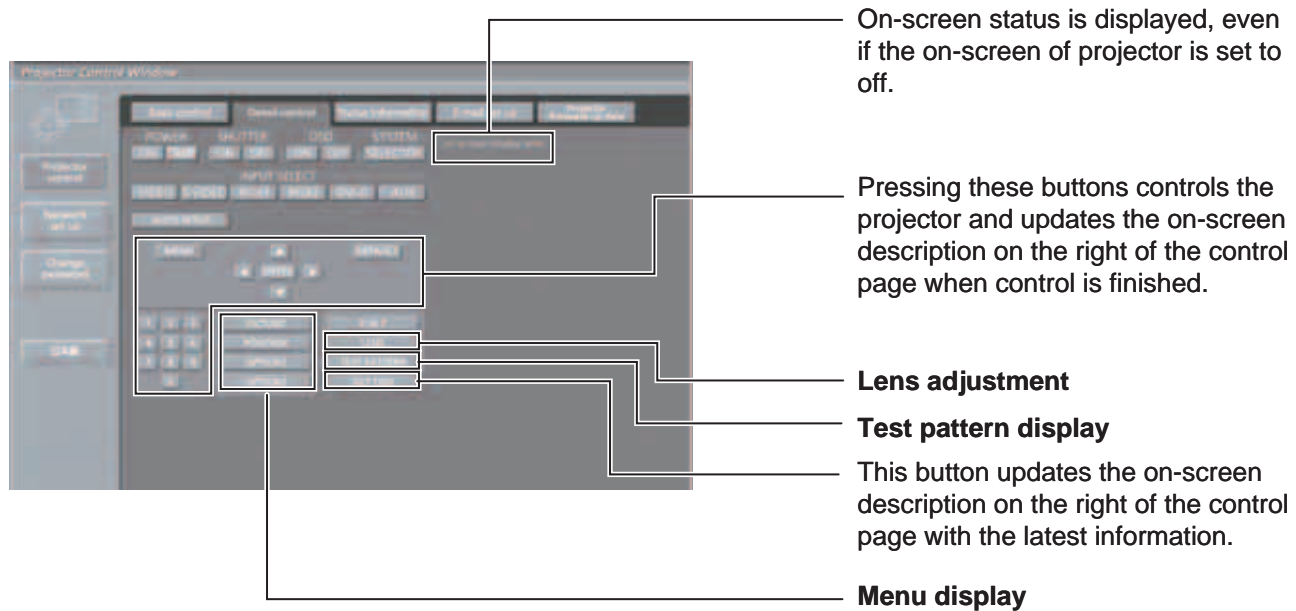

## ■ Monitor information page

Click [Projector control], then [Status information] to display the Status information page. This page displays the projector statuses established for the items shown below.

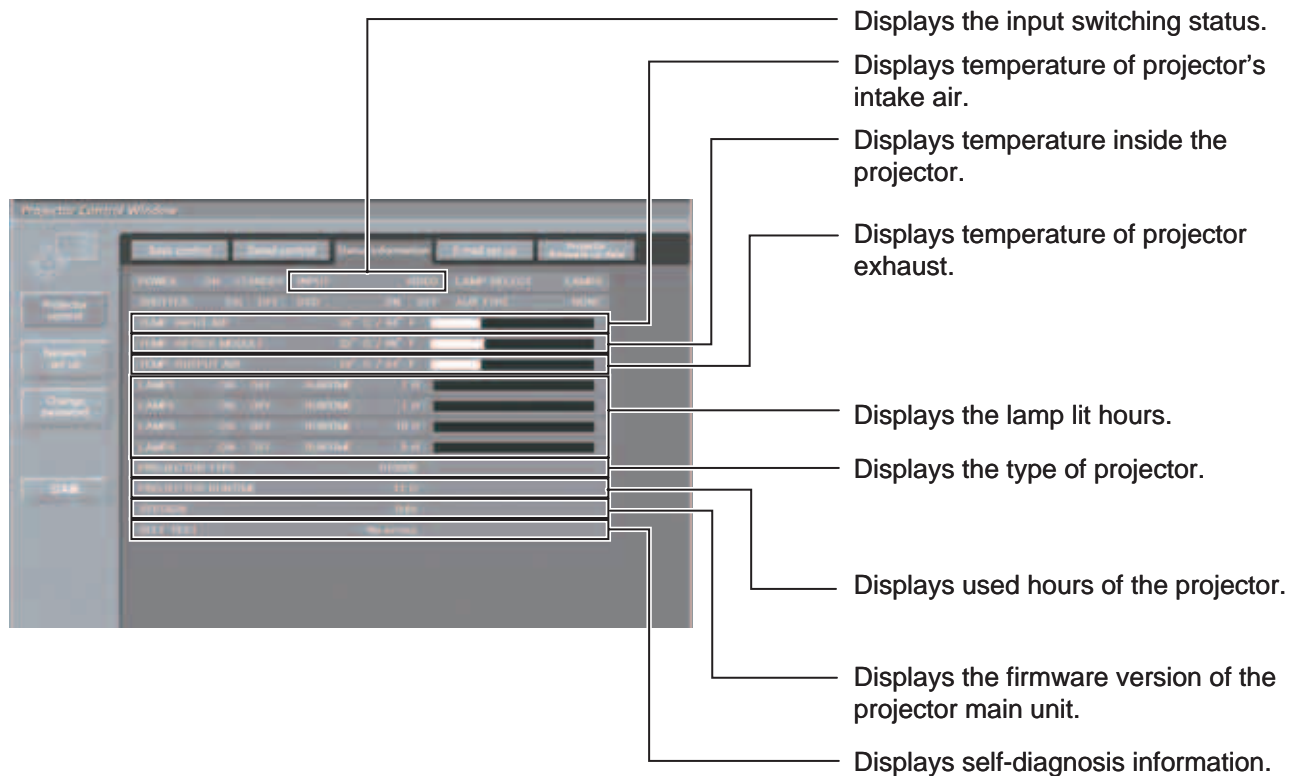

## How to use network function (continued)

### ■ Error information page

When  is displayed on the status information screen, click it to display the error details.

- Depending on the nature of the error, the projector may be placed in the standby mode for its own protection.



**OK: Normal operation**  
**FAILED: Occurrence of trouble**

### ● When [FAILED] has appeared for an item

Parameter	Description
MAIN CPU BUS	Trouble has occurred in the microcomputer circuitry. Consult your dealer.
FAN	Trouble has occurred in the fan or its drive circuit. Consult your dealer.
OPTICS MODULE TEMPERATURE	The temperature inside the projector is high. It may be that the projector is being used where the ambient temperature is high such as near a heating appliance.
INPUT AIR TEMPERATURE	The input air temperature is too high. It may be that the projector is being used where the ambient temperature is high such as near a heating appliance.
OUTPUT AIR TEMPERATURE	The temperature around the lamp is too high. It may be that the projector's ventilation holes are blocked.
LAMP REMAIN TIME	The lamp runtime has exceeded the prescribed cumulative time, and it is now time to replace the lamp.
LAMP STATUS	The lamp has failed to light. Wait a short while for the lamp to cool off, and then turn on the power.
APERTURE (CONTRAST-SHUTTER)	Trouble has occurred in the contrast shutter circuitry. Consult your dealer.
SHUTTER (MUTE-SHUTTER)	Trouble has occurred in the shutter circuitry. Consult your dealer.
DIRTY AIR FILTER	The air filter is blocked with dust. Turn off the MAIN POWER switch by following the procedure on page 36, and then clean the air filter. (pp. 108, 109)
AIR FILTER CLEANER UNIT	The air filter unit is not installed. Install the air filter unit.
OPTICS MODULE TEMP. SENSOR	Trouble has occurred in the temperature detection sensor inside the projector. Consult your dealer.
INPUT AIR TEMP. SENSOR	Trouble has occurred in the sensor used to detect the input air temperature. Consult your dealer.
OUTPUT TEMP. SENSOR	Trouble has occurred in the sensor used to detect the exhaust air temperature. Consult your dealer.
BATTERY	The backup battery has been run out. Consult your dealer.
AIRFLOW SENSOR	Problem with air flow sensor. Consult your dealer.
AC POWER	AC power supply voltage input has dropped. Check that there is sufficient electrical wiring capacity for the projector's power consumption requirements.
LENS SHIFT	Problem with lens shift circuit. Consult your dealer.

## E-mail setup page

With this projector, if a problem occurs or if the lamp usage time reaches a set value, an e-mail message can be sent to one or more preset e-mail addresses (maximum two addresses). Click [Projector Control], then [E-mail set up] to display the E-mail setup page.

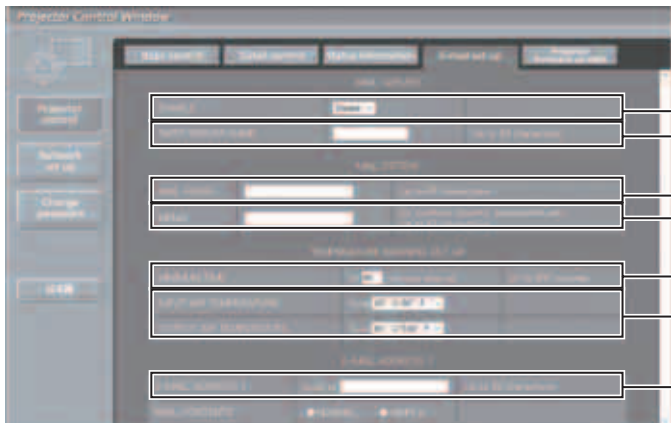

Select "Enable" to use the E-mail function.

Enter the IP address or server name of the E-mail server (SMTP). The DNS server must be set if the server name is entered.

Enter the E-mail address of the projector. (maximum 63 characters)

The user can enter the location of, for example, the installed projector so that the recipient may easily identify the originator of the E-mail. (maximum 63 characters)

The user can modify the minimum time interval of temperature warning mail. The default value is 60 minutes. In this case, the user cannot send another mail for 60 minutes after sending previous temperature warning mail even the set warning temperature is reached again.

The user can modify the threshold temperature for sending temperature warning mail. If the temperature rises above the set value, control sends temperature warning mail.

Enter the E-mail address of your desired recipient.

Select the conditions for sending E-mail.

### MAIL CONTENTS:

Select "NORMAL" or "SIMPLE".

### ERROR:

an error is detected by self-diagnosis.

### LAMP1 RUNTIME:

remaining lamp service time has reached the value set in the field.

### LAMP2 RUNTIME:

remaining lamp service time has reached the value set in the field.

### LAMP3 RUNTIME:

remaining lamp service time has reached the value set in the field.

### LAMP4 RUNTIME:

remaining lamp service time has reached the value set in the field.

### INPUT AIR TEMPERATURE:

intake air temperature has reached the value set in the field.

### OUTPUT AIR TEMPERATURE:

exhaust temperature has reached the value set in the field.

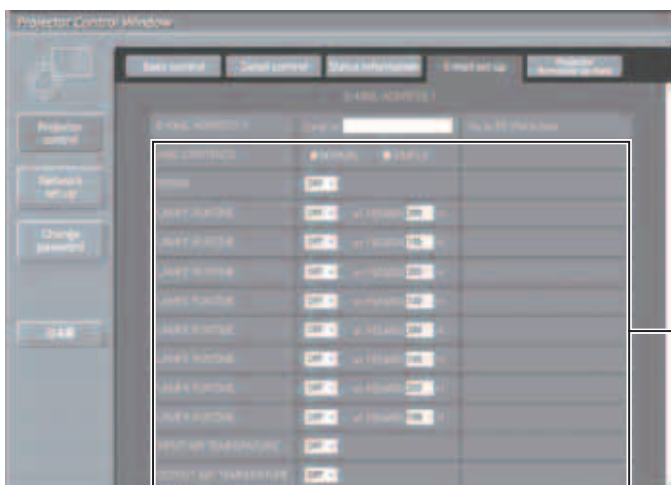

## How to use network function (continued)

### ■ E-mail setup page (continued)

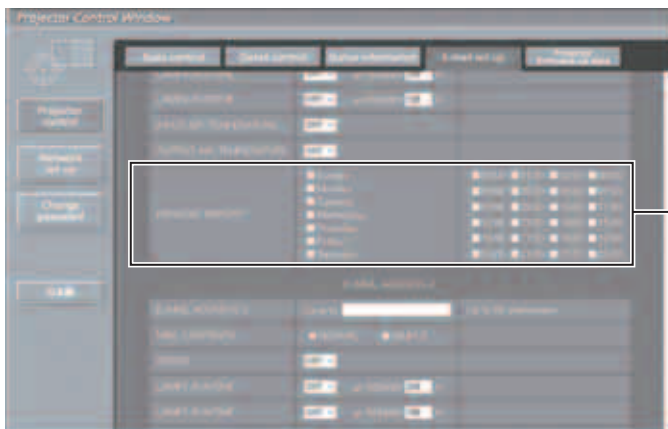

Periodic warning interval setting  
(E-mail is sent on the checked days of  
the week/times)

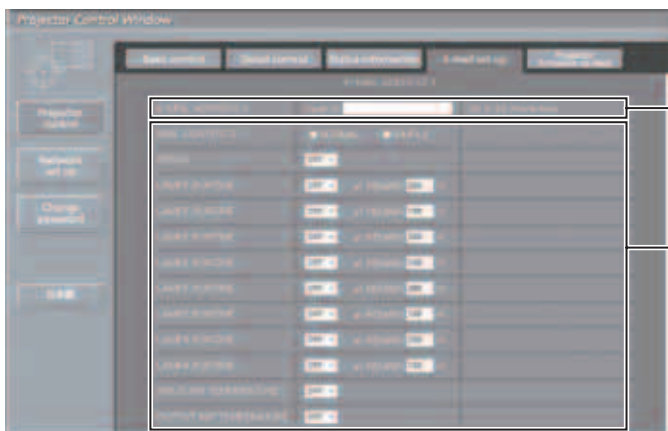

Enter the E-mail address to which the  
E-mail is to be sent when two E-mail  
addresses are going to be used. Do  
not enter it when the second E-mail  
address is not going to be used.

Select the conditions for sending  
E-mail.

**MAIL CONTENTS:**

Select "NORMAL" or "SIMPLE".

**ERROR:**

an error is detected by self-diagnosis.

**LAMP1 RUNTIME:**

remaining lamp service time has  
reached the value set in the field.

**LAMP2 RUNTIME:**

remaining lamp service time has  
reached the value set in the field.

**LAMP3 RUNTIME:**

remaining lamp service time has  
reached the value set in the field.

**LAMP4 RUNTIME:**

remaining lamp service time has  
reached the value set in the field.

**INPUT AIR TEMPERATURE:**

intake air temperature has reached the  
value set in the field.

**OUTPUT AIR TEMPERATURE:**

exhaust temperature has reached the  
value set in the field.

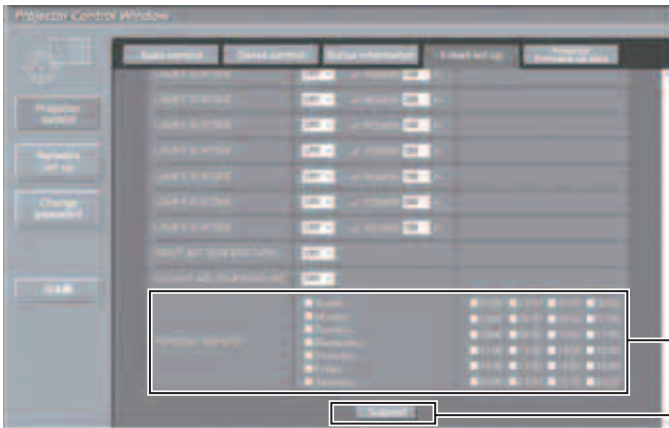

Check these boxes when E-mail is to be sent periodically to two E-mail addresses. E-mail will be sent at the times and on the days checked.

Button to update settings

## ■ DNS server set up page

Click [Network set up], then [DNS server set up] to display the DNS server set up page.

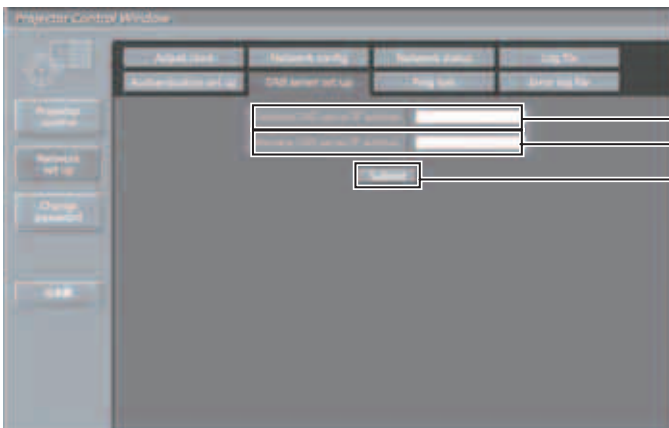

**Primary DNS server address**  
**Available input characters:**  
 Numbers (0 - 9), period (.)  
 (ex. 192.168.0.253)

**Secondary DNS server address**  
**Available input characters:**  
 Numbers (0 - 9), period (.)  
 (ex. 192.168.0.254)

Button to update settings

## How to use network function (continued)

### Authentication server setting page

The POP server is set on this page when POP authentication is required for mail transmissions. Click [Network set up], then [Authentication set up] to display the POP server setup page.

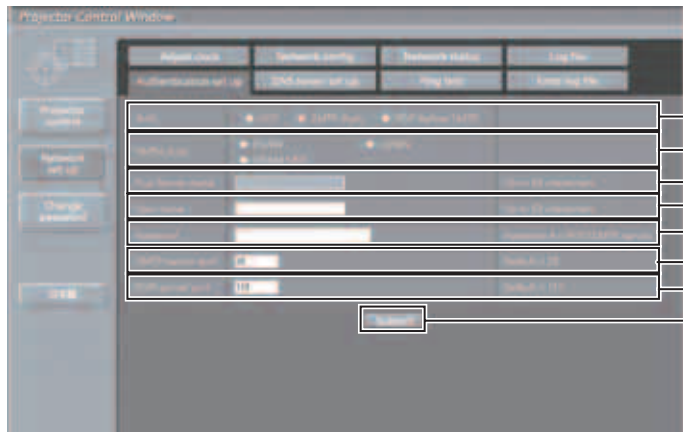

Select the authentication method specified by your Internet service provider.

Set this if SMTP authentication has been selected.

**POP server name field**  
**Available input characters:**  
Alphanumeric characters (A–Z, a–z, 0–9), hyphen (-), period (.)

**POP server user name field**

**POP server password field**

Enter the port number for the SMTP server (normally “25”).

Enter the port number for the POP server (normally “110”).

Button to update settings

### Ping test page

This page makes it possible to check whether the network is connected to the E-mail server, POP server, DNS server, etc.

Click [Network set up], then [Ping test] to display the Ping test page.



Enter the IP address of the server to be tested.

Button for conducting the test.

```
PING 198.245.80.10 (198.245.80.10): 56 data bytes
64 bytes from 198.245.80.10: icmp_seq=0 ttl=255 time=0.7 ms
64 bytes from 198.245.80.10: icmp_seq=1 ttl=255 time=0.4 ms
64 bytes from 198.245.80.10: icmp_seq=2 ttl=255 time=0.4 ms
64 bytes from 198.245.80.10: icmp_seq=3 ttl=255 time=0.4 ms
--- 198.245.80.10 ping statistics ---
4 packets transmitted, 4 packets received, 0% packet loss
round-trip min/avg/max = 0.4/0.4/0.7 ms
```

Display which appears when the connection was successful.

```
PING 198.245.80.100 (198.245.80.100): 56 data bytes
--- 198.245.80.100 ping statistics ---
4 packets transmitted, 0 packets received, 100% packet loss
```

Display which appears when the connection failed.

## ■ Contents of mail sent

- Mail with the contents shown below is sent when the E-mail settings have been established.

```

Subject: Panasonic projector report(CONFIGURE)
=== Panasonic projector report(CONFIGURE) ===
Projector Type      : D10000
----- E-mail setup data -----
TEMPERATURE WARNING SETUP
MINIMUM TIME       at [ 60] minutes interval
INPUT AIR TEMPERATURE Over [ 35C / 95F ]
OUTPUT AIR TEMPERATURE Over [ 60C / 140F ]
ERROR              [ OFF ]
LAMP1 RUNTIME      [ OFF ] at REMAIN [ 200] H
LAMP1 RUNTIME      [ OFF ] at REMAIN [ 100] H
LAMP2 RUNTIME      [ OFF ] at REMAIN [ 200] H
LAMP2 RUNTIME      [ OFF ] at REMAIN [ 100] H
LAMP3 RUNTIME      [ OFF ] at REMAIN [ 200] H
LAMP3 RUNTIME      [ OFF ] at REMAIN [ 100] H
LAMP4 RUNTIME      [ OFF ] at REMAIN [ 200] H
LAMP4 RUNTIME      [ OFF ] at REMAIN [ 100] H
INPUT AIR TEMPERATURE [ OFF ]
OUTPUT AIR TEMPERATURE [ OFF ]
PERIODIC REPORT
Sunday [ OFF ] Monday [ OFF ] Tuesday [ OFF ] Wednesday [ OFF ]
Thursday [ OFF ] Friday [ OFF ] Saturday [ OFF ]
00:00 [ OFF ] 01:00 [ OFF ] 02:00 [ OFF ] 03:00 [ OFF ]
04:00 [ OFF ] 05:00 [ OFF ] 06:00 [ OFF ] 07:00 [ OFF ]
08:00 [ OFF ] 09:00 [ OFF ] 10:00 [ OFF ] 11:00 [ OFF ]
12:00 [ OFF ] 13:00 [ OFF ] 14:00 [ OFF ] 15:00 [ OFF ]
16:00 [ OFF ] 17:00 [ OFF ] 18:00 [ OFF ] 19:00 [ OFF ]
20:00 [ OFF ] 21:00 [ OFF ] 22:00 [ OFF ] 23:00 [ OFF ]
----- check system -----
MAIN CPU BUS      [ OK ]
FAN               [ OK ]
OPTICS MODULE TEMPERATURE [ OK ]
INPUT AIR TEMPERATURE [ OK ]
OUTPUT AIR TEMPERATURE [ OK ]
LAMP1 REMAIN TIME [ OK ]
LAMP2 REMAIN TIME [ OK ]
LAMP3 REMAIN TIME [ OK ]
LAMP4 REMAIN TIME [ OK ]
.
.

```

- Mail with the contents shown below is sent when an error has occurred.

```

Subject: Panasonic projector report(ERROR)
=== Panasonic projector report(ERROR) ===
Projector Type      : D10000
----- check system -----
MAIN CPU BUS      [ OK ]
FAN               [ OK ]
OPTICS MODULE TEMPERATURE [ OK ]
INPUT AIR TEMPERATURE [ OK ]
OUTPUT AIR TEMPERATURE [ OK ]
LAMP1 REMAIN TIME [ OK ]
LAMP2 REMAIN TIME [ OK ]
LAMP3 REMAIN TIME [ OK ]
LAMP4 REMAIN TIME [ OK ]
LAMP1 STATUS      [ FAILED ]
LAMP2 STATUS      [ OK ]
LAMP3 STATUS      [ OK ]
LAMP4 STATUS      [ OK ]
APERTURE(CONTRAST-SHUTTER) [ OK ]
SHUTTER(MUTE-SHUTTER) [ OK ]
DIRTY AIR FILTER  [ OK ]
AIR FILTER CLEANER UNIT [ OK ]
OPTICS MODULE TEMP. SENSOR [ OK ]
INPUT AIR TEMP. SENSOR [ OK ]
OUTPUT AIR TEMP. SENSOR [ OK ]
BATTERY           [ OK ]
AIRFLOW SENSOR    [ OK ]
AC POWER          [ OK ]
(Error code 00 00 00 00 00 00 00 00 00 00 00 00 00 01 00 00)
Input air temperature : 29 degC / 84 degF
Optics module temperature : 33 degC / 91 degF
Output air temperature : 29 degC / 84 degF
SET RUNTIME          17 H
POWER ON             9 times
LAMP1 ON             8 times
LAMP1 HIGH           11 H
LAMP2 ON             0 times
LAMP2 HIGH           0 H
LAMP3 ON             1 times
LAMP3 HIGH           1 H
LAMP4 ON             1 times
LAMP4 HIGH           0 H
LAMP1 REMAIN         1989 H
LAMP2 REMAIN         2000 H
LAMP3 REMAIN         1999 H
LAMP4 REMAIN         2000 H
----- Current status -----
MAIN VERSION         1.00
NETWORK VERSION      1.00
----- Network configuration -----
DHCP Client          OFF
IP address           192.168.0.8
MAC address           00:0B:97:41:E2:4E
Wed Oct 11 18:21:44 2006
----- Memo -----

```



## How to use network function (continued)

### ■ Adjust clock page

Click [Network set up], then [Adjust clock] to display the Adjust clock page.

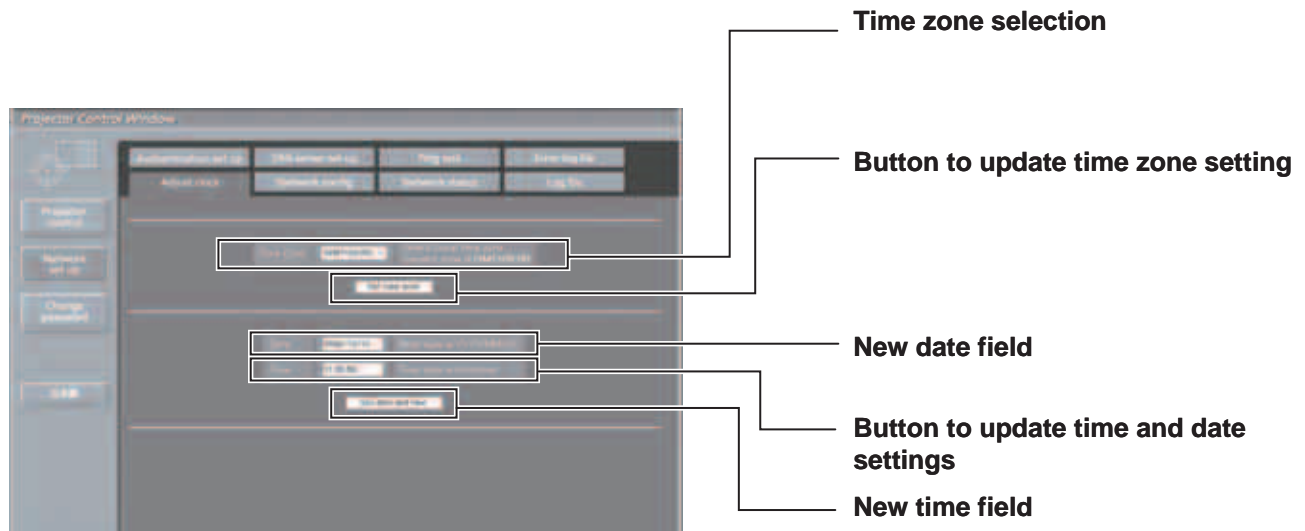

### Note

- If the time becomes incorrect immediately after setting the correct time, then the battery needs to be changed. Contact the dealer where you bought the projector to have the battery changed.

### ■ Network config page

Click [Network set up], then [Network config] to display the Network config page.

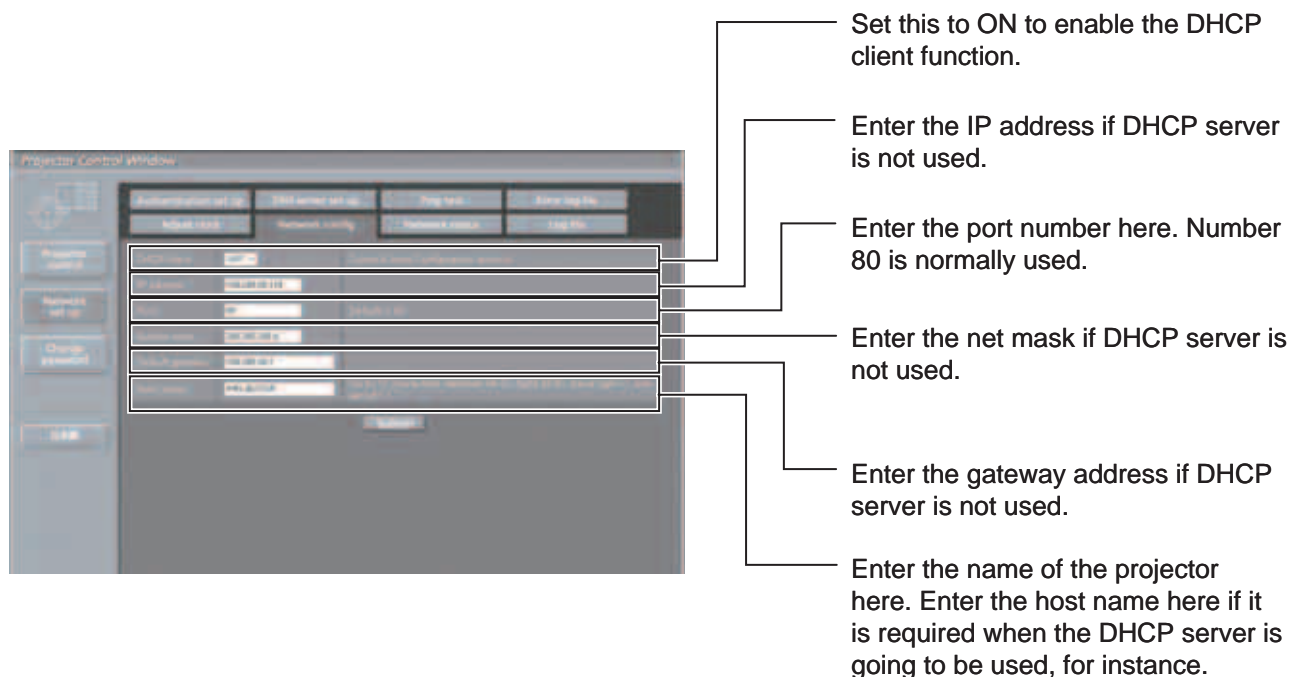

## ■ Firmware update page

(The firmware should be updated only by an individual with the specialized knowledge required to do this.)

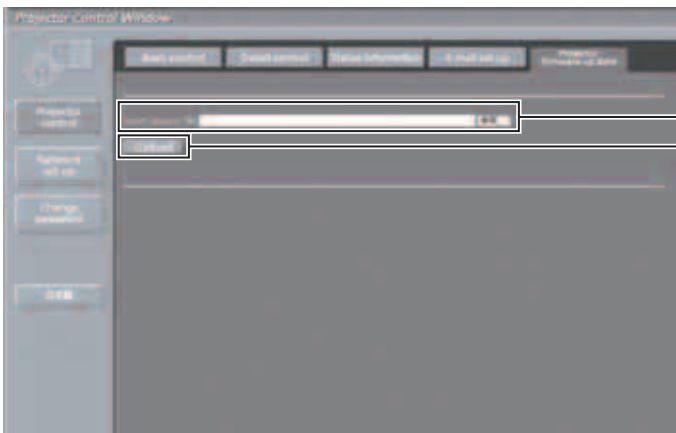

Enter here the filename of the firmware to be updated.

After entering the filename, press the [Upload] button. Data transfer is now commenced.

It will take several dozen seconds for the data to be transferred. The time taken will differ depending on the network conditions.

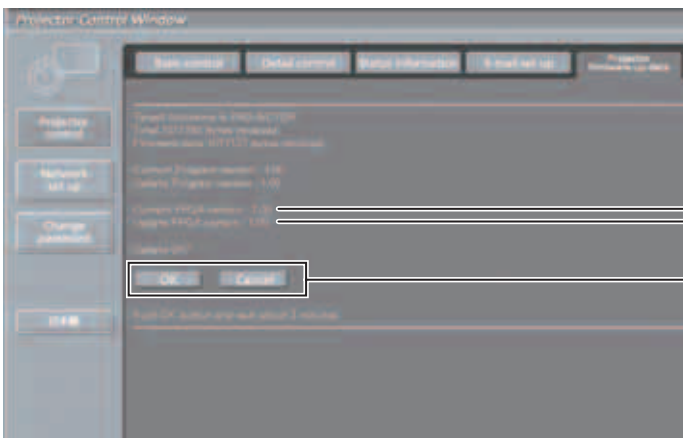

Displays the current version.

Displays the updated version.

Check the updated version against the current version, and if everything is in order, press the [OK] button. Version data rewriting is now commenced.

Do not turn off the power while the version data is being rewritten.

Messages such as the ones shown below appear during data rewriting.

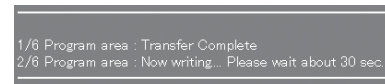

The following message appears upon completion of the version data rewriting.

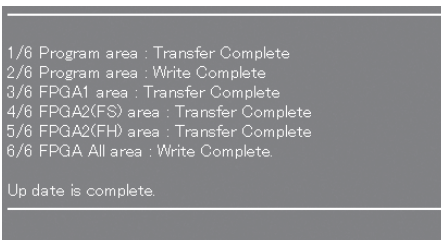

# Using the PJLink™ protocol

The network functions of this projector are compatible with PJLink™ Class 1, and so the PJLink™ protocol can be used to carry out the following operations from a computer.

- Projector settings
- Querying the projector status

## Supported commands

The following table lists the PJLink™ protocol commands that can be used to control the projector.

Command	Control details	Notes
POWR	Power supply control	Parameters 0 = Standby 1 = Power ON
POWR ?	Power supply status query	Parameters 0 = Standby      1 = Power ON 2 = Cool-down in progress 3 = Warm-up in progress
INPT	Input selection	Parameters 11 = RGB1      12 = RGB2 21 = VIDEO      22 = S-VIDEO 31 = DVI-D
INPT ?	Input selection query	32 = AUX (only enabled if ET-MD77DV, ET-MD77SD1 or ET-MD77SD3 is installed)
AVMT	Shutter control	Parameters
AVMT ?	Shutter mode query	30 = Shutter mode off (picture mute cancelled) 31 = Shutter mode on (picture mute)
ERST?	Error status query	Parameters 1st byte:      Indicates fan errors, range 0--2 2nd byte:      Indicates lamp errors, range 0--2 3rd byte:      Indicates temperature errors, range 0--2 4th byte:      Fixed at 0 5th byte:      Indicates filter errors, range 0--2 6th byte:      Indicates other errors, range 0--2 Definitions for each value from 0 to 2 are as follows. 0 = No error known      1 = Warning      2 = Error
LAMP ?	Lamp status query	Parameters 1st digits (1--5 digits): Lamp 1 cumulative operating time 2nd digit: 0 = Lamp 1 off, 1 = Lamp 1 on 3rd digits (1--5 digits): Lamp 2 cumulative operating time 4th digit: 0 = Lamp 2 off, 1 = Lamp 2 on 5th digits (1--5 digits): Lamp 3 cumulative operating time 6th digit: 0 = Lamp 3 off, 1 = Lamp 1 on 7th digits (1--5 digits): Lamp 4 cumulative operating time 8th digit: 0 = Lamp 4 off, 1 = Lamp 2 on
INST ?	Input selection list query	The following are returned as parameters. "11 12 21 22 31" (If any of the ET-MD77DV, ET-MD77SD1 or ET-MD77SD3 are installed, "11 12 31 22 31 32" is returned.)
NAME ?	Projector name query	The name set for "HOST NAME" in "NETWORK" is returned.
INF1 ?	Manufacturer name query	"Panasonic" is returned.
INF2 ?	Model name query	"D10000" or "DW10000" is returned.
INFO ?	Other information query	Information such as version number is returned.
CLSS ?	Class information query	"1" is returned.

## ■ PJLink™ security authorization

The password used for PJLink™ is the same as the password which has been set for web browser control. If you would like to use PJLink™ without authorization being used, leave the password for web browser control blank.

- PJLink™ is a pending trademark in Japan, the United States and other countries and regions.  
For details on PJLink™ specifications, refer to the Japan Business Machine and Information System Industries Association website. The URL is <http://pjlink.jbmia.or.jp/english/>

# Setting the security

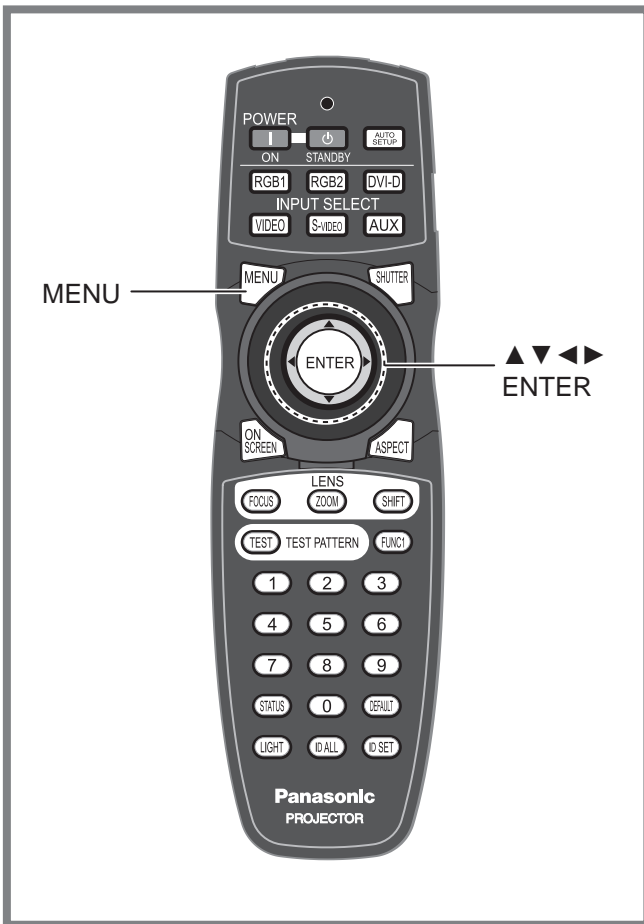

The unit's security function serves to display the password input screen or to set and display the user company's URL under the projected pictures.



Press to display the **MAIN MENU** screen.

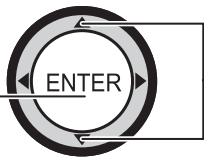

Press to select **"SECURITY"**.

Press to display the **"SECURITY"** menu.

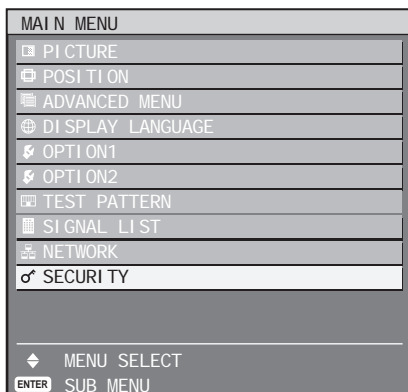

## Displaying the security screen

Password settings and text settings can be made after the security screen is displayed.

- If using for the first time
1. Press **▲, ►, ▼, ◀, ▲, ►, ▼** and **◀** in this order.
  - If the existing password has been changed

Enter the new password.



2. Press **ENTER**.

- The "SECURITY" screen will be displayed.

### Note

- Only asterisks \* will appear on the screen to represent the actual characters of the password when the password is entered.

## Setting the password

The PASSWORD screen can be displayed when the power has been turned on. Unless the correct password is entered, the user will be prohibited from performing any operations apart from POWER STANDBY (⏻) and lens adjustments.

1. Press **▲▼** to select **"PASSWORD"**.

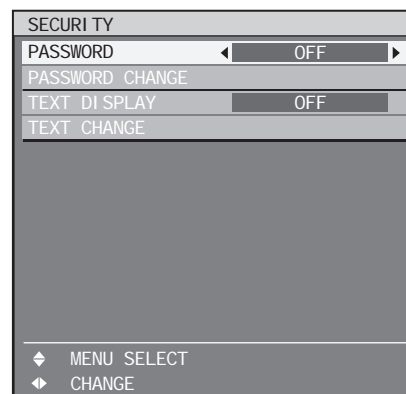

## Setting the security (continued)

### 2. Press ◀▶ to switch "PASSWORD".

- The setting will change as follows each time ◀▶ is pressed.

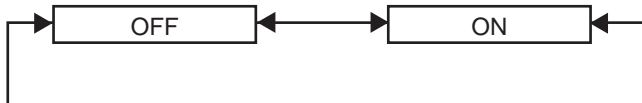

- ON:**  
Password entry is enabled.
- OFF:**  
Password entry is disabled.

## Changing the password

The password can be changed.

### 1. Press ▲▼ to select "PASSWORD CHANGE".

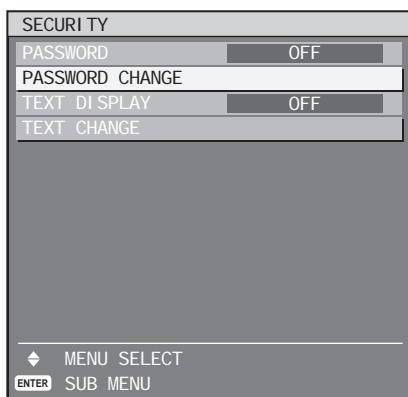

### 2. Press ENTER.

- The "PASSWORD" screen will be displayed.



### 3. Press ▲▼◀▶ to set the password.

- Up to 8 buttons can be set as the password.

### 4. Press ENTER.

### 5. For the purposes of confirmation, enter the password again.

### 6. Press ENTER.

#### Note

- Only asterisks \* will appear on the screen to represent the actual characters of the password when the password is entered.

## Setting the text

The set text can be permanently displayed below the pictures being projected.

### 1. Press ▲▼ to select "TEXT DISPLAY".

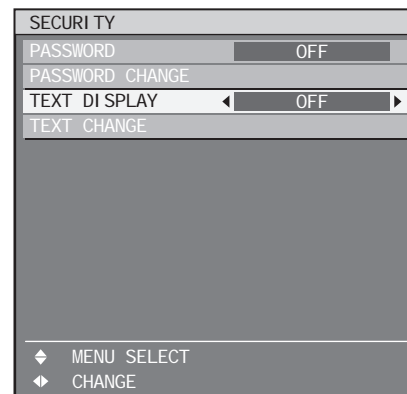

### 2. Press ◀▶ to switch "TEXT DISPLAY".

- The setting will change as follows each time ◀▶ is pressed.

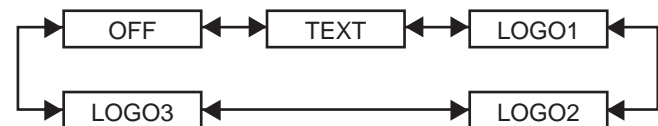

- OFF:**  
The text display is disabled.
- TEXT:**  
The text display is enabled.
- LOGO1:**  
The picture registered by the user will be projected.
- LOGO2:**  
The picture registered by the user will be projected.
- LOGO3:**  
The Panasonic logo is projected.

#### Note

- Separate software is required in order to create the pictures to use for "LOGO1" and "LOGO2". Consult your dealer.

## Changing the text

The characters displayed in the text can be changed when “ON” has been selected as the “TEXT DISPLAY” setting.

1. Press ▲ ▼ to select “TEXT CHANGE”.

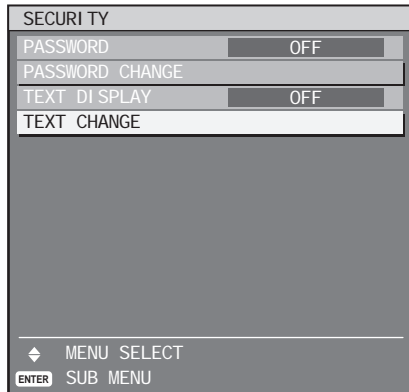

2. Press ENTER.

- The “TEXT” screen will be displayed.

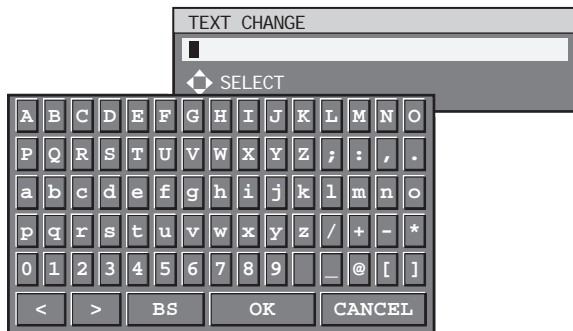

3. Press ◀ ▶ to select the text position, and press ▲ ▼ to select the characters of the text.
4. Press ENTER.
  - The text is now changed.

# Using the serial terminals

The main unit is equipped with SERIAL terminals located in its connection terminals, and this terminal is compliant with RS-232C/RS-422. Also a serial output terminal is provided to enable plural projector control.

## Examples of connection

### ■ For RS-232C

#### ● Single projector

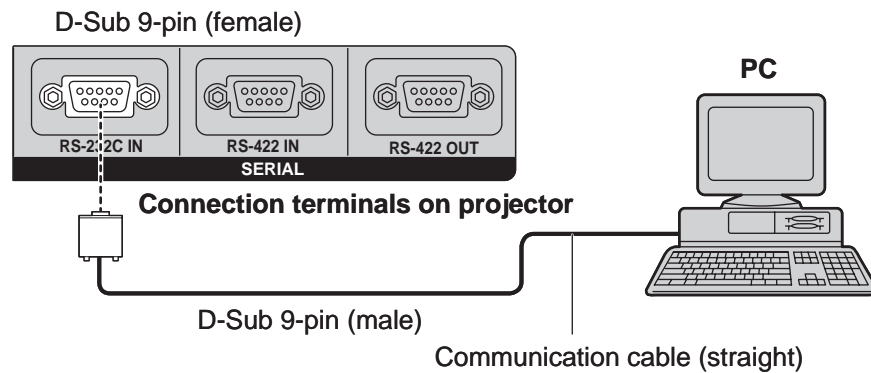

#### ● Plural projectors

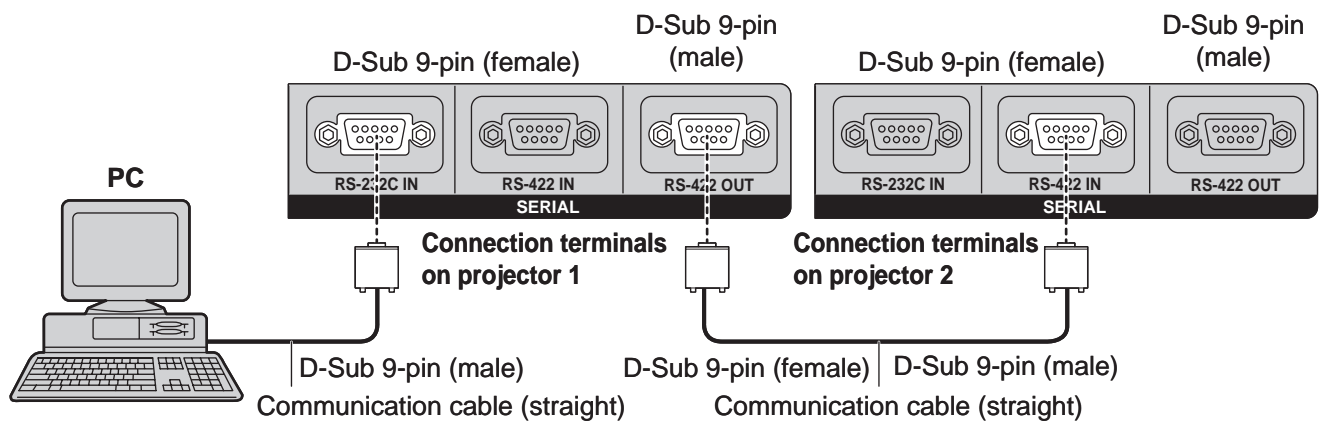

### ■ Pin assignments and signal names

Pin No.	Signal name	Description
#		NC
\$	TXD	Send data
%	RXD	Receive data
&		Connected internally
(	GND	Ground
)		NC
*	CTS	Connected internally
+	RTS	
-		NC

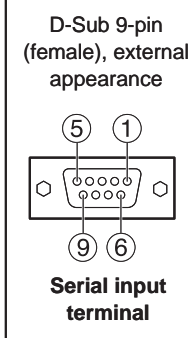

### ■ Communication conditions (Factory setting)

Signal level	RS-232C-compliant
Synchronization method	Start-stop synchronization
Baud rate	9 600bps
Parity	None
Character length	8 bits
Stop bit	1 bit
X parameter	None
S parameter	None

## ■ For RS-422

### ● Single projector

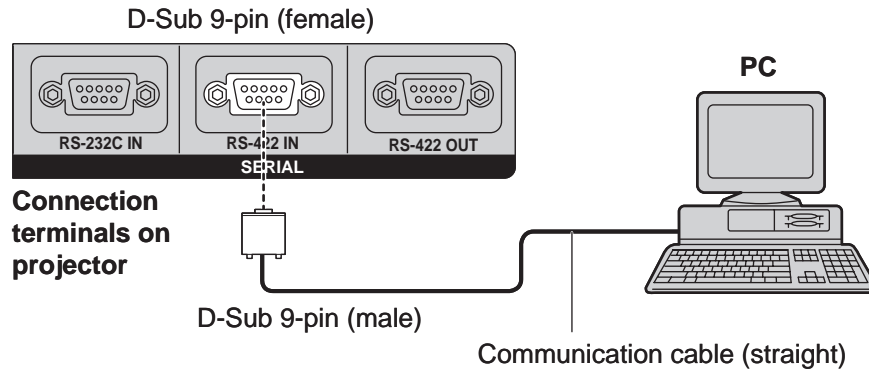

### ● Plural projectors

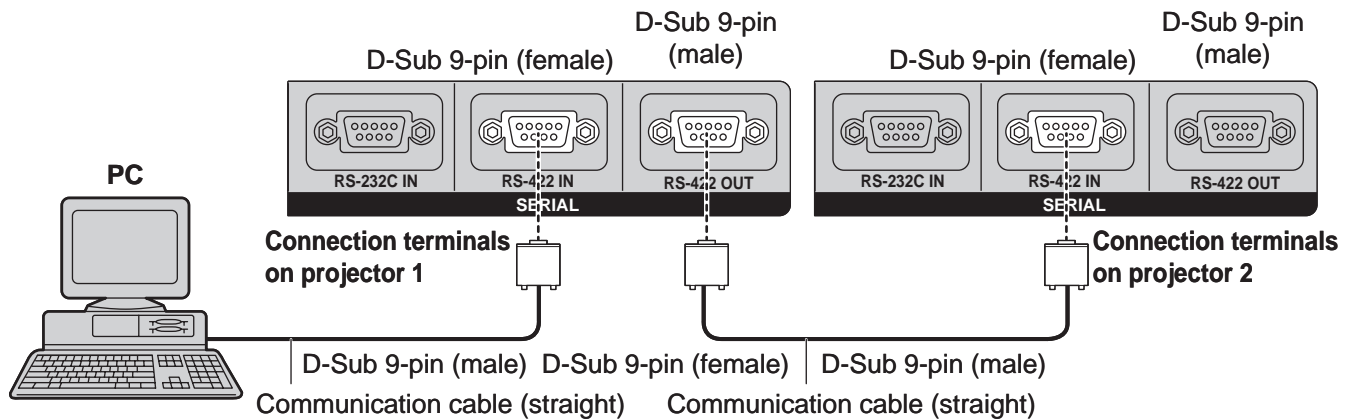

## ■ Pin assignments and signal names

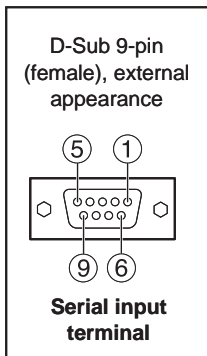

Pin No.	Signal name	Description
#		NC
\$	TXD(-)	Data transmit terminal (-)
%	RXD(+)	Data receive terminal (+)
&		Connected internally
(		NC
)		Connected internally
*	TXD(+)	Data transmit terminal (+)
+	RXD(-)	Data receive terminal (-)
-	FG	GND

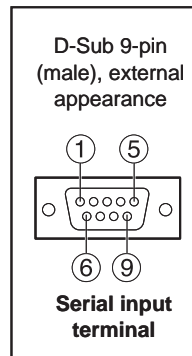

Pin No.	Signal name	Description
#		NC
\$	RXD(-)	Data receive terminal (-)
%	TXD(+)	Data transmit terminal (+)
&		Connected internally
(		NC
)		Connected internally
*	RXD(+)	Data receive terminal (+)
+	TXD(-)	Data transmit terminal (-)
-	FG	GND

## ■ Communication conditions (Factory setting)

Signal level	RS-422-compliant
Synchronization method	Start-stop synchronization
Baud rate	9 600bps
Parity	None
Character length	8 bits
Stop bit	1 bit
X parameter	None
S parameter	None



## Using the serial terminals (continued)

### Basic format

Transmission from the computer begins with STX, then the ID, command, parameter, and ETX are sent in this order. Add parameters according to the details of control.

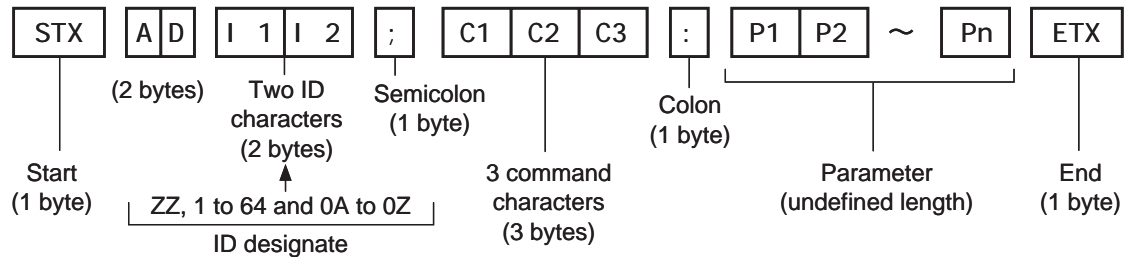

#### Attention

- No command can be sent or received for 10 to 60 seconds after the lamp starts lighting. Try sending any command after that period has elapsed.
- When transmitting multiple commands, be sure to wait until 0.5 of a second has elapsed after receiving the response from the projector before sending the next command. When sending commands without parameters, a colon (:) is not necessary.

#### Note

- When the wrong command is sent, the "ER401" or "ER402" status is sent from the projector to the personal computer.
- Projector ID supported on the RS-232C interface is ZZ (ALL) and a group of 1 to 64 and 0A to 0Z.
- The "STX" character code is 02 and the "ETX" character code is 03.
- If a command is sent with a projector ID specified, the projector will return answer back only in the following cases:  
If it coincides with the projector ID,  
ID specification is ALL and VPS-SYSTEM is the master,  
or ID specification is group and Group is the master.

### Control commands

When controlling the projector from a computer, the following commands are available:

Command	Function of command	Remarks
PON	Power "ON"	In standby mode, commands other than "PON" are invalid. • While the lamp is ON and being controlled, a "PON" command will not be accepted.
POF	Power "OFF"	
I I S	Switch input modes	Parameter VID = VIDEO      SVD = S-VIDEO      DVI = DVI-D RG1 = RGB1      RG2 = RGB2      AUX = AUX
QSL	Query for active lamp mode	Parameter 0 = QUAD, 1 = L1/L4, 2 = L2/L3, 3 = DUAL, 4 = L1/L2/L3, 5 = L1/L2/L4, 6 = L1/L3/L4, 7 = L2/L3/L4, 8 = TRIPLE, 9 = L1, 10 = L2, 11 = L3, 12 = L4, 13 = SINGLE
LPM	Active lamp mode	Parameter 0 = QUAD, 1 = L1/L4, 2 = L2/L3, 3 = DUAL, 4 = L1/L2/L3, 5 = L1/L2/L4, 6 = L1/L3/L4, 7 = L2/L3/L4, 8 = TRIPLE, 9 = L1, 10 = L2, 11 = L3, 12 = L4, 13 = SINGLE

#### Note

- If you need a detailed command list, please contact your dealer.

## Cable specifications

### ■ Connecting to a PC

#### ● For RS-232C

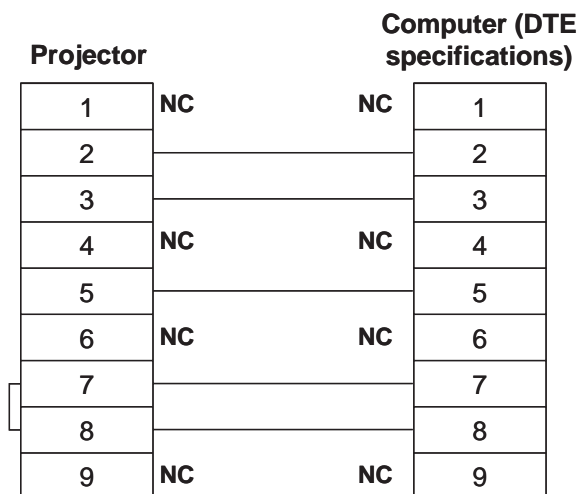

#### ● When multiple projectors are connected

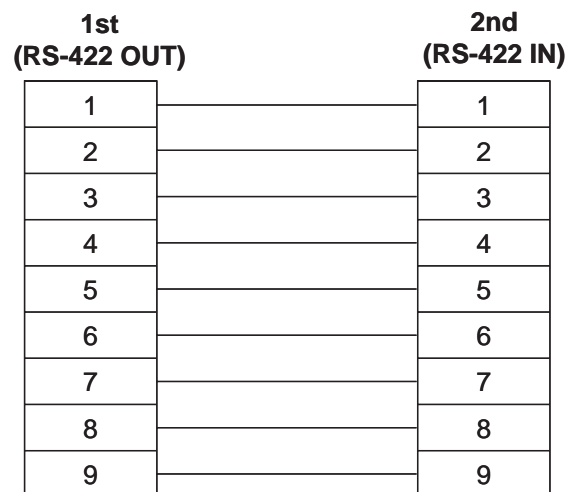

### Attention

- To connect the computer to the SERIAL terminal, prepare an adequate communication cable that fits to your personal computer.

# Using the Remote 2 terminal

Using the REMOTE 2 terminal provided on the connection terminals of the main unit, it is possible to operate the projector from a control panel etc. furnished in a distant location where infrared remote control signal cannot be received.

## Example of a control panel layout

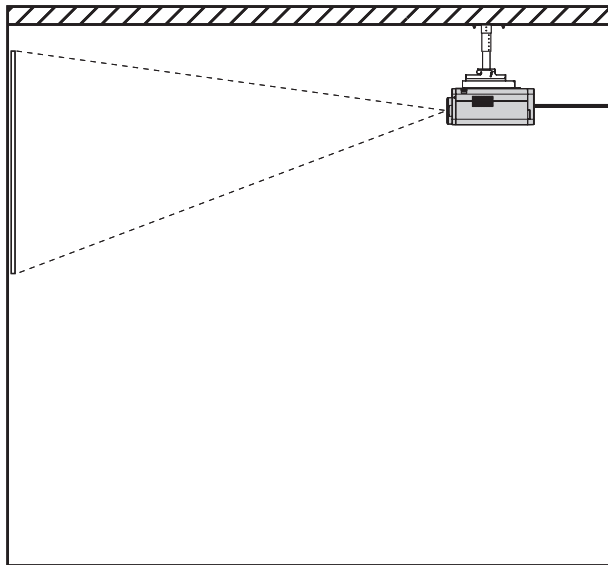

Projector set up in a meeting room

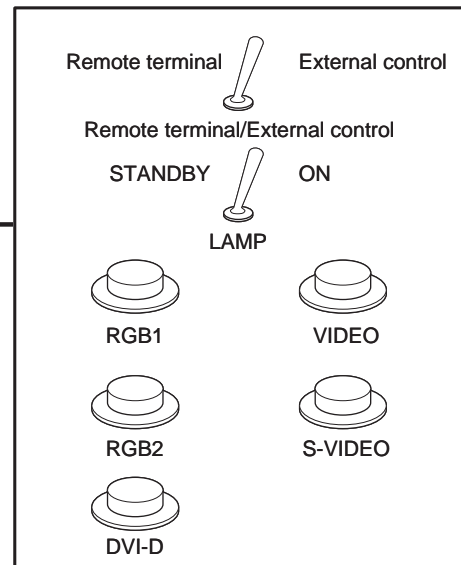

Control panel located in a different room

## Pin assignments and control

Be sure to short-circuit Pins # and - when controlling.

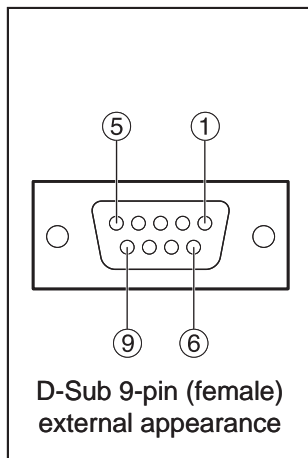

	Names of terminals	Open (H)	Short (L)
#	GND		GND
\$	POWER	OFF	ON
%	RGB1	Other	RGB1
&	RGB2	Other	RGB2
(	VIDEO	Other	VIDEO
)	S-VIDEO	Other	S-VIDEO
*	DVI-D	Other	DVI-D
+	SHUTTER	OFF	ON
-	RST / SET	Controlled by remote control	Controlled by external contact

### Note

- When pin # and pin - are short-circuited, the following buttons on the projector's control panel and on the remote control cannot be used.  
POWER button, SHUTTER button  
In addition, the RS-232C commands and network functions that correspond to these functions cannot be used either.
- When pin # and pin - are short-circuited and then any one of pins % to \* is short-circuited to pin #, the following buttons on the projector's control panel and on the remote control cannot be used.  
POWER button, input selection buttons (RGB1, RGB2, DVI-D, AUX, VIDEO, S-VIDEO), SHUTTER button  
In addition, the RS-232C commands and network functions that correspond to these functions cannot be used either.

# Indication of monitor lamp

Five monitor lamps are provided at the top of main unit front to inform the user of the lamp replacement time and unusual internal temperature. These lamps indicate the degree of abnormality by combination of blinking and/or lighting lamps. Turn off the power and take the proper measure according to the table below.

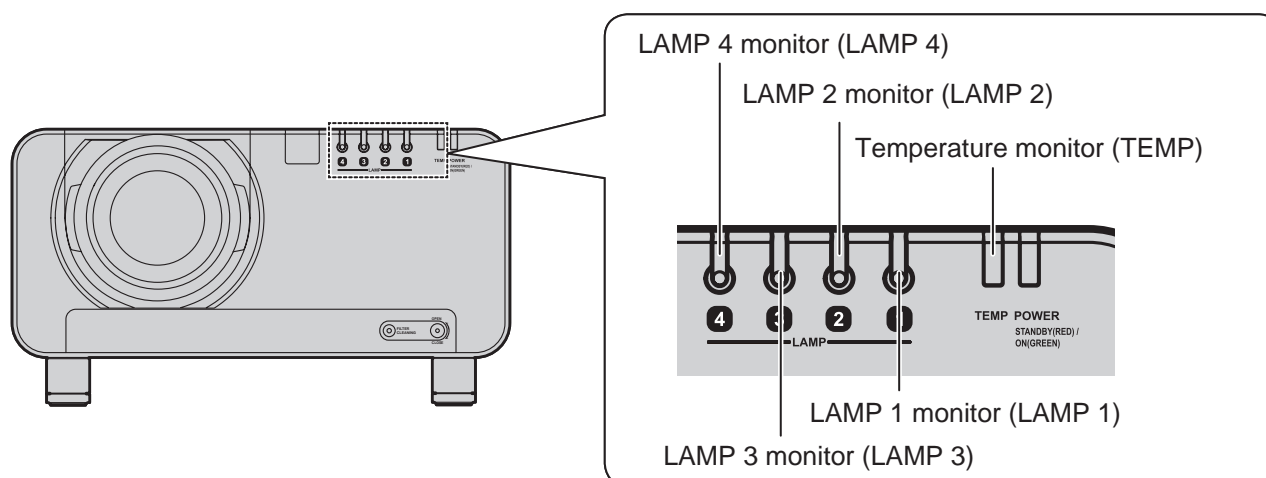

Name of monitor lamp	Lamp indication	Information	Check point	Remedial measure
TEMP monitor	Lighting in red	Warm-up status	<ul style="list-style-type: none"> <li>Did you turn on the power when the ambient temperature was low (approx. 0 °C)?</li> </ul>	<ul style="list-style-type: none"> <li>Wait about five minutes in the current status.</li> <li>Install the unit in a location having an ambient temperature from 0 °C to 45 °C.</li> </ul>
		High temperature inside. (WARNING)	<ul style="list-style-type: none"> <li>Check if the ventilation port is blocked.</li> <li>Is the room air temperature too high?</li> <li>Is the air filter blocked with dust?</li> </ul>	<ul style="list-style-type: none"> <li>Remove the object that is blocking the ventilation port.</li> <li>Move the projector to a temperature of 0 °C to 45 °C and the humidity of 20 % to 80 % (no condensation).</li> <li>Turn off the MAIN POWER switch using the procedure on page 36 and clean the air filter. (pp. 108-109)</li> </ul>
	Blinking in red (2 times)	High temperature inside (Standby condition)		
	Blinking in red (3 times)	Cooling fan has been stopped.		<ul style="list-style-type: none"> <li>Turn off the main power supply (MAIN POWER) switch in the procedure shown on page 36 and consult the distributor.</li> </ul>
LAMP monitor	Lighting in red	Indicates the time for replacing the lamp unit.	<ul style="list-style-type: none"> <li>Did you notice a "REPLACE THE LAMP" message on the screen when turning on the projector power supply?</li> </ul>	<ul style="list-style-type: none"> <li>This lamp monitor lights up when the lamp unit used hours have reached 1 800 hours. Request the dealer to replace the lamp unit.</li> </ul>
	Blinking in red (3 times)	Error is detected in the lamp circuit.	<ul style="list-style-type: none"> <li>Did you turn the power back on immediately after turning it off?</li> <li>Some error has arisen in the lamp circuit.</li> <li>Check for fluctuation (or drop) in the source voltage.</li> </ul>	<ul style="list-style-type: none"> <li>Wait until the lamp has cooled off, and then turn on the power.</li> <li>Turn off the MAIN POWER switch using the procedure on page 36 and consult the dealer.</li> </ul>

## Attention

- Be sure to observe the procedure "Powering up the projector" (p. 35) and "Powering off the projector" (p. 36) when performing power supply operation to take a measure to the indication of temperature monitor (TEMP) lamp and lamp monitor (LAMP) lamp.

# Cleaning and replacement of air filter

If the air filter is blocked with too much dust, the inside of the projector will become hot and the temperature monitor (TEMP) indicator will flash and the power will turn off. The static electric mesh filter should be replaced and the metal mesh filter and brush inside the filter unit should be cleaned after approximately 2 000 hours of use, although this is a guide only and the actual time will vary depending on the operating conditions.

## Procedure of cleaning

### 1. Turn off the main power and remove the power plug from the receptacle.

- Turn off the main power supply observing the procedure (How to turn "OFF" the power supply) on page 36 and then remove the power plug.

### 2. Use a Phillips screwdriver to loosen the filter cleaning unit fixing screw at the front of the projector.

- Insert your hand into the base of the air filter and pull the air filter forwards while removing the filter cleaning unit from the projector.

### 3. Remove the static electric mesh filter from the filter cleaning unit.

- Loosen the static electric mesh filter so that it can be removed, and then remove it.

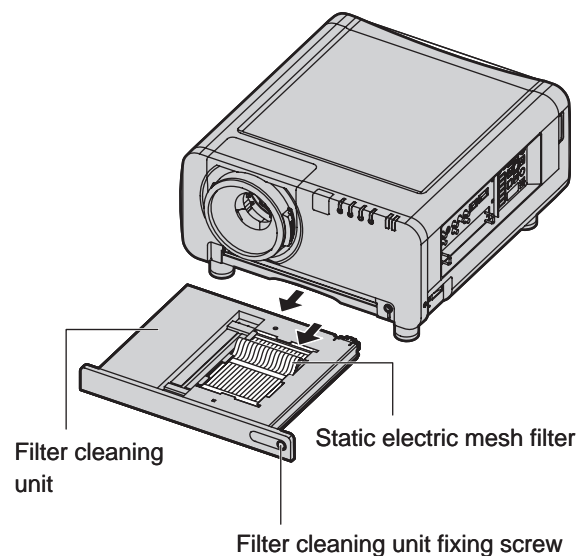

### 4. Place the filter cleaning unit upside down.

### 5. Remove the four brush cover fixing screws, and then remove the brush cover and the movable metal mesh filter from the filter cleaning unit.

Brush cover fixing screws (4 places)

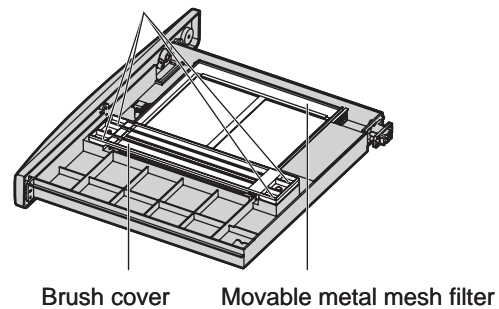

### 6. Clean the filter cleaning unit, brush and movable metal mesh filter.

- Use a vacuum cleaner to remove any dust blockages.

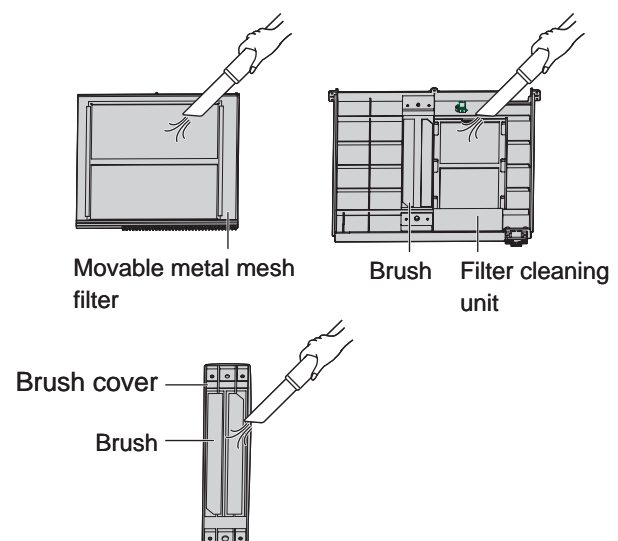

## 7. Install the movable metal mesh filter to the filter cleaning unit.

- When reassembling, align the edge of the movable metal mesh filter with position A.
- Hook the movable metal mesh filter onto the gear and the rail.
- The movable metal mesh filter will be set to the correct position after the set is installed and the power is turned on, so it can be installed in the middle position during reassembly without any problem.

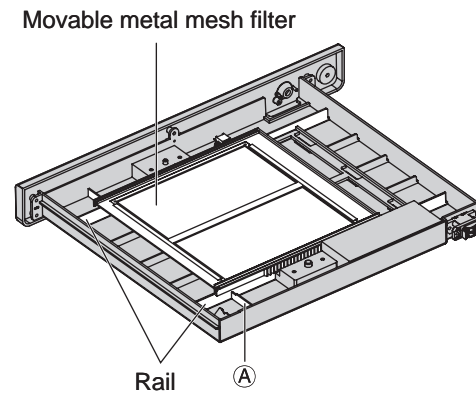

## 8. Install the brush cover so that it is aligned with the positioning pin guide, and then tighten the four brush cover fixing screws.

Brush cover fixing screws (4 places)

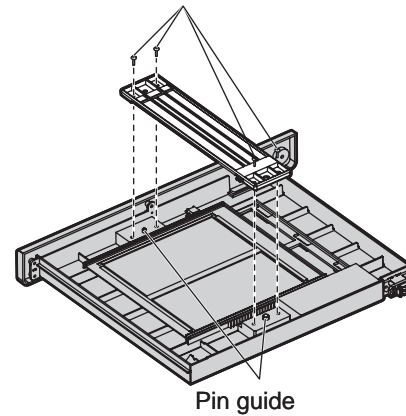

## 9. Install the new static electric mesh filter to the filter cleaning unit.

## 10. Insert the filter cleaning unit into the projector, and then securely tighten the filter cleaning unit fixing screw.

- Install the air filter, and then install the filter cleaning unit by carrying out removal step 2 in reverse.

### Attention

- The air filter must be installed before using the projector. If the projector is used without the air filter installed, foreign particles and dust will get inside the projector and cause problems with operation.

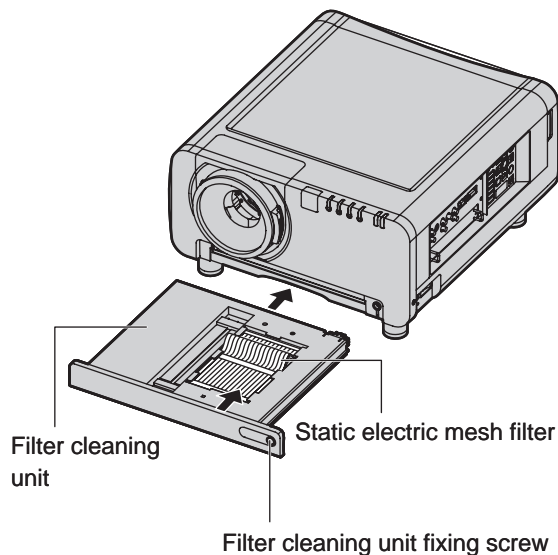

### Note

- If cleaning cannot remove the dust completely, then it is a sign to replace the static electric mesh filter. Consult the dealer. In addition, when the lamp unit is replaced, also replace the static electric mesh filter.
- Do not wash the static electric mesh filter with water.
- Use a neutral detergent to clean off any oil from the movable metal mesh filter.

# Replacement of lamp unit

## WARNING

- Wait until the lamp is cooled sufficiently before replacing the lamp unit.
- Make sure that all four lamp units are installed.
- Replacement of the lamp unit should be carried out by a qualified technician.
- Do not remove any screws (such as the black screws) other than those indicated when replacing the lamp unit. If this is not observed, electric shocks, burns or other injuries may occur.

## Precautions on lamp unit replacement

- Be careful when handling a light source lamp. The lamp unit has high internal pressure. If improperly handled, failure might result.
- A used lamp unit may burst if it is handled violently. For disposition of used lamps, request an industrial waste disposal contractor.
- If you continue to use a lamp after the replacement time, the lamp may break.
- Phillips screwdriver is necessary when replacing a lamp unit. Take care not to slip your hand when using a screwdriver.

## Attention

- A lamp unit is an optional part. Contact the dealer.  
**Replacement Lamp Unit model No.:** ET-LAD10000 (single bulb), ET-LAD1000F (4 bulbs)  
Rating: 250 W
- Other lamps than specified above cannot be used. Be sure to use the specified lamp.

## Timing of lamp unit replacement

The lamp used for the light source has its due life. The life of light source lamp used in the main unit is 2 000 hours. However, it may happen that the lamp becomes dead (will not light) by the time of 2 000 hours depending on the characteristics of individual lamps and working conditions (lamps may reduce their life affected by the times of lighting and the intervals between previous lighting and next lighting). Therefore, it is strongly recommended for the user to keep a spare bulb.

If a lamp unit has not been replaced after 2 000 hours of operation have elapsed, the lamp will turn off automatically. When the operating time for all of the lamps reaches 2 000 hours or more, the power will turn off automatically approximately 10 minutes after it is turned on, and the projector will switch to standby mode.

## Attention

- Clean and replace the air filter when replacing the lamp units. (pp. 108-109)

## ■ Indication after 1 800 hours

When lamp unit used hours have reached 1 800 hours, lamp monitor (LAMP1, LAMP2, LAMP3, or LAMP4) light up including standby state.

Further, an on-screen indication will appear for about 30 seconds as shown in the diagram on the right, recommending replacement of lamp unit. (The indication on the below diagram will disappear after about 30 seconds or when either control button on the main unit or remote control button is operated.)

After the time of 2 000 hours, the on-screen indication will not disappear unless the menu (MENU) button is operated.

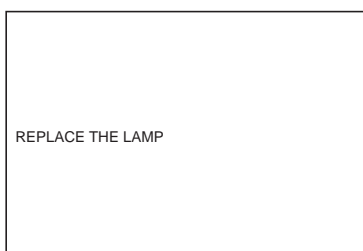

## Procedure of lamp unit replacement

1. Be sure to observe the procedure “Powering up the projector” (p. 35) and “Powering off the projector” (p. 36), remove the power plug and confirm that the surroundings of the lamp unit have cooled off.

2. Use a Phillips screwdriver to loosen the lamp unit cover screw at the rear of the projector until the screw turns freely.
3. Open the lamp unit cover and remove it from the projector.

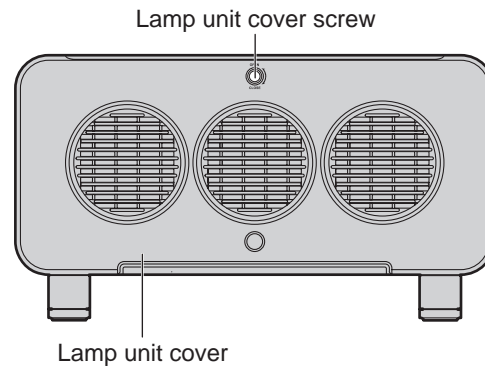

4. Use a Phillips screwdriver to loosen the three fixing screws for the lamp unit to be replaced until the screws turn freely. Hold the handle of the lamp unit and gently pull the lamp unit out from the projector.

### CAUTION

The lamp unit and structural parts around the lamp unit will be hot immediately after the projector has been used. You might get burned if you touch it while it is still hot.

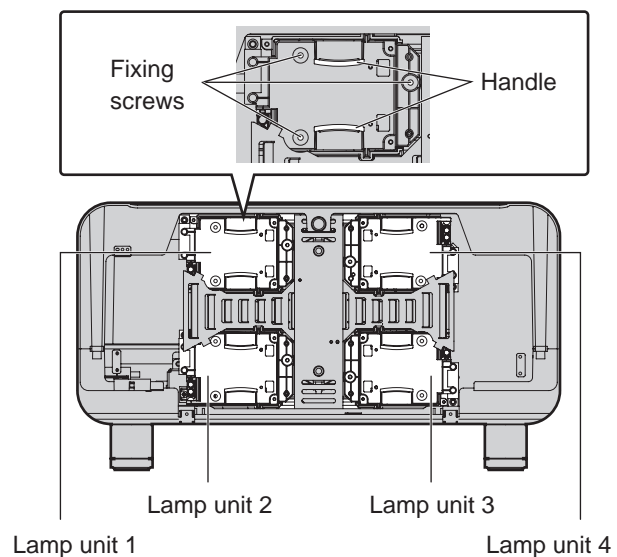

5. Install the new lamp unit.
6. Use a Phillips screwdriver to securely tighten the 3 lamp unit fixing screws for each lamp unit.

7. Install and close the lamp unit cover, and then use a Phillips screwdriver to securely tighten the lamp unit cover screw.

### Caution

- Firmly install the lamp unit and lamp unit cover. If not installed firmly, a protection circuit will function and the power will not be turned on.

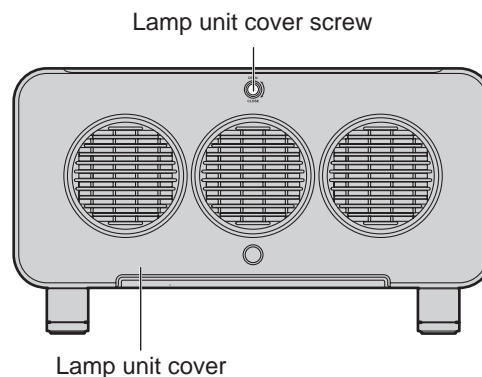



# Notes when installing the ceiling mount bracket

When installing the ceiling mount bracket to the projector, install the accessory eye bolts and wires to the projector. (The projector will still be safe if they are not used, however they will help prevent the possibility of accidents caused by the projector falling down if the screws happen to become loose.)

Installation should be carried out by a qualified technician by following the procedure given below.

- Panasonic takes no responsibility for any losses or damage occurring as a result of using a ceiling mount bracket not manufactured by Panasonic, or if damage to the projector occurs as a result of an inappropriate location used for installing the ceiling mount bracket, even if the projector's warranty period has not yet expired.
- Use a torque screwdriver or similar tool to tighten the screws. Do not use tools such as electric screwdrivers or impact screwdrivers.
- Dispose of any used products as soon as possible by asking a qualified technician for assistance.

## Attention

- Be sure to use the accessory eye bolts and wires.

## Installation procedure

- 1. Place the projector on a soft cloth with the base facing upward.**
- 2. Turn the four adjustable feet counterclockwise and remove them from the projector.**

The adjustable feet will be used if the projector is installed normally, so store them safely.

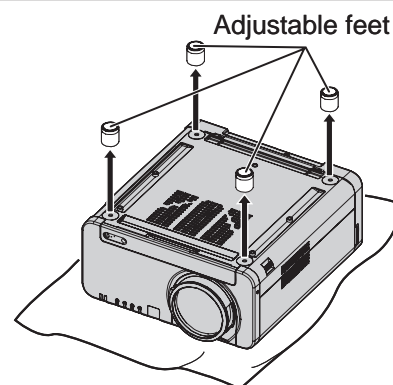

- 3. Turn the four eye bolts clockwise to install them to the projector.**

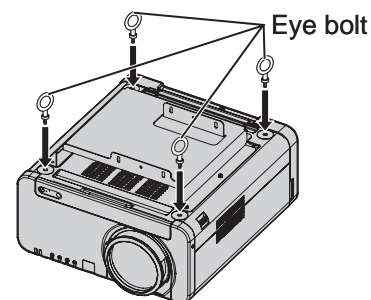

- 4. Install each of the four wires to the four eye bolts.**
- 5. Pull the four accessory wires from the eye bolts to the ceiling in four directions.**

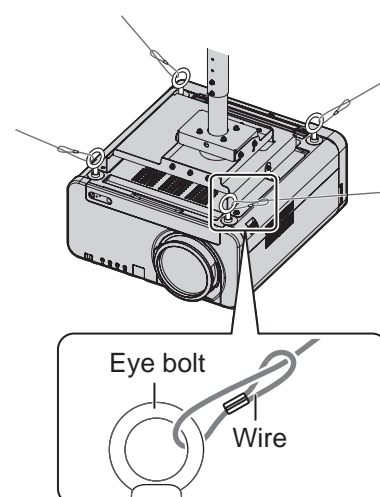

# Before asking for service ... try to check the following points again.

Symptoms	Check point	Page
<b>Power does not turn on</b>	• Is the power cord securely plugged in the receptacle?	34
	• Is the MAIN POWER switch put to the "O" position?	35, 36
	• Is power supply live at the receptacle?	34
	• Is the temperature monitor (TEMP) lamp on the projector front lighting or blinking?	107
	• Is the lamp monitor (LAMP) lamp on the projector front lighting or blinking?	107
	• Is the lamp unit cover completely attached?	111
	• Was operation of ID setting made in a correctly way?	18, 75
	• Are all four lamp units installed?	109, 110
<b>No image appears on screen</b>	• Is the lens covered with the cap?	25
	• Is the screen image input connected in a correct manner?	43, 54
	• Is the device(s) connected to the projector working normally?	-
	• Is the shutter function used?	43
<b>Screen image is blurred</b>	• Is the lens in focus?	37
	• Is the projection distance adequate?	21, 22
	• Is the lens dirty?	-
	• Is the projector placed vertical to the screen?	20
<b>Pale color / bad color tint</b>	• Are color strength and color tint correctly adjusted?	50, 51
	• Is the device(s) connected to the projector adjusted correctly?	-
<b>Remote control does not function</b>	• Are dry batteries consumed?	-
	• Is polarity correct in battery setting?	17
	• Are there any obstacle between the remote control and the beam receiving window?	17
	• Are you trying to operate the remote control beyond the effective range?	17
	• Is the remote 2 (REMOTE2) terminal used for external control?	106
	• Is any external light interfering with the remote control operation?	-
	• Was operation of ID setting made in a correctly way?	18, 75
	• Is the LOCK button of the remote control at the lock position?	11
	• Is adjustment value protection enabled? Press ▼+ ▼ + ENTER+ ▼ + ▼ + ENTER to cancel the protection.	64
<b>Abnormal image on the screen</b>	• Is the input selector set to correct position?	43, 54
	• Is the correct signaling system selected?	54
	• Are there any malfunctions on the source side, such as bad video tape?	-
	• Are you supplying a signal that is not compatible with the projector?	119
<b>Images from PC are not projected</b>	• Is the cable too long?	-
	• Is the correct signal destination set for notebook computer screen image?	-
	• Use [Fn] and [F3] keys for setting. (For details, refer to the instruction manual of the computer.)	-

# Self-diagnosis display

There is a self-diagnosis display located at the side of the projector (p. 15) which automatically displays error details when an error occurs.

Self-diagnosis display	Details	Remedy
U04	Air filter is blocked	<ul style="list-style-type: none"> <li>Clean the air filter unit.</li> </ul>
U11	Intake air temperature warning	<ul style="list-style-type: none"> <li>Ambient air temperature is too high.</li> </ul>
U12	Optical module temperature warning	
U13	Lamp ambient temperature warning	
U14	Low temperature warning	
U21	Intake air temperature error	
U22	Optical module temperature error	
U23	Lamp ambient temperature error	
U24	Low temperature error	<ul style="list-style-type: none"> <li>Ambient temperature is too low.</li> </ul>
U41	Lamp 1 operating time warning	<ul style="list-style-type: none"> <li>The lamp replacement period has arrived. Replace the lamp.</li> </ul>
U42	Lamp 2 operating time warning	
U43	Lamp 3 operating time warning	
U44	Lamp 4 operating time warning	
U51	Lamp 1 error	<ul style="list-style-type: none"> <li>Lamp has not turned on.</li> </ul>
U52	Lamp 2 error	
U53	Lamp 3 error	
U54	Lamp 4 error	
U61	Lamp 1 : 2000 hour operating time exceeded	<ul style="list-style-type: none"> <li>The lamp has exceeded its replacement period. Replace the lamp straight away.</li> </ul>
U62	Lamp 2 : 2000 hour operating time exceeded	
U63	Lamp 3 : 2000 hour operating time exceeded	
U64	Lamp 4 : 2000 hour operating time exceeded	
U70	Air filter unit not installed	<ul style="list-style-type: none"> <li>Install the air filter unit.</li> </ul>
U71	Lamp 1 not installed	<ul style="list-style-type: none"> <li>Install the lamp.</li> </ul>
U72	Lamp 2 not installed	
U73	Lamp 3 not installed	
U74	Lamp 4 not installed	
U81	AC power supply voltage drop warning (less than 90 V)	<ul style="list-style-type: none"> <li>AC power supply voltage input has dropped. Check that there is sufficient electrical wiring capacity for the projector's power consumption requirements.</li> </ul>
U91	Lamp unit cover is not closed	<ul style="list-style-type: none"> <li>Close the lamp unit cover.</li> </ul>
H01	Internal clock battery replacement	<ul style="list-style-type: none"> <li>The battery needs to be replaced. Consult your dealer.</li> </ul>
H11	Air intake temperature sensor not found	<ul style="list-style-type: none"> <li>If turning the main power off and back on again does not clear the error display, consult your dealer.</li> </ul>
H12	Optical module temperature sensor not found	
H13	Lamp ambient temperature sensor not found	
H18	Air flow sensor not found	
F11	Shutter error	
F12	Dynamic iris error	
F13	Air filter unit error	
F21	2.5 V DC error	
F22	3.3 V DC error	
F23	5.0 V DC error	



Self-diagnosis display	Details	Remedy
F41	Lamp 1 memory error	<ul style="list-style-type: none"> <li>• Problem with lamp. Consult your dealer.</li> </ul>
F42	Lamp 2 memory error	
F43	Lamp 3 memory error	
F44	Lamp 4 memory error	
F91	FPGA1 configuration error	<ul style="list-style-type: none"> <li>• If turning the main power off and back on again does not clear the error display, consult your dealer.</li> </ul>
F92	FPGA2 configuration error	
F93	Flash ROM error	
F94	RAM error	
F95	FPGA expansion error	
F96	Lens shift error	
FE1	Power supply fan error	
FE2	Lamp 1 fan error	
FE3	Lamp 2 fan error	
FE4	Lamp 3 fan error	
FE5	Lamp 4 fan error	
FE6	Ballast circuit 1 fan error	
FE7	Ballast circuit 3 fan error	
FE8	Radiator fan error	
FE9	Center exhaust fan error	
FF0	Left exhaust fan error	
FF1	Right exhaust fan error	
FF2	Red DMD cooling fan error	
FF3	Green DMD cooling fan error	
FF4	Blue DMD cooling fan error	
FF5	Color prism fan error	
FF6	Lamp prism fan error	
FF7	Ballast circuit 2 fan error	
FF8	Ballast circuit 4 fan error	
FP1	Lamp 1 PFC error	
FP2	Lamp 2 PFC error	
FP3	Lamp 3 PFC error	
FP4	Lamp 4 PFC error	

# Specifications

Model No.		PT-D10000U	PT-DW10000U
Power supply		AC 120 V, 50 Hz/60 Hz	
Power consumption		1 500 W (about 25 W in standby)	
Amps		Maximum 15 A	
DLP® panel	Panel size	0.95 inch (aspect ratio 4:3)	0.95 inch (aspect ratio 16:9)
	Display system	Three-unit DLP® chip, DLP® type	
	Number of pixels	3 × 1 470 000 pixels (1 400 × 1 050 dots)	3 × 2 073 600 pixels (1 920 × 1 080 dots)
Lens (Powered zoom/ Powered focus control)		Option	
Projection lamp		4 bulbs × 250 W UHM lamp	
Optical output		10 000 lm	
Applicable scanning frequency	For video signal (S-video included)	Horizontally 15.73 kHz/15.63 kHz, vertically 59.94 Hz/50 Hz	
	For RGB signal	Horizontally 15 kHz–100 kHz, vertically 24 Hz–120 Hz, Panasonic Intelligent Auto Scanning (PIAS) system	
		Dot clock frequency 20 MHz–162 MHz	
	For DVI-D signal	EDID1 1 480p, 576p, 720/60p, 720/59.94p, EDID2 <sup>1</sup> Displayable resolution : 720/50p, 1 080/60p, 1 080/59.94p, VGA-UXGA 1 080/50p, (non-interlace) 1 080/60i, 1 080/59.94i, 1 080/50i, Dot clock frequency : 1 080/24sF, 1 080/23.98sF 25 MHz-162 MHz 1 080/30p, 1 080/29.97p, 1 080/25p, 1 080/24p, 1 080/23.98p	
	For YP <sub>B</sub> P <sub>R</sub> signal	[480i] horizontally 15.73 kHz, vertically 59.94 Hz [480p] horizontally 31.5 kHz, vertically 59.94 Hz [576i] horizontally 15.63 kHz, vertically 50 Hz [576p] horizontally 31.25 kHz, vertically 50 Hz [720/60p] horizontally 45 kHz, vertically 60 Hz [1 035/60i] horizontally 33.75 kHz, vertically 60 Hz [1 080/60i] horizontally 33.75 kHz, vertically 60 Hz [1 080/50i] horizontally 28.13 kHz, vertically 50 Hz [1 080/24p] horizontally 27 kHz, vertically 24 Hz [1 080/30p] horizontally 33.75 kHz, vertically 30 Hz [1 080/25p] horizontally 28.13 kHz, vertically 25 Hz [1 080/24sF] horizontally 27 kHz, vertically 48 Hz [1 080/60p] horizontally 67.5 kHz, vertically 60 Hz [1 080/50p] horizontally 56.25 kHz, vertically 50 Hz • HD/SYNC, VD terminals are not compliant with 3 value composite SYNC.	
Color system		7 standards (NTSC/NTSC4.43/PAL/PAL-N/PAL-M/SECAM/PAL60)	
Screen size		70 inch–600 inch* <sup>2</sup>	
Screen aspect ratio		4:3	16:9
Projection scheme		Menu-selectable from front/rear/ceiling mount, and floor standing	
Contrast ratio		5 000:1 (when "DYNAMIC IRIS" has been set to "3")	
Interface ports	Input module connection slot	One system	
	RGB1 input terminal	1 set, BNC × 5 [For YP <sub>B</sub> P <sub>R</sub> input] Y: 1.0 V[p-p] synchronization signal included, P <sub>B</sub> P <sub>R</sub> : 0.7 V [p-p] 75 Ω [For RGB input] 0.7 V[p-p] 75 Ω For G-SYNC: 1.0 V [p-p] 75 Ω HD/SYNC: 75 Ω, 1.4–5 Vp-p, positive/negative polarity automatically adjusted VD: 75 Ω, 1.4–5 Vp-p, positive/negative polarity automatically adjusted	

Model No.		PT-D10000U	PT-DW10000U
Interface ports	RGB2 input terminal	1 set of high-density, D-sub 15p (female) [For YP <sub>B</sub> P <sub>R</sub> input] Y: 1.0 V [p-p] synchronization signal included, P <sub>B</sub> P <sub>R</sub> : 0.7 V [p-p] 75 Ω [For RGB input] 0.7 V [p-p] 75 Ω For G-SYNC: 1.0 V [p-p] 75 Ω HD/SYNC: TTL, high-impedance, positive/negative polarity automatically adjusted VD: TTL, high-impedance, positive/negative polarity automatically adjusted • HD/SYNC, and VD terminals are not compliant with 3-value direct SYNC.	
	Video input/output terminal	1 set BNC 1.0 V [p-p] 75 Ω (Active through for Video output)	
	S-video input terminal	1 set Mini DIN 4p Y 1.0 V [p-p] C 0.286 V [p-p] 75 Ω Compliant with S1 signals	
	DVI-D input terminal	1 set DVI 1.0 compliant HDCP (Single link only) compatible	
	LAN terminal	1 set (Used for network connection) 10BASE-T/100BASE-TX PLink™ compatible	
	Serial input/output terminal	D-sub 9-pin (female/male), RS-232C compliant Used for personal computer control	
	Remote1 input/output terminal	1 set each for M3 pin jack Wired remote control, used for link control	
	Remote2 terminal	D-sub 9p (female) Used for external control	
Length of power supply cord		3.0 m (9.1')	
Cabinet		Molded resin	
Outside dimensions		Width: 578 mm (22.8"), Height : 320 mm (12.6"), Depth: 643 mm (25.3")	
Working environment condition		32 kg (71 lb) (without lens)	
Working environment condition		Ambient temperature <sup>*3</sup> : 0 °C to 45 °C Ambient humidity: 10 % to 80 % (no condensation)	
Remote control	Power source	3 V DC (two AA dry cells)	
	Operation range	approx. 30 m (98'5") (in front of beam receiver)	
	Mass	134 g (0.31 lb) (including dry cells)	
	Outside dimensions	Width: 51 mm (2"), Thickness: 23 mm (0.9"), Depth: 176 mm (6.9")	
Option		Hanging attachment (For high ceiling): ET-PKD100H Hanging attachment (For low ceiling): ET-PKD100S Projection lens: ET-D75LE1, ET-D75LE2, ET-D75LE3, ET-D75LE4, ET-D75LE5, ET-D75LE6, ET-D75LE8 DVI-D input module: ET-MD77DV SD-SDI input module: ET-MD77SD1 HD/SD-SDI input module: ET-MD77SD3 Replacement Lamp Unit: ET-LAD10000 (single bulb), ET-LAD1000F (4 bulbs)	

\*1 Interlace signals are not supported even when the EDID2 mode is selected.

\*2 70" – 300" for ET-D75LE5

\*3 If using the projector at high altitudes (1 400 m (4605.3') - 2 700 m (8881.5')), the ambient operating temperature should be 0°-40°C.

# Appendix

## Compatible RGB/YP<sub>B</sub>Pr/DVI-D Signals

The following table specifies the types of RGB/ YP<sub>B</sub>Pr/DVI-D signals compatible with the projector.

RGB signals can also be input within the range of fH=15 kHz–100 kHz, fV=24 Hz–120 Hz, dot clock=20 MHz–162 MHz.

Display mode	Number of displayed dots	Scanning frequency		Dot clock frequency (MHz)	Format
		H (kHz)	V (kHz)		
NTSC/NTSC4.43/PAL-M/PAL60	720 x 480i	15.7	59.9		VIDEO/S-VIDEO
PAL/PAL-N/SECAM	720 x 576i	15.6	50.0		VIDEO/S-VIDEO
480i	720 x 480i	15.7	59.9	13.5	YPbPr/RGB
576i	720 x 576i	15.6	50.0	13.5	YPbPr/RGB
480p	720 x 483	31.5	59.9	27.0	YPbPr/RGB/DVI(EDID1)
576p	720 x 576	31.3	50.0	27.0	YPbPr/RGB/DVI(EDID1)
1080/60 i	1 920 x 1 080i	33.8	60.0	74.3	YPbPr/RGB/DVI(EDID1)
1080/50 i	1 920 x 1 080i	28.1	50.0	74.3	YPbPr/RGB/DVI(EDID1)
1080/24p	1 920 x 1 080	27.0	24.0	74.3	YPbPr/RGB/DVI(EDID1)
1080/24sF	1 920 x 1 080i	27.0	24.0	74.3	YPbPr/RGB/DVI(EDID1)
1080/25p	1 920 x 1 080	28.1	25.0	74.3	YPbPr/RGB/DVI(EDID1)
1080/30p	1 920 x 1 080	33.8	30.0	74.3	YPbPr/RGB/DVI(EDID1)
1080/50p	1 920 x 1 080	56.3	50.0	148.5	YPbPr/RGB/DVI(EDID1)
1080/60p	1 920 x 1 080	67.5	60.0	148.5	YPbPr/RGB/DVI(EDID1)
720p/60p	1 280 x 720	45.0	60.0	74.3	YPbPr/RGB/DVI(EDID1)
720p/50p	1 280 x 720	37.5	50.0	74.3	YPbPr/RGB/DVI(EDID1)
VGA400	640 x 400	31.5	70.1	25.2	RGB/DVI(EDID2)
	640 x 400	37.9	85.1	31.5	RGB/DVI(EDID2)
VGA480	640 x 480	31.5	59.9	25.2	RGB/DVI(EDID1&EDID2)
	640 x 480	35.0	66.7	30.2	RGB/DVI(EDID2)
	640 x 480	37.9	72.8	31.5	RGB/DVI(EDID2)
	640 x 480	37.5	75.0	31.5	RGB/DVI(EDID2)
	640 x 480	43.3	85.0	36.0	RGB/DVI(EDID2)
SVGA	800 x 600	35.2	56.3	36.0	RGB/DVI(EDID2)
	800 x 600	37.9	60.3	40.0	RGB/DVI(EDID2)
	800 x 600	48.1	72.2	50.0	RGB/DVI(EDID2)
	800 x 600	46.9	75.0	49.5	RGB/DVI(EDID2)
MAC16	800 x 600	53.7	85.1	56.3	RGB/DVI(EDID2)
	832 x 624	49.7	74.6	57.3	RGB/DVI(EDID2)
	1 024 x 768	39.6	50.0	51.9	RGB/DVI(EDID2)
	1 024 x 768	48.4	60.0	65.0	RGB/DVI(EDID2)
XGA	1 024 x 768	56.5	70.1	75.0	RGB/DVI(EDID2)
	1 024 x 768	60.0	75.0	78.8	RGB/DVI(EDID2)
	1 024 x 768	65.5	81.6	86.0	RGB/DVI(EDID2)
	1 024 x 768	68.7	85.0	94.5	RGB/DVI(EDID2)
	1 024 x 768i	35.5	87.0	44.9	RGB
	1 024 x 768	80.0	100.0	105.0	RGB/DVI(EDID2)
	1 024 x 768	96.7	120.0	130.0	RGB/DVI(EDID2)
	1 024 x 768	96.7	120.0	130.0	RGB/DVI(EDID2)
MXGA	1 152 x 864	64.0	71.2	94.2	RGB/DVI(EDID2)
	1 152 x 864	67.5	74.9	108.0	RGB/DVI(EDID2)
	1 152 x 864	76.7	85.0	121.5	RGB/DVI(EDID2)
WXGA	1 280 x 800	41.3	50.0	68.0	RGB/DVI(EDID2)
	1 280 x 800	49.7	59.8	83.5	RGB/DVI(EDID2)
	1 280 x 768	47.8	59.9	79.5	RGB/DVI(EDID2)
MAC21	1 152 x 870	68.7	75.1	100.0	RGB/DVI(EDID2)
MSXGA	1 280 x 960	60.0	60.0	108.0	RGB/DVI(EDID2)
SXGA	1 280 x 1 024	52.4	50.0	88.0	RGB/DVI(EDID2)
	1 280 x 1 024	64.0	60.0	108.0	RGB/DVI(EDID2)
	1 280 x 1 024	72.3	66.3	125.0	RGB/DVI(EDID2)
	1 280 x 1 024	78.2	72.0	135.1	RGB/DVI(EDID2)
	1 280 x 1 024	80.0	75.0	135.0	RGB/DVI(EDID2)
	1 280 x 1 024	91.1	85.0	157.5	RGB/DVI(EDID2)
SXGA+	1 400 x 1 050	65.2	60.0	122.6	RGB/DVI(EDID2)
	1 400 x 1 050	78.8	72.0	149.3	RGB/DVI(EDID2)
	1 400 x 1 050	82.2	75.0	155.9	RGB/DVI(EDID2)
UXGA	1 600 x 1 200	75.0	60.0	162.0	RGB/DVI(EDID2)

### Note

- The number of display dots of the PT-D10000U is 1 400 x 1 050. If signals with a number of display dots differing from the data listed above are supplied, they will be converted into signals with 1 400 x 1 050 dots and displayed.
- The number of display dots of the PT-DW10000U is 1 920 x 1 080. If signals with a number of display dots differing from the data listed above are supplied, they will be converted into signals with 1 920 x 1 080 dots and displayed.
- Character "i" that follows the number of displayed dots stands for interlace signal.
- Flicker (line flicker) will be caused in images if interlace signals are connected.

## List of P IN P

Subwindow Main window		RGB1		RGB2		VIDEO input	S-VIDEO input	DVI		AUX				
		RGB input	YPbPr input	RGB input	YPbPr input			EDID1	EDID2	ET- MD77SD1	ET- MD77SD3*1	ET-MD77DV		
RGB1	RGB input	x	x	x	x	o	o	o	o	o	o	o	o	
	YPbPr input	x	x	x	x	x	x	x	o	x	x	x	o	
RGB2	RGB input	x	x	x	x	o	o	o	o	o	o	o	o	
	YPbPr input	x	x	x	x	x	x	x	o	x	x	x	o	
VIDEO input		o	x	o	x	x	x	x	o	x	x	x	o	
S-VIDEO input		o	x	o	x	x	x	x	o	x	x	x	o	
DVI	EDID1	o	x	o	x	x	x	x	x	x	x	x	o	
	EDID2 (PC)	o	o	o	o	o	o	x	x	o	o	o	o	
AUX	ET-MD77SD1	o	x	o	x	x	x	x	o	x	x	x	x	
	ET-MD77SD3*1	o	x	o	x	x	x	x	o	x	x	x	x	
	ET- MD77DV	EDID1*2	o	x	o	x	x	x	x	o	x	x	x	x
		EDID2	o	o	o	o	o	o	o	o	x	x	x	x

o: P IN P (Picture in Picture) combinations are enabled  
x: P IN P (Picture in Picture) combinations are disabled

\*1 480i, 576i, 720/60p, 720/50p, 1 035/60i, 1 080/60i, 1 080/50i, 1 080/24sF, 1 080/30p, 1 080/25p, 1 080/24p

\*2 480p, 576p, 720/60p, 720/50p, 1 080/60i, 1 080/50i, 1 080/24sF, 1 080/30p, 1 080/25p,  
1 080/24p, 1 080/60p, 1 080/50p

### Note

- Noise reduction cannot be used with analog RGB input, DVI input (EDID1 setting) or AUX input (EDID1 setting).
- For the PT-DW10000U, the picture quality for the sub window will deteriorate if the size of the main window is 75 % or more and the size of the sub window is 50 % or more.



# Dimensions

## Outside dimensions

unit : mm (inch)

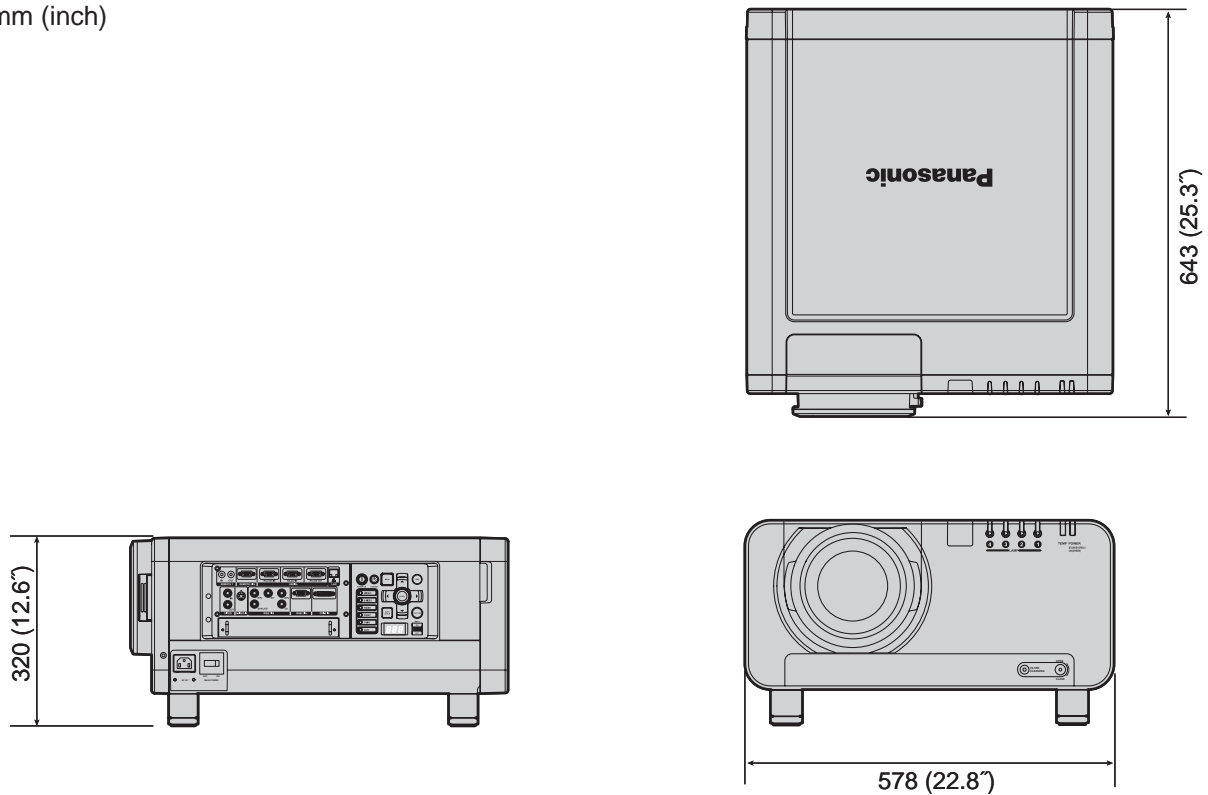

## Installation dimensions diagram

(Figure 1 : Dimensions applying when one unit is used)

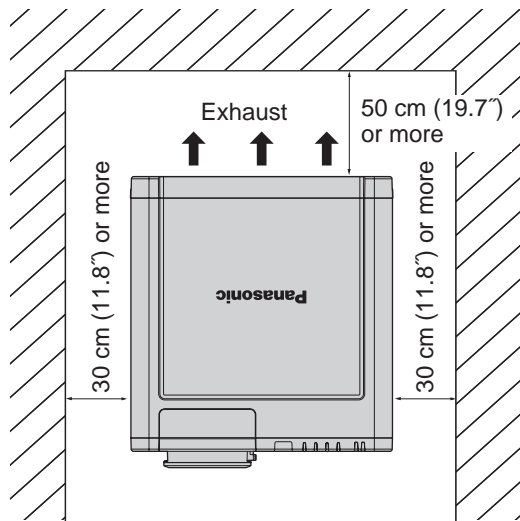

(Figure 2 : Dimensions applying when two units are used)

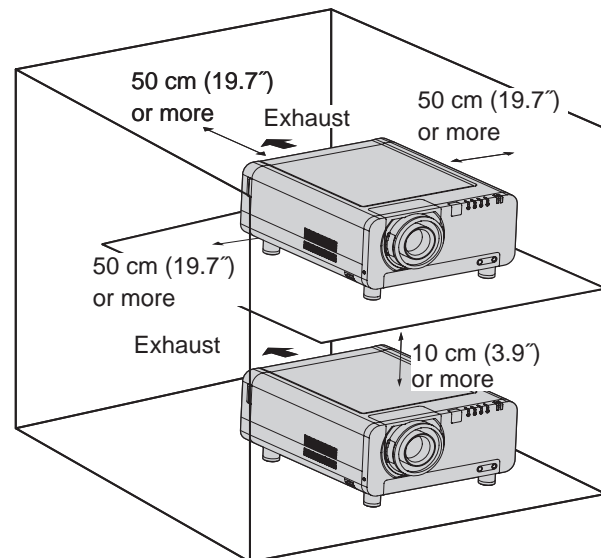

### Attention

- Leave a clearance of at least 50 cm (19.7") so that the ventilation opening on the rear panel will not be blocked.
- Set up the projector so that air can flow freely around the rear of the projector without staying still. In addition, leave a space of 30 cm (11.8") or more at the sides so that the hot air coming out from the air outlet vents does not get drawn in through the air intake vents.
- When the projector is to be placed inside a box and used, leave the clearances shown in Fig. 2 and ensure that the temperature during operation remains within the 0 °C to 35 °C range.

# Index

Be sure to read the “IMPORTANT SAFETY NOTICE” and the “Precautions with regard to safety”. (pp. 4-9)

## A

Accessories ..... 10  
Adjusting Brightness..... 50  
Adjusting Color ..... 50  
Adjusting color matching ..... 67–69  
Adjusting Contrast ..... 50  
Adjusting the aspect ratio ..... 57  
Adjusting the clamp position..... 62  
Adjusting the color temperature..... 51  
Adjusting the feet..... 20  
Adjusting the input resolution ..... 61  
Adjusting the zoom ratio ..... 58  
Adjusting Tint..... 51  
Air filter cleaning ..... 80–81  
Altitude..... 76  
Automatic adjustment ..... 44, 70  
Auto signal..... 70  
AUX DVI EDID..... 72

## B

Back Color ..... 71  
Basic operations on menu screen .... 48  
Before asking for service ..... 113  
Blanking adjustment ..... 61

## C

Changing the password..... 100  
Changing the text ..... 101  
Cleaning and replacement of  
air filter ..... 108–109  
Clock phase adjustment ..... 58  
Compatible RGB/YPbPr/DVI-D  
Signals ..... 118  
Connecting the power cord..... 34  
Connecting with personal  
computers..... 26  
Connecting with VIDEO devices..... 25

## D

Digital cinema reality ..... 60  
Direction ..... 77  
DVI-D input module ..... 32  
DVI EDID ..... 71  
Dynamic iris setting ..... 53

## E

Edge blending adjustment ..... 62–64  
Effective range of remote control  
operation..... 17

## F

Frame delay..... 64

## G

Gamma setting ..... 52

## H

HD/SD-SDI input module..... 31  
How to adjust the lens ..... 37–39  
How to install and remove the  
projection lens ..... 33

## I

Indication of monitor lamp ..... 107  
Installation dimensions diagram .... 120  
Installation Setting ..... 76  
Installing the input module..... 27–28

## K

Keystone distortion correction ..... 59

## L

Lamp relay..... 79  
Lamp select ..... 78  
Lamp unit replacement..... 111  
Large Screen Correction ..... 69  
List of P IN P..... 119

## M

Main menu..... 46  
Maintenance ..... 11

## N

Network connections ..... 86  
Network function..... 84–97  
Noise reduction setting..... 53  
Notes when installing the ceiling  
mount bracket..... 112

## O

On-screen display function ..... 43  
OSD memory ..... 74  
Output resolution ..... 77  
Outside dimensions ..... 120

## P

P IN P ..... 72–73  
Position of on-screen indications..... 74  
Power indicator lamp ..... 34  
Powering off the projector..... 36  
Powering up the projector..... 35  
Projection scheme ..... 20

## R

Raster position..... 65  
Registered signals ..... 40–41  
Registering the picture mode  
settings as presets..... 54  
Remote 2 terminal ..... 106  
RS-232C setting ..... 79

## S

SD-SDI input module..... 30  
Self-diagnosis display..... 114–115  
Serial terminals..... 102–105  
Setting a projector ID..... 75  
Setting FUNC1 ..... 73  
Setting projector ID number to  
remote control..... 18  
Setting the date and time..... 81  
Setting the password ..... 99  
Setting the text..... 100  
Sharpness setting..... 52  
Shift adjustment..... 56  
Specifications ..... 116–117  
sRGB ..... 55  
Startup logo ..... 82  
Status function..... 43  
Sub memory ..... 41–42  
Sub menu ..... 46–47  
Switching the input signal ..... 43  
Switching the picture mode ..... 49  
System format ..... 54  
System information..... 80

## T

Test pattern ..... 83

## U

Using the PJLink™ protocol ..... 98  
Using the SHUTTER function..... 43

## W

Wired remote control ..... 18

**Note:**

Purchase of this equipment includes the rights to use this software (the built-in microcomputer and information recorded on ROMs) but does not grant copyrights. Do not reverse engineer, change or modify the software. The guarantee will not be valid for any malfunctions caused by such actions.

**Trademark Acknowledgement**

- Digital Light Processing, DLP, and DLP® CHIP are registered trademarks of the Texas Instruments.
- VGA and XGA are trademarks of International Business Machines Corporation.
- S-VGA is a registered trademark of the Video Electronics Standards Association.
- “Microsoft Windows” is a registered trademark of the Microsoft Corporation (U.S.A.) in the U.S. and other countries.
- “Netscape” and “Netscape Navigator” are registered trademarks of the Netscape Communications Corporation in the U.S. and other countries.
- HDMI, the HDMI logo and High-Definition Multimedia Interface are the trademarks or registered trademarks of HDMI Licensing LLC.
- Patent No. 5,717,422

All other trademarks are the property of the various trademark owners.

# NOTES IMPORTANTES CONCERNANT LA SÉCURITÉ

**AVERTISSEMENT:**  
POUR RÉDUIRE LES RISQUES DE FEU OU DE CHOC ÉLECTRIQUE, NE PAS EXPOSER CE PRODUIT À L'EAU OU À L'HUMIDITÉ

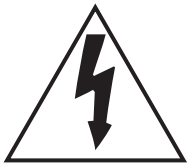
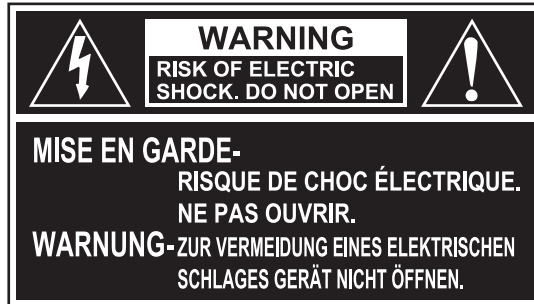

Le symbole de la flèche en forme d'éclair, dans un triangle, avertit l'utilisateur de la présence de "tensions dangereuses" à l'intérieur du produit qui peuvent être de force suffisante pour constituer un risque de choc électrique aux personnes.



Le point d'exclamation dans un triangle avertit l'utilisateur de la présence d'instructions importantes concernant l'utilisation et l'entretien (réparation) dans la littérature accompagnant le produit.

## ATTENTION:

Cet appareil est équipé d'une fiche de courant à trois broches avec mise à la terre. Ne pas retirer la broche de mise à la masse de la fiche. Cette fiche ne pourra être utilisée que dans une prise avec mise à la terre. Ceci est une précaution sécuritaire. S'il est impossible d'insérer la fiche dans la prise, s'adresser à un électricien. Ne pas annuler la protection de la fiche à mise à la terre.

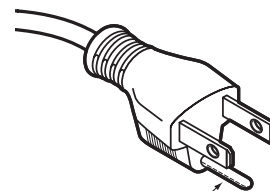

Ne pas retirer

## AVERTISSEMENT:

Ne peut être utilisé dans une salle d'ordinateurs telle que définie dans la norme ANSI/NFPA 75 Standard for Protection of Electronic Computer/Data Processing Equipment.

# Précautions de sécurité

## AVERTISSEMENT

- **En cas de problème (comme par exemple une absence d'image) ou si vous remarquez que de la fumée ou une odeur suspecte s'échappe du projecteur, couper immédiatement l'alimentation du projecteur, puis débrancher le cordon d'alimentation de la prise du secteur.**
  - Ne pas continuer d'utiliser le projecteur dans ces cas, autrement cela peut entraîner un incendie ou des chocs électriques.
  - Après s'être assuré que de la fumée ne se dégage plus, s'adresser à un centre technique agréé et demander que les réparations nécessaires soient faites.
  - Le fait de réparer le projecteur soi-même est très dangereux, et ne doit jamais être fait.
- **Ne pas installer ce projecteur dans un endroit qui n'est pas assez résistant pour supporter le poids du projecteur.**
  - Si l'emplacement d'installation n'est pas assez résistant, le projecteur risque de tomber et de causer de graves blessures et (ou) des dommages.
  - Demander à un technicien qualifié d'installer le projecteur par exemple s'il est installé au plafond.
  - Si l'installation n'est pas faite correctement, cela peut entraîner des blessures ou des chocs électriques.
- **En cas de pénétration de corps étrangers ou d'éclaboussures à l'intérieur du projecteur, de chute du projecteur ou de brisure du boîtier, couper immédiatement l'alimentation, puis débrancher le cordon d'alimentation de la prise du secteur.**
  - Si l'on continue d'utiliser le projecteur dans ces conditions, cela peut entraîner un incendie ou des chocs électriques.
  - S'adresser à un centre technique agréé pour que les réparations nécessaires puissent être faites.
- **Ne jamais recouvrir le filtre à air, l'orifice d'admission d'air et les orifices de ventilation.**
  - Cela risque de faire surchauffer le projecteur, et causer un incendie ou endommager le projecteur.
- **Ne pas surcharger la prise du secteur.**
  - Si l'alimentation est surchargée (par exemple, par l'utilisation de trop d'adaptateurs), cela risque de faire surchauffer le projecteur et peut entraîner un incendie.
- **Ne pas retirer le capot ou le modifier.**
  - L'intérieur du projecteur, soumis à des tensions élevées, présente en effet un grand danger d'incendies ou de chocs électriques.
  - Pour toute inspection, réglage ou réparation, s'adresser à un centre technique agréé.
- **Nettoyer régulièrement le cordon d'alimentation afin d'éviter qu'il ne se recouvre de trop de poussières.**
  - En effet, une trop importante accumulation de poussières au niveau de la fiche du cordon d'alimentation présente un risque d'endommagement de l'isolation électrique de la prise, ce qui pourrait causer un incendie. Retirer le cordon d'alimentation avant de le nettoyer à l'aide d'un linge sec.
  - Toujours débrancher le cordon d'alimentation de la prise du secteur lorsque le projecteur ne sera pas utilisé pendant une période prolongée.
- **Toute manipulation ou procédure risquant d'endommager le cordon ou la fiche du cordon d'alimentation est strictement interdite.**
  - Ne jamais endommager le cordon d'alimentation, ou l'altérer de quelque forme que ce soit, le placer à proximité de sources de chaleur, le plier, le tordre excessivement, tirer dessus, placer des objets lourds dessus ou le rembobiner.
  - Il est possible que des chocs électriques, des courts-circuits ou un incendie soient produits par tout endommagement du cordon d'alimentation.
  - Contacter un centre de service autorisé pour toute réparation du cordon d'alimentation qui s'avérerait nécessaire.
- **Ne jamais manipuler la fiche du cordon avec les mains mouillées.**
  - Cela peut entraîner des chocs électriques.

■ **Introduire fermement la fiche du cordon d'alimentation dans une prise du secteur.**

- Si la fiche n'est pas complètement insérée, cela peut entraîner des chocs électriques ou la faire surchauffer.
- Ne jamais utiliser des fiches endommagées ou des prises incorrectement montées au mur.

■ **Ne pas placer le projecteur sur des surfaces instables.**

- Si le projecteur est placé sur une surface qui est inclinée ou instable, il risque de tomber ou de se renverser et cela pourrait causer des blessures ou des dommages.

■ **Ne pas placer le projecteur dans l'eau et ne pas le laisser se mouiller.**

- Sinon cela peut causer un incendie ou des chocs électriques.

■ **Ne jamais démonter la lampe.**

- Toute rupture de la lampe risquerait en effet de causer de graves blessures.

■ **Ne pas placer des récipients contenant des liquides sur le projecteur.**

- Si de l'eau se renverse sur le projecteur ou pénètre dans celui-ci, il y aura risque d'incendie ou d'électrocution.
- Si de l'eau entre à l'intérieur du projecteur, contacter un centre technique agréé.

■ **Ne pas mettre d'objets étrangers dans le projecteur.**

- Ne pas insérer d'objets métalliques ou inflammables dans les orifices de ventilation ou les faire tomber sur le projecteur, car cela peut causer un incendie ou des chocs électriques.

■ **Après avoir retiré la pile de la télécommande, la tenir hors de portée des enfants.**

- La pile risque en effet de causer une mort par asphyxie si elle est avalée.
- Rechercher immédiatement le secours d'un médecin si la pile a été avalée par quelqu'un.

■ **Ne jamais laisser les bornes + et – de la pile entrer en contact avec des objets métalliques, tels que des colliers ou des barrettes par exemple.**

- En effet, ceci risquerait de causer une fuite du courant de la pile, voire une surchauffe, une explosion ou même un incendie.
- Conserver la pile dans un sac en plastique, à l'écart de tout objet métallique.

■ **Isoler la pile avec du ruban adhésif ou autre matériau similaire avant de la mettre au rebut.**

- La pile risquerait en effet de prendre feu ou même d'exploser en cas de contact avec d'autres objets métalliques ou des piles.

■ **Le remplacement de la lampe ne devrait être confié qu'à un technicien qualifié.**

- L'unité de la lampe est soumise à de très fortes pressions internes. Une mauvaise manipulation risquerait d'entraîner une défaillance.
- La lampe risque en effet de s'endommager très facilement en cas de chute ou de choc violent, ce qui pourrait causer des blessures ou des défaillances.

■ **En cas d'installation au plafond, s'assurer d'utiliser le fil accessoire (à installer à un endroit différent que le support de montage au plafond) ainsi que les œillets correspondants, en tant que mesure de sécurité supplémentaire visant à empêcher toute chute du projecteur.**

- Des accidents pourraient en effet être causés par une mauvaise fixation du projecteur.

■ **Ne pas placer plusieurs kits les uns sur les autres.**

- Des accidents pourraient être causés par un non-respect de cette mise en garde.

## Précautions concernant la sécurité (suite)

### Mise en garde

- **Ne pas installer le projecteur dans des endroits humides ou poussiéreux, ou dans des endroits où le projecteur peut entrer en contact avec des fumées grasses ou de la vapeur.**
  - L'utilisation du projecteur dans de telles conditions pourrait causer un incendie ou des chocs électriques.
- **Si vous désirez débrancher le cordon d'alimentation, tirer sur la fiche et non pas sur le cordon directement.**
  - Le fait de tirer directement sur le cordon d'alimentation risquerait en effet de l'endommager très rapidement et risquerait de causer un incendie, des courts-circuits ou de graves chocs électriques.
- **Débrancher toujours tous les câbles avant de déplacer le projecteur.**
  - Le fait de déplacer le projecteur avec des câbles branchés peut endommager les câbles, ce qui pourrait causer un incendie ou des chocs électriques.
- **Ne pas placer d'objets lourds sur le projecteur.**
  - Cela peut déséquilibrer le projecteur et le faire tomber, ce qui peut entraîner des dommages ou des blessures.
- **Ne jamais court-circuiter, chauffer ou démonter la pile ou la jeter à l'eau ou au feu.**
  - Le non-respect de cette mise en garde risquerait en effet de provoquer une surchauffe, une fuite, une explosion ou une mise à feu de la pile, ce qui risquerait de causer des brûlures ou d'autres blessures graves.
- **Respecter à tout moment la polarité de la pile (+ et –), notamment lors de son insertion.**
  - En effet, si la pile n'est pas correctement placée, ceci risquerait de causer une explosion, une fuite, un incendie, des blessures ou une contamination du compartiment des piles et de ses alentours.
- **N'utiliser que le type de piles spécifié.**
  - L'utilisation d'un type de pile incorrect pourrait entraîner une explosion, une fuite, un incendie, des blessures ou une contamination du compartiment des piles et de ses alentours, ce qui, d'une façon générale, pourrait causer des brûlures ou des dommages matériels.
- **Ne pas regarder directement dans l'objectif pendant que le projecteur fonctionne.**
  - Une lumière intense est émise par l'objectif du projecteur. Si l'on regarde directement dans cette lumière, elle risque de causer des blessures et de graves lésions oculaires.
- **Veillez à ce que le faisceau lumineux n'éclaire pas directement votre peau pendant que vous utilisez le projecteur.**
  - Une lumière intense est émise par l'objectif du projecteur. Si vous vous placez dans ce faisceau lumineux, celui-ci risquera de vous blesser ou de vous abîmer la peau.
- **Ne jamais placer les mains ou d'autres objets à proximité des orifices d'évacuation de l'air.**
  - De l'air chaud sort est émis par les orifices d'évacuation de l'air. Par conséquent, ne jamais placer à proximité les mains, le visage ou d'autres parties de votre corps très sensibles à la chaleur.
- **Ne jamais réutiliser une lampe usagée.**
  - La lampe risquerait en effet d'exploser.
- **Le remplacement de la lampe ne devrait être effectué qu'après lui avoir laissé le temps de se refroidir, car vous risqueriez de vous brûler sérieusement dans le cas contraire.**
- **Débrancher le cordon d'alimentation de la prise du secteur à titre préventif avant d'entreprendre tout nettoyage.**
  - Sinon cela peut causer des chocs électriques.

■ **Si la lampe est brisée, aérer la salle immédiatement. Ne pas toucher ou approcher le visage des morceaux brisés.**

- Sinon, l'utilisateur risquera d'inhaler le gaz qui s'est dégagé lorsque la lampe s'est brisée, et qui contient à peu près la même quantité de mercure que les lampes fluorescentes, et d'être blessé par les morceaux brisés.
- Si l'on pense avoir inhalé le gaz, ou que le gaz a pénétré dans les yeux ou la bouche, consulter immédiatement un médecin.
- Demander à son revendeur de remplacer l'unité de lampe et de vérifier l'intérieur du projecteur.

■ **Demander à un centre technique agréé de nettoyer l'intérieur du projecteur au moins une fois par an.**

- S'il n'est pas nettoyé et que de la poussière s'accumule à l'intérieur du projecteur, cela peut causer un incendie ou des problèmes de fonctionnement.
- Il est recommandé de nettoyer l'intérieur du projecteur avant l'arrivée de la saison des pluies. Demander au centre technique agréé le plus proche de nettoyer le projecteur lorsque cela est requis. Se renseigner auprès du centre technique agréé pour le coût du nettoyage.

■ **Ne pas introduire les doigts dans les ouvertures situées de chaque côté de l'objectif pendant les déplacements à l'horizontale ou à la verticale, car ceci pourrait causer des blessures.**

■ **Dans le cadre du respect de l'environnement, ramener toute unité non réparable à votre revendeur ou société de recyclage.**

■ **Ne jamais utiliser le projecteur lorsque les pieds réglables ou l'objectif de projection sont retirés.**



- Dans le cas contraire, des accidents ou des défaillances risqueraient de se produire.



# Avant l'utilisation

## Accessoires

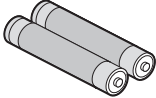
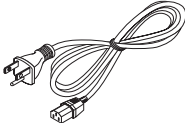
Vérifier que tous les accessoires ci-dessous sont bien compris avec votre projecteur.

Télécommande [N2QAYB000076 x 1]	Piles de la télécommande (AA)	Cordon d'alimentation [K2CG3YY00015 x 1]	Support anti-chutes	
			Oeillet [THEA172J x 4]	Fil [TTRA0144 x 4]
				

## Mise en garde concernant les déplacements du projecteur

L'objectif de projection est très sensible aux vibrations et aux impacts. Par conséquent, démonter à chaque fois l'objectif avant tout transport.

## Mises en garde concernant la configuration

Respecter les précautions suivantes pendant toute l'installation du produit.

■ **Veillez à installer le couvercle de l'objectif de projection avant d'installer l'objectif de projection.**

Dans le cas contraire, de la poussière risquerait de s'accumuler à l'intérieur du projecteur et de causer des problèmes.

■ **Eviter d'installer cet appareil à un endroit soumis à de fortes vibrations ou à des impacts violents.**

En effet, si le projecteur est installé à un endroit où des vibrations sont transmises à partir d'une source de puissance ou monté dans une voiture ou un autre véhicule, les vibrations et les impacts pourraient être transmis aux composants du produit et conduire à des défaillances techniques. Installer donc le produit à un emplacement soumis à aucun(e) impact ou vibration.

■ **Ne jamais installer le projecteur à proximité de lignes haute tension ou de sources d'alimentation.**

L'appareil risquerait en effet d'être exposé à des interférences en cas d'installation à proximité de lignes haute tension ou de sources d'alimentation.

■ **Ne pas placer le projecteur sur une surface ou tapis en vinyle.**

En cas d'aspiration de la surface en vinyle par l'orifice d'aspiration d'air, il y a un risque de blocage de l'arrivée d'air, ce qui entraînera une hausse de la température interne, suivie d'un déclenchement du circuit de protection et de l'arrêt du projecteur.

■ **Consulter un technicien spécialisé avant toute installation au plafond.**

Lorsque l'appareil doit être accroché au plafond, il sera nécessaire d'acheter un accessoire de montage au plafond (pour plafonds hauts : N° de modèle ET-PKD100H) (pour plafonds bas : N° de modèle ET-PKD100S) et de contacter un technicien spécialisé pour son installation.

■ **Ne jamais utiliser le projecteur à une altitude dépassant les 2 700 m (8881.5') au-dessus du niveau de la mer. Pour des utilisations dépassant les 1 400 m (4605.3') au-dessus du niveau de la mer, configurer le paramètre "ALTITUDE", comme décrit à la page 76, sur la valeur "HAUTE".**

La durée de vie de l'appareil risquerait d'être raccourcie dans le cas contraire.

## Remarques concernant l'utilisation

### ■ Pour voir des images trop claires :

- Votre public aura du mal à voir correctement les images à fort contraste et brillance lorsque de la lumière naturelle ou en provenance d'une source de lumière interne vient illuminer directement la surface de l'écran. Par conséquent, tirer les rideaux ou stores des fenêtres, éteindre les sources de lumière proches de l'écran et prendre d'une manière générale toutes les mesures qui s'imposent.
- Dans certains cas peu fréquents, dépendant avant tout des conditions de projection, il est possible que des parasites se forment à l'écran en raison de l'air chaud s'échappant du port d'évacuation d'air. S'assurer qu'aucun appareil capable de recirculer l'air chaud évacué du projecteur en face de celui-ci ou d'un autre appareil proche.

### ■ Ne jamais toucher la surface de l'objectif de projection avec les mains nues.

Toute trace d'empreintes digitales ou tache laissée sur l'objectif sera en effet agrandie par ce dernier et particulièrement visible sur l'écran pendant les projections. Garder vos mains à distance de l'objectif. Placer le couvercle sur l'objectif lorsqu'il n'est pas utilisé.

### ■ Écran

Il sera impossible d'obtenir une image nette si l'écran présente des taches, des défauts ou des altérations de teinte quelconques. Lors de toute opération concernant l'écran, faire attention à ne jamais appliquer des substances volatiles, ainsi que d'y laisser des taches ou des défauts.

### ■ Lampe

La source de lumière utilisée dans cet appareil est une lampe au mercure à haute pression interne. Toute lampe au mercure à haute pression présente les caractéristiques suivantes :

- Elle risque d'exploser en émettant un bruit fort ou de ne plus émettre de lumière à la fin de sa durée de vie, en raison des impacts reçus, des défauts ou des détériorations subies pendant son utilisation.
- La durée de vie d'une lampe au mercure dépend fortement des conditions d'utilisation auxquelles elle est soumise. Elles sont tout particulièrement sensibles aux commutations marche/arrêt fréquentes et/ou à répétitions.
- Dans certains cas très rares, elle risque d'exploser quelques temps après son premier allumage.
- La probabilité d'explosion de la lampe augmente plus elle est utilisée au-delà de sa durée d'utilisation.

### ■ Entretien

S'assurer à chaque fois de bien retirer la fiche du cordon d'alimentation de son logement sur l'appareil avant tout nettoyage.

- **Utiliser un linge propre et sec pour le nettoyage du boîtier.**  
Utiliser un linge sec imbibé d'eau tiède pour essuyer toute trace d'huile. Si vous désirez utiliser un produit chimique, veuillez suivre les instructions fournies.
- **Ne jamais nettoyer la surface de l'objectif avec un linge pelucheux ou poussiéreux.**  
Toute poussière ayant été déposée sur l'objectif sera en effet agrandie et bien visible à l'écran. N'essuyer la saleté et la poussière qu'avec un chiffon doux.

## Mise au rebut

Contactez votre revendeur ou un revendeur spécialisé avant toute mise au rebut de l'appareil.

# Remplacement de la lampe

## MISE EN GARDE

- Attendre jusqu'à ce que la lampe ait eu le temps de se refroidir avant de remplacer la lampe.
- S'assurer que les quatre unités de lampe ont été installées.
- Le remplacement de la lampe ne devrait être confié qu'à un technicien qualifié.

## Précautions à prendre lors du remplacement de la lampe

- Faire très attention lors de la manipulation de la lampe. En effet, l'unité de la lampe est soumise à de très fortes pressions internes. Une mauvaise manipulation risquerait d'entraîner une défaillance.
- Une lampe usée risque même d'exploser en cas de manipulation violente. Contacter un prestataire de services spécialisé dans le traitement de déchets industriels pour la mise au rebut des lampes usagées.
- La lampe risque d'exploser en cas d'utilisation dépassant la durée de remplacement.
- Un tournevis cruciforme est nécessaire au remplacement de la lampe. Faire attention aux mouvements de la main lors de l'utilisation du tournevis à proximité de la lampe.

## Attention

- L'unité de la lampe est une pièce en option. Consulter votre revendeur pour plus de détails à propos des commandes.

**N° de modèle de l'unité de remplacement de la lampe :** ET-LAD10000 (ampoule simple), ET-LAD1000F  
(4 ampoules)  
Puissance : 250 W

- Des lampes autres que celles spécifiées ci-dessus ne devront en aucun cas être utilisées. N'utiliser que les types de lampe spécifiés.

## Intervalle de remplacement de la lampe

Toute lampe utilisée en tant que source de lumière a une durée de vie limitée. La durée de vie de la lampe utilisée dans ce projecteur est de 2000 heures. Cependant, il est possible que la lampe soit morte (ne s'allume pas) avant ces 2000 heures, selon les caractéristiques de chaque lampe et de ses conditions d'utilisation (la durée de vie d'une lampe peut en effet être affectée par le nombre de fois où elle a été allumée et éteinte et par les intervalles qui les séparent). Il est par conséquent fortement conseillé de toujours avoir une ampoule de rechange à portée de main.

Lorsqu'une lampe n'a pas été remplacée après 2000 heures d'utilisation, cette lampe sera automatiquement éteinte. Si la durée d'utilisation de toutes les lampes dépasse les 2000 heures, le courant sera automatiquement coupé 10 minutes après le démarrage, et le projecteur passera en mode de veille.

## Attention

- Nettoyer et remplacer le filtre à air à chaque remplacement des unités de lampes. (pp. 108–109)

## ■ Indication après 1800 heures

Lorsqu'une lampe a été utilisée pendant plus de 1800 heures, le témoin de la lampe correspondante (LAMP1, LAMP2, LAMP3 ou LAMP4) s'allumera, même en mode de veille.

De plus, un message s'affichera à l'écran pendant environ 30 secondes comme indiqué sur la figure ci-contre, demandant un remplacement de la lampe correspondante. (L'indication de la figure ci-dessous disparaît après environ 30 secondes ou dès qu'on appuie sur une des touches à l'arrière de l'appareil ou de la télécommande.)

Après une durée d'utilisation de 2000 heures, le message restera affiché en permanence à l'écran, et ne disparaîtra qu'à condition d'appuyer sur la touche du menu (MENU).



## Procédure de remplacement de la lampe

1. Respecter à tout prix la procédure d' "Mise en marche du projecteur" (p. 35) et "Arrêt du projecteur" (p. 36), retirer la fiche du cordon d'alimentation, puis attendre que le voisinage de la lampe ait eu le temps de refroidir.

2. Dévisser, à l'aide d'un tournevis cruciforme (Phillips), la vis du couvercle de l'unité de la lampe à l'arrière du projecteur jusqu'à ce qu'elle puisse tourner librement.
3. Ouvrir le couvercle de la lampe puis retirer cette dernière du projecteur.

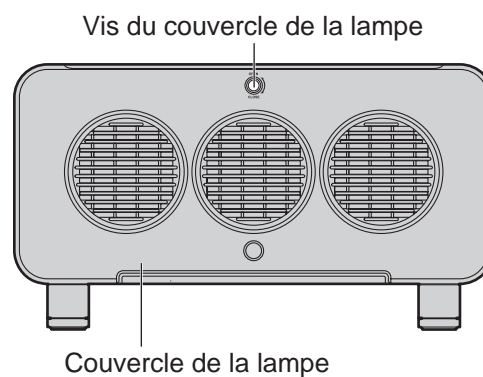

4. Dévisser, à l'aide d'un tournevis cruciforme (Phillips), les trois vis de fixation de la lampe à remplacer jusqu'à ce qu'elles puissent tourner librement. Tout en tenant doucement l'unité de la lampe par sa poignée, continuer à tirer dessus jusqu'à l'extraire complètement du projecteur.

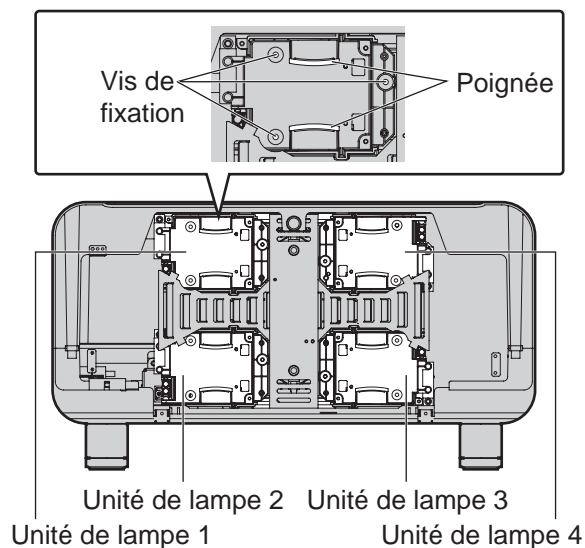

### MISE EN GARDE

La lampe ainsi que les pièces se trouvant à proximité sont toujours extrêmement chaudes juste après l'utilisation du projecteur.

Vous risquez de très graves brûlures en cas de non-respect de cette mise en garde.

5. Installer la nouvelle unité de lampe.
6. Resserrer à l'aide d'un tournevis cruciforme les 3 vis de fixation de la lampe pour chaque unité de lampe.

7. Installer puis refermer le couvercle de la lampe, avant de revisser à l'aide d'un tournevis cruciforme, les vis de fixation du couvercle.

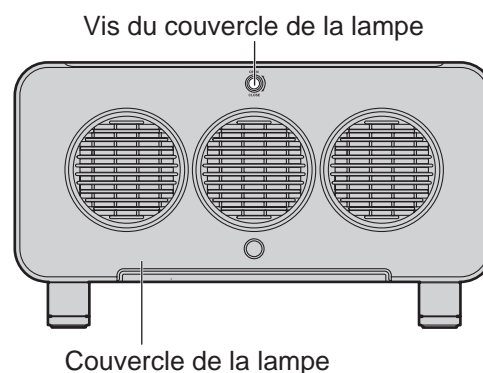

### Mise en garde

- Installer fermement la lampe ainsi que le couvercle de la lampe. En effet, dans le cas contraire, le circuit de protection ne fonctionnera pas correctement et l'appareil ne pourra pas s'allumer.

---

# Panasonic<sup>®</sup>

Projectors

---

**Panasonic Projector Systems Company**

Unit of Panasonic North America

One Panasonic Way 4B-9 Secaucus, NJ 07094 (201) 392-6591  
3330 Cahuenga Blvd West Los Angeles, CA 90068 (323) 436-3500

**Technical Support:**

(800) 524-1448

(800) 526-6610

FAX: (201) 392-6514

E-Mail: [pjscsupport@us.panasonic.com](mailto:pjscsupport@us.panasonic.com)

---

**Panasonic Canada Inc.**

5770 Ambler Drive, Mississauga, Ontario L4W 2T3 (905) 624-5010

© 2006 Matsushita Electric Industrial Co., Ltd. All Rights Reserved.