

myprojectorlamps.com

**The most trusted, dependable name
in projector lamp sales.**



<http://www.myprojectorlamps.com>



<http://www.myprojectorlamps.ca>



<http://www.myprojectorlamps.eu>

The following projector manual has not been modified or altered in any way.

Operating Instructions

DLPTM based Projector

Models No. **PT-D9500U**
PT-D9600U



Panasonic®

Read these instructions completely before operating this unit.

TQBJ0060

Dear Panasonic Customer:

This instruction booklet provides all the necessary operating information that you might require. We hope it will help you to get the most performance out of your new product, and that you will be pleased with your Panasonic DLP™ based projector.

The serial number of your product may be found on its back. You should note it in the space provided below and retain this booklet in case service is required.

Model number: **PT-D9500U / PT-D9600U**

Serial number: _____

Contents

1. Product outline	3
2. Features.....	3
3. IMPORTANT SAFETY NOTICE.....	5
4. Precautions with regards to safety.....	6
5. Precaution on handling.....	8
6. Name and function of each part.....	10
7. Name and function of each remote control part.....	11
8. Before using the remote control unit.....	13
• Using the remote control with the cable.....	14
9. Turning the power on and off.....	15
10. On-screen menu operation guide.....	16
11. Before using the projector.....	17
• Installing the projection lens.....	17
12. Setting up the projector.....	18
13. Projection distance for each projection lens (sold separately)	20
14. Adjusting projector feet.....	24
15. Setting the projection method	25
16. Adjusting the lens	26
17. Installing the input module	27
18. Connecting and adjusting the input module signal.....	29
19. Connecting the input module signal source	30
20. Selecting the input signal / Selecting the system format.....	39
21. Selecting the signal of ET-MD95VM2(sold separately).....	40
22. Registering input signal data	41
23. Using the RGB REALITY mode	43
24. Adjusting the picture automatically	44
25. Adjusting the picture manually.....	45
26. Adjusting the blanking	48
27. Adjusting the clamp position / Picture mute function	49
28. Adjusting the keystone(trapezoidal distortion).....	50
29. Adjusting the picture to the desired setting	51
30. Power up function.....	58
31. Displaying a test pattern	59
32. Displaying the projector settings	60
33. Setting and specifying ID numbers.....	61
34. Using the RS-232C connectors.....	63
35. Replacing the lamp unit	66
36. Before asking for service	67
37. Specifications.....	68
38. Sold separately (Optional accessories).....	70
39. Dimensions.....	71
40. NOTES IMPORTANTES CONCERNANT LA SÉCURITÉ	72
41. Précautions concernant la sécurité.....	73
42. Précautions à suivre lors de la manipulation.....	75
43. Remplacement du module-lampe.....	77

Product Outline

This is a high-luminance DLP™ based projector which is powered by a single-phase, 3-wire type 200 V – 240 V power supply. It utilizes three RGB DMD™ chips and a high-output xenon lamp. By fitting a projection lens and input module (sold separately) in accordance with the setting-up location and the type of input signal, it can project images onto screens from 100 inches (2.5 m) to 600 inches (15 m) in size.

It can be used to project RGB signals with dot clock frequencies ranging from 20 MHz to 162 MHz and color difference input signals such as high-definition TV signals. In addition, an input module (sold separately) can be used to allow the projector to receive signals via a TMDS (Transition Minimized Differential Signalling)-type digital interface, and also NTSC, NTSC4.43, PAL, SECAM, PAL-M, PAL60, PAL-N video signals, Y/C signals and serial digital (SDI) signals. Besides this, the projector is equipped with an RS-232C connector so that it can be controlled by means of a personal computer or signal selector.

Other functions available include selection of the projection method (ceiling/floor/rear), an ID number assignment function which is useful for controlling multiple projectors simultaneously, keystone(trapezoidal distortion)correction and a lens focus/position adjustment (optical axis shift) function. All settings and adjustments during the setting-up process can be carried out easily by using on-screen menus.

The adoption of an ANC (Active Noise Control) circuit reduces noise interference.

In addition, a self-diagnosis display function is also provided. This function generates and displays a two-digit error code to notify you if a problem occurs with operation of the projector.

DMD™ chip's aspect ratio is 4:3 on the PT-D9500U, and 5:4 on the PT-D9600U.

Features

High-output light source which gives clear and sharp reproduction to all parts of the image

The adoption of a 1 600 W xenon lamp allows the projector to project a sharp, clear picture is projected uniformly over a large screen area.

High-density, high-quality computer images can also be projected

The projector utilizes a DLP™ (Digital Light Processing) system which incorporates an 0.9-inch(for the PT-D9500U)/1.1-inch (for the PT-D9600U) DMD™ (Digital Micromirror Device) having a display resolution of 1 024 x 768 dots(for the PT-D9500U)/1 280 x 1 024 dots(for the PT-D9600U) that produces a three-layer image from R, G and B layers.

This system produces images with high resolution and color reproduction which is faithful to the source. Because it can handle dot clock frequencies ranging from 20 MHz to 162 MHz, computer images with signal resolutions of up to 1 600 x 1 200 dots can also be input. However, if the display resolution is greater than 1024 x 768 dots(for the PT-D9500U)/1 280 x 1 024 dots (for the PT-D9600U), A-PIC (Advanced Panasonic Intelligent Compression) automatically converts the image to a resolution of 1024 x 768 dots(for the PT-D9500U)/1 280 x 1 024 dots(for the PT-D9600U)without causing any lines or characters to disappear, and without causing any flickering.

※DMD™ is an optical switch, a new device having a high utilization-factor of light and a high reaction rate, incorporating approximately from 780 000 to 1 310 000 micromirrors which rotate according to a digital signal in the solid-state memories.

A new processing circuit for moving images provides excellent moving image quality

The adoption of a new type of processing circuit exclusively for moving images converts the signals to images which are comfortable to view with no flickering or loss of quality from the image source.

Features

Projects a wide range of image sizes from 100 inches (2.5 m) to 600 inches (15 m)

By attaching different projection lenses (sold separately) that match the requirements of the setting-up location, images of any size between 100 inches (2.5 m) and 600 inches (15 m) (with an aspect ratio of 4:3 (PT-D9500U/ 5:4 (PT-D9600U)) can be projected, depending on the projection distance. When using the fixed focus lens, the available picture size is 100 to 500 inches diagonal for the PT-D9500U, and 100 to 200 inches diagonal for the PT-D9600U.

The flexibility in installation format (ceiling/floor/rear), keystone compensation, and optical axis shifting capability combine to allow for installation in limited spaces.

A variety of different input sources can be used

Standard applicable formats include analog RGB signals and color difference signals such as high-definition TV signals. In addition, an input module (sold separately) can be used to allow the projector to project signals from various sources, such as digital signals from personal computers (TMDS), NTSC, PAL, SECAM, NTSC4.43, PAL-M, PAL60, PAL-N video signals, Y/C signals and serial digital (SDI) signals.

Adoption of a noise suppressing circuit

This circuit detects noise from sources such as the cooling fan, and controls a noise control speaker in real time to reduce the noise level to 1/5 compared to our conventional models.

Other useful functions also included

In addition to an on-screen setting display function, the projector is also provided with a built-in memory which can store up to 64 signal sources plus several test patterns for checking adjustment levels. In addition, a self-diagnosis display function is also provided. This function generates and displays a two-digit error code to notify you if a problem occurs with operation of the projector.

Projection lenses which are sold separately are required for the operation of this projector. Please select the lenses which are best suited to the setting-up location for the projector.





Trademark Acknowledgements

- Digital Light Processing, DLP, and Digital Micromirror Device, DMD are registered trademarks of the Texas Instruments.
 - VGA and XGA are trademarks of International Business Machines Corporation.
 - S-VGA is a registered trademark of the Video Electronics Standards Association.
- All other trademarks are the property of the various trademark owners.

IMPORTANT SAFETY NOTICE

WARNING: To prevent damage which may result in fire or shock hazard, do not expose this appliance to rain or moisture.

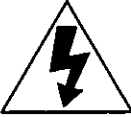
Power Supply: This DLP™ based Projector is designed to operate on 200 V – 240 V, 50 Hz / 60 Hz AC only.

  	 <p>The lightning flash with arrowhead symbol, within an equilateral triangle, is intended to alert the user to the presence of uninsulated “dangerous voltage” within the product’s enclosure that may be of sufficient magnitude to constitute a risk of electric shock to persons.</p>
<p>AVIS: RISQUE DE CHOC ÉLECTRIQUE. NE PAS OUVRIR</p>	 <p>The exclamation point within an equilateral triangle is intended to alert the user to the presence of important operating and maintenance (servicing) instructions in the literature accompanying the product.</p>

CAUTION: This equipment is equipped with a three-pin grounding-type power plug. Do not remove the grounding pin on the power plug. This plug will only fit a grounding-type power outlet. This is a safety feature. If you are unable to insert the plug into the outlet, contact an electrician. Do not defeat the purpose of the grounding plug.

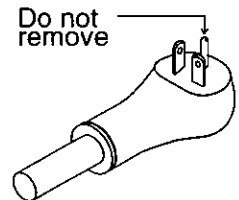

WARNING: This equipment has been tested and found to comply with the limits for a Class A digital device, pursuant to Part 15 of the FCC Rules. These limits are designed to provide reasonable protection against harmful interference when the equipment is operated in a commercial environment. This equipment generates, uses, and can radiate radio frequency energy and, if not installed and used in accordance with the instruction manual, may cause harmful interference to radio communications. Operation of this equipment in a residential area is likely to cause harmful interference in which case the user will be required to correct the interference at his own expense.

CAUTION: Any unauthorized changes or modifications to this equipment would void the users authority to operate.

Precautions with regard to safety

Read these operating instructions thoroughly and check all necessary safety precautions when setting up the projector in order to avoid accidents.

WARNING

Setting-up

Installation should only be carried out by a qualified technician.

- In order to maintain full safety and precision during installation, such work should only be carried out by a qualified technician.

At least three people are needed to set up the projector.

- This projector is manufactured with high precision and is very heavy. If only one person attempts to install or move the projector by himself, the projector may be damaged or injury may result. Always make sure that at least three people are available to transport and install the projector.

Check the strength of the installation location.

- This projector weighs 96 kg(211.2 lb). When coupled with the ceiling mount bracket (sold separately), the total weight becomes 135 kg(297 lb). If the installation location is not strong enough to bear the weight, carry out any reinforcement measures that may be necessary to ensure that the installation location will be free of any problems regarding strength and safety.

Avoid installing the projector in any of the following places:

- Places which are subject to vibration or shocks Vibration and shocks may cause malfunctions or accidents.
- Next to sprinklers or sensors Heat produced by the projector may cause sensors to operate incorrectly or sprinkler systems to be activated, which could cause problems.
- Near high-voltage power lines or motors Such power sources may cause interference.
- Places with adverse ambient conditions Avoid places which are extremely dusty, where oil fumes or vapor are present, and where the ambient temperature is outside the range of 0 °C – 40 °C(32 °F – 104 °F) or the ambient humidity is outside the range of 10 % – 80 %. If the projector is installed in such places, operating problems, fire or electric shocks may result.

Do not connect any power supply to the projector other than one with power supply voltage indicated (single-phase, 3-wire, 200 V–240 VAC)

- If the wrong power supply is connected, the projector may malfunction, and fire or electric shocks may result.

A special ceiling mount bracket (sold separately) is required for ceiling installation.

- If suspending the projector from a ceiling, you must purchase and use the special ceiling mount bracket (ET-PKD95).

Use commercially-available screens.

- Select a screen which matches the projection method to be used and the place of use.

Keep external light away from the screen.

- Do not allow light from any sources other than the projector fall on the screen. If the screen is illuminated by such external light, the projected image will lose its high contrast and will not be so easy to see.

Allow enough space around the projector for maintenance to be carried out.

- Leave at least 80 cm / 2.6 feet of free space on all sides of the projector to allow enough room for adjustments and maintenance to be carried out.

Always connect to a secure earth.

- Connect an earth wire to the earthing screw marked with \perp next to the MAIN POWER switch. Then connect this earth wire to a secure earthing terminal somewhere inside the room.
If the projector is used without the earth wire connected, electric shocks may result.

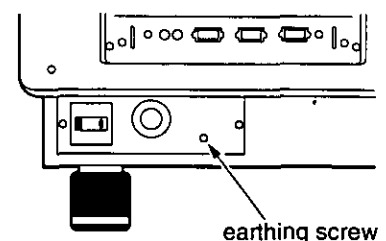

When using the projector

Do not look into the lens while the projector is being used.

- Strong light is emitted from the projector's lens. If you look directly into this light, it can hurt and damage your eyes.

Do not place the projector on top of surfaces which are sloped or unstable.

- The projector may fall down or tip over.

Do not place any objects on top of the projector.

- If water spills onto the projector or foreign objects get inside it, a short-circuit may occur which could result in fire or electric shocks. If any foreign objects get inside the projector, please consult an Authorized Service Center.

Do not stick any foreign objects into the projector.

- Do not insert any metal objects or flammable objects into the ventilation holes or drop them onto the projector, as doing so can cause fire or electric shocks to occur.

Do not cover the air outlet.

- Doing so may cause the projector to overheat, which can cause fire or damage to the projector.

Do not remove the cover or modify it in any way.

- High voltages which can cause severe electric shocks are present inside the projector. For any inspection, adjustment and repair work, please contact an Authorized Service Center.

Do not spill water on the projector.

- This can cause fire or electric shocks to occur.

Securely insert the power cord plug as far as it will go.

- If the plug is not fully inserted, heat may be generated which could cause fire. If the plug is damaged or the wall socket plate is loose, they should not be used.

Do not handle the power cord plug with wet hands.

- Doing so may cause electric shocks to occur.

Do not do anything that might damage the power cable.

- Do not damage the cable, make any modifications to it, place heavy objects on top of it, heat it, place it near any hot objects, twist it, bend it excessively or pull it. To do so may cause fires and electric shocks to occur. If the power cable becomes damaged, have it repaired at an Authorized Service Center.

Clean the power cable regularly to prevent it from becoming covered in dust.

- If dust builds up on the power cord plug, the resultant humidity can damage the insulation, which could result in fire. Pull the power cord out from the wall outlet and wipe it with a dry cloth.
- If not using the projector for an extended period of time, pull the power cord plug out from the wall outlet.

If a problem occurs during use

If a problem occurs (such as no picture), or if smoke or an abnormal odor starts to come out from the projector, immediately pull the power cord plug out from the wall outlet.

- If you continue to use the projector in this condition, fire or electric shocks could result. After checking that the smoke has stopped coming out, contact an Authorized Service Center so that the necessary repairs can be made. Repairing the projector yourself is extremely dangerous, and it should never be done.

If water or foreign objects get inside the projector, if the projector dropped, or if the cabinet becomes damaged, disconnect the power cord plug immediately.

- A short circuit may occur, which could cause fire. Contact an Authorized Service Center for any repairs that need to be made.

Caution!

- Do not reach for the openings beside the optical lens, during horizontal or vertical movements of the lens there is a injury hazard.

Precautions on handling

CAUTION

Setting-up

The following points should always be observed when setting up this projector.

A dedicated power supply must be used.

- Ask the place of purchase to carry out any electrical work which may be required to provide a 14 A, 200 V - 240 V AC (single phase) power supply for the projector alone to use.

Avoid setting up in places which are subject to vibration or shocks.

- If the projector is set up in a location with strong vibration, such as near a motor, or if it is installed inside a vehicle or on board a ship, the projector may be subjected to vibration or shocks which can damage the internal parts and cause malfunctions or accidents. Accordingly, set up the projector in a place which is free from such vibrations and shocks.

Do not place the projector near high-voltage power lines or motors.

- If the projector is set up near high-voltage power lines or motors, it may be subjected to electrical interference.

The projection distance will vary depending on the projection lens (sold separately) which is used.

- Select a projection lens which is suitable for the amount of space available at the setting-up location.

If installing the projector to the ceiling, be sure to have a qualified technician carry out the work.

- If suspending the projector from the ceiling, you will need to obtain the ceiling mount bracket which is sold separately. Also be sure to have the work performed by a qualified technician.

Do not move the projector after it has been installed and adjusted.

- After installation and adjustment of the projector have been completed, do not change the distance from the projector to the screen, and do not move the position of the projector, otherwise the colors may become unbalanced and readjustment may be necessary. Be particularly careful of this when the projector is installed using the floor method.

Allow enough space around the projector for maintenance to be carried out.

- Leave at least 80 cm(2.6 feet) of free space on all sides of the projector to allow enough room for adjustments and maintenance to be carried out.

Notes on use

In order to get the best picture quality

- If outside light or light from indoor lamps is shining onto the screen, the images projected will not have good contrast. Draw curtains or blinds over any windows, turn off any fluorescent lights near the screen and cover any highly-reflective floor and wall surfaces with carpet or wallpaper to prevent reflection.

Do not touch the surface of the projection lens with your bare hands.

- Do not touch your hands against the surface of the lens. If the surface of the lens becomes dirty from fingerprints or anything else, this will be magnified and projected onto the screen.

About the screen

- If the screen you are using is dirty, damaged or discolored, attractive projections cannot be obtained. Do not apply any volatile substances to the screen, and do not let it become dirty or damaged.

Cleaning and maintenance

Always disconnect the power plug from the power source as a safety precaution before carrying out cleaning and maintenance.

Wipe the cabinet with a soft, dry cloth.

- If the cabinet is particularly dirty, soak the cloth in water with a small amount of neutral detergent in it, squeeze the cloth very well, and then wipe the cabinet. After cleaning, wipe the cabinet dry with a dry cloth. If using a chemically-treated cloth, read the instructions supplied with the cloth before use.

Do not wipe the lenses with a cloth that is dusty or which produces lint.

- If any dust or lint gets onto the lenses, such dust or lint will be magnified and projected onto the screen. Use the blower end of a vacuum cleaner to clean any dust and lint from the lens surfaces, or use a clean, soft cloth to wipe off any dust or lint.

When wiping the surface of the lens, be sure to wipe in a single direction. If you move the cloth over the lens surface in different directions, it may cause any dirt to be rubbed into the surface of the lens instead of being cleaned away.

Name and function of each part

〈Projector〉

POWER button

This button is used to turn the projector power supply on and off.
 •This button is enabled while the MAIN POWER switch is ON.

SYSTEM SELECTOR button

This button is used to select RGB, RGB REALITY, or YPbPr (YCbCr) signal or switch between video and digital-serial signal formats.

Arrow buttons

These buttons are used to select and adjust items in the on-screen menus.

LENS button

This button is used to select the mode for adjusting the lens.

PIC-MUTE button

This button is used to temporarily halt the projection of a picture.

RGB/Component signal input terminals

These terminals are used to input analog RGB signals and component signals.

MAIN POWER switch

This switch turns the main power supply to the projector on and off.

REMOTE IN 2 input/output connector

This connector is used to connect a wired remote control unit to control the projector when using it in a multi-screen projection system.

RS-232C OUT connector

When using a personal computer to control a multi-screen projection system, this connector is used to connect this projector to the RS-232C IN connector of the next projector.

RS-232C IN connector

If you would like to use a personal computer to control the projector operation, connect the RS-232C output connector of the computer to this terminal.

REMOTE IN 1 connector

This connector is used to connect an external control circuit in order to turn the projector power on and off and to change the input source externally.

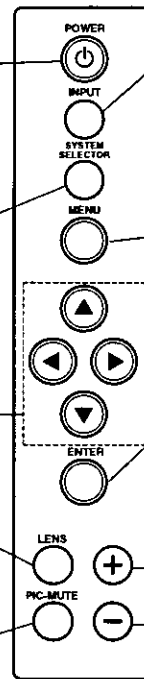

INPUT button

This button is used to change the input between RGB / INPUT 1 / INPUT 2 / INPUT 3. If there are several input terminals in a single input slot, the selection will change in order between all input terminals available for that slot.

MENU button

This button is used to make the MENU screen and the respective adjustment screens appear on the projection screen, and to return to a previously-displayed screen.

ENTER button

This button is used to accept and activate items selected in the on-screen menus.

Control level buttons

These buttons are used to adjust the BRIGHT, CONTRAST, COLOR and TINT and to adjust the lens.

Power indicator

When the MAIN POWER switch is pressed, this indicator becomes red and the projector switches to standby mode. When the POWER button on the remote control unit or the projector operating panel is pressed, the indicator changes to green, and after a brief period, a picture is then projected.

Self-diagnosis display

If a problem with the operation of the projector is detected, a two-digit code appears in this display. If a code appears, stop using the projector and ask the place of purchase to check the projector. (The code "FC" under the operation of the cooling fan is not an error code, refer to Note on page 15.)

Remote control signal receptor

This receives the signals which are sent from the remote control unit.

Projection lens (sold separately)

This lens enlarges the image and projects it onto the screen.

Installation bays for input modules (sold separately)

(These are designated as slot 1, slot 2 and slot 3 in order from the top.)

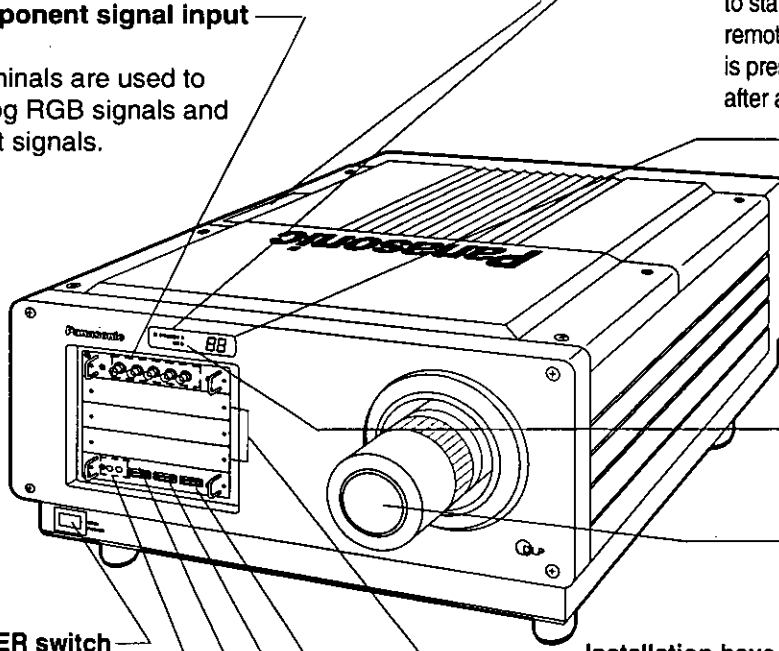

Name and function of each remote control part

〈Remote control unit〉

STD (standard) button

This button is used to reset all of the projector adjustment values (BRIGHT, CONTRAST, COLOR, TINT and SHARPNESS) to the default levels which were set at the time of shipment from the factory. It is pressed after the respective adjustment mode screen has been displayed.

SYSTEM SELECTOR button

This button is used to select RGB, RGB REALITY, or YPBPR (YCbCr) signal or switch between video and digital-serial signal formats.

POWER button

This button is used to turn the projector power supply on and off.
•This button is enabled while the MAIN POWER switch is ON.

Input select buttons

These buttons are used to change the input between RGB/INPUT 1 (slot 1)/INPUT 2 (slot 2)/INPUT 3 (slot 3). If there are several input terminals in a single input slot, the selection will change in order between all input terminals available for that slot.

CONTRAST button

This button is used to select the mode for adjusting the picture contrast.

BRIGHT buttons

This button is used to select the mode for adjusting the picture brightness.

Numeric buttons

These buttons are used to specify this projector when it is being used in a multi-screen projection system. In addition, they are used to enter ID numbers when selecting IDs, and to enter passwords.

PIC-MUTE button

This button is used to temporarily halt the projection of a picture.

ON SCREEN button

This button is used to turn the on-screen display function on and off.

NEXT button

If the ID SELECT button is being pressed and held, the tens digit of the ID number then changes each time the NEXT button is pressed.

ID SELECT button

When the projector is being used in a multi-screen projection system, this button is used to select the mode for specifying which projector is to be operated.

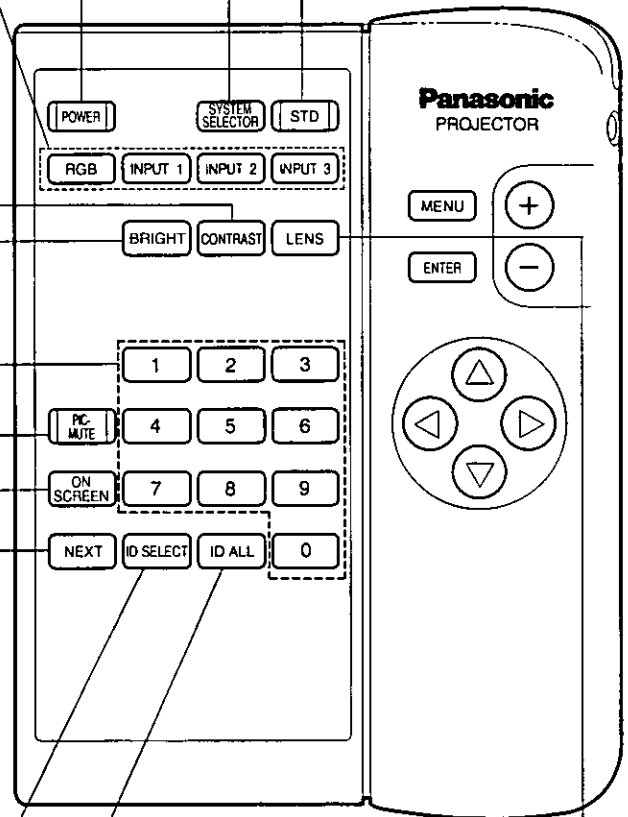

LENS button

This button is used to select the mode for adjusting the lens.

ID ALL button

When the projector is being used in a multi-screen projection system, this button is used to select the mode for controlling all projectors using a single remote control unit.

NOTE When the projector is being used in a multi-screen projection system, to use the remote control unit, set the ID number of the projector. Refer to page 61 for details.

Name and function of each remote control part (continued)

〈Remote control unit〉

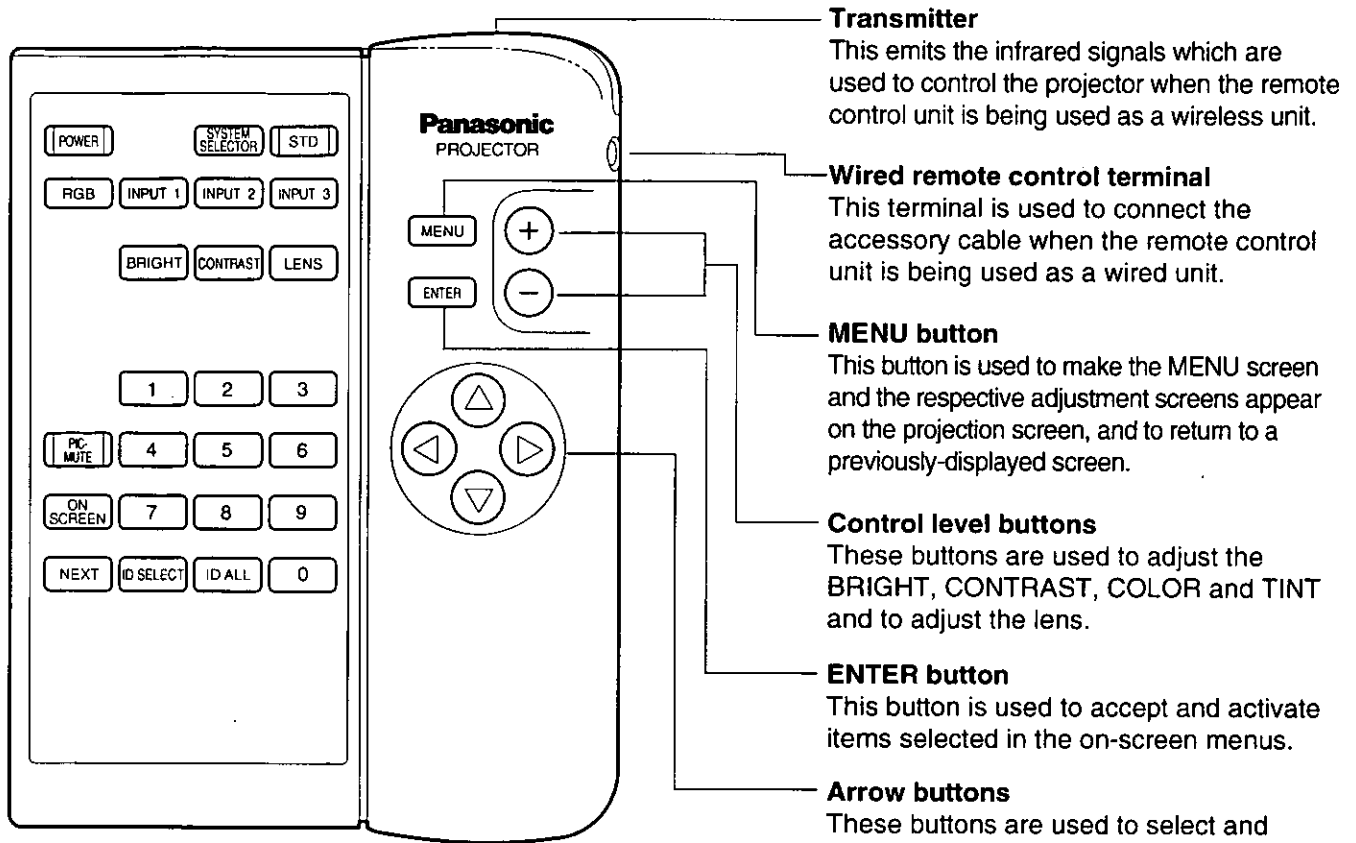

Rear of remote control unit

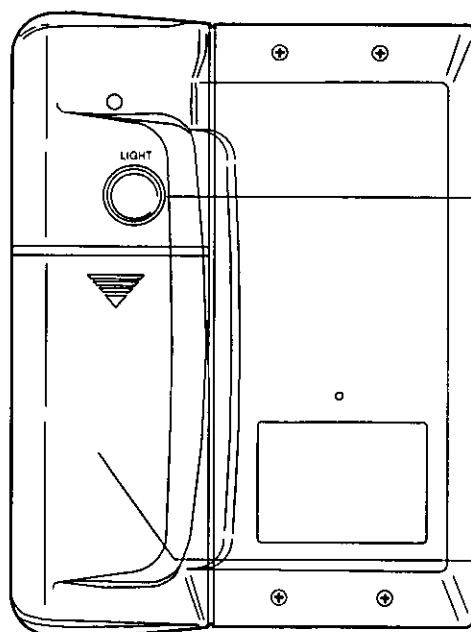

If the button illumination is flashing

This indicates that the remote control unit batteries are nearly flat. Replace them with new batteries.

Before using the remote control unit

Inserting the batteries

- Insert the AA batteries supplied with the remote control unit, making sure that the polarities are correct.
- The batteries also need to be inserted when the remote control unit is connected to the projector using the remote control cable.

1 Open the battery compartment cover.

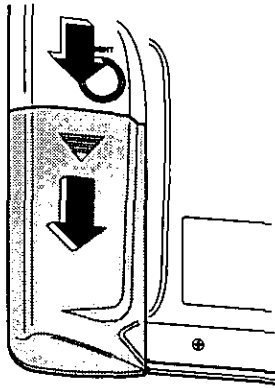

Push the ▼ mark firmly in the direction of the arrow to slide the cover, and then pull it toward you to remove it.

2 Insert the batteries.

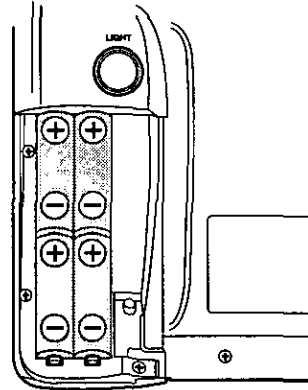

Insert the batteries so that their direction matches the polarity markings inside the compartment.

3 Close the battery compartment cover.

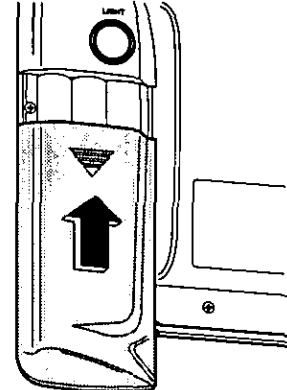

Return the battery compartment cover to its original position.

Note on using the batteries

The following should be observed in order to prevent damage to or leaking of the batteries.

- Do not mix old and new batteries of different types.
- Do not burn spent batteries or put them in with combustible garbage.

- Do not use rechargeable (Ni-Cd) batteries.
- Do not recharge the batteries.
- Do not short the (+) and (-) terminals.
- Do not disassemble the batteries.

Notes when using the remote control unit

- Do not spill any liquids onto the remote control unit.
- Do not drop the remote control unit.

Because the memory in the remote control unit is reset when the batteries are replaced after the projector has been set up, you will need to reset the ID numbers.

Attaching the strap

A strap is provided with the remote control unit. You can use this strap to hang the remote control unit around your neck for easy carrying. Attach the strap as shown in the illustrations below.

- Open the battery compartment cover. Attach the supplied strap as shown in this illustration and close battery compartment cover.

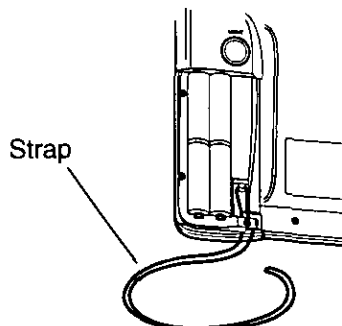

Operating range of remote control unit

- When using remote control unit without the cable, refer to the illustration below for operating range.

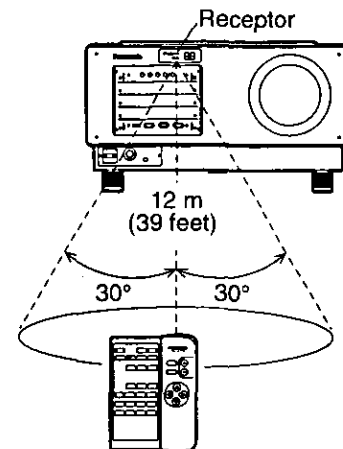

NOTE

If facing the remote control unit towards the screen to operate the projector, the operating range of remote control unit will be limited by the amount of light reflection loss caused by the characteristics of the screen used.

Using the remote control unit with the cable

The remote control unit can be connected to the projector using the accessory remote control cable.

This cable should be connected to the REMOTE IN2 IN terminal at the front of the projector and to the remote control cable terminal.

Note:

- The maximum length for the cable used to connected the remote control unit is 15 m (49 feet).

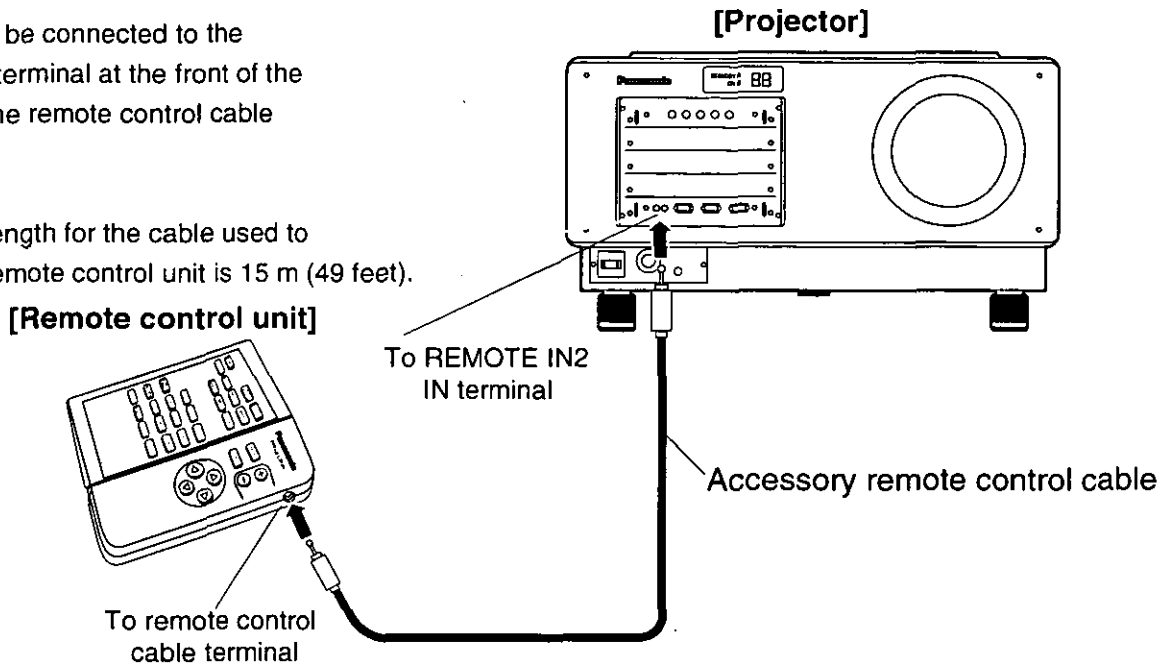

● Using REMOTE IN 1 Terminal

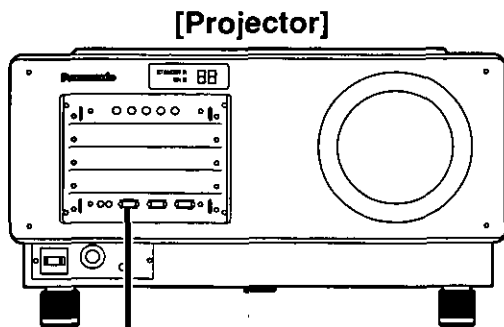

Because each pin of the REMOTE IN 1 terminal is controlled by its open (H) or short (L) as shown in the table below, the addition of an external control circuit allows the external control for the projector power supply on and off, the change of the input terminal, and the switching of the input signal system.

- NOTE**
- To perform external contact control of the projector, turn off the MAIN POWER switch of the projector, then set pin 9 of the REMOTE IN 1 terminal to the external contact control mode (short) using the external control circuit, and then turn on the MAIN POWER switch of the projector.
 - When controlling the projector using the external control circuit, the external contact control mode (short) at pin 9 disables the buttons on the projector operating panel and the remote control unit for the projector power supply on and off and the change of the input terminal functions.

	Terminals	Open(H)	Short(L)
1	GND	—	GND
2	POWER	OFF	ON
3	RGB	Other	RGB
4	INPUT 1	Other	INPUT 1
5	INPUT 2	Other	INPUT 2
6	INPUT 3	Other	INPUT 3
7	LINE / Y / C	LINE	Y / C
8	SYSTEM SELECTOR	480i, 1080i	576i, 720P
9	RST / SET	Remote control	External contact control

Turning the power ON and OFF

Always be sure to follow the procedure given below to turn the projector power on and off.

<Turning the power on >

<Turning the power off >

1	Main power ON (The power indicator will become red)
Press the [I] side of the MAIN POWER switch at the front of the projector. (The projector will change to standby mode.)	

Wait about 3 seconds

2	Standby ON (The power indicator will become green)
Press the POWER button on the remote control unit or on the projector operating panel.	

After about 20 seconds

3	Picture projected
A picture will then be projected.	

While projecting a picture (The power indicator is green)

1	Standby OFF (The power indicator will become red from green after the cooling fan has stopped)
Press the POWER button on the remote control unit or on the projector operating panel.	

Wait about 5 minutes

2	Main power OFF
Press the [O] side of the MAIN POWER switch at the front of the projector. (The power will then turn off.)	

NOTE

- The projector will continue to draw approximately 2.8 W of power when it is in standby mode, even after the cooling fan has stopped.
- The lamp cooling fan will continue to operate for approximately five minutes after the power is turned off. At the same time, the self-diagnosis display "FC" will blink.
Do not disconnect the power cord from the power outlet or do not open any circuit breakers while the cooling fan is still operating.
- When projecting a picture for the first time after setting up the projector, first press the LENS button on the remote control unit or the projector operating panel, and then use the control level buttons (+ and -) to adjust the basic focus.
- Turning on the power at an ambient temperature of about 0 °C may require a warm-up time of approximately two minutes to start projecting a picture. Codes such as "C1", "C2", and "C3" will appear in the self-diagnosis display during the warm-up. After the warm-up, the self-diagnosis display will turn off and the projector will project a picture.
- If the ambient temperature is too low and the warm-up time exceeds three minutes, the power will automatically be turned off as an abnormal condition. In this case, increase the ambient temperature to 0 °C or higher and then perform the operations "Main power ON → Standby ON" again.

On-screen menu operation guide

The figure below shows on-screen displays for any desired setting, starting with the MAIN MENU, and ending with its sub-menu.

Normal screen

•[On-screen displays such as the input signal type will appear when the input signal is changed. (The display will disappear automatically.)]

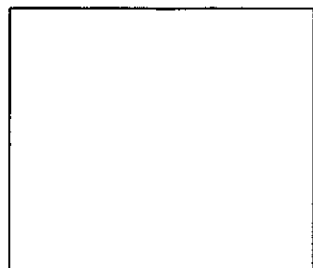

```

RGB
INPUT : n
ID : nnn
S. S. : No : nn - nn
    
```

MENU screen

```

MENU
AUTO SETUP
LENS
PICTURE
POSITION
OPTION
SIGNAL LIST
TEST PATTERN

MENU : ▲▼
START : ENTER
EXIT : MENU
    
```

LENS (Lens adjustment mode)

```

LENS

LENS FOCUS : + -
LENS SHIFT : ▲▼◀▶
EXIT : MENU
    
```

PICTURE (Picture adjustment mode)

```

PICTURE
COLOR TEMP : ****
BRIGHT : nnn
CONTRAST : nnn
COLOR : nnn
TINT : nnn
SHARPNESS H : nnn
SHARPNESS V : nnn
NR
▼
MENU : ▲▼
SELECT : ◀▶
EXIT : MENU
    
```

POSITION (Screen position adjustment mode)

```

POSITION

SHIFT
SIZE
BLK
CLOCK PHASE
INPUT RESOLUTION
CLAMP POSITION
KEystone

MENU : ▲▼
SUB MENU : ENTER
EXIT : MENU
    
```

OPTION (Miscellaneous setting mode)

```

OPTION

ID : nn
SETTING RUNTIME : *****
LAMP NORMAL : nnnnnh
HIGH : nnnnnh
REMAIN : nnnnnh
SET RUNTIME : nnnnnh
LAMP POWER : *****
RS-232C SETTING
SYSTEM INFORMATION
VIDEO MODULE SETTING
PASSWORD

MENU : ▲▼
SELECT : ◀▶
EXIT : MENU
    
```

SIGNAL LIST (Registered signal list)

```

SIGNAL LIST

NAME INPUT SS
nn : ***** 1 n - n
nn : ***** 2 n - n
nn : ***** 3 n - n
nn : ***** RGB n - n
nn : ***** 2 n - n
nn : <NO ENTRY> - -
nn : <NO ENTRY> - -

NEXT PAGE

DELETE : STD
SELECT : ▲▼
STATUS : ENTER
EXIT : MENU
    
```

Contents of menu screen

Screen name

Selection items

●The color of a selected item changes

Operation guide

●Displayed contents depends on a selected item

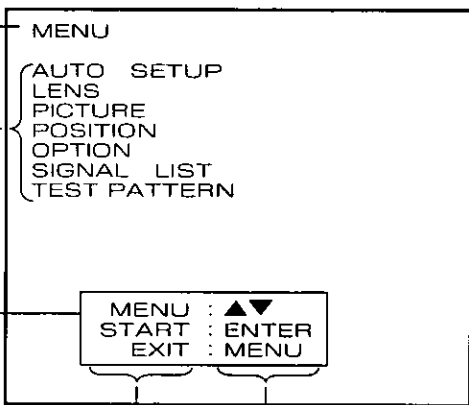

Display of operation buttons
●Displayed buttons depends on a selected item

Display of operation contents

MENU	Selects from the items on screen
START	Starts the automatic adjustment
SUB MENU	Advances to the next screen
SELECT	Selects setting values and others
CHANGE	Changes
EXIT	Return to the previous screen

Before using the projector

The projection lenses and input modules which are available for use with this projector need to be purchased separately (only the analog RGB input module is provided as standard equipment), and must be installed to the projector before the projector can be used.

- NOTE**
- Obtain the required projection lenses and input modules beforehand in accordance with the projection distance and the system used.
 - When installing an optional input module, refer to page 27 for details.

Installing the projection lens

Install a projection lens (sold separately) which is appropriate for the projector setting-up conditions.

Setting procedure

- ① Remove the lens caps (one each at front and back) from the projection lens.
- ② Insert the projection lens into the lens holder and turn it clockwise until it is securely in place.

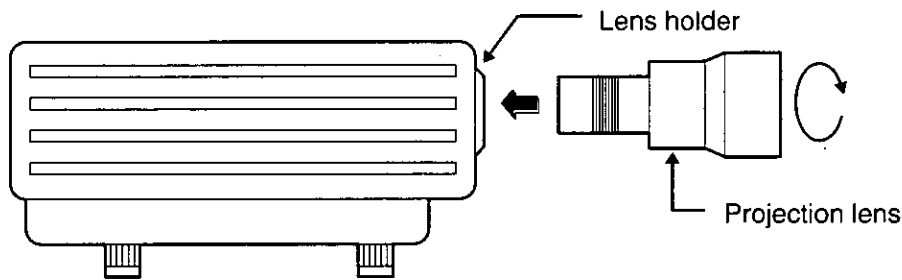

- NOTE**
- Lens focus adjustment should be carried out when the menu screen is first displayed, or when using the focus adjustment function.
 - Because a projection lens is considerably heavy, be careful not to drop it during installation.
 - If inserting the projection lens into the lens holder too strongly, the lens may jam into the holder. To prevent this problem, do this work carefully.

Setting up the projector

- After determining the installation position of the projector and screen in consideration of the audience positions, install them according to the chapter "Projection distance for each projection lens (sold separately)" on pages 20-24.

Installing to the floor (Including the direct rear-mounting)

1. Installing drawing of the screen and the projector (unit : mm / inches)

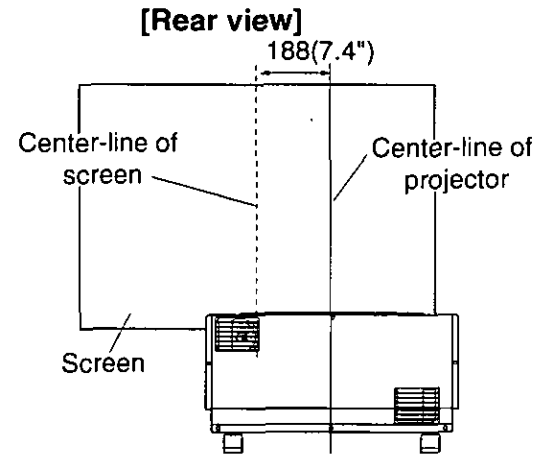
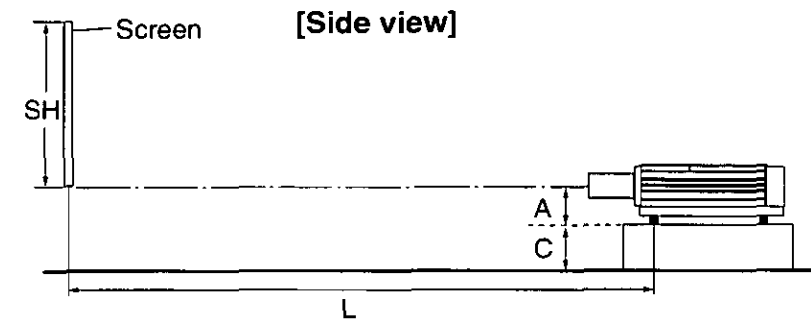

[Top view]

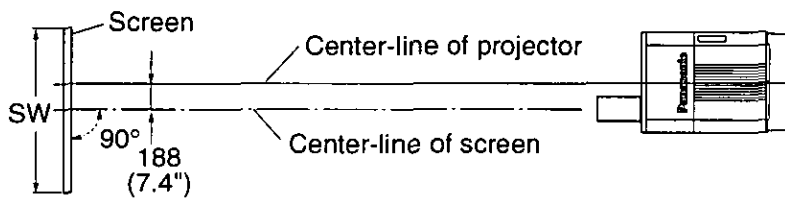

L : Projection distance between the screen and the center of the front foot of the projector.

A: Distance between the center of the lens and the top of the setting table (including the height of a foot of the projector), 250 mm – 275 mm (9.8"- 10.8") (The height of each foot is adjustable.)

C: Distance between the bottom of the foot and the floor (height of the setting table)
Set this distance so that the distance between the center of the lens and the floor can become equal to that between the lowest edge of the screen and the floor.

2. Installing the screen and the projector

Example of installation points

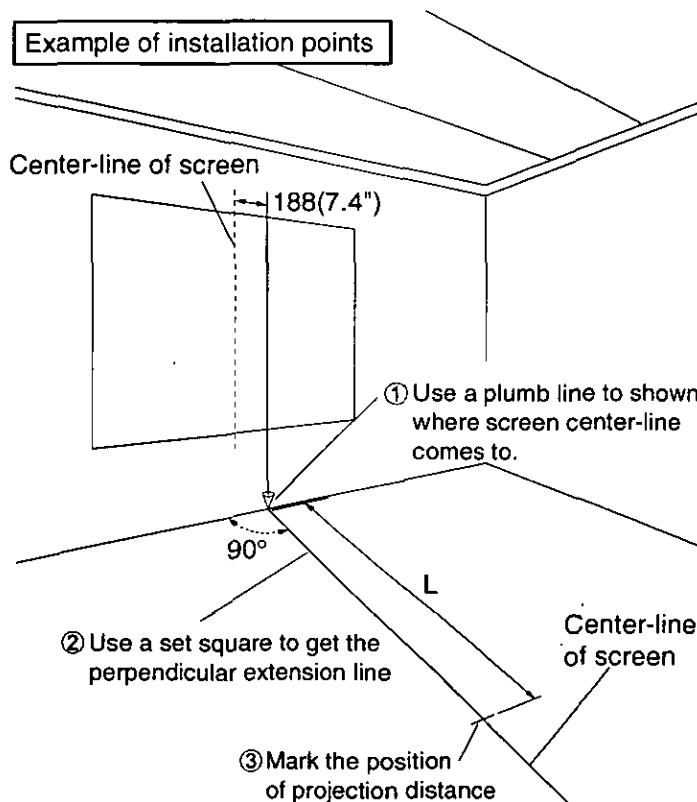

● Installing the screen

After determining the installation position of the screen in consideration of the screen characteristics and the audience positions, install it using the procedure specified by screen manufacture.

● Installing the projector

Install the projector by observing the items below and referring to the above "Installation drawing of the projector and screen" and the drawing at left.

- Set the lens center position of the projector to the same height as the lower edge of the effective height of the screen. (If the projector position is lower than the reference position, prepare a setting table that has a height of the above "C".)
- Set the center line of the projector to the position facing the vertical line 188 mm/7.4" away from the center line of the screen to the right.
- Set the center position of the front foot of the projector to the position of the projection distance (L) specified according to the projection lens and the target picture size.

Installing to the ceiling (Including direct rear-projection)

- Using the projector by installing to the ceiling requires an optional ceiling mount bracket (ET-PKD95). For the projection distance (L), refer to the chapter "Projection distance for each projection lens (sold separately)" on pages 20 - 24.
- For the procedures to install the ceiling mount bracket on the projector and mount the suspension bolts on the ceiling surface, refer to the installation instructions supplied with ET-PKD95.

1. Installing drawing of the screen and the projector (unit : mm / inches)

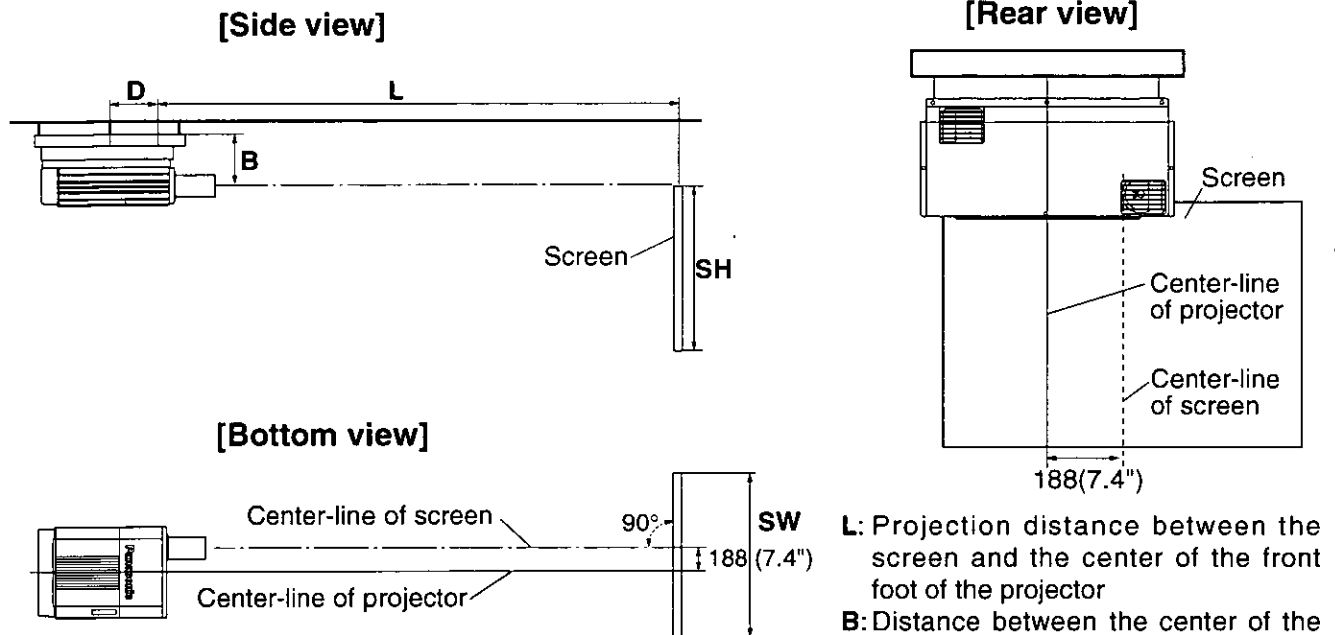

2. Position of the ceiling mount bracket on the ceiling

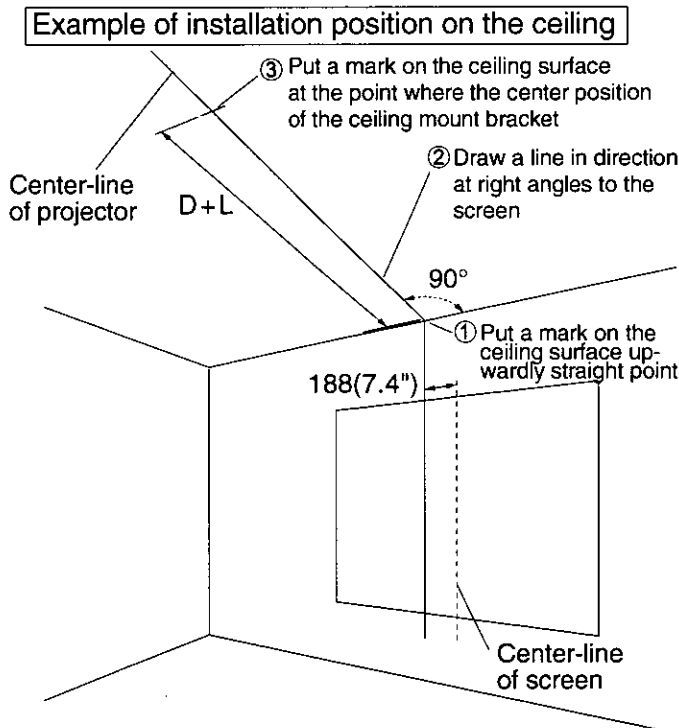

● Locating the positions to mount the suspension bolts on the ceiling surface

Locate the center-hole position of the ceiling side of the optional ceiling mount bracket (ET-PKD95) by the procedure below. For the procedure to install to the ceiling, refer to the installation instructions of the optional ceiling mount bracket (ET-PKD95).

- Put a mark on the ceiling surface at the upwardly straight point of a distance of 188 mm/7.4" from the screen center to the left.
- Draw a line in a direction at right angles to the screen from marked point.
- Put another mark on the ceiling surface at the point where the center position of the ceiling side of the ceiling mount bracket will be set. The point is at a distance of $D + L$ from the screen.

Projection distance for each projection lens

(sold separately)

The required projection distance depends on not only the target picture size but also the type of an optional projection lens. Obtain the appropriate projection lens for the installation space by referring to the projection distance for each projection lens shown in the table below and on the next page.

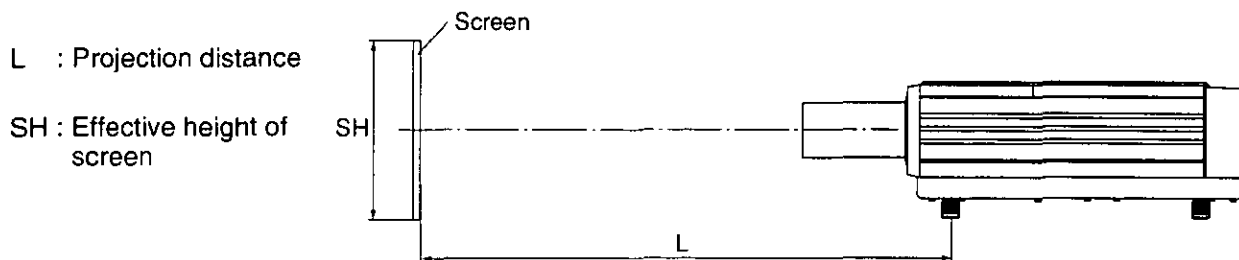

Projection distance measurements for PT-D9500U (screen aspect ratio: 4:3)

unit: mm (feet/inches)

Picture size	Screen size		Projection distance						
			Zoom lens						Fixed focal lens
	Effective height(SH)	Effective width(SW)	ET-D95LE1 (1.5-2.5 : 1)		ET-D95LE2 (2.5-4.0 : 1)		ET-D95LE3 (4.0-7.0 : 1)		ET-D95LE4 (1.05:1)
Min.			Max.	Min.	Max.	Min.	Max.		
2 540 (100")	1 524 (5'0")	2 032 (6'8")	3 261 (10'9")	5 197 (17'1")	5 270 (17'3")	8 221 (27'0")	8 196 (26'11")	14 142 (46'5")	2 244 (7'4")
3 048 (120")	1 829 (6'0")	2 438 (8'0")	3 870 (12'9")	6 203 (20'4")	6 279 (20'7")	9 833 (32'3")	9 820 (32'3")	16 976 (55'8")	2 657 (8'9")
3 810 (150")	2 286 (7'6")	3 048 (10'0")	4 784 (15'9")	7 713 (25'4")	7 792 (25'7")	12 251 (40'2")	12 257 (40'2")	21 227 (69'7")	3 276 (10'9")
4 572 (180")	2 743 (9'0")	3 658 (12'0")	5 698 (18'9")	9 223 (30'3")	9 305 (30'6")	14 669 (48'1")	14 693 (48'2")	25 478 (83'7")	3 896 (12'10")
5 080 (200")	3 048 (10'0")	4 064 (13'4")	6 307 (20'8")	10 229 (33'7")	10 314 (33'10")	16 281 (53'5")	16 318 (53'6")	28 312 (92'10")	4 309 (14'2")
6 350 (250")	3 810 (12'6")	5 080 (16'8")	7 830 (25'8")	12 745 (41'9")	12 835 (42'1")	20 310 (66'7")	20 379 (66'10")	35 397 (116'1")	5 341 (17'10")
7 620 (300")	4 572 (15'0")	6 096 (20'0")	9 353 (30'8")	15 261 (50'0")	15 357 (50'4")	24 340 (79'10")	24 440 (80'2")	42 482 (139'4")	6 373 (20'11")
8 890 (350")	5 334 (17'6")	7 112 (23'4")	10 876 (35'8")	17 777 (58'8")	17 879 (58'8")	28 369 (93'6")	28 501 (93'5")	49 567 (162'6")	7 405 (24'3")
10 160 (400")	6 096 (20'0")	8 128 (26'8")	12 399 (40'8")	20 293 (66'7")	20 401 (66'11")	32 399 (106'3")	32 562 (106'9")	56 651 (185'9")	8 437 (27'8")
11 430 (450")	6 858 (22'6")	9 144 (30'0")	13 922 (45'8")	22 809 (77'10")	22 923 (75'2")	36 429 (119'5")	36 623 (120'1")	63 736 (209'0")	9 469 (31'1")
12 700 (500")	7 620 (25'0")	10 160 (33'4")	15 445 (50'8")	25 325 (83'0")	25 445 (83'5")	40 458 (132'8")	40 684 (133'5")	70 821 (232'3")	10 502 (34'5")
13 970 (550")	8 382 (27'6")	11 176 (36'8")	16 968 (55'8")	27 841 (91'4")	27 966 (91'9")	44 488 (145'11")	44 745 (146'9")	77 906 (255'5")	—
15 240 (600")	9 144 (30'0")	12 192 (40'0")	18 491 (60'8")	30 357 (99'7")	30 488 (100'0")	48 517 (159'11")	48 806 (160'0")	84 991 (278'8")	—

Projection distance measurements for PT-D9500U (screen aspect ratio: 16:9)

unit: mm (feet/inches)

Picture size	Screen size		Projection distance						
			Zoom lens						Fixed focal lens
	Effective height(SH)	Effective width(SW)	ET-D95LE1 (1.5-2.5 : 1)		ET-D95LE2 (2.5-4.0 : 1)		ET-D95LE3 (4.0-7.0 : 1)		ET-D95LE4 (1.05:1)
Min.			Max.	Min.	Max.	Min.	Max.		
2 540 (100")	1 245 (4'1")	2 214 (7'3")	3 534 (11'7")	5 647 (18'6")	5 721 (18'9")	8 942 (29'4")	8 922 (29'3")	15 409 (50'6")	2 429 (8'0")
3 048 (120")	1 494 (4'11")	2 657 (8'9")	4 197 (13'9")	6 743 (22'1")	6 820 (22'5")	10 698 (35'1")	10 692 (35'1")	18 497 (60'8")	2 879 (9'5")
3 810 (150")	1 868 (6'2")	3 321 (10'11")	5 193 (17'3")	8 388 (27'6")	8 468 (27'10")	13 332 (43'9")	13 346 (43'9")	23 128 (75'10")	3 553 (11'8")
4 572 (180")	2 241 (7'4")	3 985 (13'1")	6 188 (20'4")	10 033 (32'11")	10 117 (33'2")	15 966 (52'4")	16 001 (52'6")	27 759 (91'0")	4 228 (13'11")
5 080 (200")	2 491 (8'2")	4 428 (14'6")	6 852 (22'6")	11 129 (36'6")	11 216 (36'10")	17 722 (58'1")	17 771 (58'3")	30 847 (101'2")	4 678 (15'4")
6 350 (250")	3 113 (10'3")	5 535 (18'2")	8 511 (27'11")	13 870 (45'6")	13 963 (45'10")	22 112 (72'7")	22 195 (72'10")	38 565 (126'6")	5 802 (19'0")
7 620 (300")	3 736 (12'3")	6 641 (21'10")	10 171 (33'4")	16 611 (54'6")	16 711 (54'10")	26 502 (86'11")	26 619 (87'3")	46 284 (151'9")	6 927 (22'9")
8 890 (350")	4 358 (14'4")	7 748 (25'5")	11 830 (38'10")	19 352 (63'6")	19 458 (63'10")	30 892 (101'4")	31 043 (101'10")	54 002 (177'1")	8 051 (26'5")
10 160 (400")	4 981 (16'4")	8 855 (29'0")	13 489 (44'3")	22 094 (72'5")	22 205 (72'10")	35 282 (115'8")	35 467 (116'4")	61 721 (202'5")	9 176 (30'1")
11 430 (450")	5 604 (18'5")	9 962 (32'8")	15 148 (49'8")	24 835 (81'5")	24 953 (81'10")	39 672 (130'1")	39 892 (130'10")	69 440 (227'8")	10 300 (33'10")
12 700 (500")	6 226 (20'5")	11 069 (36'4")	16 808 (55'11")	27 576 (90'5")	27 700 (90'10")	44 062 (144'6")	44 316 (145'4")	77 158 (253'7")	11 425 (37'6")
13 970 (550")	6 849 (22'6")	12 176 (40'0")	18 467 (60'7")	30 317 (99'5")	30 448 (99'10")	48 452 (158'11")	48 740 (159'10")	84 877 (278'4")	—

NOTE:

- The projection distance listed in the table may have a variation within ± 5 %.
- Keystone (trapezoidal distortion) is compensated to be smaller than the screen size.

Projection distance measurements for PT-D9600U (screen aspect ratio: 5:4)

unit: mm (feet/inches)

Picture size	Screen size		Projection distance								
			Zoom lens								Fixed focal lens
	Effective height(SH)	Effective width(SW)	ET-D95LE5 (1.5:20:1)		ET-D95LE6 (2.0:25:1)		ET-D95LE7 (2.5:40:1)		ET-D95LE8 (4.0:70:1)		
Min.			Max.	Min.	Max.	Min.	Max.	Min.	Max.		
2 540 (100")	1 586 (5'3")	1 983 (6'7")	3 203 (10'7")	4 194 (13'10")	4 266 (14'0")	5 172 (17'0")	5 033 (16'7")	7 927 (26'1")	8 066 (26'7")	13 905 (45'9")	1 926 (6'4")
3 048 (120")	1 904 (6'3")	2 380 (7'10")	3 814 (12'7")	5 007 (16'6")	5 079 (16'9")	6 165 (20'3")	6 025 (19'10")	9 315 (31'4")	9 654 (31'9")	16 686 (54'11")	2 261 (7'5")
3 810 (150")	2 380 (7'10")	2 975 (9'10")	4 732 (15'7")	6 226 (20'6")	6 299 (20'9")	7 655 (25'2")	7 512 (24'9")	11 891 (39'1")	12 035 (39'7")	20 858 (68'7")	2 763 (9'1")
4 572 (180")	2 856 (9'5")	3 570 (11'9")	5 650 (18'7")	7 444 (24'6")	7 519 (24'9")	9 146 (30'1")	8 999 (29'8")	14 270 (47'0")	14 416 (47'5")	25 029 (82'4")	3 265 (10'9")
5 080 (200")	3 174 (10'6")	3 967 (13'1")	6 261 (20'7")	8 257 (27'2")	8 332 (27'5")	10 139 (33'4")	9 991 (32'11")	15 855 (52'2")	16 004 (52'8")	27 810 (91'6")	3 600 (11'11")
6 350 (250")	3 967 (13'1")	4 959 (16'4")	7 791 (25'8")	10 289 (33'11")	10 365 (34'1")	12 623 (41'7")	12 470 (41'0")	19 820 (65'2")	19 973 (65'9")	34 763 (114'4")	—
7 620 (300")	4 760 (15'8")	5 950 (19'7")	9 320 (30'8")	12 320 (40'7")	12 398 (40'10")	15 107 (49'9")	14 948 (49'2")	23 784 (78'3")	23 941 (78'9")	41 715 (137'3")	—
8 890 (350")	5 554 (18'3")	6 942 (32'10")	10 849 (35'9")	14 352 (47'3")	14 431 (47'6")	17 591 (57'11")	17 427 (57'4")	27 748 (87'3")	27 910 (87'9")	48 668 (160'2")	—
10 160 (400")	6 347 (20'11")	7 934 (26'1")	12 379 (40'9")	16 383 (53'11")	16 464 (54'2")	20 074 (66'0")	19 906 (65'6")	31 712 (104'4")	31 879 (104'11")	55 620 (183'0")	—
11 430 (450")	7 140 (23'6")	8 925 (29'4")	13 908 (45'9")	18 415 (60'7")	18 497 (60'11")	22 558 (74'2")	22 384 (73'8")	35 676 (117'4")	35 847 (117'11")	62 573 (205'10")	—
12 700 (500")	7 438 (24'6")	9 917 (32'8")	15 438 (50'10")	20 446 (67'3")	20 530 (67'7")	25 042 (82'5")	24 863 (81'10")	39 640 (130'5")	39 816 (131'0")	69 525 (228'9")	—
13 970 (550")	7 934 (26'1")	10 909 (35'11")	16 967 (55'10")	22 478 (74'0")	22 562 (74'3")	27 526 (90'7")	27 342 (90'0")	43 604 (143'5")	43 785 (144'0")	76 478 (251'7")	—
15 240 (600")	9 520 (31'4")	11 900 (39'2")	18 496 (60'11")	24 509 (80'8")	24 595 (80'11")	30 010 (98'9")	29 820 (98'1")	47 568 (156'6")	47 753 (157'1")	83 430 (274'6")	—

Projection distance measurements for PT-D9600U(screen aspect ratio: 16:9)

unit: mm (feet/inches)

Picture size	Screen size		Projection distance								
			Zoom lens								Fixed focal lens
	Effective height(SH)	Effective width(SW)	ET-D95LE5 (1.5:20:1)		ET-D95LE6 (2.0:25:1)		ET-D95LE7 (2.5:40:1)		ET-D95LE8 (4.0:70:1)		
Min.			Max.	Min.	Max.	Min.	Max.	Min.	Max.		
2 540 (100")	1 245 (4'1")	2 214 (7'3")	3 558 (11'8")	4 666 (15'4")	4 738 (15'7")	5 748 (18'11")	5 609 (18'6")	8 848 (29'1")	8 987 (29'7")	15 519 (51'1")	2 120 (7'0")
3 048 (120")	1 494 (4'11")	2 657 (8'9")	4 241 (14'0")	5 572 (18'4")	5 645 (18'7")	6 857 (22'7")	6 715 (22'1")	10 617 (34'11")	10 759 (35'5")	18 623 (61'3")	2 494 (8'3")
3 810 (150")	1 868 (6'2")	3 321 (10'11")	5 265 (17'4")	6 933 (22'10")	6 933 (23'1")	8 520 (28'0")	8 375 (27'7")	13 272 (43'8")	13 417 (44'2")	23 279 (76'7")	3 055 (10'1")
4 572 (180")	2 241 (7'4")	3 985 (13'11")	6 289 (20'9")	8 293 (27'3")	8 368 (27'7")	10 184 (33'6")	10 035 (33'0")	15 926 (52'5")	16 074 (52'11")	27 935 (91'11")	3 615 (11'11")
5 080 (200")	2 491 (8'2")	4 428 (14'6")	6 971 (20'9")	9 200 (30'3")	9 276 (30'6")	11 292 (37'2")	11 142 (36'8")	17 696 (58'3")	17 846 (58'9")	31 038 (102'1")	—
6 350 (250")	3 113 (10'3")	5 535 (18'2")	8 678 (28'7")	11 468 (37'9")	11 545 (38'0")	14 065 (46'3")	13 908 (45'9")	22 120 (72'10")	22 276 (73'3")	38 798 (127'8")	—
7 620 (300")	3 736 (12'3")	6 641 (21'10")	10 385 (34'2")	13 735 (45'2")	13 814 (45'6")	16 837 (55'5")	16 674 (54'11")	26 554 (87'4")	26 705 (87'11")	46 557 (153'2")	—
8 890 (350")	4 358 (14'4")	7 748 (25'5")	12 092 (39'10")	16 002 (52'8")	16 082 (52'11")	19 609 (64'6")	19 441 (64'0")	30 968 (101'11")	31 134 (102'5")	54 317 (178'8")	—
10 160 (400")	4 981 (16'4")	8 855 (29'0")	13 799 (45'5")	18 351 (60'5")	18 351 (60'5")	22 381 (73'8")	22 207 (73'1")	35 393 (116'5")	35 564 (117'0")	62 076 (204'2")	—
11 430 (450")	5 604 (18'5")	9 962 (32'8")	15 506 (51'0")	20 537 (67'10")	20 620 (67'10")	25 153 (82'9")	24 974 (82'2")	39 817 (131'0")	39 993 (131'7")	69 836 (229'9")	—
12 700 (500")	6 226 (20'5")	11 069 (36'4")	17 213 (56'8")	22 804 (75'0")	22 889 (75'4")	27 925 (91'11")	27 740 (91'3")	44 241 (145'7")	44 422 (146'2")	77 595 (255'3")	—
13 970 (550")	6 849 (22'6")	12 176 (40'0")	18 919 (62'3")	25 071 (82'6")	25 158 (82'9")	30 697 (101'0")	30 506 (100'4")	48 665 (160'1")	48 852 (160'9")	85 355 (280'10")	—

NOTE:

- The projection distance listed in the table may have a variation within ± 5 %.
- Keystone (trapezoidal distortion) is compensated to be smaller than the screen size.

Calculation of the projection distance for each projection lens (for PT-D9600U)

If there is no reference made to the require picture size, calculate the projection distance using an expression below after obtaining the diagonal measurement (inch) of the screen you will use.

Model No. of projection lens	Aspect ratio	Methods of calculation of Projection distance (L)	Unit : inches
Z O O M B R E L E N S	ET-D95LE5 (1.5 – 2.0 : 1)	4:3 Min. : L = [(diagonal of screen(inches) x 1.233 + 5.67 Max. : L = [(diagonal of screen(inches) x 1.638 + 5.157	
		5:4 Min. : L = [(diagonal of screen(inches) x 1.204 + 5.67 Max. : L = [(diagonal of screen(inches) x 1.6 + 5.157	
		16:9 Min. : L = [(diagonal of screen(inches) x 1.344 + 5.67 Max. : L = [(diagonal of screen(inches) x 1.785 + 5.157	
	ET-D95LE6 (2.0 – 2.5 : 1)	4:3 Min. : L = [(diagonal of screen(inches) x 1.639 + 7.874 Max. : L = [(diagonal of screen(inches) x 2.003 + 8.031	
		5:4 Min. : L = [(diagonal of screen(inches) x 1.601 + 7.874 Max. : L = [(diagonal of screen(inches) x 1.956 + 8.031	
		16:9 Min. : L = [(diagonal of screen(inches) x 1.787 + 7.874 Max. : L = [(diagonal of screen(inches) x 2.183 + 8.031	
	ET-D95LE7 (2.5 – 4.0 : 1)	4:3 Min. : L = [(diagonal of screen(inches) x 1.999 + 2.992 Max. : L = [(diagonal of screen(inches) x 3.196 - 0.039	
		5:4 Min. : L = [(diagonal of screen(inches) x 1.952 + 2.992 Max. : L = [(diagonal of screen(inches) x 3.121 - 0.039	
		16:9 Min. : L = [(diagonal of screen(inches) x 2.178 + 2.992 Max. : L = [(diagonal of screen(inches) x 3.484 - 0.039	
	ET-D95LE8 (4.0 – 7.0 : 1)	4:3 Min. : L = [(diagonal of screen(inches) x 3.2 + 5.079 Max. : L = [(diagonal of screen(inches) x 5.606	
		5:4 Min. : L = [(diagonal of screen(inches) x 3.125 + 5.079 Max. : L = [(diagonal of screen(inches) x 5.474	
		16:9 Min. : L = [(diagonal of screen(inches) x 3.488 + 5.079 Max. : L = [(diagonal of screen(inches) x 6.11	
Fixed focal lens	4:3	L = 0.636 x diagonal of screen(inches) + 9.921	
	5:4	L = 0.659 x diagonal of screen(inches) + 9.921	
	16:9	L = 0.736 x diagonal of screen(inches) + 9.921	

Model No. of projection lens	Aspect ratio	Methods of calculation of Projection distance (L)	Unit : mm
Z O O M B R E L E N S	ET-D95LE5 (1.5 – 2.0 : 1)	4:3 Min. : L = [(diagonal of screen(inches) x 31.321 + 144 Max. : L = [(diagonal of screen(inches) x 41.605 + 131	
		5:4 Min. : L = [(diagonal of screen(inches) x 30.587 + 144 Max. : L = [(diagonal of screen(inches) x 40.63 + 131	
		16:9 Min. : L = [(diagonal of screen(inches) x 34.137 + 144 Max. : L = [(diagonal of screen(inches) x 45.346 + 131	
	ET-D95LE6 (2.0 – 2.5 : 1)	4:3 Min. : L = [(diagonal of screen(inches) x 41.635 + 200 Max. : L = [(diagonal of screen(inches) x 50.868 + 204	
		5:4 Min. : L = [(diagonal of screen(inches) x 40.659 + 200 Max. : L = [(diagonal of screen(inches) x 49.676 + 204	
		16:9 Min. : L = [(diagonal of screen(inches) x 45.378 + 200 Max. : L = [(diagonal of screen(inches) x 55.442 + 204	
	ET-D95LE7 (2.5 – 4.0 : 1)	4:3 Min. : L = [(diagonal of screen(inches) x 50.764 + 76 Max. : L = [(diagonal of screen(inches) x 81.185 - 1	
		5:4 Min. : L = [(diagonal of screen(inches) x 49.574 + 76 Max. : L = [(diagonal of screen(inches) x 79.282 - 1	
		16:9 Min. : L = [(diagonal of screen(inches) x 55.328 + 76 Max. : L = [(diagonal of screen(inches) x 88.484 - 1	
	ET-D95LE8 (4.0 – 7.0 : 1)	4:3 Min. : L = [(diagonal of screen(inches) x 81.279 + 129 Max. : L = [(diagonal of screen(inches) x 142.387	
		5:4 Min. : L = [(diagonal of screen(inches) x 79.374 + 129 Max. : L = [(diagonal of screen(inches) x 139.05	
		16:9 Min. : L = [(diagonal of screen(inches) x 88.587 + 129 Max. : L = [(diagonal of screen(inches) x 155.19	
Fixed focal lens	4:3	L = 16.153 x diagonal of screen(inches) + 252	
	5:4	L = 16.751 x diagonal of screen(inches) + 252	
	16:9	L = 18.684 x diagonal of screen(inches) + 252	

Calculation of the projection distance for each projection lens (for PT-D9500U)

If there is no reference made to the require picture size, calculate the projection distance using an expression below after obtaining the diagonal measurement (inch) of the screen you will use.

Model No. of projection lens		Aspect ratio	Methods of calculation of Projection distance (L)	Unit : inches
Zoom lens	ET-D95LE1 (1.5 – 2.5 : 1)	4:3	Min. : $L = \{(\text{diagonal of screen(inches)} + 12.87377) \times 1.2\} - 6.97$ Max. : $L = \{(\text{diagonal of screen(inches)} + 6.79329) \times 1.98\} - 6.97$	
		16:9	Min. : $L = \{(\text{diagonal of screen(inches)} / 0.9179 + 12.87377) \times 1.2\} - 6.97$ Max. : $L = \{(\text{diagonal of screen(inches)} / 0.9179 + 6.79329) \times 1.98\} - 6.97$	
	ET-D95LE2 (2.5 – 4.0 : 1)	4:3	Min. : $L = \{(\text{diagonal of screen(inches)} + 7.995693) \times 1.96\} - 6.97$ Max. : $L = \{(\text{diagonal of screen(inches)} + 4.208911) \times 3.17\} - 6.97$	
		16:9	Min. : $L = \{(\text{diagonal of screen(inches)} / 0.9179 + 7.995693) \times 1.96\} - 6.97$ Max. : $L = \{(\text{diagonal of screen(inches)} / 0.9179 + 4.208911) \times 3.17\} - 6.97$	
	ET-D95LE3 (4.0 – 7.0 : 1)	4:3	Min. : $L = \{(\text{diagonal of screen(inches)} + 3.08921) \times 3.2\} - 6.97$ Max. : $L = \{(\text{diagonal of screen(inches)} + 1.052912) \times 5.58\} - 6.97$	
		16:9	Min. : $L = \{(\text{diagonal of screen(inches)} / 0.9179 + 3.08921) \times 3.2\} - 6.97$ Max. : $L = \{(\text{diagonal of screen(inches)} / 0.9179 + 1.052912) \times 5.58\} - 6.97$	
Fixed focal lens	ET-D95LE4 (1.05 : 1)	4:3	$L = 0.81 \times \text{diagonal of screen(inches)} + 7.09$	
		16:9	$L = 0.89 \times \text{diagonal of screen(inches)} + 7.09$	

Model No. of projection lens		Aspect ratio	Methods of calculation of Projection distance (L)	Unit : mm
Zoom lens	ET-D95LE1 (1.5 – 2.5 : 1)	4:3	Min. : $L = \{(\text{diagonal of screen(inches)} + 12.87377) \times 1000/32.82965\} - 177$ Max. : $L = \{(\text{diagonal of screen(inches)} + 6.79329) \times 1000/19.87243\} - 177$	
		16:9	Min. : $L = \{(\text{diagonal of screen(inches)} / 0.9179 + 12.87377) \times 1000/32.82965\} - 177$ Max. : $L = \{(\text{diagonal of screen(inches)} / 0.9179 + 6.79329) \times 1000/19.87243\} - 177$	
	ET-D95LE2 (2.5 – 4.0 : 1)	4:3	Min. : $L = \{(\text{diagonal of screen(inches)} + 7.995693) \times 1000/19.87243\} - 177$ Max. : $L = \{(\text{diagonal of screen(inches)} + 4.208911) \times 1000/12.40818\} - 177$	
		16:9	Min. : $L = \{(\text{diagonal of screen(inches)} / 0.9179 + 7.995693) \times 1000/19.82683\} - 177$ Max. : $L = \{(\text{diagonal of screen(inches)} / 0.9179 + 4.208911) \times 1000/12.40818\} - 177$	
	ET-D95LE3 (4.0 – 7.0 : 1)	4:3	Min. : $L = \{(\text{diagonal of screen(inches)} + 3.08921) \times 1000/12.31233\} - 177$ Max. : $L = \{(\text{diagonal of screen(inches)} + 1.052912) \times 1000/7.057261\} - 177$	
		16:9	Min. : $L = \{(\text{diagonal of screen(inches)} / 0.9179 + 3.08921) \times 1000/12.31233\} - 177$ Max. : $L = \{(\text{diagonal of screen(inches)} / 0.9179 + 1.052912) \times 1000/7.057261\} - 177$	
Fixed focal lens	ET-D95LE4 (1.05 : 1)	4:3	$L = 20.64 \times \text{diagonal of screen(inches)} + 180$	
		16:9	$L = 22.49 \times \text{diagonal of screen(inches)} + 180$	

Adjusting projector feet

The four feet on the bottom of the projector are adjustable for the height (0 mm / 0" to 25 mm / 1") and can be used for its adjustment when the installation position is not level.

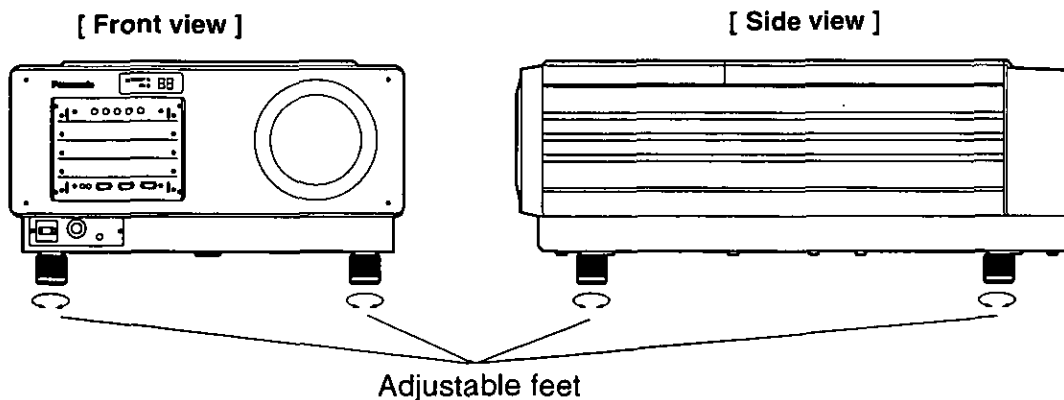

Setting the projection method

The projection method can be set in accordance with the way the projector has been installed. If the projected picture is upside-down or back-to-front, change the projection method while referring to illustrations A to D below.

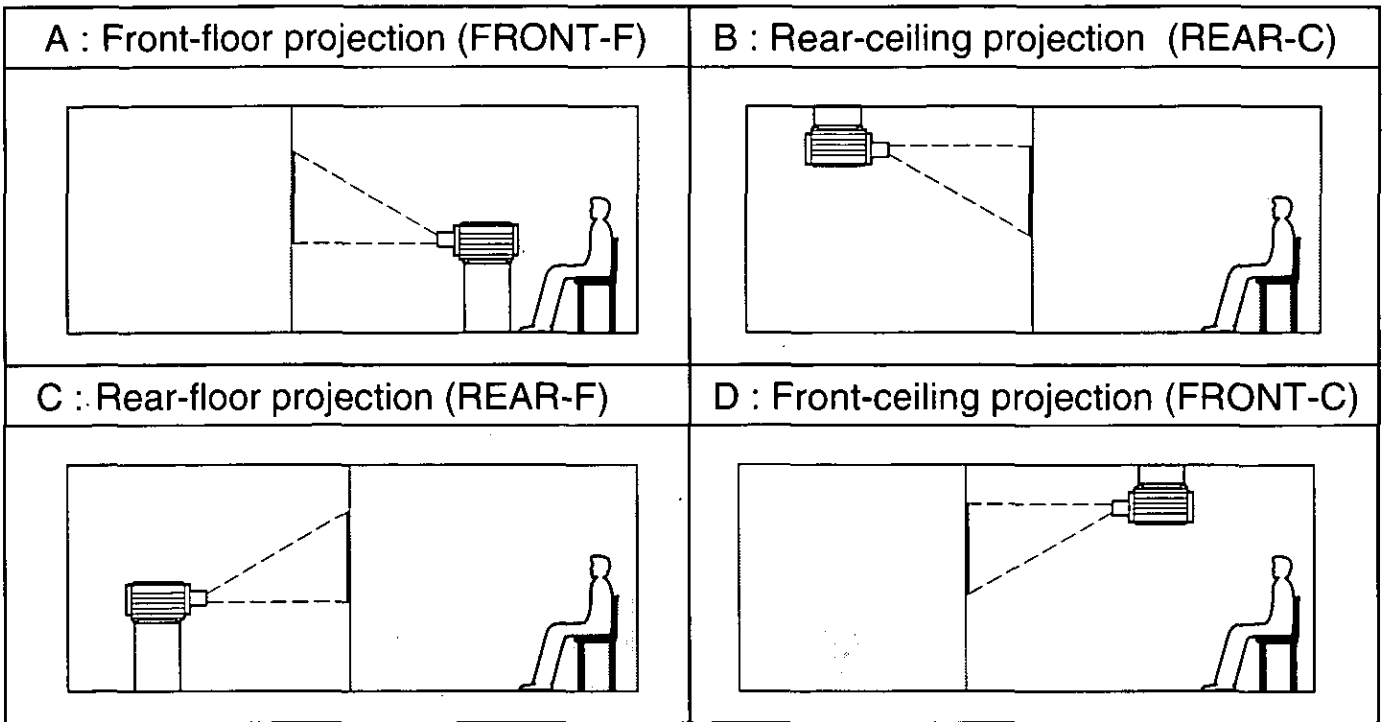

Set the projection method by displaying on-screen displays using the control buttons on the remote control unit or the projector operating panel.

Setting procedure

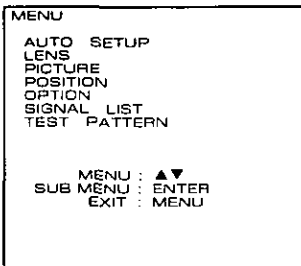

- ① Press the MENU button. ... The MENU screen will be displayed.
- ② Press the UP (▲) and DOWN (▼) arrow buttons to select OPTION.
 - The text color of a selected item will change.

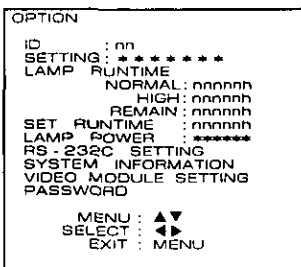

- ③ Press the ENTER button. ... The OPTION screen will be displayed.
- ④ Press the UP (▲) and DOWN (▼) arrow buttons to select SETTING.
- ⑤ Press the LEFT (◀) and RIGHT (▶) arrow buttons to select the projection method.
 - The display and the projection method will change as shown below each time the LEFT (◀) or RIGHT (▶) arrow button is pressed.

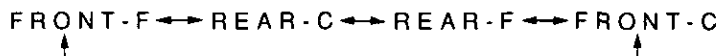

- ⑥ Press the MENU button twice.
 - The on-screen display will disappear and the screen will return to the normal state.

Adjusting the lens

Adjusting the focus

Adjustment procedure

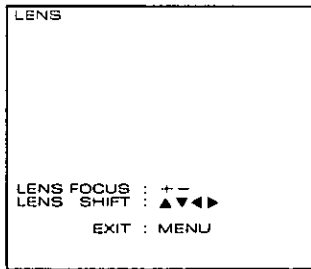

- ① Press the LENS button. ... The LENS screen will be displayed.
- ② Use the control level buttons (+ and -) to adjust the focus to the correct setting.
 - Initial pressing of these buttons will allow fine adjustment. Pressing and holding these buttons will allow the slow mode for the first six seconds and then the fast mode.
- ③ Press the MENU button.
 - The on-screen display will disappear and the screen will return to the normal state.

Note : After the zoom adjustment of a zoom lens(sold separately), adjust the focus.

Adjusting the lens position (optical shift)

Adjustment procedure

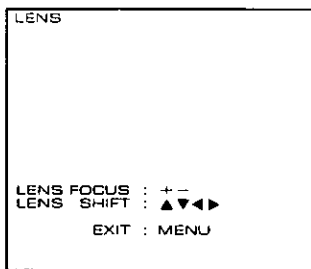

- ① Press the LENS button. ... The LENS screen will be displayed.
- ② Use the (UP, DOWN, LEFT and RIGHT (▲, ▼, ◀ and ▶) buttons to adjust the lens position so that the centre of the picture is in the centre of the screen.
 - Initial pressing of these buttons will allow fine adjustment. Pressing and holding these buttons will allow the slow mode for the first six seconds and then the fast mode.
- ③ Press the MENU button to return the screen to the normal state.

- The following procedure can also be used in lens adjustment mode.

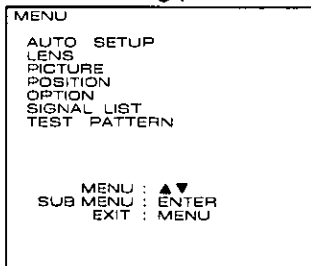

- ① Press the MENU button. ... The MENU screen will be displayed.
- ② Press the UP(▲) and DOWN(▼)arrow buttons to select LENS.
- ③ Press the ENTER button. ... The LENS screen will be displayed.

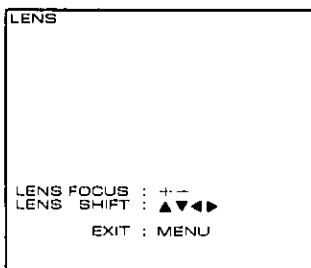

- After the display of the LENS screen, follow the above procedure.

Caution!

- Do not reach for the openings beside the optical lens, during horizontal or vertical movements of the lens there is a injury hazard.

Installing the input module

Obtain the required input modules (sold separately) beforehand in accordance with the system input signal.

• Types of input module (sold separately)

Input signal	Module No.	Input signal level
Video signal	ET-MD95VM2	Video ----- 1.0 V [p-p]
		Y ----- 1.0 V [p-p]
		C ----- 0.286 V [p-p]
		Cr ----- 0.7 V [p-p]
		Cb ----- 0.7 V [p-p]
Impedance ----- 75 Ω		
Serial digital signal	ET-MD95SD1	Conforming to SMPTE259M
Serial digital signal	ET-MD95SD2	Conforming to SMPTE259M/SMPTE294M
HD Serial digital signal	ET-MD95SD3	Conforming to SMPTE292M
SVGA,XGA,SXGA signals	ET-MD95T	Conforming to TMDS

• Input slot numbers

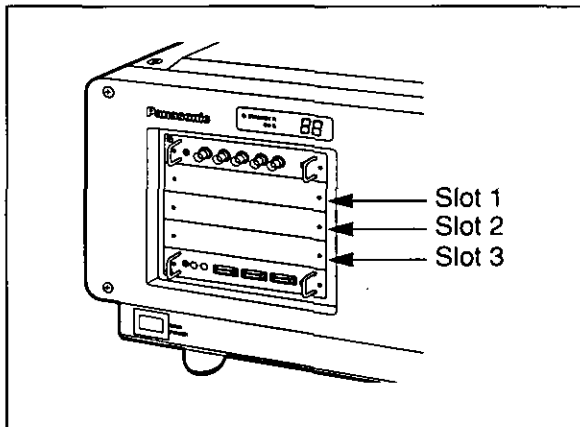

The bays (slots) in which the input modules are inserted are numbered 1, 2 and 3 in order starting from the top, as shown in the illustration at left.

The slots can be used in any order, and the same type of input module can be inserted into more than one slot at the same time. In addition, the projector will automatically detect which input module has been inserted into which slot.

It is necessary to select VIDEO or Y/C input and adjust the input signal after the input module has been inserted.

NOTE

- The signal sources connected to the input modules can each be selected by specifying the respective slot number using the input select buttons on the remote control unit or the projector operating panel. For details on selecting the input source refer to page 39.
- Modules other than the optional specified ones cannot be inserted into the slots 1, 2, and 3.

Installing the input modules

Disconnect the power supply from the projector before installing any of the input modules.
You will need a Phillips screwdriver with a No. 2 tip to install the input modules.

Installation procedure

- ① Remove the two screws which are holding the slot cover where the input module is to be installed, and then remove the slot cover.
- ② Fit the input module into the slot rails, and then push the input module in until it is seated in the connector, while being careful not to bump any of the module components.
- ③ Tighten the two screws to secure module in place.

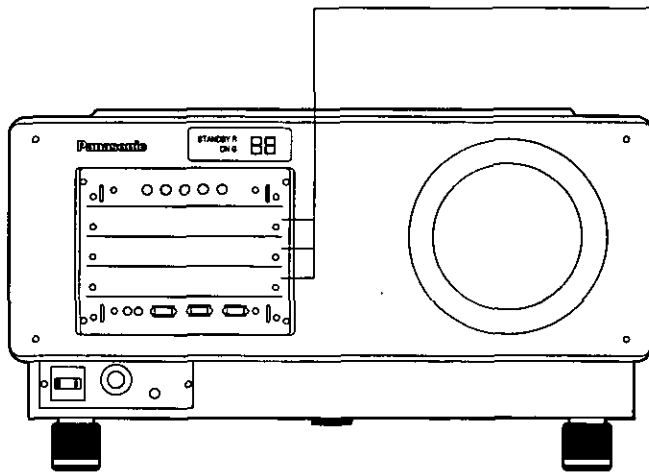

① Remove the slot cover

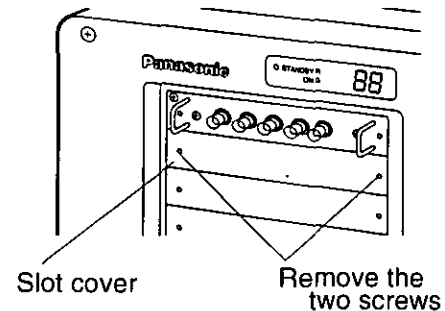

② Insert the input module

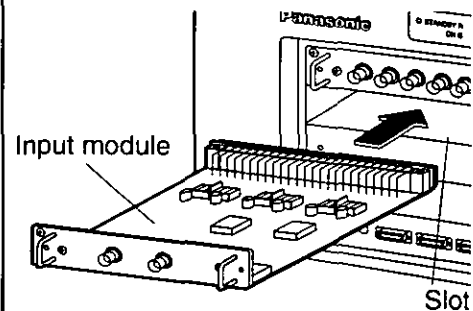

③ Secure the input module

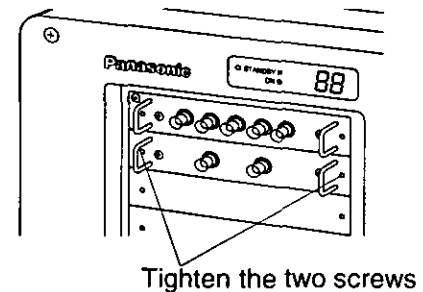

④ Register input signal

- After installing the input modules, you will need to register the input signals with the projector before they can be projected. If the input signals are not registered, they will not be projected properly when they are being input and a slot number is specified. (Refer to pages 41 and 42 for details on registering input signals.)

- NOTE**
- Up to three input modules can be installed.
 - Do not remove any of the covers on spare slots where no input module has been installed.

Connecting the input module signal

When setting up the projector, you will need to connect the signal source to an input module according to the type of signal being input.

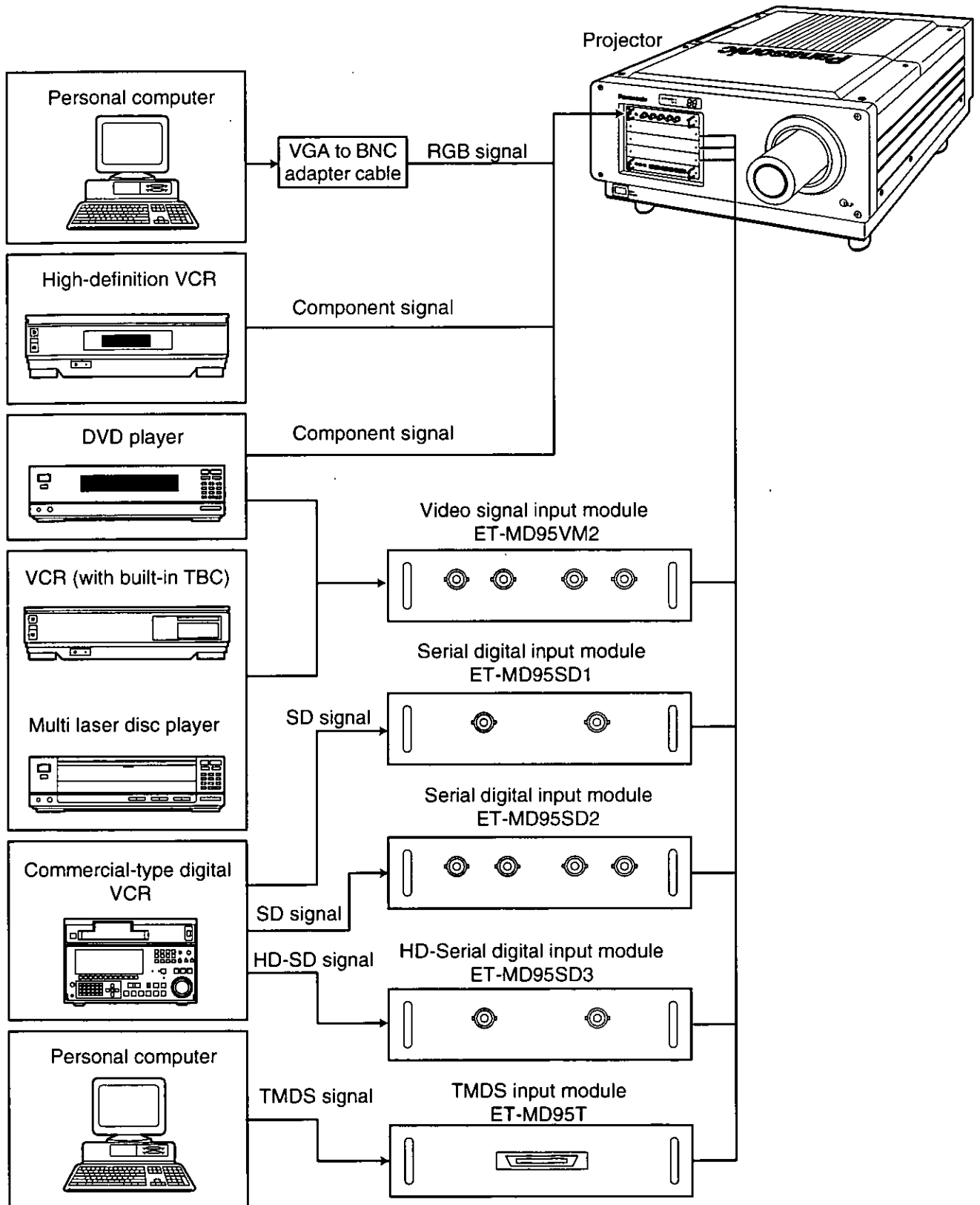

Connecting the input module signal source

Connecting the signal source to the input module for analog RGB signals

If using the input module for analog RGB signals in order to connect the projector to a personal computer, you will also need to use a separate interface (D-SUB → BNC) cable.

1. Connecting an analog RGB signal source (Analog RGB input terminals (standard))

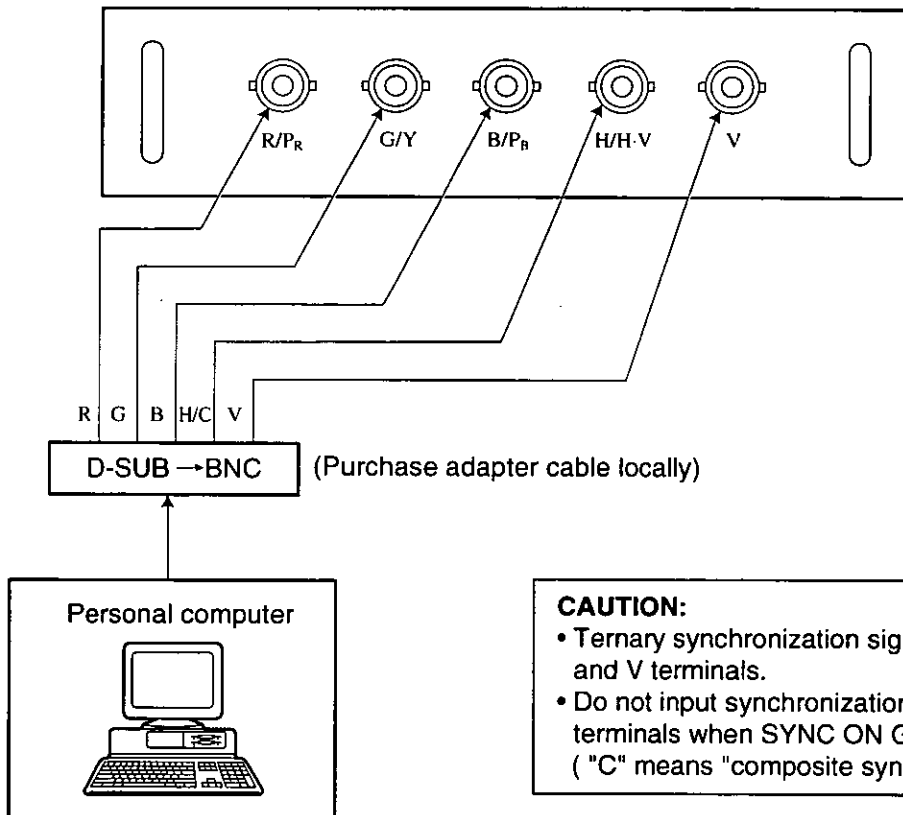

CAUTION:

- Ternary synchronization signals cannot be input to the H/C and V terminals.
- Do not input synchronization signals to the H/C and V terminals when SYNC ON GREEN signals are being input. ("C" means "composite sync" in H/C.)

2. Connecting a component signal source

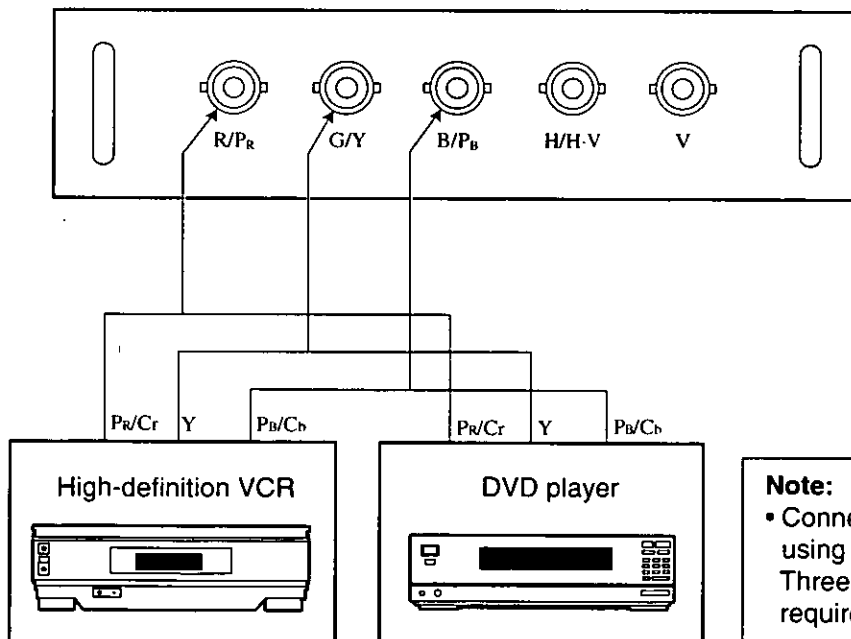

Note:

- Connect either the VCR or DVD player using three BNC cable. Three BNC-to-RCA adaptors may be required at the DVD player.

Analog RGB signals that can be input

The table below lists the different types of analog RGB signals that can be input.

If a signal which differs greatly from any of the types listed below is input, the picture image may not be displayed correctly, or black background may be displayed.

Display mode name	Signal data		
	No. of dots	Horizontal scanning frequency(kHz)	Vertical scanning frequency(Hz)
VGA400	640×400	24.8	56.4
	640×400	31.5	70.1
VGA480	640×480	31.5	59.9
	640×480	35.0	66.7
	640×480	37.9	72.8
	640×480	37.5	75.0
	640×480	43.3	85.0
SVGA	800×600	32.1	51.0
	800×600	35.2	56.3
	800×600	37.9	60.3
	800×600	48.1	72.1
	800×600	46.9	78.0
	800×600	53.7	85.1
XGA	1024×768	48.4	60.0
	1024×768	56.5	70.1
	1024×768	60.0	75.0
	1024×768	65.5	81.6
	1024×768	68.7	85.0
	1024×768i	35.5	86.8
	1024×768	80.7	100.8
	1024×768	94.0	120.0
MXGA	1152×864	63.9	70.0
	1152×864	67.5	75.0
	1152×864	77.1	85.0
	1120×750	50.1	60.1
	1120×750i	32.6	80.0
SXGA	1280×1024	52.4	50.0
	1280×1024	64.0	60.0
	1280×1024	72.4	66.3
	1280×1024	78.2	71.7
	1280×1024	80.0	75.0
	1280×1024i	46.2	86.0
	1280×1024i	47.6	88.9
MAC16	832×624	49.7	74.6
MAC21	1152×870	68.6	75.0
HDTV	960×1035i	33.8	60.0
720P	1280×720	45.0	60.0
UXGA	1600×1200	75.0	60.0

Note: • The display resolution of this projector is 1024 x 768 dots. If the display resolution indicated in the above data exceeds this resolution, the resolution will be converted to 1024 x 768 dots.

• Display resolution follows by a "i" indicate interlace signals.

Connecting the signal source to the input module for video signals

1. Connecting a video signal source

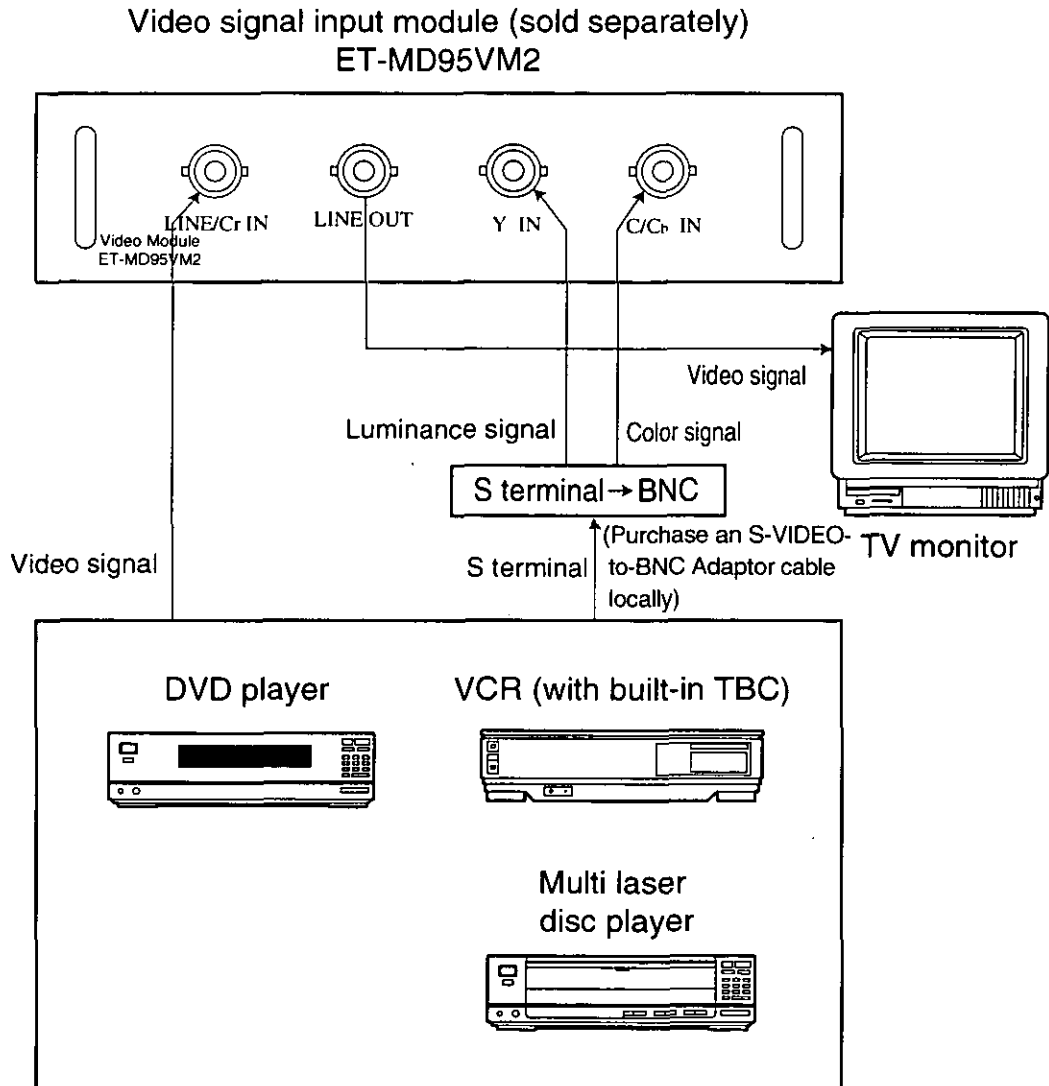

- Switching between LINE input and Y/C input is carried out by toggling the INPUT button.
(Example) If the ET-MD95VM2 is inserted in slot 1 the selection will change as follows each time the INPUT 1 button on the remote control unit (or the INPUT button on the projector operating panel) is pressed.
LINE input → Y/C input
- If connecting a VCR, be sure to use one which has a built-in TBC.
- If applying a signal with nonstandard burst signal, the picture may become unstable.
In this case, connect a time base corrector between this module and its signal source.

Connecting the signal source to the input module for video signals

2. Connecting a component signal source

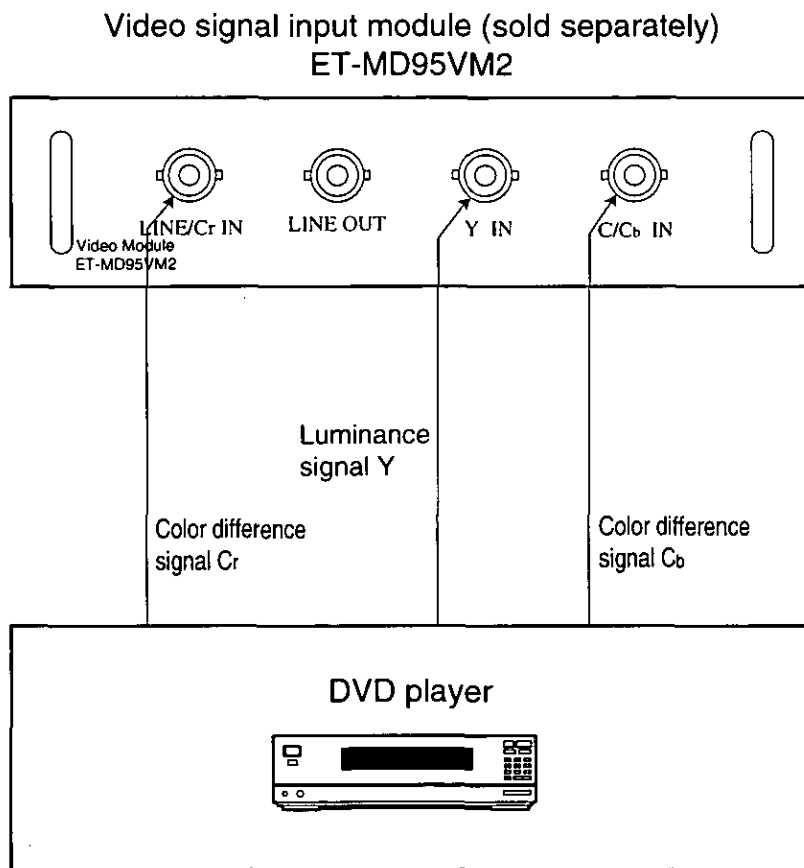

- For details of composite and component signal switching, see ET-MD95VM2 (sold separately) signal switching on page 40.

Connecting the signal source to the input module for TMDS signals

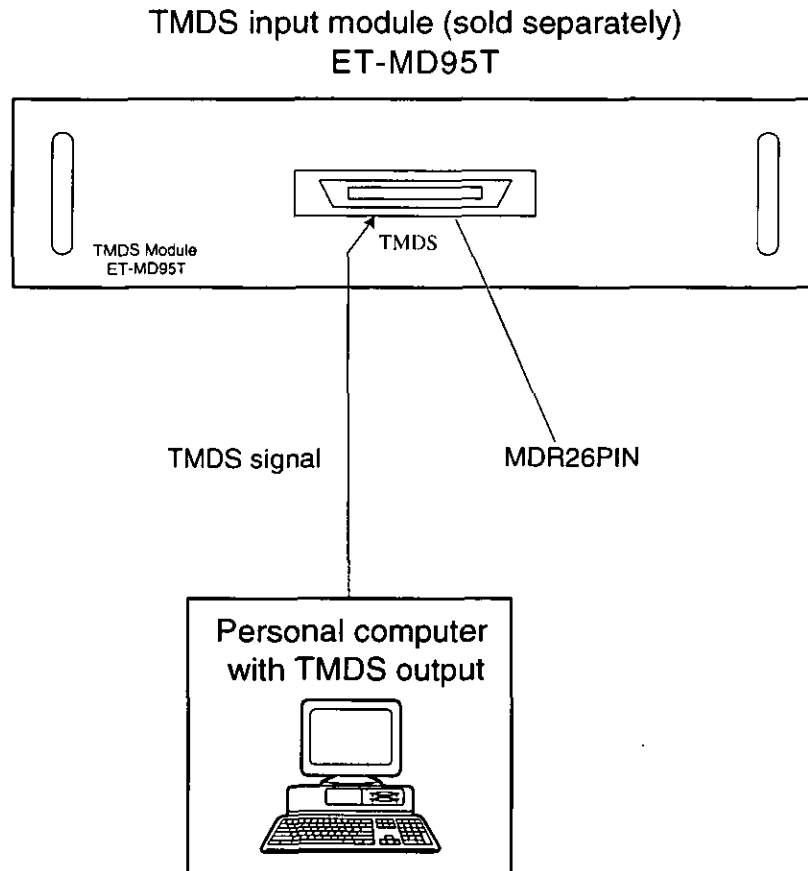

- This input module is for use with personal computers which are equipped with a TMDS output connector.
- The connector is a MDR 26-pin connector.
- The cable used should not be longer than 7 m / 22.96 feet(Recommend length : 5 m / 16.4 feet).
If a cable which is longer than 7 m (22.96 feet) is used, signal conditioning amplifier should also be used.
- Before connecting the cable, check to make sure that the projector and PC are turned off. If cable connection is attempted with the projector and/or PC turned on, the PC may be damaged.
- Concerning a connecting cable used for this module, because its characteristic impedance can affect the picture performance, consult a Panasonic sales company.

Connecting the signal source to the input module for serial digital signals

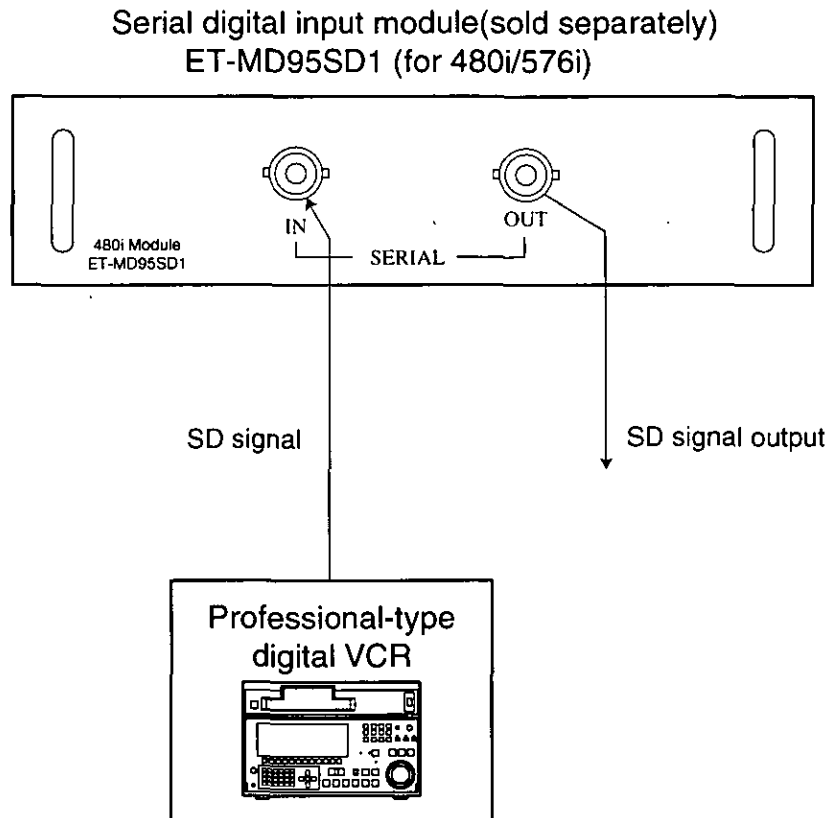

- Use an input module which correctly matches the input signal type.
- The SYSTEM SELECTOR button can be used to toggle between different formats when using input modules that can handle two different signals with different specifications. The current signal format can be checked by looking at the on-screen display.

Connecting the signal source to the input module for serial digital signals

1. 480p dual link (4:2:2p): 59.94 Hz progressive scan with 720 by 483 active lines at 270 Mbps, complying with the SMPTE294M Standard

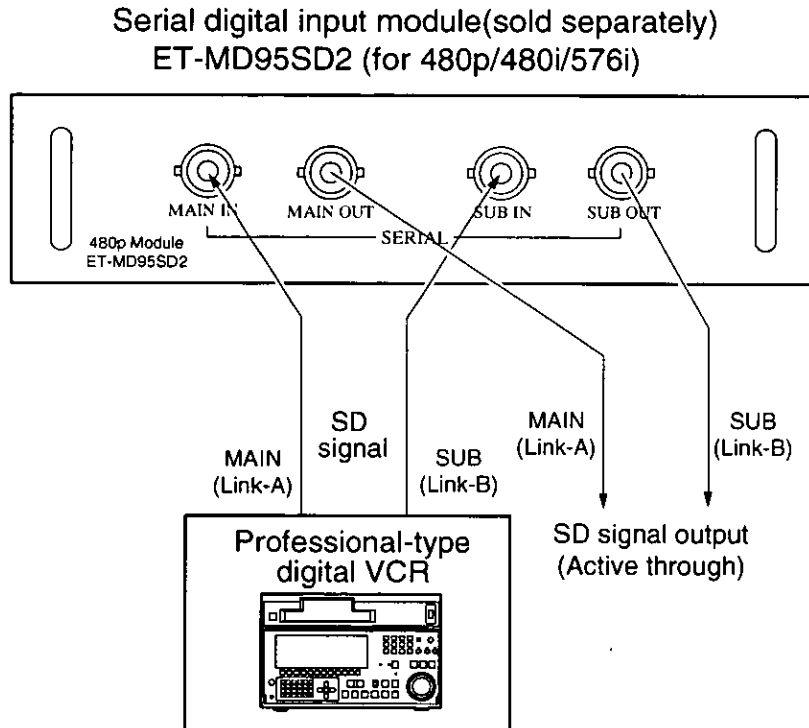

Connecting the signal source to the input module for serial digital signals

- 1) 480p single link (4:2:0p): 59.94 Hz progressive scan with 720 by 483 active lines at 360 Mbps, complying with the SMPTE294M Standard
- 2) 480i (4:2:2): 59.94 Hz interlace scan with 525 lines at 270 Mbps, complying with the SMPTE294M Standard
- 3) 576i (4:2:2): 50 Hz interlace scan with 625 lines at 270 Mbps, complying with the SMPTE294M Standard

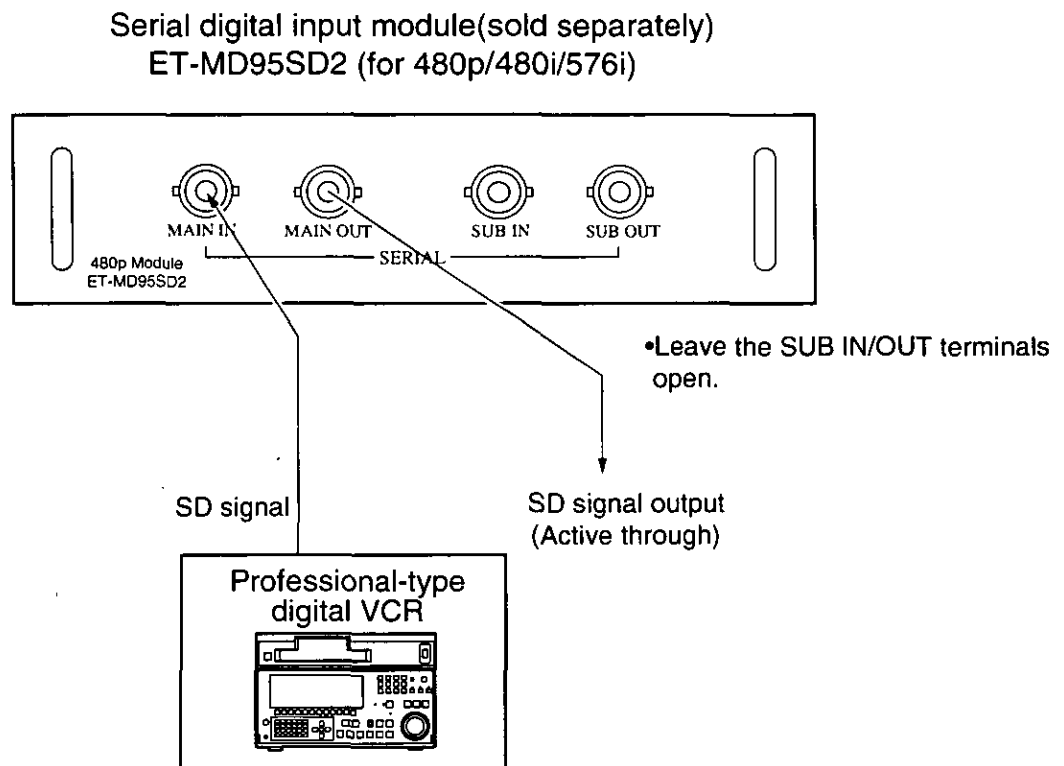

- Use an input module which correctly matches the input signal type.
- Input modules that accommodate the 4 video signal formats described above can be switched from one to another with the SYSTEM SELECTOR button that cycles through those signal formats. The selected input signal is indicated by an OSD message that automatically goes off.
- The SYSTEM SELECTOR should normally be set in the AUTO position.
- The automatic scan format identification logic may malfunction if signal connections other than those described above are employed or an unstable video signal is applied. In such an event, use the SYSTEM SELECTOR button to select the scan format that matches the video signal format applied.
- To ensure correct video signal transmission, use 3C2W or better than 3C2W cables for video interconnections (e.g., 3C2W, 3CFB, 4CFB, 5C2W, 5CFTX, 7CFB, etc.).

Connecting the signal source to the input module for serial digital signals

Serial digital input module(sold separately)
ET-MD95SD3 (for HD SDI)

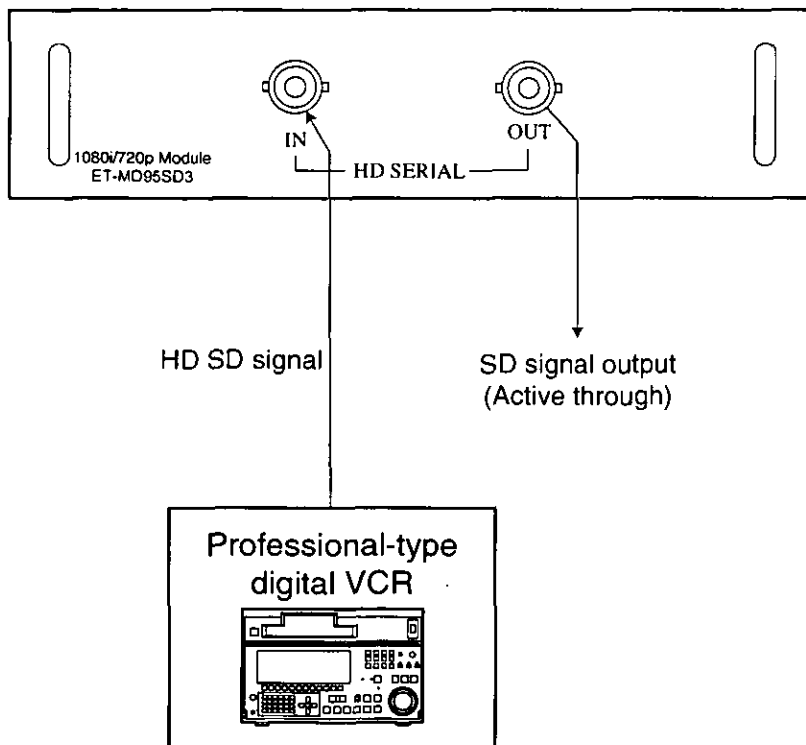

- Use an input module which correctly matches the input signal type.
- Input modules that accommodate 8 video signal formats (14 scan formats) (SMPTE292M) can be switched from one to another with the SYSTEM SELECTOR switch that cycles through those signal formats. The selected input signal is indicated by an OSD message that automatically goes off.

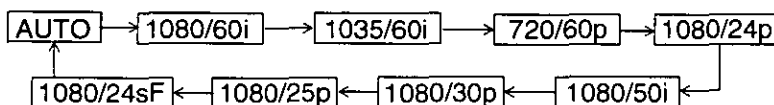

- The SYSTEM SELECTOR should normally be set in the AUTO position.
- The automatic scan format identification logic may malfunction if signal connections other than those described above are employed or an unstable video signal is applied. In such an event, use the SYSTEM SELECTOR button to select the scan format that matches the video signal format applied.
- To ensure correct video signal transmission, use 5CFB or better than 5CFB cables for video interconnections (e.g., 5CFB, 5CFTX, 7CFB, etc.).

Selecting the input signal

- The following remote control unit buttons and the INPUT button on the projector operating panel can be used to switch between different input sources.

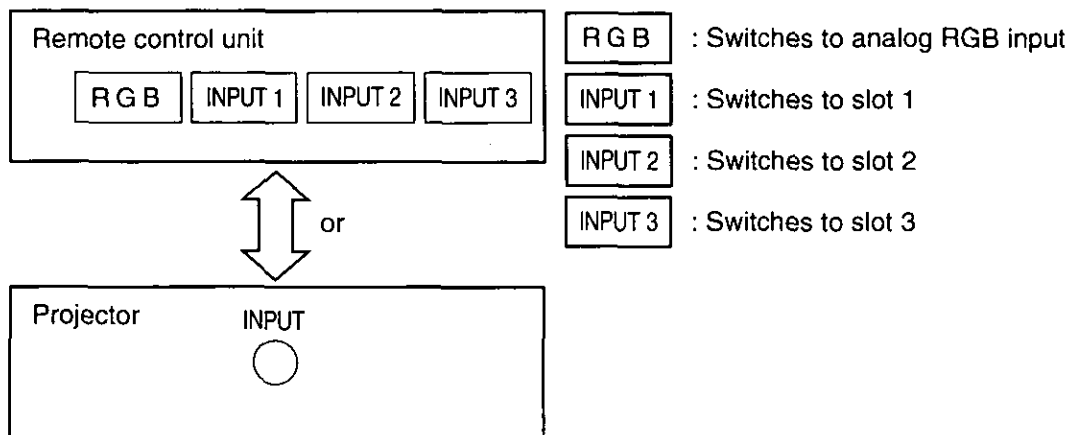

- The input source can be changed in the order RGB INPUT 1 INPUT 2 INPUT 3 each time the INPUT button on the projector operating panel is pressed.

NOTE • When using the video signal input module (ET-MD95VM2), the input source will toggle between LINE and Y/C input each time the above input selection buttons are pressed. (Example) If the ET-MD95VM2 has been installed to slot 1. When INPUT 1 of remote control (or INPUT button the projector operating panel) is pressed, LINE input will be selected, and when it is pressed once more, Y/C input will be selected.

Selecting the system format

- When the SYSTEM SELECTOR button on the remote control unit or the projector operating panel is pressed, the signal format will change as shown below depending on which input module is installed.

When analog RGB input is selected

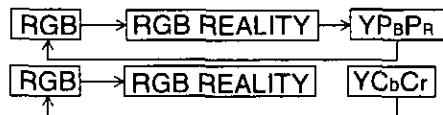

•When 720p or 1080i signals are input

•When 480i or 576i or 480p signals are input
The SYSTEM SELECTOR button will not function for signals other than the above.

Video signal input module ET-MD95VM2

•When set at AUTO1



•When set at AUTO2

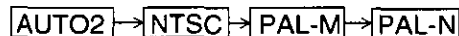

•When set at YCbCr



• For details of the AUTO1, AUTO2, or YCbCr settings, see page 40.

Serial digital input module

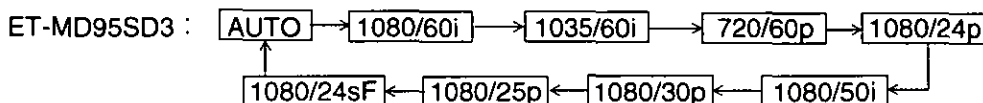
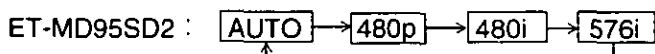

• If you press the Standard (STD) button while system format is being switched by SYSTEM SELECTOR button, selection will return to AUTO1, AUTO2, or AUTO.

NOTE • "480i" means a total of 525 lines, interlaced, and "576i" means 625 lines, interlaced, when the lines hidden by vertical blanking are counted.

Selecting the signal of ET-MD95VM2(sold separately)

When using the projector with the optional ET-MD95VM2 Video Input Module, select the appropriate video signal format that matches the video equipment you are using.

Setting procedure

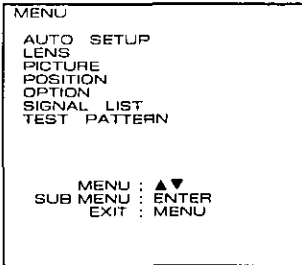

- ① Press the MENU button. ... The MENU screen will be displayed.
- ② Press the UP (▲) and DOWN (▼) arrow buttons to select OPTION.

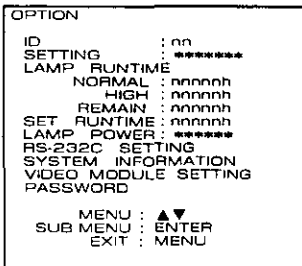

- ③ Press the ENTER button. ... The OPTION screen will be displayed.
- ④ Press the UP (▲) and DOWN (▼) arrow buttons to select VIDEO MODULE SETTING.

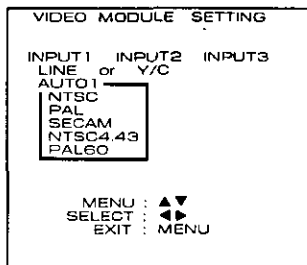

- ⑤ Press the ENTER button. ... The VIDEO MODULE SETTING screen will be displayed.
- ⑥ Press the UP (▲) and DOWN (▼) arrow buttons to select the desired INPUT MODULE.
- ⑦ Press the UP (▲) and DOWN (▼) arrow buttons to select the input signal system and press the UP (▲) and DOWN (▼) arrow buttons to select input signal format "LINE or Y/C" or "YCbCr".
 - The selected signal format will be displayed.
(The picture may be distorted while the signal format is being switched.)
- ⑧ If chose "LINE or Y/C" in step ⑦ above, press the UP (▲) and DOWN (▼) arrow buttons to select the video system and press the LEFT (◀) and RIGHT (▶) arrow buttons to select the "AUTO1" or "AUTO2".
 - The selected signal format will be displayed.
(The picture may be distorted while the signal format is being switched.)
- ⑨ Press the MENU button 3 times consecutively.
 - The OSD information will go off.

Registering input signal data

Because the projector has no factory pre-set data of input signals, be sure to register input signal data before first use.

NOTE

- Up to 64 different input signals can be registered.
- Input a signal according to an input module installed on the projector and register the signal data.
- Registering and adjustment of input signals should only be carried out by a qualified technician.

Registration new signal

- If a new signal is input and MENU key of the remote control unit or projector operating panel buttons are pressed, the new signal registration screen shown below will be displayed. The registration procedure is given below.

Registration procedure

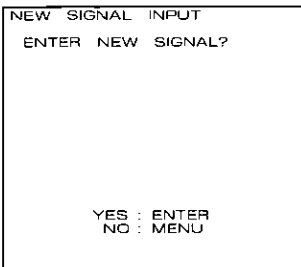

- ① Press the MENU button. ... The NEW SIGNAL INPUT screen will be displayed.

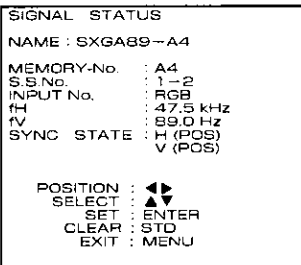

(Displayed contents is an example)

- ② Press the ENTER button. ... The SIGNAL STATUS screen will be displayed.

NOTE

- Parameters such as the memory number, signal selector input number, slot input number, type of input signal, frequency, and synchronizing signal are identified and displayed automatically.
- The memory numbers are from A1 to H8. (Each from A to H has eight memory numbers each.)
The lowest number of available memory numbers is displayed automatically. If there is no available memory number, follow the overwriting procedure on the next page.
- For the registration name (NAME), the signal name and memory number are displayed automatically.

- ③ When using the original name displayed automatically on the screen without change, press the ENTER button.
 - The registration is complete and the display will return to the MENU screen. When changing the original name, press LEFT (◀) and RIGHT (▶) arrow buttons to select a letter or number and then press the UP (▲) and DOWN (▼) arrow buttons to enter the selected letter or number. (If clearing the name change, press the STD button.)
After changing the name, press the ENTER button.
 - The registration of the new name is complete and the display will return to the MENU screen.

NOTE

- If the MENU button is pressed instead of the ENTER button, the original name will be registered instead of the new name.

When the memory does not allow new signal registration because it is full

- When a total of 64 signals has already been registered and the memory is full, inputting a new signal and pressing the MENU button on the remote control unit or the projector operating panel will display the overwriting registration screen below. In this case, to register the new data, an existing signal will be cleared and overwriting with the new data.

Overwriting registration procedure

```

NEW SIGNAL INPUT
MEMORY FULL!!
OVERWRITE OLD DATA?

YES : ENTER
NO  : MENU
    
```

- ① Press the MENU button. ... The overwriting registration screen will be displayed.

```

SIGNAL LIST
NAME      INPUT SS
nn : ***** 1  n-n
nn : ***** 2  n-n
nn : ***** 3  n-n
nn : ***** RGB n-n
nn : ***** 2  n-n
nn : <NO ENTRY> -  -
nn : <NO ENTRY> -  -

NEXT PAGE

SELECT : ▲▼
DELETE : ENTER
EXIT   : MENU
    
```

- ② Press the ENTER button. ... The SIGNAL LIST screen will be displayed.

- The memory numbers are from A1 to H8. (64 type of memory numbers, each from A to H has eight memory numbers each.)

- ③ Press the UP (▲) and DOWN (▼) arrow buttons to select the signal to be cleared.

```

SIGNAL STATUS
NAME : *****
MEMORY-No. : nnn
S.S.No.    : n-n
INPUT No.  : RGB
fH         : nnn, nkHz
fV         : nnn, nHz
SYNC STATE : *****

YES : ENTER
NO  : MENU
    
```

- ④ Press the ENTER button. ... The SIGNAL STATUS screen will be displayed.

- If not clearing the existing signal, press the MENU button to return the display to the SIGNAL LIST screen.

```

SIGNAL STATUS
NAME : *****
MEMORY-No. : nnn
S.S.No.    : n-n
INPUT No.  : RGB
fH         : nnn, nkHz
fV         : nnn, nHz
SYNC STATE : *****

POSITION : ◀▶
SELECT   : ▲▼
SET      : ENTER
CLEAR    : STD
EXIT     : MENU
    
```

- ⑤ Press the ENTER button.

- The clearing operation is complete and the SIGNAL STATUS screen will be displayed. The contents of the new signal will be displayed for each item. For the remainder of this registration procedure, follow ③ on the previous page.

Using the RGB REALITY mode

When in RGB Reality mode, the RGB video applied to the projector is internally converted into component signals to be processed by the moving image converter that provides for better picture quality.

You can choose the RGB mode best suited for the type of RGB signals you are using (refer to page 39):

RGB mode: Choose this mode when the RGB signal source is a PC or other computer-based device that focuses on still images.

RGB REALITY mode: Choose this mode when the RGB signal source is a scan converter or other video equipment that focuses on moving images.

The following lists the video signal formats compatible with the RGB Reality mode:

Signal name	fH(kHz)/fV(Hz)	RGB mode	RGB REALITY mode	Remarks
480i	15.73/60	△	◎	
576i	15.63/50	△	◎	
480p	31.47/60	○	◎	
720/60p	45.00/60	○	◎	
1035/60i	33.75/60	○	◎	
1080/60i	33.75/60	○	◎	
1080/24p	27.00/24	○	◎	
1080/50i	28.12/50	○	◎	
1080/30p	33.75/30	○	◎	
1080/25p	28.12/25	○	◎	
1080/24sF	27.00/48	○	◎	
Except above list		◎	×	RGB mode only

◎ : Compatible (factory default)

○ : Compatible (when you apply the RGB Reality mode to the signal formats marked with ○, select the signal format with the SYSTEM SELECTOR button, and then register it with the projector's memory.)

△ : These signal formats may not be compatible with RGB mode depending on signal conditions. Use the RGB Reality mode.

× : Not compatible

NOTE

- In the RGB REALITY mode, optimum adjustment values are pre-set, so it is not possible to automatically adjust the picture (page 44) or the input signal resolution (page 45).
- When in RGB REALITY mode, all of the projector's adjustments provide the same functions as those for the YPbPr(or YCbCr) input.

Adjusting the picture automatically

The automatic adjustment (AUTO SETUP) is a function to automatically adjust the resolution, clock phase, and picture position when inputting an analog RGB signal consisting of dots like a computer signal. (The input of a moving picture signal or any signal other than analog RGB signals cannot enable this function.)

It is recommendable for the automatic adjustment to input a picture signal including a brighter white box around the outside of the perimeter of a basic picture with clear, black-and-white characters and not including a halftone like a photograph or CG.

Adjustment procedure

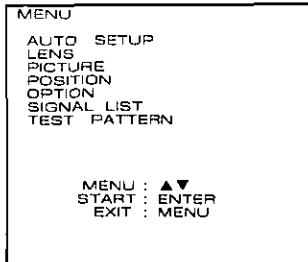

- ① Press the MENU button. ... The MENU screen will be displayed.
- ② Press the UP (▲) and DOWN (▼) arrow buttons to select AUTO SETUP.
- ③ Press the ENTER button. ... This completes the automatic adjustment.

- NOTE**
- If inputting a picture in which the edge of the screen is not known, or a dark picture, when starting the automatic adjustment the message "INCOMPLETED" will be displayed and the picture will not be adjusted automatically.
If this happens, you will need to manually adjust settings such as INPUT RESOLUTION, CLOCK PHASE and SHIFT.
If automatic adjustment completes correctly, "COMPLETED" will be displayed. Even if this happens, there may still be some cases where the clock phase will not be correct. In such cases, adjust the clock phase manually.
 - Some types of personal computer may not support automatic adjustment.
If you already know what the computer's horizontal resolution is, manually adjust the DISP DOTS setting to match the computer's horizontal resolution, and then repeat the AUTO SETUP procedure.
 - Some types of synchronizing signals for C-SYNC and G-SYNC may not support the automatic adjustment.
 - The picture may become distorted for approximately 10 seconds while automatic adjustment is being carried out, but this is normal.
 - Adjustment can be carried out separately for each input signal.

Adjusting the picture manually

Signals which cannot be adjusted automatically should be adjusted manually. The following settings can be adjusted manually, and the respective adjustment procedures are given below.

1. Input signal resolution data
2. Clock phase
3. Picture position

Adjusting the input signal resolution

Adjustment procedure

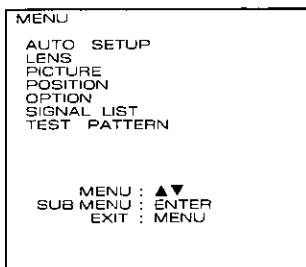

- ① Press the MENU button. ... The MENU screen will be displayed.
- ② Press the UP (▲) and DOWN (▼) arrow buttons to select POSITION.

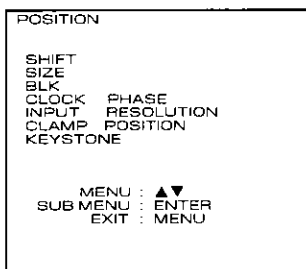

- ③ Press the ENTER button. ... The POSITION screen will be displayed.
- ④ Press the UP (▲) and DOWN (▼) arrow buttons to select INPUT RESOLUTION.

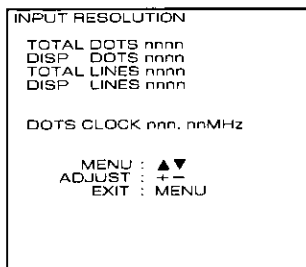

- ⑤ Press the ENTER button. ... The INPUT RESOLUTION screen will be displayed.
- ⑥ Press the UP (▲) and DOWN (▼) arrow buttons to select the desired item, and then press the LEFT (◀) and RIGHT (▶) arrow buttons to adjust.

TOTAL DOTS ----- Total number of horizontal dots
DISP DOTS ----- Actually displayed number of horizontal dots
TOTAL LINES ----- Total number of vertical lines
DISP LINES ----- Actually displayed number of vertical lines

Numeric values for each item are displayed according to the input signal. If vertical stripes or chipped areas appear on the screen, increase and decrease the displayed values to adjust the screen to its optimum state.

NOTE

- The input of an all-white picture does not allow the above stripes to appear.
- The picture may become distorted during the automatic adjustment, but this is normal.

Adjusting the clock phase

If a flicker or bleeding of the contour appears on the screen, adjust the clock phase to obtain an optimum picture.

Adjustment procedure

```
MENU
AUTO SETUP
LENS
PICTURE
POSITION
OPTION
SIGNAL LIST
TEST PATTERN

MENU : ▲▼
SUB MENU : ENTER
EXIT : MENU
```

- ① Press the MENU button. ... The MENU screen will be displayed.
- ② Press the UP (▲) and DOWN (▼) arrow buttons to select POSITION.

```
POSITION
SHIFT
SIZE
BLK
CLOCK PHASE
INPUT RESOLUTION
CLAMP POSITION
KEYSTONE

MENU : ▲▼
SUB MENU : ENTER
EXIT : MENU
```

- ③ Press the ENTER button. ... The POSITION screen will be displayed.
- ④ Press the UP (▲) and DOWN (▼) arrow buttons to select CLOCK PHASE.

```
CLOCK PHASE
14

ADJUST : + -
EXIT : MENU
```

- ⑤ Press the ENTER button. ... The CLOCK PHASE screen will be displayed.
- ⑥ Use the control level buttons (+ and -) to adjust the clock phase.
 - The adjustment values will change from 0 (min.) to 19 (max.).

NOTE

- If the signal output from the personal computer is itself unstable, it may not be possible to obtain an optimum adjustment value.
- If the TOTAL DOTS setting is incorrect, it may not be possible to obtain an optimum adjustment value.

Adjusting the picture position

Adjustment procedure

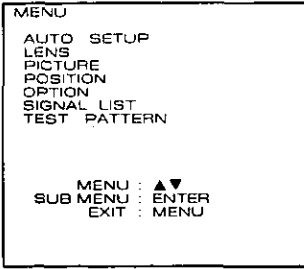

- ① Press the MENU button. ... The MENU screen will be displayed.
- ② Press the UP (▲) and DOWN (▼) arrow buttons to select POSITION.

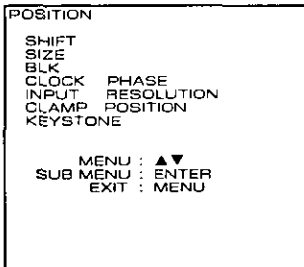

- ③ Press the ENTER button. ... The POSITION screen will be displayed.
- ④ Press the UP (▲) and DOWN (▼) arrow buttons to select SHIFT.

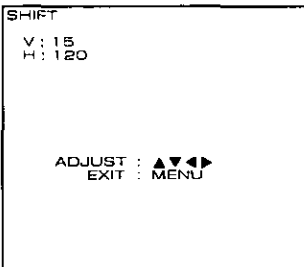

- ⑤ Press the ENTER button. ... The SHIFT screen will be displayed.
- ⑥ Press the UP, DOWN, LEFT and RIGHT (▲, ▼, ◀ and ▶) arrow buttons to adjust the picture position.
- ⑦ Press the MENU button three times.
 - The on-screen display will disappear and the screen will return to the normal state.

< When adjusting the horizontal position >

If the ▶ button is pressed, the picture moves to the right.

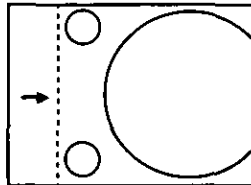

If the ◀ button is pressed, the picture moves to the left.

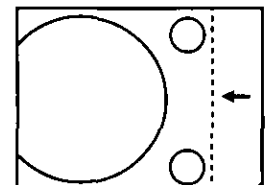

< When adjusting the vertical position >

If the ▲ button is pressed, the picture moves to the up.

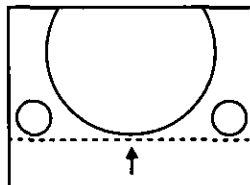

If the ▼ button is pressed, the picture moves to the down.

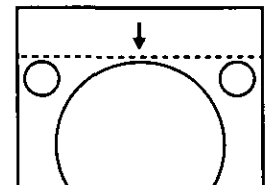

Adjusting the blanking

If picture noise appears at the perimeter of the screen or a picture extends off the screen a little, adjust the blanking to fine-tune the screen.

Adjustment procedure

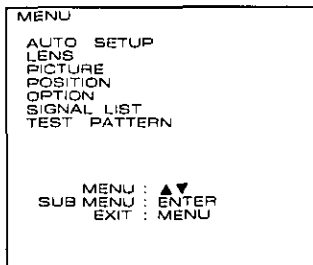

- ① Press the MENU button. ... The MENU screen will be displayed.
- ② Press the UP (▲) and DOWN (▼) arrow buttons to select POSITION.

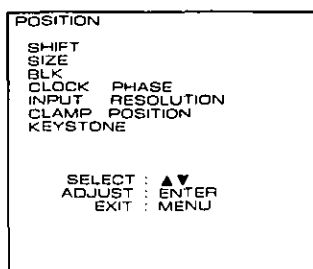

- ③ Press the ENTER button. ... The POSITION screen will be displayed.
- ④ Press the UP (▲) and DOWN (▼) arrow buttons to select BLK.

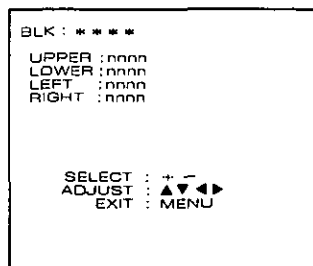

- ⑤ Press the ENTER button. ... The BLK screen will be displayed.
- ⑥ Press the control level buttons (+ and -) to select the desired BLK mode from those indicated below.
UPPER, LOWER, LEFT, RIGHT
- ⑦ Press the UP (▲) and DOWN (▼) arrow buttons to adjust UPPER and LOWER, or Press the LEFT (◀) and RIGHT (▶) arrow buttons to adjust LEFT and RIGHT.
 - The adjustment values will change from 0 (min.) to 256 (max.).

<When adjusting the upper blanking>

If the ▲ button is pressed, the blanking portion moves upward. If the ▼ button is pressed, the blanking portion moves downward.

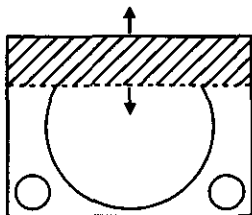

<When adjusting the lower blanking>

If the ▲ button is pressed, the picture moves upward. If the ▼ button is pressed, the blanking portion moves downward.

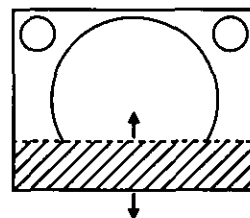

<When adjusting the left blanking>

If the ▶ button is pressed, the picture moves to the right. If the ◀ button is pressed, the blanking portion moves to the left.

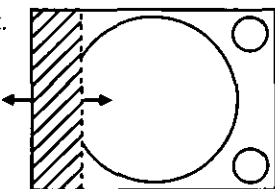

<When adjusting the right blanking>

If the ▶ button is pressed, the blanking portion moves to the right. If the ◀ button is pressed, the blanking portion moves to the left.

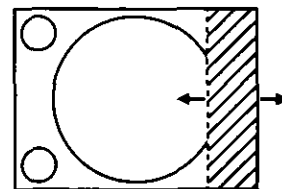

Adjusting the clamp position

- If the black portions of the picture are fractured or tinged with green, adjust the clamp position its optimum state.

Adjustment procedure

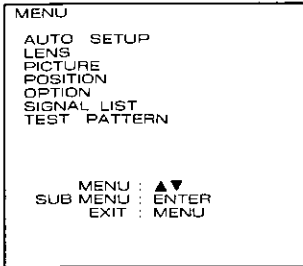

- ① Press the MENU button. ... The MENU screen will be displayed.
- ② Press the UP (▲) and DOWN (▼) arrow buttons to select POSITION.

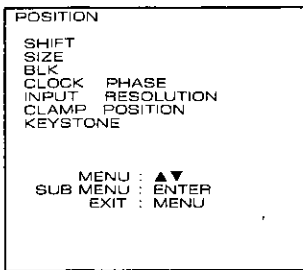

- ③ Press the ENTER button. ... The POSITION screen will be displayed.
- ④ Press the UP (▲) and DOWN (▼) arrow buttons to select CLAMP POSITION.

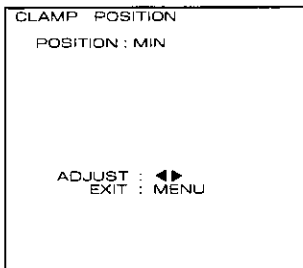

- ⑤ Press the ENTER button. ... The CLAMP POSITION screen will be displayed.
- ⑥ Press the LEFT (◀) and RIGHT (▶) arrow buttons to adjust.
 - The adjustment values will change from 0 (min.) to 255 (max.)

Optimum value for clamp position adjustment

- If the black sections are fractured → The optimum value is when the fracturing of the black sections is at a minimum.
- If the black sections are tinged with green → Optimum value is when the green portion turns black but is not smudged.

Picture mute function

The projector has a picture mute capability that allows you to put the image off instantaneously. To mute the image, press the PIC-MUTE button on the projector or remote control. To reset picture mute, press the PIC-MUTE button a second time.

Adjusting the keystone(Trapezoidal distortion)

- The KEYSTONE adjustment allows you to compensate for pictures' horizontal trapezoidal distortion. When the YC video or RGB REALITY mode is selected, the picture is only trimmed into a rectangular frame, with trapezoidal distortion left in the images.

Adjustment procedure

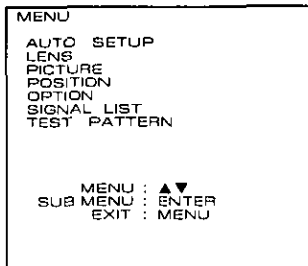

- ① Press the MENU button. ... The MENU screen will be displayed.
- ② Press the UP (▲) and DOWN (▼) arrow buttons to select POSITION.

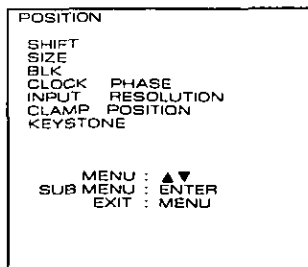

- ③ Press the ENTER button. ... The POSITION screen will be displayed.
- ④ Press the UP (▲) and DOWN (▼) arrow buttons to select KEYSTONE.

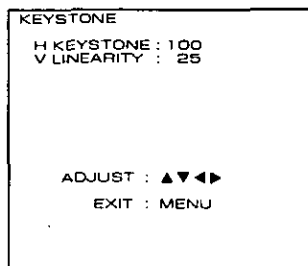

- ⑤ Press the ENTER button. ... KEYSTONE screen will be displayed.
- ⑥ Press the LEFT (◀) and RIGHT (▶) arrow buttons to correct horizontal keystone (trapezoidal distortion).
 - The adjustment values will change from 0 (min.) to 200 (max.)
- ⑦ Press the UP (▲) and DOWN (▼) arrow buttons to adjust vertical linearity.
 - The adjustment values will change from 0 (min.) to 255 (max.)

NOTE

- Adjust vertical linearity after adjusting horizontal keystone. The variable range of V LINEARITY changes with the H KEYSTONE adjustment setting.
- To reset H KEYSTONE and V LINEARITY to their respective factory default settings (H KEYSTONE:100 and V LINEARITY: 25), press the Standard (STD) button on the remote control.
- H KEYSTONE and V LINEARITY settings are reflected to other input signals as well.
- The keystone adjustment can compensate for trapezoidal distortion that corresponds to the projector's elevation angle (to the screen) to within $\pm 10^\circ$.
- The keystone adjustment has different effects on RGB and YC signals:
 - RGB signals: The original images are preserved as they are after keystone compensation thanks to digital processing.
 - YC signals: Part of the original image is trimmed and lost by keystone adjustment due to blanking.

<For Keystone Distortion Broadened Toward the Bottom>

Press and hold the right arrow button ▶ until both sides of the frame become completely vertical. In case of over-adjustment, use the left arrow button ◀ to step back.

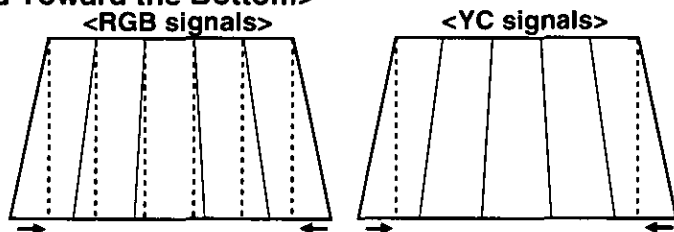

RGB signals: Includes analog RGB and TMDS signals.

YC signals: Includes the Video Signal module, Digital Serial Signal module, analog YPBPR input, and analog RGB input all placed in RGB REALITY mode.

Adjusting the picture to the desired setting

The following procedures can be used to adjust the picture to the desired appearance.

Adjustment procedure ... Adjusting the COLOR setting

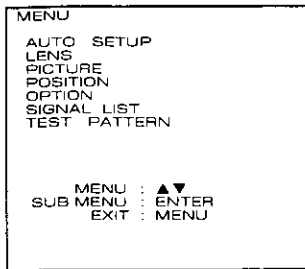

- ① Press the MENU button. ... The MENU screen will be displayed.
- ② Press the UP (▲) and DOWN (▼) arrow buttons to select PICTURE.

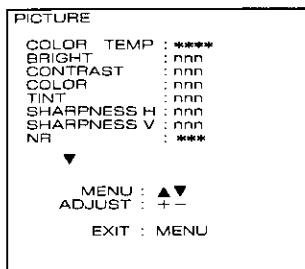

- ③ Press the ENTER button. ... The PICTURE screen will be displayed.
- ④ Press the UP (▲) and DOWN (▼) arrow buttons to select COLOR.

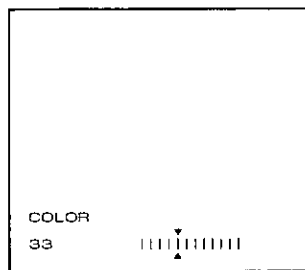

- ⑤ Press the ENTER button. ... The COLOR individual adjustment screen will be displayed.
- ⑥ Use the control level buttons (+ and -) to adjust the COLOR setting level.
 - *1. The functions of the LEFT (◀) and RIGHT (▶) arrow buttons change depending on the adjustment item selected. Refer to the table below for details.
 - *2. For some types of input signal, it may not be possible to adjust some of the settings. In such cases, the adjustment level display will appear as “- -”.
- ⑦ If you would like to adjust the BRIGHT, CONTRAST and TINT settings, repeat steps ④, ⑤ and ⑥.
- *3. If adjusting the BRIGHT and CONTRAST settings, the individual adjustment screens can be displayed by pressing the respective buttons on the remote control unit.

Adjustment Item	Operation	Adjustment Details	Adjustment Range	Remarks
COLOR	Press the [+] button.	The color becomes pastel.	Max. value 100	Except analog RGB and TMDS signals
	Press the [-] button.	The color becomes more intense.	Min. value 0	
TINT	Press the [+] button.	Flesh tones become greenish.	Max. value 60	Except analog RGB and TMDS signals
	Press the [-] button.	Flesh tones become reddish.	Min. value 0	
BRIGHT	Press the [+] button.	The screen becomes brighter.	Max. value 63	
	Press the [-] button.	The screen becomes darker.	Min. value 0	
CONTRAST	Press the [+] button.	The bright areas become brighter.	Max. value 63	
	Press the [-] button.	The bright areas become darker.	Min. value 0	

NOTE

- If approximately five seconds pass without any buttons being pressed while an individual adjustment screen is being displayed, the display will return to the PICTURE screen.
- COLOR and TINT settings cannot be adjusted for analog RGB input and TMDS input.

Adjusting the picture to the desired setting (continued)

Adjusting the white balance

Adjustment procedure (Project a signal to be adjusted)

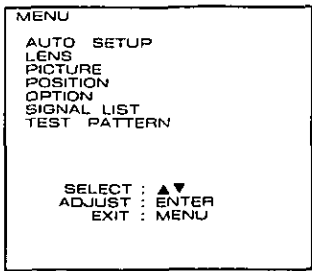

- ① Press the MENU button. ... The MENU screen will be displayed.
- ② Press the UP (▲) and DOWN (▼) arrow buttons to select PICTURE.

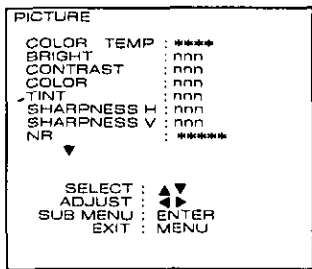

- ③ Press the ENTER button. ... The PICTURE screen will be displayed.
- ④ Press the UP (▲) and DOWN (▼) arrow buttons to select COLOR TEMP.
- ⑤ Press the LEFT (◀) and RIGHT (▶) arrow buttons to select the desired setting from those indicated below.
LOW, MID, HIGH, USER, DYNAMIC

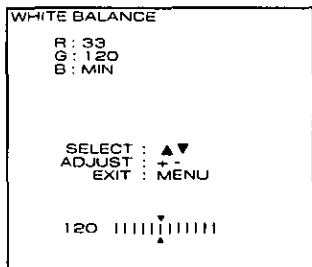

- (If you would like to further adjust the white balance)
- ⑥ Select USER in step ⑤.
 - ⑦ Press the ENTER button. ... The WHITE BALANCE screen will be displayed.
 - ⑧ Press the UP (▲) and DOWN (▼) arrow buttons to select either R, G or B.
 - ⑨ Use the control level buttons (+ and -) to adjust the setting level.

Adjustment Item	Operation	Adjustment Details	Adjustment Range
R (Red)	Press the [+] button.	The red component becomes stronger.	Max. value 255 Min. value 0
	Press the [-] button.	The red component becomes weaker.	
G (Green)	Press the [+] button.	The green component becomes stronger.	
	Press the [-] button.	The green component becomes weaker.	
B (Blue)	Press the [+] button.	The blue component becomes stronger.	
	Press the [-] button.	The blue component becomes weaker.	

- NOTE**
- If these adjustments are not made correctly, none of the colors will be reproduced correctly.
 - If you make an error in adjustment so that the colors do not match correctly, press the STD button while one of the individual adjustment screens is being displayed. Only the item being displayed will be reset to the factory pre-settings.
 - The projection of a built-in test pattern (Refer to page 59.) does not allow the white balance adjustment. Be sure to project an external input signal for this adjustment.
 - The COLOR TEMP adjustment is allowed only when inputting an analog RGB or TMDS at GAMMA MODE 6.

Adjusting the picture quality

The following procedures can be used to adjust the picture quality to the desired setting.

Adjustment procedure

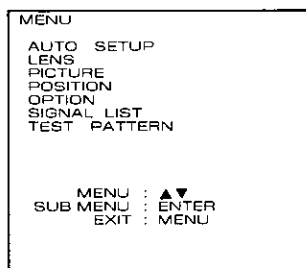

- ① Press the MENU button. ... The MENU screen will be displayed.
- ② Press the UP (▲) and DOWN (▼) arrow buttons to select PICTURE.

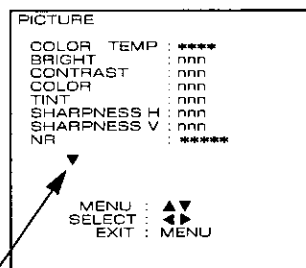

- ③ Press the ENTER button. ... The PICTURE screen will be displayed.

NOTE

- If a ▼ or ▲ indicator is shown at the bottom or top of the adjustment items list in the PICTURE window, it indicates that the remaining part of the list can be scrolled up or down in the window. Use the UP or DOWN arrow button (▲▼) to scroll the list.

▼ indicator

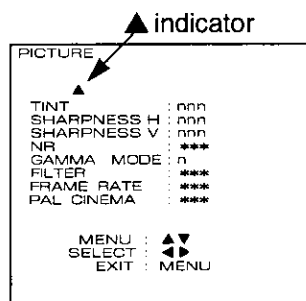

- ④ Press the UP (▲) and DOWN (▼) arrow buttons to step through the adjustment items list until you reach the target item.
 - ⑤ Press the LEFT (◀) and RIGHT (▶) arrow buttons to change the current setting.
- For available adjustment items and settings, see the table on the next page.

Adjustment Item	Operation	Adjustment Details
SHARPNESS H	Makes the horizontal contours sharper.	Nine steps from OFF to 8 (factory default : 2) A larger value causes a greater effect
SHARPNESS V	Makes the vertical contours sharper.	Four steps from OFF to 3 (factory default : 2) A larger value causes a greater effect
NR (Noise Reduction)	Selects the noise reduction effectiveness.	OFF: No correction 1 : Weak 2 : Medium (factory default) 3 : Strong A larger value causes a greater effect
GAMMA MODE	Selects the gamma mode.	Seven steps from 0 to 6 (factory default : 6) The only setting 6 allows the COLOR TEMP adjustment.
FILTER	For the PT-D9500U, use this adjustment to select interpolation filter settings for signals other than XGA. For the PT-D9600U, use this adjustment to select interpolation filter settings for signals other than SXGA.	Five types from 0 to 4 (factory default : 2) 0 : Gives priority to contrast. 4 : Restricts the loss in picture information to a minimum.
FRAME RATE	Use this adjustment to choose the best frame rate conversion for minimum flicker on individual HDTV signal input.	24p → 60p / 24p → 24p (factory default: 24p → 60p) 25p → 50p / 25p → 25p (factory default: 25p → 50p) 30p → 60p / 30p → 30p (factory default: 30p → 60p)
PAL CINEMA	Use this adjustment to further enhance vertical resolution when a 576i PAL (or SECAM) signal is applied.	OFF: Normal ON : Effect On (see the following notes.)

NOTE

- SHARPNESS V and NR (noise reduction) settings cannot be adjusted for analog RGB input and TMDS input.
- The FILTER adjustment is ineffective for XGA (1 024 x 768) mode on the PT-D9500U, or SXGA (1 280 x 1 024) mode on the PT-D9600U. It is also ineffective for any video input mode other than analog RGB and TMDS modes, or if "THROUGH" is chosen for the SIZE mode (see pages 56 and 57).
- FRAME RATE is effective only for analog RGB, HD serial, 1080/30p, 1080/25p, 1080/24p, and 1080/24sF video signal formats.
- PAL CINEMA is effective only for the 576i PAL (or SECAM) standard.
- PAL CINEMA will cause degraded picture quality (lowered vertical resolution) if used for signals other than those pulled down at a 2:2 ratio.
- For 480p, 480i or 576i scan format, SHARPNESS H defaults to 7.

Adjusting the picture size

Adjustment procedure

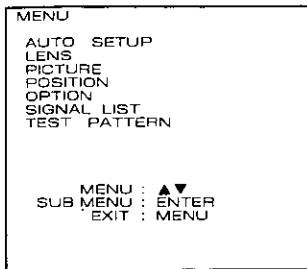

- ① Press the MENU button. ... The MENU screen will be displayed.
- ② Press the UP (▲) and DOWN (▼) arrow buttons to select POSITION.

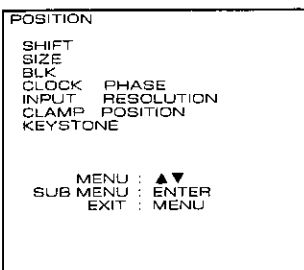

- ③ Press the ENTER button. ... The POSITION screen will be displayed.
- ④ Press the UP (▲) and DOWN (▼) arrow buttons to select SIZE.

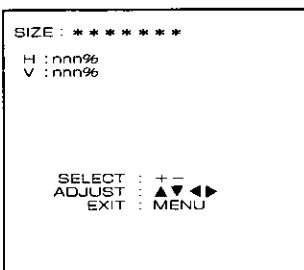

- ⑤ Press the ENTER button. ... The SIZE screen will be displayed.
- ⑥ Press the control level buttons (+ and -) to select the desired size mode from those indicated below.
DEFAULT, THROUGH, H-FIT, V-FIT, HV-FIT, ZOOM
• "4:3", "16:9" ----- Modes other than the analog RGB or TMDS input allow the selection.

Size modes

DEFAULT ...The input signal is projected with the aspect ratio unchanged.

THROUGH .The input signal is projected with the resolution unchanged.

H-Fit.....The input signal is projected with all horizontal panel picture elements used.

For signals with a aspect ratio which is vertically longer than 4:3(for the PT-D9500U)/ 5:4(for the PT-D9600U), the top and bottom edges of the picture are cropped.

V-FitThe input signal is projected with all vertical panel picture elements used.

For signals with a aspect ratio which is horizontally longer than 4:3(for the PT-D9500U)/ 5:4(for the PT-D9600U), the left and right edges of the picture are cropped.

HV-FitThe input signal is converted to an aspect ratio of 4:3(for the PT-D9500U) / 5:4(for the PT-D9600U).

For signals with an aspect ratio other than 4:3(for the PT-D9500U) / 5:4(for the PT-D9600U), circles in the picture become distorted, etc.









ZOOMThe enlargement ratio of the picture is changed. The enlargement ratio in both the horizontal and vertical directions can be changed to between 50 % and 999 %(except analog RGB, TMDS input), between 75 % and 999 %(up to SXGA of analog RGB, TMDS input),between 100 % and 999 %(more than UXGA of analog RGB, TMDS input) with the top-left corner of the screen as the reference point.

4:3The input signal is projected with the aspect ratio 4:3.

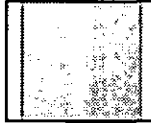
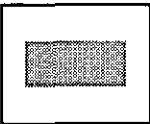
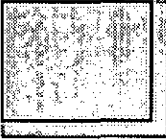
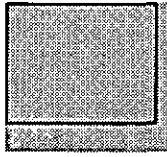
16:9The input signal is projected with the aspect ratio 16:9.

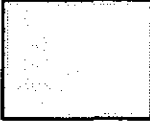

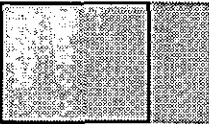
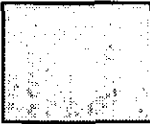
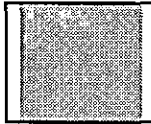
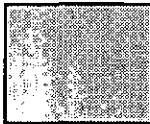
- An overscan of 7 % is applied to all modes other than analog RGB input and TMDS input.

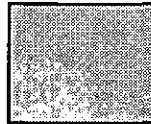
Screen examples for different size settings (For PT-D9500U)

INPUT PICTURE SIZE SETTING	8 : 5 (640 × 400)	4 : 3 (1152 × 864)	5 : 4 (1280 × 1024)
Default	 The picture is displayed at maximum size while maintaining the original aspect.		
Through			
H-Fit			
V-Fit			
HV-Fit			

* If the picture extends outside the screen, the top-left corner is used as the reference point.

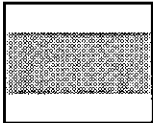
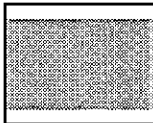
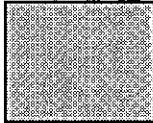
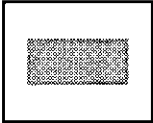
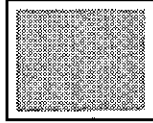
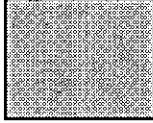
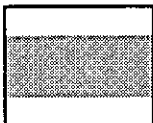
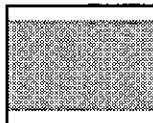
Screen examples for different size settings (For PT-D9600U)

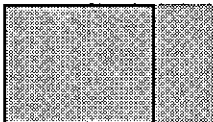
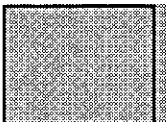
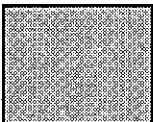
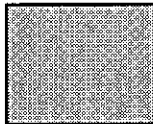
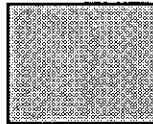
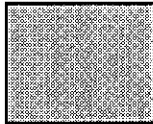
INPUT PICTURE SIZE SETTING	8 : 5 (640 × 400)	4 : 3 (1152 × 864)	5 : 4 (1280 × 1024)
Default	 <p data-bbox="483 574 735 645">The picture is displayed at maximum size while maintaining the original aspect.</p>		
Through			
H-Fit			
V-Fit			
HV-Fit			

* If the picture extends outside the screen, the top-left corner is used as the reference point.

Power up function

Power up function

The projector is provided with a power up function which allows the performance of the lamp to be utilized to the maximum level.

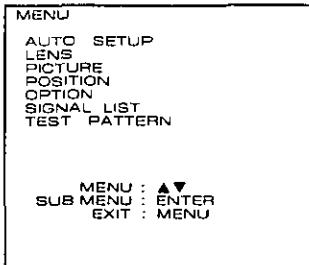

- ① Press the MENU button. ... The MENU screen will be displayed.
- ② Press the UP (▲) and DOWN (▼) arrow buttons to select OPTION.

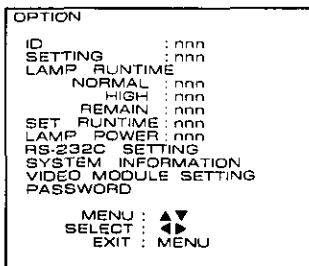

- ③ Press the ENTER button. ... The OPTION screen will be displayed.
- ④ Press the UP (▲) and DOWN (▼) arrow buttons to select LAMP POWER.
- ⑤ Press the LEFT (◀) and RIGHT (▶) arrow buttons to select HIGH (power up) setting in LAMP POWER mode.

Setting	Mode
HIGH	Power up mode
NORMAL	Normal mode

- ⑥ Press the MENU button twice.
 - The on-screen display will disappear and the screen will return to the normal state.

- CAUTION**
- Power up mode (HIGH) is cancelled when the power is turned off. Therefore, the mode will return to the normal usage mode (NORMAL) when the power is turned back on.
 - When HIGH has been set in LAMP POWER mode, the lamp's useful life will be shorter compared to normal mode.

Displaying a test pattern

17 types of test pattern are built in. These test patterns can be used to check the various adjustment settings. Use the following procedure to display a test pattern.

NOTE • These test patterns cannot reflect the adjustment results of various picture settings such as picture quality, positions, and sizes. Be sure to project an external input signal for various adjustments.

Operating procedure

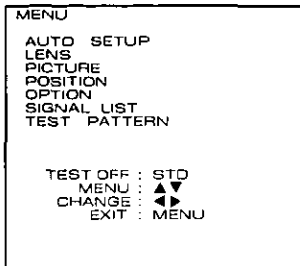

- ① Press the MENU button. ... The MENU screen will be displayed.
- ② Press the UP (▲) and DOWN (▼) arrow buttons to select TEST PATTERN.
- ③ Press the LEFT (◀) and RIGHT (▶) arrow buttons to select the required test pattern.

Test pattern display chart (◀ LEFT and ▶ RIGHT arrow buttons)

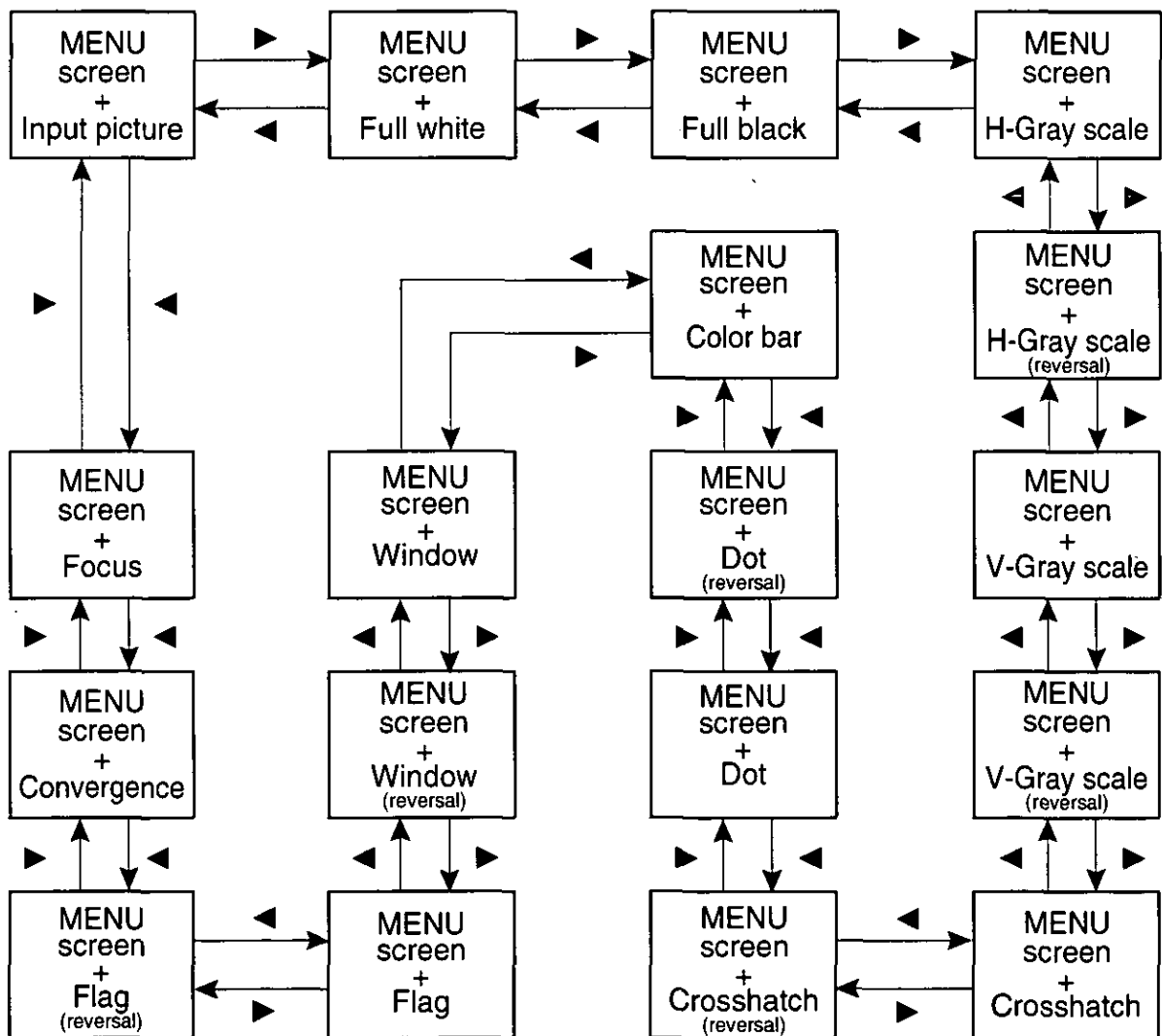

Displaying the projector settings

Display procedure

```

MENU
AUTO SETUP
LENS
PICTURE
POSITION
OPTION
SIGNAL LIST
TEST PATTERN

MENU : ▲▼
SUB MENU : ENTER
EXIT : MENU
    
```

- ① Press the MENU button. ... The MENU screen will be displayed.
- ② Press the UP (▲) and DOWN (▼) arrow buttons to select OPTION.

```

OPTION
ID : 00
SETTING : *****
LAMP RUNTIME
  NORMAL : nnnnnh
  HIGH : nnnnnh
  REMAIN : nnnnnh
SET RUNTIME : nnnnnh
LAMP POWER : *****
RS-232C SETTING
SYSTEM INFORMATION
VIDEO MODULE SETTING
PASSWORD

MENU : ▲▼
SUB MENU : ENTER
EXIT : MENU
    
```

- ③ Press the ENTER button. ... The OPTION screen will be displayed.
- ④ Press the UP (▲) and DOWN (▼) arrow buttons to select SYSTEM INFORMATION.

```

SYSTEM INFORMATION
ROM Ver. : n.nn
SETTING : *****
LAMP RUNTIME
  NORMAL : nnnnnh
  HIGH : nnnnnh
  REMAIN : nnnnnh
SET RUNTIME : nnnnnh

INPUT1 : *****
INPUT2 : *****
INPUT3 : *****

Number of
ENTRY SIGNAL nn/64

EXIT : MENU
    
```

- ⑤ Press the ENTER button. ... The SYSTEM INFORMATION screen will be displayed.

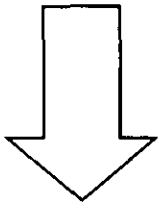

```

SYSTEM INFORMATION
ROM Ver. 2.00
SETTING : FRONT-F
LAMP RUNTIME
  NORMAL: 120h
  HIGH: 0h
  REMAIN: 1380h
SET RUNTIME: 120h

INPUT1 : ** -MD95SD1:SS
INPUT2 : ** -MD95VM2:AW
INPUT3 : <NONE>

Number of
ENTRY SIGNAL 10/64

EXIT : MENU
    
```

- Firmware version number
- Projection method setting
- Cumulative lamp usage time (normal mode)
- Cumulative lamp usage time (HIGH mode)
- Remaining lamp operating time (calculated in normal mode)
- Cumulative projector running time
- Data for module in slot 1 (INPUT 1)
- Data for module in slot 2 (INPUT 2)
- Data for module in slot 3 (INPUT 3)
- Number of signals registered

Setting and specifying ID numbers

This projector is provided with an ID number function, so that if multiple projectors are being used together, the projectors can be controlled all at once or separately using a single remote control unit. Because the factory pre-setting of the ID number is ALL, using only one projector do not require this setting.

Setting ID numbers

Setting procedure

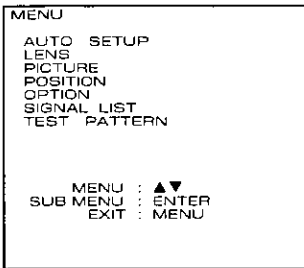

- ① Press the MENU button. ... The MENU screen will be displayed.
- ② Press the UP(▲) and DOWN(▼) arrow buttons to select OPTION.

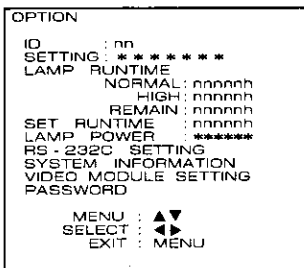

- ③ Press the ENTER button. ... The OPTION screen will be displayed.
- ④ Press the LEFT(◀) and RIGHT(▶) arrow buttons to change the value. (ALL, 1, 2, ..., 64)
- ⑤ Press the MENU button twice. ... This completes the setting.
 - The setting is complete. At that time, the on-screen display will disappear and the screen will return to the normal state.

- NOTE**
- The ID numbers can be set to ALL or to a number from 1 to 64.
 - The ID number is set to ALL at the time of shipment from the factory.
 - When setting ID numbers, the ID number of the remote control unit must match the ID number of the projector.
 - All projectors which have had their ID numbers set to ALL will operate regardless of which number is specified when using the remote control unit or a personal computer to control the projectors. If the projector is connected to other projectors and its ID number is set to ALL, it will not be possible to control the projector separately from other projectors with different ID number settings.

Setting remote control unit ID numbers

When an ID number has been assigned for a projector, you then need to assign the same ID number as the projectors to be controlled to the remote control unit which is to be used to operate these projectors, otherwise the remote control unit cannot be used.

Because the factory pre-setting of the projector ID number is ALL, using only one projector requires the use of the ID ALL button on the remote control unit for this setting.

Setting method

Within 5 seconds of pressing the ID SELECT button, use the NEXT button to set the tens digit of the ID number which has been assigned to the projector, and then use the numeric buttons (0 to 9) to set the units digit.

However, if the ID ALL button is pressed, the remote control unit will operate the projector regardless of which ID number has been assigned to the projector.

- If the NEXT button or a numeric button is not pressed within 5 seconds of pressing the ID SELECT button, the ID number will return to the setting prior to when the ID SELECT button was pressed.
- Setting an ID number for the remote control unit can be carried out without needing the projector, so be careful not to press the ID SELECT button inadvertently.
- Once an ID number has been assigned to the remote control unit, that ID number will be stored in the remote control unit until it is again changed. However, if the remote control unit is left with flat batteries inside it, the ID number setting will be cleared. When the batteries are replaced, re-assign the same ID number to the remote control unit.

If you do not know the ID number assigned to the projector

If you do not know what ID number has been assigned to the projector, turn on the projector so that it is operating, and then press the ID SELECT button. The ID number will then be displayed on the screen as shown at right.



ID : 1
CONTROLLER ID : ?

The ID number for the projector can be set to ALL or to a number from 1 to 64.

Using the RS-232C connectors

The projector is equipped with a D-SUB 9-pin RS-232C input connector and RS-232C output connector which allow the projector to be controlled externally. These connectors conform to RS-232C specifications, and can be used by a computer which conforms to either RS-232 or RS-232C specifications.

- Set the communication parameters below according to a computer to be connected. To connect the computer, use a straight cable and connect it to the RS-232C IN connector.

- Communication parameters

- Baud rate (bps) : 1 200/2 400/4 800/9 600/19 200/38 400
 - Parity : ODD/EVEN/NONE
 - VPS system : MASTER/SLAVE
 - Start & stop bits : 1 bit (fixed)
 - Character length : 8 bit (fixed)
 - X parameter/S parameter : None
 - Synchronization : Start-stop asynchronous
- MASTER: Returns a command in response to ID ALL.
SLAVE: Returns no command in response to ID ALL.

- BAUD RATE, PARITY, and VPS SYSTEM are reconfigurable parameters (see the next page):

Commands

Receive (PC → DLP™ based projector) :

STX(02h)	ID NO(1byte)	Command(1 to 3bytes)	ETX(03h)
----------	--------------	----------------------	----------

Send (PC ← DLP™ based projector) :

STX(02h)	ID NO(1byte)	Command(1 to 3bytes)	ETX(03h)
----------	--------------	----------------------	----------

- The following command is returned in case of error:

STX(02h)	ID NO(1byte)	ERR(FFh)	ETX(03h)
----------	--------------	----------	----------

- For ID NOs, see the following ID list.
- For the details of commands, see the Command List (page 65).
- Up to 3 commands can be transmitted.
- All commands are binary commands.

ID List

ID	Code specified	ID	Code specified	ID	Code specified	ID	Code specified	ID	Code specified	ID	Code specified
ALL	00h	12	0Ch	24	18h	36	24h	48	30h	60	3Ch
1	01h	13	0Dh	25	19h	37	25h	49	31h	61	3Dh
2	02h	14	0Eh	26	1Ah	38	26h	50	32h	62	3Eh
3	03h	15	0Fh	27	1Bh	39	27h	51	33h	63	3Fh
4	04h	16	10h	28	1Ch	40	28h	52	34h	64	40h
5	05h	17	11h	29	1Dh	41	29h	53	35h		
6	06h	18	12h	30	1Eh	42	2Ah	54	36h		
7	07h	19	13h	31	1Fh	43	2Bh	55	37h		
8	08h	20	14h	32	20h	44	2Ch	56	38h		
9	09h	21	15h	33	21h	45	2Dh	57	39h		
10	0Ah	22	16h	34	22h	46	2Eh	58	3Ah		
11	0Bh	23	17h	35	23h	47	2Fh	59	3Bh		

Example: Send a RGB command to the DLP™ based projector with ID1.

Receive (PC → DLP™ based projector) :

STX(02h)	ID NO (01h)	RGB(06h)	ETX(03h)
----------	-------------	----------	----------

Send (PC ← DLP™ based projector) :

STX(02h)	ID NO (01h)	RGB(06h)	ETX(03h)
----------	-------------	----------	----------

- Send a PICTURE MUTE command to all the DLP™ based projectors.

Receive (PC → DLP™ based projector) :

STX(02h)	ID NO (00h)	PICTURE MUTE(91h)	ETX(03h)
----------	-------------	-------------------	----------

Send (PC ← DLP™ based projector) :

STX(02h)	ID NO (1byte)	PICTURE MUTE(91h)	ETX(03h)
----------	---------------	-------------------	----------

- The ID No. is that of the DLP™ based projector whose VPS SYSTEM is set up for MASTER.

Using the RS-232C connectors (continued)

RS-232C settings

Setting procedure

```

MENU
AUTO SETUP
LENS
PICTURE
POSITION
OPTION
SIGNAL LIST
TEST PATTERN

MENU : ▲▼
SUB MENU : ENTER
EXIT : MENU
    
```

- ① Press the MENU button. ... The MENU screen will be displayed.
- ② Press the UP (▲) and DOWN (▼) arrow buttons to select OPTION.

```

OPTION
ID : nn
SETTING : *****
LAMP RUNTIME : *****
NORMAL : nnnnnh
HIGH : nnnnnh
REMAIN : nnnnnh
SET RUNTIME : nnnnnh
LAMP POWER : *****
RS-232C SETTING
SYSTEM INFORMATION
VIDEO MODULE SETTING
PASSWORD

MENU : ▲▼
SELECT : ◀▶
EXIT : MENU
    
```

- ③ Press the ENTER button. ... The OPTION screen will be displayed.
- ④ Press the UP (▲) and DOWN (▼) arrow buttons to select RS-232C SETTING.

```

RS-232C SETTING
BAUD RATE : 9600bps
PARITY : EVEN

VPS SYSTEM : SLAVE

MENU : ▲▼
SELECT : ◀▶
EXIT : MENU
    
```

- ⑤ Press the ENTER button. ... The RS-232C SETTING screen will be displayed.
- ⑥ Press the UP (▲) and DOWN (▼) arrow buttons to select the communication parameter.
- ⑦ Press the LEFT (◀) and RIGHT (▶) arrow buttons to change the setting.
- ⑧ Press the MENU button three times.
 - The on-screen display will disappear and the screen will return to the normal state.

- The basic commands for external control using RS-232C are given on the following next page.
- Pin specifications of RS-232C connector**

●RS-232C IN

Pin No.	Name	Functions
1	T R I	unassigned
2	R D	data transmission
3	S D	data reception
4	N C	N C
5	F G	G N D
6	T R O	unassigned
7	R S	demand for transmission
8	C S	acceptance transmission
9	N C	N C

●RS-232C OUT

Pin No.	Name	Functions
1	T R O	unassigned
2	R D	data reception
3	S D	data transmission
4	N C	N C
5	F G	G N D
6	T R I	unassigned
7	C S	demand for transmission
8	R S	acceptance transmission
9	N C	N C

Using the RS-232C connectors (continued)

List of basic control commands

CODE	Target remote control buttons	
	NAME	
06h	RGB	
0Ah	INPUT1	
0Bh	INPUT2	
0Ch	INPUT3	
0Fh	NEXT	
10h	1	
11h	2	
12h	3	
13h	4	
14h	5	
15h	6	
16h	7	
17h	8	
18h	9	
19h	0	
35h	BRIGHT	
36h	CONTRAST	
3Bh	STD	
3Dh	POWER	
3Eh	POWER ON *2	
3Fh	POWER OFF *2	
40h	TEST *1	
58h	+	
59h	-	
5Ah	▲	
5Bh	▼	
5Ch	◀	
5Dh	▶	
62h	ON SCREEN	
6Bh	ID ALL *1	
6Ch	ID SELECT *1	
6dh	INPUT *2	
70h	SYSTEM SELECTOR	
72h	ENTER	
7Ah	MENU	
7Ch	LENS	
91h	PICTURE MUTE	

NOTE

*1: This command is for the supplied remote control. therefore would have no effect when sent from RS-232C.

*2: Not available for the remote control unit.

Replacing the lamp unit



DANGER



Some dangers are associated with the replacing of the lamp. If lamp replacement becomes necessary, have the lamp unit replaced by a qualified service person, experienced in working with Xenon lamps.

Notes on handling the lamp unit

- The lamp unit is sold separately and consult a Panasonic authorized dealer or service center.

Part No. : ET-LAD9500

Lamp unit replacement period

The lamp unit for the projector should be replaced after approximately 1 500 hours of use (recommendable replacement time: 1 000 hours) in the normal usage mode. The operating life of the lamp also depends on the number of times it is turned on and off. Turning on and off the lamp at frequent intervals will decrease its operating life.

The projector has an automatic shut-off function that automatically stops the light emission of the lamp once its total usage time exceeds 1 500 hours to prevent any accidents caused by the end of its life. And the on-screen displays below appear according to its usage time.

- Warning display between 1 300 and 1 450 hours of use
The lamp usage time will be displayed in yellow at the bottom-left of the screen.
(This display will disappear if any of the buttons on the remote control unit or projector are pressed.)
- Warning display between 1 450 and 1 500 hours of use
The lamp usage time will be displayed in red at the bottom-left of the screen for one minute. After this, it will repeatedly turn off for 30 minutes and then be displayed again for one minute.
(This repeating display will be cancelled if any of the buttons on the remote control unit or projector are pressed.)
- Warning display after 1 500 hours of use
A warning message to urge the replacement of the lamp will be displayed in red at the bottom left of the screen for 10 minutes. After that, the automatic shut-off function will set the projector to the standby mode.

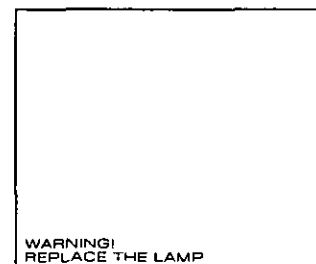
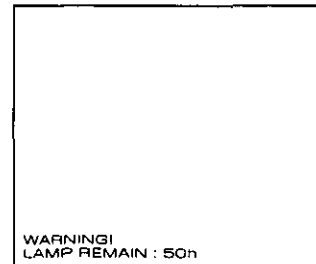
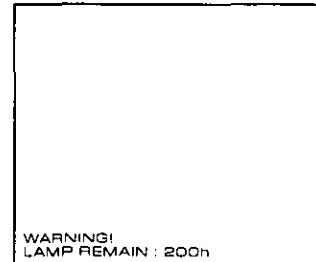

- NOTE** • The lamp used in the light source module has a nominal operating lifetime of 1 500 hours. However, the lifetime may expire before 1 500 hours depending on individual lamp characteristics or operating conditions (how often it is switched off or on and how long the intervals are). It is recommended that you prepare a spare lamp.

Before asking for service, check the following points.

Symptom	Check the following	Symptom	Check the following
Power does not turn on.	<ul style="list-style-type: none"> • Is the power turned on at the power point? • Is the power cord disconnected from the power point? • Is the MAIN POWER switch turned to OFF? • Is the REMOTE IN 1 connector being used for external control? • Is the ID number setting correct? 	The contrast and brightness of the picture cannot be adjusted.	<ul style="list-style-type: none"> • Is the REMOTE IN 1 connector being used for external control?
		On-screen displays do not appear.	<ul style="list-style-type: none"> • Has the ON SCREEN button been pressed to turn off the displays?
No picture appears.	<ul style="list-style-type: none"> • Is the picture transmission cable disconnected? • Is the signal source connected to the projector operating normally? • Has the picture mute function been turned on? • Does the video signal format match the input signal format? • Is Y/C signal selected for composite input, or vice versa? 	The remote control unit does not work.	<ul style="list-style-type: none"> • Have the batteries been inserted with the correct polarity? • Is something obstructing the path between the remote control unit and the remote control signal receptor of the projector? • Is the remote control being used outside the effective range? • Is the REMOTE IN 1 connector being used for external control? • Is a remote control cable being connected to the REMOTE IN 2 connector ? (in the wireless mode)
			<ul style="list-style-type: none"> • Has the input source been changed to a new type of signal which is not registered? • Does the video signal format match the input signal format?
Color is misaligned when special signals are input.	<ul style="list-style-type: none"> • Has the input source been changed to a new type of signal which is not registered? • Does the video signal format match the input signal format? 		

NOTE

•Explanation about the DMD™ devices

The DMD™ devices are produced using high-precision technology (Three sheets of approximately 780,000 pixels(for PT-D9500U)/1,310,000 pixels(for PT-D9600U) are used for the projector.), but there might be extremely small chipped or brighter points of the picture on the screen.

Specifications

Power Supply	200 V – 240 V AC (single-phase, 3-wire), 14 A (Max.)
Power Consumption	2.3 kW Approx. 2.8 W during standby (when cooling fan is stopped)
Operating environment temperature	0 °C – 40 °C : NORMAL lamp power 0 °C – 35 °C : HIGH lamp power If the power is turned on when the temperature is around 0 °C, a warming-up time of about two minutes will be required before a picture can be projected.
Storage environment	Temperature: –25 °C – 65 °C Humidity: 10 % – 80 % (with no condensation)
DMD™ elements	Element size: 0.9 inches (aspect ratio ; 4:3) : PT-D9500U : 1.1 inches (aspect ratio ; 5:4) : PT-D9600U Display method: 3 DMD™ elements, DLP™ system Pixels: 1 024 dots × 768 lines, (3 sheets) : PT-D9500U : 1 280 dots × 1 024 lines, (3 sheets) : PT-D9600U
Lamp	1 600 W Xenon lamp (recommended replacement period 1 000 hours)
Luminosity	9 000 lm (ANSI) : LAMP POWER NORMAL } PT-D9500U 10 000 lm (ANSI) : LAMP POWER HIGH } 10 000 lm (ANSI) : LAMP POWER NORMAL } PT-D9600U 12 000 lm (ANSI) : LAMP POWER HIGH }
Projection method	Ceiling or Floor/Front or Rear (menu selectable)
Keystone compensation	Max. elevation angle : ±10 ° or less
Optical axis shift volume	Top and bottom : 10/0 – 0/10 (electromotion) Left and right : fine-tune(PT-D9500U) Top and bottom : 10/0 – 2/8 (electromotion) Left and right : fine-tune(PT-D9600U)
Projection screen size	Between 100"(2.5 m) and 600"(15 m) when separate zoom lens is fitted } PT-D9500U Between 100"(2.5 m) and 500"(12.5 m) when separate fixed focus lens is fitted } Between 100"(2.5 m) and 600"(15 m) when separate zoom lens is fitted } PT-D9600U Between 100"(2.5 m) and 200"(5.0 m) when separate fixed focus lens is fitted }
Screen aspect ratio	4:3 when separate zoom lens or fixed focus lens is fitted (PT-D9500U) 5:4 when separate zoom lens or fixed focus lens is fitted (PT-D9600U)
Input signals	Standard analog RGB input BNC termination × 5 Video signal input block Impedance : 75 Ω Sync signal input block Impedance : 75 Ω R/P _R /C _r 0.7 V [p-p] G/Y 0.7 V [p-p] (1.0 V [p-p] when SYNC ON G/Y signal is input) B/P _B /C _b 0.7 V [p-p] Composite sync 0.6 V [p-p] – 4.0 V [p-p] Separate sync 0.6 V [p-p] – 4.0 V [p-p] Analog RGB input signal f _H : 15 kHz–100 kHz, f _V : 24 Hz–120 Hz, dot clock frequency: 20 MHz–162 MHz Color difference input signal Applicable formats: 480i, 576i, 480p, 720/60p, 1080/60i(1035/60i) 1080/50i, 1080/30p, 1080/25p, 1080/24p, 1080/24sF ----- With ET-MD95VM2 video signal (NTSC, NTSC4.43, PAL, SECAM, PAL-M, PAL60, PAL-N) input module (sold separately) installed Video signal 1.0 V [p-p] Impedance: 75 Ω BNC termination Y signal 1.0 V [p-p] Impedance: 75 Ω BNC termination C signal 0.286 V [p-p] Impedance: 75 Ω BNC termination C _b signal 0.7 V [p-p] Impedance: 75 Ω BNC termination C _r signal 0.7 V [p-p] Impedance: 75 Ω BNC termination

Input signals	With serial digital input module (sold separately) installed ET-MD95SD1 (for 480i/576i) SERIAL IN (SMPTE259M) BNC termination SERIAL OUT (SMPTE259M) BNC termination ET-MD95SD2 (for 480p/480i/576i) SERIAL MAIN IN/SUB IN (SMPTE259M/294M) BNC termination SERIAL MAIN OUT/SUB OUT (SMPTE259M/294M) BNC termination ET-MD95SD3 (for HD SDI) HD-SERIAL IN (SMPTE292M) BNC termination HD-SERIAL OUT (SMPTE292M) BNC termination
	With ET-MD95T TMDs input module (sold separately) installed MDR26 connector Applicable signals SVGA, XGA, SXGA
Contrast ratio	450:1 (100% black-and-white pattern) : PT-D9500U 550:1 (100% black-and-white pattern) : PT-D9600U
Connection terminals	3 input module connection slots Analog RGB input BNC termination × 5 RS-232C input/output connectors D-SUB 9-pin × 2 for computer control REMOTE IN 1 connector D-SUB 9-pin for external control REMOTE 2 IN/OUT terminals M3 pin jack × 2 For wired remote control unit and serial control
Power cord length	2.5 m (8.2')
Cabinet	Aluminium, PPE plastic (denatured)
Weight	96 kg (211.2 lb) (not including separate projection lens)
Dimensions	68 cm/26.77" (W) × 39 cm/15.35" (H) [including legs] × 97.3 cm/38.3" (D)
(Remote control unit) Number of functions Power supply Operating range Weight Dimensions	34 (including lighting function) 3 V DC (AA batteries × 4) Within approx. 12 m / 39.3' directly in front of receptor (when operated as wireless unit) Within 15 m / 49.2' (when operated as wired unit) Approx. 350 g / 0.77 lb (including batteries) 14.0 cm / 5.5" (W) × 3.6 cm / 1.4" (H) × 18.1 cm / 7.1" (L)

Accessories

- Remote control unit 1
- AA-size batteries 4
- Remote control cable (15 m / 49.2') 1
- Remote control unit strap 1

Sold separately

Select from the range available in accordance with the setting-up location and system requirements.

	NAME	MODEL NO.	Applicable model
Projection lenses	Zoom lens 1.5 – 2.5 : 1	ET - D95LE1	Dedicated to the PT-D9500U
	Zoom lens 2.5 – 4.0 : 1	ET - D95LE2	
	Zoom lens 4.0 – 7.0 : 1	ET - D95LE3	
	Fixed focal lens 1.05 : 1	ET - D95LE4	
	Zoom lens 1.5 – 2.0 : 1	ET - D95LE5	Dedicated to the PT-D9600U
	Zoom lens 2.0 – 2.5 : 1	ET - D95LE6	
	Zoom lens 2.5 – 4.0 : 1	ET - D95LE7	
	Zoom lens 4.0 – 7.0 : 1	ET - D95LE8	
	Fixed focal lens 0.8 : 1	ET - D95LE9	
Modules	Video signal input module (NTSC, PAL, SECAM, NTSC4.43, PAL-M, PAL60, PAL-N)	ET - MD95VM2	Shared with the PT-D9500U and PT-D9600U
	Serial digital input module (480i/576i)	ET - MD95SD1	
	Serial digital input module (480p/480i/576i)	ET - MD95SD2	
	HD-Serial digital input module	ET - MD95SD3	
	TMDS input module	ET - MD95T	
Other	Replacement lamp unit	ET - LAD9500	
	Ceiling mount bracket	ET - PKD95	
	Dual stacking mount bracket	ET - DFD95	

Dimensions

UNIT : mm (inch)

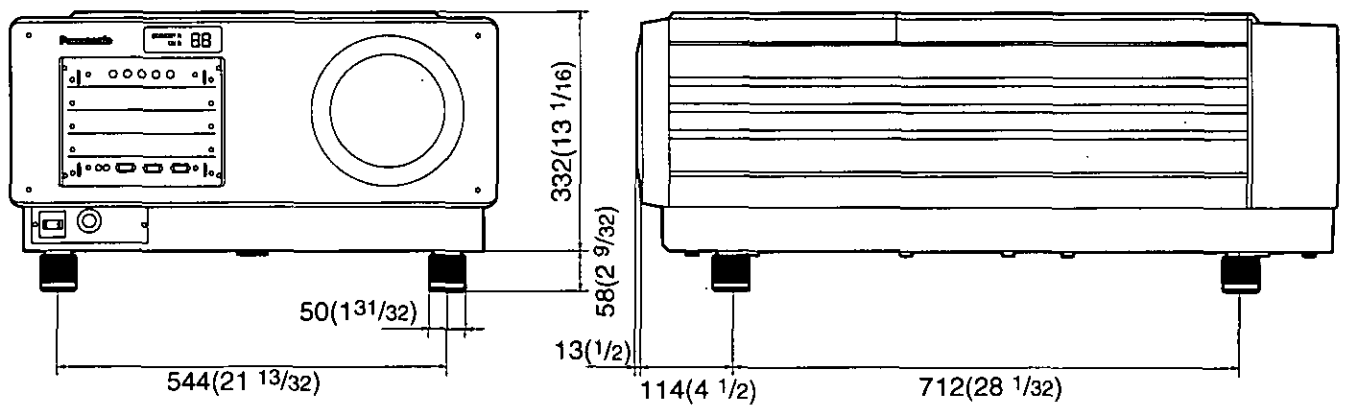
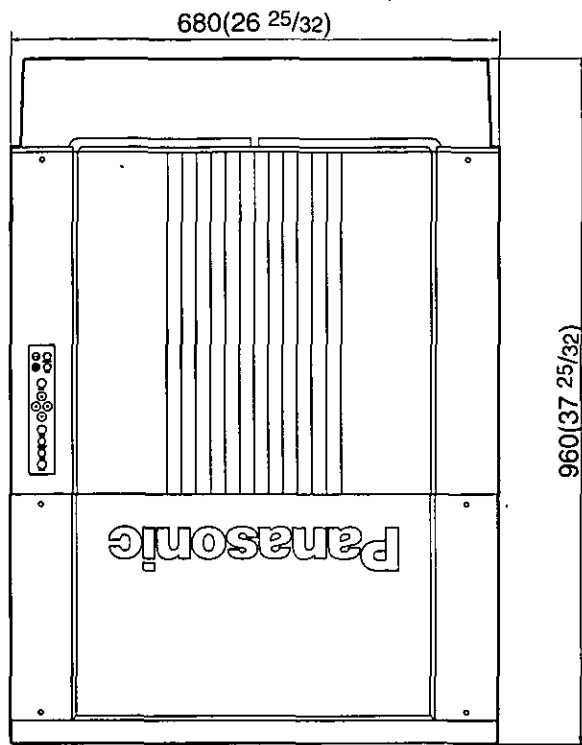

NOTES IMPORTANTES CONCERNANT LA SÉCURITÉ

AVERTISSEMENT: Afin d'éviter des dommages qui risquent de causer un incendie ou des chocs électriques, ne pas exposer cet appareil à la pluie ou à l'humidité.

Alimentation: Ce projecteur DLP a été conçu pour fonctionner seulement sur secteur domestique de 200 V – 240 V, 50 Hz / 60 Hz.



CAUTION

RISK OF ELECTRIC
SHOCK. DO NOT OPEN



AVIS: RISQUE DE CHOC ÉLECTRIQUE. NE PAS OUVRIR



Le symbole de la flèche en forme d'éclair, dans un triangle, avertit l'utilisateur de la présence de "tensions dangereuses" à l'intérieur du produit qui peuvent être de force suffisante pour constituer un risque de choc électrique aux personnes.



Le point d'exclamation dans un triangle avertit l'utilisateur de la présence d'instructions importantes concernant l'utilisation et l'entretien (réparation) dans la littérature accompagnant le produit.

ATTENTION: Cet appareil est équipé d'une fiche de à trois broches avec mise à la terre. Ne pas retirer la broche de mise à la masse de la fiche. Cette fiche ne pourra être utilisée que dans une prise avec mise à la terre. Ceci est une précaution sécuritaire. S'il est impossible d'insérer la fiche dans la prise, s'adresser à un électricien. Ne pas annuler la protection de la fiche à la terre.

Ne pas retirer

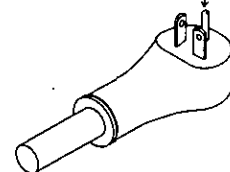

Précautions concernant la sécurité

Lire attentivement ce mode d'emploi et respecter toutes les précautions de sécurité indiquées lors de l'installation du projecteur, afin d'éviter des accidents.

AVERTISSEMENT

Installation

Confier l'installation du projecteur à un technicien qualifié seulement.

- Afin de garantir une installation sûre et précise, il faut confier ce travail à un technicien qualifié seulement.

Pour installer le projecteur, le concours d'au moins trois personnes est nécessaire.

- Ce projecteur a été fabriqué avec une grande précision, et il est très lourd. Si une seule personne tente d'installer ou de déplacer le projecteur, elle risquera de se blesser ou d'endommager le projecteur. Veiller à ce qu'au moins trois personnes soient présentes pour transporter et installer le projecteur.

Vérifier la solidité de l'emplacement d'installation.

- Ce projecteur pèse 96 kg (211,2 lb). Avec l'applique d'installation au plafond (vendue séparément), le poids total est alors de 135 kg (297 lb). Si l'emplacement d'installation n'est pas assez solide pour supporter le poids, faire les travaux de renforcement nécessaires pour garantir que l'emplacement d'installation soit absolument solide et sûr.

Éviter d'installer le projecteur aux endroits suivants:

- Endroits sujets à des vibrations ou à des chocs Vibrations et chocs risquent de causer des pannes ou des accidents.
- À proximité d'extincteurs ou de capteurs La chaleur produite par le projecteur risque d'entraîner des anomalies de fonctionnement des capteurs ou d'activer les systèmes d'extincteurs, et donc de causer des problèmes.
- À proximité de moteurs ou de lignes de courant à haute tension De telles sources d'alimentation risquent de causer des interférences.
- Endroits à conditions ambiantes défavorables Éviter d'installer l'appareil à des endroits très poussiéreux, contenant des fumées grasses ou de la vapeur, et où la température ambiante est hors des limites de la plage 0 °C – 40 °C (32 °F–104 °F), et l'humidité ambiante hors des limites de la plage 10 % – 80 %. Si le projecteur est installé à de tels endroits, ceci pourra causer des anomalies de fonctionnement, un incendie ou une électrocution.

Brancher exclusivement le projecteur à une source d'alimentation de la tension indiquée (monophasée, 3 fils, 200 V–240 V c.a.)

- Si l'on branche le projecteur à une source d'alimentation inadéquate, ceci risquera d'entraîner des anomalies de fonctionnement, un incendie ou une électrocution.

Une applique d'installation au plafond (vendue séparément) est nécessaire pour réaliser l'installation au plafond.

- Si l'on suspend le projecteur à un plafond, il faut acheter et utiliser l'applique d'installation au plafond spéciale (ET-PKD95).

Utiliser des écrans en vente dans le commerce.

- Choisir un écran qui convienne à la méthode de projection utilisée et à l'endroit où on l'utilise.

Protéger l'écran de la lumière extérieure.

- Veiller à ce que l'écran ne soit illuminé que par la lumière provenant du projecteur. Si l'écran est illuminé par une source de lumière extérieure, l'image projetée aura un mauvais contraste et sera moins visible.

Laisser assez d'espace autour du projecteur pour les opérations d'entretien.

- Laisser au moins 80 cm d'espace libre tout autour du projecteur, afin qu'il y ait assez de place pour pouvoir bien effectuer les réglages et l'entretien.

Toujours bien brancher le projecteur à la terre.

- Brancher un fil de terre à la vis de mise à la terre portant la marque \perp près de l'interrupteur MAIN POWER. Brancher ensuite ce fil de terre à une borne de terre sûre située dans la salle.

Si l'on utilise le projecteur sans l'avoir branché à la terre, on risquera de s'électrocuter.

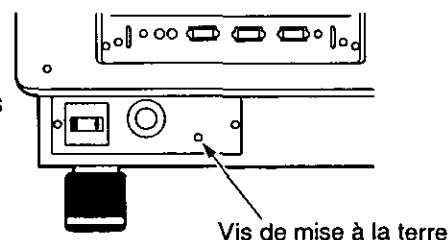

Lors de l'utilisation du projecteur

Ne pas regarder directement dans la lentille pendant que le projecteur fonctionne.

- Une lumière intense est émise par la lentille du projecteur. Si l'on regarde directement dans cette lumière, elle risquerait de blesser et d'abîmer les yeux.

Ne pas placer le projecteur sur des surfaces inclinées ou instables.

- Le projecteur risquerait de tomber ou de se renverser.

Ne pas placer d'objets sur le projecteur.

- Si de l'eau se renverse sur le projecteur ou si des corps étrangers y pénètrent, un court-circuit risquera de se produire et d'entraîner un incendie ou une électrocution. Si des corps étrangers pénètrent dans le projecteur, contacter un centre de service agréé.

Ne pas faire pénétrer d'objets étrangers dans le projecteur.

- Ne pas introduire d'objets en métal ou d'objets inflammables dans les orifices de ventilation, ou ne pas les laisser tomber sur le projecteur; ceci risquerait de causer un incendie ou une électrocution.

Ne pas boucher la sortie d'air.

- Le projecteur risquerait de surchauffer, ce qui pourrait causer un incendie ou abîmer le projecteur.

Ne pas retirer le couvercle, ni le modifier.

- Le projecteur contient des composants placés sous haute tension qui peuvent causer une électrocution grave. Confier tous les travaux de vérification, de réglage ou de réparation à un centre de service agréé.

Ne pas renverser d'eau sur le projecteur.

- Ceci risquerait de causer un incendie ou une électrocution.

Introduire la fiche du cordon d'alimentation à fond dans la prise.

- Si la fiche n'est pas introduite bien à fond, de la chaleur risquera d'être produite et de causer un incendie. Si la fiche est abîmée ou si la plaque de la prise murale est mal fixée, ne pas les utiliser..

Ne pas manipuler la fiche du cordon d'alimentation avec les mains mouillées.

- On risquerait de s'électrocuter.

Ne rien faire qui puisse endommager le câble d'alimentation.

- Ne pas endommager le câble, le modifier, placer d'objets lourds sur le câble, le chauffer, le placer à proximité d'objets chauds, le torsader, le plier excessivement ou le tirer. Ceci risquerait de causer un incendie ou une électrocution. Si le câble est abîmé, le faire réparer par un centre de service agréé.

Nettoyer régulièrement le câble d'alimentation afin que de la poussière ne s'y accumule pas.

- Si de la poussière s'accumule sur le cordon d'alimentation, l'humidité ainsi créée pourrait abîmer l'isolant et entraîner un incendie. Débrancher le cordon d'alimentation de la prise murale et l'essuyer avec un chiffon sec.
- Si l'on n'utilise pas le projecteur pendant une longue période, débrancher la fiche du cordon d'alimentation de la prise murale.

En cas d'anomalies de fonctionnement

Si une anomalie se produit (absence d'image par exemple), ou si de la fumée ou une odeur anormale est émise par le projecteur, débrancher immédiatement le cordon d'alimentation de la prise murale.

- Si l'on continue d'utiliser le projecteur dans cet état, on risque de causer un incendie ou une électrocution. Après s'être assuré qu'il n'y a plus d'émission de fumée, s'adresser à un centre de service agréé pour effectuer les réparations nécessaires. Ne jamais effectuer soi-même les réparations, car ceci vous exposerait à de graves dangers.

Si de l'eau ou des corps étrangers pénètrent dans le projecteur, si le projecteur tombe, ou si le coffret est abîmé, débrancher immédiatement la fiche d'alimentation.

- Un court-circuit risquerait de se produire et de causer un incendie. Pour toute réparation, s'adresser à un centre de service agréé.

Précautions à suivre lors de la manipulation

PRÉCAUTION

Installation

Toujours respecter les points suivants lors de l'installation du projecteur.

Une alimentation électrique spécialisée doit être utilisée.

- Demander à son revendeur d'effectuer les travaux d'électricité qui peuvent être nécessaires pour fournir une alimentation électrique de 14 A, 200 V – 240 V c.a. (monophasée) pour l'utilisation du projecteur exclusivement.

Éviter l'installation dans des endroits sujets à des vibrations ou chocs.

- Si le projecteur est installé dans des endroits sujets à fortes vibrations, comme près d'un moteur, ou s'il est installé à l'intérieur d'un véhicule ou sur un bateau, le projecteur peut être soumis à des vibrations ou chocs qui peuvent endommager les composantes internes et causer un mauvais fonctionnement ou des accidents. Installer donc le projecteur dans un endroit qui n'est pas sujet à des vibrations ou chocs.

Ne pas installer le projecteur près de lignes à haute-tension ou près de moteurs.

- Le projecteur peut être affecté par des interférences électriques s'il est installé près de lignes à haute-tension ou près de moteurs.

La distance de projection varie selon la lentille de projection (vendue séparément) que l'on utilise.

- Choisir une lentille de projection qui convienne à la grandeur de l'espace de l'emplacement d'installation.

Si l'on veut installer le projecteur au plafond, demander à un technicien qualifié de faire l'installation.

- Si l'on suspend le projecteur au plafond, il faut se procurer l'applique d'installation au plafond qui est vendue séparément. Veiller aussi à confier les travaux à un technicien qualifié.

Ne pas déplacer le projecteur après l'avoir installé et réglé.

- Après avoir fini d'installer et de régler le projecteur, ne pas changer la distance entre le projecteur et l'écran, et ne pas changer la position du projecteur, sinon l'équilibre des couleurs sera affecté et il faudra refaire le réglage. Faire particulièrement attention à ceci lorsqu'on installe le projecteur sur le sol.

Laisser assez d'espace autour du projecteur pour les travaux d'entretien.

- Laisser au moins 80 cm (2,6 pieds) d'espace libre tout autour du projecteur, afin qu'il y ait assez de place pour pouvoir bien effectuer les réglages et l'entretien.

Remarques concernant l'utilisation

Afin d'obtenir la meilleure qualité possible d'image

- Si la lumière du jour ou la lumière intérieure éclaire l'écran, les images projetées n'auront pas le contraste adéquat. Fermer les rideaux ou les volets des fenêtres, éteindre les éclairages fluorescents près de l'écran et couvrir tout plancher ou mur à haute réflexion de tapis ou papier peint pour éviter la réflexion.

Ne pas toucher la surface de la lentille avec les mains nues.

- Ne pas toucher la lentille avec les mains nues. Si la surface de la lentille porte des traces de doigts ou autres, ces traces seront agrandies et projetées sur l'écran.

À propos de l'écran

- Si l'écran utilisé est sale, endommagé ou décoloré, de belles images ne peuvent pas être obtenues. Ne pas appliquer de produit chimique volatil sur l'écran et ne pas le laisser se salir ou s'endommager.

Nettoyage et entretien

Avant d'entreprendre les travaux de nettoyage et d'entretien, toujours débrancher la fiche d'alimentation de la prise de courant par mesure de sécurité.

Essuyer le boîtier avec un chiffon doux et sec.

- Si le boîtier est particulièrement sale, tremper le chiffon dans de l'eau avec une petite quantité de détergent neutre, bien essorer le chiffon, puis essuyer le boîtier. Lors de l'utilisation d'un chiffon traité chimiquement, lire les instructions accompagnant le chiffon avant l'utilisation.

Ne pas essuyer les lentilles avec un chiffon poussiéreux ou qui produit de la peluche.

- Si de la poussière ou de la peluche se dépose sur la lentille, cette poussière ou peluche sera grossie et projetée sur l'écran. Utiliser un aspirateur pour retirer toute poussière ou peluche des surfaces des lentilles, ou utiliser un chiffon doux et propre pour éliminer la poussière ou la peluche.

En essuyant la surface de la lentille, veiller à n'essuyer que dans une seule direction. Si l'on déplace le chiffon sur la surface de la lentille dans plusieurs directions, on risquera d'incruster la poussière dans la surface de la lentille au lieu de l'éliminer.

Remplacement du module-lampe



Le remplacement de la lampe présente certains dangers. Confiez le remplacement du module-lampe à un technicien qualifié ayant l'expérience des lampes au xénon.

Remarques concernant la manipulation du module-lampe

- Le module-lampe est vendu séparément, adressez-vous à un détaillant Panasonic agréé ou à un centre de service Panasonic.

Numéro de pièce: ET-LAD9500

Période de remplacement du module-lampe

La lampe du projecteur doit être remplacée toutes les 1 500 heures d'utilisation environ (intervalle de remplacement recommandé : 1 000 heures) en mode d'utilisation normale. La durée de service de la lampe dépend aussi du nombre de fois qu'on l'allume et qu'on l'éteint. Si vous allumez et éteignez la lampe très fréquemment, sa durée de service sera réduite. Le projecteur possède une fonction de mise hors tension automatique qui arrête automatiquement l'émission de lumière de la lampe une fois que sa durée d'utilisation totale dépasse 1 500 heures, afin qu'aucun accident lié à sa durée de service épuisée ne se produise. Les affichages à l'écran représentés ci-dessous apparaissent en fonction de la durée d'utilisation de la lampe.

• Affichage d'avertissement entre 1 300 et 1 450 heures d'utilisation

La durée d'utilisation de la lampe est affichée en jaune dans la partie inférieure gauche de l'écran.

(Cet affichage disparaît si l'on appuie sur toute touche de la télécommande ou du projecteur.)

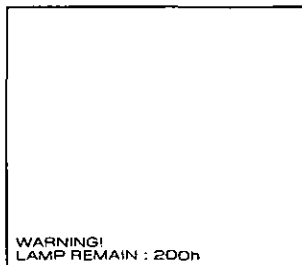

• Affichage d'avertissement entre 1 450 heures et 1 500 heures d'utilisation

La durée d'utilisation de la lampe est affichée en rouge pendant une minute dans la partie inférieure gauche de l'écran. Ensuite, celui-ci disparaîtra pendant 30 minutes puis réapparaîtra pendant 1 minute.

(Cet affichage à répétition disparaît si l'on appuie sur toute touche de la télécommande ou du projecteur.)

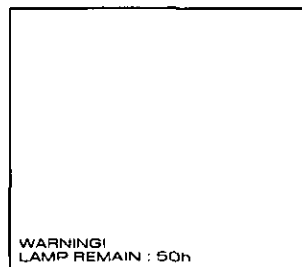

• Affichage d'avertissement après 1 500 heures d'utilisation

Un avertissement indiquant qu'il faut remplacer la lampe apparaît en rouge pendant 10 minutes dans la partie inférieure gauche de l'écran. Ensuite, le projecteur repasse automatiquement au mode d'attente.

NOTES

- La lampe utilisée dans le module de la source de lumière a une durée de vie nominale de 1 500 heures. Cependant, la durée de vie peut être plus courte que 1 500 heures en fonction des caractéristiques individuelles de la lampe ou des conditions d'utilisation (la fréquence et l'intervalle des mises hors ou sous tension). Nous vous recommandons de préparer une lampe de rechange.

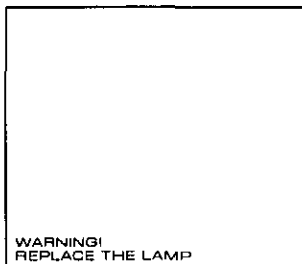

Panasonic®

Panasonic Broadcast & Digital Systems Company

Division of Matsushita Electric Corporation of America

Executive Office:

3330 Cahuenga Blvd W., Los Angeles, CA 90068 (323) 436-3500

EASTERN ZONE: One Panasonic Way 4E-7 Secaucus, NJ 07094 (201) 348-7621

Mid-Atlantic/New England : One Panasonic Way 4E-7 Secaucus, NJ 07094 (201) 348-7621

Southeast Region: 1225 Northbrook Parkway, Ste 1-160 Suwanee GA 30024 (770) 338-6835

Central Region: 1707 N Randall Road E1-C-1, Elgin, IL 60123 (847) 468-5200

WESTERN ZONE: 3330 Cahuenga Blvd W., Los Angeles, CA 90068 (323) 436-3500

Dallas Region: 6226 Abington Way, Houston, TX 77008 (713) 802-2726

No. CA/Northwest Region: 5870 Stoneridge, #3, Pleasanton, CA (925) 416-5108

Government Marketing Department: 52 West Gude Drive, Rockville, MD 20850 (301) 738-3840

Panasonic Sales Company

Division of Matsushita Electric of Puerto Rico, Inc.

San Gabriel Industrial Park, 65th Infantry Ave., K.m.9.5, Carolina, PR 00630 (787) 750-4300

Panasonic Canada Inc.

5770 Ambler Drive, Mississauga, Ontario L4W 2T3 (905) 624-5010