

myprojectorlamps.com

**The most trusted, dependable name
in projector lamp sales.**



<http://www.myprojectorlamps.com>



<http://www.myprojectorlamps.ca>



<http://www.myprojectorlamps.eu>

The following projector manual has not been modified or altered in any way.

Panasonic

LCD Projector

ENGLISH

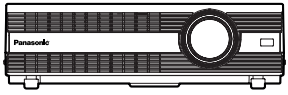

Operating Instructions

Model No. **PT-AE100E**



Before operating this product, please read the instructions carefully and save this manual for future use.

Dear Panasonic Customer:

This instruction booklet provides all the necessary operating information that you might require. We hope it will help you to get the most performance out of your new product, and that you will be pleased with your Panasonic LCD projector.

The serial number of your product may be found on its back. You should note it in the space provided below and retain this booklet in case service is required.

Model number: **PT-AE100E**

Serial number: _____

IMPORTANT SAFETY NOTICE

WARNING: THIS APPARATUS MUST BE EARTHED.

WARNING: To prevent damage which may result in fire or shock hazard, do not expose this appliance to rain or moisture.

Machine Noise Information Ordinance 3. GSGV, January 18, 1991: The sound pressure level at the operator position is equal or less than 70 dB (A) according to ISO 7779.

WARNING:

- 1) Remove the plug from the wall outlet when this unit is not in use for a prolonged period of time.
- 2) To prevent electric shock, do not remove cover. No user serviceable parts inside. Refer servicing to qualified service personnel.
- 3) Do not remove the earthing pin on the power plug. This apparatus is equipped with a three prong earthing-type power plug. This plug will only fit an earthing-type power outlet. This is a safety feature. If you are unable to insert the plug into the outlet, contact an electrician. Do not defeat the purpose of the earthing plug.

IMPORTANT: THE MOULDED PLUG (U.K. only)

FOR YOUR SAFETY, PLEASE READ THE FOLLOWING TEXT CAREFULLY.

This appliance is supplied with a moulded three pin mains plug for your safety and convenience. A 13 amp fuse is fitted in this plug. Should the fuse need to be replaced, please ensure that the replacement fuse has a rating of 13 amps and that it is approved by ASTA or BSI to BS1362.

Check for the ASTA mark  or the BSI mark  on the body of the fuse.

If the plug contains a removable fuse cover, you must ensure that it is refitted when the fuse is replaced. If you lose the fuse cover, the plug must not be used until a replacement cover is obtained. A replacement fuse cover can be purchased from an Authorised Service Centre.

If the fitted moulded plug is unsuitable for the socket outlet in your home, then the fuse should be removed and the plug cut off and disposed of safely. There is a danger of severe electrical shock if the cut off plug is inserted into any 13 amp socket.

If a new plug is to be fitted, please observe the wiring code as shown below. If in any doubt, please consult a qualified electrician.

WARNING: — THIS APPLIANCE MUST BE EARTHED.

IMPORTANT: — The wires in this mains lead are coloured in accordance with the following code: —

Green-and-Yellow:	Earth
Blue:	Neutral
Brown:	Live

As the colours of the wire in the mains lead of this appliance may not correspond with the coloured markings identifying the terminals in your plug, proceed as follows.

The wire which is coloured GREEN-AND-YELLOW must be connected to the terminal in the plug which is marked with the letter E or by the Earth symbol  or coloured GREEN or GREEN-AND-YELLOW.

The wire which is coloured BLUE must be connected to the terminal in the plug which is marked with the letter N or coloured BLACK.

The wire which is coloured BROWN must be connected to the terminal in the plug which is marked with the letter L or coloured RED.

How to replace the fuse. Open the fuse compartment with a screwdriver and replace the fuse.

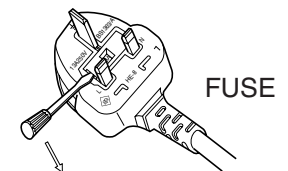

Contents

Preparation

IMPORTANT SAFETY NOTICE	2
Precautions with regard to safety	5
Accessories	9
Precautions on handling	10
Location and function of	
each part.....	12
Using the remote control unit	17
Inserting the battery.....	17
Operating range.....	17
Connections	18
Notes on connections.....	18
Example of connecting to video equipment.....	18
Example of connecting to computer.....	19
Example of connecting to equipments compatible with YPbPr(CbCr) signals.....	20
Setting-up	21
Projection methods.....	21
Projector position.....	21
Basic Operation	
Starting to use	22
Turning on the power.....	22
Turning off the power.....	23
On-screen menus	24
Menu screens.....	24
Menu operation guide.....	26
Unavailable on-screen menu items.....	26
Returning to the previous screen.....	26
Returning a setting to the factory default.....	27
Using the freeze function	27
Using the DIGITAL ZOOM function	28
Correcting keystone distortion	29
Setting the ASPECT	30
Using the index window function ...32	
Using the shutter function	33
Changing the display language	33
Muting the sound	33

Adjusting the picture	34
PICTURE MODE.....	34
COLOR.....	34
TINT.....	34
BRIGHT.....	34
CONTRAST.....	35
SHARPNESS.....	35
TV SYSTEM.....	35
Colour Hue Setting.....	35
WHITE BALANCE R/G/B.....	35
SIGNAL MODE.....	35
Adjusting the position	36
HORIZONTAL POSITION.....	36
VERTICAL POSITION.....	36
DOT CLOCK.....	36
CLOCK PHASE.....	36
ASPECT.....	36
AUTO SETUP.....	37

Advanced Operation

Option settings	37
OSD.....	37
PC PRIORITY.....	37
BACK COLOR.....	37
4:3 H-POS.....	37
FRONT/REAR.....	38
DESK/CEILING.....	38
LAMP POWER.....	38
LAMP TIME.....	38
FUNCTION.....	38

Others

Indicators	39
Cleaning and replacing the air filter	41
Replacing the lamp unit	42
Before asking for service	45
Specifications	47
Appendix	49
List of compatible signals.....	49
Connector pin wiring.....	50
Projection dimensions calculation methods.....	51
Dimensions	51
Trademark acknowledgements	52

Precautions with regard to safety

WARNING

If a problem occurs (such as no image or no sound) or if you notice smoke or a strange smell coming from the projector, turn off the power and disconnect the power cord from the wall outlet.

- Do not continue to use the projector in such cases, otherwise fire or electric shocks could result.
- Check that no more smoke is coming out, and then contact an Authorised Service Centre for repairs.
- Do not attempt to repair the projector yourself, as this can be dangerous.

Do not install this projector in a place which is not strong enough to take the full weight of the projector.

- If the installation location is not strong enough, it may fall down or tip over, and severe injury or damage could result.

Installation work (such as ceiling suspension) should only be carried out by a qualified technician.

- If installation is not carried out correctly, there is the danger that injury or electric shocks may occur.

If foreign objects or water get inside the projector, or if the projector is dropped or the cabinet is broken, turn off the power and disconnect the power cord from the wall outlet.

- Continued use of the projector in this condition may result in fire or electric shocks.
- Contact an Authorised Service Centre for repairs.

Do not cover the air inlet or the air outlet.

- Doing so may cause the projector to overheat, which can cause fire or damage to the projector.

Do not overload the wall outlet.

- If the power supply is overloaded (for example, by using too many adapters), overheating may occur and fire may result.

Do not remove the cover or modify it in any way.

- High voltages which can cause fire or electric shocks are present inside the projector.
- For any inspection, adjustment and repair work, please contact an Authorised Service Centre.

Clean the power cord plug regularly to prevent it from becoming covered in dust.

- If dust builds up on the power cord plug, the resulting humidity can damage the insulation, which could result in fire. Pull the power cord out from the wall outlet and wipe it with a dry cloth.
- If not using the projector for an extended period of time, pull the power cord plug out from the wall outlet.

Do not do anything that might damage the power cord or the power cord plug.

- Do not damage the power cord, make any modifications to it, place it near any hot objects, bend it excessively, twist it, pull it, place heavy objects on top of it or wrap it into a bundle.
- If the power cord is used while damaged, electric shocks, short-circuits or fire may result.
- Ask an Authorised Service Centre to carry out any repairs to the power cord that might be necessary.

Do not handle the power cord plug with wet hands.

- Failure to observe this may result in electric shocks.

Insert the power cord plug securely into the wall outlet.

- If the plug is not inserted correctly, electric shocks or overheating could result.
- Do not use plugs which are damaged or wall outlets which are coming loose from the wall.

Do not place the projector on top of surfaces which are unstable.

- If the projector is placed on top of a surface which is sloped or unstable, it may fall down or tip over, and injury or damage could result.

Do not place the projector into water or let it become wet.

- Failure to observe this may result in fire or electric shocks.

Do not place liquid containers on top of the projector.

- If water spills onto the projector or gets inside it, fire or electric shocks could result.
- If any water gets inside the projector, contact an Authorised Service Centre.

Do not insert any foreign objects into the projector.

- Do not insert any metal objects or flammable objects into the projector or drop them onto the projector, as doing so can result in fire or electric shocks.

After removing the battery from the remote control unit, keep the battery out of the reach of small children and infants.

- The battery can cause death by suffocation if swallowed.
- If the battery is swallowed, seek medical advice straight away.

Do not allow the + and - terminals of the battery to come into contact with metallic objects such as necklaces or hairpins.

- Failure to observe this may cause the battery to leak, overheat, explode or catch fire.
- Store the battery in a plastic bag and keep it away from metallic objects.

Insulate the battery using tape or similar before disposal.

- If the battery comes into contact with metallic objects or other batteries, it may catch fire or explode.

During a thunderstorm, do not touch the projector or the cable.

- Electric shocks can result.

Do not use the projector in a bath or shower.

- Fire or electric shocks can result.

Do not look into the lens while the projector is being used.

- Strong light is emitted from the projector's lens. If you look directly into this light, it can hurt and damage your eyes.

Do not bring your hands or other objects close to the air outlet port.

- Heated air comes out of the air outlet port. Do not bring your hands or face, or objects which cannot withstand heat close to this port, otherwise burns or damage could result.

Replacement of the lamp unit should only be carried out by a qualified technician.

- The lamp unit has high internal pressure. It can easily become damaged if struck against hard objects or dropped, and injury or malfunctions may result.

When replacing the lamp, allow it to cool for at least one hour before handling it.

- The lamp cover gets very hot, and contact with it can cause burns.

Before replacing the lamp, be sure to unplug the power cord from the power outlet.

- Electric shocks or explosions can result if this is not done.

Caution

Do not set up the projector in humid or dusty places or in places where the projector may come into contact with smoke or steam.

- Using the projector under such conditions may result in fire or electric shocks.

When disconnecting the power cord, hold the plug, not the cord.

- If the power cord itself is pulled, the cord will become damaged, and fire, short-circuits or serious electric shocks may result.

Always disconnect all cables before moving the projector.

- Moving the projector with cables still attached can damage the cables, which could cause fire or electric shocks to occur.

Do not place any heavy objects on top of the projector.

- Failure to observe this may cause the projector to become unbalanced and fall, which could result in damage or injury.

Do not short-circuit, heat or disassemble the battery or place it into water or fire.

- Failure to observe this may cause the battery to overheat, leak, explode or catch fire, and burns or other injury may result.

When inserting the battery, make sure the polarities (+ and -) are correct.

- If the battery is inserted incorrectly, it may explode or leak, and fire, injury or contamination of the battery compartment and surrounding area may result.

Use only the specified battery.

- If an incorrect battery is used, it may explode or leak, and fire, injury or contamination of the battery compartment and surrounding area may result.

Do not put your weight on this projector.

- You could fall or the projector could break, and injury may result.
- Be especially careful not to let young children climb onto the equipment.

Disconnect the power cord plug from the wall outlet as a safety precaution before carrying out any cleaning.

- Electric shocks can result if this is not done.



Ask an Authorised Service Centre to clean inside the projector at least once a year.

- If dust is left to build up inside the projector without being cleaned out, it can result in fire or problems with operation.
- It is a good idea to clean the inside of the projector before the season for humid weather arrives. Ask your nearest Authorised Service Centre to clean the projector when required. Please discuss with the Authorised Service Centre regarding cleaning costs.

We are in effort to hold your environment clean. Please bring the non repairable unit your Dealer or a Recycling Company.

Accessories

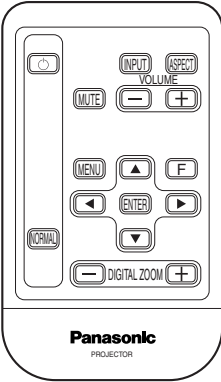
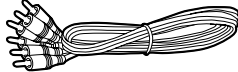
Check that all of the accessories shown below have been included with your projector.

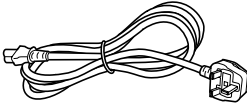
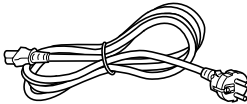
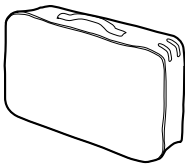
<p>Remote control unit (N2QADC000003 x1)</p> 	<p>Video/Audio cable [3.0 m (9'10"), K2KA2FA00001 x1]</p> 	<p>Lithium battery for remote control unit (CR2025 x1)</p> 
	<p>Power cord for U.K. (K2CT3FR00001 x1)</p> 	<p>Power cord for Continental (K2CM3FR00001 x1)</p> 
<p>Carrying bag (TPEP004 x1)</p> 		

Precautions on handling

Cautions regarding transportation

Be sure to attach the lens cover before transporting the projector.

The projection lens is extremely susceptible to vibration and shocks. When carrying the projector, use the accessory carrying bag.

When placing the projector inside the carrying bag, position it so that the lens is facing upward.

Cautions regarding setting-up

Observe the following at all times when setting up the projector.

Avoid setting up in places which are subject to vibration or shocks.

If the projector is set up in locations with strong vibration, such as near a motor, or if it is installed inside a vehicle or on board a ship, the projector may be subjected to vibration or shocks which can damage the internal parts and cause malfunctions or accidents. Accordingly, set up the projector in a place which is free from such vibrations and shocks.

Do not set up the projector near high-voltage power lines or near motors.

The projector may be subject to electromagnetic interference if it is set up near high-voltage power lines or motors.

If installing the projector to the ceiling, ask a qualified technician to carry out all installation work.

If the projector is to be suspended from the ceiling, you will need to purchase the separate installation kit (Model No.: ET-PKE100). Furthermore, all installation work should only be carried out by a qualified technician.

If using of this projector at high elevations (above 1400 m), consult your dealer or Authorised Service Centre.

Special measures will be necessary to use this projector at high elevations, so consult your dealer or Authorised Service Centre about preparations. Failure to observe this may cause malfunctions.

Notes on use

In order to get the best picture quality

If outside light or light from indoor lamps is shining onto the screen, the images projected will not have good contrast. Draw curtains or blinds over any windows and turn off any fluorescent lights near the screen to prevent reflection.

Do not touch the surfaces of the lens with your bare hands.

If the surface of the lens becomes dirty from fingerprints or anything else, this will be magnified and projected onto the screen. Moreover, when not using the projector, retract the lens and then cover it with the accessory lens cover.

About the screen

If the screen you are using is dirty, damaged or discoloured, attractive projections cannot be obtained. Do not apply any volatile substances to the screen, and do not let it become dirty or damaged.

Before carrying out cleaning and maintenance, be sure to disconnect the power cord plug from the wall outlet.

Wipe the cabinet with a soft, dry cloth.

If the cabinet is particularly dirty, soak the cloth in water with a small amount of neutral detergent in it, squeeze the cloth very well, and then wipe the cabinet. After cleaning, wipe the cabinet dry with a dry cloth.

If using a chemically-treated cloth, read the instructions supplied with the cloth before use.

Do not wipe the lens with a cloth that is dusty or which produces lint.

If any dust or lint gets onto the lens, such dust or lint will be magnified and projected onto the screen. Use a blower to clean any dust and lint from the lens surface, or use a soft cloth to wipe off any dust or lint.

Location and function of each part

Projector <Top, right and front>

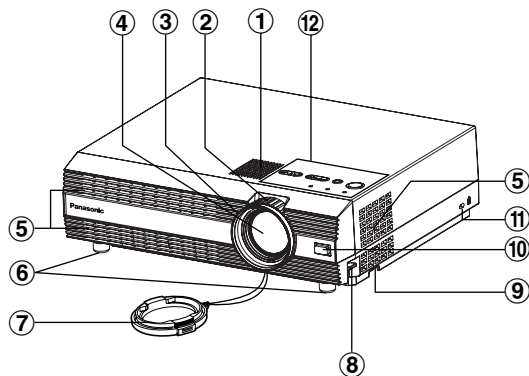

① **Speaker**

② **Zoom ring**
(page 23)

③ **Focus ring**
(page 23)

④ **Projection lens**

⑤ **Air inlet ports**
Do not cover this port.

⑥ **Front adjustable legs(L/R)**
(page 23)

⑦ **Lens cover**

⑧ **Leg adjuster buttons(L/R)**
(page 23)
This button is used to unlock the front adjustable legs. Press to adjust the angle of tilt of the projector.

⑨ **Air filter**
(page 41)

⑩ **Remote control signal receptor**
(page 17)

⑪ **Security lock**

This can be used to connect a commercially-available theft-prevention cable (manufactured by Kensington). This security lock is compatible with the Microsaver Security System from Kensington. Contact details for this company are given below.
Kensington Technology Group
ACCO Brands Inc.
2855 Campus Drive
San Mateo, CA 94403 USA
Tel (650)572-2700
Fax (650)572-9675
<http://www.kensington.com/>
<http://www.gravis.com/>

⑫ **Projector control panel**
(page 14)

Projector <Back and bottom>

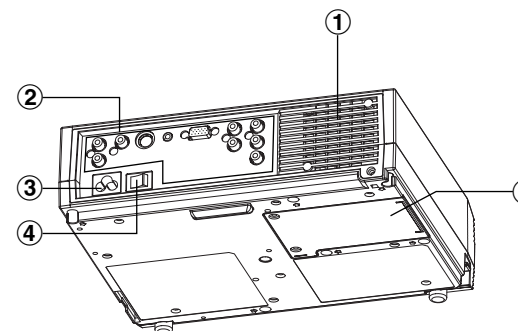

① **Air outlet port**

Do not cover this port.

WARNING

Do not bring your hands or other objects close to the air outlet port.

- Heated air comes out of the air outlet port. Do not bring your hands or face, or objects which cannot withstand heat close to this port, otherwise burns or damage could result.

② **Connector panel**
(page 16)

③ **Power input socket (AC IN)**
(page 22)

The accessory power cord is connected here.
Do not use any power cord other than the accessory power cord.

④ **MAIN POWER switch**
(pages 22 and 23)

⑤ **Lamp unit holder**
(page 43)

NOTE:

- During projection of an image, the cooling fan will operate, emitting a small noise as it operates. Turning the lamp on or off will cause this noise to increase a little.
- By using the OPTION menu to set "LAMP POWER" to LOW, the operating sound of the fan can be reduced. (Refer to page 38.)

<Projector control panel and remote control unit>

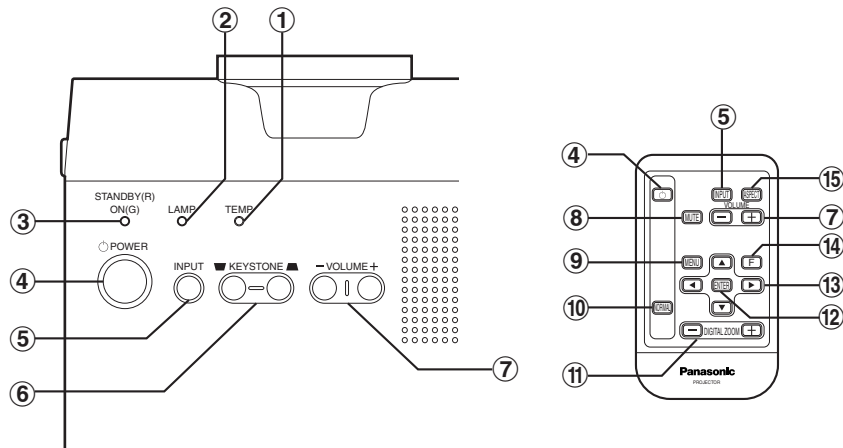

- The wireless remote control and the projector itself have the same control buttons available.

① TEMP indicator

(page 39)

This indicator illuminates if an abnormally high temperature is detected inside the projector. If the temperature rises above a certain level, the power supply will be turned off automatically and the indicator will illuminate or flash.

② LAMP indicator

(page 40)

This indicator illuminates when it is time to replace the lamp unit. It flashes if a circuit abnormality is detected.

③ Power indicator

(pages 22 and 23)

This indicator illuminates red when the main power is switched on (Standby Mode), and it illuminates green when projection of an image begins.

④ POWER button

(pages 22 and 23)

⑤ INPUT select button

(page 22)

⑥ KEYSTONE buttons

(page 29)

These buttons are used to correct keystone distortion of the projected image when the projector position is tilted upward or downward.

⑦ VOLUME +/- buttons

These buttons are used to adjust the volume of the sound output from the projector's built-in speaker.

⑧ MUTE button

(page 33)

This button momentarily stops output of the projector's built-in speaker.

⑨ MENU button

(page 24)

This button is used to display menu screens. When a menu screen is being displayed, it can be used to return to a previous screen or to clear the screen.

⑩ NORMAL button

(page 27)

This button is used to reset the projector adjustment values to the factory default settings.

⑪ DIGITAL ZOOM +/- buttons

(page 28)

These buttons are used to enlarge certain portions of the projected image.

⑫ ENTER button

(page 26)

This button is used to accept and to activate items selected in the on-screen menus.

⑬ Arrow (▲, ▼, ◀ and ▶) buttons

(page 26)

These buttons are used to select and adjust items in the on-screen menu screens.

⑭ F(function) button

(page 38)

This button momentarily freezes a moving image (FREEZE menu item), and it can be used to split the screen into one frozen image and one moving image (INDEX menu item). Use the FUNCTION item in the OPTION menu to select which of these two operations you want to use with this button.

⑮ ASPECT button

(page 30)

This button is used for aspect adjustment (vertical and horizontal proportions).

<Connector panel>

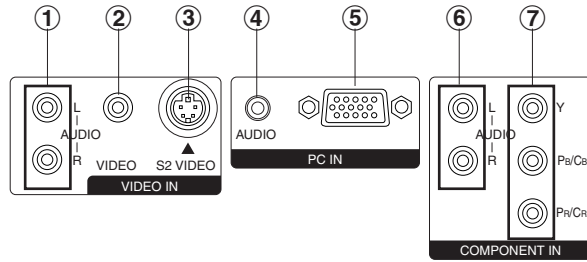

① **AUDIO L-R input jacks (for VIDEO/S-VIDEO)**

(page 18)

Only one system is provided, so connect the appropriate connector when using VIDEO or S-VIDEO.

② **VIDEO input jack**

(page 18)

This jack is used to input video signals from a video equipment such as a video deck.

③ **S2 VIDEO input connector**

(pages 18 and 30)

This connector is used to input signals from an S-VIDEO-compatible equipment such as a video deck. The connector is compatible with S2 and S1 signals, and projector aspect is automatically adjusted according to the type of signal received.

④ **AUDIO input jack (for PC)**

(page 19)

⑤ **RGB input connector**

(page 19)

This connector is used to input RGB signals from a PC.

⑥ **AUDIO L-R input jacks (for YPBPR)**

(page 20)

⑦ **YPBPR(CbCr) input jacks**

(page 20)

These jacks are used to input YPBPR signals from compatible equipment such as DVD players.

Using the remote control unit

Inserting the battery

Insert the lithium battery which is supplied with the remote control unit, making sure that the polarities are correct.

- ① **While pushing the battery holder tab to the right, pull out the battery holder.**

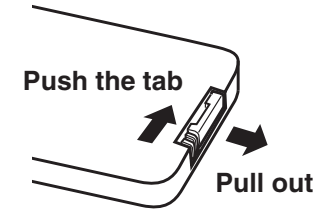

- ② **Insert the battery into the battery holder so that the "+" side is facing upwards.**

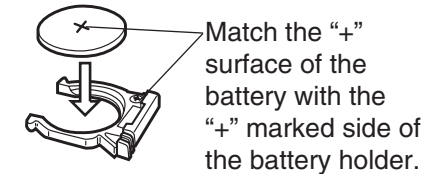

- ③ **Insert the battery holder.**

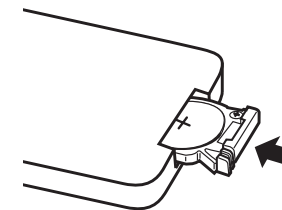

NOTE:

- Do not drop the remote control unit.
- Keep the remote control unit away from liquids.
- Remove the battery if not using the remote control unit for long periods.
- Use only CR2025 batteries as replacement batteries.

Operating range

If the remote control unit is held so that it is facing directly in front of the front remote control signal receptor, the operating range is within approximately 7 m (23') from the surfaces of the receptors.

Furthermore, the remote control unit can be operated from an angle of $\pm 30^\circ$ to the left or right and $\pm 15^\circ$ above or below the receptors.

NOTE:

- If there are any obstacles in between the remote control unit and the receptors, the remote control unit may not operate correctly.
- If strong light is allowed to shine onto the remote control signal receptor, correct remote control operation may not be possible. Place the projector as far away from light sources as possible.
- If facing the remote control unit toward the screen to operate the projector, the operating range of the remote control unit will be limited by the amount of light reflection loss caused by the characteristics of the screen used.

Connections

Notes on connections

- Read the instruction manual for each system component carefully before connecting it.
- Turn off the power supply for all components before making any connections.
- If the cables necessary for connecting a component to the system are not included with the component or available as an option, you may need to fashion a cable to suit the component concerned.

Example of connecting to video equipment

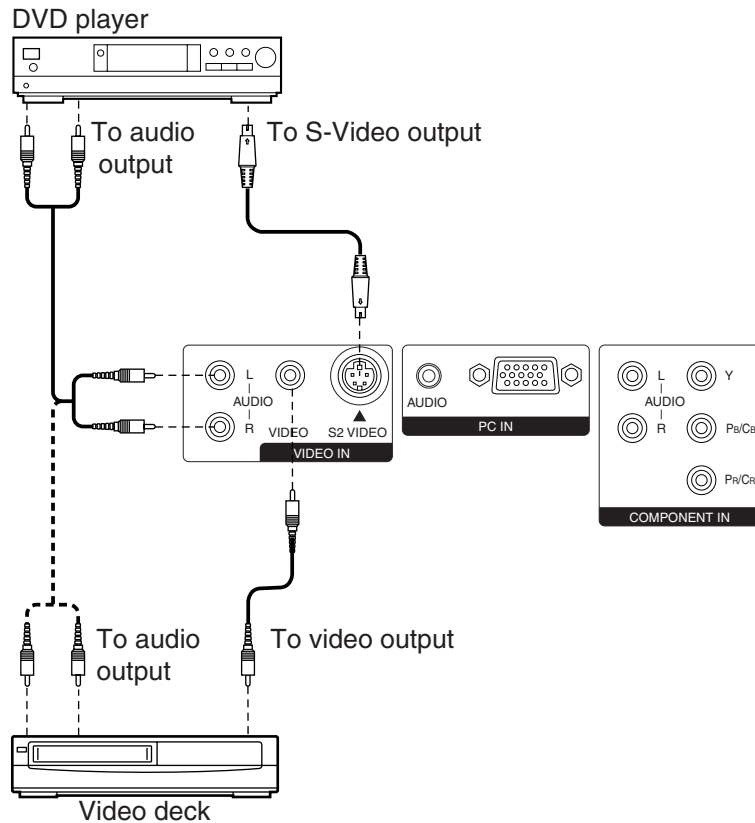

NOTE:

- Only one audio system circuit is available for the AUDIO L-R input jacks for S-VIDEO/VIDEO signals, so if you wish to change the audio input source, you will need to remove and insert the appropriate plugs.
- If the signal cables are disconnected or if the power supply for the computer or video deck is turned off while the digital zoom or index window functions are being used, these functions will be cancelled.

Example of connecting to computer

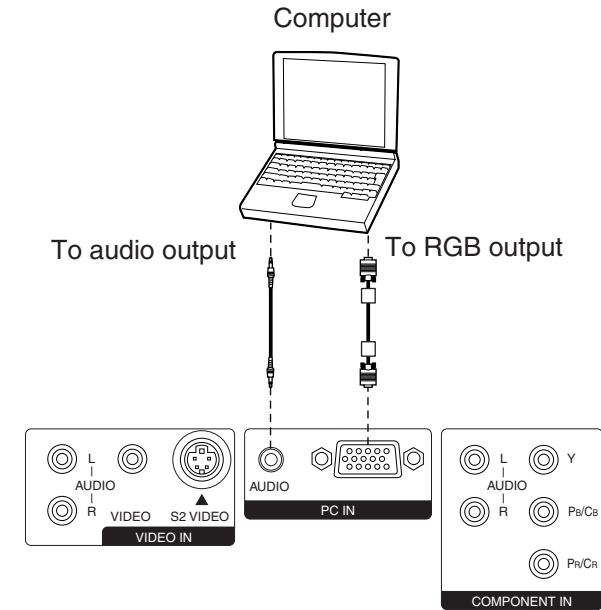

NOTE:

- It is better to shut down the computer before turning off the MAIN POWER switch of the projector.
- Refer to the list of compatible signals on page 49 for the types of RGB signals which can be input to the projector by connecting a computer.

Example of connecting to equipment compatible with YPBPr(CbCr) signals

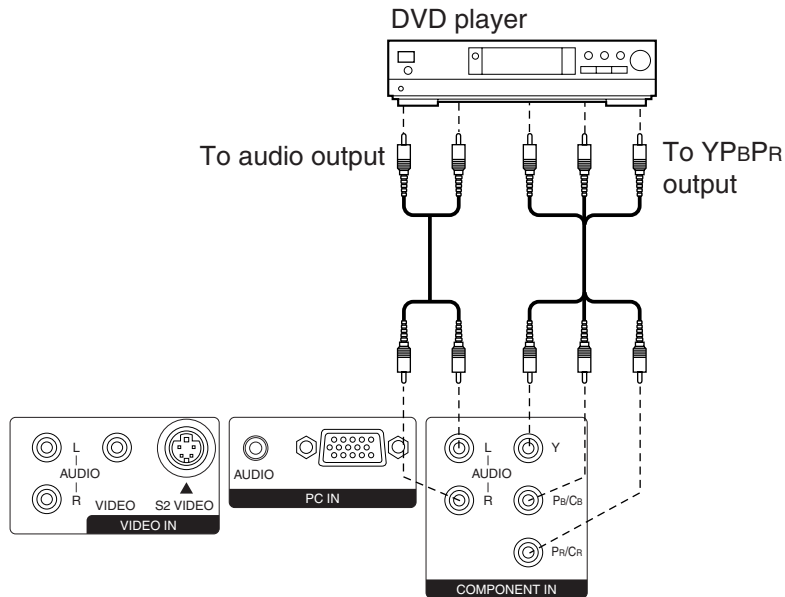

NOTE:

- Refer to page 49 for a list of compatible YPBPr signals which can be input to the projector.

Setting-up

Projection methods

The projector can be set up so that any one of the following four projection methods can be used. Select whichever projection method matches the setting-up method. (The projection method can be set from the OPTION menu. Refer to page 38 for details.)

		DESK/CEILING	
		DESK	CEILING
FRONT/REAR	FRONT		
	REAR		

NOTE:

- You will need to purchase the separate ceiling bracket (ET-PKE100) when using the ceiling installation method.

Projector position

The projection range of this projector is 1.2 m – 7.4 m.

The lower edge of the projected image falls about 0.1 m from the centre of the lens.

For details about projected image distances, refer to page 51.

Screen Size (16:9)

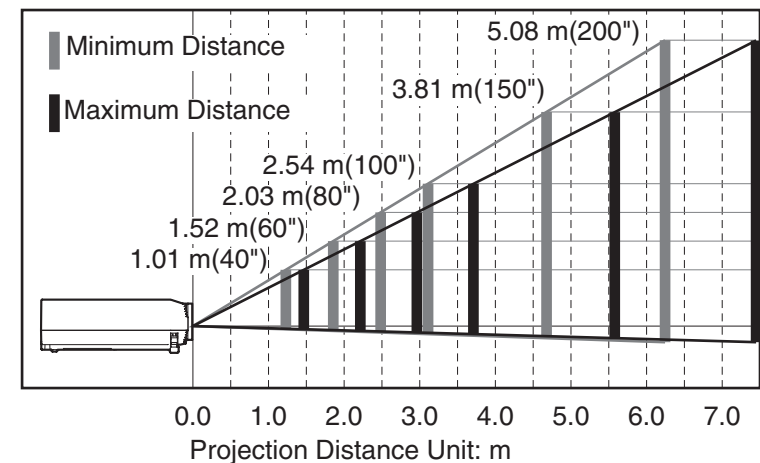

Starting to use

Turning on the power

Please ensure that all preparations have been completed before turning on the power. (Refer to pages 18 – 21.)

① Remove the lens cover.

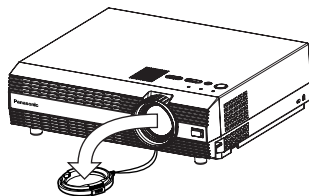

② Connect the accessory power cord.

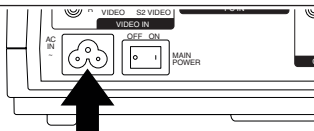

③ Press the MAIN POWER switch to the “I” side to turn on the power.

The power indicator on the projector will illuminate red.

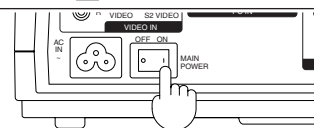

④ Press the POWER button.

The power indicator on the projector will flash green. After a short period, the button will illuminate green, and a picture will be projected.

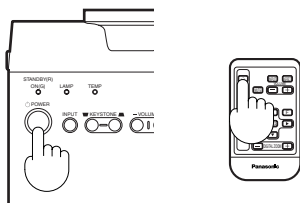

⑤ Turn on the power of all connected devices.

Start the Play function a device such as a DVD player.

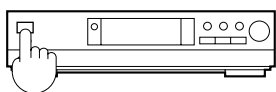

⑥ Press the INPUT select button to select the input signal.

The input signal selected will change as shown at below-right each time an input select button is pressed.

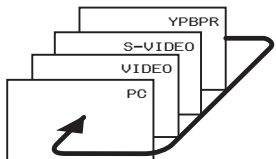
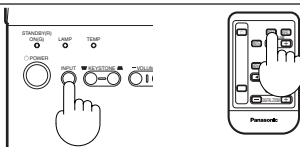

⑦ While pressing the adjuster buttons, adjust the forward/back angle of tilt of the projector.

If there is keystone distortion in the projected images, carry out keystone correction as described on page 29.

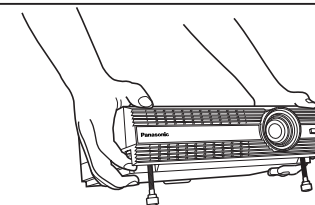

⑧ Turn the focus/zoom ring to adjust the projected image focus and size.

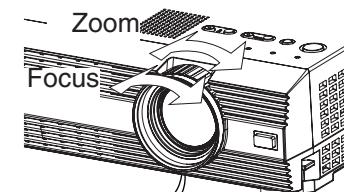

Turning off the power

① Hold down the POWER button for at least 0.5 seconds or press the POWER button twice to turn off the power.

The lamp unit will switch off and the picture will stop being projected. (The power indicator on the projector will illuminate orange.)

② Wait until the power indicator on the projector illuminates red (until the cooling fan stops).

Do not in any way cut power to the projector while the cooling fan is still operating. Be careful not to switch off the MAIN POWER switch of the projector, unplug the power cord from the electrical outlet or turn off in-line switches such as tabletop power switches.

③ Press the MAIN POWER switch to the “O” side to turn off the power.

NOTE:

- After the power is turned off, the lamp unit will take some time to cool down. If you turn the power back on again before the lamp unit has cooled down, the lamp unit may not turn on straight away, but it will turn on automatically after a short period. (During this time, the power indicator on the projector will flash orange.)
- When the projector is in standby mode (the power indicator on the projector is illuminated red), the projector will still draw a maximum 0.7 W of power, even when the cooling fan has stopped.
- If the MAIN POWER switch is accidentally turned off while the projector is being used, the lamp unit may not turn on straight away after the power is turned back on. In such cases, the lamp unit will turn back on automatically after a short period. (During this time, the power indicator on the projector will flash green.)
- A tinkling sound may be heard while the power indicator is turned off, but this is not a sign of a malfunction.

On-screen menus

Menu screens

The various settings and adjustments for this projector can be carried out by selecting the operations from on-screen menus.

The general arrangement of these menus is shown below.

MAIN MENU

MENU	
KEYSTONE	
PICTURE	
POSITION	
SHUTTER	
LANGUAGE	
OPTION	
◆ SELCT [ENTER] ENTER	

Keystone correction
(page 29)

SHUTTER function
(page 33)

OPTION menu (page 37)

OPTION	
OSD	ON
PC PRIORITY	NORMAL
BACK COLOR	BLACK
4:3 H-POS	CENTER
FRONT/REAR	FRONT
DESK/CEILING	DESK
LAMP POWER	HIGH
LAMP RUNTIME	5H
FUNCTION	INDEX
◆ SELCT [ENTER] ADJ [MENU] ESC	

LANGUAGE menu (page 33)

LANGUAGE ENGLISH	
ENGLISH	
DEUTSCH	
FRANÇAIS	
ESPAÑOL	
ITALIANO	
日本語	
中文	
◆ SELCT [ENTER] ENTER [MENU] ESC	

NOTE:

- The remote control unit must be used to manipulate on-screen menus.
- Keystone distortion of the on-screen display will not be corrected.

PICTURE menu (page 34)
When an S-VIDEO/VIDEO signal is being input

PICTURE	
PICTURE MODE	NORMAL
COLOR	0
TINT	0
BRIGHT	0
CONTRAST	0
SHARPNESS	0
COLOR TEMP.	NORMAL
TV-SYSTEM	AUTO1
◆ SELCT [ENTER] ADJ [MENU] ESC	

When a YPBPR signal is being input

PICTURE	
PICTURE MODE	NORMAL
COLOR	0
TINT	0
BRIGHT	0
CONTRAST	0
SHARPNESS	0
COLOR TEMP.	NORMAL
SIGNAL MODE	525I
◆ SELCT [ENTER] ADJ [MENU] ESC	

When a PC signal is being input

PICTURE	
PICTURE MODE	NORMAL
BRIGHT	0
CONTRAST	0
SHARPNESS	0
COLOR TEMP.	NORMAL
W-BAL R	0
W-BAL G	0
W-BAL B	0
SIGNAL MODE	SUGA
◆ SELCT [ENTER] ADJ [MENU] ESC	

POSITION menu (page 36)
When an S-VIDEO/VIDEO/
YPBPR signal is being input

POSITION	
H-POSI	0
V-POSI	0
ASPECT	16:9
◆ SELCT [ENTER] ENTER [MENU] ESC	

When a PC signal is being input

POSITION	
H-POSI	0
V-POSI	0
DOT CLK	0
CLK PHASE	0
ASPECT	4:3
AUTO SETUP	
◆ SELCT [ENTER] ENTER [MENU] ESC	

Menu operation guide

① Press the MENU button.

The MAIN MENU screen will be displayed.

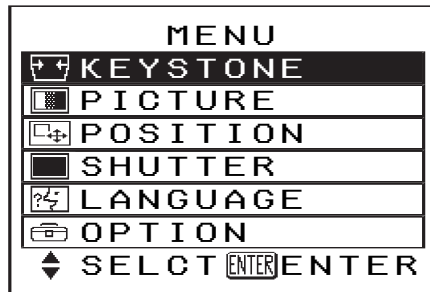

② Press the ▲ or ▼ arrow buttons to select an item.

Selected items will be displayed in blue.

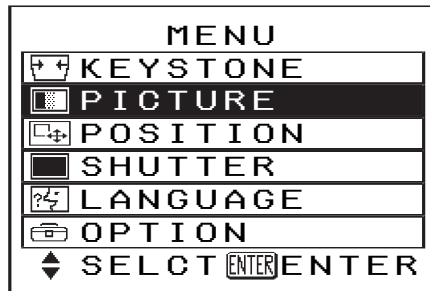

③ Press the ENTER button to accept the selection.

The selected menu screen or adjustment screen will then be displayed.

(Example: PICTURE menu)

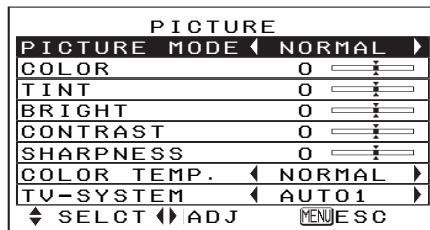

④ Press the ▲ or ▼ buttons to select an item, and then press the ◀ or ▶ buttons to change or adjust the setting.

An individual adjustment screen such as the one shown below will be displayed for bar-scale items.

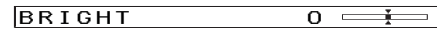

The bar scale will turn green when any adjustment changes the setting from the factory set value.

Unavailable on-screen menu items

This projector has unadjustable items and unusable functions depending on the signal being input. When an item cannot be adjusted or a function cannot be used, the corresponding on-screen menu display does not appear, and the item or function will not work even if the ENTER button is pressed.

Returning to the previous screen

If you press the MENU button while a menu screen is being displayed, the display will return to the previous screen.

If you press the MENU button while the MAIN MENU screen is being displayed, the MAIN MENU screen will be cleared.

Returning a setting to the factory default

If you press the NORMAL button on the remote control unit, you can return settings to the factory default settings. However, the operation of this function varies depending on which screen is being displayed.

- When a menu screen is being displayed

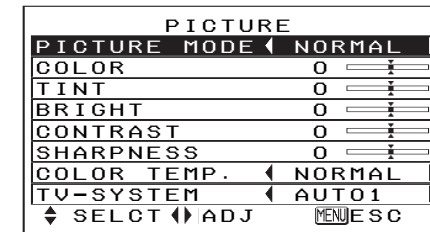

All items displayed will be returned to their factory default settings, and the bar scale will appear white.

- When an individual adjustment screen is being displayed

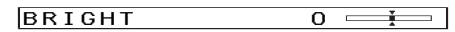

Only the item displayed will be returned to the factory default setting, and the bar scale will appear white.

NOTE:

- Triangle symbols above and below a menu bar indicate the factory default setting. Items which do not have these triangle symbols cannot be returned to the factory default setting.

Indicates the standard factory default setting



Indicates the current adjustment value

- The positions of triangle symbols vary depending on the type of signal being input.

Using the freeze function

The picture will alternate between a still picture and a moving picture each time the F(function) button on the remote control unit is pressed.

Select FREEZE from the FUNCTION item in the OPTION menu to use this function. (Refer to page 38.)

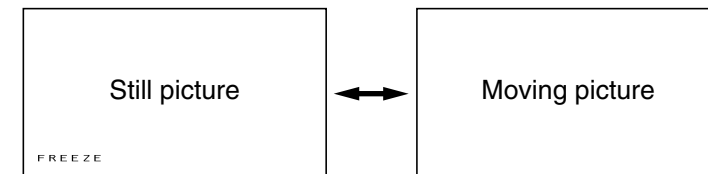

Using the DIGITAL ZOOM function

This function lets you enlarge a single section of the picture. Furthermore, the spot display mode which is used to select the section which is to be enlarged can also be used when making presentations.

① **Press a DIGITAL ZOOM +/- button.**

The projector will change to spot display mode.

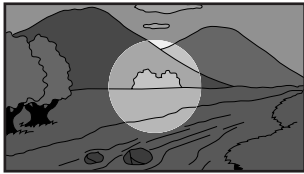

② **Use the ▲, ▼, ◀ and ▶ buttons to move the spot to the section which you would like to enlarge, and then press the ENTER button.**

The area around the spot will then be enlarged to twice the normal size.



③ **Use the DIGITAL ZOOM +/- buttons to change the enlargement ratio.**

The enlargement ratio can be changed within the range of x1 to x2, in steps of 0.1.

NOTE:

- When PC signals are being input, the enlargement ratio can be changed within the range of x1 to x3.

④ **Press the MENU button to return to the normal screen.**

The projector will not return to spot display mode at this time. To return to spot display mode, clear the enlarged picture display from the screen and then press a DIGITAL ZOOM +/- button again.

NOTE:







- This function can only be used when using the remote control unit.
- If the type of signal being input changes while the digital zoom function is being used, the digital zoom function will be cancelled.

Correcting keystone distortion

When either the projector or the screen is tilted, the keystone distortion will affect the image. You can correct the image proportions by the following procedure.

① **Use the KEYSTONE buttons to obtain image balance.**

You can also correct keystone distortion by selecting the KEYSTONE item in the MAIN MENU and pressing ENTER.

Picture condition	Operation
	Press the  or  button.
	Press the  or  button.

② **Press the MENU button to return to the previous screen.**

NOTE:

- Keystone distortion can be corrected to $\pm 30^\circ$ of the angle of tilt for the projector. However, the greater the correction amount, the more the picture quality will deteriorate, and the harder it will become to achieve a good level of focus. To obtain the best picture quality, set up the projector and screen in such a way that the amount of keystone correction required is as minimal as possible.
- The picture size will also change when correction of keystone distortion is carried out.

Setting the ASPECT

This projector allows you to change the aspect ratio to match the type of input signal. Pressing the ASPECT button will change the aspect ratio according to the successive settings shown below. (You can also change the aspect ratio by selecting the POSITION item in the MAIN MENU and pressing ENTER.)

S-VIDEO	S1/S2→4:3→16:9→JUST→ZOOM
VIDEO/YPbPr	4:3→16:9→JUST→ZOOM
PC	4:3→16:9→V SCROLL

Illustrations for aspect ratio settings are shown on the next page. Refer to this illustration for assistance in selecting a suitable aspect ratio.

About S2 and S1 video signals:

- S2 and S1 video signals are for 16:9 images and include a notification signal when being played by devices such as a DVD player.
- When the projector is set to the “S1/S2” setting shown above, it will detect those notification signals and automatically switch to the correct aspect ratio for projection.

NOTE:

- This projector is equipped with an aspect ratio selection function. However, if a mode which does not match the aspect ratio of the input signal is selected, it may affect the quality of viewing of the original picture. Keep this in mind when selecting the aspect ratio.
- If using this projector in places such as cafes or hotels with the aim of displaying programmes for viewing for a commercial purpose or for public presentation, note that if the aspect ratio (16:9) selection function is used to change the aspect ratio of the screen picture, you may be infringing the rights of the original copyright owner for that programme under copyright protection laws.
- If a normal (4:3) picture which was not originally intended for wide-screen viewing is projected onto a wide screen, distortion may occur around the edges of the picture so that part of the picture is no longer visible. Such programmes should be viewed in 4:3 mode to give proper consideration to the aims and intentions of the original programme’s creator.
- The following signals have resolutions that are 16:9 image sizes. The aspect ratios for these signals cannot be changed while being played because they are already established. (Refer to page 49.)
HDTV60, HDTV50, 750p, WIDE 400/480/600/720/768
- Image sizes such as Cinema-Vision that project wider than the 16:9 ratio will have narrow black fields at the top and bottom.

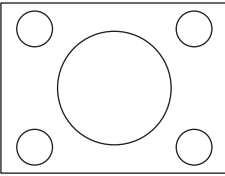
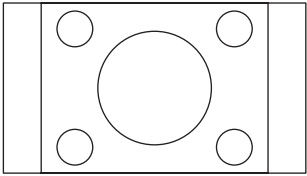
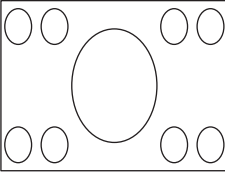
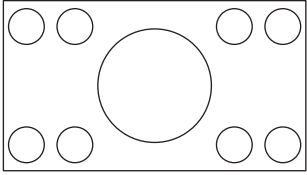
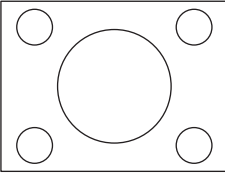
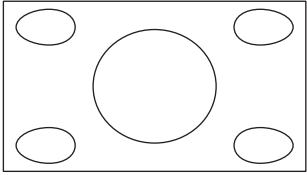
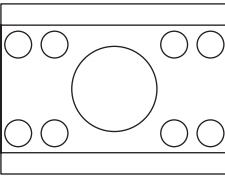
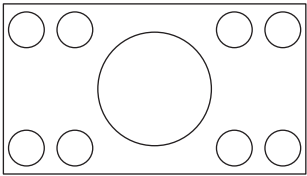
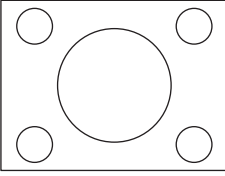
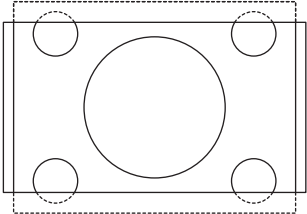
ASPECT	Input signal	Projected Image
4:3	4:3 Input signal 	4:3 
16:9	Squeezed signal (image contracted horizontally) 	Horizontal expansion of projected image 
JUST	4:3 Input signal 	Horizontal expansion of projected image (Centre of image is less distorted) 
ZOOM	Letterbox signal 	Expansion preserves original ratio 
V SCROLL	4:3 Input signal 	Enlarges image approximately 1.2 times (Vertical position can be adjusted by the ▼ and ▲ buttons) 

Using the index window function

This function lets you store a picture which is being projected into memory, so that you can display a still picture and a moving picture on the screen.

Select INDEX from the FUNCTION item in the OPTION menu to use this function. (Refer to page 38.)

① Press the F (function) button.

NOTE:

- The aspect ratio of the screen changes and the image is vertically elongated in comparison to a normal image.

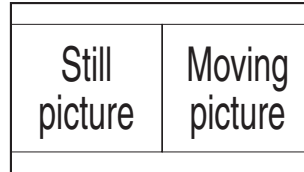

② Use the ▲ and ▼ buttons to select a screen size.

The screen size can be chosen from 3 options.

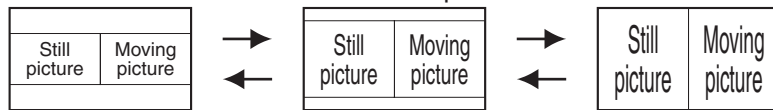

③ Use the ◀ and ▶ buttons to switch between the still picture screen (left) and moving picture screen (right).

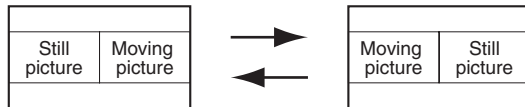

④ Press the ENTER button to store the picture in memory.

NOTE:

- When the screen size is changed, the picture's aspect ratio will also change. Make sure that you fully understand the notes on S2 and S1 signals which are given on page 30 before using the index window function.
- When steps ② and ③ are carried out, the memory will be reset and a new picture will be stored in memory.

Using the shutter function

The shutter function can be used to momentarily turn off the picture and sound from the projector when the projector is not being used for short periods of time, such as during breaks in meetings or when carrying out preparation. The projector uses less power in shutter mode than it does in normal projection mode.

① Select SHUTTER from the MAIN MENU screen and then press the ENTER button.

② Press any button on either the projector or remote control unit to return to normal operating mode.

Changing the display language

① Select LANGUAGE from the MAIN MENU screen and then press the ENTER button.

② Use the ▲▼ buttons to select a language and then press the ENTER button.

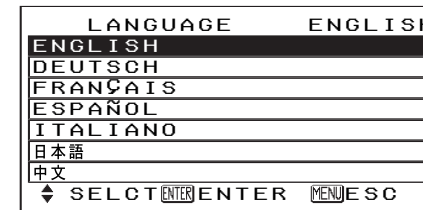

Indicates the language which is currently set

Muting the sound

The sound can be muted for temporary interruptions such as telephone calls. Press the MUTE button once to turn off sound, and press MUTE again to regain sound.



NOTE:

- Turning off the power will cancel adjustments such as volume level set with the VOLUME +/- buttons.

Adjusting the picture

Use the ▲ and ▼ buttons to select an item, and then use the ◀ and ▶ buttons to change the setting for that item.

For items with bar scales, press the ENTER button or the ◀ or ▶ buttons to display the adjustment screen, and then use the ◀ or ▶ buttons to make the adjustment.

When an S-VIDEO/VIDEO signal is being input

PICTURE	
PICTURE MODE ◀ NORMAL ▶	
COLOR 0	◀ ▶
TINT 0	◀ ▶
BRIGHT 0	◀ ▶
CONTRAST 0	◀ ▶
SHARPNESS 0	◀ ▶
COLOR TEMP. ◀ NORMAL ▶	
TV-SYSTEM ◀ AUTO1 ▶	
◀ SELCT ▶ ADJ	MENU ESC

When a YPbPr signal is being input

PICTURE	
PICTURE MODE ◀ NORMAL ▶	
COLOR 0	◀ ▶
TINT 0	◀ ▶
BRIGHT 0	◀ ▶
CONTRAST 0	◀ ▶
SHARPNESS 0	◀ ▶
COLOR TEMP. ◀ NORMAL ▶	
SIGNAL MODE 525I	
◀ SELCT ▶ ADJ	MENU ESC

When a PC signal is being input

PICTURE	
PICTURE MODE ◀ NORMAL ▶	
BRIGHT 0	◀ ▶
CONTRAST 0	◀ ▶
SHARPNESS 0	◀ ▶
COLOR TEMP. ◀ NORMAL ▶	
W-BAL R 0	◀ ▶
W-BAL G 0	◀ ▶
W-BAL B 0	◀ ▶
SIGNAL MODE SVGA	
◀ SELCT ▶ ADJ	MENU ESC

PICTURE MODE

When an S-VIDEO/VIDEO/YPbPr signal is being input

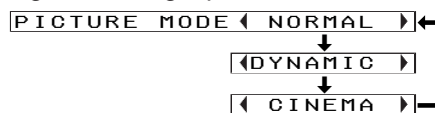

When a PC signal is being input

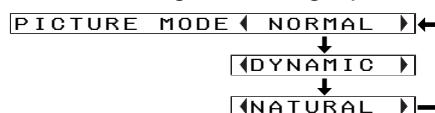

Select the picture mode that best matches the image source and room conditions.

The mode best used in dark rooms is NATURAL or CINEMA. For rooms having regular lighting conditions in use, select NORMAL. For exceptionally bright rooms, use DYNAMIC.

COLOR

(S-VIDEO/VIDEO/YPbPr only)

Press the ▶ button to make the colour more vivid in tone, and press the ◀ button to make the colour more pastel in tone.

TINT

(NTSC/NTSC 4.43/YPbPr only)

This adjusts the flesh tones in the picture. Press the ▶ button to make flesh tones more greenish, and press the ◀ button to make the flesh tones more reddish.

BRIGHT

This adjusts the darker areas (black areas) in the picture. Press the ▶ button if dark areas are too solid (for example, if hair is difficult to see), and press the ◀ button if black areas are too light (grey rather than black).

CONTRAST

This adjusts the contrast of the picture. Press the ▶ button to make the picture brighter, and press the ◀ button to make the picture darker. (Adjust the BRIGHT setting first if required before adjusting the CONTRAST setting.)

SHARPNESS

Press the ▶ button to make the picture details sharper, and press the ◀ button to make the picture details softer.

TV SYSTEM

(S-VIDEO/VIDEO only)

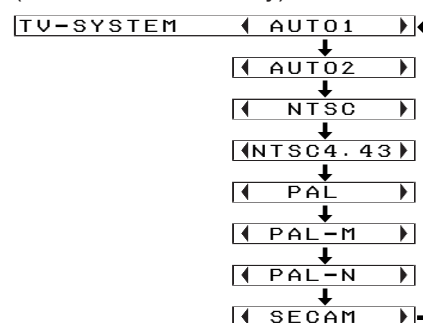

AUTO1 The projector automatically distinguishes between NTSC/NTSC 4.43/PAL/SECAM signals.

AUTO2 The projector automatically distinguishes between NTSC/PAL-M/PAL-N signals.

This should normally be set to "AUTO1" or "AUTO2". If the signal is of such poor quality that the correct format cannot be automatically distinguished, change the setting manually to the required TV system.

Colour Hue Setting (color temperature)

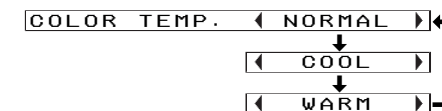

Use COLOR TEMP. to adjust colour according to the type of screen being used.

NORMAL is for white screens. COOL is for grey screens. WARM is for yellow screens.

WHITE BALANCE R/G/B

(PC only)

This is used to adjust the white areas of the picture if they appear colourised.

Press the ◀ button to make the selected colour lighter. Press the ▶ button to make the selected colour stronger.

SIGNAL MODE

(PC/YPbPr only)

This displays the type of signal which is currently being projected. Refer to the table on page 49 for details on each type of signal.

Adjusting the position

When the input signal is from a PC, first select AUTO SETUP and then press the ENTER button to initiate automatic positioning. If the optimum setting is not obtained when AUTO SETUP is carried out, adjust by the following procedure.

Use the ▲ and ▼ buttons to select an item, and then use the ◀ and ▶ buttons to change the setting for that item.

For items with bar scales, press the ENTER button or the ◀ or ▶ buttons to display the adjustment screen, and then use the ◀ or ▶ buttons to make the adjustment.

When an S-VIDEO/VIDEO/YPbPr signal is being input

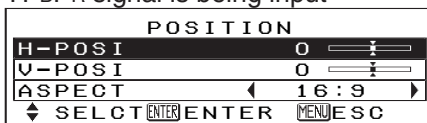

When an PC signal is being input

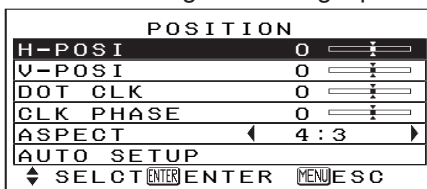

HORIZONTAL POSITION

Press the ◀ button to move the picture to the left, and press the ▶ button to move the picture to the right.

VERTICAL POSITION

Press the ◀ button to move the picture down, and press the ▶ button to move the picture up.

DOT CLOCK

(PC only)

Periodic striped pattern interference (noise) may occur when a striped pattern such as the one below is projected. If this happens, use the ◀ and ▶ buttons to adjust so that any such noise is minimised.

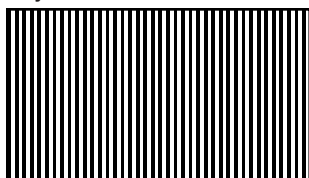

CLOCK PHASE

(PC only)

Adjust the DOT CLOCK setting first before carrying out this adjustment. Use the ◀ and ▶ buttons to adjust so that the noise level is least noticeable.

NOTE:

- If signals with a dot clock frequency of 100 MHz or higher are being input, interference may not be completely eliminated when the DOT CLOCK and CLOCK PHASE adjustments are carried out.

ASPECT

Refer page 30.

AUTO SETUP

(PC only)

HORIZONTAL POSITION, VERTICAL POSITION, DOT CLOCK and CLOCK PHASE are matched to the input signal and are automatically adjusted.

Option settings

Use the ▲ and ▼ buttons to select an item, then press the ◀ or ▶ buttons to change the setting.

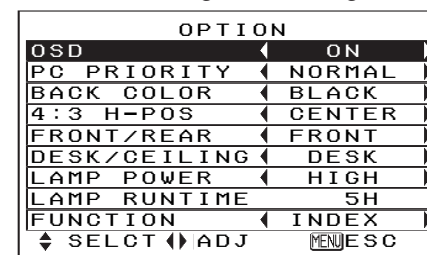

OSD

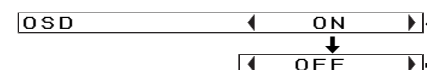

ON The signal name is displayed in the top-right corner of the screen when the input signal is changed.

OFF Use this setting when you do not want the signal name to be displayed.

PC PRIORITY

(PC only)

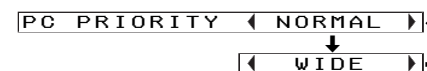

NORMAL displays the PC screen data in a 4:3 aspect ratio. WIDE displays the PC screen data in a 16:9 aspect ratio.

NOTE:

- When the ASPECT is set to V-SCROLL (page 30), AUTO SETUP cannot be performed.

BACK COLOR

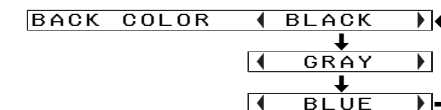

This sets the colour which is projected onto the screen when no signal is being input to the projector. This sets the background colour for the left/right margins when the 4:3 aspect ratio is selected. (Refer to page 31.)

4:3 H-POS

(4:3 aspect mode only)

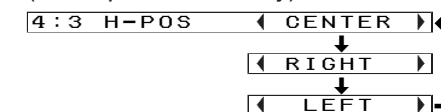

This sets the horizontal positioning of the projected image when the 4:3 aspect ratio is selected. (Refer to page 31.)

FRONT/REAR

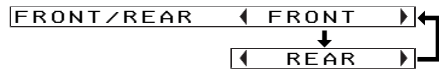

This setting should be changed in accordance with the projector setting-up method.

Set to “FRONT” when using a normal reflective screen with the projector positioned in front of the screen, and set to “REAR” when using a translucent screen with the projector positioned behind the screen.

DESK/CEILING

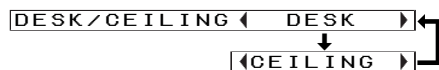

This setting should be changed in accordance with the projector setting-up method.

Set to “DESK” when setting up the projector on a desk or similar, and set to “CEILING” when suspending the projector from the ceiling using the ceiling bracket which is sold separately.

LAMP POWER

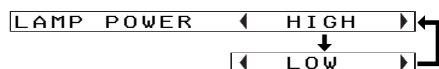

This setting changes the lamp brightness. When set to “LOW”, the luminance of the lamp is reduced, but the projector uses less power, and the operating noise is also reduced.

The LOW position is recommended for narrow rooms where a high picture luminance is not essential or for watching movies.

LAMP TIME

This setting displays the usage time for the lamp unit which is currently being used.

NOTE:

- The lamp’s operating life varies depending on the usage conditions (such as the LAMP POWER setting and the number of times the power is turned on and off).

FUNCTION



This sets the operation that will be carried out when the FUNCTION button is pressed.

INDEX will activate the Index Window, splitting the screen into a still image and a moving image. (Refer to page 32.)

FREEZE will temporarily freeze the image. (Refer to page 27.)

Indicators

There are two indicators on the control panel of the projector which give information about the operating condition of the projector. These indicators illuminate or flash to warn you about problems that have occurred inside the projector, so if you notice that one of the indicators is on, turn off the power and check the table below for the cause of the problem.

TEMP indicator			
Indicator display	Illuminated (red) (Lamp unit on)	Flashing (red) (Lamp unit on)	Flashing (red) (Lamp unit off)
Problem	The surrounding temperature or the temperature inside the projector has become unusually high.	The temperature inside the projector has become dangerously high, or the temperature has suddenly changed.	The surrounding temperature or the temperature inside the projector has become dangerously high, causing the lamp unit to be automatically shut off.
Possible cause	<ul style="list-style-type: none"> • The ventilation holes may be covered. • The ambient temperature in the place of use may be too high. • The air filter may be blocked. 		
Remedy	<ul style="list-style-type: none"> • Uncover the ventilation holes. • Set up the projector in a place where the temperature is between 0 °C (32 °F) and 40 °C (104 °F) and the humidity is between 20% and 80% (with no condensation). • Turn off the MAIN POWER switch by following the procedure on page 23, and then clean the air filter (refer to page 41). 		

LAMP indicator			
Indicator display	Illuminated (red)	Flashing (red)	
Problem	It is nearly time to replace the lamp unit.	An abnormality has been detected in the lamp circuit.	
Possible cause	<ul style="list-style-type: none"> Does “REPLACE LAMP” appear on the screen after the projector is turned on? 	<ul style="list-style-type: none"> The power may have been turned on straight away after it was turned off. 	<ul style="list-style-type: none"> There may be an abnormality in the lamp circuit.
Remedy	<ul style="list-style-type: none"> This occurs when the operation time for the lamp unit is nearing 1800 hours. (when LAMP POWER has been set to “HIGH”) Ask your dealer or an Authorised Service Centre to replace the lamp unit. 	<ul style="list-style-type: none"> Wait for a while until the lamp unit cools down before turning the power back on again. 	<ul style="list-style-type: none"> Turn off the MAIN POWER switch by following the procedure given on page 23, and then contact an Authorised Service Centre.

NOTE:

- Be sure to turn off the MAIN POWER switch by following the procedure given in “Turning off the power” on page 23 before carrying out any of the procedures in the “Remedy” column.
- If the main power turns off after the TEMP indicator starts flashing, it means that an abnormality has occurred. Please contact an Authorised Service Centre so that the necessary repairs can be made.

Cleaning and replacing the air filter

If the air filter becomes clogged with dust, the internal temperature of the projector will rise, the TEMP indicator will flash and the projector power will turn off. **The air filter should be cleaned every 100 hours of use,** depending on the location where the projector is being used.

Cleaning procedure

- Turn off the MAIN POWER switch and disconnect the power cord plug from the wall outlet.**
Turn off the MAIN POWER switch according to the procedure given in “Turning off the power” on page 23 before disconnecting the plug from the wall outlet.
- Gently turn the projector upside down.**

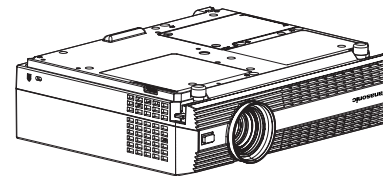

NOTE:

- Place the projector on top of a soft cloth so that it will not become scratched.

- Remove the air filter.**
Put your fingernails under the air filter and pull the air filter out of the projector.

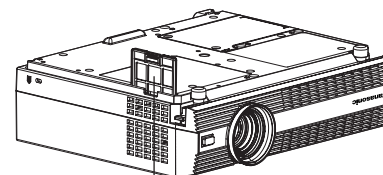

Air filter

- Clean the air filter.**
Use a vacuum cleaner to clean off any accumulated dust.

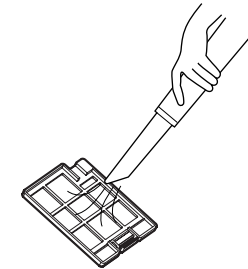

NOTE:

- Be careful not to let the air filter get sucked into the vacuum cleaner.

- Install the air filter.**

NOTE:

- Be sure to install the air filter cover before using the projector. If the projector is used without the air filter cover installed, dust and other foreign particles will be drawn into the projector, and malfunctions will result.
- If the dust cannot be removed by cleaning, it is time to replace the air filter. Please consult your dealer. Furthermore, if the lamp unit is being replaced, replace the air filter at this time also.

Replacing the lamp unit

Warning

The lamp unit should only be replaced by a qualified technician.

When replacing the lamp, allow it to cool for at least one hour before handling it.

- The lamp cover gets very hot, and contact with it can cause burns.

Notes on replacing the lamp unit

- The light generating lamp is made of glass, so dropping it or allowing it to hit hard objects may cause it to burst. Be careful when handling the lamp.
- After having removed the old lamp, carelessly discarding it can cause the lamp to burst. Dispose of the lamp with the same care that would be taken with a fluorescent light.
- A Phillips screwdriver is necessary for removing the lamp unit. Make sure that your hands are not slippery when using the screwdriver.

NOTE:

- The projector is not supplied with a replacement lamp unit. Please ask your dealer for details. Lamp unit product no.: **ET-LAE100**

CAUTION:

- Do not use any lamp unit other than the one with the product number indicated above.



Lamp unit replacement period

The lamp is a consumable product. Even when the full life of the bulb has not been exhausted, the brightness of the light will gradually decline. Therefore periodic replacement of the lamp is necessary.

The intended lamp replacement interval is 2000 hours, but it is possible that the lamp may need to be replaced earlier due to variables such as a particular lamp's characteristics, usage conditions and the installation environment. Early preparation for lamp replacement is encouraged. A lamp that has exceeded 2000 hours of use has a much greater chance of exploding. In order to prevent the lamp from exploding, the lamp will be automatically shut off when 2000 hours of use have been reached.

NOTE:

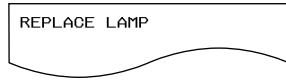
- The usage hours explained above are for use when the HIGH setting has been selected for LAMP POWER in the OPTION menu. If the LOW setting is selected, the brightness of the lamp will be less and life of the lamp can be extended.
- While 2000 hours is the intended replacement interval, it is not a period of time covered by warranty.

	On-screen display 	Lamp indicator warning light 
More than 1800 hours	Displayed for 30 seconds. Pressing any button will clear the display.	The projector will enter Standby Mode and the red indicator lamp will illuminate.
More than 2000 hours	This display cannot be cleared at all, no matter which button is pressed.	

Lamp unit replacement procedure

NOTE:

- If the lamp usage time has passed 2000 hours (when LAMP POWER has been set to "HIGH"), the projector will switch to standby mode after approximately 10 minutes of operation. The steps ⑧ to ⑾ on the next page should thus be completed within 10 minutes.

- ① Turn off the MAIN POWER switch according to the procedure given in "Turning off the power" on page 23, and then disconnect the power cord plug from the wall outlet and check that the area around the lamp unit has cooled down.
- ② Use a Phillips screwdriver to turn the lamp unit cover fixing screws at the bottom of the projector, and then remove the lamp unit cover from the projector.

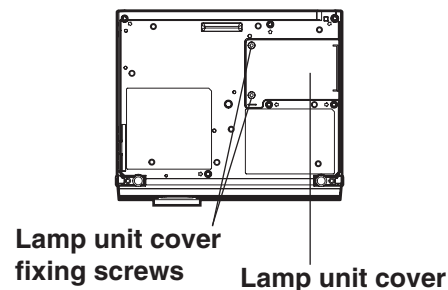

- ③ Use a Phillips screwdriver to loosen the two lamp unit fixing screws until the screws turn freely. Then hold the handle of the lamp unit and gently pull it out from the projector.

Lamp unit fixing screws

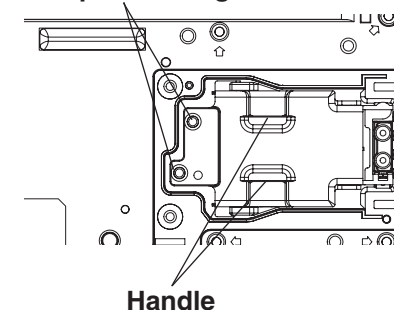

- ④ Insert the new lamp unit while making sure that the direction of insertion is correct, and then use a Phillips screwdriver to securely tighten the lamp unit fixing screws.

- ⑤ Install the lamp unit cover, and then use a Phillips screwdriver to securely tighten the lamp unit cover fixing screws.

NOTE:

- Be sure to install the lamp unit and the lamp unit cover securely. If they are not securely installed, it may cause the protection circuit to operate so that the power cannot be turned on.
- ⑥ Insert the power cord plug into the wall outlet and then press the MAIN POWER switch.

NOTE:

- If the POWER button on the projector does not illuminate red when the MAIN POWER switch is turned on, turn the MAIN POWER switch off again and check that the lamp unit and the lamp unit cover are securely installed. Then turn the MAIN POWER switch back on.

- ⑦ Press the POWER button so that a picture is projected onto the screen.

- ⑧ Press the MENU button to display the MAIN MENU screen, and then press the ▲ and ▼ buttons to move the cursor to select “OPTION”.

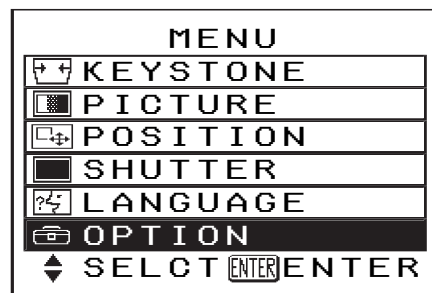

- ⑨ Press the ENTER button to display the OPTION screen, and then use the ▲ and ▼ buttons to select LAMP RUNTIME.

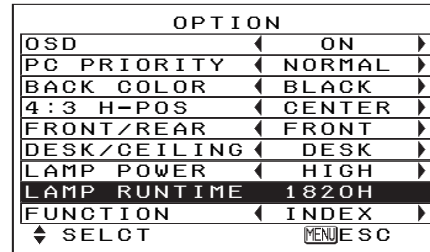

- ⑩ Press and hold the ENTER button for approximately 3 seconds.

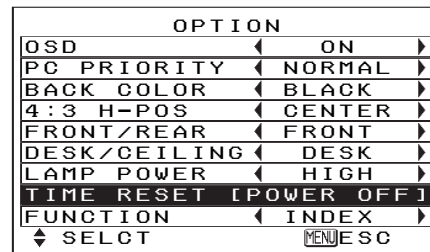

The “LAMP RUNTIME” will change to “TIME RESET [POWER OFF]”.

NOTE:

- If the MENU button is pressed, the lamp time resetting screen will be cancelled.
- ⑪ Hold down the POWER button for at least 0.5 seconds or press the POWER button twice to turn off the power. This will reset the cumulative usage time for the lamp unit to zero.

Before asking for service

Before asking for service, check the following points.

Problem	Possible cause
Power does not turn on.	<ul style="list-style-type: none"> ● The power cord may not be connected. ● The MAIN POWER switch is turned off. ● The main power supply is not being supplied to the wall outlet. ● TEMP indicator is illuminated or flashing. (Refer to page 39.) ● LAMP indicator is illuminated or flashing. (Refer to page 40.) ● The lamp unit cover has not been securely installed.
No picture appears.	<ul style="list-style-type: none"> ● The video signal input source may not be connected properly. ● The input selection setting may not be correct. (Refer to page 22.) ● The BRIGHT adjustment setting may be at the minimum possible setting. (Refer to page 34.) ● The shutter function may be in use. (Refer to page 33.)
The picture is fuzzy.	<ul style="list-style-type: none"> ● The lens cover may still be attached to the lens. ● The lens focus may not have been set correctly. (Refer to page 23.) ● The projector may not be at the correct distance from the screen. (Refer to page 21.) ● The lens may be dirty. ● The projector may be tilted too much. (Refer to page 23.)
COLOR is too light or TINT is poor	<ul style="list-style-type: none"> ● COLOR or TINT adjustment may be incorrect. (Refer to page 34.) ● The input source which is connected to the projector may not be adjusted correctly.
No sound can be heard.	<ul style="list-style-type: none"> ● The audio signal source may not be connected properly. ● The volume adjustment may be at the lowest possible setting. (Refer to page 14.) ● Make sure that the MUTE function is not activated.

Problem	Possible cause
Remote control unit does not operate.	<ul style="list-style-type: none"> • The battery may be weak. • The battery may not be inserted correctly. (Refer to page 17.) • The remote control signal receptor on the projector may be obstructed. (Refer to page 17.) • The remote control unit may be out of the operation range. (Refer to page 17.)
The picture does not display correctly.	<ul style="list-style-type: none"> • The correct input signal may not be selected. (Refer to page 22.) • The signal format (TV system) may not be set correctly. (Refer to page 35.) • There may be a problem with the video tape or other signal source.
Picture from computer does not appear	<ul style="list-style-type: none"> • A signal which is not compatible with the projector may be being input. (Refer to page 49.) • The cable may be too long. • The external video output for the laptop computer may not be set correctly. (You may be able to change the external output settings by pressing the [Fn]+[F3] or [Fn]+[F10] keys simultaneously. The actual method varies depending on the type of computer, so refer to the documentation provided with your computer for further details.)

Specifications

Power supply:	100 V–240 V ~, 50 Hz/60 Hz
Power consumption:	180 W (During standby (when fan is stopped): Approx. 0.7 W) 2.2 A–0.8 A
Amps:	
LCD panel:	
Panel size (diagonal):	0.7 type (17.78 mm)
Aspect ratio:	16:9
Display method:	3 transparent LCD panels (RGB)
Drive method:	Active matrix method
Pixels:	415 272 (858 x 484) x 3 panels
Lens:	Manual zoom (1 - 1.2) / focus lens F 2.0 - 2.3, f 22.0 mm - 26.2 mm
Lamp:	UHM lamp (120 W)
Luminosity:	700 lm/ANSI
Scanning frequency:	(for RGB signals):
Horizontal scanning frequency:	30 kHz–70 kHz
Vertical scanning frequency:	50 Hz–87 Hz
Dot clock frequency:	100 MHz or less
YPbPr signals:	525i (480i), 625i, 525p (480p), 750p (720p), 1125i (1080i)
Colour system:	6 (NTSC/NTSC 4.43/PAL/PAL-M/PAL-N/SECAM)
Projection size:	1016 mm - 5080 mm (40" - 200")
Throw distance:	1.2 m - 7.4 m (3'11" - 24'3")
Optical axis shift:	17:1 (fixed)
Screen aspect ratio:	16:9
Installation:	Front/Rear/Ceiling/Desk (Menu selection method)
Speaker:	4 cm x 3 cm oval x 1
Max. useable volume output:	2 W (mono)
Connectors	
VIDEO IN:	
S2 VIDEO:	Single-line, Mini DIN 4-pin Y 1.0 V [p-p], C 0.286 V [p-p], 75 Ω
VIDEO:	Single-line, RCA pin jack 1.0 V [p-p], 75 Ω
AUDIO:	0.5 V [rms] RCA pin jack x 2 (L-R)
PC IN:	
RGB:	Single-line D-SUB HD 15-pin (female)
R.G.B.:	0.7 V [p-p], 75 Ω
G.SYNC:	1.0 V [p-p], 75 Ω
HD/SYNC:	TTL high impedance, automatic plus/minus polarity compatible
VD:	TTL high impedance, automatic plus/minus polarity compatible
AUDIO:	Single-line 0.5 V [rms] M3 jack (Stereo MINI)

COMPONENT IN:

Y: 1.0 V [p-p], 75 Ω
 PB,PR (CB,CR): 0.7 V [p-p], 75 Ω
 AUDIO: 0.5 V [rms] RCA pin jack x 2 (L-R)
 Cabinet: Moulded plastic (ABS/PC)

Dimensions:

Width: 280 mm (11")
 Height: 85 mm (3 11/32")
 Length: 242 mm (9 17/32") (including lens)
 Weight: 2.7 kg (6.0 lbs.)

Operating environment:

Temperature: 0 °C–40 °C (32 °F–104 °F)
 Humidity: 20%–80% (no condensation)
 Certifications: EN60950, EN55022, EN61000-3-2, EN61000-3-3, EN55024

<Remote control unit>

Power supply: 3 V DC (Lithium CR2025 battery x1)
 Operating range: Approx. 7 m (23') (when operated directly in front of signal receptor)
 Weight: 32 g (1.13 ozs.) (including battery)

Dimensions:

Width: 50 mm (1 31/32")
 Height: 12.5 mm (1/2")
 Length: 86 mm (3 3/8")

<Options>

Ceiling bracket ET-PKE100
 Projection Screen ET-SR90CT(width: 1 800 mm(70"))
 ET-SR70CT(width: 1 400 mm(55"))

Appendix

List of compatible signals

Mode	Display resolution (dots)*1	Scanning frequency		Dot clock frequency (MHz)	Picture quality*2	Format
		H (kHz)	V (Hz)			
NTSC/M-NTSC/PAL-M	720 x 480i	15.734	59.940		A	Video/S-Video
PAL/PAL-N/SECAM	720 x 576i	15.625	50.000		A	Video/S-Video
525i	720 x 480i	15.734	59.940	13.500	A	YPbPr
625i	720 x 576i	15.625	50.000	13.500	A	YPbPr
525p	720 x 483	31.469	59.940	27.000	A	YPbPr
HDTV60	1 920 x 1 080i	33.750	60.000	74.250	A	YPbPr/PC
HDTV50	1 920 x 1 080i	28.125	50.000	74.250	A	YPbPr/PC
750P	1 280 x 720	45.000	60.000	74.250	A	YPbPr
VGA400	640 x 400	31.469	70.086	25.175	A	PC
	640 x 400	37.861	85.081	31.500	A	PC
VGA480	640 x 480	31.469	59.940	25.175	AA	PC
	640 x 480	35.000	66.667	30.240	AA	PC
	640 x 480	37.861	72.809	31.500	AA	PC
	640 x 480	37.500	75.000	31.500	AA	PC
WIDE400	720 x 400	43.269	85.008	36.000	AA	PC
	720 x 400	37.927	85.038	35.500	A	PC
WIDE480	856 x 480	30.057	60.114	31.500	AA	PC
	800 x 600	35.156	56.250	36.000	A	PC
SVGA	800 x 600	37.879	60.317	40.000	A	PC
	800 x 600	48.077	72.188	50.000	A	PC
	800 x 600	46.875	75.000	49.500	A	PC
	800 x 600	53.674	85.061	56.250	A	PC
	832 x 624	49.725	74.550	57.283	A	PC
MAC16	832 x 624	49.725	74.550	57.283	A	PC
WIDE600	1 072 x 600	37.287	59.947	51.382	A	PC
WIDE720	1 280 x 720	45.106	60.141	76.500	A	PC
XGA	1 024 x 768	48.363	60.004	65.000	A	PC
	1 024 x 768	56.476	70.069	75.000	A	PC
	1 024 x 768	60.023	75.029	78.750	A	PC
	1 024 x 768	68.678	84.997	94.500	A	PC
	1 024 x 768i	35.520	86.952	44.897	A	PC
WIDE768	1 280 x 768	45.327	56.518	76.150	A	PC
MXGA	1 152 x 864	63.995	71.184	94.200	A	PC
	1 152 x 864	67.500	74.917	108.000	B	PC
MAC21	1 152 x 870	68.681	75.062	100.000	B	PC

*1 The "i" appearing after the resolution indicates an interlaced signal.

*2 The following symbols are used to indicate picture quality.

AA Maximum picture quality can be obtained.

A Signals are converted by the image processing circuit before picture is projected

B Some loss of data occurs to make projection easier.

Connector pin wiring

- The pin layout and signal names for the S2 VIDEO input connector are shown below.

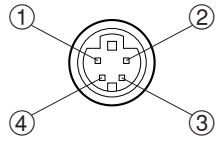

External view

Pin No.	Signal
①	Earth (Luminance signal)
②	Earth (Colour signal)
③	Luminance signal
④	Colour signal

- The pin layout and signal names for the RGB input connector are shown below.

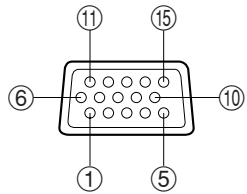

External view

Pin No.	Signal
①	R
②	G/G-SYNC
③	B
⑫	SDA
⑬	HD/SYNC
⑭	VD
⑮	SCL

Pin ⑨ is spare.

Pins ④—⑧, ⑩ and ⑪ are for earth.

Pins ⑫ and ⑮ functions are only valid when supported by the computer

Projection dimensions calculation methods

The following methods will allow you to calculate dimensions such as screen diagonal length and projection distances. Units in all calculations are metre.

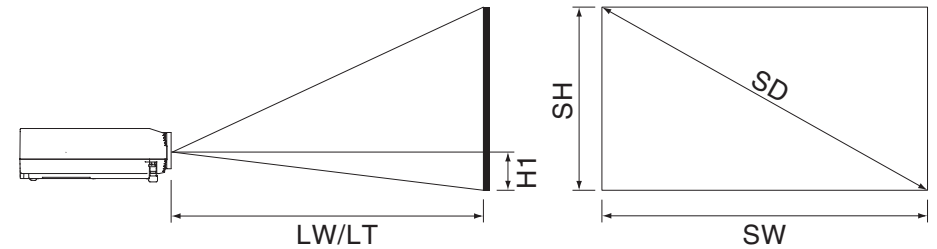

Screen Width: $SW=SD \times 0.872$

Screen Height: $SH=SD \times 0.490$

Minimum Projection Distance: $LW=1.42 \times SW - 0.02$

Maximum Projection Distance: $LT=1.70 \times SW - 0.08$

Image Lower Edge from Lens Centre: $H1=SW/32$

Dimensions

<Units: mm (")>

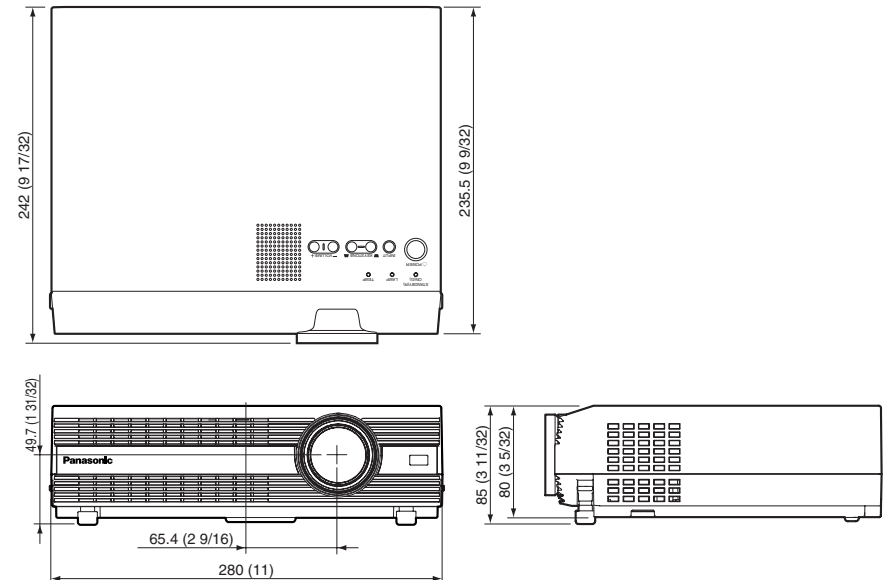

Trademark acknowledgements

- VGA and XGA are trademarks of International Business Machines Corporation.
- Macintosh is a registered trademark of Apple Computer, Inc.
- S-VGA is a registered trademark of the Video Electronics Standards Association.
- Windows is a registered trademark of Microsoft Corporation.

All other trademarks are the property of the various trademark owners.

These Operating Instructions are printed on recycled paper.