

myprojectorlamps.com

**The most trusted, dependable name
in projector lamp sales.**



<http://www.myprojectorlamps.com>



<http://www.myprojectorlamps.ca>



<http://www.myprojectorlamps.eu>

The following projector manual has not been modified or altered in any way.

Panasonic®

LCD Projector

Operating Instructions

Model No. **PT-AE1000U**

ENGLISH

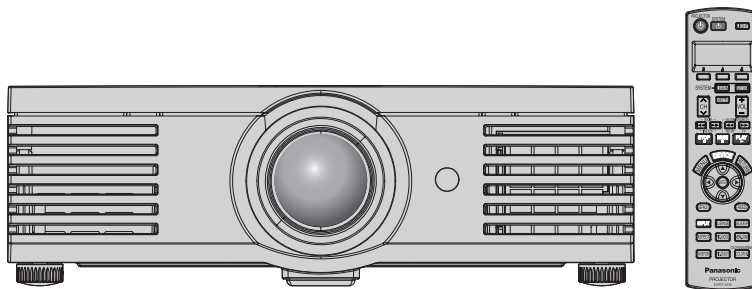

HDMI™
HIGH-DEFINITION MULTIMEDIA INTERFACE

For assistance, please call: 1 - 888 - View - PTV (843 - 9788)
or send e-mail to: consumerproducts@panasonic.com
or visit us at www.panasonic.com

(U.S.A.)

For assistance, please call: 787 - 750 - 4300
or visit us at <http://panasonic.net>

(Puerto Rico)

Before operating this product, please read these instructions carefully and save this manual for future use.

Important Safety Notice

Dear Panasonic Customer:

This instruction booklet provides all the necessary operating information that you might require. We hope it will help you to get the most out of your new product, and that you will be pleased with your Panasonic LCD projector. The serial number of your product may be found on its bottom. You should note it in the space provided below and retain this booklet in case service is required.

Model number: **PT-AE1000U**

Serial number:

WARNING: TO REDUCE THE RISK OF FIRE OR ELECTRIC SHOCK, DONOT EXPOSE THIS PRODUCT TO RAIN OR MOISTURE.

Power Supply: This LCD Projector is designed to operate on 100 V - 240 V, 50 Hz/ 60 Hz AC, house current only.

CAUTION: The AC power cord which is supplied with the projector as an accessory can only be used for power supplies up to 125 V, 7 A. If you need to use higher voltages or currents than this, you will need to obtain a separate 250 V power cord. If you use the accessory cord in such situations, fire may result.



The lightning flash with arrowhead symbol, within an equilateral triangle, is intended to alert the user to the presence of uninsulated “dangerous voltage” within the product’s enclosure that may be of sufficient magnitude to constitute a risk of electric shock to persons.



The exclamation point within an equilateral triangle is intended to alert the user to the presence of important operating and maintenance (servicing) instructions in the literature accompanying the product.

CAUTION: This equipment is equipped with a three-pin grounding-type power plug. Do not remove the grounding pin on the power plug. This plug will only fit a grounding-type power outlet. This is a safety feature. If you are unable to insert the plug into the outlet, contact an electrician. Do not defeat the purpose of the grounding plug.

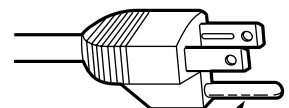

Do not remove

Important Safety Notice

WARNING:

This equipment has been tested and found to comply with the limits for a Class B digital device, pursuant to Part 15 of the FCC Rules. These limits are designed to provide reasonable protection against harmful interference in a residential installation. This equipment generates, uses and can radiate radio frequency energy and, if not installed and used in accordance with the instructions, may cause harmful interference to radio communications. However, there is no guarantee that interference will not occur in a particular installation. If this equipment does cause harmful interference to radio or television reception, which can be determined by turning the equipment off and on, the user is encouraged to try to correct the interference by one or more of the following measures:

- Reorient or relocate the receiving antenna.
- Increase the separation between the equipment and receiver.
- Connect the equipment into an outlet on a circuit different from that to which the receiver is connected.
- Consult the dealer or an experienced radio/TV technician for help.

FCC CAUTION: To assure continued compliance, use only shielded interface cables when connecting to computers or peripheral devices. Any unauthorized changes or modifications to this equipment will void the users authority to operate.

If you use serial port to connect PC for external control of projector, you must use optional RS-232C serial interface cable with ferrite core. Any unauthorized changes or modifications to this equipment will void the user's authority to operate.

Indication based on the German law "Geräte- und Produktsicherheitsgesetz"

Directive 2001/95/EC (Article 5);

Panasonic Marketing Europe GmbH

Hagenauer Str. 43 65203 Wiesbaden F.R.GERMANY

WARNING: Not for use in a computer room as defined in the Standard for the Protection of Electronic Computer/Data Processing Equipment, ANSI/NFPA 75.

Declaration of Conformity

Model Number: PT-AE1000U

Trade Name: **Panasonic**

Responsible party: Panasonic North America

Address: One Panasonic Way 4B - 9 Secaucus, New Jersey 07094

Telephone number: 1 - 888 - View - PTV (843 - 9788)

This device complies with Part 15 of the FCC Rules. Operation is subject to the following two conditions: (1) This device may not cause harmful interference, and (2) this device must accept any interference received, including interference that may cause undesired operation.

Contents

Quick Steps

1. Set up your projector

See "Setting up" on page 14.



2. Connect with other devices

See "Connections" on page 18.



3. Prepare the Remote control

See "Remote control" on page 11.



4. Start projecting

See "Switching the projector on/off" on page 19.



5. Adjust the image

See "Menu Navigation" on page 28.

Important Safety Notice..... 2

Preparation

Precautions with regard to safety 6

WARNINGS 6

CAUTIONS..... 7

Before use..... 9

Accessories 9

Cautions when transporting 9

Cautions when installing 9

Cautions on use 10

About Your Projector 11

Remote control..... 11

Projector..... 12

Getting Started

Setting up..... 14

Screen size and throw distance 14

Projection method 15

Front leg adjuster and throwing angle..... 15

Lens shift and positioning..... 16

Connections 18

Before connection to the projector 18

Connecting with COMPONENT/VIDEO/S-VIDEO 18

Connecting with HDMI/PC 18

Basic Operation

Switching the projector on/off 19

Power cord 19

POWER indicator 19

Switching on the projector..... 20

Switching off the projector..... 20

Projecting an image 21

Selecting the input signal 21

Positioning the image..... 21

Remote control operation 22

Operating range 22

Turning on the button backlight..... 22

Resetting to the factory default settings 22

Capturing an image..... 22

Switching the input signal..... 23

Switching the aspect ratio 23

Adjusting the waveform of the input signal..... 24

Adjusting the focus and zoom 25

Switching the picture mode 25

Adjusting the image..... 25

Switching off the projector automatically..... 25

Loading a saved setting 25

Setting your own color profile..... 26

Settings

Menu Navigation	28
Navigating through the MENU	28
Main menu and Sub-menu	29
PICTURE Menu	31
PICTURE MODE.....	31
CONTRAST	31
BRIGHTNESS.....	31
COLOR	31
TINT	31
SHARPNESS	31
COLOR TEMPERATURE	31
DYNAMIC IRIS.....	32
WAVEFORM MONITOR.....	32
ADVANCED MENU.....	32
MEMORY SAVE	33
MEMORY LOAD	33
SIGNAL MODE	33
POSITION Menu	34
H - POSITION	34
V - POSITION	34
DOT CLOCK	34
CLOCK PHASE.....	34
ASPECT.....	35
WSS.....	36
OVER SCAN	36
KEYSTONE.....	36
AUTO SETUP	36
LENS CONTROL Menu	37
ZOOM/FOCUS.....	37
OPTION Menu	38
INPUT GUIDE	38
OSD DESIGN.....	38
OSD POSITION	38
BACK COLOR.....	38
STARTUP LOGO	38
AUTO SEARCH	38
HDMI SIGNAL LEVEL.....	38
INSTALLATION.....	39
SLEEP	39
ALTITUDE.....	39
LAMP POWER.....	39
LAMP RUNTIME	39
FUNCTION BUTTON.....	39

Maintenance

TEMP and LAMP Indicators	40
Controlling alerts	40
Care and Replacement	41
Before cleaning	41
Cleaning your projector	41
Before replacing the Lamp unit	42
When to replace the Lamp unit	42
Replacing the lamp unit.....	42
Troubleshooting	44
Appendix	
Technical Information	45
List of compatible signals	45
Serial terminal	46
Menu structure	49
Specifications	50
Dimensions	52
Trademark acknowledgements	53
Index	54

Precautions with regard to safety

WARNINGS

If you notice smoke, strange smells or noise coming from the projector, disconnect the power cord plug from the wall outlet.

- Do not continue to use the projector in such cases, otherwise fire or electric shocks could result.
- Check that no more smoke is coming out, and then contact an Authorized Service Center for repairs.
- Do not attempt to repair the projector yourself, as this can be dangerous.

Do not install this projector in a place which is not strong enough to take the full weight of the projector.

- If the installation location is not strong enough, it may fall down or tip over, and severe injury or damage could result.

Installation work (such as ceiling suspension) should only be carried out by a qualified technician.

- If installation is not carried out correctly, there is the danger that injury or electric shocks may occur.
- Do not use other than an authorized ceiling mount bracket.

If foreign objects or water get inside the projector, or if the projector is dropped or the cabinet is broken, disconnect the power cord plug from the wall outlet.

- Continued use of the projector in this condition may result in fire or electric shocks.
- Contact an Authorized Service Center for repairs.

Do not overload the wall outlet.

- If the power supply is overloaded (for example, by using too many adapters), overheating may occur and fire may result.

Do not remove the cover or modify it in any way.

- High voltages can cause fire or electric shocks.
- For any inspection, adjustment and repair work, please contact an Authorized Service Center.

Clean the power cord plug regularly to prevent it from becoming covered in dust.

- If dust builds up on the power cord plug, the resulting humidity can damage the insulation, which could result in fire. Pull the power cord plug out from the wall outlet and wipe it with a dry cloth.
- If not using the projector for an extended period of time, pull the power cord plug out from the wall outlet.

Do not do anything that might damage the power cord or the power cord plug.

- Do not damage the power cord, make any modifications to it, place it near any hot objects, bend it excessively, twist it, pull it, place heavy objects on top of it or wrap it into a bundle.
- If the power cord is used while damaged, electric shocks, short-circuits or fire may result.
- Ask an Authorized Service Center to carry out any repairs to the power cord that might be necessary.

Do not handle the power cord plug with wet hands.

- Failure to observe this may result in electric shocks.

Insert the power cord plug securely into the wall outlet.

- If the plug is not inserted correctly, electric shocks or overheating could result.
- Do not use plugs which are damaged or wall outlets which are coming loose from the wall.

Do not place the projector on top of surfaces which are unstable.

- If the projector is placed on top of a surface which is sloped or unstable, it may fall down or tip over, and injury or damage could result.

Do not place the projector into water or let it become wet.

- Failure to observe this may result in fire or electric shocks.

Do not place the projector on soft materials such as carpets or sponge mats.

- Doing so may cause the projector to overheat, which can cause burns, fire or damage to the projector.

Do not place liquid containers on top of the projector.

- If water spills onto the projector or gets inside it, fire or electric shocks could result.
- If any water gets inside the projector, contact an Authorized Service Center.

Do not insert any foreign objects into the projector.

- Do not insert any metal objects or flammable objects into the projector or drop them onto the projector, as doing so can result in fire or electric shocks.

Do not allow the + and - terminals of the batteries to come into contact with metallic objects such as necklaces or hairpins.

- Failure to observe this may cause the batteries to leak, overheat, explode or catch fire.
- Store the batteries in a plastic bag and keep them away from metallic objects.

During a thunderstorm, do not touch the projector or the cable.

- Electric shocks can result.

Do not use the projector in a bath or shower.

- Fire or electric shocks can result.

Do not place your skin into the light beam while the projector is being used.

- Strong light is emitted from the projector's lens. If you place directly into this light, it can hurt or damage your skin.

Do not look into the lens while the projector is being used.

- Strong light is emitted from the projector's lens. If you look directly into this light, it can hurt and damage your eyes.
- Be especially careful not to let young children look into the lens. In addition, turn off the power and disconnect the power cord plug when you are away from the projector.

Do not place your hands or other objects close to the air outlet port.

- Heated air comes out of the air outlet port. Do not place your hands or face, or objects which cannot withstand heat close to this port [allow at least 50 cm (20") of space], otherwise burns or damage could result.

Replacement of the lamp is better to be carried out by a qualified technician.

- The lamp has high internal pressure. If improperly handled, explosion might result.
- The lamp can easily become damaged if struck against hard objects or dropped, and injury or malfunctions may result.

When replacing the lamp, allow it to cool for at least one hour before handling it.

- The lamp cover gets very hot, and touching it can cause burns.

Before replacing the lamp, be sure to disconnect the power cord plug from the wall outlet.

- Electric shocks or explosions can result if this is not done.

Do not allow infants or pets to touch the remote control unit.

- The accessory remote control unit can be used to operate not only the projector but also other appliances such as air conditioners and electrical device by programing them using the learning function. If the remote control unit operated inappropriately, fire or injury may result.
- Keep the remote control unit out of the reach of infants and pets after using it.

CAUTIONS

Do not cover the air inlet port or the air outlet port.

- Doing so may cause the projector to overheat, which can cause fire or damage to the projector.
- Do not place the projector in narrow, badly ventilated places such as closets or bookshelves.
- Do not place the projector on cloth or papers, as these materials could be drawn into the air inlet port.

Do not set up the projector in humid or dusty places or in places where the projector may come into contact with oily smoke or steam.

- Using the projector under such conditions may result in fire, electric shocks or plastic deterioration. The plastic deterioration may cause the falling down of the projector which is mounted in the ceiling.

When disconnecting the power cord, hold the plug, not the cord.

- If the power cord itself is pulled, the cord will become damaged, and fire, short-circuits or serious electric shocks may result.

Always disconnect all cables before moving the projector.

- Moving the projector with cables still attached can damage the cables, which could cause fire or electric shocks to occur.

Do not place any heavy objects on top of the projector.

- Failure to observe this may cause the projector to become unbalanced and fall, which could result in damage or injury.

Do not short-circuit, heat or disassemble the batteries or place them into water or fire.

- Failure to observe this may cause the batteries to overheat, leak, explode or catch fire, and burns or other injury may result.

When inserting the batteries, make sure the polarities (+ and -) are correct.

- If the batteries are inserted incorrectly, they may explode or leak, and fire, injury or contamination of the battery compartment and surrounding area may result.

Use only the specified batteries.

- If incorrect batteries are used, they may explode or leak, and fire, injury or contamination of the battery compartment and surrounding area may result.

Precautions with regard to safety

Do not mix old and new batteries.

- If the batteries are inserted incorrectly, they may explode or leak, and fire, injury or contamination of the battery compartment and surrounding area may result.

Do not put your weight on this projector.

- You could fall or the projector could break, and injury may result.
- Be especially careful not to let young children stand or sit on the projector.

If not using the projector for an extended period of time, disconnect the power cord plug from the mains socket.

- If dust builds up on the power cord plug, the resulting humidity may damage the insulation, which could result in fire.

Disconnect the power cord plug from the wall outlet as a safety precaution before carrying out any cleaning.

- Electric shocks can result if this is not done.

If the lamp has broken, ventilate the room immediately. Do not touch or bring your face close to the broken pieces.

- Failure to observe this may cause the user to absorb the gas which was released when the lamp broke and which contains nearly the same amount of mercury as fluorescent lamps, and the broken pieces may cause injury.
- If you believe that you have absorbed the gas or that the gas has got into your eyes or mouth, seek medical advice immediately.
- Ask your dealer about the replacement of the lamp unit and check the inside of the projector.

Ask an Authorized Service Center to clean inside the projector at least once a year.

- If dust is left to build up inside the projector without being cleaned out, it can result in fire or problems with operation.
- It is a good idea to clean the inside of the projector before the season for humid weather arrives. Ask your nearest Authorized Service Center to clean the projector when required. Please discuss with the Authorized Service Center regarding cleaning costs.

We are constantly making efforts to preserve and maintain a clean environment. Please take non repairable units back to your dealer or a recycling company.

NOTE:

- This product has a High Intensity Discharge (HID) lamp that contains a small amount of mercury. It also contains lead in some components. Disposal of these materials may be regulated in your community due to environmental considerations. For disposal or recycling information please contact your local authorities, or the Electronics Industries Alliance: <http://www.eiae.org>.

Before use

Accessories

Make sure the following accessories are provided with your projector.

Remote control
(EUR7914Z40 x 1)



AA batteries for **Remote control**
(x 2)

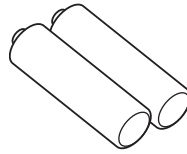

Lens cover (TXFKK01VKD4)

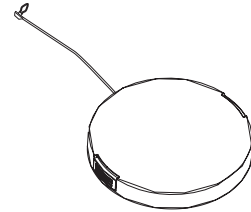

Power cord for continental Europe (K2CG3FZ00008 x 1)

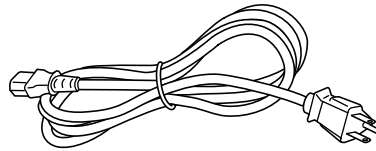

Cautions when transporting

Do not subject the projector to excessive vibration or shocks.

- The projector lens need to be handled with care.
- Cover the lens with the lens cover when transporting the projector.

When transporting the projector, hold the body at the bottom securely.

- Do not hold the adjuster legs or the top cover to move the projector, as this may damage the projector.

Cautions when installing

Avoid setting up in places which are subject to vibration or shocks.

- The internal parts can be damaged, which may cause malfunctions or accidents.

Avoid setting up in places which are subject to sudden temperature changes, such as near an air conditioner or lighting equipment.

- The life of the lamp may be shortened or the projector may be turned off. See "TEMP indicator" on page 40.

Do not set up the projector near high-voltage power lines or near motors.

- The projector may be subject to electromagnetic interference.

If installing the projector to the ceiling, ask a qualified technician to carry out all installation work.

- You will need to purchase the separate installation kit (Model No. ET-PKX100, ET-PKE1000S). Furthermore, all installation work is recommended to be carried out by a qualified technician.

If using this projector at high elevations (above 1 400 m), set the ALTITUDE to HIGH. See "ALTITUDE" on page 39.

- Failure to observe this may result in malfunctions or the life of the lamp or the other components may be shortened.

Before use

Cautions on use

In order to get the best picture quality

- Draw curtains or blinds over any windows and turn off any lights near the screen to prevent outside light or light from indoor lamps from shining onto the screen.

Do not touch the surfaces of the lens with your bare hands.

- If the surface of the lens becomes dirty from fingerprints or anything else, this will be magnified and projected onto the screen. Moreover, when not using the projector, cover it with the lens cover.

Screen

- Do not apply any volatile substances which may cause discoloration to the screen, and do not let it become dirty or damaged.

Lamp

- The lamp may need to be replaced earlier due to variables such as individual lamp characteristics, usage conditions and the installation environment, especially when the projector is subjected to continuous use for more than 10 hours or the power is frequently turned on and off.

Liquid crystal panel

- Do not project the same image for long periods of time, as this may remain as an afterimage on the liquid crystal panel.
- The liquid crystal panel of the projector is built with very high precision technology to provide fine picture details. Occasionally, a few stuck pixels may appear on the screen as fixed points of blue, green or red. Please note that this does not affect the performance of your LCD.

About Your Projector

Remote control

Front, back and top view

Power While the **MAIN POWER** is on, switch between stand-by mode and project mode. (page 20)

MENU Display the **Main menu**. Return to the previous menu. (page 29)

Navigation Navigate through the menus with **▲ ▼ ▶ ◀**, and activate the menu item with **ENTER**. (page 28)

DEFAULT Reset some of the settings to the factory default settings. (page 22)

Battery compartment
 1. Press the tab and lift up the cover.
 2. Insert the batteries according to the polarity diagram indicated inside.

Remote control signal emitter

LIGHT Turn the button backlight of **Remote control** on/off. (page 22)

Function buttons Assign the frequently used functions from the option for shortcut. (page 39)

Learning Remote control buttons and LCD Program and operate other devices. See “Remote Control Operating Guide”.

RETURN Return to the previous menu. (page 28)

FREEZE Capture the projected image as a still picture. (page 22)

INPUT	Switch to cycle through the input method. (page 23)	LENS	Adjust the focus and size of the image. (page 25)	SLEEP	Turn off the POWER automatically by setting the duration. (page 22)
ASPECT	Switch to cycle through the aspect ratio. (page 23)	PIC.MODE	Switch to cycle through the PICTURE MODE . (page 25)	MEM.LOAD	Display the MEMORY LOAD menu. (page 25)
WAVEFORM	Display the input waveform. (page 24)	PIC.ADJUST	Display the PICTURE menu. (page 25)	COLOR M.	Display the COLOR MANAGEMENT menu. (page 26)

NOTE:

- Do not drop the **Remote control**.
- Avoid contact with liquids or moisture.
- Remove the batteries if not using the **Remote control** for a long period of time.
- Do not use rechargeable batteries.
- Do not keep pressing the **Remote control** buttons as this may shorten battery life.

About Your Projector

Projector

Top and front view

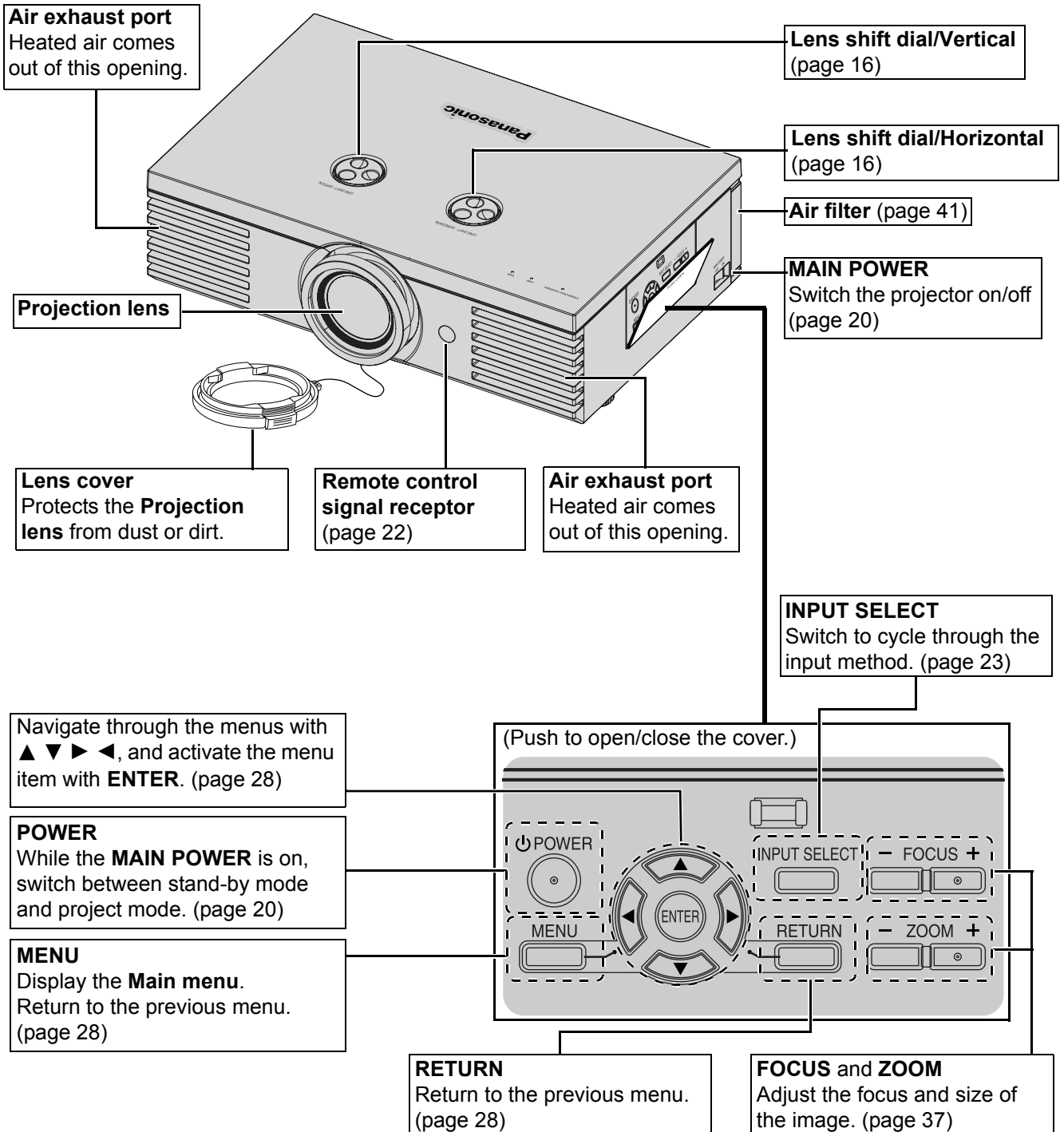

NOTE:

- Do not cover the ventilation openings or place anything within 50 cm (20") of them as this may cause damage or injury.
- While the projector is not in use, attach the **Lens cover** to protect the lens.

Back and bottom view

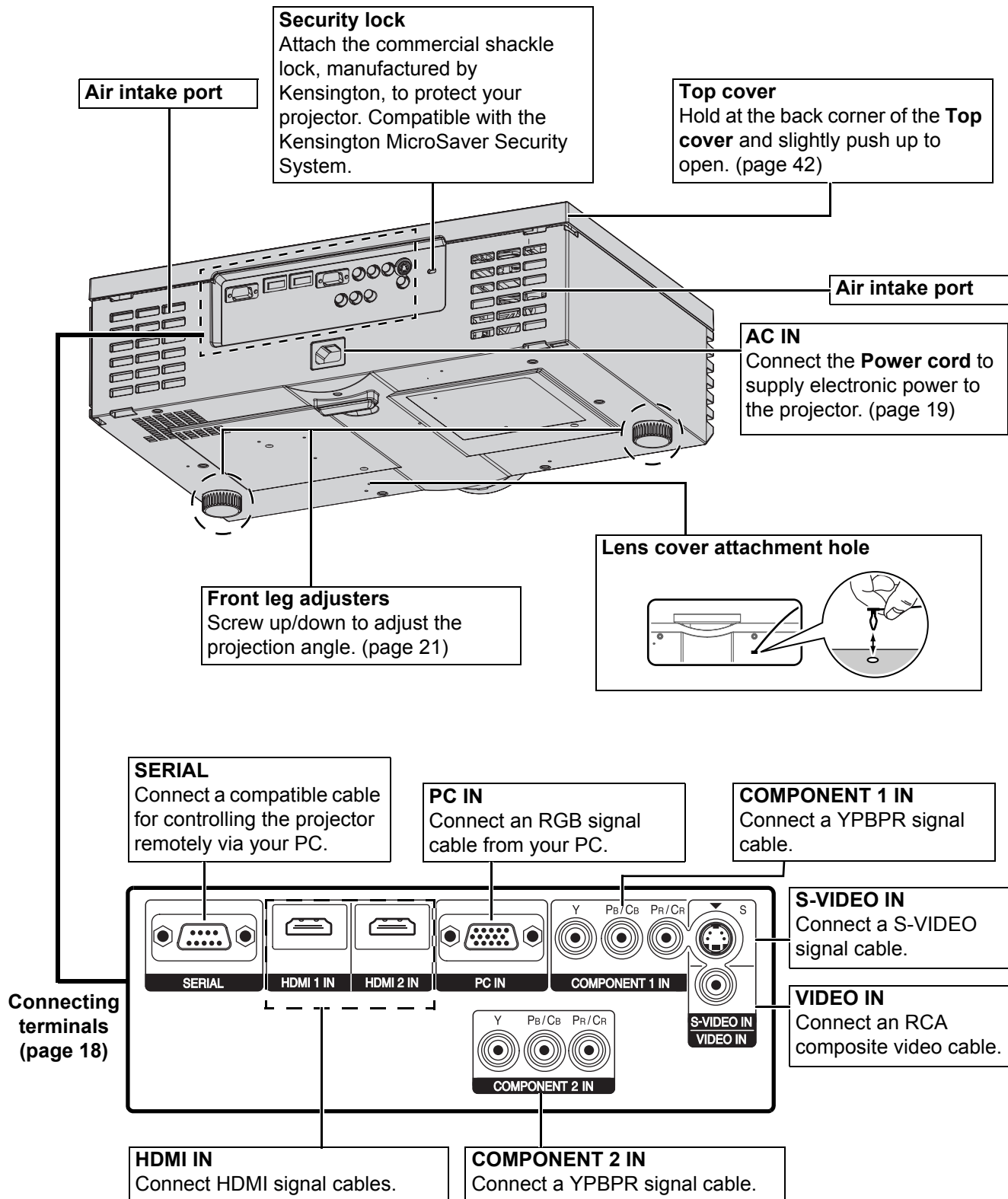

NOTE:

- Do not cover the ventilation openings or place anything within 50 cm (20") of the vents as this may cause damage or injury.
- This projector should only be used with the attached **Power cord** to ensure optimum performance and avoid damage to the projector.
- Do not open the **Top cover** other than replacing the lamp unit.

Setting up

Screen size and throw distance

You can adjust the projection size with 2.0 power zoom lens. Calculate and define the throw distance as follows.

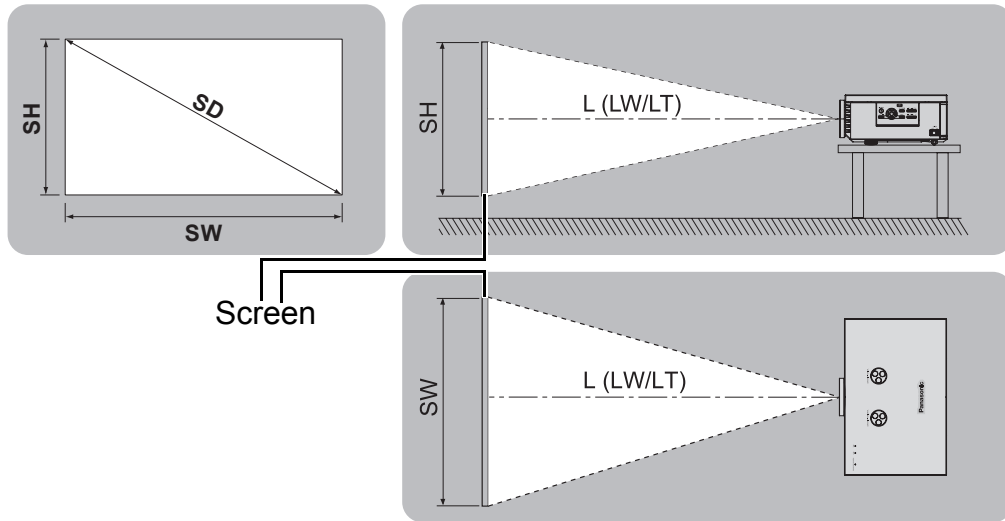

Projection size (16 : 9)			Throw distance (L)	
Diagonal length (SD)	Screen height (SH)	Screen width (SW)	Minimum distance (LW)	Maximum distance (LT)
1.01 m (40")	0.50 m (1'7")	0.89 m (2'11")	1.2 m (3'11")	2.3 m (7'6")
1.27 m (50")	0.62 m (2')	1.11 m (3'7")	1.5 m (4'11")	2.9 m (9'6")
1.52 m (60")	0.75 m (2'5")	1.33 m (4'4")	1.8 m (5'10")	3.5 m (11'5")
1.77 m (70")	0.87 m (2'10")	1.55 m (5'1")	2.1 m (6'10")	4.1 m (13'5")
2.03 m (80")	1.00 m (3'3")	1.77 m (5'9")	2.4 m (7'10")	4.7 m (15'8")
2.28 m (90")	1.12 m (3'8")	1.99 m (6'6")	2.7 m (8'10")	5.3 m (17'4")
2.54 m (100")	1.25 m (4'1")	2.21 m (7'3")	3.0 m (9'10")	5.9 m (19'4")
3.05 m (120")	1.49 m (4'10")	2.66 m (8'8")	3.6 m (11'9")	7.2 m (23'7")
3.81 m (150")	1.87 m (6'1")	3.32 m (10'10")	4.8 m (15'8")	9.0 m (29'6")
5.08 m (200")	2.49 m (8'2")	4.43 m (14'6")	6.0 m (19'8")	12.0 m (39'4")

* All measurements above are approximate and may differ slightly from the actual measurements.

Calculation methods for screen dimensions

You can calculate more detailed screen dimensions from the screen diagonal.

$$SW = SD \times 0.872$$

$$SH = SD \times 0.490$$

$$LW = 1.189 \times SD - 0.04$$

$$LT = 2.378 \times SD - 0.05$$

Unit: m

* The results above are approximate and may differ slightly from the actual measurements.

NOTE:

- Do not use the projector at a raised or a horizontally tilted position as it may cause malfunction of the projector.
- Make sure the projector lens surface is parallel with the screen. You can tilt the projector body approximately $\pm 30^\circ$ vertically. Overtilting may result in shortening the component's life.
- For the best quality of the projection image, install a screen where sun light or room light does not shine directly onto the screen. Close window shades or curtains to block the lights.

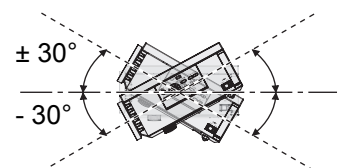

Projection method

You can use the projector with any of the following 4 projection methods. To set the desired method in the projector, see "INSTALLATION" on page 39.

■ Setting on a desk/floor and projecting from front

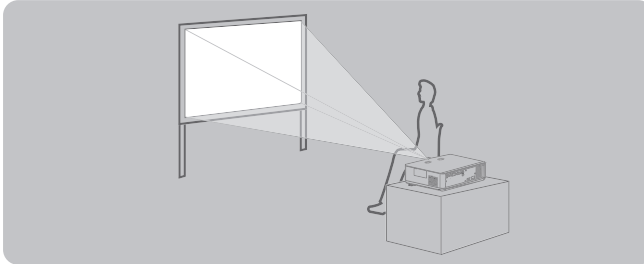

INSTALLATION: FRONT/DESK

■ Setting on a desk/floor and projecting from rear

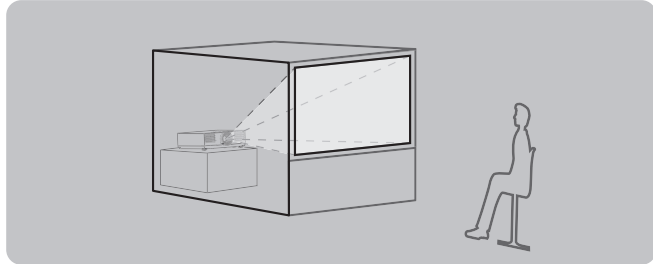

INSTALLATION: REAR/DESK

■ Mounting in the ceiling and projecting from front

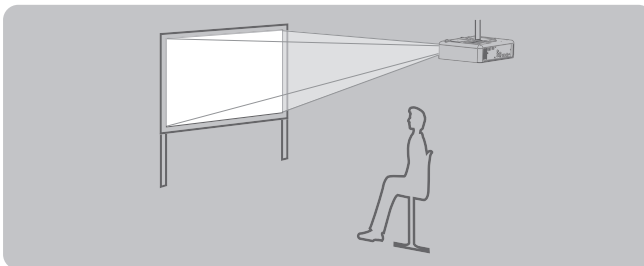

INSTALLATION: FRONT/CEILING

■ Mounting in the ceiling and projecting from rear

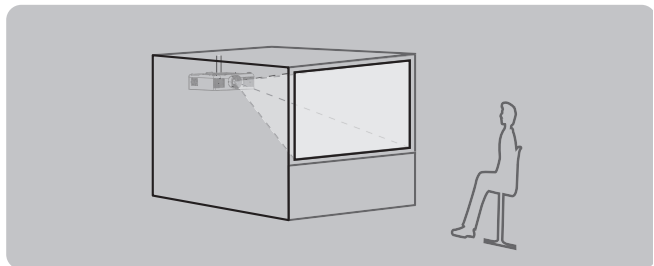

INSTALLATION: REAR/CEILING

NOTE:

- A translucent screen is required for **REAR** projection.
- When mounting the projector in the ceiling, the optional ceiling mount bracket (ET-PKX100, ET-PKE1000S) is required.

Front leg adjuster and throwing angle

You can adjust the throwing angle by screwing the front legs up/down. This adjust the angle of the projector. See "Positioning the image" on page 21.

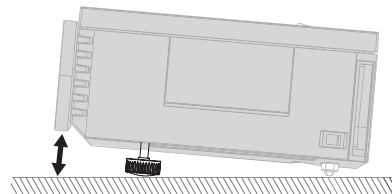
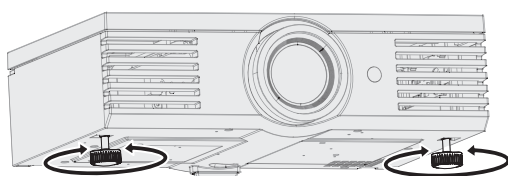

NOTE:

- Heated air comes out of the **Air exhaust port**. Do not touch the **Air exhaust port** directly.
- If keystone distortion occurs, see "KEYSTONE" on page 36.

Lens shift and positioning

If the projector is not positioned right in front of the center of the screen, you can adjust the projected image position by moving the **Lens shift dials** within the shift range of the lens.

Adjusting the Lens shift dials

Horizontal shift

You can place the projector where the projector lens is up to 40% horizontally off-center from the screen and then adjust the image position with the **Lens shift dial • Horizontal**.

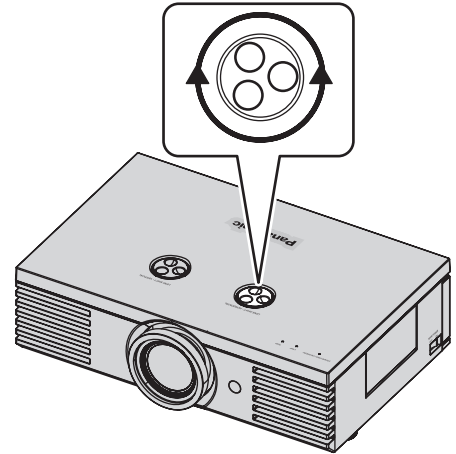
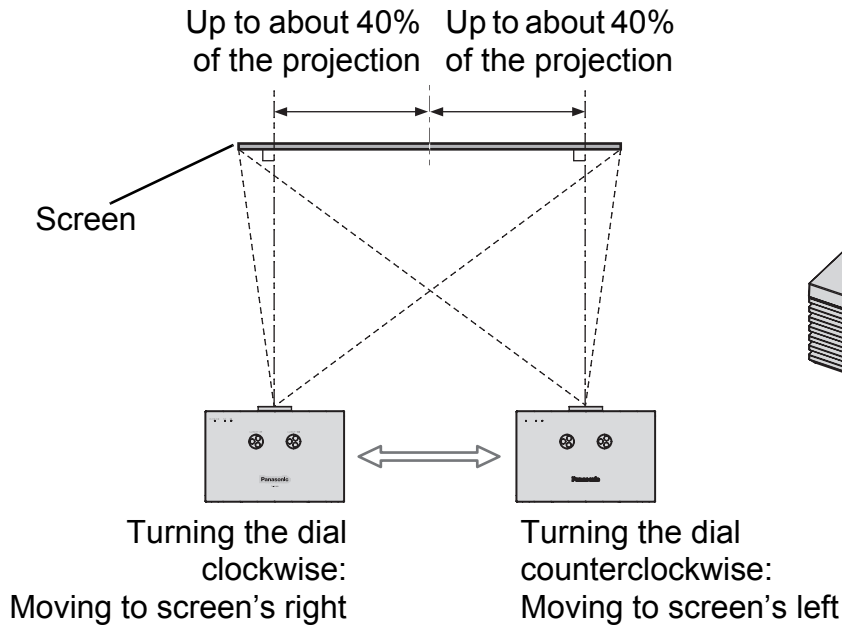

Vertical shift

You can place the projector where the projector lens is up to 100% vertically off-center from the screen and then adjust the image position with the **Lens shift dial • Vertical**.

Turning the dial counterclockwise:
Moving to screen's bottom

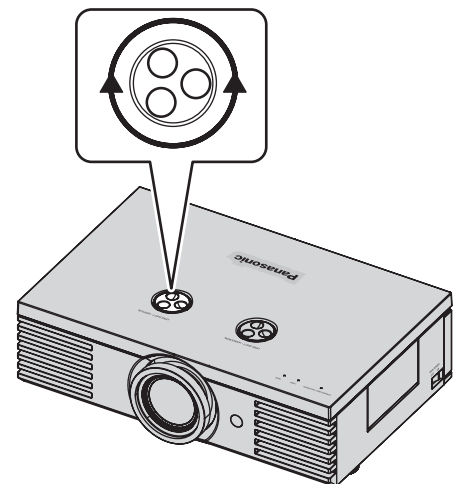
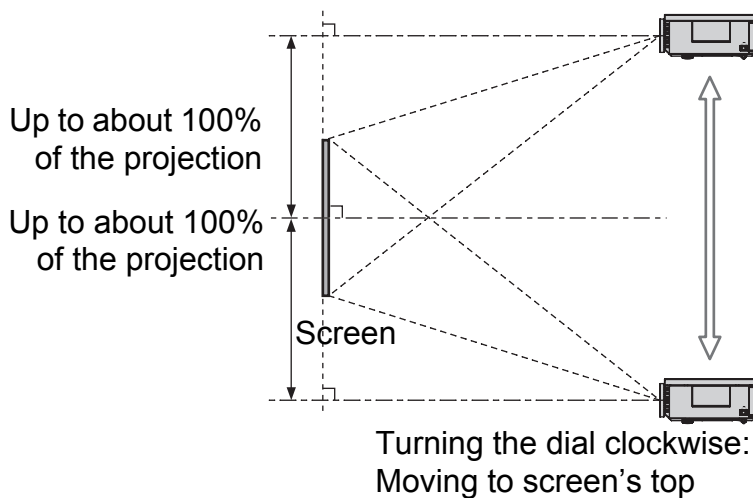

Projector location range

You can determine where to locate the projector by considering the **Lens shift dials** possibilities. See "Positioning the image" on page 21 for available placement.

After fixing the screen position

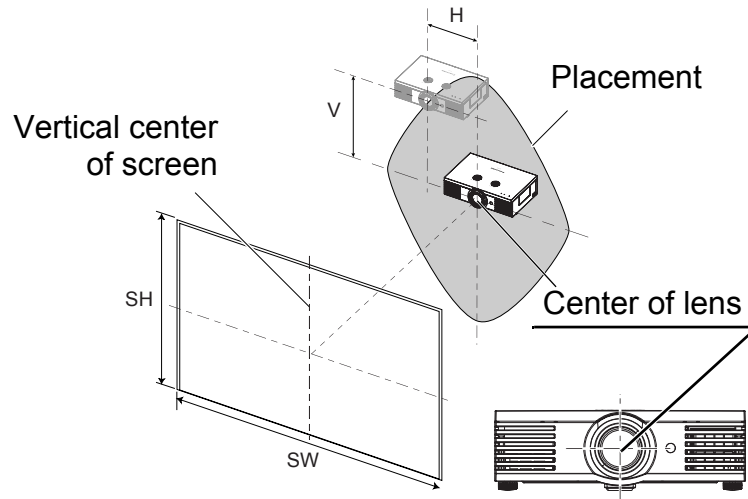

The adjustable projection range

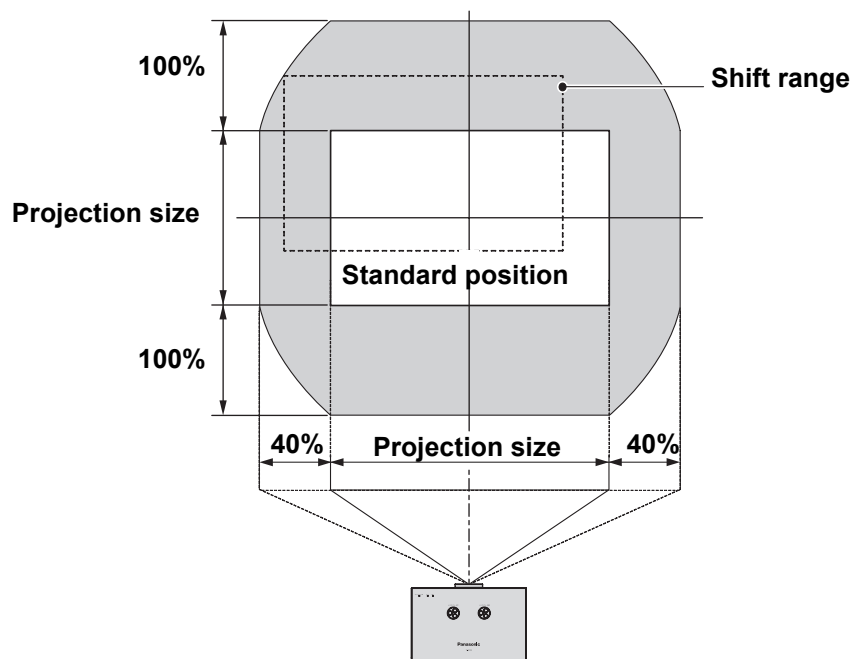

NOTE:

- When the projecting position is fully moved to the vertical limit of the shift range, you cannot move horizontally, likewise when the projecting position is fully moved to the horizontal limit of the shift range, you cannot move vertically.
- When the projector is tilted and you adjust **KEYSTONE**, the center of the screen and the lens need to be realigned.
- Do not force the **Lens shift dials** to turn as this may damage the projector.

Connections

Before connection to the projector

- Read and follow the operating and connecting instructions of each peripheral device.
- The peripheral devices must be turned off.
- Use cables that match each peripheral device to be connected.
- Confirm the type of video signals. See “List of compatible signals” on page 45.
- Audio cables must be connected from each peripheral device directly to the audio reproduction system.

Connecting with COMPONENT/VIDEO/S-VIDEO

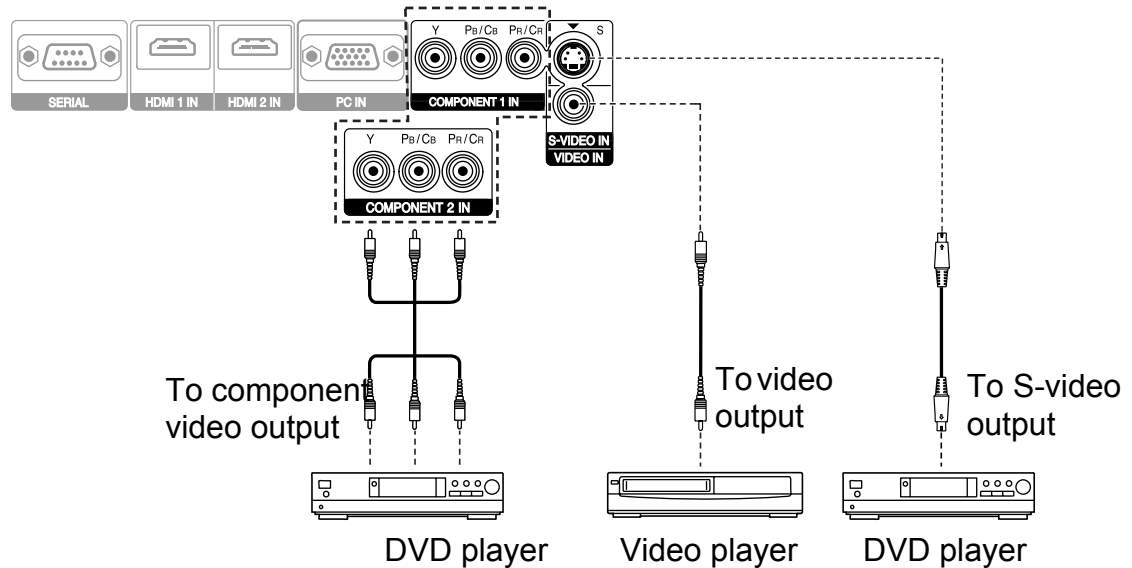

Connecting with HDMI/PC

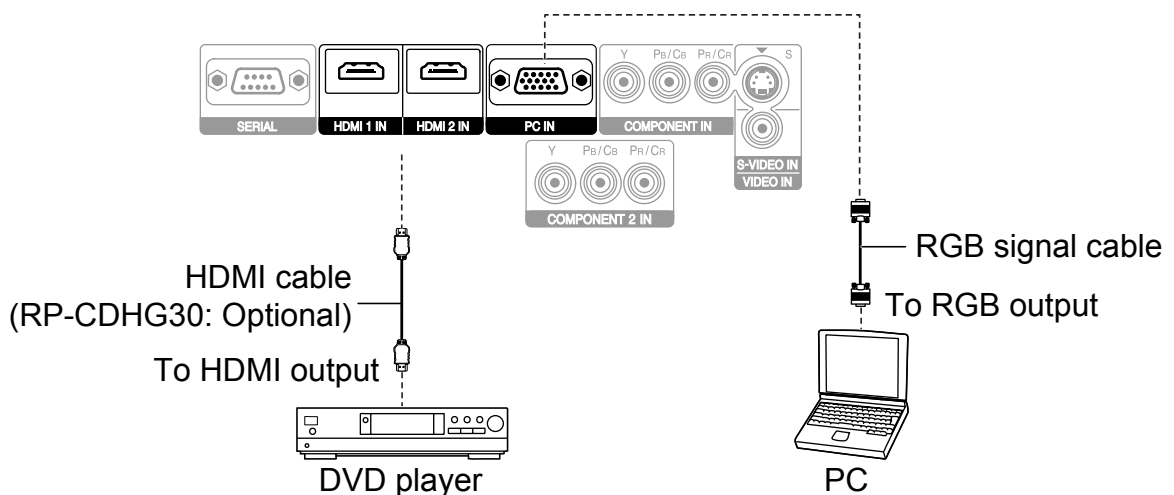

NOTE:

- Make sure the **HDMI** cable is adapted to your **HDMI** device for proper performance.
- A compatible cable is required for an HDMI 1 080p signal.
- It is possible to connect with DVI devices via a HDMI/DVI conversion adapter, but some equipment may not project the image properly or other problems could be encountered. See “Serial terminal” on page 46.

Switching the projector on/off

Power cord

Ensure all the input devices are connected and turned off before connecting the **Power cord**.

Connecting

Make sure to use the **Power cord** which is provided with the projector.

1. Ensure the shape of the power cord plug and the **AC IN** connector on the side of the projector match, then push the plug all the way in.
2. Connect the **Power cord** to a wall outlet.

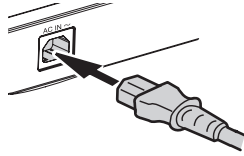

Disconnecting

Make sure the **MAIN POWER** is switched off.

1. Hold the plug and unplug the **Power cord** from the wall outlet.
2. Hold the plug and unplug the **Power cord** from the **AC IN** connector on the side of the projector.

NOTE:

- Do not force the connector as this may damage the projector and/or the power cord.
- Dirt or dust build-up around plugs may cause fire or electrical hazards.
- Switch off the power to the projector when not in use.

POWER indicator

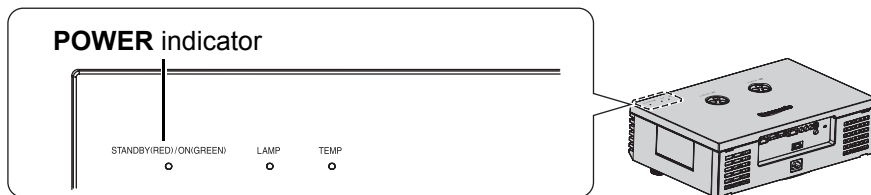

Indicator status		Status
No illumination or flashing		The MAIN POWER is switched off.
RED	Lit	The MAIN POWER is switched on and the projector is in standby.
GREEN	Flashing	The POWER is switched on and the projector is getting ready to project.
	Lit	The projector is ready to project.
ORANGE	Lit	The POWER is switched off and the projector is cooling the lamp.
	Flashing	The POWER is switched on again when cooling the lamp and recovering to projection mode. Recovery may take a while.

NOTE:

- While the projector is cooling the lamp, do not switch the **MAIN POWER** off or unplug the **Power cord**.
- The electric consumption in standby mode is 0.08 W.

Switching the projector on/off

Switching on the projector

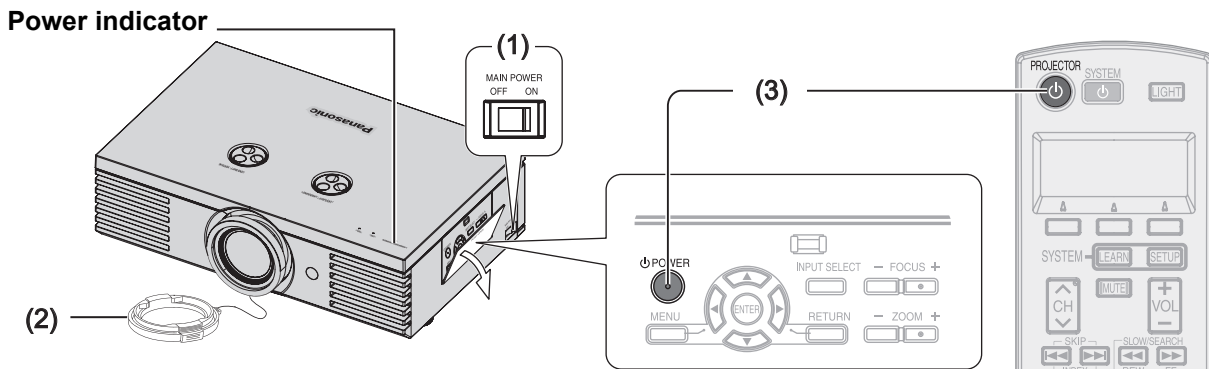

1. Switch the **MAIN POWER** on.
 - The power indicator lights up in **RED**.
2. Remove the **Lens cover** from the lens.
3. Press the **POWER** button.
 - The power indicator lights up in **GREEN** after flashing for a while.
 - The **STARTUP LOGO** is displayed on the screen. See "STARTUP LOGO" on page 38.

NOTE:

- Some small rattling or tinkling sound may be heard when starting up, but this is normal and does not affect the performance of the projector.
- Do not attach anything on the **Lens cover** which may cause burns, fire or damage to the projector.

Switching off the projector

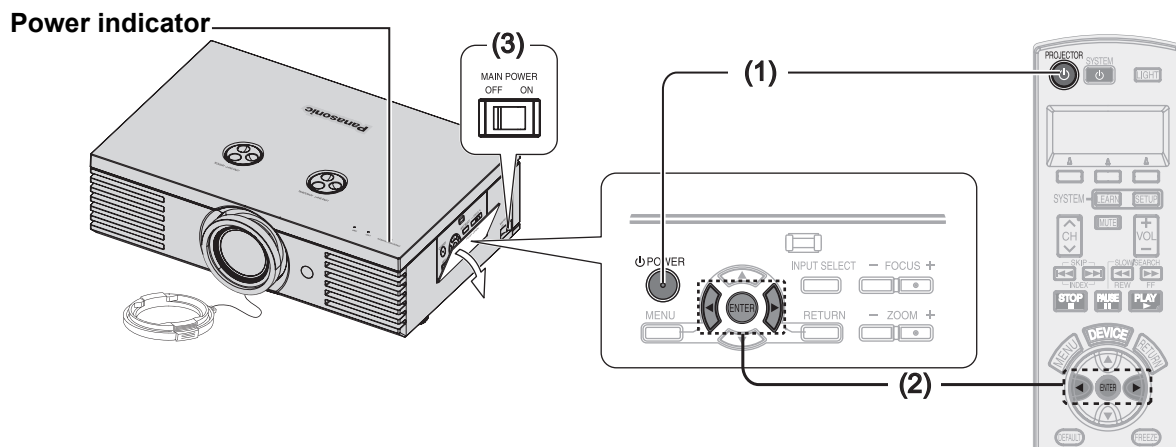

1. Press the **POWER** button.
 - The confirmation screen is displayed.
 - To return to the projection, press **ENTER** to select **CANCEL** or press **MENU/RETURN**.
2. Press **◀** to select **OK** and press **POWER** or **ENTER**.
 - The power indicator lights up in **ORANGE** while cooling the lamp, then illuminates **RED** when it is ready to switch off the **MAIN POWER**.
3. Switch off the **MAIN POWER** on the back of the projector.

NOTE:

- Press the **POWER** twice or for a long duration to switch the power.

Projecting an image

Selecting the input signal

1. Switch on the connected devices.
 - Press the play button of the required device.
2. Press the **INPUT** button to select the required input method if needed. See "Switching the input signal" on page 23.
 - The image will be projected on the screen.

NOTE:

- **AUTO SEARCH** is **ON** as default and the signal from the connected devices is detected automatically. See "AUTO SEARCH" on page 38.

Positioning the image

1. Press **ASPECT** to select the required aspect mode. See "Switching the aspect ratio" on page 23.
2. Adjust the projected image with the **Lens shift dials**. See "Lens shift and positioning" on page 16.
4. Adjust the focus and the projected image size.
 - Press +/- of the **FOCUS** and **ZOOM** buttons to adjust.
 - Press the **LENS** button to adjust the focus and zoom by **Remote control**. see "LENS CONTROL Menu" on page 37

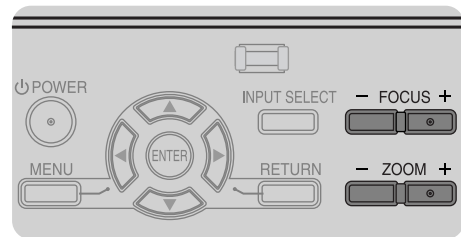
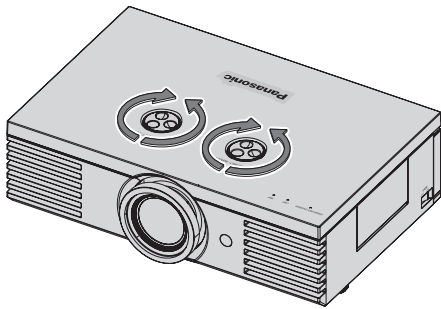

3. Adjust the angle of the projector.
 - Screw down the **Front leg adjuster** and adjust the angle vertically.

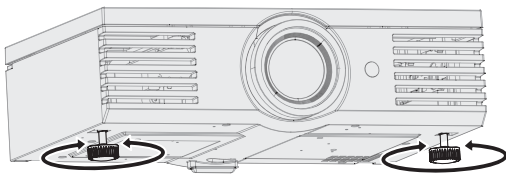

NOTE:

- Do not touch the **Air exhaust port** as this may cause burns or injury.
- If keystone distortion occurs, see "KEYSTONE" on page 36.

Remote control operation

Operating range

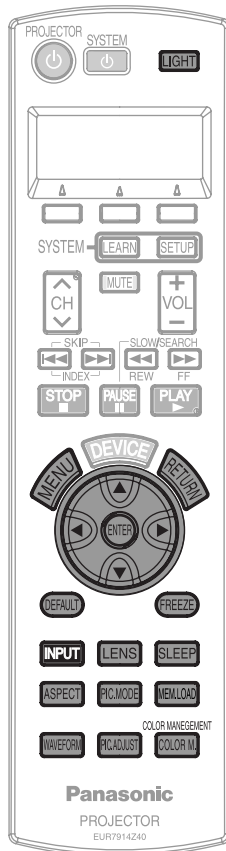

You can operate the projector with the **Remote control** within the remote range 7 m.

● Facing to the projector

Ensure the **Remote control emitter** is facing to the **Remote control signal receptor** on front of the projector and press the required buttons to operate.

● Facing to the screen

Ensure the **Remote control emitter** is facing to the screen and press the required buttons to operate the projector. The signal will be reflected off the screen. The operating range may differ due to the screen material.

NOTE:

- The **Remote control** may malfunction under strong light such as a fluorescent. Do not let strong light shine onto the signal receptor.
- If there are any obstacles between the remote control unit and the receptor, the **Remote control** may not operate correctly.

Turning on the button backlight



In a dark room, you can turn on the button backlight to operate the **Remote control**. Press the button on the upper right corner of the unit to turn on the backlight and enter the light-on mode.

After 30 seconds without any operation, the backlight will go out. Press any but the **LIGHT** button to turn on again. To escape from the light-on mode, press the **LIGHT** button.

Resetting to the factory default settings



You can reset most of the customized settings to the factory defaults by pressing **DEFAULT** button of the **Remote control**. Display the required sub menu or the menu items and press the button again. See "Main menu and Sub-menu" on page 29.

NOTE:

- Some menu items are not available to reset by pressing the **DEFAULT** button. Adjust each menu items manually.

Capturing an image



When projecting an image, press **FREEZE** to capture the projected image and display it on the screen as a still picture. Press again to escape.

NOTE:

- Escaping from the freeze mode is available by pressing any button except the **LIGHT** button.

Switching the input signal



You can switch the input method manually by pressing the **INPUT** button. Press the button several times or press ◀ ▶ to cycle through the input methods as follows. The actual projected image will be changed in a while.

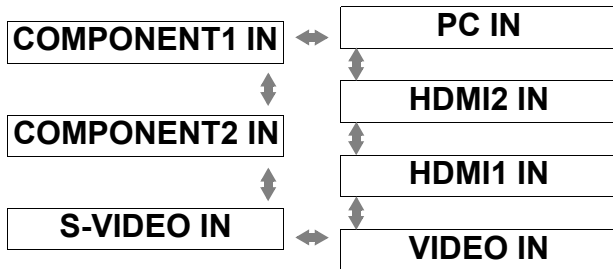

Graphical guidance will be displayed on the upper right of the display and you can confirm the selected input method which is highlighted in yellow. See "INPUT GUIDE" on page 38.

COMPONENT1 IN	Connected to COMPONENT1 IN terminal equipment's signal
COMPONENT2 IN	Connected to COMPONENT2 IN terminal equipment's signal
S-VIDEO IN	Connected to S-VIDEO IN terminal equipment's signal
VIDEO IN	Connected to VIDEO IN terminal equipment's signal
HDMI1 IN HDMI2 IN	Connected to HDMI IN terminal equipment's signal
PC IN	Connected to PC IN terminal equipment's signal

NOTE:

- If you select an unplugged input method, the guidance will blink on and off several times.
- See "List of compatible signals" on page 45.
- See "Connections" on page 18.

Switching the aspect ratio



The aspect ratio is selected automatically, or you can switch it manually by pressing the **ASPECT** button. Press the button several times to cycle through the different aspect type as follows. See "ASPECT" on page 35.

VIDEO/ S-VIDEO/ COMPONENT (YPbPr)	4:3 ↔ ZOOM2
	16:9 ↔ ZOOM1
	14:9 ↔ JUST
PC (RGB)	4:3 ↔ 16:9
HDMI	4:3 ↔ 16:9

NOTE:

- If you project an image with an unmatched aspect ratio, the image may distort or some portions may be cropped. Select an aspect ratio which preserves the intention of the image creator.
- The order of **ASPECT** types is defined not only by the input method but also by the input signals. See "List of compatible signals" on page 45.
- If you project a copyrighted image enlarged or distorted by using **ASPECT** function in commercial use in a public place, such as a restaurant or hotel, you might infringe on the copyright of the creator which is protected by copyright law.

Adjusting the waveform of the input signal



You can monitor if the brightness and contrast level of the input signal is in the recommended range by displaying it in the waveform monitor. See "WAVEFORM MONITOR" on page 32.

1. Project a commercial adjusting signal.
2. Press the **WAVEFORM** button to display the waveform monitor.

OFF	Deactivate the waveform monitor.
FULL SCAN	Monitoring the waveform of brightness and contrast of the whole image.
SINGLE LINE SCAN	Monitoring the waveform of detailed brightness and contrast in each horizontal line of the image. Press ▲ ▼ to select the required line.

3. Press **ENTER** button to select the required adjusting mode.

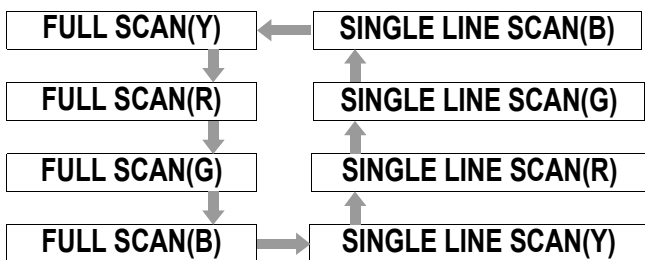

4. Press ▲ ▼ ◀ ▶ to adjust the displaying position of the waveform monitor.
5. Adjust the waveform in each menu.

NOTE:

- When you adjust the **SINGLE LINE SCAN**, the position of the waveform is depends on the position of the selected line.
- When the **WAVEFORM** displayed, the **COLOR MANAGEMENT** is disabled.

Adjusting the waveform

Make sure to adjust to the 0% line first. Any signal level below the recommended range will be forced to 0%.

Adjusting in PICTURE menu

Press **PIC. ADJUST** button to display the **PICTURE** menu and adjust **BRIGHTNESS** (-32 to +32) and **CONTRAST** (-64 to +64) with ◀ ▶.

BRIGHTNESS	Adjust the bottom line of the waveform to 0 % (0/7.5 IRE).
CONTRAST	Adjust the top line of the waveform to 100 % (100 IRE).

Adjusting in ADVANCED menu

Press **PIC. ADJUST** twice to display the **ADVANCED** menu and adjust **BRIGHTNESS** (-16 to +16) and **CONTRAST** (-32 to +32) in red, green and blue with ◀ ▶.

In red	
BRIGHTNESS R	Adjust the bottom line of the waveform to 0 % (0/7.5 IRE).
CONTRAST R	Adjust the top line of the waveform to 100 % (100 IRE).
In green	
BRIGHTNESS G	Adjust the bottom line of the waveform to 0 % (0/7.5 IRE).
CONTRAST G	Adjust the top line of the waveform to 100 % (100 IRE).
In blue	
BRIGHTNESS B	Adjust the bottom line of the waveform to 0 % (0/7.5 IRE).
CONTRAST B	Adjust the top line of the waveform to 100 % (100 IRE).

NOTE:

- When the **Main menu** (except **WAVEFORM** and individually displayed menu item) is displayed, the waveform monitor will be halt.
- When the waveform monitor is displayed, the **Main menu** will be displayed in order not to interfere the waveform monitor.

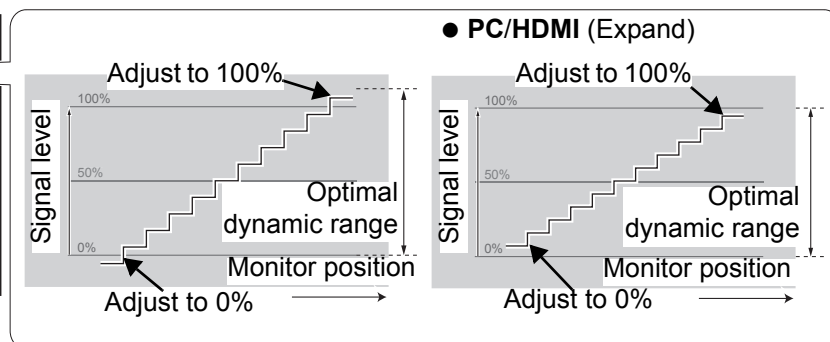
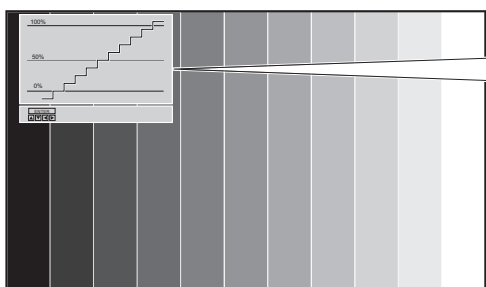

Adjusting the focus and zoom



You can adjust the focus and zoom of the projected image. Press the **LENS** button to

display the **LENS control** menu. See "LENS CONTROL Menu" on page 37.

Switching the picture mode



You can switch the preset picture mode settings by pressing the **PIC. MODE** button. Press the button until the required setting is selected. See "PICTURE MODE" on page 31.

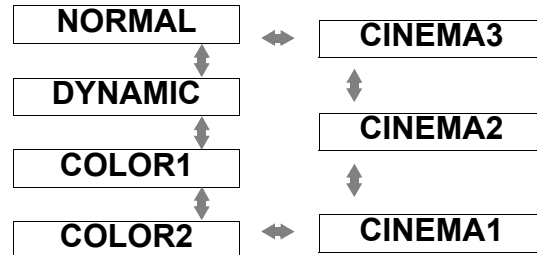

Adjusting the image



You can display one of the **PICTURE** or **ADVANCED** menu items by pressing the **PICTURE ADJUSTMENT** button. Press the button to switch between **PICTURE** and **ADVANCED** menu. Press **▲ ▼** to select the required menu item and **◀ ▶** to adjust.

- **PICTURE menu items**
PICTURE MODE, CONTRAST, BRIGHTNESS, COLOR, TINT, SHARPNESS, COLOR TEMPERATURE and **DYNAMIC IRIS**

- **ADVANCED menu items**
GAMMA, CONTRAST, BRIGHTNESS, NR, MPEG NR, CINEMA REALITY and **TV-SYSTEM**

NOTE:

- For each menu items description, see "PICTURE Menu" on page 31.
- The screen will be cleared after 7 seconds without any operation.

Switching off the projector automatically



You can switch off the **POWER** automatically by setting the **SLEEP** feature. Press the **SLEEP** button several times to cycle through the duration of time. See "SLEEP" on page 39.

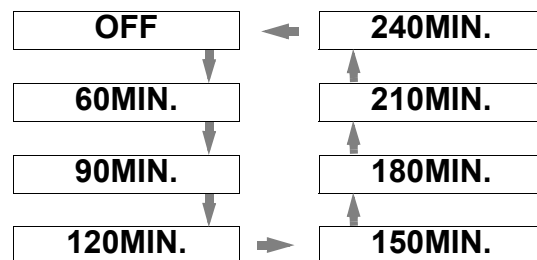

Loading a saved setting



You can access saved settings instantly. See "MEMORY LOAD" on page 33.

1. Select the required setting from **MEMORY1 - 5**.
 - Undefined setting will not be displayed.
2. Press **ENTER** to activate the selected setting.

NOTE:

- If you have not saved any settings, **MEMORY1 - 5** will not be displayed.

Setting your own color profile



You can adjust a selected color individually and save and retrieve under the **PICTURE MODE** setting. Press the **COLOR MANAGEMENT** button to open the menu.

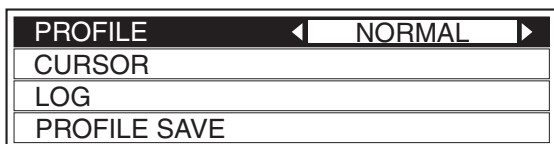

Create a new profile

Adjusting the selected color

Select a color and adjust **COLOR**, **TINT** and **BRIGHTNESS**.

1. Select the **CURSOR** menu and press **ENTER**.
 - The projected image is captured, and the target cursor is displayed.
 - When the **LOG** is fully stored, the target cursor will not be displayed. See "Managing stored logs" on page 26.

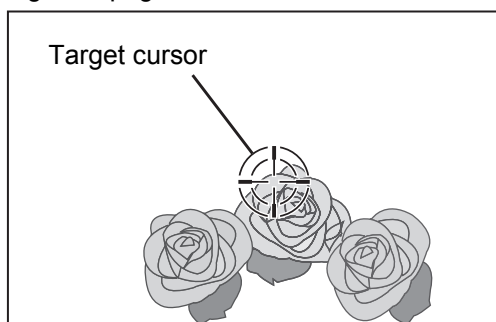

2. Move the cursor with **▲ ▼ ◀ ▶** to the required place to select a color and press **ENTER**.
 - The color at the center of the target cursor is sampled and the sample box is displayed on the left of the cursor. The menu items are displayed on the upper part of the screen.

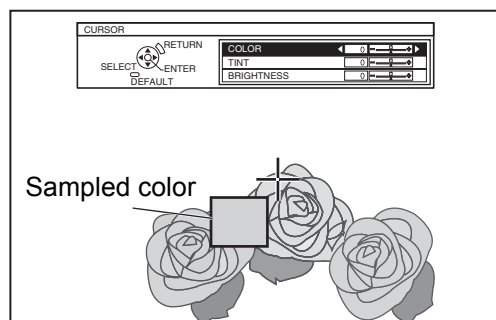

3. Select a menu item and the **◀ ▶** to adjust each item level.
 - The result box is displayed on the right of the cursor and shows the adjusted color.

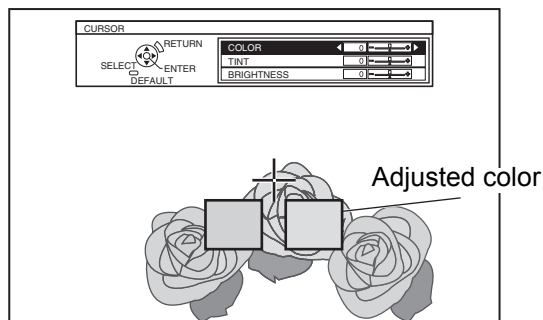

COLOR	Adjust the vividness of the color. Setting range: -30 to +30
TINT	Adjust the color tone. Setting range: -30 to +30
BRIGHTNESS	Adjust the brightness of the color. Setting range: -20 to +20

4. Press **ENTER** to store the adjusted result.
 - "**PROCESSING**" is displayed for a few seconds and the result is stored in **LOG**.
 - You can store up to 8 logs under **LOG** for each **PICTURE MODE** setting.
5. Press **MENU** or **RETURN** to return to the previous menu.
 - Repeat the steps above to store more adjustment.

● Managing stored logs

You can edit or delete the stored logs of the selected **PICTURE MODE**.

1. Select **LOG** and press **ENTER**.
 - The **LOG** menu is displayed.

PICTURE MODE : CINEMA1			
POINT1	0	0	+2
POINT2	-1	0	-2
POINT3	0	+10	0
POINT4	-10	+10	-10
POINT5	-6	+5	+7
POINT6	+3	-3	+1
POINT7	0	+7	+9
POINT8	-1	+14	-4
ALL DELETE			

Sampled color  Adjusted color 

2. Select the required log from 1 - 8 or **ALL DELETE**, and press **ENTER**.
 - Select **CHANGE** to edit the log.
The cursor menu is displayed and you can readjust the color.
 - Select **DELETE** to delete the log.
The confirmation screen will be displayed. Select **OK** to delete.
 - When you select **ALL DELETE**, the "**DELETE ALL LOG.**" screen is displayed. Select **OK** to delete all logs. The **PROFILE** setting will be set to **NORMAL**.

● Saving a log setting as a profile

Return to the **COLOR MANAGEMENT** menu and save the stored log as a profile. Make sure that the **PICTURE MODE** is not switched.

1. Select the **PROFILE SAVE** menu and press **ENTER**.
 - The **PROFILE SAVE** menu is displayed. You can save the profile as **USER1**, **USER2** and **USER3**.

USER1
USER2
USER3

2. Press **ENTER** to save the profile
 - The confirmation screen is displayed. Press **ENTER** again to save.

■ Loading saved profiles

When profiles are loaded under the **PICTURE MODE** setting, you can keep them as you defined until the **PROFILE** is set to **NORMAL**.

1. Select the required **PICTURE MODE** and press **ENTER**.
2. Press the **COLOR MANAGEMENT** button and select the **PROFILE** menu.
 - The profile settings of the selected **PICTURE MODE** will be displayed.
3. Select the required profile and press **ENTER**.

NORMAL	Return to the default setting of the PICTURE MODE
USER1	
USER2	Defined profile settings.
USER3	

NOTE:

- **LOG** and **PROFILE SAVE** are not displayed before you apply **COLOR MANAGEMENT**.
- If you load a profile with a different attribute mode of the profile, the **CURSOR** and **PROFILE SAVE** menus will not be displayed.
- The approximate colors will be adjusted at the same time. If you adjust the exact same color differently, both colors will affect each other and you might get unexpected results.
- White, Black and Grey are not adjustable.
- If you escape the **COLOR MANAGEMENT** menu or attempt to perform another menu action before you save the adjusted profile, the confirmation screen will be displayed.
- If you switch the input signal before you save the profile, the setting will be cancelled without notice.

Menu Navigation

The menu system allows you to access functions which do not have their own dedicated buttons on the **Remote control**. The menu options are structured and categorized. You can navigate through the menu with ▲ ▼ ◀ ▶ buttons.

Navigating through the MENU

Displaying the Main menu



Press **MENU** button to display the **Main menu** and the operating guidance.

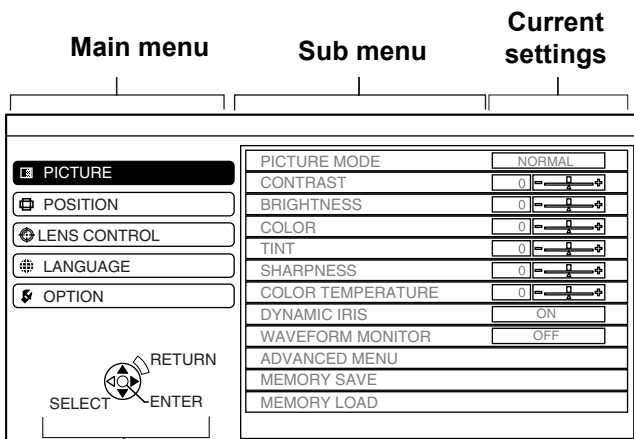

Operating guidance

Contains the required buttons to adjust the settings.

Operating procedure

- Press ▲ ▼ to scroll to the required **Main menu** item and press **ENTER** to select.
 - The selected item is highlighted in orange and the **Sub-menu** is displayed on the right. See “Main menu and Sub-menu” on page 29.
- Press ▲ ▼ to scroll to the required **Sub-menu** item and press ◀ ▶ or **ENTER** to adjust.
 - The selected item is called up and the other menu items disappear from the screen.
 - If there is a lower level, the next level will be displayed.

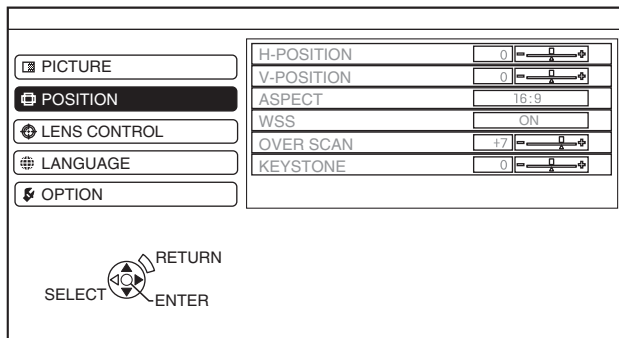

- Press ◀ ▶ to adjust or set the selected item.
 - For items using a bar scale, the current settings are displayed on the left of the bar scale.
 - You can cycle through the options of an item by pressing ◀ ▶.

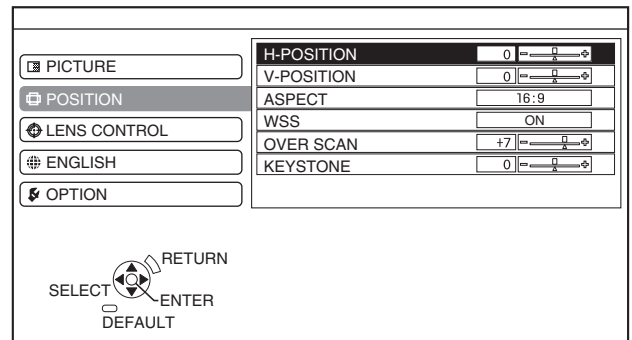

- Press **MENU** or **RETURN** to return to the previous menu.
 - To continue projection, press the button repeatedly until the menu disappears.

About the bar scale items

The triangle mark under the bar indicates factory default setting and the square indicates the current setting.

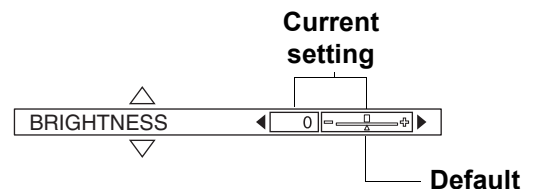

Returning to the previous menu



Press the **MENU** or **RETURN** button to return to the previous menu. Press repeatedly to escape the menu mode and return to the projection.

Main menu and Sub-menu

The **Main menu** has 5 options. Select the required menu item and press **ENTER** to display the **Sub-menu**.

NOTE:

- Some default settings vary by the selected input signal.

PICTURE

See "PICTURE Menu" on page 31.

Sub-menu items	Default setting	Sub-menu items	Default setting
PICTURE MODE	NORMAL	DYNAMIC IRIS	ON
CONTRAST	0	WAVEFORM MONITOR	
BRIGHTNESS	0	ADVANCED MENU	
COLOR	0	MEMORY SAVE	
TINT	0	MEMORY LOAD	
SHARPNESS	0	SIGNAL MODE*1	
COLOR TEMPERATURE	0		

*1. PC/COMPONENT/HDMI signals only

POSITION

See "POSITION Menu" on page 34.

Sub-menu items	Default setting	Sub-menu items	Default setting
H - POSITION	0	WSS*1	ON
V - POSITION	0	OVER SCAN	+7
DOT CLOCK*2	0	KEYSTONE	0
CLOCK PHASE*3	0	AUTO SETUP*4	
ASPECT	16:9*5		

*1. VIDEO/S-VIDEO/COMPONENT signals only

*2. PC signal only

*3. COMPONENT/PC signals only

*4. PC signal only

*5. AUTO for NTSC signals

LENS CONTROL

See "LENS CONTROL Menu" on page 37.

Sub-menu items
ZOOM/FOCUS

Menu Navigation

LANGUAGE

Press ▲ ▼ to select the required language and press **ENTER**.



OPTION

See "OPTION Menu" on page 38.

Sub-menu items	Default setting	Sub-menu items	Default setting
INPUT GUIDE	DETAILED	INSTALLATION	FRONT/DESK
OSD DESIGN	TYPE1	SLEEP	OFF
OSD POSITION	CENTER	ALTITUDE	LOW
BACK COLOR	BLUE	LAMP POWER	NORMAL
STARTUP LOGO	ON	LAMP RUNTIME	
AUTO SEARCH	ON	FUNCTION BUTTON	
HDMI SIGNAL LEVEL	NORMAL		

PICTURE Menu

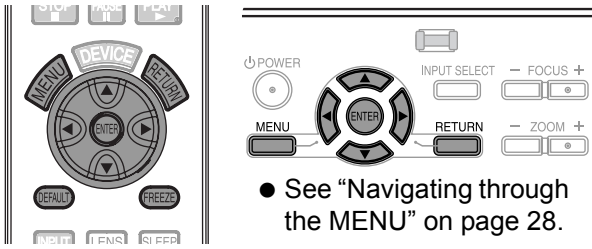

- See “Navigating through the MENU” on page 28.

PICTURE MODE

Depending on the projection environment, you can use these preset parameter settings to optimise image projection. Press ◀ ▶ to cycle through the options.

NORMAL	Setting for a general image, such as sports or games
DYNAMIC	Bright and sharp setting
CINEMA1	Hollywood style colors
CINEMA2	Deeper and more rich color setting
CINEMA3	Vivid and crisp color setting
COLOR1	Setting for HDTV standard in ITU-R BT. 709 and color temperature 6 500K at the default setting of the PICTURE menu items.
COLOR2	Setting for DCDM standard and color temperature 6 300 K at the default setting of the PICTURE menu items.

NOTE:

- It may take for a while until the selected mode is stabilized.

CONTRAST

You can adjust the contrast of the projected image. Adjust the **BRIGHTNESS** in advance if necessary.



- Setting range: -64 to +64

BRIGHTNESS

You can adjust the brightness of the projected image.



- Setting range: -32 to +32

COLOR

You can adjust the color saturation of the projected image.



- Setting range: -32 to +32
- When **PC** is connected, this function is available with 1 125 (1 080)/60i, 1 125 (1 080)/50i, 1 125 (1 080)/60p and 1 125 (1 080)/50p signals only.

TINT

You can adjust the skin tone in the projected image.



- Setting range: -32 to +32
- When **PC** is connected, this function is available with 1 125 (1 080)/60i, 1 125 (1 080)/50i, 1 125 (1 080)/60p and 1 125 (1 080)/50p signals only.

SHARPNESS

You can adjust the sharpness of the projected image.



- Setting range will vary according to the selected input signal

COLOR TEMPERATURE

You can adjust the white balance of the projected image.



- Setting range: -6 to +6

PICTURE Menu

DYNAMIC IRIS

You can switch automatic adjustment of the lamp and the lens iris on/off.

- **ON:** Automatic adjustment
- **OFF:** No adjustment

WAVEFORM MONITOR

You can monitor whether or not the luminance level of the input signal is in the recommended range by displaying it in the waveform monitor. If the waveform is not in the range, adjust it for the best quality. See "Adjusting the waveform of the input signal" on page 24.

<input checked="" type="radio"/> OFF
FULL SCAN(Y)
FULL SCAN(R)
FULL SCAN(G)
FULL SCAN(B)
SINGLE LINE SCAN(Y)
SINGLE LINE SCAN(R)
SINGLE LINE SCAN(G)
SINGLE LINE SCAN(B)
MONITOR POSITION ◀ UPPER LEFT ▶

1. Press ▲ ▼ to move to the required waveform style.
2. Press **ENTER** to select.
 - The **WAVEFORM MONITOR** will be displayed.
3. Adjust the **WAVEFORM MONITOR**.
 - See "Adjusting the waveform of the input signal" on page 24.

ADVANCED MENU

From the **ADVANCED MENU**, you can perform more detailed image adjustment manually.

■ GAMMA

You can adjust linear intensity at 3 levels. Press ◀ ▶ to increase/decrease 1 point.

Levels	Default setting
GAMMA HIGH	0
GAMMA MID	0
GAMMA LOW	0

- Setting range: -8 to +8

■ CONTRAST

You can adjust the amount of contrast in RGB colors individually. Press ◀ ▶ to increase/decrease 1 point.

RGB	Default setting
CONTRAST R	0
CONTRAST G	0
CONTRAST B	0

- Setting range: -32 to +32

■ BRIGHTNESS

You can adjust the brightness in RGB colors individually. Press ◀ ▶ to increase/decrease 1 point.

RGB	Default setting
BRIGHTNESS R	0
BRIGHTNESS G	0
BRIGHTNESS B	0

- Setting range: -16 to +16

■ COLOR MANAGEMENT

You can manage your own defined color settings. See "Setting your own color profile" on page 26.

■ NR (Noise Reduction)

You can switch the automatic noise reduction system on/off. Press ◀ ▶ to select the required setting.

- **ON:** Automatic noise reduction
- **OFF:** No noise reduction

NOTE:

- Applying noise reduction may affect image quality.

MPEG NR

You can switch the automatic noise reduction system for MPEG format images on/off. The system minimizes block noise and mosquito noise to eliminate jagged edges, providing an overall smoother image. Press ◀ ▶ to select the required setting.

- **ON:** Active
- **OFF:** Deactive

NOTE:

- **MPEG NR** is for MPEG images only.
- **MPEG NR** is not available with **PC** and **HDMI (VGA60)** signals.

CINEMA REALITY

You can switch the automatic image synchronizer on/off for 24 frames a second images, such as movies. Press ◀ ▶ to select the required setting.

- **ON:** Active
- **OFF:** Deactive

NOTE:

- **CINEMA REALITY** is available with interlace signals only.
- If the **CINEMA REALITY** is different from the required setting of the image, select **OFF**.

TV-SYSTEM

When the video signal is changed, the setting switches automatically.

You can switch the setting manually to match the video data. Press ◀ ▶ to cycle through the options.

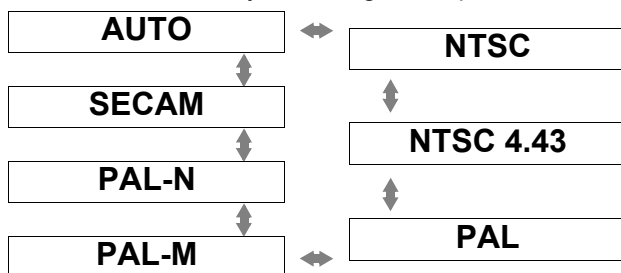

MEMORY SAVE

You can save the adjusted **PICTURE** settings with up to 5 in each of 2 signal groups.

1. Adjust the different items of the **PICTURE** menu.
2. Select **MEMORY SAVE** and press **ENTER**.
3. Select **MEMORY1 - 5** to save and press **ENTER**.
 - The confirmation screen is displayed.
 - ★ : In use
 - ☆ : Not in use
 - Select **ALL DELETE** to clear all the saved settings.
4. Select **OK** and press **ENTER**.
 - To cancel, select **CANCEL** and press **ENTER**, or press the **RETURN** button.

VIDEO, S-VIDEO, COMPONENT, HDMI (not including VGA60), 1 125 (1 080)/50i, 1 125 (1 080)/60i, 1 125 (1 080)/50p and 1 125 (1 080)/60p signals in PC connection	MEMORY1 - 5
VGA60 in HDMI connection, PC not including 1 125 (1 080)/50i, 1 125 (1 080)/60i, 1 125 (1 080)/50p and 1 125 (1 080)/60p	MEMORY1 - 5

MEMORY LOAD

You can access saved settings instantly. See "Loading a saved setting" on page 25.

1. Select the required setting from **MEMORY1 - 5**.
 - Undefined setting will not be displayed.
2. Press **ENTER** to activate the selected setting.

NOTE:

- If you have not saved any settings, **MEMORY1 - 5** will not be displayed.

SIGNAL MODE

The current selected signal is displayed when **PC/COMPONENT/HDMI** equipment is connected.

NOTE:

- See "List of compatible signals" on page 45.

POSITION Menu

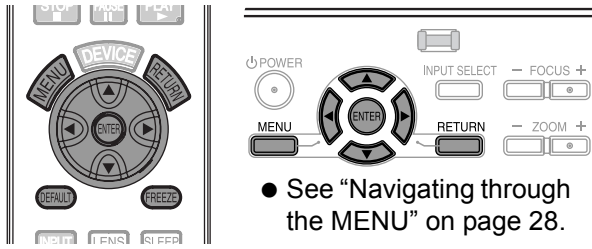

H - POSITION

You can move the projected image horizontally for fine adjustment.

Move
left



Move
right

V - POSITION

You can move the projected image vertically for fine adjustment.

Move
down



Move
up

DOT CLOCK

If you have interference patterns on the projected image, which is sometimes referred to as moire or noise, you can minimize it by pressing ◀ ▶ to adjust the clock frequency.

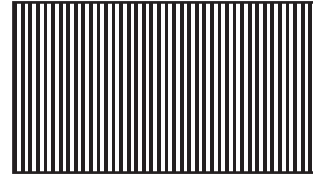

NOTE:

- If the projecting signal's dot clock frequency is higher than 150 MHz, the adjustment may not make a difference.

CLOCK PHASE

If you require further adjustment for the same reason as the **DOT CLOCK** adjustment, you can fine adjust the timing of the clock. Press ◀ ▶ to adjust.

NOTE:

- If the projecting signal's dot clock frequency is higher than 150 MHz, the adjustment may not make a difference.
- **CLOCK PHASE** is available with **PC** signals, and 1 125 (1 080)/50i, 1 125 (1 080)/60i, 1 125 (1 080)/50p, 1 125 (1 080)/60p, 1 125 (1 080)/24p, 750 (720)/50p and 750 (720)/60p signals of **COMPONENT** connection.

ASPECT

You can switch the aspect ratio manually when needed.

Aspect ratio options and projection example

If you apply the aspect ratio options to the projected image, the result will be as follows. The result may differ due to the input signals. See "Switching the aspect ratio" on page 23.

VIDEO/S-VIDEO/COMPONENT

Not available with 1 125 (1 080)/50i, 1 125 (1 080)/60i, 1 125 (1 080)/50p, 1 125 (1 080)/60p, 1 125 (1 080)/24p, 750 (720)/50p and 750 (720)/60p signals.

Original size		4:3	Squeeze signal	16:9 Letter box	14:9 Letter Box	2.35:1 Cinescope
4:3	Projects at 4:3.					
4:3	Projects at 4:3.					
16:9	Adjusts horizontally to 16:9.					
16:9	Adjusts horizontally to 16:9.					
JUST	Adjusts horizontally to fit 16:9. Closer to edge, more enlarged. Not available with PC signals.					
JUST	Adjusts horizontally to fit 16:9. Closer to edge, more enlarged. Not available with PC signals.					
ZOOM/ ZOOM1	Adjusts to 16:9 size with preserving original ratio. Escape the menu mode and press ▲▼ to adjust vertically.					
ZOOM/ ZOOM1	Adjusts to 16:9 size with preserving original ratio. Escape the menu mode and press ▲▼ to adjust vertically.					
ZOOM2	Adjusts to cinescope size not including letter box. Escape the menu mode and press ▲▼ to adjust vertically.					
ZOOM2	Adjusts to cinescope size not including letter box. Escape the menu mode and press ▲▼ to adjust vertically.					
14:9	Adjusts to 14:9.					
14:9	Adjusts to 14:9.					

COMPONENT signals

Available with 1 125 (1 080)/50i, 1 125 (1 080)/60i, 1 125 (1 080)/50p, 1 125 (1 080)/60p, 1 125 (1 080)/24p, 750 (720)/50p and 750 (720)/60p signals

Original Size		4:3	16:9	Cinescope
H - FIT	Adjusts horizontally to 16:9.			
H - FIT	Adjusts horizontally to 16:9.			
V - FIT	Adjusts to 16:9 vertically. Escape and press ▲ ▼ to scroll the image to adjust the edge vertically.			
V - FIT	Adjusts to 16:9 vertically. Escape and press ▲ ▼ to scroll the image to adjust the edge vertically.			
ZOOM	Adjusts to 16:9 size with preserving original ratio. Escape the menu mode and press ▲▼ to adjust vertically.			
ZOOM	Adjusts to 16:9 size with preserving original ratio. Escape the menu mode and press ▲▼ to adjust vertically.			

POSITION Menu

Aspect ratio depend on signals

Press ◀ ▶ to cycle through the aspect ratio options. The cycle pattern depends on the connected signals.

VIDEO/ S-VIDEO	<ul style="list-style-type: none"> ● 4:3 → 16:9 → 14:9 → JUST → ZOOM1 → ZOOM2 ● AUTO → 4:3 → 16:9 → JUST → ZOOM <p>NTSC signal</p>
PC (RGB)	<ul style="list-style-type: none"> ● 4:3 → 16:9 ● 4:3 → 16:9 <p>VGA or SVGA signals</p> <ul style="list-style-type: none"> ● Not switchable <p>WIDE480/600/720/768/768-2/800/900 signals</p>
HDMI	<ul style="list-style-type: none"> ● 4:3 → 16:9 ● 16:9 → H - FIT → V - FIT → ZOOM <p>1 125 (1 080)/50i, 1 125 (1 080)/60i, 1 125 (1 080)/50p, 1 125 (1 080)/60p, 1 125 (1 080)/24p, 750 (720)/50p and 750 (720)/60p signals</p> <ul style="list-style-type: none"> ● 4:3 → 16:9 → JUST → ZOOM <p>525p (480p) and 625p (576p) signals</p>
COMPONENT (YPbPr)	<ul style="list-style-type: none"> ● 4:3 → 16:9 → 14:9 → JUST → ZOOM1 → ZOOM2 <p>625i (576i), 625p (576p)</p> <ul style="list-style-type: none"> ● AUTO → 4:3 → 16:9 → JUST → ZOOM <p>525i (480i), 525p (480p)</p> <ul style="list-style-type: none"> ● 16:9 → H - FIT → V - FIT <p>1 125 (1 080)/50i, 1 125 (1 080)/60i, 1 125 (1 080)/50p, 1 125 (1 080)/60p, 1 125 (1 080)/24p, 750 (720)/50p, 750 (720)/60p signals</p>

WSS

WSS (Wide Screen Signalling) detects if a **PAL/625p (576p)/625i (576i)** signal is input and that signal has an identification signal, and switch the aspect ratio to required setting automatically. You can switch the system off manually.

OVER SCAN

If the 4 edges of an image is partly dropped, you can use this function to adjust and project it properly.



- Setting range: 0 to +10
- **OVER SCAN** is not available with **PC** signals.

KEYSTONE

If the projector is aligned non-perpendicularly to the screen, or if the projection screen has an angled surface, you can vertically correct keystone.

Image	Operation

- Setting range: -32 to 32

NOTE:

- You can correct the distortion ± 30 degrees from the vertical plane. For a better quality image, installing the projector with a minimum of distortion is recommended.
- Some distortion may be retained for **Lens shift** adjustment.
- The distortion of the **Main menu** screen is not correctable.
- The result of the keystone correction will affect the aspect ratio and the size of the image.

AUTO SETUP

You can adjust **V - POSITION**, **H - POSITION**, **DOT CLOCK** and **CLOCK PHASE** automatically when connecting via **PC**. Press **ENTER** to adjust these at the same time.

LENS CONTROL Menu

ZOOM/FOCUS

You can use the 2 different test patterns to adjust the focus and zoom of the image. See “Lens shift and positioning” on page 16.

1. Press **ENTER** to display test pattern 1.
 - Press ▲ ▼ to adjust the focus and ◀ ▶ to adjust the zoom.

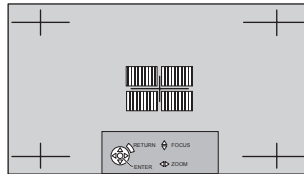

2. Press **ENTER** to display test pattern 2.
 - Press ▲ ▼ to adjust the focus and ◀ ▶ to adjust the zoom.

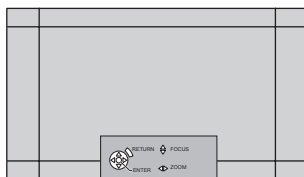

3. Press **ENTER** to display the projected image.
 - You can confirm the adjustment is fit to the projected image.
4. Press **MENU** or **RETURN** to return to the previous menu, or press repeatedly to escape the menu mode.

NOTE:

- When the projector and/or the screen is tilted, adjust the focus at the center of the image. The upper and lower edge might be out of focus.
- When the image is distorted in keystone, adjust the **KEYSTONE** in **POSITION** menu.

OPTION Menu

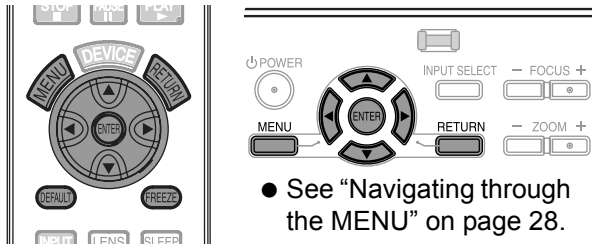

INPUT GUIDE

When you press **INPUT** or the **INPUT SELECT** button to change the input method, the guidance appears in the upper right corner of the screen. The following display methods are available. Press ◀ ▶ to cycle through the options.

Options	Function
OFF	Turn off the guidance.
SIMPLE	Display the input method by text. The INPUT GUIDE will go out after 5 seconds without any operation.
DETAILED	Display the input method by graphic. The INPUT GUIDE will go out after 10 seconds without any operation.

OSD DESIGN

You can change the background color of the menu. Press ◀ ▶ to cycle through the options.

Options	Function
TYPE1	Semi transparent black
TYPE2	Solid blue
TYPE3	Semi transparent dark blue

OSD POSITION

You can change the position where to display the menu. Press ◀ ▶ to cycle through the options.

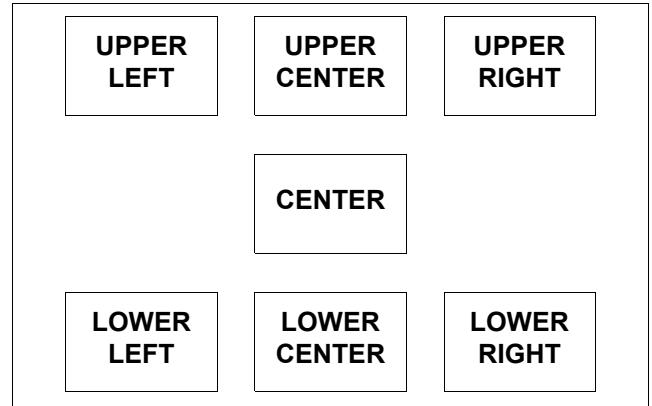

BACK COLOR

You can choose a **BLUE** or **BLACK** screen for when the projector is idle. Press ◀ ▶ to select an option.

STARTUP LOGO

You can switch the logo on/off that is displayed when starting up the projector. Press ◀ ▶ to select an option.

- **ON:** Active
- **OFF:** Deactive

AUTO SEARCH

When the projector is turned on, the input terminals are detected and an input signal is selected automatically. You can switch the system on/off. Press ◀ ▶ to select an option.

- **ON:** Active
- **OFF:** Deactive

NOTE:

- When no signal is detected, the last used input will be selected.

HDMI SIGNAL LEVEL

When an **HDMI** is selected, you can switch the **HDMI** signal level **NORMAL** or **EXPAND** to display the image. Press ◀ ▶ to select an option.

NOTE:

- **HDMI SIGNAL LEVEL** is not available with some equipments.

INSTALLATION

When installing the projector, select the projection method according to the projector position. Press ◀ ▶ to cycle through the options. See “Projection method” on page 15.

FRONT/DESK	Setting on a desk/floor and projecting from front
FRONT/CEILING	Mounting in the ceiling and projecting from front
REAR/DESK	Setting on a desk/floor and projecting from rear
REAR/CEILING	Mounting in the ceiling and projecting from rear

SLEEP

You can select the required duration of time and set the off timer to turn off the **POWER** of the projector automatically. 3 minutes before turn-off, the countdown of minutes will be displayed in the lower right corner. Press ◀ ▶ to cycle through the options. See “Switching off the projector automatically” on page 25.

ALTITUDE

If you use the projector at high elevations, set the fan speed to **HIGH**. Press ◀ ▶ to select **HIGH** or **LOW**.

NOTE:

- At 1 400 m (4593 ft) above sea level, the setting must be **HIGH**.

LAMP POWER

You can adjust the power of the lamp to save on electricity, prolong the lamp life and reduce the noise.

Options	Function
NORMAL	When higher luminance is required such as movies
ECO - MODE	When lower luminance is sufficient such as in a small room

NOTE:

- When no input signal is detected, the function is disabled.

LAMP RUNTIME

You can check how long the lamp has been used.

NOTE:

- **LAMP RUNTIME** is a relevant matter for lamp replacement timing. See “Care and Replacement” on page 41.

FUNCTION BUTTON

You can assign frequently used functions to each function button and access the functions instantly.

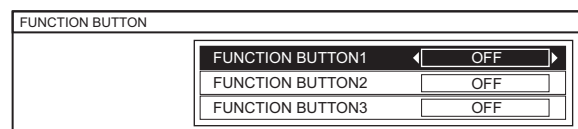

1. Press ▲ ▼ to select the required button to assign.
2. Press **ENTER**.
3. Press ◀ ▶ to select the required function to assign.
4. Press **RETURN** or **MENU** to return to the previous menu, or press repeatedly to return to the projection.

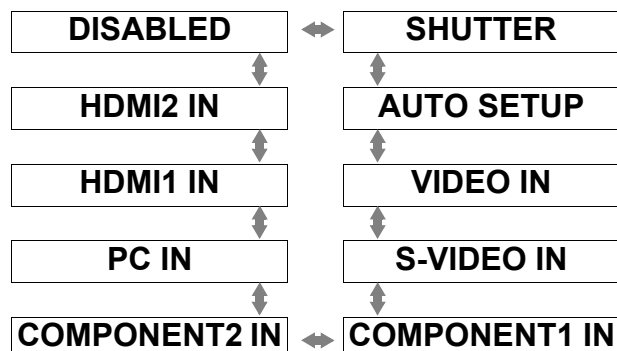

● SHUTTER function

You can turn off the lamp and stop the projection temporary for electrical power save. Press any button except the **LIGHT**, **DEVICE** or **Learning Remote control buttons** to return to the projection.

NOTE:

- See “Selecting the input signal” on page 21, “AUTO SETUP” on page 36.
- The function buttons are also used as Learning Remote control buttons. Press the **DEVICE** button to switch the control mode. See “Remote Control Operating Guide” provided with the projector.

TEMP and LAMP Indicators

Controlling alerts

If a problem should occur with the projector, the **TEMP** and/or **LAMP** indicators will alert you. Respond to the alert as follows.

1. Confirm the **POWER** indicator status and turn off the projector in the proper way.
2. Find out the cause of the problem.
3. Follow the instructions for each indication below and solve the problem.
4. Turn on the projector in the correct way and confirm the indicator is not indicating a problem any longer.

NOTE:

- If no problem is found or the problem remains, do not turn on the projector. Instead contact an Authorized Service Center.

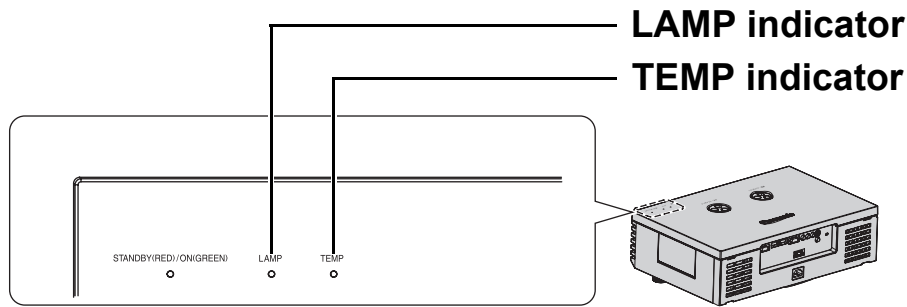

TEMP indicator

Indicator and projector	<ul style="list-style-type: none"> ● Illuminating RED and still projecting ● Flashing RED and POWER is turned off 		
Problem	The temperature inside and/or outside the projector is abnormally high.		
Cause	The ventilation ports are covered.	The room temperature is too high.	The Air filter is excessively dirty and the ventilation is poor.
Remedy	Remove the object(s) from the ventilation ports or clear around the projector.	Reinstall the projector at a temperature controlled place. See "Setting up" on page 14.	Clean or replace the Air filter in the proper way. See "Cleaning the Air filter" on page 41.

LAMP indicator

Indicator	● Illuminating RED	● Flashing RED
Problem	LAMP RUNTIME has reached 1 800 hours (with LAMP POWER set to NORMAL).	LAMP circuit failure, abnormal function or LAMP is damaged.
Cause	Lamp unit will run out soon and needs to be replaced.	The projector is switched off incorrectly.
Remedy	Replace the Lamp unit . See "Before replacing the Lamp unit" on page 42.	<ul style="list-style-type: none"> ● Let the LAMP cool down and turn on the projector. ● If the POWER does not turn on, contact an Authorized Service Center.

Maintenance

Care and Replacement

Before cleaning

- Ensure the projector is switched off.
- Unplug all the cables from the projector.

Cleaning your projector

Cleaning the outer surface of the projector

Wipe off dirt and dust gently with a soft cloth.

- If it is difficult to remove the dirt, soak a cloth in a neutral detergent diluted with water, wring the cloth well and then wipe the projector. Dry off the projector with dry cloth.
- If you use a chemical treated wipe, follow the instructions supplied with it.

Cleaning the lens surface

Wipe off dirt and dust gently with a lint-free cloth.

- Make sure no dirt or dust remains on the surface of the lens. It will be enlarged and projected onto a screen.

Cleaning the Air filter

If the **Air filter** is excessively dirty, the internal temperature of the projector increases and may cause malfunction. Clean the **Air filter** regularly every 100 hours of usage.

1. Place a finger at the bottom of the **Air filter**.
2. Slightly push up and pull out the **Air filter** to remove.

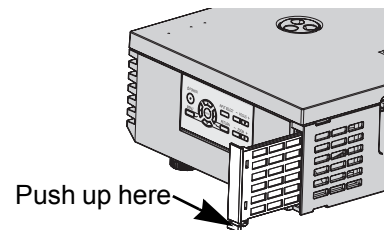

3. Vacuum dirt and dust from the **Air filter**.
 - Do not wash the **Air filter**.

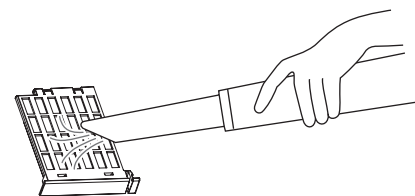

4. Place and slightly slide in the **Air filter** in the **Air intake port** to attach.
 - Make sure the **Air filter** clicks into the place.

NOTE:

- Do not use the projector without attaching the **Air filter**.

Replacing the Air filter

The **Air filter** should be replaced when cleaning is ineffective and when replacing the **Lamp unit**. An replacement **Air filter** is provided with a replacement lamp unit, ET-LAE1000. Contact an Authorized Service Center for the optional **Air filter**.

Care and Replacement

Before replacing the Lamp unit



- Ensure the projector is switched off.
- Unplug all the cables from the projector.
- Prepare a Phillips-head screwdriver.
- Contact an Authorized Service Center to purchase a replacement **Lamp unit** (ET-LAE1000).

NOTE:

- Prior to replacing the lamp unit, allow it to cool down to prevent the risk of burns, damage and other hazards.
- Do not attempt replacement with an unauthorized lamp unit.

When to replace the Lamp unit

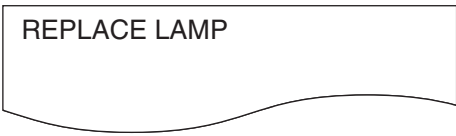
The **Lamp unit** is consumable and the brightness decreases by duration of usage. The **LAMP** indicator will alert you of the replacement timing at 1 800 hours, and at 2 000 hours, the projector will be turned off. 1 800 or 2 000 hours is a rough guidance and might be shortened by the usage conditions, characteristics of the lamp unit, environmental conditions, and so on. You can check the duration of usage time using **LAMP RUNTIME** in the **OPTION** menu.

Indication	On screen	LAMP indicator
		
Over 1 800 hours	"REPLACE LAMP" is displayed on the upper left of the screen for 30 seconds. To clear the screen immediately, press any button.	Illuminates RED
Over 2 000 hours	"REPLACE LAMP" is displayed on the upper left of the screen, and until you respond it will stay. To clear the screen, press any button.	

NOTE:

- The guide times, 1 800 and 2 000 hours, are rough estimates based on certain conditions and is not a guaranteed time. The estimated condition is: **LAMP POWER** in **OPTION** menu set to **NORMAL**.
- To prolong the lamp life, set the **LAMP POWER** in **OPTION** menu to **ECO - MODE**. See "LAMP POWER" on page 39.
- For more information about the **Lamp unit**, such as guaranteed time, see the "Replacement Instructions" provided with the **Lamp unit**.

Replacing the lamp unit

Opening the top cover

1. Turn off the **MAIN POWER** switch according to the procedure "Switching the projector on/off" on page 19 and disconnect the power cord plug from the wall outlet.
 - Make sure the **Lamp unit** and the surroundings are cooled enough.
2. Open the top cover of the projector and remove aside.
 - Hold the top cover up and press one of the buttons of the hinge parts each to remove.

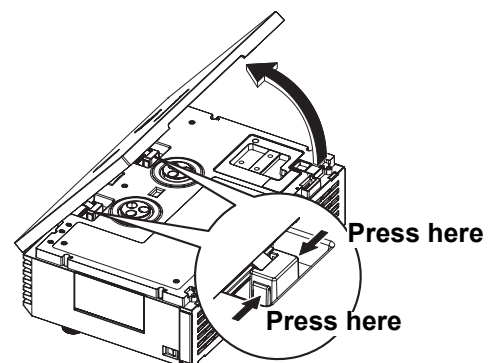

Removing and replacing the lamp unit

1. Use a Phillips screw driver to loosen the 3 lamp unit fixing screws until the screws turn freely.
2. Hold the handle of the lamp unit and release the lamp unit lock.
3. Pull out the lamp unit gently from the projector.
4. Replace the new lamp unit while making sure that the direction of insertion is correct.
 - Press the top of the lamp unit and make sure the unit is installed securely.
5. Tighten the lamp unit fixing screws securely with a Phillips screwdriver.

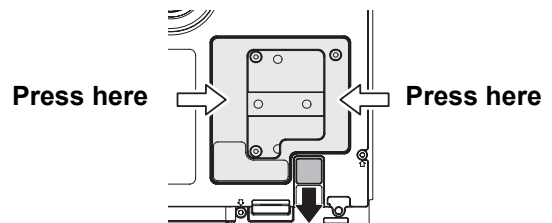
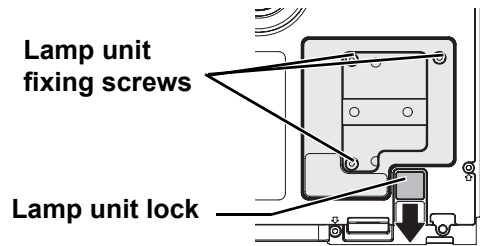

Attaching the top cover

1. Attach the hinge parts of the top cover to the projector and press slightly until it clicks.
2. Hook the tabs of the top cover to the projector and lift down slowly.
3. Press the back corner of the top cover gently until it clicks.

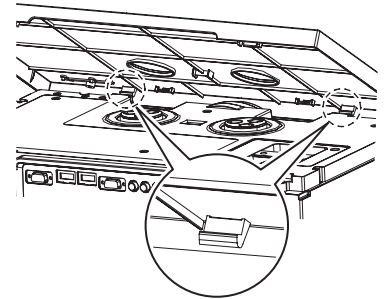

NOTE:

- Be sure to install the lamp unit and the top cover of the projector securely. If they are not securely installed, it may cause the protection circuit to operate so that the power cannot be turned on.
- Grip the handle and keep the lamp unit paralleled when you remove the **Lamp unit**. Some parts of the lamp unit are sharpened and may cause injury.
- Do not switch the power on while the top cover is opened.
- When the projector is mounted in the ceiling, keep the lamp unit paralleled and remove.

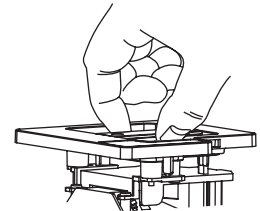

Resetting the LAMP RUNTIME

If the lamp usage time has passed 2 000 hours (when **LAMP POWER** has been set to **NORMAL**), the projector will switch to standby mode after approximately 10 minutes of operation. The resetting procedure should thus be completed within 10 minutes. See "LAMP RUNTIME" on page 39.

1. Connect the **Power cord** to the projector and a wall socket, and switch the **MAIN POWER** on.
2. Switch the **POWER** button.
3. Press the **MENU** button to display the menu.
4. Press **▲ ▼** to select **OPTION** and press **ENTER**.
5. Press **▲ ▼** to select **LAMP RUNTIME**.
6. Press and hold the **ENTER** button for approximately 3 seconds.
7. The confirmation screen will be displayed and select **OK**.
8. Switch off the **POWER** to reset the duration of the **LAMP RUNTIME**.
9. Confirm the duration of time in **LAMP RUNTIME** is reset to "0".

ALTITUDE	LOW
LAMP POWER	NORMAL
LAMP RUNTIME	1820H
FUNCTION BUTTON	

Troubleshooting

Should any problem persist, contact your dealer.

Problem	Cause	Reference page
Power does not turn on.	● The power cord may not be connected.	19
	● The MAIN POWER switch is turned off.	20
	● No electric supply is at the wall outlet.	19
	● TEMP indicator is lit or flashes.	40
	● LAMP indicator is lit or flashes.	40
	● The lamp unit cover has not been securely installed.	42
No picture appears.	● The video signal input source may not be connected to a terminal properly.	18
	● The input selection setting may not be correct.	21
	● The BRIGHTNESS adjustment setting may be at the minimum setting.	31
	● The SHUTTER function may be in use.	46
The picture is fuzzy.	● The lens cover may still be attached to the lens.	12
	● The lens focus may not have been set correctly.	16
	● The projector may not be at the correct distance from the screen.	14
	● The lens may be dirty.	41
	● The projector may be tilted too much.	15
The color is pale or greyish.	● COLOR or TINT adjustment may be incorrect.	31
	● The input source which is connected to the projector may not be adjusted correctly.	21
The Remote control does not operate.	● The batteries may be weak.	11 22
	● The batteries may not have been inserted correctly.	
	● The remote control signal receptor on the projector may be obstructed.	
	● The remote control unit may be out of the operation range.	
The picture does not display correctly.	● The signal format (TV-SYSTEM) may not have been set correctly.	33
	● There may be a problem with the VCR or other signal source.	-
	● A signal which is not compatible with the projector is being input.	45
Picture from a computer does not appear.	● The cable may be too long.	-
	● The external video output from a laptop computer may not be correct. (You may be able to change the external output settings by pressing the [Fn] + [F3] or [Fn] + [F10] keys simultaneously. The actual method varies depending on the type of computer; refer to the documentation provided with your computer for further details.)	-

Technical Information

List of compatible signals

Mode	Display resolution (dots) ^{*1}	Scanning frequency		Dot clock frequency (MHz)	Picture quality ^{*2}	Format
		H (kHz)	V (kHz)			
NTSC/NTSC 4.43/ PAL-M/PAL60	720 x 480i	15.7	59.9		A	VIDEO/S-VIDEO
PAL/PAL-N/SECAM	720 x 576i	15.6	50.0		A	VIDEO/S-VIDEO
525i (480i)	720 x 480i	15.7	59.9	13.5	A	COMPONENT
625i (576i)	720 x 576i	15.6	50.0	13.5	A	COMPONENT
525p (480p)	720 x 483	31.5	59.9	27.0	A	COMPONENT/HDMI
625p (576p)	720 x 576	31.3	50.0	27.0	A	COMPONENT/HDMI
1 125 (1 080)/60i	1 920 x 1 080i	33.8	60.0	74.3	AA	COMPONENT/PC/HDMI
1 125 (1 080)/50i	1 920 x 1 080i	28.1	50.0	74.3	AA	COMPONENT/PC/HDMI
1 125 (1 080)/24p	1 920 x 1 080	27.0	24.0	74.3	AA	COMPONENT/HDMI
1 125 (1 080)/60p	1 920 x 1 080	67.5	60.0	148.5	AA	COMPONENT/PC/HDMI
1 125 (1 080)/50p	1 920 x 1 080	56.3	50.0	148.5	AA	COMPONENT/PC/HDMI
750 (720)/60p	1 280 x 720	45.0	60.0	74.3	AA	COMPONENT/HDMI
750 (720)/50p	1 280 x 720	37.5	50.0	74.3	AA	COMPONENT/HDMI
VGA480	640 x 480	31.5	59.9	25.2	A	PC/HDMI
	640 x 480	37.5	75.0	31.5	A	PC
	640 x 480	43.3	85.0	36.0	A	PC
	640 x 480	72.1	138.0	62.3	A	PC
WIDE480	856 x 480	30.1	60.1	31.5	A	PC
SVGA	800 x 600	35.2	56.3	36.0	A	PC
	800 x 600	37.9	60.3	40.0	A	PC
	800 x 600	48.1	72.2	50.0	A	PC
	800 x 600	46.9	75.0	49.5	A	PC
	800 x 600	53.7	85.1	56.3	A	PC
WIDE600	1 072 x 600	37.2	59.9	51.4	A	PC
WIDE720	1 280 x 720	45.1	60.1	76.5	AA	PC
XGA	1 024 x 768	48.4	60.0	65.0	A	PC
	1 024 x 768	58.5	70.1	75.0	A	PC
	1 024 x 768	60.0	75.0	78.8	A	PC
	1 024 x 768	68.7	85.0	94.5	A	PC
	1 024 x 768	72.1	89.0	99.2	A	PC
WIDE768	1 280 x 768	45.3	56.5	76.2	A	PC
MXGA	1 152 x 864	64.0	71.2	94.2	A	PC
	1 152 x 864	67.5	74.9	108.0	A	PC
SXGA	1 280 x 1024	64.0	60.0	108.0	A	PC
SXGA60+	1 400 x 1 050	65.1	59.9	122.4	A	PC
WIDE768-2	1 360 x 768	48.8	59.8	74.3	A	PC
WIDE800	1 280 x 800	49.7	59.8	83.5	A	PC
WIDE900	1 440 x 900	55.9	59.8	106.5	A	PC

*1. The "i" appearing after the resolution indicates an interlaced signal.

*2. The following symbols are used to indicate picture quality.

AA Maximum picture quality can be obtained.

A Signals are converted by the image processing circuit before picture is projected.

Technical Information

Serial terminal

The serial connector which is on the connector panel of the projector conforms to the RS-232C interface specification, so that the projector can be controlled by a personal computer which is connected to this connector.

Connection

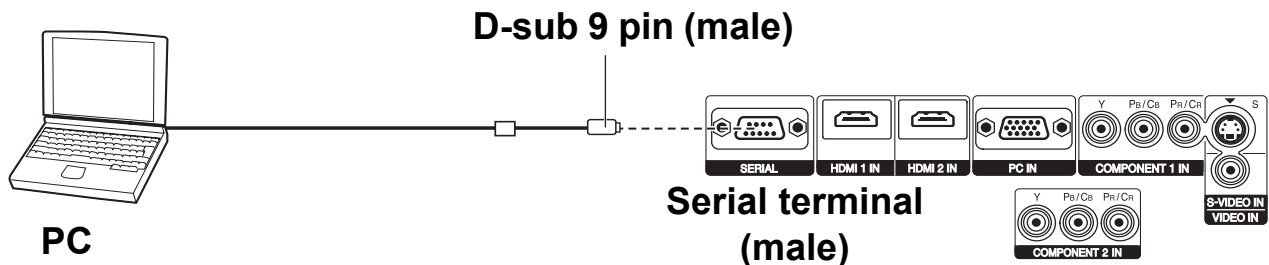

NOTE:

- You must use only an RS-232C Serial Interface Cable with a ferrite core, type ET-ADSER.

Pin assignments and signal names

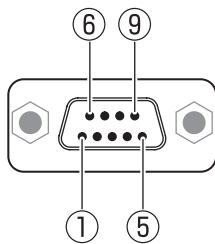

Pin No.	Signal name	Contents
①		NC
②	TXD	Transmitted data
③	RXD	Received data
④		NC
⑤	GND	Earth
⑥		NC
⑦	RTS	Connected internally
⑧	CTS	
⑨		NC

Communication settings

Signal level	RS-232C	Character length	8 bits
Sync. method	Asynchronous	Stop bit	1 bit
Baud rate	9 600 bps	X parameter	None
Parity	None	S parameter	None

Control commands

Command	Control contents	Remarks
PON	Power ON	In standby mode, all commands other than the PON command are ignored. ● The PON command is ignored during lamp ON control.
POF	Power OFF	● If a PON command is received while the cooling fan is operating after the lamp has switched off, the lamp is not turned back on again straight away in order to protect the lamp.
IIS	INPUT	Parameter: (page 23) VID = VIDEO IN RG1 = PC IN CP2 = COMPONENT1 IN SVD = S-VIDEO IN HD1 = HDMI1 IN HD2 = HDMI2 IN CP2 = COMPONENT2 IN
OMN	MAIN	Displaying Main menu
OEN	ENTER	Activating the selected items in menu mode.
OBK	RETURN	Returning to the previous menu or escaping from the menu mode.
OCU/ OCD/ OCL/ OCR	Navigation buttons	OCU = ▲ button OCD = ▼ button OCL = ◀ button OCR = ▶ button
OLE	LENS CONTROL	Activating the LENS CONTROL menu.
OST	DEFAULT	Resetting to the factory default setting. (page 22)
OFZ	FREEZE	Freezing the projected screen. Parameter: 0 = OFF 1 = ON
OOT	SLEEP	Setting the duration of time to turn off the power automatically. 0 = OFF 1 = 60 min. 2 = 90 min. 3 = 120 min. 4 = 150 min. 5 = 180 min. 6 = 210 min. 7 = 240 min. (page 25)
OSH	SHUTTER	Turning off the projection temporarily. Send the command to switch between ON and OFF. Do not send the command consecutively.
OVM	PICTURE	Activating the PICTURE menu. Send the command to switch menu items. (page 28)
OWM	WAVEFORM	Activating the WAVEFORM. Parameter: (page 24) 0 = OFF 1 = FULL SCAN (Y) 5 = SINGLE LINE SCAN (Y) 2 = FULL SCAN (R) 6 = SINGLE LINE SCAN (R) 3 = FULL SCAN (G) 7 = SINGLE LINE SCAN (G) 4 = FULL SCAN (B) 8 = SINGLE LINE SCAN (B)
VS1	ASPECT	Switch the aspect ratio. (page 23)
VPM	PICTURE MODE	Parameter: (page 25) NAT=COLOR1 NOR=NORMAL DYN=DYNAMIC CN1=CINEMA1 CN2=CINEMA2 CN3=CINEMA3 VID=COLOR2

Technical Information

Inquiry commands

Command	Control contents	Parameter	
QPW	Power status	000 = OFF	001 = ON
QFZ	FREEZE status	0 = OFF	1 = ON
QIN	Input signal status	Parameter: (page 23) VID = VIDEO IN RG1 = PC IN CP1 = COMPONENT1 IN	SVD = S-VIDEO IN HD1 = HDMI1 IN HD2 = HDMI2 IN CP2 = COMPONENT2 IN
QOT	SLEEP status	0 = OFF 1 = 60 min. 2 = 90 min. 3 = 120 min. 4 = 150 min. 5 = 180 min. 6 = 210 min. 7 = 240 min. (page 25)	
QPM	PICTURE MODE status	Parameter: (page 25) NAT = COLOR1 DYN = DYNAMIC CN2 = CINEMA2 VID = COLOR2	NOR = NORMAL CN1 = CINEMA1 CN3 = CINEMA3
QSH	SHUTTER status	0 = OFF	1 = ON
QWM	WAVEFORM status	Parameter: (page 24) 0 = OFF 1 = FULL SCAN (Y) 2 = FULL SCAN (R) 3 = FULL SCAN (G) 4 = FULL SCAN (B)	5 = SINGLE LINE SCAN (Y) 6 = SINGLE LINE SCAN (R) 7 = SINGLE LINE SCAN (G) 8 = SINGLE LINE SCAN (B)

Basic format

STX	Command	:	Parameter	ETX
Start byte (02h)	3 bytes	1 byte	1 byte - 4 bytes	End (03h)

The data streaming from the computer will start with STX, and proceed to Command, Parameter and end with ETX. You can add the required parameter.

- The projector can not receive any command for 10 seconds after the lamp is switched on. Wait 10 seconds before sending the command.
- If sending multiple commands, check that a response has been received from the projector for one command before sending the next command.
- When a command which does not require parameters to be sent, the colon (:) is not required.
- If an incorrect command is sent from the personal computer, the ER401 command will be sent from the projector to the personal computer.

Cable specifications

(When connected to a personal computer)

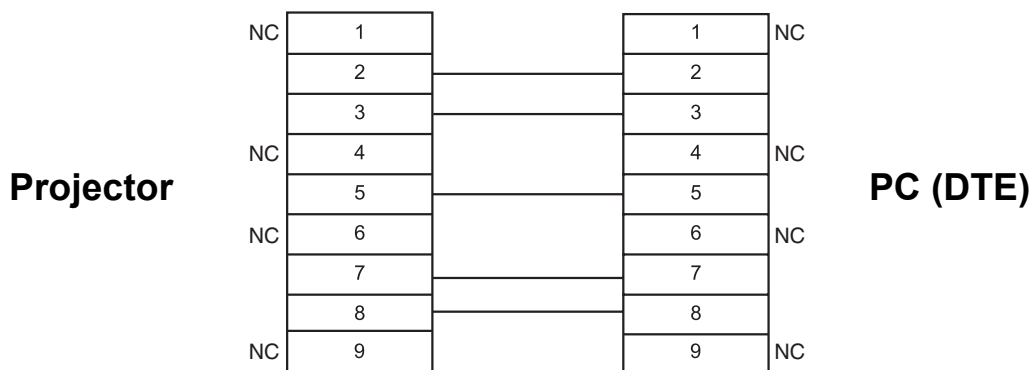

Menu structure

PICTURE Menu 31 ▶

- PICTURE MODE 31 ▶
- CONTRAST 31 ▶
- BRIGHTNESS 31 ▶
- COLOR 31 ▶
- TINT 31 ▶
- SHARPNESS 31 ▶
- COLOR TEMPERATURE 31 ▶
- DYNAMIC IRIS 32 ▶
- WAVEFORM MONITOR 32 ▶
- ADVANCED MENU 32 ▶
- MEMORY SAVE 33 ▶
- MEMORY LOAD 33 ▶
- SIGNAL MODE 33 ▶

NORMAL
DYNAMIC
CINEMA1
CINEMA2
CINEMA3
COLOR1
COLOR2

FULL SCAN(Y)
FULL SCAN(R)
FULL SCAN(G)
FULL SCAN(B)
SINGLE LINE SCAN(Y)
SINGLE LINE SCAN(R)
SINGLE LINE SCAN(G)
SINGLE LINE SCAN(B)

POSITION Menu 34 ▶

- H - POSITION 34 ▶
- V - POSITION 34 ▶
- DOT CLOCK 34 ▶
- CLOCK PHASE 34 ▶
- ASPECT 35 ▶
- WSS 36 ▶
- OVER SCAN 36 ▶
- KEystone 36 ▶
- AUTO SETUP 36 ▶

4:3
16:9
JUST
ZOOM/ZOOM1
ZOOM2
14:9
H - FIT
V - FIT

GAMMA
CONTRAST
BRIGHTNESS
COLOR MANAGEMENT
NR (Noise Reduction)
MPEG NR
CINEMA REALITY
TV-SYSTEM

LENS CONTROL Menu 37 ▶

- ZOOM/FOCUS 37 ▶

OPTION Menu 38 ▶

- INPUT GUIDE 38 ▶
- OSD DESIGN 38 ▶
- OSD POSITION 38 ▶
- BACK COLOR 38 ▶
- STARTUP LOGO 38 ▶
- AUTO SEARCH 38 ▶
- HDMI SIGNAL LEVEL 38 ▶
- INSTALLATION 39 ▶
- SLEEP 39 ▶
- ALTITUDE 39 ▶
- LAMP POWER 39 ▶
- LAMP RUNTIME 39 ▶
- FUNCTION BUTTON 39 ▶

TYPE1
TYPE2
TYPE3

UPPER LEFT
LOWER LEFT
UPPER CENTER
CENTER
LOWER CENTER
UPPER RIGHT
LOWER RIGHT

FRONT/DESK
FRONT/CEILING
REAR/DESK
REAR/CEILING

● Sub-menu items vary according to the selected input signal.

Specifications

Power supply		AC 100 - 240 V 50 Hz/60 Hz
Power consumption		240 W During standby (when fan is stopped): 0.08 W
Amps		2.8 A - 1.2 A
LCD panel	Panel size (diagonal)	0.74 type (17.78 mm)
	Aspect ratio	16 : 9
	Display method	3 transparent LCD panels (RGB)
	Drive method	Active matrix method
	Pixels	2 073 600 (1 980 x 1 080) x 3 panels
Lens		Motorized zoom (2x)/Motorized focus F 1.9 - 3.2, f 22.4 mm - 44.4 mm
Lamp		UHM lamp (165 W)
Luminosity		1 100 lm
Scanning frequency*1 (for RGB signal)	Horizontal scanning frequency	30 kHz - 70 kHz
	Vertical scanning frequency	50 Hz - 87 Hz
	Dot clock frequency	Less than 150 MHz
COMPONENT (YPbPr) signals		525i (480i), 525p (480p), 625i (576i), 625p (576p), 1 125 (1 080)/24p, 750 (720)/50p, 750 (720)/60p, 1 125 (1 080)/50i, 1 125 (1 080)/60i, 1 125 (1 080)/50p, 1 125 (1 080)/60p
Color system		7 (NTSC/NTSC 4.43/PAL/PAL-M/PAL-N/SECAM)
Projection size		1 016 mm - 5 080 mm (40" - 200")
Throw distance		1.2 m - 12 m (3'11" - 39'4")
Screen aspect ratio		16 : 9
Installation		Front/Rear/Ceiling/Desk (Menu selection method)

*1. See "List of compatible signals" on page 45 for available signals.

Specifications

Connectors	S-VIDEO IN	Single - line, Mini DIN 4p Y: 1.0 V [p-p], C: 0.286 V [p-p], 75 Ω	
	VIDEO IN	Single - line, RCA pin jack 1.0 V [p-p], 75Ω	
	PC IN	RGB	Single - line, D - sub HD 15-pin (female)
		● R.G.B.	0.7 V [p-p], 75 Ω
		● G.SYNC	1.0 V [p-p], 75 Ω
		● HD/SYNC	TTL high impedance, automatic positive/negative polarity compatible
● VD	TTL high impedance, automatic positive/negative polarity compatible		
COMPONENT1 IN COMPONENT2 IN	Y, PB/CB, PR/CR	Double - line, RCA pin jack x 3	
	● Y:	1.0 V [p-p] (including sync), 75 Ω	
	● PB/CB, (PR/CR)	0.7 V [p-p], 75 Ω	
HDMI1 IN/HDMI2 IN	Double - line, 19-pin HDMI connector		
SERIAL	D-sub 9-pin RS-232C compatible		
Cabinet	Moulded plastic (PC+ABS)		
Dimensions	● Width	460 mm (18 -3/32")	
	● Height	130 mm (5 - 3/32")	
	● Length	300 mm (11 - 25/32")	
Weight	7.2 kg (15.9 lbs.)		
Operating environment	● Temperature	0 °C - 40 °C (32 °F - 104 °F) When the ALTITUDE (page 39) is set to HIGH : 0 °C - 35 °C (32 °F - 95 °F)	
	● Humidity	20% - 80% (no condensation)	
Certifications	UL60950-1 FCC Class B	C-UL ICES-003	
Remote control	Power supply	3 V DC (AA battery x 2)	
	Operating range	Approx. 7 m (23') (when operated directly in front of signal receptor)	
	Weight	170 g (6 ozs.) (including batteries)	
	Dimensions	● Width	52 mm (2 - 1/32")
● Length		200 mm (7 - 27/32")	
● Height		28.5 mm (1 - 3/32") (not including surface projection parts)	
Options	Ceiling bracket	ET-PKX100 ET-PKE1000S	
	Projection screen	ET-SRW90CC	
	Cable cover	ET-PCE1000	

Dimensions

Units: mm (inch)

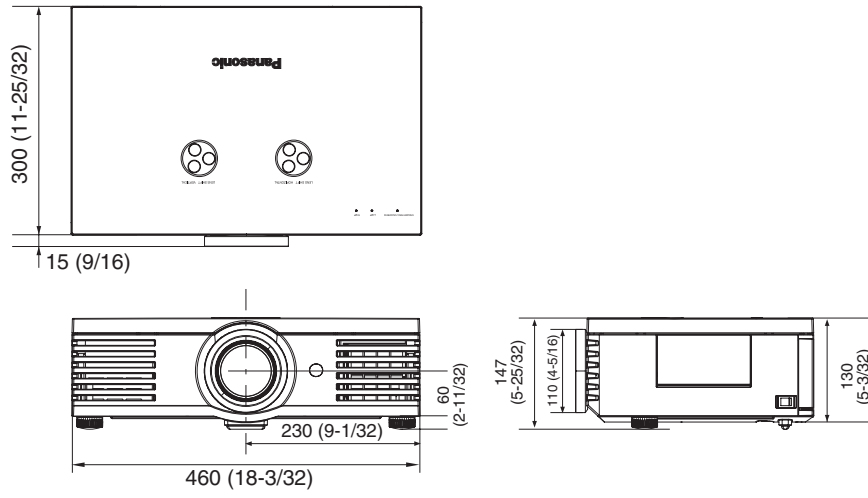

Trademark acknowledgements

- VGA and XGA are trademarks of International Business Machines Corporation.
- S-VGA is a registered trademark of the Video Electronics Standards Association.
- HDMI, the HDMI logo and High-Definition Multimedia Interface are trademarks or registered trademarks of HDMI Licensing LLC.
- The font used in the on-screen displays is a Ricoh bitmap font, which is manufactured and sold by Ricoh Company, Ltd.

All other trademarks are the property of the various trademark owners.

Information on Disposal in other Countries outside the European Union



This symbol is only valid in the European Union.

If you wish to discard this product, please contact your local authorities or dealer and ask for the correct method of disposal.



Index

A		G	
Accessories	9	GAMMA	32
ADVANCED MENU	32	H	
Air filter	41	H- POSITION	34
ALTITUDE	39	HDMI IN	
ASPECT	35	Connection	18
Options	35	Terminal	13
Remote control	23	HDMI SIGNAL LEVEL	38
Remote control button	11	I	
Signals	36	INPUT	
AUTO SEARCH	38	INPUT GUIDE	38
AUTO SETUP	36	Remote control	23
B		Remote control button	11
BACK COLOR	38	Selecting signal	21
Battery		INSTALLATION	39
Accessory	9	Projection method	15
Compartment	11	K	
BRIGHTNESS	31, 32	KEYSTONE	36
C		L	
CINEMA REALITY	33	LAMP	
Cleaning	41	Indicator status	40, 42
CLOCK PHASE	34	LAMP POWER	39
COLOR	31	LAMP RUNTIME	39
COLOR MANAGEMENT	32	Replacing	42
Remote control	26	LCD, Remote control	11
Remote control button	11	Learning Remote control buttons	11
COLOR TEMPERATURE	31	LENS CONTROL	37
COMPONENT1 IN		LENS, Remote control button	11
Connection	18	Lens shift	
Terminal	13	Horizontal shift	16
COMPONENT2 IN		Image positioning	21
Connection	18	Lens shift dial/Horizontal	12
Terminal	13	Lens shift dial/Vertical	12
CONTRAST	31, 32	Positioning	16
D		Vertical shift	16
DEFAULT		LIGHT	
Remote control	22	Remote control	22
Remote control button	11	Remote control button	11
Dimensions	52	LOG	
DOT CLOCK	34	Managing	27
DYNAMIC IRIS	32	Saving	27
E		M	
ENTER		MAIN POWER	
Control panel button	12	Control panel button	12
Remote control button	11	On/Off	19
F		MEMORY LOAD	33
FREEZE		Remote control button	11
Remote control	22	MEMORY SAVE	33
Remote control button	11	MENU	
Front leg adjuster		Main menu	29
Adjusting	15	Opening the menu	28
Image positioning	21	Remote control button	11
FUNCTION BUTTON		Menu structure	49
Remote control buttons	11	MPEG NR	33
Setting	39		

N		S	
Navigation buttons		Screen size.....	14
Control panel button	12	SERIAL	
Remote control.....	11	Basic format	48
NR (Noise Reduction)	32	Cable specifications	48
O		Communication settings.....	46
OPTION.....	38	Connection	46
OSD DESIGN.....	38	Control commands	47
OSD POSITION	38	Inquiry commands	48
OVER SCAN.....	36	Pin assignments.....	46
P		Terminal	13
PC IN		SHARPNESS.....	31
Connection	18	SIGNAL MODE	33
Terminal	13	SLEEP	39
PICTURE		Remote control	25
Operation.....	31	Remote control button	11
PIC. ADJUST, Remote control button	11	Specifications.....	50
Remote control.....	25	STARTUP LOGO	38
PICTURE MODE		S-VIDEO IN	
PIC. MODE, Remote control button	11	Connecting	18
Setting.....	31	Terminal	13
POSITION	34	T	
POWER		TEMP indicator	40
Indicator status.....	19	Throw distance	14
On/Off	20	Throwing angle	15
Remote control button	11	TINT.....	31
Power cord		TV-SYSTEM	33
Accessory	9	V	
Connection.....	19	V- POSITION	34
PROFILE		VIDEO IN	
Create new.....	26	Connecting	18
Loading	27	Terminal	13
R		W	
Remote control		WAVEFORM MONITOR.....	32
Accessory	9	Remote control	24
Buttons	11	WAVEFORM, Remote control button	11
Operating range	22	WSS	36
Operation	22	Z	
Signal emitter.....	11	ZOOM/FOCUS	37
RETURN			
Operation	28		
Remote control button	11		

