

myprojectorlamps.com

**The most trusted, dependable name
in projector lamp sales.**



<http://www.myprojectorlamps.com>



<http://www.myprojectorlamps.ca>





<http://www.myprojectorlamps.eu>

The following projector manual has not been modified or altered in any way.

Table of Contents

Table of Contents	1
Usage Notice.....	2
Safety Information	2
Precautions.....	3
Eye Safety Warnings	5
Introduction.....	6
Product Features	6
Package Overview.....	7
Product Overview	8
Main Unit.....	8
Control Panel	9
Connection Ports	10
Remote Control.....	12
Installation	13
Connecting the Projector	13
Connect to Computer/Notebook	13
Connect to Video Sources	14
Powering On/Off the Projector.....	15
Powering On the Projector.....	15
Powering Off the projector	16
Warning Indicator.....	16
Adjusting the Projected Image.....	17
Adjusting the Projector's Height.....	17
Adjusting the Projector's Zoom / Focus	18
Adjusting Projected Image Size	18
User Controls	19
Control Panel & Remote Control	19
On-screen Display Menus	23
How to operate	23
Menu Tree.....	24
Image	25
Display	28
Setup.....	31
Options.....	42
Appendices.....	45
Troubleshooting.....	45
Image Problems	45
Intermission Problems	48
Projector Status Indication	48
Remote Control Problems	49
Replacing the Lamp.....	50
Compatibility Modes	52
RS232 Commands	53
Ceiling Mount Installation	56
Optoma Global Offices	57
Regulation & Safety notices	59

Safety Informations

	The lightning flash with arrow head within an equilateral triangle is intended to alert the user to the presence of uninsulated "dangerous voltage" within the product's enclosure that may be of sufficient magnitude to constitute a risk of electric shock to persons.
	The exclamation point within an equilateral triangle is intended to alert the user to the presence of important operating and maintenance (servicing) instructions in the literature accompanying the appliance.

WARNING: TO REDUCE THE RISK OF FIRE OR ELECTRIC SHOCK, DO NOT EXPOSE THE PROJECTOR TO RAIN OR MOISTURE. DANGEROUS HIGH VOLTAGES ARE PRESENT INSIDE THE ENCLOSURE. DO NOT OPEN THE CABINET. REFER SERVICING TO QUALIFIED PERSONNEL ONLY.

Class B emissions limits

This Class B digital apparatus meets all requirements of the Canadian Interference-Causing Equipment Regulations.

Important Safety Instruction

1. Read these instructions -before using this projector.
 2. Keep these instructions -for future reference.
 3. Follow all instructions.
 4. Install in accordance with the manufacturer's instructions :
 - A. Do not block any ventilation openings.** To ensure reliable operation of the projector and to protect it from overheating, put the projector in a position and location that will not interfere with its proper ventilation. For example, do not place the projector on a bed, sofa, carpet, or similar surface that may block the ventilation openings. Do not put it in an enclosure, such as a bookcase or a cabinet that may keep air from flowing through its ventilation openings.
 - B. Do not use this projector near water or moisture.** To reduce the risk of fire or electric shock, do not expose the projector to rain or moisture.
 - C. Do not install near any heat sources,** such as radiators, heaters, stoves or other apparatus (including amplifiers) that produce heat.
 5. Clean only with a dry cloth.
 6. Only use attachments/accessories specified by the manufacturer.
 7. Refer all servicing to qualified service personnel. Servicing is required when the projector has been damaged in any way, such as:
 - Power supply cord or plug is damaged.
 - Liquids have spilled or objects have fallen into the apparatus.
 - The projector has been exposed to rain or moisture, does not operate normally, or has been dropped.
- Do not attempt to service this projector yourself. Opening or removing covers may expose you to dangerous voltages or other hazards. Please call Optoma to be referred to an authorized service center near you.
8. Do not let objects or liquids enter the projector as they may touch dangerous voltage points or short-out parts that could result in a fire or electric shock.
 9. See projector enclosure for safety related markings.
 10. The projector should not be adjusted or repaired by anyone except properly qualified service personnel.

Precautions



Please follow all warnings, precautions and maintenance as recommended in this user's guide.

- Warning- Do not look into the projector's lens when the lamp is on. The bright light may damage your eyes.
- Warning- To reduce the risk of fire or electric shock, do not expose this projector to rain or moisture.
- Warning- Please do not open or disassemble the projector as this may cause electric shock.
- Warning- When replacing the lamp, please allow unit to cool down, and follow all replacement instructions. See pages 50-51.
- Warning- This projector will detect the life of the lamp itself. Please be sure to change the lamp when it shows warning messages.
- Warning- Use the "Lamp Reset" function from the on-screen display "Options | Lamp Settings" menu after replacing the lamp module (refer to page 44).
- Warning- When switching the projector off, please ensure the cooling cycle has been completed before disconnecting the power. Allow 90 seconds for the projector to cool down.
- Warning- Do not use the lens cap when projector is in operation.
- Warning- When the lamp is approaching to the end of its life, the message "Lamp Warning: Lamp life exceeded." will show on the screen. Please contact your local reseller or service center to change the lamp as soon as possible.
- Warning- To reduce the risk of injury to the eyes, do not look directly into the laser beam on the remote control and do not point the laser beam into anyone's eyes. This remote control is equipped with a Class II laser that emits radiation.



- ❖ When the lamp reaches the end of its life, the projector will not turn back on until the lamp module has been replaced. To replace the lamp, follow the procedures listed under "Replacing the Lamp" section on pages 50-51.

Usage Notice

Do:

- ❖ Turn off the product before cleaning.
- ❖ Use a soft cloth moistened with a mild detergent to clean the display housing.
- ❖ Disconnect the power plug from the AC outlet if the product is not being used for a long period of time.

Don't:

- ❖ Do not block the ventilation slots and openings on the unit.
- ❖ Do not use abrasive cleaners, waxes or solvents to clean the unit.
- ❖ Do not use under the following conditions:
 - In extremely hot, cold or humid environments.
 - ▶ Ensure that the ambient room temperature is within 5-35°C.
 - ▶ Relative Humidity is 5-35°C, 80% (Max.), non-condensing.
 - In areas susceptible to excessive dust and dirt.
 - Near any appliance that generates a strong magnetic field.
 - In direct sunlight.

Eye Safety Warnings



- ■ Avoid staring directly into the projector's beam of light at all times.
- ■ Minimize standing facing into the beam. Keep your back to the beam as much as possible.
- ■ Using a stick or laser pointer is recommended to avoid the need for the presenter to enter the beam.
- ■ Ensure that projectors are located out of the line of sight from the screen to the audience; this ensures that, when presenters look at the audience, they do not also have to stare at the projector lamp. The best way to achieve this is by ceiling-mounting the projector rather than placing it on floor or table top.
- ■ When projector is used in a classroom, adequately supervise students when they are asked to point out something on the screen.
- ■ In order to minimize the lamp power needed, use room blinds to reduce ambient light levels.

Product Features

*This product is a XGA single chip 0.7" DLP® projector.
Outstanding features include:*

- ◆ True XGA, 1024 x 768 addressable pixels
- ◆ Single chip Dark Chip3™ DLP® Technology
- ◆ Computer Compatibility:
Apple Macintosh, iMac, and VESA Standards:
UXGA, SXGA+, SXGA, WXGA, XGA, SVGA, VGA
- ◆ Video Compatibility:
NTSC, PAL, SDTV compatible, HDTV compatible
- ◆ Auto source detection with user definable settings
- ◆ Full function IR remote control with laser pointer and mouse control
- ◆ User friendly multilingual On Screen Menu
- ◆ Advanced digital keystone correction and high quality full screen image re-scaling
- ◆ User friendly control panel
- ◆ Two speakers with 3 watt amplifier each
- ◆ Macintosh and PC compatible
- ◆ HDMI and DVI-D support (HDCP compliant)
- ◆ Support Network function (LAN/RS232)

Introduction

Package Overview

This projector comes with all the items shown below. Check to make sure your unit is complete. Contact your dealer immediately if anything is missing.

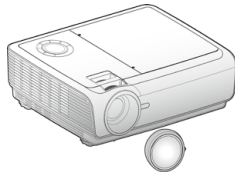

Projector with lens cap



Power Cord 3.0m



VGA Cable 1.8m



USB Cable 1.8m



IR Remote Control



2 x AAA Batteries



❖ Due to the difference in applications for each country, some regions may have different accessories.



RS232 Cable 1.8m
(available in USA and ASIA regions only)

Documentation :

- User's Manual
- Warranty Card
- Quick Start Card
- WEEE Card
(for EMEA only)

Introduction

Product Overview

Main Unit

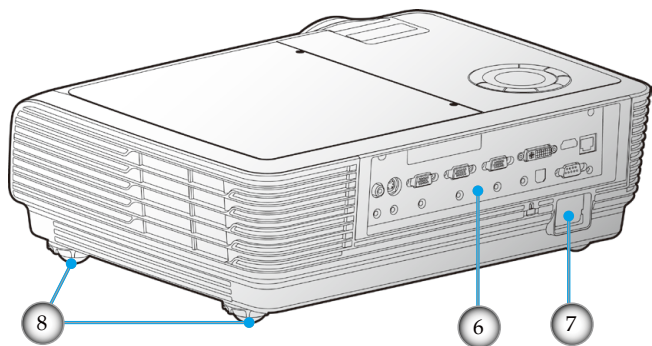
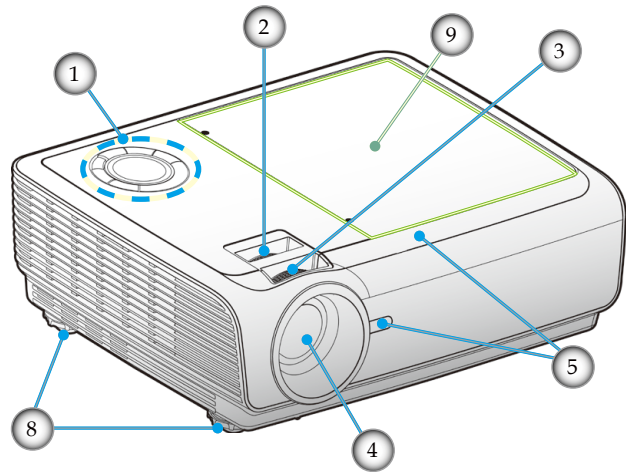

- | | |
|------------------|-------------------------|
| 1. Control Panel | 6. Connection Ports |
| 2. Zoom | 7. Power Socket |
| 3. Focus | 8. Tilt-Adjustment Feet |
| 4. Zoom Lens | 9. Lamp Cover |
| 5. IR Receivers | |

Introduction

Control Panel

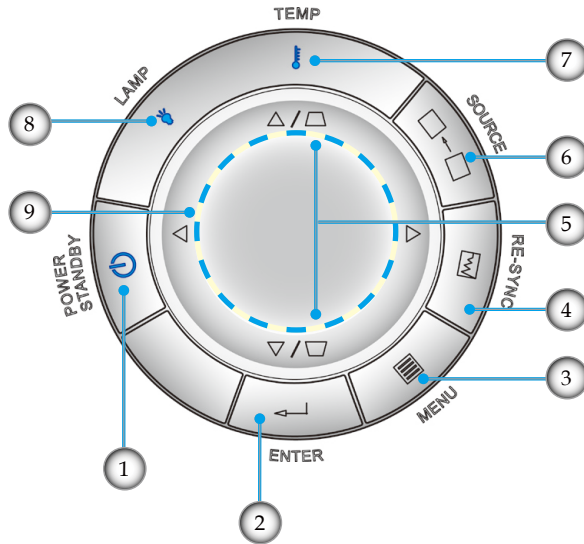

1. Power/Standby and Power LED
2. Enter
3. Menu
4. Re-Sync
5. Keystone Correction
6. Source
7. Temp LED
8. Lamp LED
9. Four Directional Select Keys

Introduction

Connection Ports

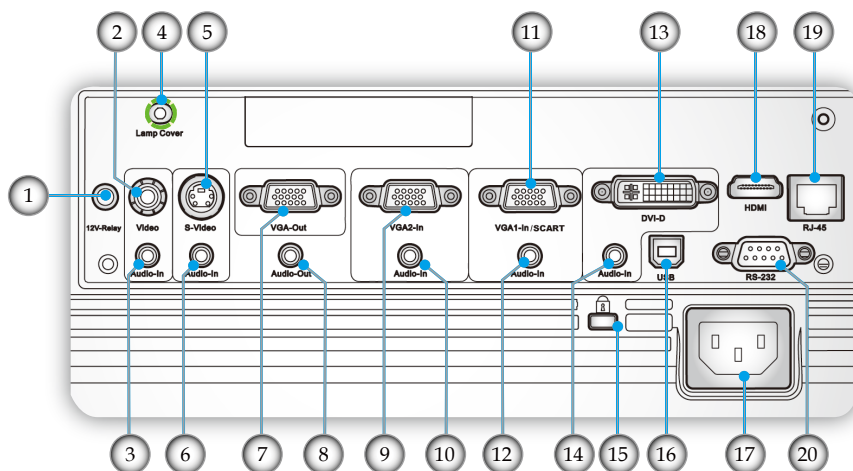

1. 12V-Relay Connector
2. Composite Video Input Connector
3. Audio Input Connector (for Composite Video Connector)
4. Lamp Cover screw (for open the top cover)
5. S-Video Input Connector
6. Audio Input Connector (for S-Video Connector)
7. VGA-Out Connector (Monitor Loop-through Output)
8. Audio-Out Connector
9. VGA2-In Connector
(PC Analog Signal/Component Video Input/HDTV)
10. Audio Input Connector (for VGA2-In Connector)
11. VGA1-In/SCART Connector
(PC Analog Signal/Component Video Input/HDTV/SCART)
12. Audio Input Connector (for VGA1-In Connector)
13. DVI-D Connector (PC Digital (HDCP))
14. Audio Input Connector (for DVI-D Connector)
15. Kensington™ Lock Port
16. USB Connector (Connect to PC for Remote Mouse function)
17. Power Socket
18. HDMI Connector (HDCP)
19. Networking Connector RJ45
20. RS-232 Connector

Introduction

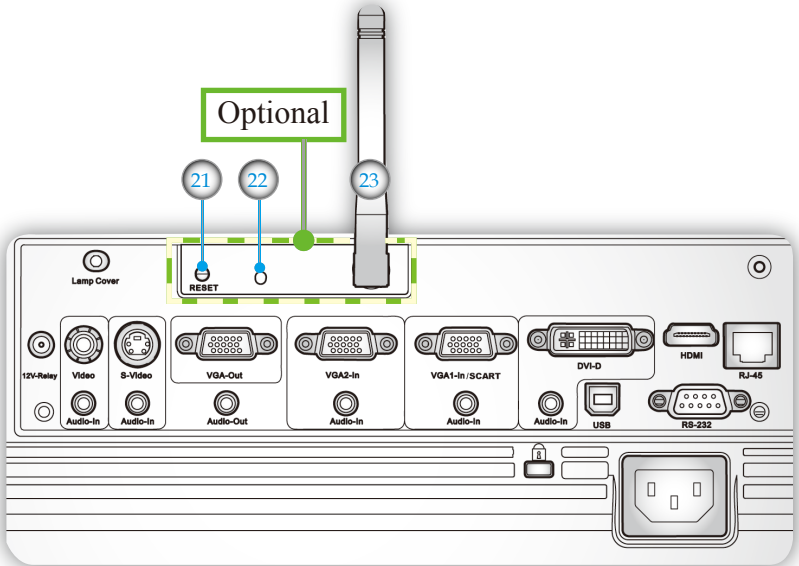

The items below are only for models that operate with optional wireless module:

21. Reset button
22. Status Indicator LED
23. Antenna

Introduction

Remote Control

1. Power On/Off
2. Re-Sync
3. Keystone
4. Page Up
5. Page Down
6. Laser LED
7. AV Mute
8. Freeze
9. Laser Button
10. Display Mode
11. Zoom in
12. Zoom out
13. Volume +/-
14. PC/Mouse Control
15. Mouse Right Click
16. Mouse Left Click
17. Enter
18. Menu
19. Four Directional Select Keys
20. Clear
21. Format
22. HDMI Source
23. Information
24. DVI Source
25. VGA1 Source
26. VGA2 Source
27. Source Lock
28. Video Source
29. S-Video Source
30. Numerical Buttons
31. Wireless (only functional with optional wireless module)

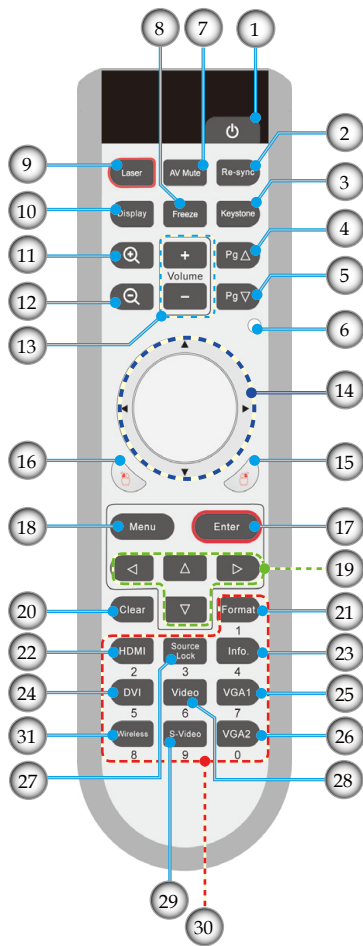

Installation

Connecting the Projector

Connect to Computer/Notebook

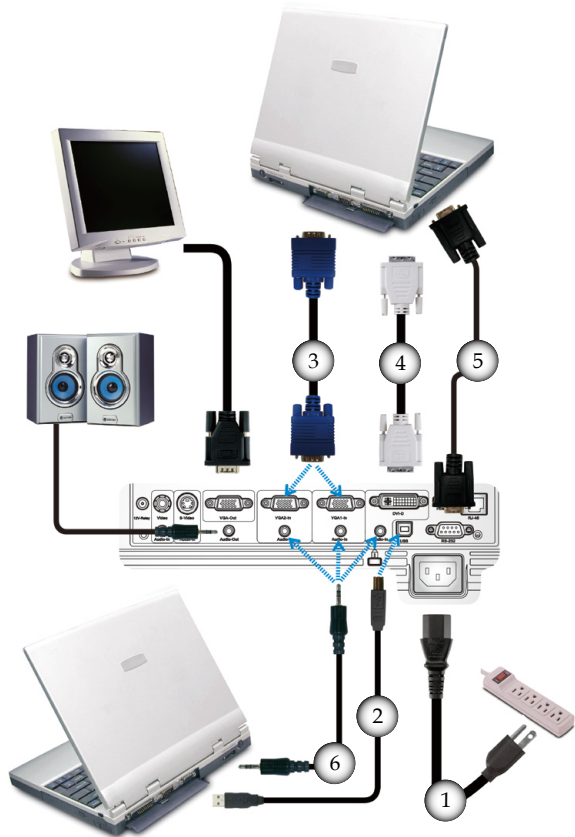

❖ Due to the difference in applications for each country, some regions may have different accessories.

- | | |
|--------|------------------------------------------|
| 1..... | Power Cord |
| 2..... | USB Cable |
| 3..... | VGA Cable |
| 4..... | DVI Cable (Optional accessories) |
| 5..... | RS232 Cable (for USA and ASIA only) |
| 6..... | Audio Input Cable (Optional accessories) |

Installation

Connect to Video Sources

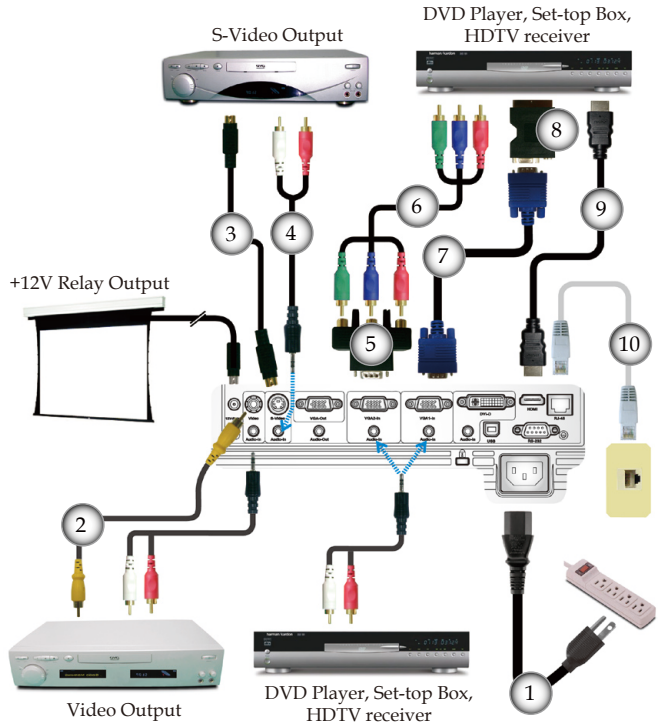

❖ Due to the difference in applications for each country, some regions may have different accessories.

- | | |
|---------|---------------------------------------------------------------|
| 1..... | Power Cord |
| 2..... | Composite Video Cable (Optional accessories) |
| 3..... | S-Video Cable (Optional accessories) |
| 4..... | Audio Cable Jack/RCA (Optional accessories) |
| 5..... | 15-Pin to 3 RCA Component/HDTV Adaptor (Optional accessories) |
| 6..... | 3 RCA Component Cable (Optional accessories) |
| 7..... | VGA Cable |
| 8..... | SCART RGB/S-Video Adaptor (Optional accessories) |
| 9..... | HDMI Cable (Optional accessories) |
| 10..... | Network Cable (Optional accessories) |

Powering On/Off the Projector

Powering On the Projector

1. Remove the lens cap. ❶
2. Ensure that the power cord and signal cable are securely connected. ❷ The Power LED will be Red.
3. Turn on the lamp by pressing “⏻” button either on the top of the projector or on the remote. The Power LED will flash Blue.

The startup screen will display in approximately 10 seconds. The first time you use the projector, you can select your preferred language from quick menu after the startup screen display.

4. Turn on your source (computer, notebook, video player, etc.). The projector will detect your source automatically.
- ❖ If you connect multiple sources at the same time, press the “Source” button on the control panel to switch between inputs.

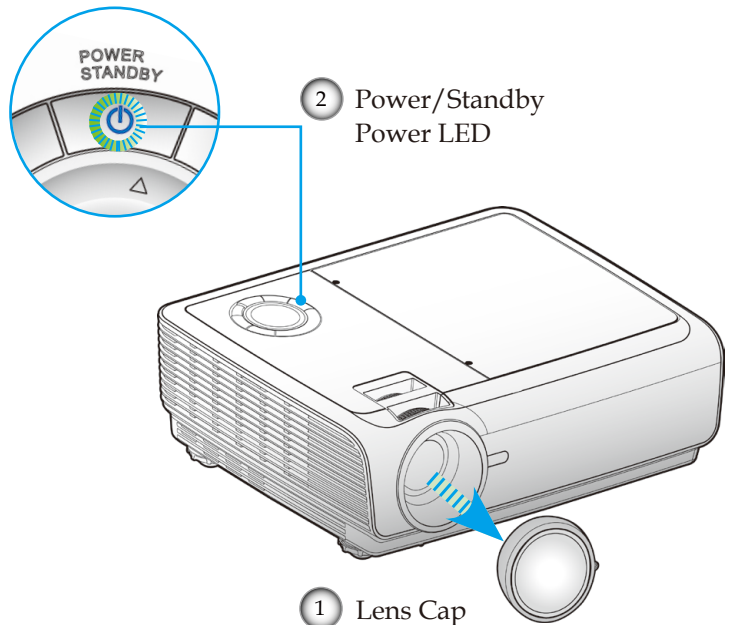

- ❖ Turn on the projector first and then select the signal sources.

Powering Off the Projector

1. Press the “⏻” button to turn off the projector lamp, you will see a message displayed on the projector’s screen.

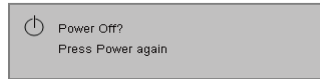

Press the “⏻” button again to confirm.

2. The cooling fans continue to operate for about 10 seconds for cooling cycle. When the Power LED turn Red, the projector has entered standby mode.

If you wish to turn the projector back on, you must wait until the projector has completed the cooling cycle and has entered standby mode. Once in standby mode, simply press “⏻” button to restart the projector.

3. Disconnect the power cord from the electrical outlet and the projector.
4. Do not turn on the projector immediately following a power off procedure.

Warning Indicator

- ❖ When the “LAMP” indicator lights red, the projector will automatically shut itself down. Please contact your local reseller or service center. See pages 57-58.
- ❖ When the “TEMP” indicator lights red, it indicates the projector has overheated. The projector will automatically shut itself down.
Under normal conditions, the projector can be switched on again after it has cooled down. If the problem persists, you should contact your local dealer or our service center. See pages 57-58.
- ❖ When the “TEMP” indicator flashes red, it indicates the fan has failed. Please contact your local dealer or our service center. See pages 57-58.

Adjusting the Projected Image

Adjusting the Projector's Height

The projector is equipped with elevator feet for adjusting the image height.

To raise the image:

1. Locate the adjustable foot you wish to modify on the underside of the projector.
2. Rotate the four adjustable rings counter clockwise to raise the projector or clockwise to lower it. Repeat with the remaining feet as needed.
3. Reset the projector on its feet and re-adjust as needed.

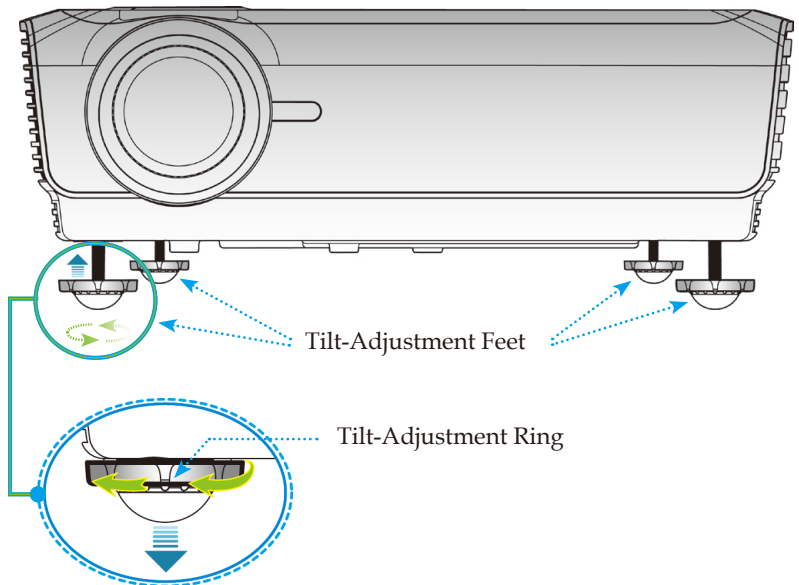

Installation

Adjusting the Projector's Zoom / Focus

You may turn the zoom lever to zoom in or out. To focus the image, rotate the focus ring until the image is clear. The projector will focus at distances from 3.9 to 32.8 feet (1.2 to 10.0 meters).

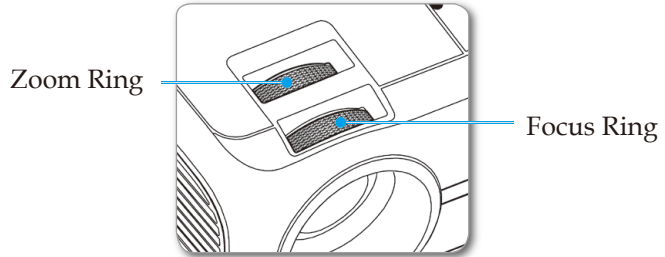

Adjusting Projection Image Size

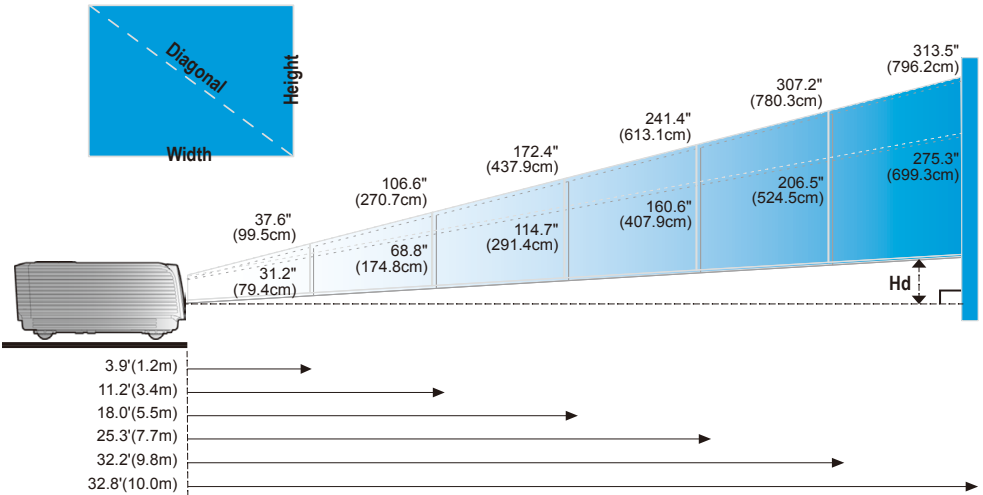

Screen (Diagonal)	Max.	37.6" (95.5cm)	106.6" (270.7cm)	172.4" (437.9cm)	241.4" (613.1cm)	307.2" (780.3cm)	313.5" (796.2cm)
	Min.	31.2" (79.4cm)	68.8" (174.8cm)	114.7" (291.4cm)	160.6" (407.9cm)	206.5" (524.5cm)	275.3" (699.3cm)
Screen Size	Max. (WxH)	30.1" x 22.6" 76.4 x 57.3cm	85.3" x 63.9" 216.6 x 162.4cm	137.9" x 103.4" 350.3 x 262.7cm	193.1" x 144.8" 490.4 x 367.8cm	245.7" x 184.3" 624.2 x 468.2cm	250.8" x 188.1" 636.9 x 477.7cm
	Min. (WxH)	25.0" x 18.7" 63.5 x 47.6cm	70.8" x 53.1" 179.9 x 134.9cm	114.6" x 85.9" 291.0 x 218.3cm	160.4" x 120.3" 407.4 x 305.6cm	204.1" x 153.1" 518.5 x 388.9cm	208.3" x 156.2" 529.1 x 396.8cm
Hd	Max.	2.26" (5.7cm)	6.39" (16.2cm)	10.34" (26.3cm)	14.48" (36.8cm)	18.43" (46.8cm)	18.81" (47.8cm)
	Min.	1.87" (4.76cm)	5.31" (13.49cm)	8.59" (21.83cm)	12.03" (30.56cm)	15.31" (38.89cm)	15.62" (39.68cm)
Distance		3.9' (1.2m)	11.2' (3.4m)	18.0' (5.5m)	25.3' (7.7m)	32.2' (9.8m)	32.8' (10.0m)

❖ This graph is for user's reference only.

User Controls





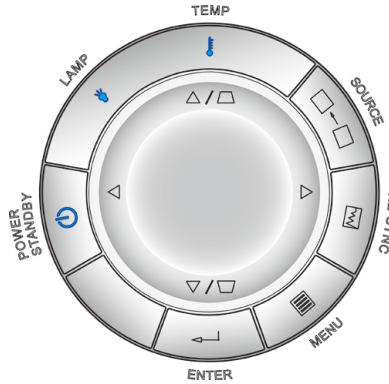

Control Panel & Remote Control

There are two ways for you to control the functions: Control Panel and Remote Control.

Control Panel



Using the Control Panel

 Power Standby Power LED	Refer to the “Power On/Off the Projector” section on pages 15-16. Indicate the projector’s status.
 Enter	Confirm your item selection.
 Menu	Press “Menu” to launch the on-screen display (OSD) menu. To exit OSD, Press “Menu” again.
 Re-Sync	Automatically synchronize the projector to the input source.
 Source	Press “Source” to select an input signal.
Four Directional Select Keys	Use ▲ ▼ ◀ ▶ to select items or make adjustments to your selection.
Keystone	Use ◻ ◻ to adjust image distortion caused by tilting the projector. (±16 degrees)
 Lamp LED	Indicate the projector’s lamp status.
 Temp LED	Indicate the projector’s temperature status.

User Controls

Remote Control

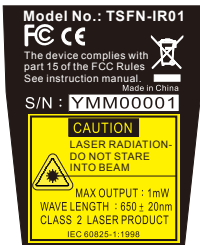

Using the Remote Control

Power	Refer to the “Power On/Off the Projector” section on pages 15-16.
Laser Button	Aim the remote at the viewing screen, press and hold this button to activate the laser pointer.
AV Mute	Momentarily turn off/on the audio and video.
Re-Sync	Automatically synchronize the projector to the input source.
Display Mode	Select the display mode from Presentation, Bright, Movie, sRGB, User1 and User2.
Freeze	Press “Freeze” to pause the screen. Press this button again to unlock.
Keystone	Adjust image distortion caused by tilting the projector. (±16 degrees)
Zoom in	Zoom in to magnify the image.
Zoom out	Zoom out to reduce the image.
Volume +/-	Adjust to increase/decrease the volume.
Page Δ	Use this button to page up.
Page ∇	Use this button to page down.
Laser Indicator LED	Indicate the laser’s status.
PC/Mouse control	The PC/Mouse control can be used to control mouse movement. The mouse function is enabled using the USB cable to connect your computer and the projector.
L Button	Mouse left click.
R Button	Mouse right click.

User Controls

Remote Control

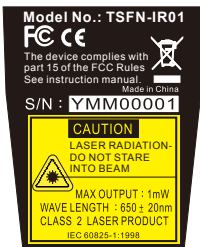

Using the Remote Control

Menu	Press "Menu" to launch the on-screen display (OSD) menu. To exit OSD, Press "Menu" again.
Enter	Confirm your item selection.
Four Directional Select Keys	Use ▲▼◀▶ to select items or make adjustments to your selection.
Clear	Clear your selection.
Format	Display the "Format" section of the onscreen display menu to select the desired aspect ratio.
HDMI	Press "HDMI" to choose HDMI source.
Source Lock	Select auto detection all connector ports or lock current connector port. (See page 42 for more)
Info.	To display the projector information on the screen.
DVI	Press "DVI" to choose DVI-In source.
Video	Press "Video" to choose Composite video source.
S-Video	Press "S-Video" to choose S-Video source.
VGA1	Press "VGA1" to choose source from VGA1-In/SCART connector.
VGA2	Press "VGA2" to choose source from VGA2-In connector.
Wireless	Press "Wireless" to choose Wireless source. (only functional with optional wireless module)

User Controls

Using the USB Remote Mouse Control

The remote control for this projector can be used as a remote mouse control with the USB cable.

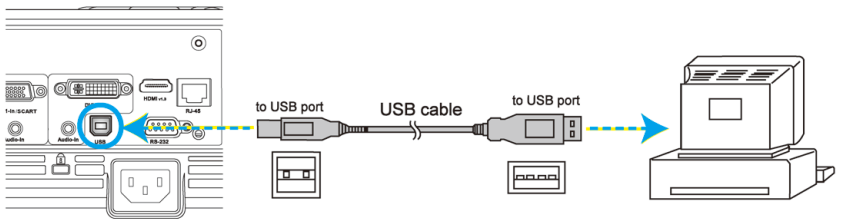

- ▶ When the projector is connected to PC via the USB cable, the remote will work as a mouse for control.

On-screen Display Menu

The Projector has multilingual On-screen Display menus that allow you to make image adjustments and change a variety of settings. The projector will automatically detect the source.

How to operate

1. To open the OSD menu, press “Menu” on the Remote Control or Projector Keypad.
2. When OSD is displayed, use ◀▶ keys to select any item in the main menu. While making a selection on a particular page, press ▼ or “Enter” key to enter sub menu.
3. Use ▲▼ keys to select the desired item and adjust the settings by ◀▶ key.
4. Select the next item to be adjusted in the sub menu and adjust as described above.
5. Press “Enter” to confirm, and the screen will return to the main menu.
6. To exit, press “Menu” again. The OSD menu will close and the projector will automatically save the new settings.

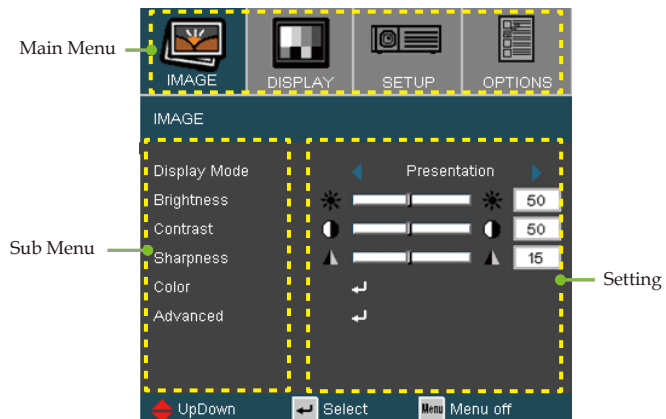

User Controls

Menu Tree

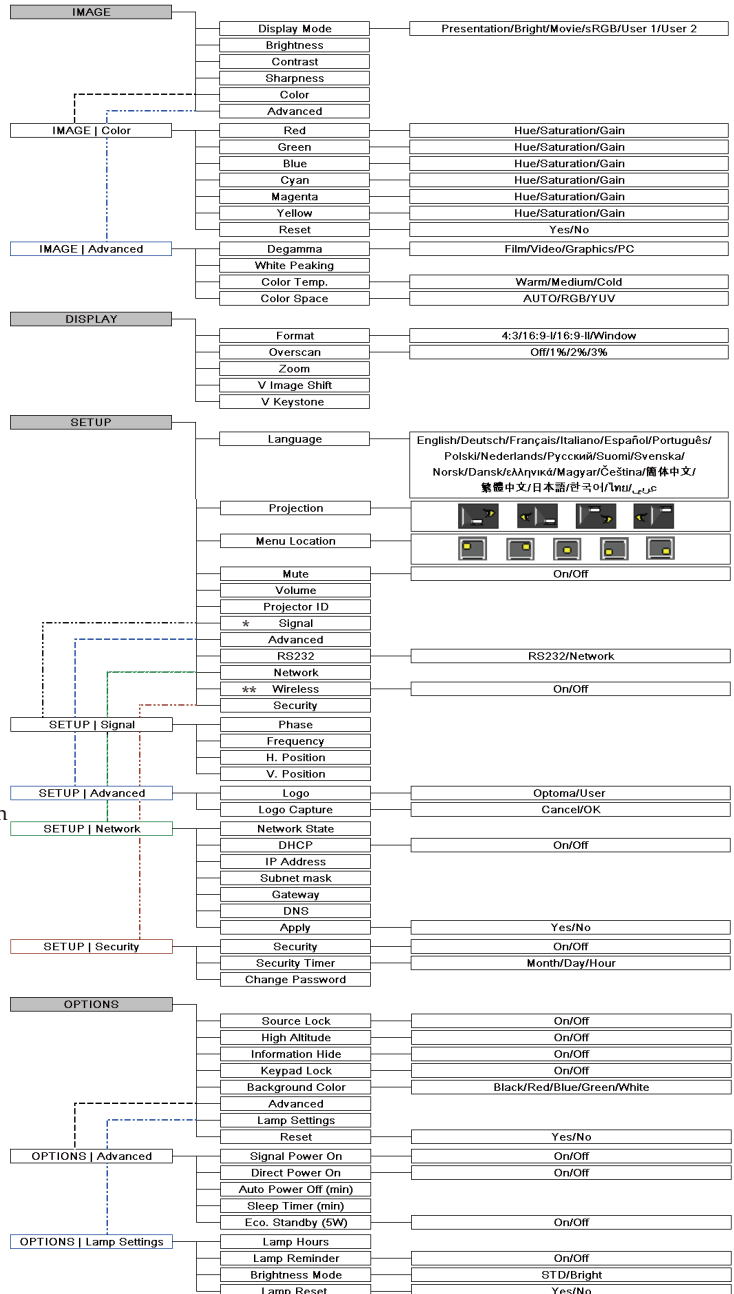

❖ (*) "Signal" menu is only supported in Analog VGA (RGB) signal.



❖ (**) "Wireless" is only functional with optional wireless module.

Image

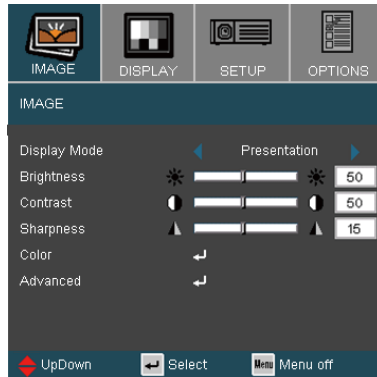

Display Mode

There are many factory presets optimized for various types of images.

- ▶ Presentation: Good color and brightness from PC input.
- ▶ Bright: Maximum brightness from PC input.
- ▶ Movie: For home theater.
- ▶ sRGB: Standardised accurate color.
- ▶ User1: User's own settings.
- ▶ User2: The initial default settings of this mode is from Movie mode. Any further adjustments by the user in User2 will be saved in this mode for future use.

Brightness

Adjust the brightness of the image.

- ▶ Press the ◀ to darken image.
- ▶ Press the ▶ to lighten the image.

Contrast

The contrast controls the degree of difference between the lightest and darkest parts of the picture. Adjusting the contrast changes the amount of black and white in the image.

- ▶ Press the ◀ to decrease the contrast.
- ▶ Press the ▶ to increase the contrast.

Sharpness

Adjust the sharpness of the image.

- ▶ Press the ◀ to decrease the sharpness.
- ▶ Press the ▶ to increase the sharpness.

Image | Color

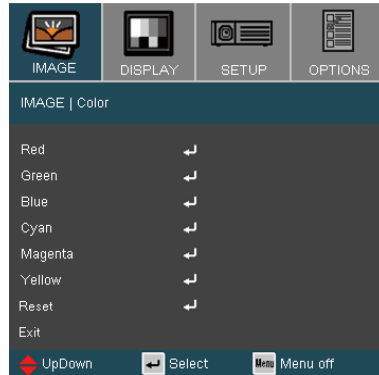

Color

Adjust the Red, Green, Blue, Cyan, Magenta and Yellow colors or returns to the factory default settings for advanced adjustment of the individual colors.

Reset

Choose “Yes” to return the factory default settings for color adjustments.



Hue

Adjust the color balance of red and green.

- ▶ Press the ◀ to increase the amount of green in the image.
- ▶ Press the ▶ to increase the amount of red in the image.

Saturation

Adjust a video image from black and white to fully saturated color.

- ▶ Press the ◀ to decrease the amount of saturation in the image.
- ▶ Press the ▶ to increase the amount of saturation in the image.

Gain

Use ◀ or ▶ to adjust Red, Green, Blue, Cyan, Magenta and Yellow colors for brightness (Gain).

Image | Advanced



Degamma

This allows you to choose a degamma table that has been fine-tuned to bring out the best image quality for the input.

- ▶ Film: for home theater.
- ▶ Video: for video or TV source.
- ▶ Graphics: for image source.
- ▶ PC: for PC or computer source.

White Peaking

This adjustable item utilizes a new color-processing algorithm and system level enhancements to enable higher brightness while providing true, more vibrant colors in picture. The range is from "0" to "10". If you prefer a stronger enhanced image, adjust toward the maximum setting. For a smoother, more natural image, adjust toward the minimum setting.

Color Temp

Adjust the color temperature. With cold temperature, the screen looks colder; with Warm temperature, the screen looks warmer.

Color Space

Select an appropriate color matrix type from AUTO, RGB or YUV.

Display



Format

Use this function to choose your desired aspect ratio.

- ▶ 4:3: This format is for 4x3 input sources not enhanced for Wide screen TV.
- ▶ 16:9 I: This format is for 16x9 input sources, like HDTV and DVD enhanced for Wide screen TV. (576i/p)
- ▶ 16:9 II: This format is for 16x9 input sources, like HDTV and DVD enhanced for Wide screen TV. (480i/p)
- ▶ Window: When a 4:3 image is bigger than a 16:9 screen, select the “Window” mode to fit the image onto the screen without changing the projection distance.

Source	480i/p	576i/p	720p	1080i	PC
4:3	Scale to 1024 x 768				
16:9 I	Scale to 1024 x 576				
16:9 II	Scale to 854 x 480				
Window	Scale to 800 x 600				

User Controls

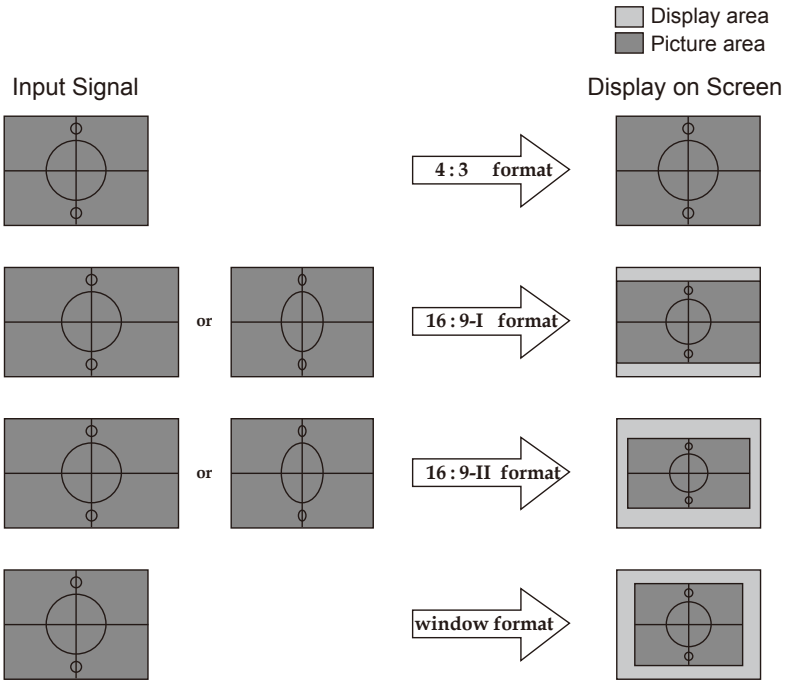

Display

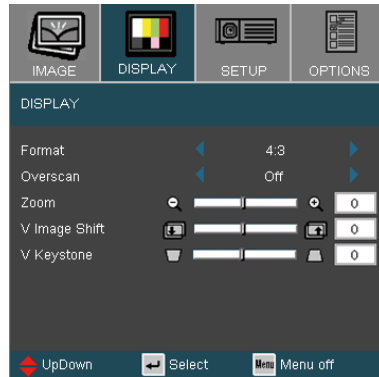

Overscan

Overscan function removes the noise in a video image. Overscan the image to remove video encoding noise on the edge of video source.

Zoom

- ▶ Press the ◀ to reduce the size of an image.
- ▶ Press the ▶ to magnify an image on the projection screen.

V Image Shift

Shift the projected image position vertically.

V Keystone

Press the ◀ or ▶ to adjust image distortion vertically and makes a squarer image.

Setup | Language

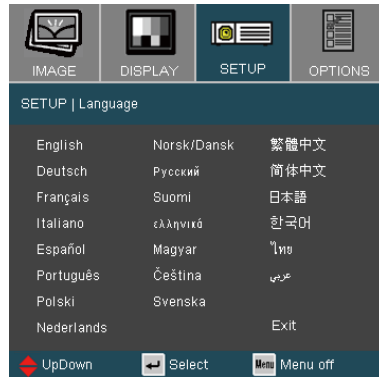





Language

Choose the multilingual OSD menu. Press ◀ or ▶ into the sub menu and then use the ▲ or ▼ key to select your preferred language. Press “Enter” to finalize the selection.

Setup



Projection

- ▶  **Front-Desktop**
The factory default setting.
- ▶  **Rear-Desktop**
When you select this function, the projector reverses the image so you can project behind a translucent screen.
- ▶  **Front-Ceiling**
When you select this function, the projector turns the image upside down for ceiling-mounted projection.
- ▶  **Rear-Ceiling**
When you select this function, the projector reverses and turns the image upside down at same time. You can project from behind a translucent screen with ceiling mounted projection.

Setup

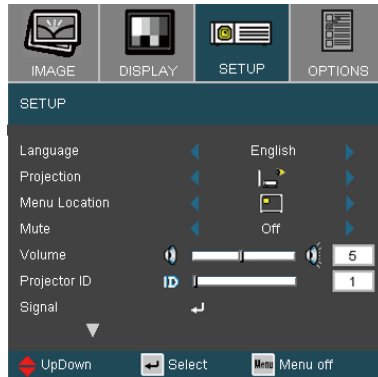

Menu Location

Choose the menu location on the display screen.

Mute

- ▶ Choose the "On" to turn mute on.
- ▶ Choose the "Off" to turn mute off.

Volume

- ▶ Press the ◀ to decrease the volume.
- ▶ Press the ▶ to increase the volume.

Projector ID

Allow the RS232 control of an individual projector. Range 01-99.

Setup | Signal

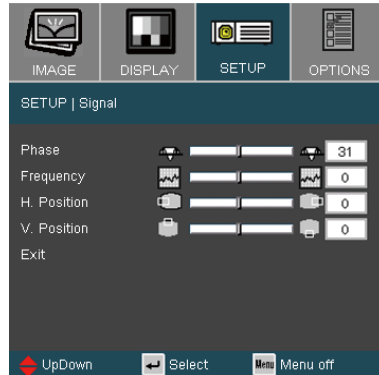

❖ “Signal” menu is only supported in Analog VGA (RGB) signal.

Phase

Synchronize the signal timing of the display with the graphic card. If you experience an unstable or flickering image, use this function to correct it.

Frequency

Change the display data frequency to match the frequency of your computer’s graphic card. If you experience a vertical flickering bar, use this function to make an adjustment.

H. Position

- ▶ Press the ◀ to move the image left.
- ▶ Press the ▶ to move the image right.

V. Position

- ▶ Press the ◀ to move the image down.
- ▶ Press the ▶ to move the image up.

Setup

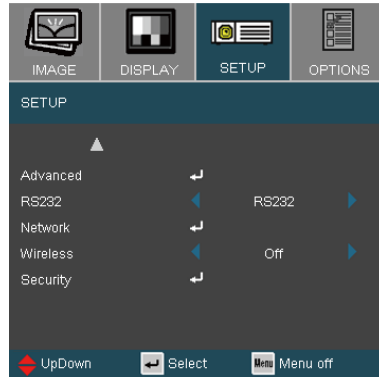

RS232

- ▶ RS232: Allow RS232 control of an individual projector.
- ▶ Network: Allow projector control via web browser (Internet Explorer) using the network (Default setting).

Wireless

Choose "On" to turn on the wireless mode.



- ❖ "Wireless" is only functional with optional wireless module.

Setup | Advanced

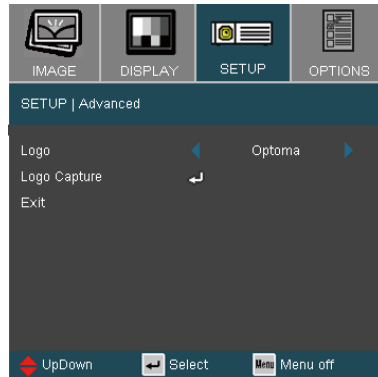

Logo

Use this function to select your desired startup screen. If you change the setting from one to another, when you exit the OSD menu, the new setting will take effect on next open.

- ▶ Optoma: The default startup screen of Optoma projector.
- ▶ User: Use memorize picture from “Logo Capture” function.

Logo Capture

Press “Enter” to immediately capture a picture what on the display screen.

Setup | Network

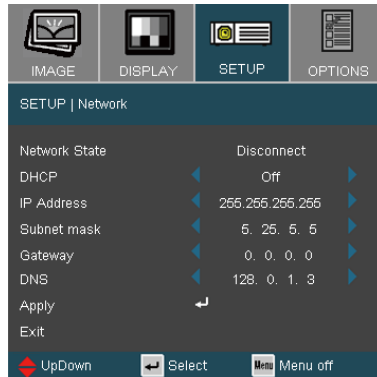

Network State

To display network information.

DHCP

Use this function to select your desired startup screen. If you change the setting from one to another, when you exit the OSD menu, the new setting will take effect on next open.

- ▶ On: Assign an IP address to the projector from the DHCP server automatically.
- ▶ Off: Assign an IP address manually.

IP Address

Select an IP address.

Subnet Mask

Select subnet mask number.

Gateway

Select the default gateway of the network connected to the projector.

DNS

Select DNS number.

Apply

Press “↵” to apply the selection.

User Controls

How to use web browser to control your projector

1. Fill in a new IP, a subnet mask, a gateway and a DNS in the dialogue box.

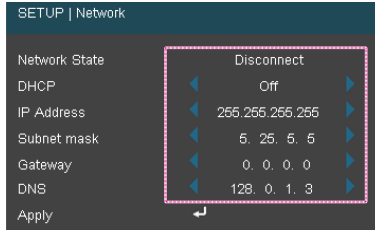

2. Then choose apply and press “↩” button to effectuate the configuration process.
3. Open your web browser and type in from the OSD LAN screen then the web page will display as below:



❖ When you used the projector IP address, you will not link to your service server.



4. Open “Control Panel” to control your projector.

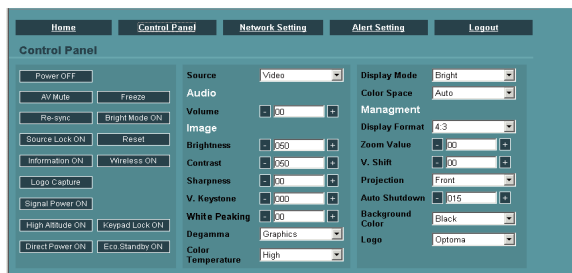

For example: Use Microsoft Internet Explorer (IE) web browser to control the projector , the IP address is [http:// 10.0.50.100](http://10.0.50.100).

Step 1: Find an IP Address (10.0.50.100) from LAN function of projector.



User Controls

Step 2: Select apply and press “Enter” button to submit function or press “menu” key to exit.

Step 3: To open Network Connections, click **Start**, click **Control Panel**, click **Network and Internet Connections**, and then click **Network Connections**. Click the connection you want to configure, and then, under **Network Tasks** , click **Change settings of this connection**.

Step 4: On the **General** tab, under **This connection uses the following items**, click

Internet Protocol (TCP/IP), and then click “Properties.”

Use a proxy server for your LAN check box., then click “OK” button twice.

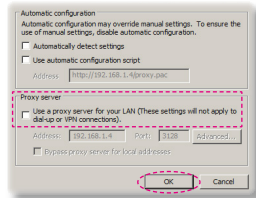
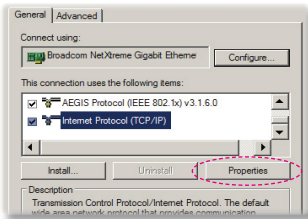

Step 5: Click **Use the following IP address**, and type in as below:

- 1) IP address: 10.0.50.XXX
- 2) Subnet mask: 255.255.0.0
- 3) Default gateway: 10.0.50.254

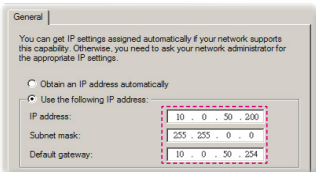

Step 8: Open your IE and type in the IP address of 10.0.50.100 in the URL then press “Enter” key. The web page will display as below:

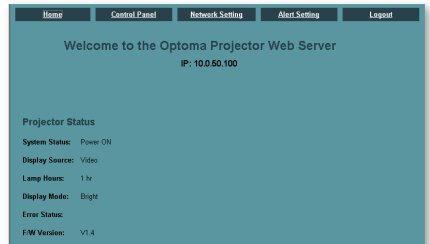

Step 6: To open Internet Options, click IE web browser, click Internet Options, click the **Connections** tab and click “LAN Settings...”

Step 9: Open “Control Panel” to control your projector.

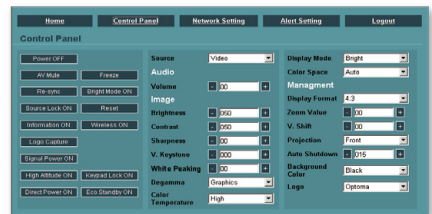
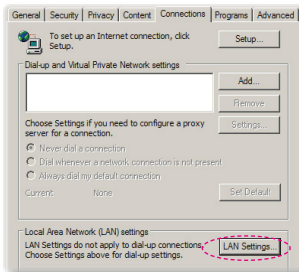

Step 7: The **Local Area Network (LAN) Setting** dialog box appears, In the **Proxy Server** area, cancel the

Setup | Security

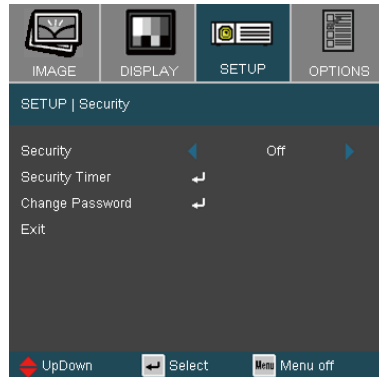

Security

- ▶ On: Choose “On” to use security verification when the turning on the projector.
- ▶ Off: Choose “Off” to be able to switch on the projector without password verification.

Security Timer

Select the time (Month/Day/Hour) function to set the number of hours the projector can be used. Once this time has elapsed you will be requested to enter your password again.



Setup | Security

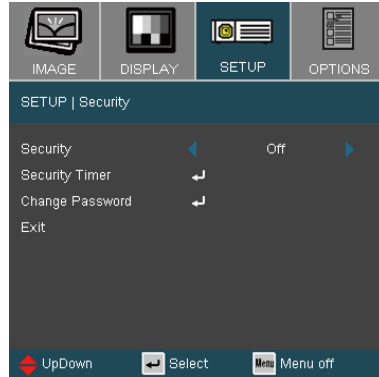

■ First Time:

1. The Password is 4 digits, DEFAULT VALUE is "1234". (first time)
2. Use number buttons on the remote to select your password, and then press "Enter" key to confirm your selection.

Change Password

1. Press "Enter" to input old password.
2. Use number button to enter current password, and then press "Enter" key again to reveal next OSD menu.
3. Scroll down to highlight Password, and then press "Enter" to activate.
4. Enter new password (4 digits in length) using the number buttons on the remote, then press "Enter" to confirm.
5. Enter new password again and press "Enter" to confirm.

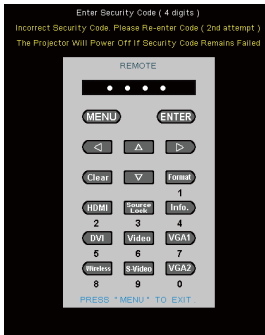

Options

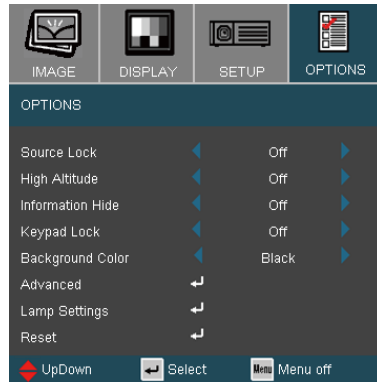

Source Lock

- ▶ On: The projector will search specified connection port.
- ▶ Off: The projector will search for other signals if the current input signal is lost.

High Altitude

Choose "On" to turn on High Altitude mode. Operates the fans at full speed continuously to allow for proper high altitude cooling of the projector.

Information Hide

- ▶ On: Choose "On" to hide the searching message.
- ▶ Off: Choose "Off" to show the searching message.

Keypad Lock

When the keypad lock function is on, the control panel will be locked, but the projector can still be operated by the remote control. If canceling this function, use the remote control or press the "Enter" key on the control panel for 10 seconds to turn it off.

Background Color

Use this feature to display a "Black", "Red", "Blue", "Green" or "White", screen when no signal is available.

Reset

Choose "Yes" to return the display parameters on all menus to the factory default settings.

Options | Advanced

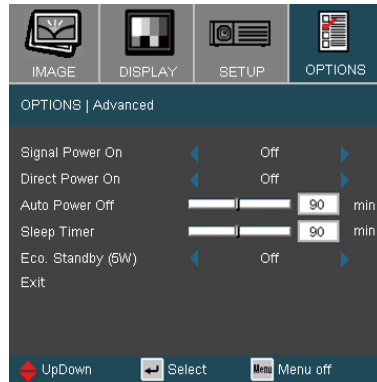

- ❖ When “Signal Power On” is enabled, the Economic Standby Mode will be auto set as Off (>5W)

Signal Power On

- ▶ On: The projector will automatically power on when plug in any signal source to the projector at standby mode. (*)
- ▶ Off: Turn on the projector to normal mode.

Direct Power On

Choose “On” to turn on Direct Power On mode. The projector will automatically power on when AC power is supplied, without pressing the “Power/Standby” key on the projector control panel or “” key on the remote control.

Auto Power Off

Sets the countdown timer interval. The countdown timer will start, when there is no signal being sent to the projector. Then projector will automatically power off when the countdown has finished (in minutes).

Sleep Timer

Set the countdown timer interval. The timer will begin, with or without a signal input. Then the projector will automatically power off then the sleep timer countdown has finished. (in minutes)



- ❖ When Economic Standby Mode is enabled (<5W), the Signal Power On function is disabled.

Eco. Standby (5W)

- Choose “On” to save power dissipation further(<5W).
- Choose “Off” to return to normal standby mode.(*)

Options | Lamp Settings

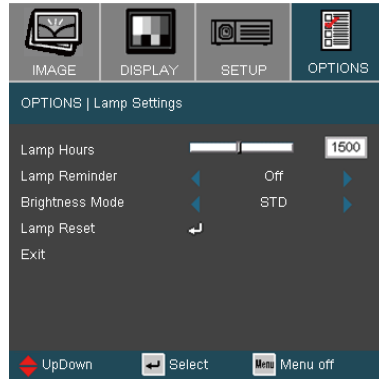

Lamp Hours

Display the projection time.

Lamp Reminder

Choose this function to show or to hide the warning message when the changing lamp message is displayed. The message will appear 30 hours before suggested replacement of lamp.

Brightness Mode

- ▶ **STD:** Choose “STD” to dim the projector lamp which will lower power consumption and extend the lamp life by up to 130%.
- ▶ **Bright:** Choose “Bright” to increase the brightness.

Lamp Reset

Reset the lamp life hour after replacing the lamp.

Troubleshooting

*If you experience a problem with your projector, please refer to the following information. If a problem persists, please contact your local reseller or service center.
(See pages 57-58 for details)*

Image Problems

[?] No image appears on-screen

- ▶ Ensure all the cables and power connections are correctly and securely connected as described in the “Installation” section.
- ▶ Ensure all the pins of connectors are not bent or broken.
- ▶ Check if the projection lamp has been securely installed. Please refer to the “Replacing the lamp” section.
- ▶ Make sure you have removed the lens cap and the projector is switched on.
- ▶ Ensure that the “AV mute” feature is not turned on.

[?] Partial, scrolling or incorrectly displayed image

- ▶ Press “Re-Sync” on the remote.
- ▶ If you are using a PC:

For Windows 95, 98, 2000, XP:

1. Open the “My Computer” icon, the “Control Panel” folder, and then double click on the “Display” icon.
2. Select the “Settings” tab.
3. Verify that your display resolution setting is lower than or equal to UXGA (1600 x 1200). (*)
4. Click on the “Advanced Properties” button.

If the projector is still not projecting the whole image, you will also need to change the monitor display you are using. Refer to the following steps.

5. Verify the resolution setting is lower than or equal to UXGA (1600 x 1200).



❖ (*) The resolution XGA (1024 x 768) is recommended for computer signal.

Appendices



- ❖ (*) The resolution XGA (1024 x 768) is recommended for computer signal.

6. Select the “Change” button under the “Monitor” tab.
 7. Click on “Show all devices”. Next, select “Standard monitor types” under the SP box; choose the resolution mode you need under the “Models” box.
 8. Verify that the resolution setting of the monitor display is lower than or equal to UXGA (1600 x 1200). (*)
- ▶ If you are using a Notebook:
 1. First, follow the steps above to adjust resolution of the computer.
 2. Press the toggle output settings. Example: [Fn]+[F4]

Acer ⇒	[Fn]+[F5]	IBM/Lenovo ⇒	[Fn]+[F7]
Asus ⇒	[Fn]+[F8]	HP/Compaq ⇒	[Fn]+[F4]
Dell ⇒	[Fn]+[F8]	NEC ⇒	[Fn]+[F3]
Gateway ⇒	[Fn]+[F4]	Toshiba ⇒	[Fn]+[F5]

Mac Apple:
System Preference ⇒ Display ⇒ Arrangement ⇒ Mirror display

- ▶ If you experience difficulty changing resolutions or your monitor freezes, restart all equipment including the projector.

[?] The screen of the Notebook or PowerBook computer is not displaying your presentation

- ▶ If you are using a Notebook PC
Some Notebook PCs may deactivate their own screens when a second display device is in use. Each has a different way to be reactivated. Refer to your computer’s manual for detailed information.

[?] Image is unstable or flickering

- ▶ Use “Phase” to correct it. See page 34 for more information.
- ▶ Change the monitor color setting on your computer.

[?] Image has vertical flickering bar

- ▶ Use “Frequency” to make an adjustment. See page 34 for more information.
- ▶ Check and reconfigure the display mode of your graphic card to make it compatible with the projector.

[?] Image is out of focus

- ▶ Make sure the lens cap is removed.
- ▶ Adjusts the Focus Ring on the projector lens.
- ▶ Make sure the projection screen is between the required distance 3.9 to 32.8 feet (1.2 to 10.0 meters) from the projector.
See page 18.

[?] The image is stretched when displaying 16:9 DVD title

When you play anamorphic DVD or 16:9 DVD, the projector will show the best image in 16:9 format on projector side.

If you play 4:3 format DVD title, please change the format as 4:3 in projector OSD.



If the image is still stretched, you will also need to adjust the aspect ratio by referring to the following:

- ▶ Please setup the display format as 16:9 (wide) aspect ratio type on your DVD player.

[?] Image is too small or too large

- ▶ Adjust the Zoom Ring on the top of the projector.
- ▶ Move the projector closer to or further from the screen.
- ▶ Press [Menu] button on the remote control or projector panel, go to "Display → Format" and try the different settings.

[?] Image has slanted sides

- ▶ If possible, reposition the projector so that it is centered on the screen and below the bottom of the screen.
- ▶ Press [Keystone] button on the remote control or press [ ] on the projector panel, until the sides are vertical .



❖ Use of Keystone is not recommended.

[?] Image is reversed

- ▶ Select "Setup → Projection" from the OSD and adjust the projection direction.

Intermission Problems

- [?]** The projector stops responding to all controls
 - ▶ If possible, turn off the projector, then unplug the power cord and wait at least 60 seconds before reconnecting power.
- [?]** Lamp burns out or makes a popping sound
 - ▶ When the lamp reaches its end of life, it will burn out and may make a loud popping sound. If this happens, the projector will not turn on until the lamp module has been replaced. To replace the lamp, follow the procedures in the “Replacing the Lamp” section on pages 50-51.

Projector Status Indication

[?] LED lighting message

Message	Power LED	Temp-LED	Lamp-LED
	(Blue/Red)	(Red)	(Red)
Standby State (Input power cord)	Red	○	○
Power on (Warming)	Flashing Blue	○	○
Lamp lighting	Blue	○	○
Power off (Cooling)	Flashing Red	○	○
Error (Over Temp.)	○	☀	○
Error (Fan fail)	○	Flashing (0.5s on, 0.5s off)	○
Error (Lamp fail)	○	○	☀



Steady light ⇔ ☀

No light ⇔ ○

? Message Reminders

▶ Fan failed:

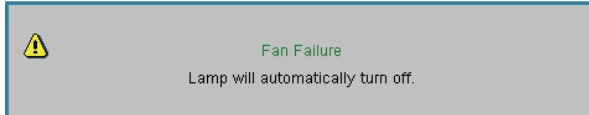

▶ Temperature warning:

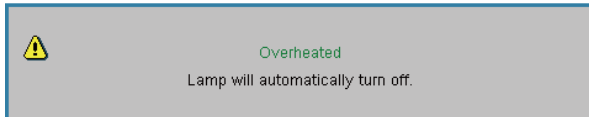

▶ Replacing the lamp:

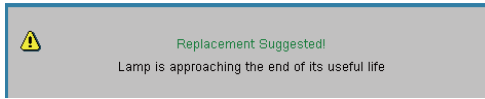

▶ Status Message:

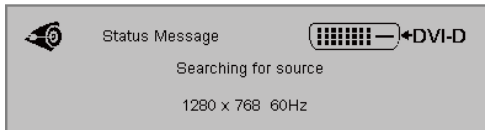

Remote Control Problems

? If the remote control does not work

- ▶ Check the operating angle for the remote control is approximately $\pm 22.5^\circ$.
- ▶ Make sure there are no obstructions between the remote control and the projector. Move to within 6 m (20 ft) of the projector.
- ▶ Make sure the batteries are inserted correctly.
- ▶ Replace weak batteries in the remote control.

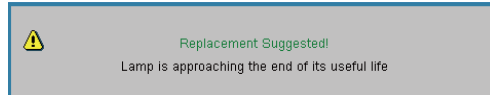

Replacing the lamp

The projector automatically detects the lamp life. When the lamp life is nearing the end of use, you will receive a warning message.



When you see this message, please contact your local reseller or service center to change the lamp as soon as possible. Make sure the projector has been cooled down for at least 30 minutes before changing the lamp.



-  Warning: If ceiling mounted, please use caution when opening the lamp access panel. It is recommended to wear safety glasses if changing the bulb when ceiling mounted. "Caution must be used to prevent any loose parts from falling out of projector."
-  Warning: Lamp compartment may be hot! Allow it to cool down before changing the lamp!
-  Warning: To reduce the risk of personal injury, do not drop the lamp module or touch the lamp bulb. The bulb may shatter and cause injury if it is dropped.

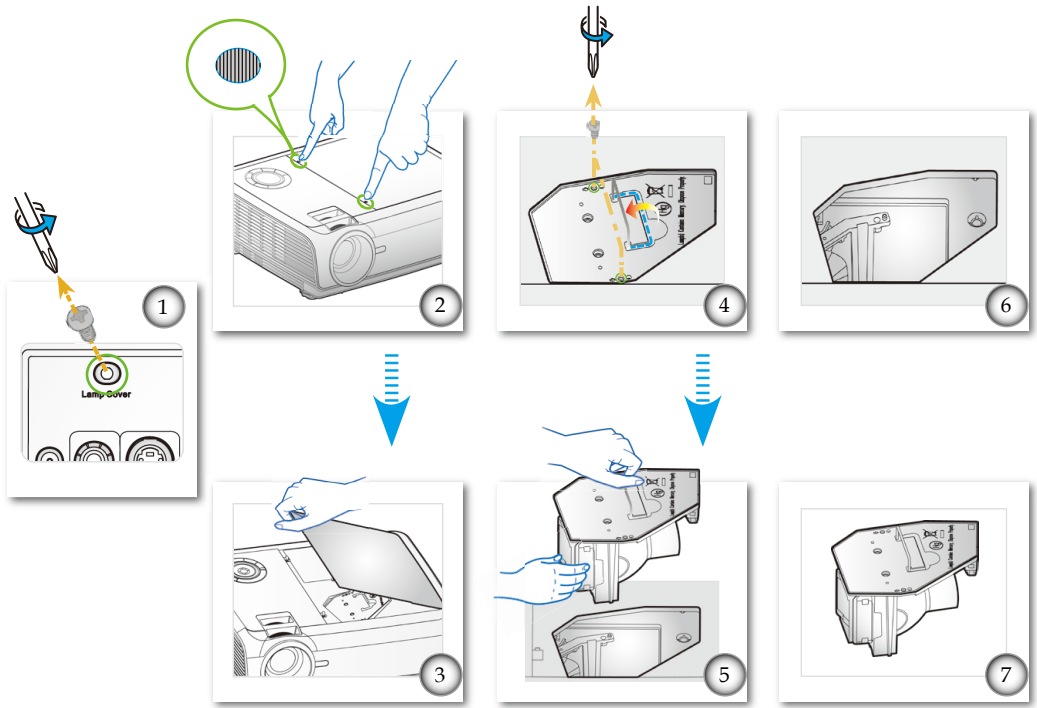

○ Lamp Replacement Procedure: ○

1. Switch off the power to the projector by pressing the “**⏻**” button.
2. Allow the projector to cool down for at least 30 minutes.
3. Disconnect the power cord.
4. Use a screwdriver to unscrew the screw (Lamp Cover) from the rear side. **①**
5. Press down the two “**⦿**” on the cover simultaneously. **②**
6. Open and remove the top cover. **③**
7. Use a screwdriver to unscrew the 2 screws from the lamp module. **④**
8. Pull up the lamp handle carefully. **⑤**
9. Remove the lamp module. **⑥ ⑦**

To replace the lamp module, reverse the previous steps.

10. Turn on the projector and use “Lamp Reset” after the lamp module is replaced.

Lamp Reset: (i) Press “Menu” → (ii) Select “Options” → (iii) Select “Lamp settings” → (iv) Select “Lamp reset” → (v) Select “Yes”.

Compatibility Modes

► Computer Compatibility

Mode	Resolution	V-Sync (Hz)	
		Analog	Digital
VGA	640 x 350	70, 85	70, 85
VGA	640 x 400	85	85
VGA	640 x 480	60, 72, 75, 85	60, 72, 75, 85
VGA	720 x 400	70, 85	70, 85
SVGA	800 x 600	56, 60, 72, 75, 85	56, 60, 72, 75, 85
XGA	1024 x 768	60, 70, 75, 85	60, 70, 75, 85
SXGA	1152 x 864	70, 75, 85	70, 75, 85
SXGA	1280 x 1024	60, 75, 85	60, 75, 85
SXGA+	1400 x 1050	60	60
UXGA	1600 x 1200	60	60
MAC LC 13"	640 x 480	66.66	***
MAC II 13"	640 x 480	66.68	***
MAC 16"	832 x 624	74.55	***
MAC 19"	1024 x 768	75	***
MAC	1152 x 870	75.06	***
MAC G4	640 x 480	60	***
i MAC DV	1024 x 768	75	***
i MAC DV	1152 x 870	75	***
i MAC DV	1280 x 960	60	***
WXGA	1280 x 720	60	60, 75, 85
WXGA	1280 x 768	60	60, 75, 85
WXGA	1280 x 800	60	60, 75, 85



❖ For widescreen resolution (WXGA), the compatibility support is dependent on Notebook/PC models."

► Video Compatibility

NTSC	M (3.58MHz), 4.43 MHz, 480i/p @60Hz
PAL	B, D, G, H, I, M, N, 576i/p @50Hz
SECAM	B, D, G, K, K1, L
SDTV/HDTV	480i/p, 576i/p, 720p@50Hz/60Hz, 1080i/p@50Hz/60Hz

RS232 Commands

RS232 Pin Assignments

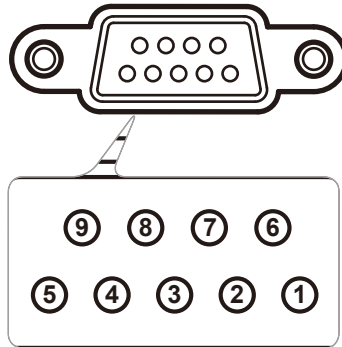

Pin no.	Spec.
1	N/A
2	RXD
3	TXD
4	N/A
5	GND
6	N/A
7	N/A
8	N/A
9	N/A

Appendices

RS232 Protocol Function List

RS232 Commands

Baud Rate : 9600

Data Bits: 8

Parity: None

Stop Bits: 1

Flow Control : None

UART16550 FIFO: Disable

Projector Return (Pass): P

Projector Return (Fail): F

XX=01-99, projector's ID,

XX=00 is for all projectors

SEND to projector

232 ASCII Code	HEX Code	Function	Description
--XX00 1	7E 30 30 30 20 31 0D	Power ON	
--XX00 2	7E 30 30 30 20 32 0D	Power OFF	
--XX00 1 -nmmn		Power On with Password	
--XX01	7E 30 30 32 20 31 0D	Resume	
--XX02 1	7E 30 30 32 20 31 0D	AV Mute	On
--XX02 2	7E 30 30 32 20 32 0D	Mute	Off
--XX03 1	7E 30 30 33 20 31 0D	Mute	Off
--XX03 2	7E 30 30 33 20 32 0D		On
--XX04 1	7E 30 30 34 20 31 0D	Freeze	
--XX04 2	7E 30 30 34 20 32 0D	Unfreeze	
--XX05 1	7E 30 30 35 20 31 0D	Zoom Plus	
--XX06 1	7E 30 30 36 20 31 0D	Zoom Minus	
--XX07 1	7E 30 30 37 20 31 0D	Up (Pan under zoom)	
--XX08 1	7E 30 30 38 20 31 0D	Down (Pan under zoom)	
--XX09 1	7E 30 30 39 20 31 0D	Left (Pan under zoom)	
--XX10 1	7E 30 30 31 20 31 0D	Right (Pan under zoom)	
--XX12 1	7E 30 31 32 20 31 0D	Direct Source Commands	HDMI
--XX12 2	7E 30 31 32 20 32 0D		DVI-D
--XX12 5	7E 30 31 32 20 35 0D		VGA 1
--XX12 6	7E 30 31 32 20 36 0D		VGA 2
--XX12 7	7E 30 31 32 20 37 0D		VGA 1 SCART
--XX12 8	7E 30 31 32 20 38 0D		VGA 1 Component
--XX12 9	7E 30 31 32 20 39 0D		S-Video
--XX12 10	7E 30 31 32 20 3A 0D		Video
--XX12 11	7E 30 31 32 20 3B 0D		Wireless
--XX12 13	7E 30 31 32 20 31 33 0D		VGA 2 Component
--XX20 1	7E 30 32 30 20 31 0D	Display Mode	Presentation
--XX20 2	7E 30 32 30 20 32 0D		Bright
--XX20 3	7E 30 32 30 20 33 0D		Movie
--XX20 4	7E 30 32 30 20 34 0D		sRGB
--XX20 5	7E 30 32 30 20 35 0D		User1
--XX20 6	7E 30 32 30 20 36 0D		User2
--XX21 n	7E 30 32 31 20 a 0D	Brightness	n = 0 (a=30) ~ 100 (a=31 30 30)
--XX22 n	7E 30 32 32 20 a 0D	Contrast	n = 0 (a=30) ~ 100 (a=31 30 30)
--XX23 n	7E 30 32 33 20 a 0D	Sharpness	n = 0 (a=30) ~ 31 (a=33 31)
--XX170 n	7E 30 31 37 30 20 a 0D	Color	Red Hue n = -50 (a=2D 35 30) ~ 50 (a=35 30)
--XX171 n	7E 30 31 37 31 20 a 0D		Red Saturation n = 0 (a=30) ~ 100 (a=31 30 30)
--XX172 n	7E 30 31 37 32 20 a 0D		Red Gain n = 0 (a=30) ~ 100 (a=31 30 30)
--XX173 n	7E 30 31 37 33 20 a 0D		Green Hue n = -50 (a=2D 35 30) ~ 50 (a=35 30)
--XX174 n	7E 30 31 37 34 20 a 0D		Green Saturation n = 0 (a=30) ~ 100 (a=31 30 30)
--XX175 n	7E 30 31 37 35 20 a 0D		Green Gain n = 0 (a=30) ~ 100 (a=31 30 30)
--XX176 n	7E 30 31 37 36 20 a 0D		Blue Hue n = -50 (a=2D 35 30) ~ 50 (a=35 30)
--XX177 n	7E 30 31 37 37 20 a 0D		Blue Saturation n = 0 (a=30) ~ 100 (a=31 30 30)
--XX178 n	7E 30 31 37 38 20 a 0D		Blue Gain n = 0 (a=30) ~ 100 (a=31 30 30)
--XX179 n	7E 30 31 37 39 20 a 0D		Cyan Hue n = -50 (a=2D 35 30) ~ 50 (a=35 30)
--XX180 n	7E 30 31 38 30 20 a 0D		Cyan Saturation n = 0 (a=30) ~ 100 (a=31 30 30)
--XX181 n	7E 30 31 38 31 20 a 0D		Cyan Gain n = 0 (a=30) ~ 100 (a=31 30 30)
--XX182 n	7E 30 33 32 20 a 0D		Yellow Hue n = -50 (a=2D 35 30) ~ 50 (a=35 30)
--XX183 n	7E 30 33 33 20 a 0D		Yellow Saturation n = 0 (a=30) ~ 100 (a=31 30 30)
--XX184 n	7E 30 33 34 20 a 0D		Yellow Gain n = 0 (a=30) ~ 100 (a=31 30 30)
--XX185 n	7E 30 31 38 30 20 a 0D		Magenta Hue n = -50 (a=2D 35 30) ~ 50 (a=35 30)
--XX186 n	7E 30 31 38 31 20 a 0D		Magenta Saturation n = 0 (a=30) ~ 100 (a=31 30 30)
--XX187 n	7E 30 33 32 20 a 0D		Magenta Gain n = 0 (a=30) ~ 100 (a=31 30 30)
--XX188 n	7E 30 33 33 20 a 0D		Reset
--XX34 n	7E 30 33 34 20 a 0D	White Peaking	n = 0 (a=30) ~ 10 (a=31 30)
--XX35 1	7E 30 33 35 20 31 0D	Degamma	Film
--XX35 2	7E 30 33 35 20 32 0D		Video
--XX35 3	7E 30 33 35 20 33 0D		Graphics
--XX35 4	7E 30 33 35 20 34 0D		PC
--XX36 1	7E 30 33 36 20 31 0D	Color Temp.	Warm
--XX36 2	7E 30 33 36 20 32 0D		Medium
--XX36 3	7E 30 33 36 20 33 0D		Cold
--XX37 1	7E 30 33 37 20 31 0D	Color Space	Auto
--XX37 2	7E 30 33 37 20 32 0D		RGB
--XX37 3	7E 30 33 37 20 33 0D		YUV
--XX60 1	7E 30 36 30 20 31 0D	Format	4:3
--XX60 2	7E 30 36 30 20 32 0D		16:9-I
--XX60 3	7E 30 36 30 20 33 0D		16:9-II
--XX60 4	7E 30 36 30 20 34 0D		Window
--XX61 n	7E 30 36 31 20 a 0D	Overscan	n = 0 (a=30) ~ 3 (a=33)
--XX62 n	7E 30 36 32 20 a 0D	Zoom	n = 0 (a=30) ~ 20 (a=32 30)
--XX64 n	7E 30 36 34 20 a 0D	V Image Shift	n = 0 (a=30) ~ 100 (a=31 30 30)
--XX66 n	7E 30 36 36 20 a 0D	V Keystone	n = -40 (a=2D 34 30) ~ 40 (a=34 30)
--XX70 1	7E 30 37 30 20 31 0D	Language	English
--XX70 2	7E 30 37 30 20 32 0D		German
--XX70 3	7E 30 37 30 20 33 0D		French
--XX70 4	7E 30 37 30 20 34 0D		Italian
--XX70 5	7E 30 37 30 20 35 0D		Spanish
--XX70 6	7E 30 37 30 20 36 0D		Portuguese
--XX70 7	7E 30 37 30 20 37 0D		Polish
--XX70 8	7E 30 37 30 20 38 0D		Dutch
--XX70 9	7E 30 37 30 20 39 0D		Swedish
--XX70 10	7E 30 37 30 20 31 30 0D		Norwegian/Danish
--XX70 11	7E 30 37 30 20 31 31 0D		Finnish
--XX70 12	7E 30 37 30 20 31 32 0D		Greek
--XX70 13	7E 30 37 30 20 31 33 0D		Traditional Chinese
--XX70 14	7E 30 37 30 20 31 34 0D		Simplified Chinese
--XX70 15	7E 30 37 30 20 31 35 0D		Japanese
--XX70 16	7E 30 37 30 20 31 36 0D		Korean
--XX70 17	7E 30 37 30 20 31 37 0D		Russian
--XX70 18	7E 30 37 30 20 31 38 0D		Hungarian
--XX70 19	7E 30 37 30 20 31 39 0D		Czechoslovak
--XX70 20	7E 30 37 30 20 32 30 0D		Arabic
--XX70 21	7E 30 37 30 20 32 31 0D		Thai
--XX71 1	7E 30 37 31 20 31 0D	Projection	Front-Desktop
--XX71 2	7E 30 37 31 20 32 0D		Rear-Desktop
--XX71 3	7E 30 37 31 20 33 0D		Front-Ceiling
--XX71 4	7E 30 37 31 20 34 0D		Rear-Ceiling
--XX72 1	7E 30 37 32 20 31 0D	Menu Location	Top Left
--XX72 2	7E 30 37 32 20 32 0D		Top Right
--XX72 3	7E 30 37 32 20 33 0D		Centre
--XX72 4	7E 30 37 32 20 34 0D		Bottom Left
--XX72 5	7E 30 37 32 20 35 0D		Bottom Right



1. There is a <CR> after all ASCII commands.

2. 0D is the HEX code for <CR> in ASCII code.

Appendices

SEND to projector

232 ASCII Code	HEX Code	Function	Projector Return	Description
~XX73 n	7E 30 30 37 33 20 a 0D	Signal	Frequency	n = -100 (a=2D 31 30 30) ~ 100 (a=31 30 30)
~XX74 n	7E 30 30 37 34 20 a 0D		Phase	n = 0 (a=30) ~ 63 (a=36 33)
~XX75 n	7E 30 30 37 35 20 a 0D		H. Position	n = -100 (a=2D 31 30 30) ~ 100 (a=31 30 30)
~XX76 n	7E 30 30 37 36 20 a 0D		V. Position	n = -100 (a=2D 31 30 30) ~ 100 (a=31 30 30)
~XX77 n	7E 30 30 37 37 20 aabcc 0D	Security	Security Timer	Month/Day/Hour n = mm/dd/hh mm = 00 (aa=30 30) ~ 99 (aa=39 39) dd = 00 (bb=30 30) ~ 29 (bb=32 39) hh = 00 (cc=30 30) ~ 23 (cc=32 33)
~XX78 1	7E 30 30 37 38 20 31 0D		Security Settings	Enable
~XX78 2	7E 30 30 37 38 20 32 0D			Disable
~XX79 n	7E 30 30 37 39 20 a 0D	Projector ID		n = 01 (a=30 31) ~ 99 (a=39 39)
~XX80 1	7E 30 30 38 30 20 31 0D	Mute	On	
~XX80 2	7E 30 30 38 30 20 32 0D		Off	
~XX81 n	7E 30 30 38 31 20 a 0D	Volume		n = 0 (a=30) ~ 10 (a=31 30)
~XX82 1	7E 30 30 38 32 20 31 0D	Logo	Optoma	User
~XX82 2	7E 30 30 38 32 20 32 0D			
~XX83 1	7E 30 30 38 33 20 31 0D	Logo Capture		
~XX86 1	7E 30 30 38 36 20 31 0D	RS232 Port	RS232	Network
~XX86 2	7E 30 30 38 36 20 32 0D			
~XX100 1	7E 30 30 31 30 30 20 31 0D	Source Lock	On	
~XX100 2	7E 30 30 31 30 30 20 32 0D		Off	
~XX101 1	7E 30 30 31 30 31 20 31 0D	High Altitude	On	
~XX101 2	7E 30 30 31 30 31 20 32 0D		Off	
~XX102 1	7E 30 30 31 30 32 20 31 0D	Information Hide	On	
~XX102 2	7E 30 30 31 30 32 20 32 0D		Off	
~XX103 1	7E 30 30 31 30 33 20 31 0D	Keypad Lock	On	
~XX103 2	7E 30 30 31 30 33 20 32 0D		Off	
~XX104 1	7E 30 30 31 30 34 20 31 0D	Background Color	Blue	
~XX104 2	7E 30 30 31 30 34 20 32 0D		Black	
~XX104 3	7E 30 30 31 30 34 20 33 0D		Red	
~XX104 4	7E 30 30 31 30 34 20 34 0D		Green	
~XX104 5	7E 30 30 31 30 34 20 35 0D		White	
~XX105 1	7E 30 30 31 30 35 20 31 0D	Advanced	Direct Power On	On
~XX105 2	7E 30 30 31 30 35 20 32 0D		Off	
~XX113 1	7E 30 30 31 31 33 20 31 0D		Signal Power On	On
~XX113 2	7E 30 30 31 31 33 20 32 0D		Off	
~XX106 n	7E 30 30 31 30 36 20 a 0D		Auto Power Off (min)	n = 0 (a=30) ~ 999 (a=39 39 39)
~XX107 n	7E 30 30 31 30 37 20 a 0D		Sleep Timer (min)	n = 0 (a=30) ~ 999 (a=39 39 39)
~XX108 1	7E 30 30 31 30 38 20 31 0D	Lamp Setting	Lamp Hours	On
~XX108 2	7E 30 30 31 30 38 20 32 0D		Lamp Reminder	Off
~XX109 2	7E 30 30 31 30 39 20 32 0D		On	
~XX110 1	7E 30 30 31 31 30 30 31 0D		Brightness Mode	Bright
~XX110 2	7E 30 30 31 31 30 30 32 0D			STD
~XX111 1	7E 30 30 31 31 31 20 31 0D		Lamp Reset	Yes
~XX111 2	7E 30 30 31 31 31 20 32 0D			No
~XX112 1	7E 30 30 31 31 32 20 31 0D	Reset		Yes
~XX112 2	7E 30 30 31 31 32 20 32 0D			No

SEND to Remote

~XX140 1	7E 30 30 31 34 30 20 31 0D		Power	
~XX140 2	7E 30 30 31 34 30 20 32 0D		Re-sync	
~XX140 3	7E 30 30 31 34 30 20 33 0D		Keystone	
~XX140 4	7E 30 30 31 34 30 20 34 0D		AV Mute	
~XX140 5	7E 30 30 31 34 30 20 35 0D		Freeze	
~XX140 6	7E 30 30 31 34 30 20 36 0D		Display	
~XX140 7	7E 30 30 31 34 30 20 37 0D		Zoom in	
~XX140 8	7E 30 30 31 34 30 20 38 0D		Zoom out	
~XX140 9	7E 30 30 31 34 30 20 39 0D		Volume +	
~XX140 10	7E 30 30 31 34 30 20 31 0D		Volume -	
~XX140 11	7E 30 30 31 34 30 20 31 31 0D		Enter	
~XX140 12	7E 30 30 31 34 30 20 31 32 0D		Menu	
~XX140 13	7E 30 30 31 34 30 20 31 33 0D		Left	
~XX140 14	7E 30 30 31 34 30 20 31 34 0D		Up	
~XX140 15	7E 30 30 31 34 30 20 31 35 0D		Right	
~XX140 16	7E 30 30 31 34 30 20 31 36 0D		Down	
~XX140 17	7E 30 30 31 34 30 20 31 37 0D		Clear	
~XX140 18	7E 30 30 31 34 30 20 31 38 0D		Format (1)	
~XX140 19	7E 30 30 31 34 30 20 31 39 0D		HDMI (2)	
~XX140 20	7E 30 30 31 34 30 20 32 30 0D		Source Lock (3)	
~XX140 21	7E 30 30 31 34 30 20 32 31 0D		Info. (4)	
~XX140 22	7E 30 30 31 34 30 20 32 32 0D		DVI (5)	
~XX140 23	7E 30 30 31 34 30 20 32 33 0D		Video (6)	
~XX140 24	7E 30 30 31 34 30 20 32 34 0D		VGA 1 (7)	
~XX140 25	7E 30 30 31 34 30 20 32 35 0D		Wireless (8)	
~XX140 26	7E 30 30 31 34 30 20 32 36 0D		S-Video (9)	
~XX140 27	7E 30 30 31 34 30 20 32 37 0D		VGA 2 (0)	

SEND from projector automatically

232 ASCII Code	HEX Code	Function	Projector Return	Description
when Standby/Warming/Cooling/Out of Range/Lamp fail			INFO n	0: 0/1/2/3/4 = Standby/Warming/Cooling/Out of Range/Lamp fail
READ from projector				
232 ASCII Code	HEX Code	Function	Projector Return	Description
~XX121 1	7E 30 30 31 32 31 20 31 0D	Input Source Commands	Ok n	n : 0/1/2/3/4/5/6/7 = None/DVI/VGA1/VGA2/S-Video/Video/HDMI/Wireless
~XX122 1	7E 30 30 31 32 32 20 31 0D	Software Version	Ok d d	
~XX123 1	7E 30 30 31 32 33 20 31 0D	Display Mode	Ok n	n : 0/1/2/3/4/5 = Presentation/Bright/Movie/sRGB/User1/User2
~XX124 1	7E 30 30 31 32 34 20 31 0D	Power State	Ok n	n : 1.0 = On/Off
~XX125 1	7E 30 30 31 32 35 20 31 0D	Brightness	Ok n	
~XX126 1	7E 30 30 31 32 36 20 31 0D	Contrast	Ok n	
~XX127 1	7E 30 30 31 32 37 20 31 0D	Aspect Ratio	Ok n	n : 0/1/2/3 = 4:3/16:9-1/16:9-II/Window
~XX128 1	7E 30 30 31 32 38 20 31 0D	Color Temperature	Ok n	n : 0/1/2 = Warm/Medium/Cold
~XX129 1	7E 30 30 31 32 39 20 31 0D	Projection Mode	Ok n	n : 0/1/2/3 = Front-Desktop/ Rear-Desktop/ Front-Ceiling/ Rear-Ceiling
~XX150 1	7E 30 30 31 35 30 20 31 0D	Information	OK a b b b c c c c d d d d e	a : 1.0=On/Off b b b b : Lamp hour c c : source 00/01.02/03/04/05.06/07 = None/DVI/VGA1/VGA2/S-Video/Video/HDMI/Wireless d d d d : FW version e : Display mode = Presentation/Bright/ Movie/sRGB/User1/User2 n : 01 = EP776/EP782
~XX151 1	7E 30 30 31 35 31 20 31 0D	Model name	Ok n	

Ceiling Mount Installation

1. To prevent damaging your projector, please use the Optoma's recommended mount package for installation.
2. If you wish to use a third party ceiling mount kit, please ensure the screws used to attached a mount to the projector met the following specifications:
 - ▶ Screw type: M4
 - ▶ Screw length: 8mm



❖ Please note that damage resulting from incorrect installation will invalidate the warranty.



⚠ Warning:

1. If you buy the ceiling mount from other company, please ensure that there is at least 10cm distance between the bottom cover of the projector and the ceiling.
2. Avoid placing the projector near sources of heat such as air-conditioning units and heaters, otherwise, it may overheat and shut down automatically.

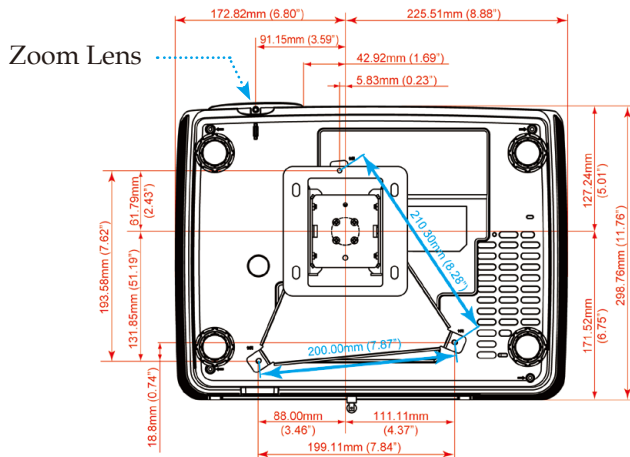
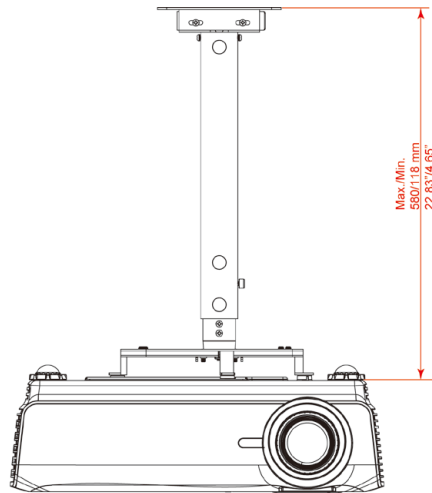

Optoma Global Offices

For service or support please contact your local office.

USA

715 Sycamore Drive
Milpitas, CA 95035, USA
www.optomausa.com

Tel : 408-383-3700
Fax : 408-383-3702
Service : services@optoma.com

Canada

5630 Kennedy Road, Mississauga,
ON, L4Z 2A9, Canada
www.optoma.ca

Tel : 905-361-2582
Fax : 905-361-2581

Europe

42 Caxton Way, The Watford Business Park
Watford, Hertfordshire,
WD18 8QZ, UK
www.optoma.eu
Service Tel : +44 (0)1923 691865

Tel : +44 (0) 1923 691 800
Fax : +44 (0) 1923 691 888
Service : service@tsc-europe.com

France

Bâtiment E
81-83 avenue Edouard Vaillant
92100 Boulogne Billancourt, France

Tel.: +33 1 41 46 12 20
Fax : +33 1 41 46 94 35
Service : savoptoma@optoma.fr

Spain

Paseo de la Castellana
135 7 Planta
Madrid, Spain

Tel.: +34 91 790 67 01
+34 91 790 67 02
Fax : + 34 91 790 68 69

Deutschland

Werftstrasse 25
D40549 Düsseldorf,
Germany

Tel : +49 (0) 211 506 6670
Fax : +49 (0) 211 506 66799
Service : info@optoma.de

Scandinavia

Grev Wedels Plass 2
3015 Drammen
Norway

Tel : +47 32 26 89 90
Fax : +47 32 83 78 98
Service : info@optoma.no

Latin America

715 Sycamore Drive
Milpitas, CA 95035, USA
www.optoma.com.br

Tel : 408-383-3700
Fax : 408-383-3702
www.optoma.com.mx

Appendices

Korean

WOOMI TECH.CO.,LTD.

4F,Minu Bldg.33-14, Kangnam-Ku, Seoul,135-815, KOREA

Tel : +82+2+34430004

Fax : +82+2+34430005

Japanese

東京都足立区綾瀬3-25-18

オーエス本社ビル

サポートセンター:0120-46-5040

E-mail : info@osscreen.com

www.os-worldwide.com

Taiwan

5F., No. 108, Minchiuan Rd.

Shindian City,

Taipei Taiwan 231, R.O.C.

www.optoma.com.tw

Tel : +886-2-2218-2360

Fax : +886-2-2218-2313

Service : services@optoma.com.tw

asia.optoma.com

Hong Kong

Unit A, 27/F Dragon Centre,

79 Wing Hong Street,

Cheung Sha Wan,

Kowloon, Hong Kong

Tel : +852-2396-8968

Fax : +852-2370-1222

www.optoma.com.hk

China

5F, No. 1205, Kaixuan Rd.,

Changning District

Shanghai, 200052, China

Tel : +86-21-62947376

Fax : +86-21-62947375

www.optoma.com.cn

Regulation & Safety notices

This appendix lists the general notices of your projector.

FCC notice

This device has been tested and found to comply with the limits for a Class B digital device pursuant to Part 15 of the FCC rules. These limits are designed to provide reasonable protection against harmful interference in a residential installation. This device generates, uses, and can radiate radio frequency energy and, if not installed and used in accordance with the instructions, may cause harmful interference to radio communications.

However, there is no guarantee that interference will not occur in a particular installation. If this device does cause harmful interference to radio or television reception, which can be determined by turning the device off and on, the user is encouraged to try to correct the interference by one or more of the following measures:

- Reorient or relocate the receiving antenna.
- Increase the separation between the device and receiver.
- Connect the device into an outlet on a circuit different from that to which the receiver is connected.
- Consult the dealer or an experienced radio/television technician for help.

Notice: Shielded cables

All connections to other computing devices must be made using shielded cables to maintain compliance with FCC regulations.

Caution

Changes or modifications not expressly approved by the manufacturer could void the user's authority, which is granted by the Federal Communications Commission, to operate this computer.

Operation conditions

This device complies with Part 15 of the FCC Rules. Operation is subject to the following two conditions:

1. This device may not cause harmful interference, and
2. This device must accept any interference received, including interference that may cause undesired operation.

Notice: Canadian users

This Class B digital apparatus complies with Canadian ICES-003.

Remarque à l'intention des utilisateurs canadiens

Cet appareil numérique de la classe B est conforme à la norme NMB-003 du Canada.

Declaration of Conformity for EU countries

- EMC Directive 89/336/EEC (including amendments)
- Low Voltage Directive 73/23/EEC (amended by 93/68/EEC)
- R & TTE Directive 1999/EC (if product has RF function)

Disposal instructions



Do not throw this electronic device into the trash when discarding. To minimize pollution and ensure utmost protection of the global environment, please recycle it.