

***myprojectorlamps.com***

**The most trusted, dependable name  
in projector lamp sales.**



<http://www.myprojectorlamps.com>



<http://www.myprojectorlamps.ca>





<http://www.myprojectorlamps.eu>

The following projector manual has not been modified or altered in any way.

# Table of Contents

<b>Table of Contents</b> .....	1
<b>Usage Notice</b> .....	2
Safety Information .....	2
Precautions .....	4
Eye Safety Warnings .....	6
<b>Introduction</b> .....	7
Package Overview .....	8
Product Overview .....	9
Main Unit .....	9
Control Panel .....	10
Rear View .....	11
Remote Control .....	12
Connecting the Projector .....	13
Connect to Computer / Notebook .....	13
<b>Installation</b> .....	13
Connect to Video Sources .....	14
Powering On / Off the Projector .....	15
Powering On the Projector .....	15
Powering Off the Projector .....	16
Warning Indicator .....	16
Adjusting the Projected Image .....	17
Adjusting the Projector's Height .....	17
Adjusting the Zoom / Focus (0.7 XGA Series) .....	18
Adjusting Projection Image Size .....	18
Adjusting the Zoom / Focus (0.55" XGA Series) .....	19
Adjusting Projection Image Size .....	19
Adjusting the Zoom / Focus (0.65 WXGA Series) .....	20
Adjusting Projection Image Size .....	20
<b>User Controls</b> .....	21
Control Panel & Remote Control .....	21
On-screen Display Menus .....	24
How to operate .....	24
Menu Tree .....	25
Image .....	26
Display .....	31
Setup .....	33
Options .....	43
LAN_RJ45 (RJ45 models only) .....	48
<b>Appendices</b> .....	51
Troubleshooting .....	51
Image Problems .....	51
Intermission Problems .....	53
Projector Status Indication .....	54
Remote Control Problems .....	55
Audio Problems .....	55
Replacing the Lamp .....	56
Cleaning the Projector .....	57
Compatibility Modes .....	58
RS232 Commands .....	60
RS232 Protocol Function List .....	61
Ceiling Installation .....	64
Optoma Global Offices .....	65
Regulation & Safety notices .....	67
Operation conditions .....	68

## Safety Information

	The lightning flash with arrow head within an equilateral triangle is intended to alert the user to the presence of uninsulated "dangerous voltage" within the product's enclosure that may be of sufficient magnitude to constitute a risk of electric shock to persons.
	The exclamation point within an equilateral triangle is intended to alert the user to the presence of important operating and maintenance (servicing) instructions in the literature accompanying the appliance.

**WARNING:** TO REDUCE THE RISK OF FIRE OR ELECTRIC SHOCK, DO NOT EXPOSE THE PROJECTOR TO RAIN OR MOISTURE. DANGEROUS HIGH VOLTAGES ARE PRESENT INSIDE THE ENCLOSURE. DO NOT OPEN THE CABINET.

REFER SERVICING TO QUALIFIED PERSONNEL ONLY.

### Class B emissions limits

This Class B digital apparatus meets all requirements of the Canadian Interference-Causing Equipment Regulations.

### Important Safety Instruction

1. Read these instructions –before using this projector.
2. Keep these instructions –for future reference.
3. Follow all instructions.
4. Install in accordance with the manufacturer's instructions :
  - A. **Do not block any ventilation openings.** To ensure reliable operation of the projector and to protect it from overheating, put the projector in a position and location that will not interfere with its proper ventilation. For example, do not place the projector on a bed, sofa, carpet, or similar surface that may block the ventilation openings. Do not put it in an enclosure, such as a bookcase or a cabinet that may keep air from flowing through its ventilation openings.
  - B. **Do not use this projector near water or moisture.** To reduce the risk of fire or electric shock, do not expose the projector to rain or moisture.
  - C. **Do not install near any heat sources,** such as radiators, heaters, stoves or other apparatus (including amplifiers) that produce heat.
5. Clean only with a dry cloth.
6. Only use attachments/accessories specified by the manufacturer.
7. Refer all servicing to qualified service personnel. Servicing is required when the projector has been damaged in any way, such as:
  - Power supply cord or plug is damaged.
  - Liquids have spilled or objects have fallen into the apparatus.
  - The projector has been exposed to rain or moisture, does not operate normally, or has been dropped.



# *Usage Notice*

Do not attempt to service this projector yourself. Opening or removing covers may expose you to dangerous voltages or other hazards. Please call Optoma to be referred to an authorized service center near you.

8. Do not let objects or liquids enter the projector as they may touch dangerous voltage points or short-out parts that could result in a fire or electric shock.
9. See projector enclosure for safety related markings.
10. The projector should not be adjusted or repaired by anyone except properly qualified service personnel.

# Precautions



*Please follow all warnings, precautions and maintenance as recommended in this user's guide.*



❖ When the lamp reaches the end of its life, the projector will not turn back on until the lamp module has been replaced. To replace the lamp, follow the procedures listed under “Replacing the Lamp” section on page 56.

- Warning - Do not look into the projector's lens when the lamp is on. The bright light may damage your eyes.
- Warning - To reduce the risk of fire or electric shock, do not expose this projector to rain or moisture.
- Warning - Please do not open or disassemble the projector as this may cause electric shock.
- Warning - When replacing the lamp, please allow unit to cool down, and follow all replacement instructions. See page 56.
- Warning - This projector will detect the life of the lamp itself. Please be sure to change the lamp when it shows warning messages.
- Warning - Use the “Lamp Reset” function from the on-screen display “Options | Lamp Settings” menu after replacing the lamp module (see page 47).
- Warning - When switching the projector off, please ensure the cooling cycle has been completed before disconnecting the power. Allow 90 seconds for the projector to cool down.
- Warning - Do not use the lens cap when projector is in operation.
- Warning - When the lamp is approaching the end of its life, the message “Lamp is approaching the end of its useful life” displays on the screen. Please contact your local reseller or service center to change the lamp as soon as possible.
- Warning - To reduce the risk of injury to the eyes, do not look directly into the laser beam on the remote control and do not point the laser beam into anyone's eyes. This remote control is equipped with a Class II laser that emits radiation.

## Do:

- ❖ Turn off the product before cleaning.
- ❖ Use a soft cloth moistened with a mild detergent to clean the display housing.
- ❖ Disconnect the power plug from the AC outlet if the product is not being used for a long period of time.

## Don't:

- ❖ Do not block the ventilation slots and openings on the unit.
- ❖ Do not use abrasive cleaners, waxes or solvents to clean the unit.
- ❖ Do not use under the following conditions:
  - In extremely hot, cold or humid environments. Ensure that the ambient room temperature is within 5-40 °C and relative humidity is 10-85% (max.), non-condensing.
  - In areas susceptible to excessive dust and dirt.
  - Near any appliance that generates a strong magnetic field.
  - In direct sunlight.

## Eye Safety Warnings



- Avoid staring directly into the projector's beam of light at all times.
- Minimize standing facing into the beam. Keep your back to the beam as much as possible.
- Using a stick or laser pointer is recommended to avoid the need for the presenter to enter the beam.
- Ensure that projectors are located out of the line of sight from the screen to the audience; this ensures that, when presenters look at the audience, they do not also have to stare at the projector lamp. The best way to achieve this is by ceiling-mounting the projector rather than placing it on floor or table top.
- When projector is used in a classroom, adequately supervise students when they are asked to point out something on the screen.
- In order to minimize the lamp power needed, use room blinds to reduce ambient light levels.

## Product Features

This product is a single chip 0.55"/0.7" XGA series and 0.65" WXGA series DLP® projector. Outstanding features include:

- ◆ Texas Instruments Single chip DLP® Technology
- ◆ Computer Compatibility:
  - Apple Macintosh, iMac, and VESA Standards:  
UXGA, SXGA+, SXGA, WXGA, WUXGA, XGA, SVGA, VGA
- ◆ Video Compatibility:
  - NTSC, NTSC4.43
  - PAL/PAL-M/PAL-N/SECAM
  - SDTV and EDTV compatible
  - HDTV compatible (720p, 1080i, 1080p)
- ◆ Auto source detection with user definable settings
- ◆ Fully featured IR remote control with laser pointer and mouse control
- ◆ User friendly multilingual On Screen Menu
- ◆ Advanced digital keystone correction and high quality full screen image re-scaling
- ◆ User friendly control panel
- ◆ One built-in speaker with 3 Watt amplifier
- ◆ Macintosh and PC compatible



## Package Overview

This projector comes with all the items shown below. Check to make sure your unit is complete. Contact your dealer immediately if anything is missing.

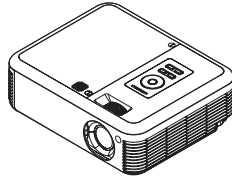

Projector with lens cover

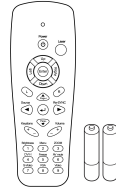

IR Remote Control  
(with 2 x AAA Batteries)



Composite cable  
(RCA)



Power Cord  
1.8m

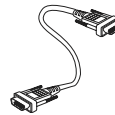

VGA Cable  
1.8m

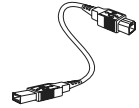

USB Cable  
1.8m

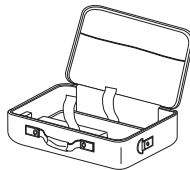

Carrying Case

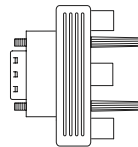

RGB to Component  
Adapter  
(optional)

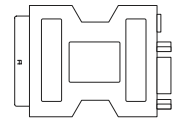

SCART to RGB &  
S-Video Adapter  
(optional)



❖ Due to the difference in applications for each country, some regions may have different accessories.

### Documentation:

- User's Manual
- Warranty Card
- Quick Start Card
- WEEE Card

## Product Overview Main Unit

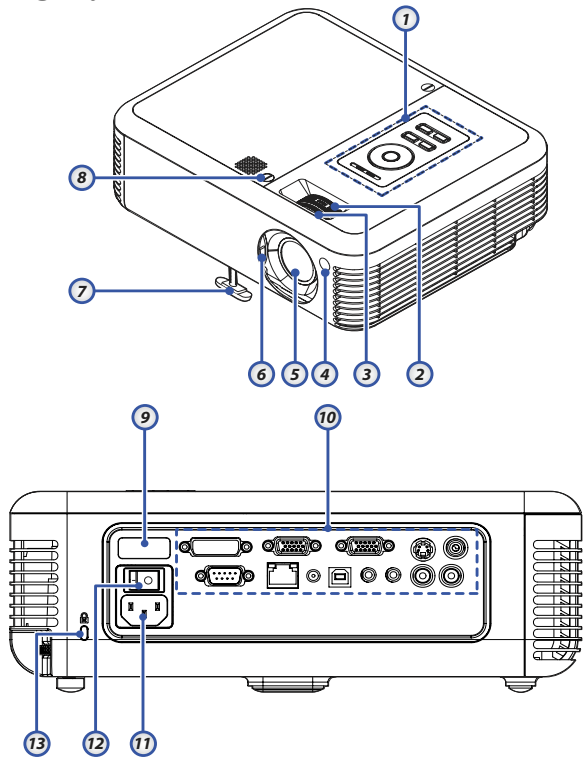

- |                      |  |
|----------------------|--|
| 1. Control Panel     | 8. Captive Screws  |
| 2. Zoom              | 9. Rear IR Receiver  |
| 3. Focus             | 10. Connection Ports<br>(RJ45 function is dependent on<br>the model purchased) |
| 4. Front IR Receiver | 11. Power Socket   |
| 5. Lens              | 12. Power Switch   |
| 6. Lens Cover        | 13. Kensington™ Lock   |
| 7. Elevator foot     |  |

## Control Panel

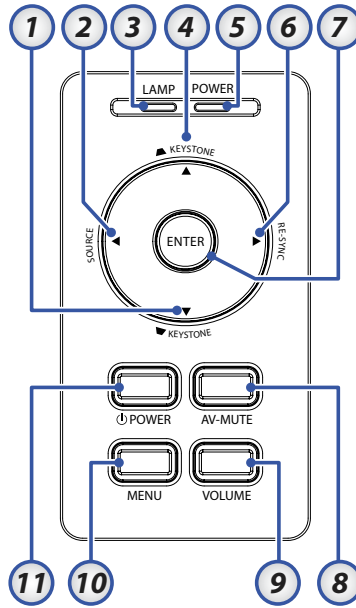

- |               |            |
|---------------|------------|
| 1. KEystone ▼ | 7. ENTER   |
| 2. SOURCE     | 8. AV-MUTE |
| 3. LAMP LED   | 9. VOLUME  |
| 4. KEystone ▲ | 10. MENU   |
| 5. POWER LED  | 11. POWER  |
| 6. RE-SYNC    |            |

## Rear View

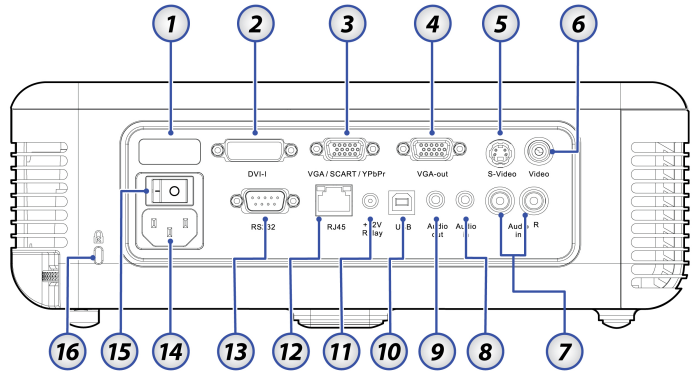

1. Rear IR Receiver
2. DVI-I Connector
3. VGA/ SCART/ YPbPr Connector
4. VGA-out
5. S-Video Input Connector
6. Video Input Connector
7. Audio Input Connector (left and right)
8. Audio In
9. Audio Out
10. USB Connector (Connect to PC for Remote Mouse function)
11. +12V Relay
12. RJ-45 Connector (RJ45 function is dependent on the model purchased)
13. RS-232 Connector
14. Power Socket
15. Power Switch
16. Kensington™ Lock Port

# Introduction

## Remote Control

1. Button LED
2. Power On/Off
3. Laser Button
4. Page Up
5. Mouse Right Click
6. Four Directional Select Keys
7. Re-Sync
8. Page Down
9. Volume +/-
10. Zoom
11. AV mute
12. Video Source
13. VGA Source
14. Freeze
15. S-Video Source
16. DVI-I
17. Brightness
18. Menu
19. Keystone +/-
20. Source
21. Enter
22. Mouse Left Click
23. PC/Mouse control
24. Number Buttons  
(for password input)

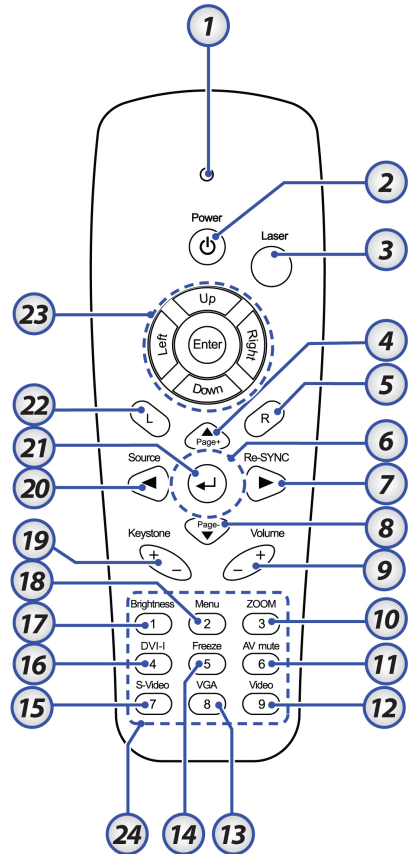

## Connecting the Projector Connect to Computer / Notebook

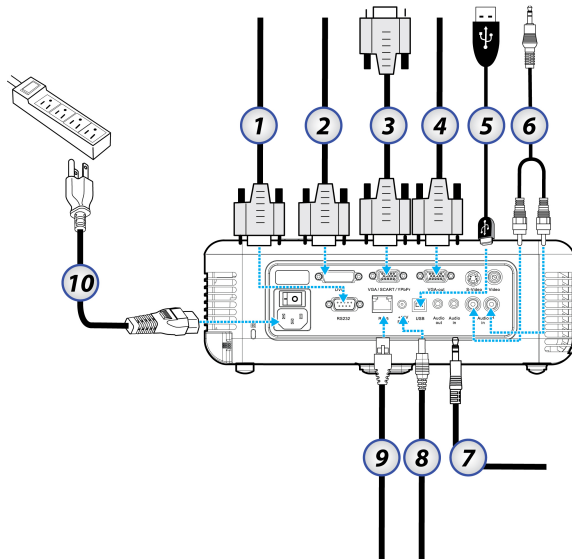

❖ Due to the difference in applications for each country, some regions may have different accessories.

1. RS-232 Cable
2. DVI-I Cable
3. VGA Cable
4. RGB-out
5. USB Cable
6. Audio-in (RCA Type cable)
7. Audio-in (mini jack)
8. +12V Relay Cable
9. RJ45 Cable (RJ45 function is dependent on the model purchased)
10. Power Cord

## Connect to Video Sources

DVD Player, Set-top Box,  
HDTV receiver

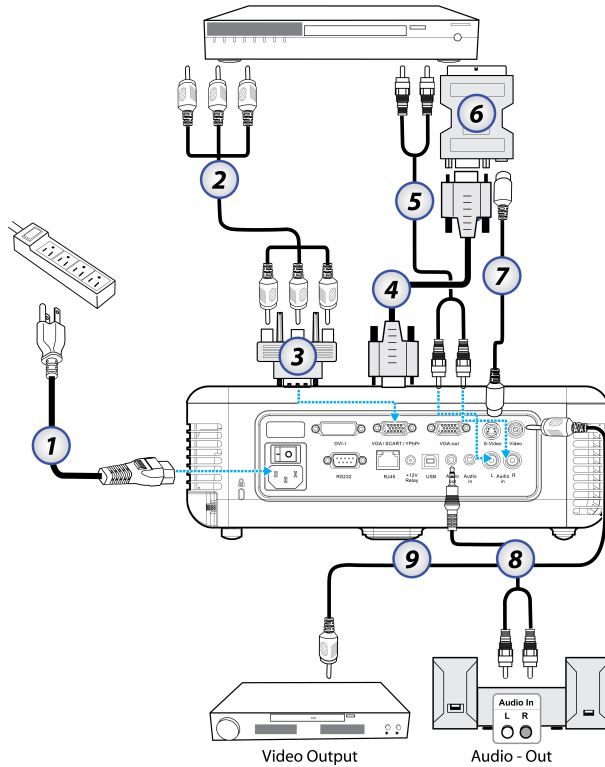

❖ Due to the difference in applications for each country, some regions may have different accessories.

1. Power Cord
2. Component Cable (optional)
3. RGB to Component Adapter (optional)
4. VGA Cable
5. RCA Type audio cable (optional)
6. SCART to RGB & S-Video Adapter (optional)
7. S-Video Cable (optional)
8. Audio-out – RCA Type cable (optional)
9. Composite Video Cable

## Powering On / Off the Projector

### Powering On the Projector

1. Slide the lens cover. ❶
2. Connect the power cord to the projector [A]. Connect the other end to a wall outlet. Switch [B] from off (O) to on ( - ).

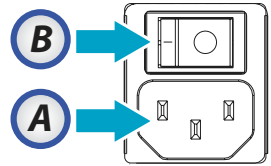

❖ Turn on the projector first and then select the signal sources.

3. The POWER and LAMP LEDs on the projector turn on. Ensure the LAMP LED is on a steady (not flashing) orange and the POWER LED is on a steady (not flashing) green. Press the **POWER** button to turn on the projector ❷.

The startup screen displays in approximately 10 seconds.

4. Turn on your source (computer, notebook, video player, etc.). The projector will detect your source automatically.

❖ If you connect multiple sources at the same time, press the **SOURCE** button on the control panel or direct source key on the remote control to switch between inputs.

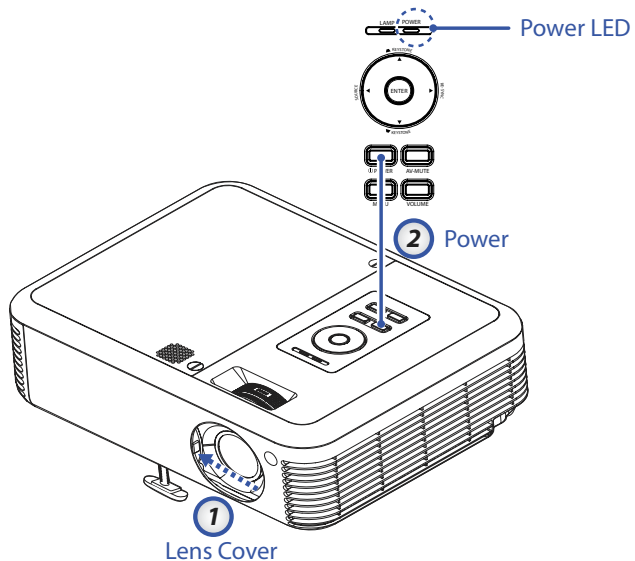



## Powering Off the Projector

1. Press **POWER** to turn off the projector lamp, a message displays on the projector's screen.

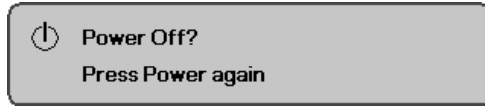

2. Press **POWER** again to confirm, otherwise the message disappears after 15 seconds.
3. The cooling fans continue to operate for about 10 seconds for cooling cycle. When the LAMP LED is on a steady (not flashing) orange and the POWER LED is on a steady (not flashing) green, the projector has entered standby mode.  
If you wish to turn the projector back on, you must wait until the projector has completed the cooling cycle and has entered standby mode. Once in standby mode, simply press **POWER** to restart the projector.
4. Turn off the main power switch. Disconnect the power cord from the electrical outlet and the projector.
5. Do not turn on the projector immediately following a power off procedure.

## Warning Indicator

- ❖ When the POWER LED indicator repeatedly blinks five (5) times, the projector will automatically shut itself down. Please contact your local reseller or service center. See pages 65-66.
- ❖ When the POWER LED indicator repeatedly blinks three times, the projector will automatically shut itself down. Under normal conditions, the projector can be switched on again after it has cooled down. If the problem persists, you should contact your local dealer or our service center. See pages 65-66.
- ❖ When the POWER LED repeatedly blinks six (6) times in conjunction with the LAMP LED blinking a single time, it indicates the fan has failed. Please contact your local dealer or our service center. See pages 65-66.

## Adjusting the Projected Image Adjusting the Projector's Height

The projector is equipped with elevator foot for adjusting the image height.

### To raise the image:

1. Press the elevator button ❶.
2. Raise the image to the desired height angle ❷, then release the button to lock the elevator foot into position.
3. Use screw in foot ❸ to fine-tune the display angle.

### To lower the image:

1. Press the elevator button.
2. Lower the image, then release the button to lock the elevator foot into position.
3. Use screw in foot ❸ to fine-tune the display angle.

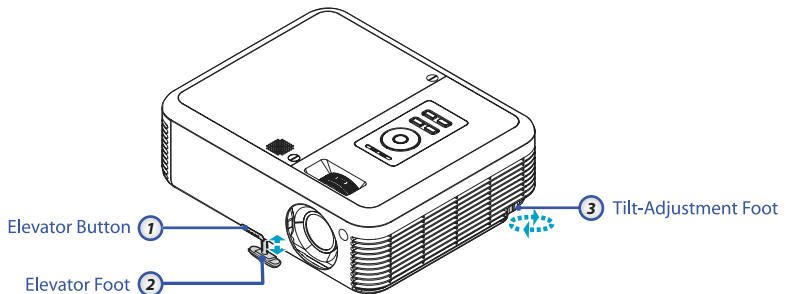

# Installation

## Adjusting the Zoom / Focus (0.7" XGA Series)

You may turn the zoom ring to zoom in or out. To focus the image, rotate the focus ring until the image is clear. The projector will focus at distances from 3.28 to 36.7 feet (1 to 11.2 meters).

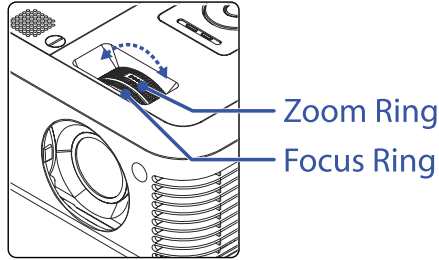

## Adjusting Projection Image Size

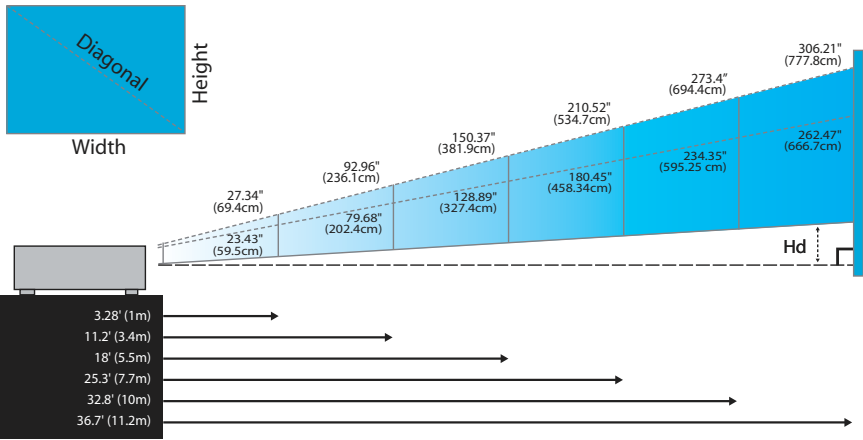

Screen (Diagonal)	Max.	27.34" (69.4cm)	92.96" (236.1cm)	150.37" (381.9cm)	210.52" (534.7cm)	273.4" (694.4cm)	306.21" (777.8cm)
	Min.	23.43" (59.5cm)	79.68" (202.4cm)	128.89" (327.4cm)	180.45" (458.34cm)	234.35" (595.25cm)	262.47" (666.7cm)
Screen size	Max (WxH)	21.87x16.4" (55.5x41.6cm)	74.37x55.77" (188.89x146.73cm)	120.3x90.22" (305.6x229.1cm)	168.42x126.31" (427.8x320.8cm)	218.72x164.04" (555.5x416.7cm)	244.97x183.73" (622.2x466.7cm)
	Min. (WxH)	18.75x14.06" (47.6x35.7cm)	63.74x47.81" (161.89x121.4cm)	103.11x77.33" (261.9x196.4cm)	144.36x108.27" (366.7x275cm)	187.48x140.61" (476.2x357.1cm)	209.97x157.48" (533.3x400cm)
Hd	Max.	2.03" (5.14cm)	6.89" (17.49cm)	11.14" (28.29cm)	15.59" (39.61cm)	20.25" (51.44cm)	22.68" (57.61cm)
	Min.	1.74" (4.41cm)	5.9" (14.99cm)	9.55" (24.25cm)	13.37" (44.09cm)	17.36" (44.09cm)	19.44" (49.38cm)
Distance		3.28' (1m)	11.2' (3.4m)	18' (5.5m)	25.3' (7.7m)	32.8' (10m)	36.7' (11.2m)

## Adjusting the Zoom / Focus (0.55" XGA Series)

You may turn the zoom ring to zoom in or out. To focus the image, rotate the focus ring until the image is clear. The projector will focus at distances from 3.28 to 32.8 feet (1 to 10 meters).

## Adjusting Projection Image Size

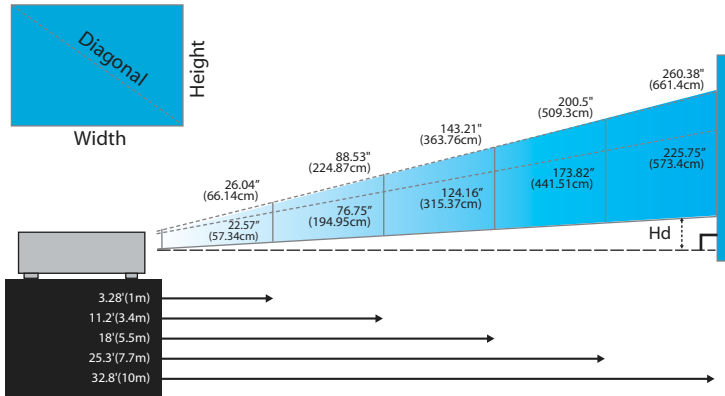

Screen (Diagonal)	Max.	26.04" (66.14cm)	88.53" (224.87cm)	143.21" (363.76cm)	200.5" (509.3cm)	260.38" (661.4cm)
	Min.	22.57" (57.34cm)	76.75" (194.95cm)	124.16" (315.37cm)	173.82" (441.51cm)	225.75" (573.4cm)
Screen size	Max (WxH)	20.8x15.6" (52.9x39.7cm)	70.82x53.12" (179.9x134.9cm)	114.57x85.93" (291x218.3cm)	160.4x120.3" (407.4x305.6cm)	208.31x156.25" (529.1x396.8cm)
	Min. (WxH)	18.06x13.54" (45.9x34.4cm)	61.4x46.1" (156x117cm)	99.33x74.5" (252.3x189.2cm)	139.06x104.29" (353.21x264.91cm)	180.6x135.45" (458.7x344cm)
Hd	Max.	2.25" (5.71cm)	7.64" (19.4cm)	12.36" (31.38cm)	17.3" (43.94cm)	22.47" (57.06cm)
	Min.	1.95" (4.98cm)	6.62" (16.82cm)	10.71" (27.21cm)	15" (38.09cm)	19.48" (49.47cm)
Distance		3.28' (1m)	11.2' (3.4m)	18' (5.5m)	25.3' (7.7m)	32.8' (10m)

## Adjusting the Zoom / Focus (0.65" WXGA Series)

You may turn the zoom ring to zoom in or out. To focus the image, rotate the focus ring until the image is clear. The projector will focus at distances from 3.28 to 32.8 feet (1 to 10 meters).

## Adjusting Projection Image Size

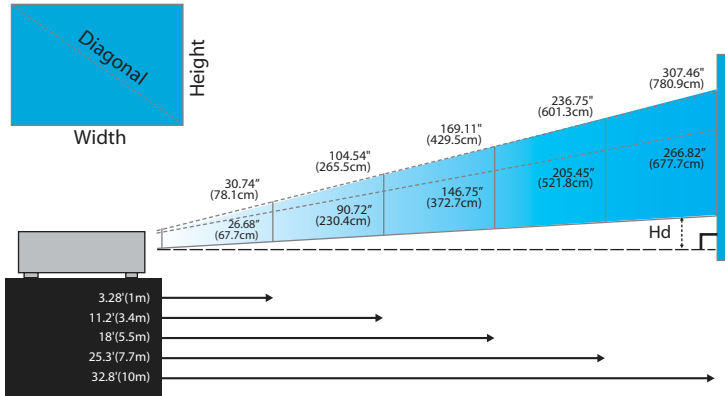

Screen (Diagonal)	Max.	30.74" (78.1cm)	104.54" (265.5cm)	169.11" (429.5cm)	236.75" (601.3cm)	307.46" (780.9cm)
	Min.	26.68" (67.7cm)	90.72" (230.4cm)	146.75" (372.7cm)	205.45" (521.8cm)	266.82" (677.7cm)
Screen size	Max (WxH)	26.07x16.3" (66.2x41.4cm)	88.65x55.4" (225.2x140.7cm)	143.4x89.63" (364.2x227.7cm)	200.76x125.48" (509.8x318.7cm)	260.73x162.96" (662.2x413.9cm)
	Min. (WxH)	22.63x14.14" (57.5x36cm)	79.63x48.08" (202.26x122.1cm)	124.45x77.78" (316.1x197.6cm)	172.22x108.89" (437.4x276.58cm)	226.26x141.42" (574.7x359.2cm)
Hd	Max.	1.92" (4.88cm)	6.54" (16.61cm)	10.58" (26.87cm)	14.81" (37.63cm)	19.24" (48.86cm)
	Min.	1.67" (4.24cm)	5.68" (14.42cm)	9.18" (23.32cm)	12.86" (32.65cm)	16.69" (42.4cm)
Distance		3.28' (1m)	11.2' (3.4m)	18' (5.5m)	25.3' (7.7m)	32.8' (10m)

## Control Panel & Remote Control

### Control Panel

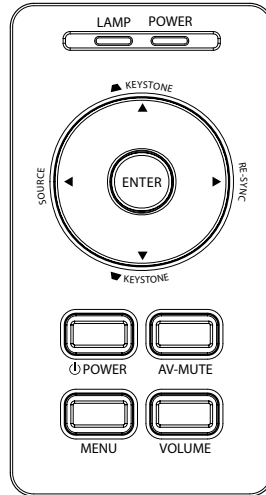

#### Using the Control Panel

KEYSTONE ▲	Adjust the image Keystone positively.
ENTER	Confirm your item selection.
LAMP LED	Indicate the projector's lamp status.
POWER LED	Indicate the projector's status.
POWER	Refer to the "Power On/Off the Projector" section on page 15.
AV-MUTE	Momentarily turns off / on the audio and video.
MENU	Press <b>MENU</b> to launch the on-screen display (OSD) menu. To exit OSD, Press <b>MENU</b> again.
RE-SYNC	Automatically synchronizes the projector to the input source.
KEYSTONE ▼	Adjust the image Keystone negatively.
SOURCE	Press <b>SOURCE</b> to select an input signal.

## Remote Control

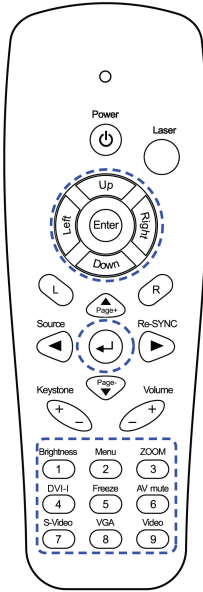

### Using the Remote Control

Power		Refer to the "Power On/Off the Projector" section on page 15.
Laser		Aim the remote at the viewing screen, press and hold this button to activate the laser pointer.
PC / Mouse control		The PC/Mouse control can be used to control mouse movement. The mouse function is enabled using the USB cable to connect your computer and the projector.
L Button		Mouse left click.
R Button		Mouse right click.
Page +		Use this button to page up.
Page -		Use this button to page down.
Enter		Confirm your item selection.
Source		Press <b>Source</b> to select an input signal.
Re-Sync		Automatically synchronizes the projector to the input source.
Four Directional Select Keys		Use  to select items or make adjustments to your selection.
Keystone +/-		Adjusts image distortion caused by tilting the projector. ( $\pm 30$ degrees)
Volume +/-		Adjusts to increase/decrease the volume.
Brightness		Adjust the brightness of the image.

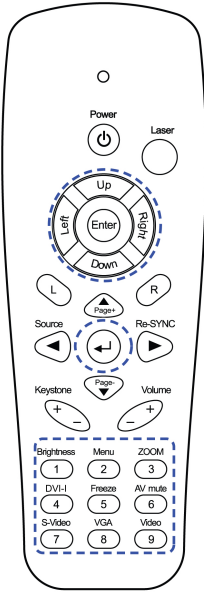

## Using the Remote Control

Menu	Press <b>Menu</b> to launch the on-screen display (OSD) menu. To exit OSD, Press <b>Menu</b> again.
Zoom	Press <b>+/-</b> to zoom in of an image.
DVI-I	Press <b>DVI-I</b> to choose source from DVI-A, DVI-D or DVI-I connector.
VGA	Press <b>VGA</b> to choose source from VGA- IN connector.
AV Mute	Momentarily turns off/on the audio and video.
S-Video	Press <b>S-Video</b> to choose S-Video source.
Freeze	Press <b>Freeze</b> to pause the screen image.
Video	Press <b>Video</b> to choose Composite video source.



## On-screen Display Menus

The Projector has multilingual On-screen Display menus that allow you to make image adjustments and change a variety of settings. The projector will automatically detect the source.

### How to operate

1. To open the OSD menu, press **Menu** on the Remote Control or Projector Keypad.
2. When OSD is displayed, use ◀▶ keys to select any item in the main menu. While making a selection on a particular page, press ▼ or **Enter** to enter sub menu.
3. Use ▲▼ keys to select the desired item and adjust the settings by ▶ key.
4. Select the next item to be adjusted in the sub menu and adjust as described above.
5. Press **Enter** to confirm, and the screen will return to the main menu.
6. To exit, press **Menu** again. The OSD menu will close and the projector will automatically save the new settings.

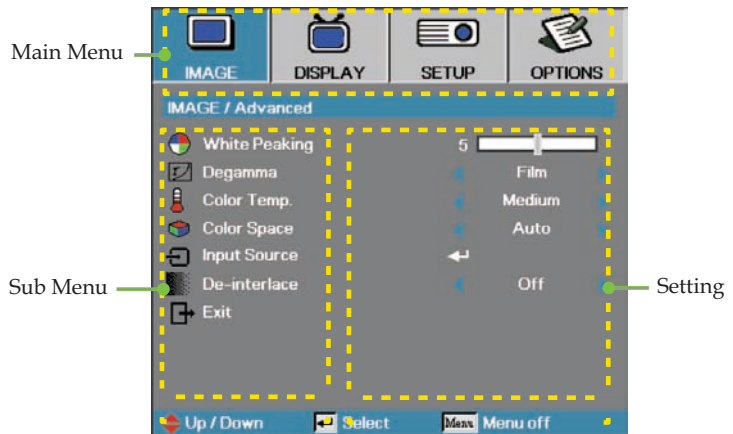

## Menu Tree

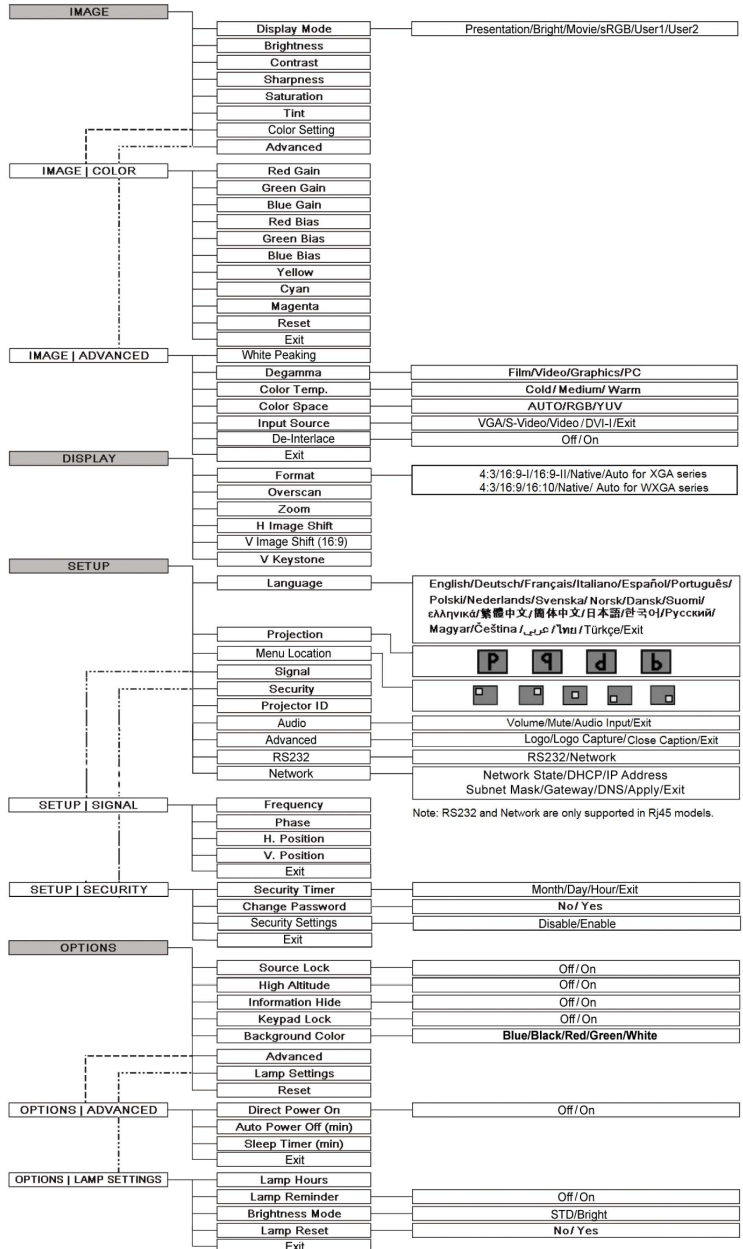

## Image

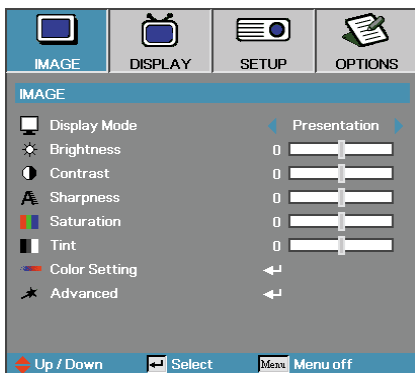

### Display Mode

There are many factory presets optimized for various types of images.

- ▶ Presentation: Good color and brightness from PC input.
  - ▶ Bright: Maximum brightness from PC input.
  - ▶ Movie: For home theater.
  - ▶ sRGB: Standardised accurate color.
  - ▶ User1: User's own settings.
  - ▶ User2: User's own settings.
- The initial default settings of this mode is from Movie mode. Any further adjustments by the user in User1/2 will be saved in this mode for future use.

### Brightness

Adjust the brightness of the image.

- ▶ Press ◀ to darken image.
- ▶ Press ▶ to lighten the image.

### Contrast

The contrast controls the degree of difference between the lightest and darkest parts of the picture. Adjusting the contrast changes the amount of black and white in the image.

- ▶ Press ◀ to decrease the contrast.
- ▶ Press ▶ to increase the contrast.

### Sharpness

Adjusts the sharpness of the image.

- ▶ Press ◀ to decrease the sharpness.
- ▶ Press ▶ to increase the sharpness.

## Image

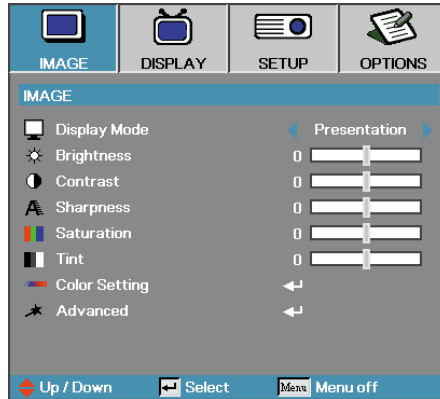

### Saturation

Adjusts a video image from black and white to fully saturation color.

- ▶ Press ◀ to decrease the amount of saturation in the image.
- ▶ Press ▶ to increase the amount of saturation in the image.

### Tint

Adjusts the color balance of red and green.

- ▶ Press ◀ to increase the amount of green in the image.
- ▶ Press ▶ to increase the amount of red in the image.

### Color Setting

Enter the Color Setting menu. Select the Red/Green/Blue Gain for brightness adjustments and Bias for contrast adjustments for the whole picture. Individual color adjustments for Cyan, Magenta, Yellow can also be adjusted. See page 28 for more details.

### Advanced

Enter the Advanced menu. Select advanced display options such as White Peaking, Degamma, Color Temp., Color Space, Input Source, De-Interlace, and Exit. See page 29 for more information.

## Image | Color Setting

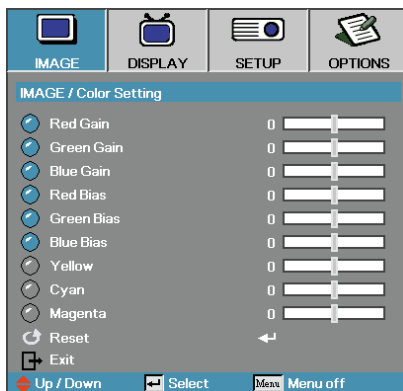

### Gain

Set RGB gain for the following colors:

- ▶ Red – increase or decrease the gain value for red.
- ▶ Green – increase or decrease the gain value for green.
- ▶ Blue – increase or decrease the gain value for blue.

### Bias

Set RGB bias for the following colors:

- ▶ Red – increase or decrease the bias value for red.
- ▶ Green – increase or decrease the bias value for green.
- ▶ Blue – increase or decrease the bias value for blue.

### Color

Set values for the following colors:

- ▶ Yellow – increase or decrease the color value for yellow.
- ▶ Cyan – increase or decrease the color value for cyan.
- ▶ Magenta – increase or decrease the color value for magenta.

### Reset

Reset all Color Setting values to the factory default.

## Image | Advanced

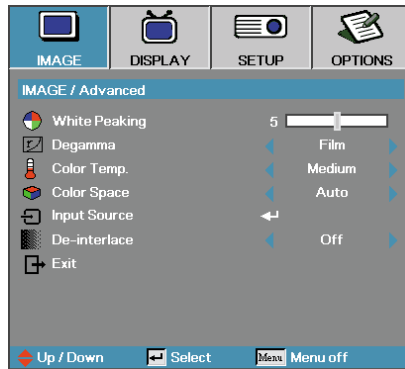

### White Peaking

This adjustable item utilizes a new color-processing algorithm and system level enhancements to enable higher brightness while providing true, more vibrant colors in picture. The range is from 0 to 10. If you prefer a stronger enhanced image, adjust toward the maximum setting. For a smoother, more natural image, adjust toward the minimum setting.

### Degamma

This allows you to choose a degamma table that has been fine-tuned to bring out the best image quality for the input.

- ▶ Film—for home theater.
- ▶ Video—for video or TV source.
- ▶ Graphics—for image source.
- ▶ PC—for PC or computer source.

### Color Temp

Adjust the color temperature. Cold temperature, the screen looks colder; with Warm temperature, the screen looks warmer.

### Color Space

Select an appropriate color matrix type from AUTO, RGB, YUV.

### Input Source

Enter the Input Source submenu. Select the sources to scan for at startup. See page 30 for more information.

### De-interlace

Press the cursor ◀ or ▶ button to select different De-interlace modes. This function converts an interlaced video signal into progressive signal.

- ▶ On: Automatically switch the De-interlace mode and Film mode.
- ▶ Off: Switch De-interlace mode to video mode for video source or TV source

## Image | Advanced | Input Source

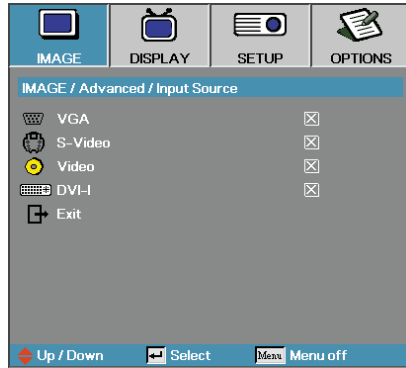

- ❖ If all sources are deselected, the projector cannot display any images. Always leave at least one source selected.

### Input Source

Enable input sources. Press ◀ or ▶ into the next menu as below and then use ▲ or ▼ to select. Press **Enter** to finalize the selection. The projector will not search inputs that are de-selected.

## Display

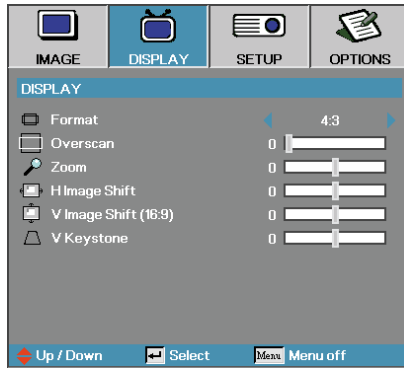

### Format

Use this function to choose your desired aspect ratio.

- ▶ 4:3: This format is for 4x3 input sources not enhanced for Wide screen TV.
- ▶ 16:9 I (XGA series)/16:9 (WXGA series): This format is for 16x9 input sources, like HDTV and DVD enhanced for Wide screen TV.
- ▶ 16:9 II (XGA series)/16:10 (WXGA series): The non-standard wide-screen display format of the projector. Part of the original image will be cut if the image aspect ratio is less than 1.67:1.
- ▶ Native: Depends on the resolution of the display.
- ▶ Auto: Automatically selects the appropriate format.

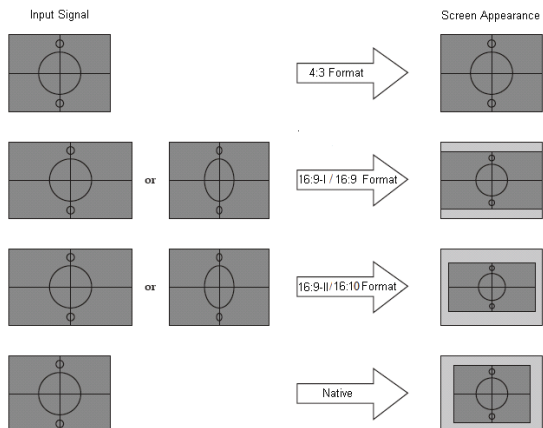



## Display

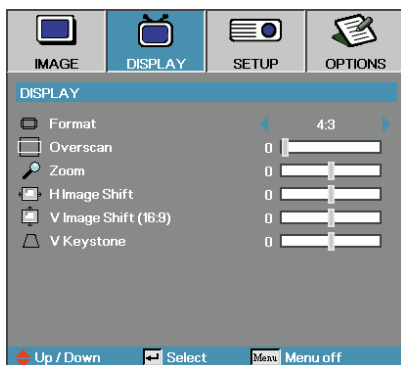

### Overscan

Overscan function removes the noise in a video image. Overscan the image to remove video encoding noise on the edge of video source.

### Zoom

- ▶ Press ◀ to reduce the size of the image.
- ▶ Press ▶ to magnify an image on the projected screen.

### H Image Shift

Shifts the projected image position horizontally.

- ▶ Press ◀ to move the image left on the projected screen.
- ▶ Press ▶ to move the image right on the projected screen.

### V Image Shift (16:9 only)

Shifts the projected image position vertically (in 16:9 format only).

- ▶ Press ◀ to move the image up on the projected screen.
- ▶ Press ▶ to move the image down on the projected screen.

### V Keystone

Press ◀ or ▶ to adjust image distortion vertically and to create a regular image.

## Setup

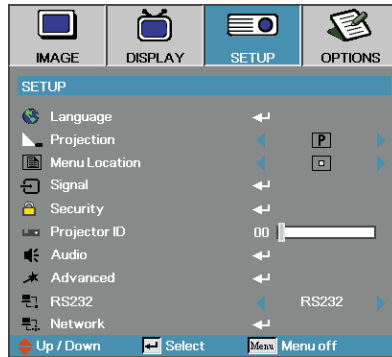

### Language

Enter the Language menu. Select the multilingual OSD menu. See page 35 for more information.

### Projection

Select projection method:

- ▶ **P** Front Desktop  
The factory default setting.
- ▶ **q** Rear Desktop  
When you select this function, the projector reverses the image so you can project behind a translucent screen.
- ▶ **d** Front Ceiling  
When you select this function, the projector turns the image upside down for ceiling-mounted projection.
- ▶ **b** Rear Ceiling  
When you select this function, the projector reverses and turns the image upside down at same time. You can project from behind a translucent screen with ceiling mounted projection.

### Menu Location

Choose the menu location on the display screen.

## Setup

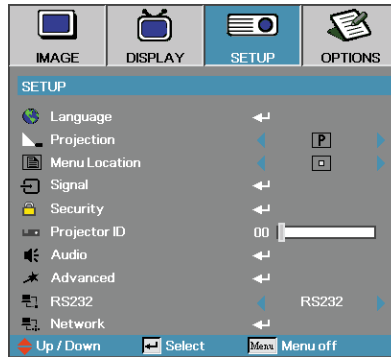

### Signal

Enter the Signal menu. Set projector signal properties. See page 36 for more information.

### Security

Enter the Security menu. Access the projector's security features. See page 37 for more information.

### Projector ID

Select a two digit projector ID from 0 through 99.

### Audio

Enter the Audio menu. Set audio level properties. See page 40 for more information.

### Advanced

Enter the Advanced menu. Select the screen display during startup. See page 41 for more information.

### RS232 (RJ45 model only)

Allows RS232 control of an individual projector.



### Network (RJ45 model only)

Allows LAN via web browser (Internet Explorer) to control of projector. See page 42 for more information.

## Setup | Language



### Language

Choose the multilingual OSD menu. Press **ENTER** (  ) into the sub menu and then use the Left (  ) or Right (  ) key to select your preferred language.

## Setup | Signal

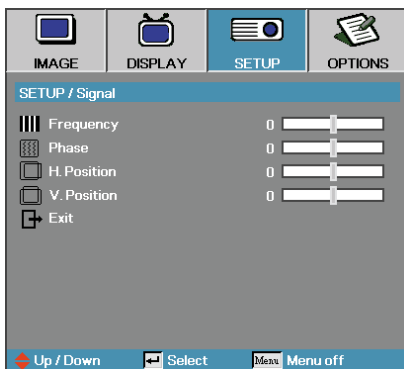

### Frequency

Change the display data frequency to match the frequency of your computer's graphic card. If you experience a vertical flickering bar, use this function to make an adjustment.

### Phase

Phase synchronizes the signal timing of the display with the graphic card. If you experience an unstable or flickering image, use this function to correct it.

### H. Position

- ▶ Press ◀ to move the image left.
- ▶ Press ▶ to move the image right.

### V. Position

- ▶ Press ◀ to move the image down.
- ▶ Press ▶ to move the image up.

## Setup | Security

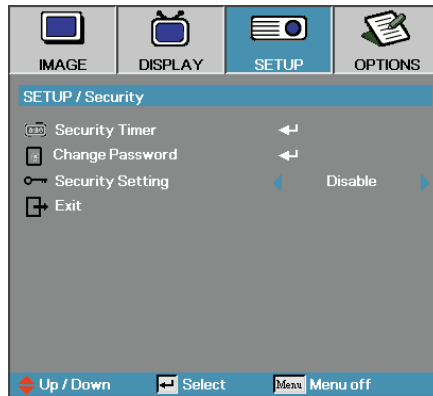

### Security Timer

Enter the Security Timer sub menu.

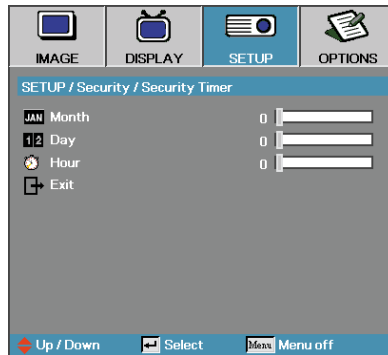

- ❖ No password is required to access Setup | Security unless the Security Timer or Security Setting are enabled.

Enter the Months, Days, and hours that the projector can be used without entering the password. Exiting to the Setup menu activates the Security Timer.

Once activated, the projector requires a password on the specified dates and times to allow power on and access to the security menu.

If the projector is in use and the Security Timer is active, the following screen displays 60 seconds before the password is required.

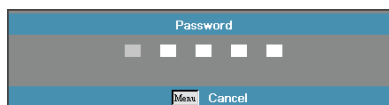

## Setup | Security

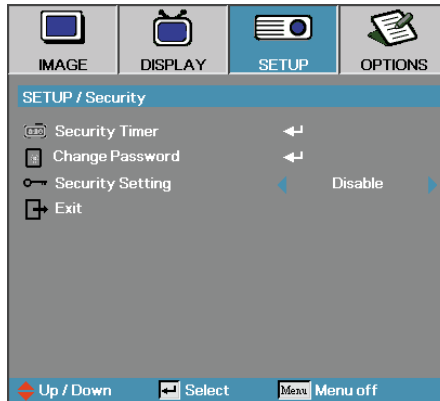

- ❖ If the incorrect password is entered three times, the device auto shutdowns after 10 seconds.

### Change Password

Use this submenu to change the security password for the projector.

1. Select Change Password from the Security submenu. The Confirm Change Password dialog box displays.
2. Select Yes.

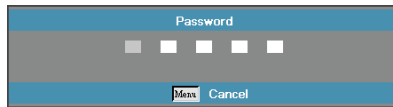

3. Enter the default password <1> <2> <3> <4> <5>. A second password screen displays.

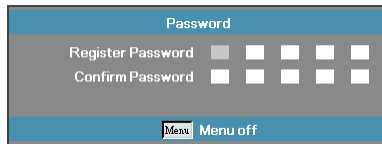

4. Enter the new password twice for verification.



- ❖ If the new passwords do not match, the password screen redisplay.

## Setup | Security

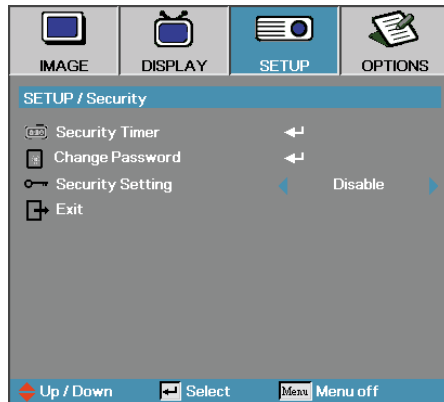

### Security Setting

Enable or disable the security password.

- ▶ Enabled – the current password is required to power on the projector and access the Security menu.
- ▶ Disabled – no password is required for any function.

When security is enabled, the following screen displays at startup and before access to the Security menu is allowed:

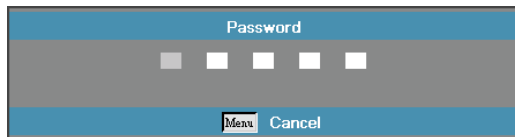



## Setup | Audio

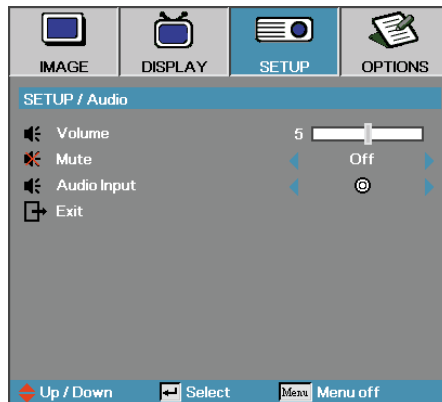

### Volume

- Press ◀ to decrease the volume of voice.
- Press ▶ to increase the volume of voice.

### Mute

- Toggle the audio on or off.
  - ▶ Off—the speaker volume is turned on.
  - ▶ On—the speaker volume is turned off.

### Audio Input

- Enter the Audio Input menu. Select the mini Jack/RCA for audio input source.

## Setup | Advanced

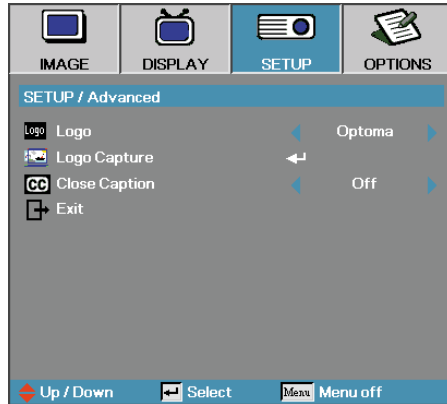

### Logo

Select the screen to display during startup.

- ▶ Optoma—the supplied default startup screen.
- ▶ User—customized screen capture using the Logo Capture function.

### Logo Capture

Capture a displayed screen to use as the startup screen.

1. Display the desired screen on the projector.
2. Select Logo Capture from the Advanced menu.

A confirmation screen displays.



- ❖ Only one startup screen can be saved at once. Subsequent captures overwrite previous files limited in 1.5MB.

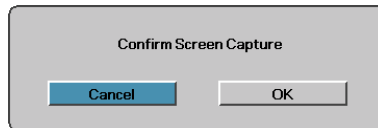

3. Select OK. Screen capture in progress.

Screen capture succeeded displays. The captured screen is saved as **User** in the Logo menu.

### Close Caption

Select the screen to display closed captioning

- ▶ Off—the supplied default setting.
- ▶ On—closed captioning text is displayed if available.

## Setup | Network

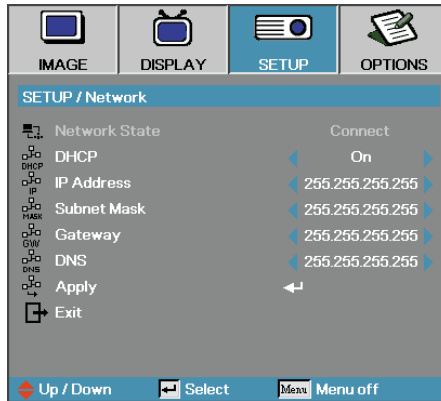

### Network

Press **Enter** to apply Network settings. If the connection is successful, the OSD display will show the following dialogue box.

- ▶ Network State – to display network information.
- ▶ DHCP:
  - On: Assign an IP address to the projector from the DHCP server automatically.
  - Off: Assign an IP address manually.
- ▶ IP Address – Select an IP address
- ▶ Subnet Mask – Select subnet mask number.
- ▶ Gateway – Select the default gateway of the network connected to the projector.
- ▶ DNS – Select DNS number.
- ▶ Apply – Press **Enter** to apply the selection.

## Options

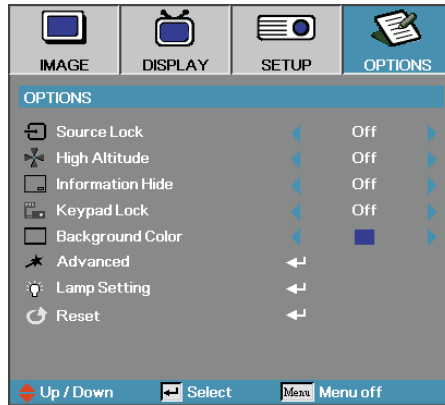

### Source Lock

Lock the current source as the only available source, even if the cable is unplugged.

- ▶ On—only the current source is recognized as an input source.
- ▶ Off—all sources selected in Image | Advanced | Input Source are recognized as an input source.

### High Altitude

Adjust the fan speed to reflect the environment.

- ▶ On—increases fan speed for high temperature, humidity, or altitude.
- ▶ Off—regular fan speed for normal conditions..

### Information Hide

Suppress informational messages on the projected screen.

- ▶ On—no status messages appear on screen during operation.
- ▶ Off— status messages appear as normal on screen during operation.

## Options

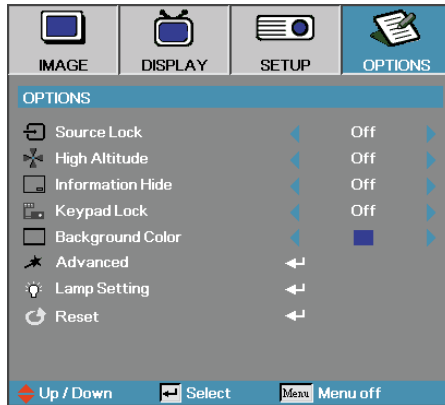

### Keypad Lock

Lock the buttons on the projector top panel.

- ▶ On—a warning message displays to confirm keypad lock.

 Hold \*ENTER\* key on keypad for 5 seconds to unlock keypad

- ▶ Off—projector keypad functions as normal.

### Background Color

Select the desired background color for the projected image when no source is detected.

### Advanced

Enter the Advanced menu. See page 45 for more details.

### Lamp Setting

Enter the Lamp Setting menu. See pages 46-47 for more details.

### Reset

Reset all Options to default factory settings.

## Options | Advanced

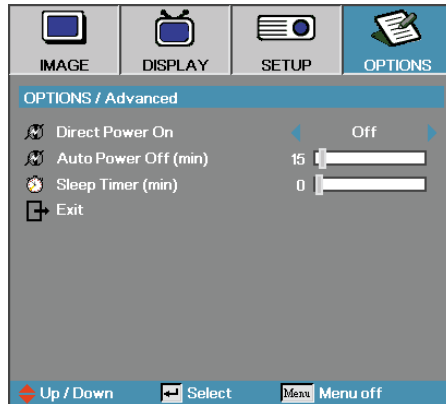

### Direct Power On

Enable or disable Direct Power On.

- ▶ On – the projector powers on automatically when AC power is supplied.
- ▶ Off – the projector must be powered on as normal.

### Auto Power Off

Set the Auto Power Off interval. The projector powers off the lamp after 15 minutes of no signal by default. The following warning is displayed 60 seconds before power off.

The projector will automatically shutdown after 60 sec.

### Sleep Timer

Set the Sleep Timer interval. The projector powers off after the specified time period of inactivity (regardless of signal). The following warning is displayed 60 seconds before power off.

The projector will automatically shutdown after 60 sec.

## Options | Lamp Setting

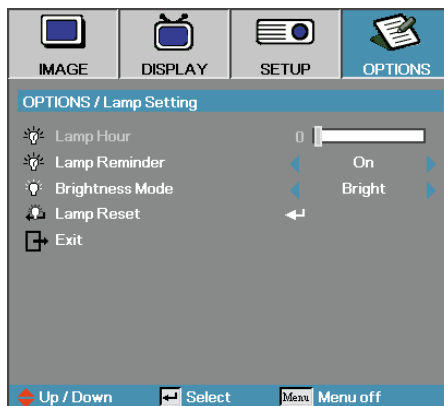

### Lamp Hour

Displays the number of hours the lamp has been active. This item is for display only.

### Lamp Reminder

Enable or disable the lamp life span reminder.

- ▶ On—a warning message displays when remaining lamp life is less than 30 hours.



Lamp is approaching the end of its useful life

- ▶ Off—no warning message displays.

### Brightness Mode

Select the lamp brightness mode.

- ▶ Bright—the default setting.
- ▶ STD—lower brightness setting to conserve lamp life.

## Options | Lamp Setting

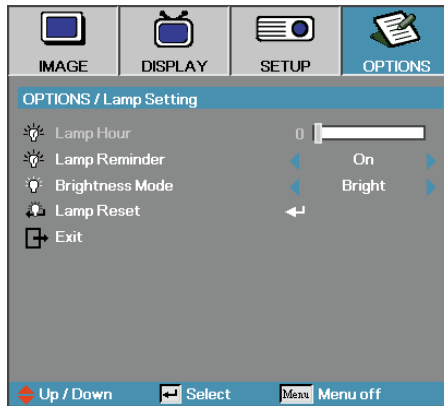

### Lamp Reset

After replacing the lamp, reset the lamp counter to accurately reflect the new lamp's life span.

1. Select Lamp Reset.

A confirmation screen displays.

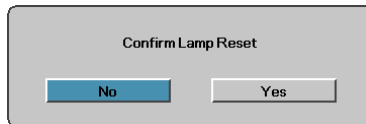

2. Select **Yes** to reset the lamp counter to zero.



## LAN\_RJ45 (RJ45 models only)

For simplicity and ease of operation, the Optoma projector provides diverse networking and remote management features.

The LAN/RJ45 function of the projector through a network, such as remotely manage: Power On/Off, Brightness and Contrast settings. Also, projector status information, such as: Video-Source, Sound-Mute, etc.

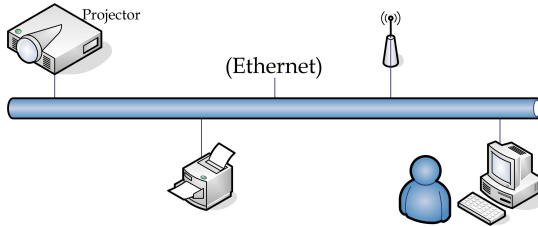

### LAN RJ45

1. Connect an RJ45 cable to RJ45 ports on the projector and the PC (Laptop).

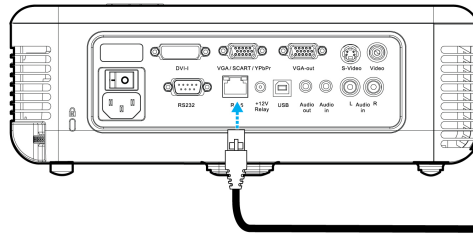

RJ45 Connector

2. On the PC (Laptop), select Start -> Control Panel-> Network Connections.

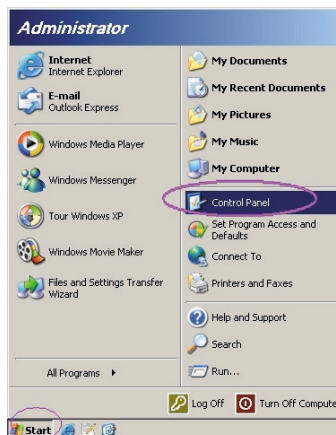

# User Controls

3. Right Click on your Local Area Connection, and select Property.

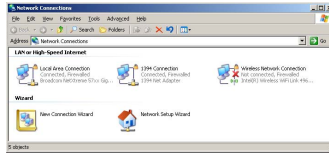

4. In the Properties window, select the **General** tab, and select **Internet Protocol (TCP/IP)**.

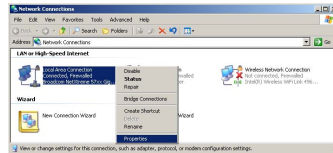

5. Click **Properties**.

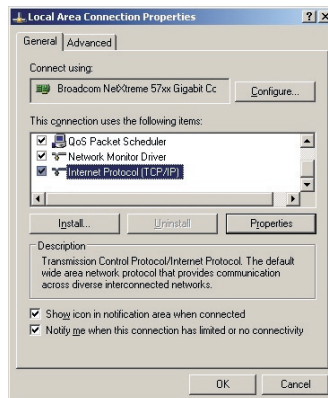

6. Fill in the IP address and Subnet mask, then press OK.

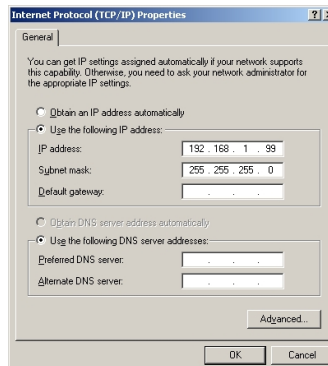

# User Controls

7. Press the **Menu** button on the projector.
8. Select OSD-> SETUP-> Network-> Enabled.
9. Input the following:
  - ▶ IP Address: 192.168.1.2
  - ▶ Subnet Mask: 255.255.255.0
  - ▶ Gateway: 0.0.0.0
  - ▶ DNS Server: 0.0.0.0
10. Press **Apply** (Enter) to confirm settings.
11. Open a web browser (ex, Microsoft Internet Explorer).

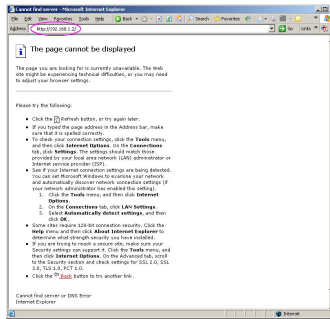

12. In the Address bar, input the IP address: 192.168.1.2.

13. Press **Enter**.

The projector is setup for remote management. The LAN/RJ45 function displays as follows.

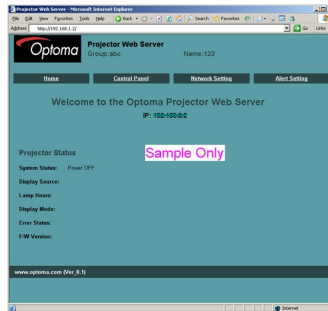

## Troubleshooting

If you experience a problem with your projector, please refer to the following information. If a problem persists, please contact your local reseller or service center.

### Image Problems

#### No image appears on-screen

- ▶ Ensure all the cables and power connections are correctly and securely connected as described in the **Installation** section.
- ▶ Ensure all the pins of connectors are not bent or broken.
- ▶ Check if the projection lamp has been securely installed. Please refer to the **Replacing the lamp** section.
- ▶ Make sure you have removed the lens cap and the projector is switched on.

#### Partial, scrolling or incorrectly displayed image

- ▶ Press “Re-Sync” on the remote.
- ▶ If you are using a PC:  
For Windows 95, 98, 2000, XP:
  1. Open the **My Computer** icon, the **Control Panel** folder, and then double click on the **Display** icon.
  2. Select the **Settings** tab.
  3. Verify that your display resolution setting is lower than or equal to UXGA (1600 x 1200).
  4. Click on the **Advanced Properties** button.  
If the projector is still not projecting the whole image, you will also need to change the monitor display you are using. Refer to the following steps.
  5. Verify the resolution setting is lower than or equal to UXGA (1600 x 1200).
  6. Select the **Change** button under the **Monitor** tab.
  7. Click on **Show all devices**. Next, select **Standard monitor types** under the SP box; choose the resolution mode you need under the “Models” box.
  8. Verify that the resolution setting of the monitor display is lower than or equal to UXGA (1600 x 1200). (\*)

- ▶ If you are using a Notebook:
  1. First, follow the steps above to adjust resolution of the computer.
  2. Press the toggle output settings. Example: [Fn]+[F4]

Acer ⇒	[Fn]+[F5]	IBM/Lenovo ⇒	[Fn]+[F7]
Asus ⇒	[Fn]+[F8]	HP/Compaq ⇒	[Fn]+[F4]
Dell ⇒	[Fn]+[F8]	NEC ⇒	[Fn]+[F3]
Gateway ⇒	[Fn]+[F4]	Toshiba ⇒	[Fn]+[F5]

---

Mac Apple:  
System Preference ⇒ Display ⇒ Arrangement ⇒ Mirror display

If you experience difficulty changing resolutions or your monitor freezes, restart all equipment including the projector.

## The screen of the Notebook or PowerBook computer is not displaying your presentation

- ▶ If you are using a Notebook:

Some Notebooks may deactivate their own screens when a second display device is in use. Each has a different way to be reactivated. Refer to your computer's manual for detailed information.

## Image is unstable or flickering

- ▶ Use **Phase** to correct it. See page 36 for more information.
- ▶ Change the monitor color setting on your computer.

## Image has vertical flickering bar

- ▶ Use **Frequency** to make an adjustment. See page 36 for more information.
- ▶ Check and reconfigure the display mode of your graphic card to make it compatible with the projector.

## Image is out of focus

- ▶ Make sure the lens cap is removed.
- ▶ Adjusts the Focus Ring on the projector lens.
- ▶ Make sure the projection screen is between the required distances from the projector. See pages 18-20 for more information.

## The image is stretched when displaying 16:9 DVD title

When you play anamorphic DVD or 16:9 DVD, the projector will show the best image in 16:9 format on projector side. If you play 4:3 format DVD title, please change the format as 4:3 in projector OSD. If the image is still stretched, you will also need to adjust the aspect ratio by referring to the following:

- ▶ Please setup the display format as 16:9 (wide) aspect ratio type on your DVD player.

## Image is too small or too large

- ▶ Adjust the Zoom Ring on the top of the projector.
- ▶ Move the projector closer to or further from the screen.
- ▶ Press [Menu] button on the remote control or projector panel, go to **Display | Format** and try the different settings.

## Image has slanted sides

- ▶ If possible, reposition the projector so that it is centered on the screen and below the bottom of the screen.
- ▶ Press [Keystone +/-] button until the sides are vertical on the remote control.



❖ Use of Keystone is not recommended.

## Image is reversed

- ▶ Select **Setup | Projection** from the OSD and adjust the projection direction.

## Intermission Problems

### The projector stops responding to all controls

- ▶ If possible, turn off the projector, then unplug the power cord and wait at least 60 seconds before reconnecting power.

### Lamp burns out or makes a popping sound

- ▶ When the lamp reaches its end of life, it will burn out and may make a loud popping sound. If this happens, the projector will not turn on until the lamp module has been replaced. To replace the lamp, follow the procedures in **Replacing the Lamp** on page 56.

## Projector Status Indication

Message	Power LED	Lamp LED
T1 temperature over temperature	3	0
Thermal Break	4	0
G794 fail	4	4
T1 fail	4	5
Lamp error	5	0
Ballast Over Temperature	5	1
Ballast shot circuit in output detected	5	2
End of lamp lift detected	5	3
Ballast lamp did not ignite	5	4
Lamp extinguished during normal operation	5	5
Lamp extinguished during run-up phase	5	6
Fan1 error (Lamp Fan)	6	1
Fan2 error (Ballast Fan)	6	1
Fan3 error (Burner Fan)	6	3
Fan4 error (Power Fan)	6	4
Lamp door open	7	0
DMD error	8	0
Color wheel error	9	0

## Message Reminders

- ▶ Replacing the lamp:

 Lamp is approaching the end of its useful life

- ▶ Out of range: (see the following for more information)



**Signal out of range**  
**lower image resolution.**

## Remote Control Problems

If the remote control does not work

- ▶ Check the operating angle for the remote control is approximately  $\pm 15^\circ$ .
- ▶ Make sure there are no obstructions between the remote control and the projector. Move to within 7m (23 ft) of the projector.
- ▶ Make sure the batteries are inserted correctly.
- ▶ Replace weak batteries in the remote control.

## Audio Problems

### There is no sound

- ▶ Adjust the volume on the remote control.
- ▶ Adjust the volume of the audio source.
- ▶ Check the audio cable connection.
- ▶ Test the source audio output with other speakers.
- ▶ Have the projector serviced.

### The sound is distorted

- ▶ Check the audio cable connection.
- ▶ Test the source audio output with other speakers.
- ▶ Have the projector serviced.



## Replacing the Lamp

The projection lamp should be replaced when it burns out. It should only be replaced with a certified replacement part, which you can order from your local dealer.

### Important:

- ▶ The lamp contains a certain amount of mercury and should be disposed of according to local ordinance regulations.
- ▶ Avoid touching the glass surface of the new lamp, doing so may shorten its operation life.

### Warning:

- ▶ Be sure to turn off and unplug the projector at least an hour before replacing the lamp. Failure to do so could result in a severe burn.

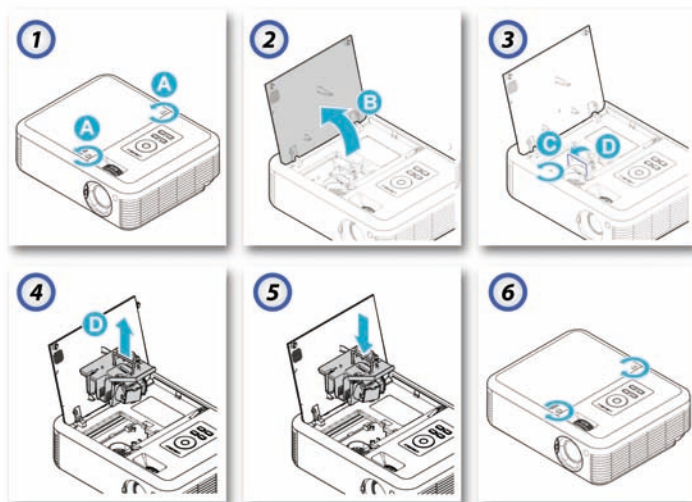

1. Loosen the two captive screws on the lamp compartment cover.
2. Open the lamp compartment cover.
3. Remove the two screws from the lamp module.
4. Lift the module handle up.
5. Replace the lamp module.
6. Reverse steps 1 to 5 to install the new lamp module.

After replacing the lamp, the lamp hours counter must be reset. See page 47 for more information.

## Cleaning the Projector

Cleaning the projector to remove dust and grime will help ensure trouble-free operation.

Warning:

- ▶ Be sure to turn off and unplug the projector at least an hour before cleaning. Failure to do so could result in a severe burn.
- ▶ Use only a dampened cloth when cleaning. Do not allow water to enter the ventilation openings on the projector.
- ▶ If a little water gets into the projector interior while cleaning, leave unplugged in a well-ventilated room for several hours before using.
- ▶ If a lot of water gets into the projector interior when cleaning, have the projector serviced.

## Cleaning the Lens

You can purchase optic lens cleaner from most camera stores. Refer to the following to clean the projector lens.

1. Apply a little optic lens cleaner to a clean soft cloth. (Do not apply the cleaner directly to the lens.)
2. Lightly wipe the lens in a circular motion.

Caution:

- ▶ Do not use abrasive cleaners or solvents.
- ▶ To prevent discoloration or fading, avoid getting cleaner on the projector case.

## Cleaning the Case

Refer to the following to clean the projector case.

1. Wipe off dust with a clean dampened cloth.
2. Moisten the cloth with warm water and mild detergent (such as used to wash dishes), and then wipe the case.
3. Rinse all detergent from the cloth and wipe the projector again.

Caution:

To prevent discoloration or fading of the case, do not use abrasive alcohol-based cleaners.

## Compatibility Modes

### Computer Compatibility

Signal	Resolution	Refresh Rate (Hz)
NTSC	-	60
PAL/SECAM	-	50
VESA	640 x 350	70.1/ 85.1
	640 x 400	70.1 / 85.1
	720 x 350	70
	720 x 400	70/ 85/ 88
	720 x 576	50/ 60
VGA	640 x 480	60/ 67/ 72.8/ 75/ 85
SVGA	800 x 600	56.3/ 60.3/ 75/ 72.2/ 80/ 85.1
	832 x 624	72/ 75
	1024 x 576	50/ 60
XGA	1024 x 768	60/ 70.1/ 72/ 75/ 85/ 87
	1152 x 864	60/ 70/ 75/85/ 75
HD720	1280 x 720	50/ 60/ 75/ 85
WXGA	1280 x 768	60/ 70/ 75/ 85
WXGA-800	1280 x 800	60
SXGA	1280 x 1024	60/ 75/85
SXGA+	1400 x 1050	60
UXGA	1600 x 1200	60
	1600 x 1050	60
HD1080	1920 x 1080	24/ 50/ 60/75
WUXGA	1920 x 1200	60/ 75
HDTV	1920 x 1080i	50/ 60
	1920 x 1080p	50/ 60
	1280 x 720p	50/ 60
SDTV	720 x 576i	50
	720 x 576p	50
	720 x 480i	60
	720 x 480p	60

## Apple Mac Compatibility

Resolution	Macbook		Macbook Pro (Intel)	Power Mac G5	Power Mac G4
	Hz-	Analog	Analog	Analog	Analog
800x600	60	o	o	-	-
800x600	72	o	o	o	o
800x600	75	o	o	o	o
800x600	85	o	o	o	o
1024x768	60	o	o	o	o
1024x768	70	o	o	o	o
1024x768	75	o	o	o	o
1024x768	85	o	o	o	o
1280x720	60	o	o	o	o
1280x720	75	o	o	-	o
1280x720	85	o	o	-	o
1280x768	60	o	o	-	o
1280x768	75	o	o	o	o
1280x768	85	o	o	-	o
1280x800	60	o	o	o	o
1280x1024	60	-	o	o	o
1280x1024	75	-	o	o	-
1680x1050	60	o	o	-	-
1920x1200	60	o	o	-	-

## RS232 Commands

### RS232 VGA-In Connector

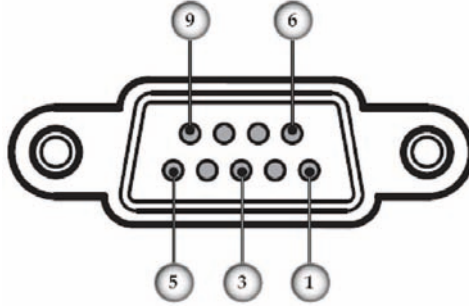

Pin No	Name	I/O (From Projector Side)
1	NC	—
2	RXD	IN
3	TXD	OUT
4	NC	—
5	NC	—
6	NC	—
7	RS232	RTS
8	RS232	CTS
9	NC	—

## RS232 Protocol Function List

### RS232 Commands

Baud Rate : 9600

Data Bits: 8

Parity: None

Stop Bits: 1

Flow Control:None

UART16550 FIFO: Disable

Projector Return (Pass): P

Projector Return (Fail): F

XX=01-99, projector's ID

XX=00 is for all projectors

SEND to projector

Note : There is a <CR> after all ASCII commands  
0D is the HEX code for <CR> in ASCII code

232 ASCII Code	HEX Code	Function	Description
-XX00 1	7E 30 30 30 20 31 0D	Power ON	
-XX00 2	7E 30 30 30 20 32 0D	Power OFF	
-XX01 1	7E 30 30 30 31 20 31 0D	Resync	
-XX02 1	7E 30 30 30 32 20 31 0D	AV Mute	On
-XX02 2	7E 30 30 30 32 20 32 0D		Off
-XX04 1	7E 30 30 30 34 20 31 0D	Freeze	
-XX04 2	7E 30 30 30 34 20 32 0D	Unfreeze	
-XX11 1	7E 30 30 31 31 20 31 0D	IR Function	On
-XX11 2	7E 30 30 31 31 20 32 0D		Off
-XX12 2	7E 30 30 31 32 20 32 0D		DVI-D
-XX12 3	7E 30 30 31 32 20 33 0D		DVI-A
-XX12 5	7E 30 30 31 32 20 35 0D		VGA
-XX12 7	7E 30 30 31 32 20 37 0D	Direct Source Selection	VGA SCART
-XX12 8	7E 30 30 31 32 20 38 0D		VGA Component
-XX12 9	7E 30 30 31 32 20 39 0D		S-video
-XX12 10	7E 30 30 31 32 20 31 30 0D		Video
-XX20 1	7E 30 30 32 30 20 31 0D	Display Mode	Presentation
-XX20 2	7E 30 30 32 30 20 32 0D		Bright
-XX20 3	7E 30 30 32 30 20 33 0D		Movie
-XX20 4	7E 30 30 32 30 20 34 0D		sRGB
-XX20 5	7E 30 30 32 30 20 35 0D		User 1
-XX20 6	7E 30 30 32 30 20 36 0D		User 2
-XX21 n	7E 30 30 32 31 20 a 0D	Brightness	n = -50 (a=2D 35 30) - +50 (a=35 30)
-XX22 n	7E 30 30 32 32 20 a 0D	Contrast	n = -50 (a=2D 35 30) - +50 (a=35 30)
-XX23 n	7E 30 30 32 33 20 a 0D	Sharpness	n = -15 (a=2D 31 35) - +15 (a=31 35)
-XX44 n	7E 30 30 34 34 20 a 0D	Saturation	n = -50 (a=2D 35 30) - +50 (a=35 30)
-XX45 n	7E 30 30 34 35 20 a 0D	Tint	n = -50 (a=2D 35 30) - +50 (a=35 30)
-XX24 n	7E 30 30 32 34 20 a 0D	Color	Red Gain n = -50 (a=2D 35 30) - +50 (a=35 30)
-XX25 n	7E 30 30 32 35 20 a 0D		Green Gain n = -50 (a=2D 35 30) - +50 (a=35 30)
-XX26 n	7E 30 30 32 36 20 a 0D		Blue Gain n = -50 (a=2D 35 30) - +50 (a=35 30)
-XX27 n	7E 30 30 32 37 20 a 0D		Red Bias n = -50 (a=2D 35 30) - +50 (a=35 30)
-XX28 n	7E 30 30 32 38 20 a 0D		Green Bias n = -50 (a=2D 35 30) - +50 (a=35 30)
-XX29 n	7E 30 30 32 39 20 a 0D		Blue Bias n = -50 (a=2D 35 30) - +50 (a=35 30)
-XX30 n	7E 30 30 33 30 20 a 0D		Cyan n = -50 (a=2D 35 30) - +50 (a=35 30)
-XX31 n	7E 30 30 33 31 20 a 0D		Yellow n = -50 (a=2D 35 30) - +50 (a=35 30)
-XX32 n	7E 30 30 33 32 20 a 0D		Magenta n = -50 (a=2D 35 30) - +50 (a=35 30)
-XX33 1	7E 30 30 33 33 20 31 0D		Reset
-XX34 n	7E 30 30 33 34 20 a 0D	White Peaking	n = 0 (a=30) - 10 (a=31 30)
-XX35 1	7E 30 30 33 35 20 31 0D	Degamma	
-XX35 2	7E 30 30 33 35 20 32 0D		Film
-XX35 3	7E 30 30 33 35 20 33 0D		Video
-XX35 4	7E 30 30 33 35 20 34 0D		Graphics
-XX35 5	7E 30 30 33 35 20 35 0D		PC
-XX36 1	7E 30 30 33 36 20 31 0D	Color Temp.	Warm
-XX36 2	7E 30 30 33 36 20 32 0D		Medium
-XX36 3	7E 30 30 33 36 20 33 0D		Cold
-XX37 1	7E 30 30 33 37 20 31 0D	Color Space	Auto
-XX37 2	7E 30 30 33 37 20 32 0D		RGB
-XX37 3	7E 30 30 33 37 20 33 0D		YUV
-XX39 2	7E 30 30 33 39 20 32 0D	Input Source	DVI-I
-XX39 5	7E 30 30 33 39 20 35 0D		VGA
-XX39 9	7E 30 30 33 39 20 39 0D		S-Video
-XX39 10	7E 30 30 33 39 20 31 30 0D		VGA
-XX40 1	7E 30 30 34 30 31 0D	De-interlace	On
-XX40 2	7E 30 30 34 30 32 0D		Off
-XX60 1	7E 30 30 36 30 20 31 0D	Format	4:3
-XX60 2	7E 30 30 36 30 20 32 0D		16:9-1
-XX60 3	7E 30 30 36 30 20 33 0D		16:9-II/16:10
-XX60 5	7E 30 30 36 30 20 35 0D		Native
-XX60 7	7E 30 30 36 30 20 37 0D		Auto
-XX61 n	7E 30 30 36 31 20 a 0D	Overscan	n = 0 (a=30) - 10 (a=31 30)
-XX62 n	7E 30 30 36 32 20 a 0D	Zoom	n = -30 (a=2D 33 30) - +50 (a=35 30)
-XX63 n	7E 30 30 36 33 20 a 0D	H Image Shift	n = -50 (a=2D 35 30) - +50 (a=35 30)
-XX64 n	7E 30 30 36 34 20 a 0D	V Image Shift	n = -24 (a=2D 32 34) - +24 (a=32 34)
-XX66 n	7E 30 30 36 36 20 a 0D	V Keystone	n = -30 (a=2D 33 30) - +50 (a=33 30)
-XX70 1	7E 30 30 37 30 20 31 0D	Language	English
-XX70 2	7E 30 30 37 30 20 32 0D		German
-XX70 3	7E 30 30 37 30 20 33 0D		French
-XX70 4	7E 30 30 37 30 20 34 0D		Italian
-XX70 5	7E 30 30 37 30 20 35 0D		Spanish
-XX70 6	7E 30 30 37 30 20 36 0D		Portuguese
-XX70 7	7E 30 30 37 30 20 37 0D		Polish
-XX70 8	7E 30 30 37 30 20 38 0D		Dutch
-XX70 9	7E 30 30 37 30 20 39 0D		Swedish
-XX70 10	7E 30 30 37 30 20 31 30 0D		Norwegian/Danish
-XX70 11	7E 30 30 37 30 20 31 31 0D		Finnish

# Appendices

~XX70 12	7E 30 30 37 20 20 31 32 0D		Greek	
~XX70 13	7E 30 30 37 20 20 31 33 0D		Traditional Chinese	
~XX70 14	7E 30 30 37 20 20 31 34 0D		Simplified Chinese	
~XX70 15	7E 30 30 37 20 20 31 35 0D		Japanese	
~XX70 16	7E 30 30 37 20 20 31 36 0D		Korean	
~XX70 17	7E 30 30 37 20 20 31 37 0D		Russian	
~XX70 18	7E 30 30 37 20 20 31 38 0D		Hungarian	
~XX70 19	7E 30 30 37 20 20 31 39 0D		Czechoslovak	
~XX70 20	7E 30 30 37 20 20 32 30 0D		Arabic	
~XX70 21	7E 30 30 37 20 20 32 31 0D		Thai	
~XX70 22	7E 30 30 37 20 20 32 32 0D		Turkish	
~XX71 1	7E 30 30 37 31 20 31 0D	Projection	Front-Desktop	
~XX71 2	7E 30 30 37 31 20 32 0D		Rear-Desktop	
~XX71 3	7E 30 30 37 31 20 33 0D		Front-Ceiling	
~XX71 4	7E 30 30 37 31 20 34 0D		Rear-Ceiling	
~XX72 1	7E 30 30 37 32 20 31 0D	Menu Location	Top Left	
~XX72 2	7E 30 30 37 32 20 32 0D		Top Right	
~XX72 3	7E 30 30 37 32 20 33 0D		Center	
~XX72 4	7E 30 30 37 32 20 34 0D		Bottom Left	
~XX72 5	7E 30 30 37 32 20 35 0D		Bottom Right	
~XX73 n	7E 30 30 37 33 20 a 0D	Signal	Frequency	n= 0 (a=30) - 31 (a=33 31)
~XX74 n	7E 30 30 37 34 20 a 0D		Phase	n= -5 (a=2D 35) - +5 (a=35)
~XX75 n	7E 30 30 37 35 20 a 0D		H. Position	n= -5 (a=2D 35) - +5 (a=35)
~XX76 n	7E 30 30 37 36 20 a 0D		V. Position	n= -5 (a=2D 35) - +5 (a=35)
~XX77 n	7E 30 30 37 37 20 aabbc 0D	Security	Security Timer	Hour /Day/ Month n-bbdddm hh= 0 (a=30) ~ 24 (a=32 34) dd= 0 (a=30) ~ 30 (a=33 30) mm= 0 (a=30) ~ 12 (a=31 32)
~XX78 1	7E 30 30 37 38 20 31 0D		Security Settings	Enable
~XX78 2	7E 30 30 37 38 20 32 0D			Disable
~XX79 n	7E 30 30 37 39 20 a 0D	Projector ID		n=0 (a=30)- 99 (a=39 39)
~XX80 1	7E 30 30 38 20 20 31 0D	Mute	On	
~XX80 2	7E 30 30 38 20 20 32 0D		Off	
~XX81 n	7E 30 30 38 31 20 a 0D	Volume		n= 0 (a=30) - 10 (a=31 30)
~XX89 1	7E 30 30 38 39 20 31 0D	Audio Input	Mini Jack	
~XX89 1	7E 30 30 38 39 20 32 0D		RCA	
~XX82 1	7E 30 30 38 32 20 31 0D	Logo	Optoma	
~XX82 2	7E 30 30 38 32 20 32 0D		User	
~XX83 1	7E 30 30 38 33 20 31 0D	Logo capture		
~XX88 1	7E 30 30 38 34 20 31 0D	Close Caption	On	
~XX88 2	7E 30 30 38 34 20 32 0D		Off	
~XX86 1	7E 30 30 38 36 20 31 0D	RS232	RS232	
~XX86 2	7E 30 30 38 36 20 32 0D		Network	
~XX100 1	7E 30 30 31 30 20 31 0D	Source Lock	On	
~XX100 2	7E 30 30 31 30 20 32 0D		Off	
~XX101 1	7E 30 30 31 30 20 31 0D	High Altitude	On	
~XX101 2	7E 30 30 31 30 20 32 0D		Off	
~XX102 1	7E 30 30 31 30 32 20 31 0D	Information Hide	On	
~XX102 2	7E 30 30 31 30 32 20 32 0D		Off	
~XX103 1	7E 30 30 31 30 33 20 31 0D	Keypad Lock	On	
~XX103 2	7E 30 30 31 30 33 20 32 0D		Off	
~XX104 1	7E 30 30 31 30 34 20 31 0D	Background Color	Blue	
~XX104 2	7E 30 30 31 30 34 20 32 0D		Black	
~XX104 3	7E 30 30 31 30 34 20 33 0D		Red	
~XX104 4	7E 30 30 31 30 34 20 34 0D		Green	
~XX104 5	7E 30 30 31 30 34 20 35 0D		White	
~XX105 1	7E 30 30 31 30 35 20 31 0D	Advanced	Direct Power On	On
~XX105 2	7E 30 30 31 30 35 20 32 0D			Off
~XX106 n	7E 30 30 31 30 36 20 a 0D		Auto Power Off (min)	n=0 (a=30)-120 (a=31 32 30) (multiple of 5)
~XX107 n	7E 30 30 31 30 37 20 a 0D		Sleep Timer (min)	n=0 (a=30)-900 (a=39 30 30) (multiple of 5)
~XX108 1	7E 30 30 31 30 38 20 31 0D	Lamp Setting	Lamp Hour	
~XX109 1	7E 30 30 31 30 39 20 31 0D		Lamp Reminder	On
~XX109 2	7E 30 30 31 30 39 20 32 0D			Off
~XX110 1	7E 30 30 31 30 20 31 0D		Brightness Mode	Bright
~XX110 2	7E 30 30 31 30 20 32 0D			STD
~XX111 1	7E 30 30 31 31 20 31 0D		Lamp Reset	Yes
~XX111 2	7E 30 30 31 31 20 32 0D			No
~XX112 1	7E 30 30 31 31 32 20 31 0D	Reset		Yes
~XX112 2	7E 30 30 31 31 32 20 32 0D			No
<b>SEND to Remote</b>				
~XX140 1	7E 30 30 31 34 20 31 0D		Power	
~XX140 3	7E 30 30 31 34 20 33 0D		Remote Mouse Up	
~XX140 4	7E 30 30 31 34 20 34 0D		Remote Mouse Left	
~XX140 5	7E 30 30 31 34 20 35 0D		Remote Mouse Enter	

-XX140 6	7E 30 30 31 34 30 20 36 0D	Remote Mouse Right
-XX140 7	7E 30 30 31 34 30 20 37 0D	Remote Mouse Down
-XX140 8	7E 30 30 31 34 30 20 38 0D	Mouse Left Click
-XX140 9	7E 30 30 31 34 30 20 39 0D	Mouse Right Click
-XX140 10	7E 30 30 31 34 30 20 31 30 0D	Up/Page +
-XX140 11	7E 30 30 31 34 30 20 31 31 0D	Left/Source
-XX140 12	7E 30 30 31 34 30 20 31 32 0D	Enter (for projection MENU)
-XX140 13	7E 30 30 31 34 30 20 31 33 0D	Right/Re-SYNC
-XX140 14	7E 30 30 31 34 30 20 31 34 0D	Down/Page -
-XX140 15	7E 30 30 31 34 30 20 31 35 0D	Keystone +
-XX140 16	7E 30 30 31 34 30 20 31 36 0D	Keystone -
-XX140 17	7E 30 30 31 34 30 20 31 37 0D	Volume -
-XX140 18	7E 30 30 31 34 30 20 31 38 0D	Volume +
-XX140 19	7E 30 30 31 34 30 20 31 39 0D	Brightness
-XX140 20	7E 30 30 31 34 30 20 32 30 0D	Menu
-XX140 21	7E 30 30 31 34 30 20 32 31 0D	Zoom
-XX140 22	7E 30 30 31 34 30 20 32 32 0D	DVI-I
-XX140 23	7E 30 30 31 34 30 20 32 33 0D	Freeze
-XX140 24	7E 30 30 31 34 30 20 32 34 0D	AV Mute
-XX140 25	7E 30 30 31 34 30 20 32 35 0D	S-Video
-XX140 26	7E 30 30 31 34 30 20 32 36 0D	VGA
-XX140 27	7E 30 30 31 34 30 20 32 37 0D	Video

**SEND from projector automatically**

232 ASCH Code	HEX Code	Function	Projector Return	Description
when Standby/Warming/Cooling/Out of Range/Lamp fail			INFOh	n : 0/1/2/3/4 = Standby/Warming/Cooling/Out of Range/Lamp fail

**READ from projector**

232 ASCH Code	HEX Code	Function	Projector Return	Description
-XX121 1	7E 30 30 31 32 31 20 31 0D	Input Source Commands	OKn	n : 0/1/2/3/4= None/DVI-I/VGA/S-Video/Video
-XX122 1	7E 30 30 31 32 32 20 31 0D	Software Version	OKaaaa	
-XX123 1	7E 30 30 31 32 33 20 31 0D	Display Mode	OKn	n : 0/1/2/3/4/5=Presentation/Bright/Movie/sRGB/User1/User2
-XX124 1	7E 30 30 31 32 34 20 31 0D	Power State	OKn	n : 0/1=Off/On
-XX125 1	7E 30 30 31 32 35 20 31 0D	Brightness	OKn	
-XX126 1	7E 30 30 31 32 36 20 31 0D	Contrast	OKn	
-XX127 1	7E 30 30 31 32 37 20 31 0D	Aspect Ratio	OKn	n : 0/1/2/3/4=4:3/16:9/16:9/16:10/16:10/Native/auto
-XX128 1	7E 30 30 31 32 38 20 31 0D	Color Temperature	OKn	n : 0/1/2=Warm/Medium/Cold
-XX129 1	7E 30 30 31 32 39 20 31 0D	Projection Mode	OKn	n : 0/1/2/3=Front-Desktop/Rear-Desktop/Front-Ceiling/Rear-Ceiling
-XX150 1	7E 30 30 31 35 30 20 31 0D	Information	OKabbbbccddddd	a : 0/1=Off/On bbbb: Lamp Hour cccc: source 0/1/2/3/4= None/DVI-I/VGA/S-Video/Video dddd: FW version e : Display mode 0/1/2/3/4/5=Presentation/Bright/Movie/sRGB/User1/User2
-XX151 1	7E 30 30 31 35 31 20 31 0D	Model Name	OKn	n : 0/1/2=EX774/EW674/EX772
-XX152 1	7E 30 30 31 35 32 20 31 0D	RS232 Version No	OKn	



## Ceiling Installation



- ❖ Damage to the projector as a result of incorrect installation voids the warranty.

To prevent damage to your projector please use the recommended mounting package for installation.

To ensure compliance, only use a UL Listed ceiling mount and screws that meet the following specifications:

- 1 x 4 mm Tripod Mount—#1/4-20, maximum length 0.3"
  - 1 x 6.5 mm Tripod Mount—#1/4-20, maximum length 0.3"
- M3 – 3 x M3 Ceiling Mounts—M3x8, maximum length 8 mm



- ❖ Ensure at least 10cm clearance between the ceiling and the underside of the projector.
- ❖ Avoid locating the projector near heat sources such as air conditioning and heaters. Excess heat may cause the projector to power off.

Refer to the following diagram to ceiling mount the projector.

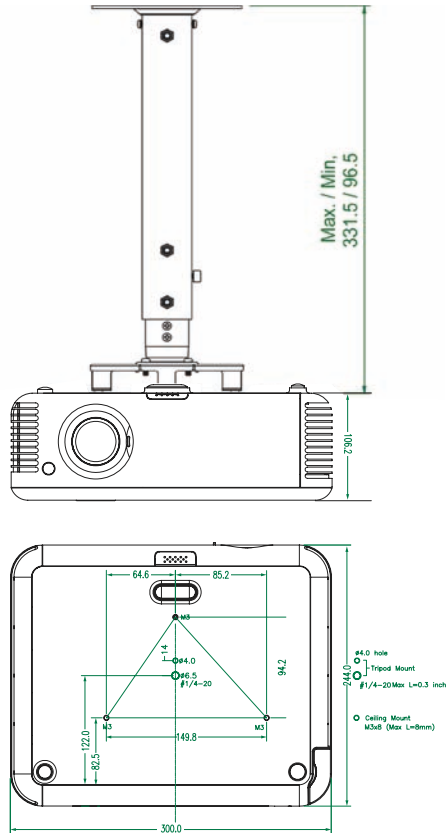

## Optoma Global Offices

*For service or support please contact your local office.*

### USA

715 Sycamore Drive  
Milpitas, CA 95035, USA  
Tel : 408-383-3700  
www.optomausa.com

Fax : 408-383-3702  
Service : [services@optoma.com](mailto:services@optoma.com)

### Canada

5630 Kennedy Road, Mississauga,  
ON, L4Z 2A9, Canada  
Tel : 905-361-2582  
www.optoma.ca

Fax : 905-361-2581

### Europe

42 Caxton Way, The Watford Business Park  
Watford, Hertfordshire, WD18 8QZ, UK  
Tel : +44 (0) 1923 691 800  
www.optoma.eu  
Service Tel : +44 (0)1923 691865

Fax : +44 (0) 1923 691 888

Service : [service@tsc-europe.com](mailto:service@tsc-europe.com)

### France

Bâtiment E 81-83 avenue Edouard Vaillant  
92100 Boulogne Billancourt, France  
Tel.: +33 1 41 46 12 20  
Service : [savoptoma@optoma.fr](mailto:savoptoma@optoma.fr)

Fax : +33 1 41 46 94 35

### Spain

C/ José Hierro,36 Of, 1C  
28529 Rivas Vacia Madrid, Spain  
Tel.: +34 91 499 06 06

Fax : +34 91 670 08 32

### Deutschland

Werftstrasse 25 D40549  
Düsseldorf, Germany  
Tel : +49 (0) 211 506 6670  
Service : [info@optoma.de](mailto:info@optoma.de)

Fax : +49 (0) 211 506 66799

## Scandinavia

Grev Wedels Plass 2  
3015 Drammen Norway  
Tel : +47 32 26 89 90  
Service : [info@optoma.no](mailto:info@optoma.no)

Fax : +47 32 83 78 98

## Latin America

715 Sycamore Drive  
Milpitas, CA 95035, USA  
Tel : 408-383-3700  
[www.optoma.com.br](http://www.optoma.com.br)

Fax : 408-383-3702  
[www.optoma.com.mx](http://www.optoma.com.mx)

## Korea

WOOMI TECH.CO.,LTD

4F,Minu Bldg.33-14, Kangnam-Ku, seoul,135-815, KOREA

Tel : +82+2+34430004

Fax : +82+2+34430005

## Japan

東京都足立区綾瀬3-25-18  
株式会社オーエスエム  
サポートセンター:0120-46-5040  
E-mail : [info@osscreen.com](mailto:info@osscreen.com)

[www.os-worldwide.com](http://www.os-worldwide.com)

## Taiwan

5F., No. 108, Minchiuan Rd., Shindian City,  
Taipei Taiwan 231, R.O.C.

Tel : +886-2-2218-2360

Fax : +886-2-2218-2313

[www.optoma.com.tw](http://www.optoma.com.tw)

[asia.optoma.com](http://asia.optoma.com)

Service : [services@optoma.com.tw](mailto:services@optoma.com.tw)

## Hong Kong

Unit A, 27/F Dragon Centre, 79 Wing Hong Street,  
Cheung Sha Wan, Kowloon, Hong Kong

Tel : +852-2396-8968

Fax : +852-2370-1222

[www.optoma.com.hk](http://www.optoma.com.hk)

## China

5F, No. 1205, Kaixuan Rd., Changning District  
Shanghai, 200052, China

Tel : +86-21-62947376

Fax : +86-21-62947375

[www.optoma.com.cn](http://www.optoma.com.cn)

## Regulation & Safety notices

This appendix lists the general notices of your projector.

### FCC notice

This device has been tested and found to comply with the limits for a Class B digital device pursuant to Part 15 of the FCC rules. These limits are designed to provide reasonable protection against harmful interference in a residential installation. This device generates, uses, and can radiate radio frequency energy and, if not installed and used in accordance with the instructions, may cause harmful interference to radio communications.

However, there is no guarantee that interference will not occur in a particular installation. If this device does cause harmful interference to radio or television reception, which can be determined by turning the device off and on, the user is encouraged to try to correct the interference by one or more of the following measures:

- ▶ Reorient or relocate the receiving antenna.
- ▶ Increase the separation between the device and receiver.
- ▶ Connect the device into an outlet on a circuit different from that to which the receiver is connected.
- ▶ Consult the dealer or an experienced radio/television technician for help.

### ***Notice: Shielded cables***

All connections to other computing devices must be made using shielded cables to maintain compliance with FCC regulations.

### ***Caution***

Changes or modifications not expressly approved by the manufacturer could void the user's authority, which is granted by the Federal Communications Commission, to operate this computer.

## Operation conditions

This device complies with Part 15 of the FCC Rules. Operation is subject to the following two conditions:

1. This device may not cause harmful interference, and
2. This device must accept any interference received, including interference that may cause undesired operation.

### Notice: Canadian users

This Class B digital apparatus complies with Canadian ICES-003.

### Remarque à l'intention des utilisateurs canadiens

Cet appareil numérique de la classe B est conforme à la norme NMB-003 du Canada.

### Declaration of Conformity for EU countries

- ▶ EMC Directive 2004/108/EC (including amendments)
- ▶ Low Voltage Directive 2006/95/EC
- ▶ R & TTE Directive 1999/5/EC (if product has RF function)

## Disposal instructions



**Do not throw this electronic device into the trash when discarding. To minimize pollution and ensure utmost protection of the global environment, please recycle it.**