

myprojectorlamps.com

**The most trusted, dependable name
in projector lamp sales.**



<http://www.myprojectorlamps.com>



<http://www.myprojectorlamps.ca>



<http://www.myprojectorlamps.eu>



The following projector manual has not been modified or altered in any way.

Table of contents

+	+	+	+	Table of Contents	1
+	+	+	+	Usage Notice	2
				<i>Safety Information</i>	2
				<i>Precautions</i>	3
				<i>Eye Safety Warnings</i>	5
+	+	+	+	Introduction	6
				<i>Product Features</i>	6
				<i>Package Overview</i>	7
				<i>Product Overview</i>	8
				<i>Main Unit</i>	8
				<i>Control Panel</i>	9
				<i>Connection Ports</i>	10
				<i>Remote Control</i>	11
+	+	+	+	Installation	12
				<i>Connecting the Projector</i>	12
				<i>Powering On/Off the Projector</i>	13
				<i>Powering On the Projector</i>	13
				<i>Powering Off the projector</i>	14
				<i>Warning Indicator</i>	14
				<i>Adjusting the Projected Image</i>	15
				<i>Adjusting the Projector's Height</i>	15
				<i>Adjusting the Projector's Zoom / Focus</i>	16
				<i>Adjusting Projected Image Size</i>	16
+	+	+	+	User Controls	17
				<i>Control Panel & Remote Control</i>	17
				<i>On-screen Display Menus</i>	20
				<i>How to operate</i>	20
				<i>Menu Tree</i>	21
				<i>Image</i>	22
				<i>Display</i>	26
				<i>Setup</i>	29
				<i>System</i>	32
+	+	+	+	Appendices	36
				<i>Troubleshooting</i>	36
				<i>Image Problems</i>	36
				<i>Intermission Problems</i>	38
				<i>Projector Status Indication</i>	39
				<i>Remote Control Problems</i>	40
				<i>Replacing the Lamp</i>	41
				<i>Compatibility Modes</i>	42
				<i>RS232 Commands and Protocol Function List</i>	43
				<i>Ceiling Mount Installation</i>	46
				<i>Optoma Global Offices</i>	47
				<i>Regulation & Safety notices</i>	49

Usage Notice

Safety Information

	The lightning flash with arrowhead within an equilateral triangle is intended to alert the user to the presence of uninsulated "dangerous voltage" within the product's enclosure that may be of sufficient magnitude to constitute a risk of electric shock to persons.
	The exclamation point within an equilateral triangle is intended to alert the user to the presence of important operating and maintenance (servicing) instructions in the literature accompanying the appliance.

WARNING: TO REDUCE THE RISK OF FIRE OR ELECTRIC SHOCK, DO NOT EXPOSE THIS APPLIANCE TO RAIN OR MOISTURE. DANGEROUS HIGH VOLTAGES ARE PRESENT INSIDE THE ENCLOSURE. DO NOT OPEN THE CABINET. REFER SERVICING TO QUALIFIED PERSONNEL ONLY.

Class B emissions limits

This Class B digital apparatus meets all requirements of the Canadian Interference-Causing Equipment Regulations.

Important Safety Instruction

1. Read these instructions -before using this projector.
2. Keep these instructions -for future reference.
3. Follow all instructions.
4. Install in accordance with the manufacturer's instructions

A. Do not block any ventilation openings

To ensure reliable operation of the projector and to protect it from overheating, put the projector in a position and location that will not interfere with its proper ventilation. For example, do not place the projector on a bed, sofa, carpet, or similar surface that may block the ventilation openings. Do not put it in an enclosure, such as a bookcase or a cabinet that may keep air from flowing through its ventilation openings.

B. Do not use this projector near water or moisture. To reduce the risk of fire or electric shock, do not expose the projector to rain or moisture.

C. Do not install near any heat sources, such as radiators, heaters, stoves or other apparatus (including amplifiers) that produce heat.

5. Clean only with a dry cloth.
6. Only use attachments/accessories specified by the manufacturer.
7. Refer all servicing to qualified service personnel. Servicing is required when the projector has been damaged in any way:
 - Such as power supply cord or plug is damaged.
 - Liquid has been spilled or objects have fallen into the apparatus.
 - The projector has been exposed to rain or moisture, does not operate normally, or has been dropped.

Do not attempt to service this projector yourself. Opening or removing covers may expose you to dangerous voltages or other hazards. Please call Optoma to be referred to an authorized service center near you.

8. Do not let objects or liquids enter the projector -as they may touch dangerous voltage points or short-out parts that could result in a fire or electric shock.
9. See projector enclosure for safety related markings.
10. The projector should not be adjusted or repaired by anyone except properly qualified service personnel.

Precautions



Please follow all warnings, precautions and maintenance as recommended in this user's guide.

- ■ Warning- Do not look into the projector's lens when the lamp is on. The bright light may hurt your eyes.
- ■ Warning- To reduce the risk of fire or electric shock, do not expose this projector to rain or moisture.
- ■ Warning- Please do not open or disassemble the projector as this may cause electric shock.
- ■ Warning- When replacing the lamp, please allow unit to cool down, and follow all replacement instructions. See page 41.
- ■ Warning- This projector will detect the life of the lamp itself. Please be sure to change the lamp when it shows warning messages.
- ■ Warning- Reset the "Lamp Reset" function from the on-screen display "System | Lamp Setting" menu after replacing the lamp module (refer to page 35).
- ■ Warning- When switching the projector off, please ensure the cooling cycle has been completed before disconnecting power. Allow 90 seconds for the projector to cool down.
- ■ Warning- Do not use lens cap when projector is in operation.
- ■ Warning- When the lamp is approaching to the end of its life time, the message "Replacement suggested" will show on the screen. Please contact your local reseller or service center to change the lamp as soon as possible.

Note

When the lamp reaches the end of its life, the projector will not turn back on until the lamp module has been replaced. To replace the lamp, follow the procedures listed under "Replacing the Lamp" section on page 41.

Usage Notice

Do:

- ■ Turn off the product before cleaning.
- ■ Use a soft cloth moistened with mild detergent to clean the display housing.
- ■ Disconnect the power plug from AC outlet if the product is not being used for a long period of time.

Do not:

- ■ Block the slots and openings on the unit provided for ventilation.
- ■ Use abrasive cleaners, waxes or solvents to clean the unit.
- ■ Use under the following conditions:
 - Extremely heat, cold or humidity.
 - In areas susceptible to excessive dust and dirt.
 - Near any appliance generating a strong magnetic field.
 - In direct sunlight.

Eye Safety Warnings



- ■ Avoid staring directly into the projector beam at all times.
- ■ Minimize standing facing into the beam. Keep your back to the beam as much as possible.
- ■ A stick or laser pointer is recommended to avoid the need for the user to enter the beam.
- ■ Ensure that projectors are located out of the line of sight from the screen to the audience; this ensures that, when presenters look at the audience, they do not also have to stare at the projector lamp. The best way to achieve this is by ceiling-mounting rather than floor or table-mounting the projector.
- ■ When projector is used in a classroom, adequately supervise students when they are asked to point out something on the screen.
- ■ In order to minimize the lamp power needed, use room blinds to reduce ambient light levels.

Introduction

Product Features

This product is a 1080p single chip 0.95" DLP® projector. Outstanding features include:

- Native 16:9 1080p DLP® Technology
- Complete 10-bit video processing (decoding, deinterlacing, scaling, image enhancement and color)
- PixelWorks™ video processor chip
- Studio-grade 480i/576i Standard Definition de-interlacing and 1080i High Definition de-interlacing
- Video Compatibility:
 - 480i-NTSC, NTSC4.43
 - 576i-PAL/PAL-M/PAL-N/SECAM
 - SDTV compatible (480i/p, 576i/p)
 - HDTV compatible (720p, 1080i/p)
 - RGB signal: HD, XGA, SVGA, VGA res-sizing
- Macintosh compatible
- Full function IR remote control with back light
- Advanced vertical digital keystone correction and high quality full screen image re-scaling
- User friendly control panel
- Optoma's patent-pending O₂Air™ Photo Catalyst air purification technology
- HDMI & DVI support HDCP function.
- HDMI(support HDMI 1.3) x2, DVI-I (support HDMI 1.1, SCART, HDTV) x1, YPbPr (RCA) x1, S-Video x1, Composite x1



Introduction

Package Overview

This projector comes with all the items shown below. Check to make sure your unit is complete. Contact your dealer immediately if anything is missing.



Projector with lens cap



Power Cord 1.8m



RS232 Cable 1.8m



RCA Component Cable for YPbPr 2.0m



IR Remote Controller



2 x AA Batteries

Available in European version only



SCART RGB/S-Video Adaptor



DVI to VGA Adaptor



VGA Cable 1.8m

Note

Due to the difference in applications for each country, some regions may have different accessories.

Documentation :

- User's Manual
- Warranty Card
- Quick Start Card

Introduction

Product Overview

Main Unit



1. Control Panel
2. Zoom Lever
3. Focus Ring
4. Elevator Button (one on each side)
5. Elevator Feet
6. Zoom Lens
7. IR Receivers
8. Connection Ports
9. Power Socket
10. Tilt-Adjustment Feet
11. Air exhaust vent

Introduction

Control Panel

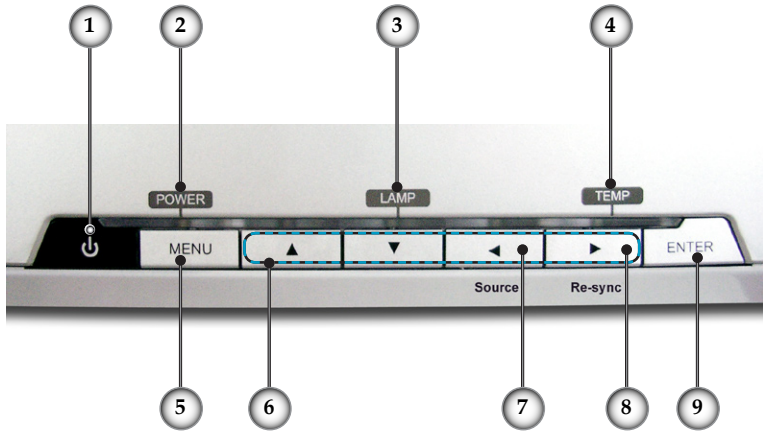

1. Power and IR Receiver
2. Power Indicator LED
3. Lamp Indicator LED
4. Temp Indicator LED
5. Menu (On/Off)
6. Four Directional Select Keys
7. Source Select
8. Re-Sync
9. Enter

Introduction

Connection Ports

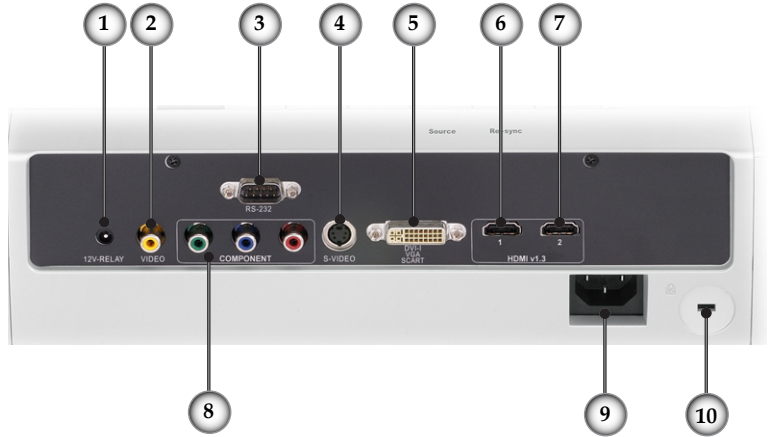

1. +12V Relay Connector
2. Composite Video Input Connector
3. RS232 Input Connector
4. S-Video Input Connector
5. DVI-I Input Connector (PC Digital and DVI-HDCP)
6. HDMI 1 Connector
7. HDMI 2 Connector
8. Component Video Input Connector
9. Power Socket
10. Kensington Microsaver™ Lock Port

Remote Control

1. Power (On/Off)
2. Contrast
3. Gamma
4. Brite Mode
5. Image Shift
6. Enter
7. Four Directional Select Keys
8. Display Mode
9. Edge Mask
10. Brightness
11. Image AI
12. IRIS
13. Menu
14. Overscan
15. 4:3
16. 16:9
17. HDMI1 Source
18. YPbPr Source
19. Letter-Box
20. Native
21. DVI Source
22. Composite Video Source
23. HDMI2 Source
24. S-Video

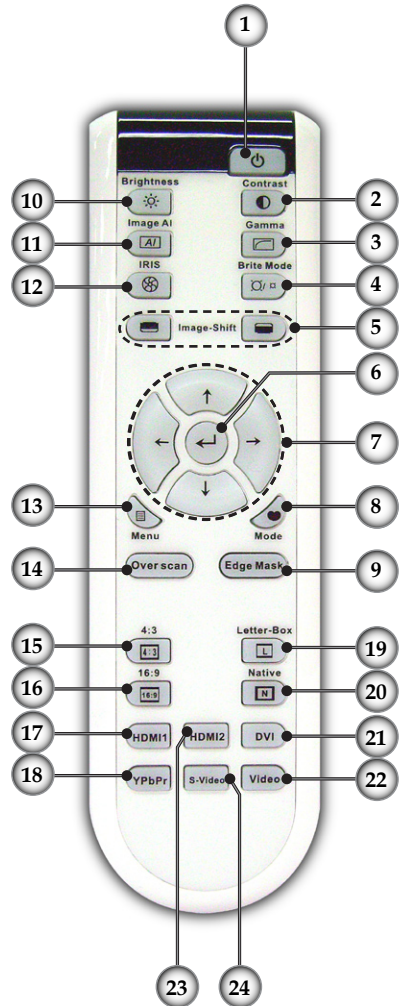

Installation

Connecting the Projector

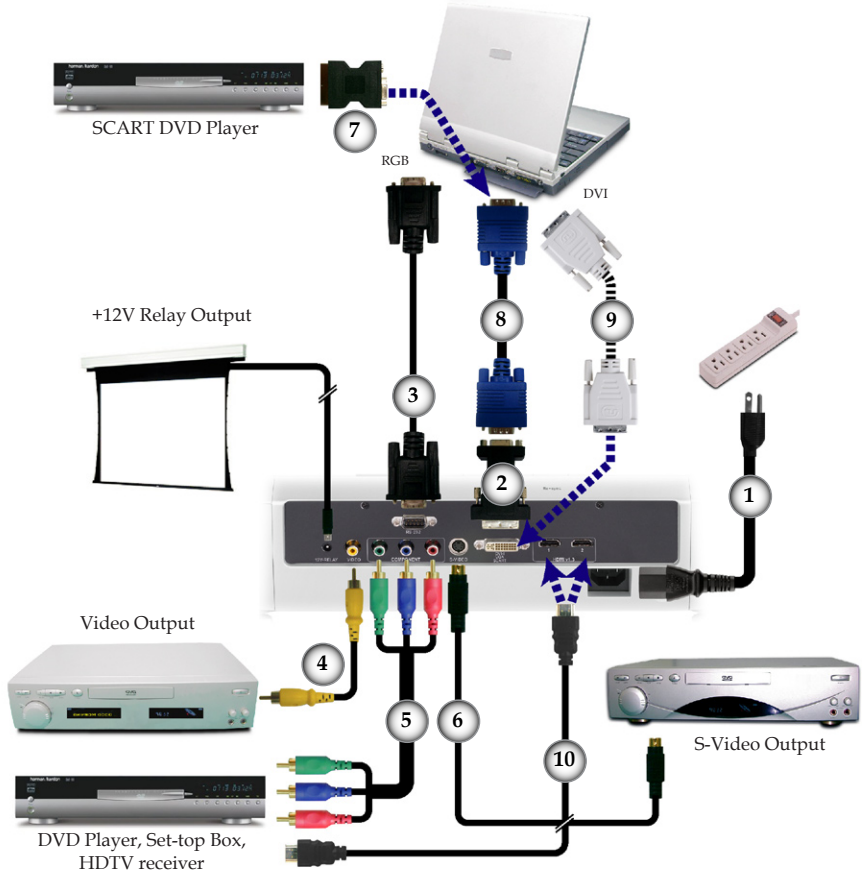

Note

Due to the difference in applications for each country, some regions may have different accessories.

- 1.....Power Cord
- 2.....DVI to VGA Adaptor (For European Only)
- 3.....RS232 Cable
- 4.....Composite Video Cable (Optional Accessory)
- 5.....RCA Component Cable for YPbPr
- 6.....S-Video Cable (Optional Accessory)
- 7.....SCART RGB/S-Video Adaptor (For European Only)
- 8.....VGA Cable (For European Only)
- 9.....DVI Cable (Optional Accessory)
- 10.....HDMI Cable (Optional Accessory)

Powering On/Off the Projector

Powering On the Projector

1. Remove the lens cap. ❶
2. Ensure that the power cord and signal cable are securely connected. The Power LED will turn red.
3. Turn on the lamp by pressing “⏻” button on the control panel. ❷ And the Power LED will turn blue.

The startup screen will display in approximately 30 seconds. The first time you use the projector, you can select your preferred language from quick menu after the startup screen display.

4. Turn on your source (computer, notebook, video player, etc.). The projector will detect your source automatically within “Setup” menu, check that “Source Lock” has been set to “Off”.
- If you connected multiple sources at the same time, press the “Source” button on the control panel or direct source key on the remote control to switch between inputs.

Note

Turn on the projector first and then select the signal sources.

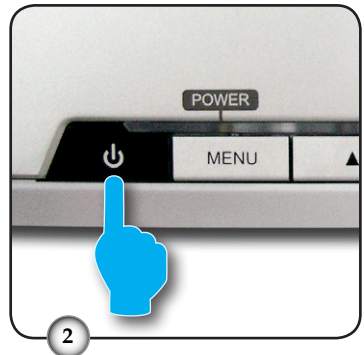

Powering Off the Projector

1. Press the “⏻” button to turn off the projector lamp, you will see a message displayed on the projector’s screen.

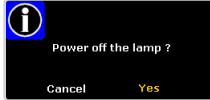

Press the “⏻” button again to confirm, otherwise the message will disappear after 5 seconds.

2. The cooling fans continue to operate for about 60 seconds for cooling cycle and the Power LED will flash blue. When the lights solid red, the projector has entered standby mode.

If you wish to turn the projector back on, you must wait until the projector has completed the cooling cycle and has entered standby mode. Once in standby mode, simply press “⏻” button to restart the projector.

3. Disconnect the power cord from the electrical outlet and the projector.
4. Do not turn on the projector immediately following a power off procedure.

Warning Indicator

- When the “LAMP” indicator lights solid red, the projector will automatically shut itself down. Please contact your local reseller or service centre. See page 47.
- When the “TEMP” indicator flashes red, it indicates the projector has overheated. The projector will automatically shut itself down.
Under normal conditions, the projector can be switched on again after it has cooled down. If the problem persists, you should contact your local dealer or our service center. See page 47.
- When the “LAMP” indicator flashes red, it indicates the fan has failed. Please contact your local dealer or our service centre. See page 47.

Adjusting the Projected Image

Adjusting the Projector's Height

The projector is equipped with elevator feet for adjusting the image height.

To raise the image:

1. Press the elevator button **1**.
2. Raise the image to the desired height angle **2**, then release the button to lock the elevator feet into position.
3. Use screw in feet **3** to fine-tune the display angle.

To lower the image:

1. Press the elevator button.
2. Lower the image, then release the button to lock the elevator feet into position.
3. Use screw in feet **3** to fine-tune the display angle.

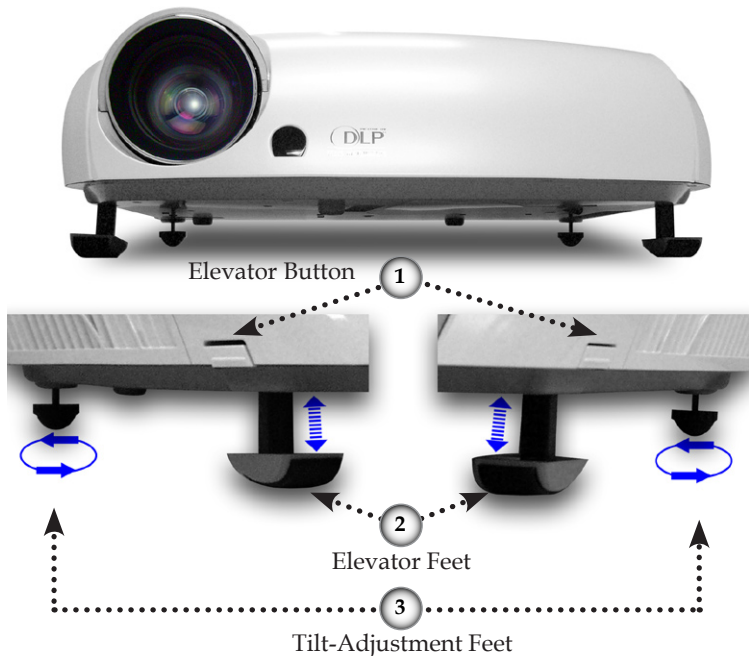

Installation

Adjusting the Projector's Zoom / Focus

Turn the Zoom Lever to zoom in or zoom out. To focus the image, turn the focus ring until you see a clear image. The projector will focus at distances from 4.9 to 39.4 feet (1.5 to 12.0 meters) and the projection screen size from 0.775m~7.62m (30.5"~300") at 16:9 mode with mechanical travel.



Adjusting Projection Image Size

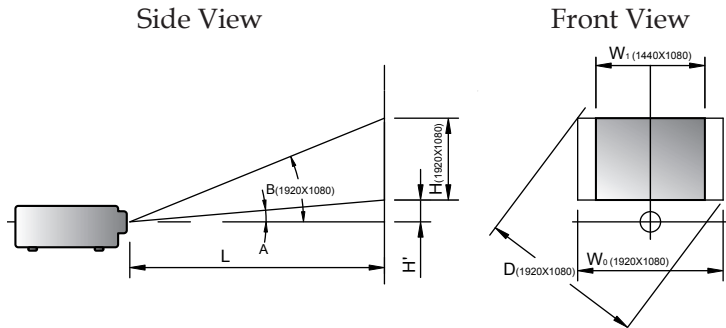

Throw Ratio (TR)=1.85 as Wide mode								
$A=6.25^\circ$	B (1920x1080)=22.47°		W_0 (1920x1080)=L/TR					
$H=L \times \tan(A)$			W_1 (1440x1080)= W_0 (1920x1080) \times 0.75					
H (1920x1080)= W_0 (1920x1080) \times 0.56			H (1440x1080)= W_1 (1440x1080) \times 0.75					
Display Format	A	B	L (cm)	W (cm)	H (cm)	H' (cm)	D (cm)	D' (in)
16:9 (1920x1080)	6.25	22.47	245.73	132.83	74.72	26.90	152.40	60.00
4:3 (1440x1080)	6.25	22.47	245.73	99.62	74.72	26.90	124.53	49.03
Projection Distance (M)	2.0		2.5	3.0	3.5	4.0	5.0	6.0
Screen Size 16:9 (inch)	Max	48.8	61.0	73.3	85.5	97.7	122.1	146.5
	Min	40.7	50.9	61.0	71.2	81.4	101.7	122.1
Screen Size 4:3 (inch)	Max	39.9	49.9	59.9	69.8	79.8	99.8	119.7
	Min	33.3	41.6	49.9	58.2	66.5	83.1	99.8

User Controls

Control Panel & Remote Control

There are two ways for you to control the functions: Control Panel and Remote Control.

Using the Control Panel







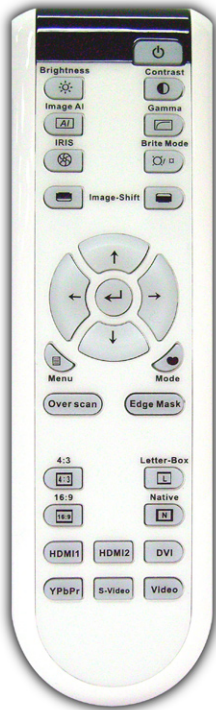











Power	Refer to the “Power On/Off the Projector” section on pages 13-14.
Source	Press “Source” to choose DVI, RGB, Component-p, Component-i, S-Video, Composite Video, HDTV and HDMI sources.
Menu	Press “Menu” to launch the on-screen display (OSD) menu. To exit OSD, Press “Menu” again.
Four Directional Select Keys	Use ▲ ▼ ◀ ▶ to select items or make adjustments to your selection.
Enter	Confirm your item selection.
Re-Sync	Automatically synchronizes the projector to the input source.

User Controls



Using the Remote Control

- | | |
|--|--|
|  Power | Refer to the “Power On/Off the Projector” section on pages 13-14. |
|  Brightness | Adjust the brightness of the image. |
|  Contrast | Control the degree of difference between the lightest and darkest parts of the picture. |
|  Image AI | Switch the Image AI function ON/OFF. (refer to page 32-33) |
|  Gamma | There are 10 preset gamma curves. After the initial setup and fine tuning is completed, utilize the Gamma Adjustment steps to optimize your image output. |
|  IRIS | Refer to “IRIS” function on page 33 for more information. |
|  Brite Mode | Increase the brightness of the image. (refer to page 35). |
|  Image Shift | Shifts the projected image position vertically. |
|  Edge Mask | Choose “On” to mask off a few pixels on each edge of the image to be displayed. Use Edge Mask “On” if image source happens to have encoding error near any edge of the displayable image. |
|  Mode | Select the display mode from Cinema, Bright, TV, sRGB and User. |
|  Menu | Press “Menu” to launch the on-screen display (OSD) menu. To exit OSD, Press “Menu” again. |
| Four Directional Select Keys | Use     to select items or make adjustments to your selection. |
|  Enter | Confirm your item selection. |
| Overscan | Mask off a few pixels on each edge of the image to be displayed. Use this function to adjust if image source happens to have noise near any edge of the display image. |
|  4:3 | Scale the image at a 4:3 aspect ratio. |
-

User Controls

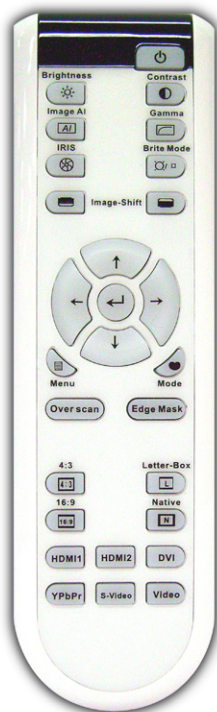

16:9	Scale the image at a 16:9 aspect ratio.
[N] Native	The input source will be displayed without scaling.
[L] Letter-Box	Enable the viewing of the letterboxed non-anamorphically enhanced movie at full screen width. Part of the original image will be lost if the image aspect ratio is less than 2.35:1.
DVI	Press "DVI" to choose Analog and Digital Signal source from DVI connector.
HDMI1	Press "HDMI1" to choose source from HDMI1 connector.
HDMI2	Press "HDMI2" to choose source from HDMI2 connector.
YPbPr	Press "YPbPr" to choose Component video source.
Video	Press "Video" to choose Composite video source.
S-Video	Press "S-Video" to choose S-video source.

On-screen Display Menus

The Projector has multilingual On-screen Display menus that allow you to make image adjustments and change a variety of settings. The projector will automatically detect the source.

How to operate

1. To open the OSD menu, press "Menu" on the Remote Control or Control Panel.
2. When OSD is displayed, use ▲ ▼ keys to select any item in the main menu. While making a selection on a particular page, press ► or "Enter" key to enter sub menu.
3. Use ▲ ▼ keys to select the desired item and adjust the settings by ◀ ▶ key.
4. Select the next item to be adjusted in the sub menu and adjust as described above.
5. Press "Enter" or "Menu" to confirm, and the screen will return to the main menu.
6. To exit, press "Menu" again. The OSD menu will close and the projector will automatically save the new settings.

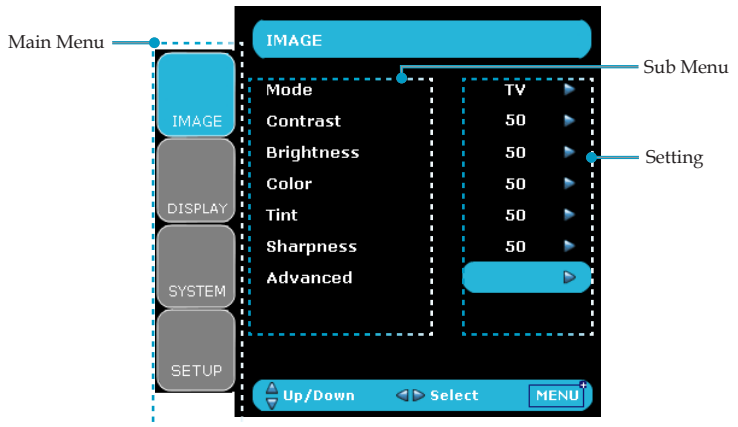

User Controls

Menu Tree

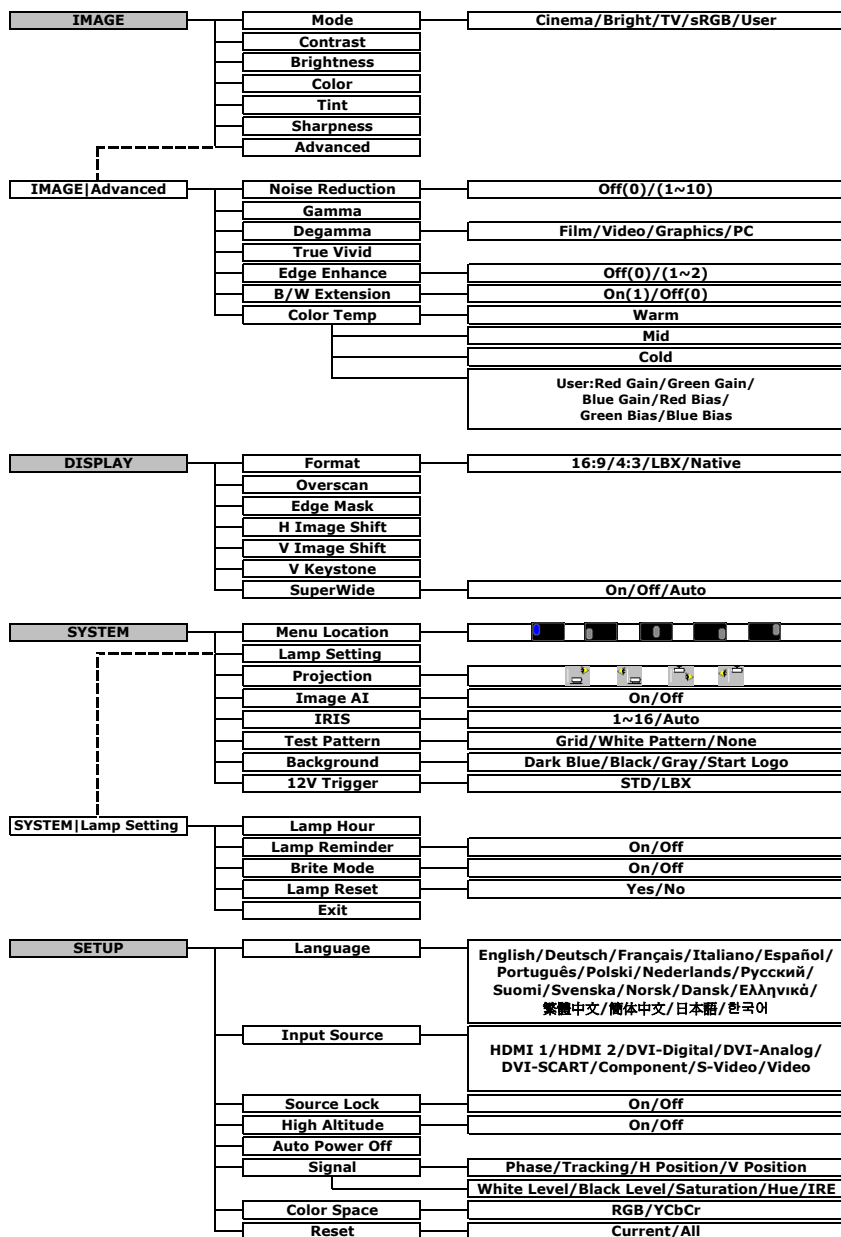

User Controls

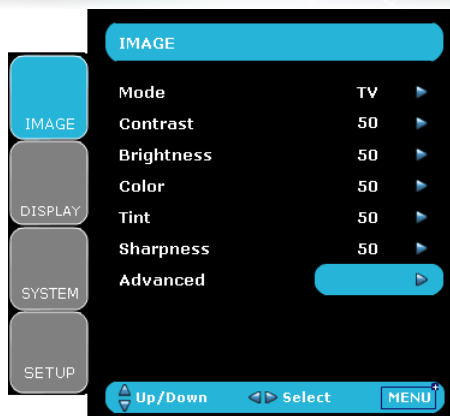

Image

Mode

There are many factory presets optimized for various types of images.

- ▶ Cinema: For home theater.
- ▶ Bright: For the brightest possible image, Use if ambient light is present.
- ▶ TV: For watching analogue or digital TV images.
- ▶ sRGB: For standard color.
- ▶ User: Memorize user's settings.

Contrast

The contrast controls the degree of difference between the lightest and darkest parts of the picture. Adjusting the contrast changes the amount of black and white in the image.

- ▶ Press the ◀ to decrease the contrast.
- ▶ Press the ▶ to increase the contrast.

Brightness

Adjust the brightness of the image.

- ▶ Press the ◀ to darken image.
- ▶ Press the ▶ to lighten the image.

Color

Adjusts a video image from black and white to fully saturated color.

- ▶ Press the ◀ to decrease the amount of color in the image.
- ▶ Press the ▶ to increase the amount of color in the image.

Note

"Image mode-->TV" will support automatically "Overscan" with step "2" as default.

User Controls

Tint

Adjusts the color balance of red and green.

- ▶ Press the ◀ to increase the amount of green in the image.
- ▶ Press the ▶ to increase the amount of red in the image.

Sharpness

Adjusts the sharpness of the image.

- ▶ Press the ◀ to decrease the sharpness.
- ▶ Press the ▶ to increase the sharpness.

User Controls

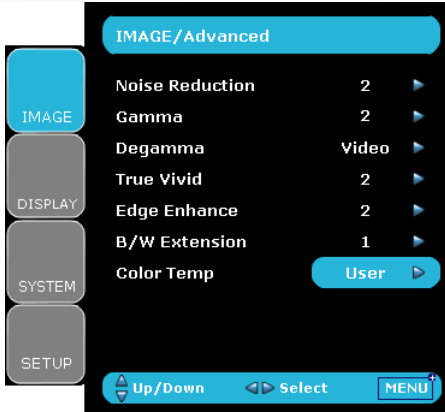

Image | Advance

Noise Reduction

The motion Adaptive Noise Reduction reduces the amount of visible noise interlaced signals. The range is from "0" to "10". (0:Off)

Gamma

This unit comes with 10 preset gamma curves. After the initial setup and fine tuning is completed, utilize the Gamma Adjustment steps to optimize your image output.

Degamma

This allows you to choose a degamma table that has been fine-tuned to bring out the best image quality for the input.

- ▶ Film: For home theater.
- ▶ Video: For video or TV source.
- ▶ Graphics: For image source.
- ▶ PC: For PC or computer source.

True Vivid

This adjustable item utilizes a new color-processing algorithm and enhancements to enable the picture's vividness to be significantly increased. The range is from "0" to "5".

Edge Enhance

There are 3 pre-set modes and one user mode for advanced edge enhancement filter. You can easily switch between the modes to achieve different effects. (0:Off)

B/W Extension

Black and White Extension can stretch the black and white levels to automatically increase the contrast of input image. This unit has 2



"B/W Extension" can't support when source is HDMI, analog or digital RGB via DVI port.

User Controls

pre-set modes that allow the user to switch among the pre-sets to obtain different image effects. (0:Off/1:On)

Color Temp.

Adjust the color temperature. At cold temperature, the screen looks colder; at warm temperature, the screen looks warmer.

- 1) For User mode adjustment, put cursor on "User", and press "Enter" to select this adjustment item.

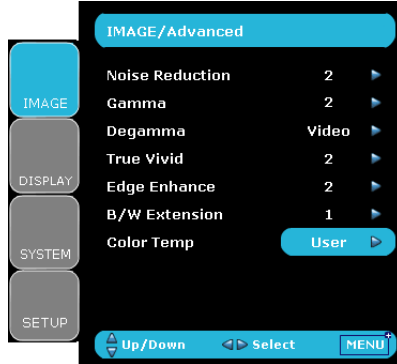

- 2) Use "▲", "▼" to highlight the desired adjustment items, then press "Enter" or "▶" to select it. The Menu disappears and only an adjustment bar appears.
- 3) Use "◀", "▶" arrow keys to adjust image.

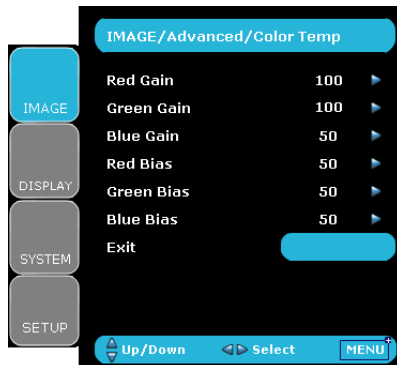

User Controls

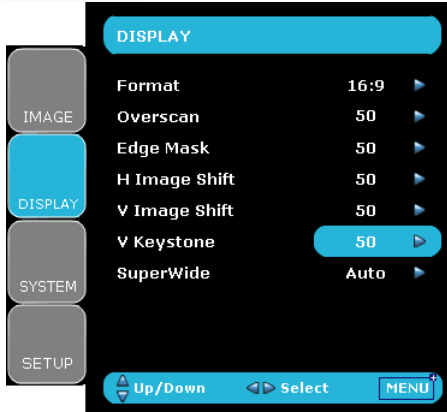

Display

Format

Use this function to choose your desired aspect ratio.

- ▶ 4:3: This format is for 4x3 input sources not enhanced for Wide-screen TV.
- ▶ 16:9: This format is for 16x9 input sources, like HDTV and DVD enhanced for Widescreen TV.
- ▶ Native: This format displays the original image without any scaling.

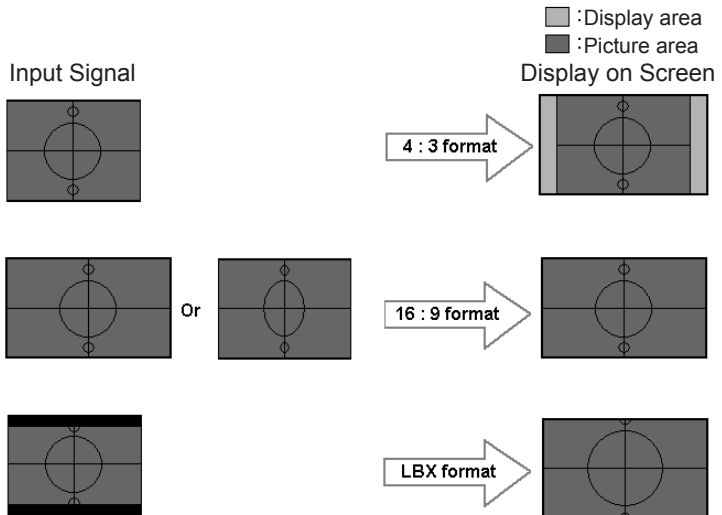

- ▶ LBX: This format is for non-16x9, letterbox source and for users who use external 16x9 lens to display 2.35:1 aspect ratio using full resolution.

Detail informations about LBX mode :

1. Some Letter-Box DVDs are not enhanced for 16x9 TVs. In this situation, the image will not look right when displayed in 16:9 mode.

In this situation, please try to using the 4:3 mode to view the DVD.

But if the content itself is not 4:3, it will have black bars around the image in a 16:9 display. For this kind of content, you can use LBX mode to fill the image in the 16x9 display as much as possible.

2. If you use an external 16x9 lens, this LBX mode also allows you to watch a 2.35:1 content (include Anamorphic DVD and HDTV film source) that support anamorphic wide is enhanced for 16x9 Display in a wide 2.35:1 image.

In this case, there are no black bars, the full lamp power and vertical resolution is fully utilized for maximum viewing effects.

Other than these two occasions, one should stay with 16:9 and 4:3 modes for most viewing experiences.

Note

(*) Each I/O has different setting of "Over-scan".

(*) "Image mode-->TV" will support automatically "Over-scan" with step "2" as default.

(*) "Over-scan" and "Edge mask" can't work at same time.

(*) "H Image shift" only support in format "4:3" and "Native". If source is 1080i/p, "H Image shift" only support in format "4:3".

Over-scan

Over-scan function removes the noise in a video image. Over-scan the image to remove video encoding noise on the edge of video source.

Edge Mask

▶ Press the ◀ to reduce the size of an image.

▶ Press the ▶ to magnify an image on the projection screen.

H Image Shift

Shifts the projected image position horizontally.

V Image Shift

Shifts the projected image position vertically.

User Controls

V Keystone

Press the ◀ or ▶ to adjust image distortion vertically and makes a squarer image.

Note

- ❖ “SuperWide” is “Off” as default.
- ❖ How to use “SuperWide”
 1. Use a 2.0:1 screen that buy from Optoma
 2. Enable SuperWide feature to Auto
 3. Use zoom ring in top of projector to fit the image width to the screen width

SuperWide

- ▶ Off: The format can be chosen your desired aspect ratio including 4:3, 16:9, LBX and Native.
- ▶ On: The format only can be chosen 4:3 and 16:9.
- ▶ Auto: To solve the differences of the film formats, the option can keep the format in the same ratio.

User Controls

Setup

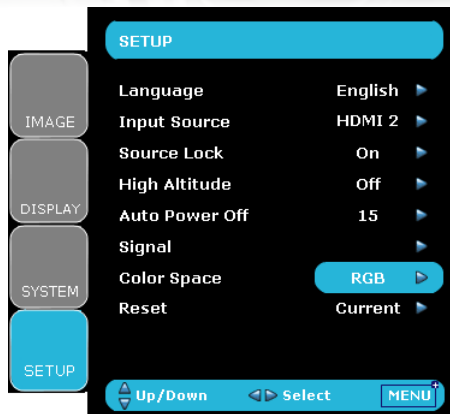

Language

Choose the multilingual OSD menu. Press ◀ or ▶ into the sub menu and then use the ▲ or ▼ key to select your preferred language. Press “Select (Enter)” to finalize the selection.

Input Source

Enable input sources. Press ◀ or ▶ into the next menu as below and then use ▲ or ▼ to select. Press “Select (Enter)” to finalize the selection. The projector will not search inputs that are de-selected.

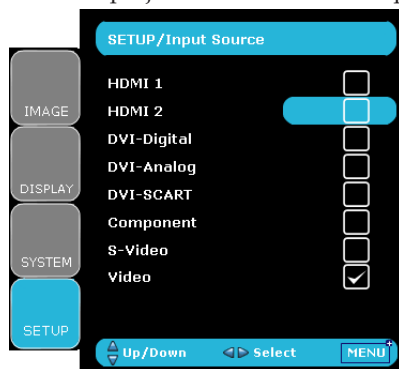

Source Lock

When this function is turned off, the projector will search for other signals if the current input signal is lost. When this function is turned on, it will search for a specified connection port.

User Controls

High Altitude

Choose "On" to turn on High Altitude mode. Operates the fans at full speed continuously to allow for proper high altitude cooling of the projector.

Auto Power Off

Sets the interval of power-off of the system, if there is no signal input. (In minutes)

RGB/HDTV Source

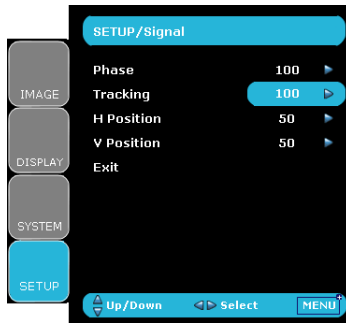

Video Source

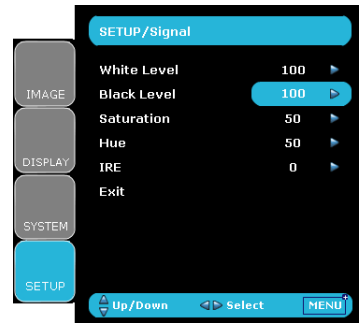

Signal

- ▶ Phase: Changes the display data frequency to match the frequency of your computer's graphic card. When you experience a vertical flickering bar, use this function to make an adjustment.
- ▶ Tracking : Synchronizes the signal timing of the display with the graphics card. If you experience an unstable or flickering image, use this function to correct it.
- ▶ H Position: Adjusts the horizontal position.
- ▶ V Position: Adjusts the vertical position.
- ▶ White Level : Allow user adjust White Level when inputting S-Video or Video/CVBS signals.
- ▶ Black Level : Allow user adjust Black Level when inputting S-Video or Video/CVBS signals.
- ▶ Saturation : Adjusts a video image from black and white to fully saturated color. Press the ◀ to decrease the amount of color in the image. Press the ▶ to increase the amount of color in the image.



"Signal" don't support when source is HDMI or DVI-D.

User Controls



“IRE” only support under NTSC signal.

- ▶ Hue : Adjusts the color balance of red and green. Press the ◀ to increase the amount of green in the image. Press the ▶ to increase the amount of red in the image.
- ▶ IRE : Adjusts measurement of composite video signals.

Color Space

Select an appropriate color matrix type from RGB or YCbCr.

Reset

Return the adjustments and settings to factory default values.

- ▶ Current : Returns the current menu’s settings to factory default.
- ▶ All : Returns the settings for all menus to factory default values.

User Controls

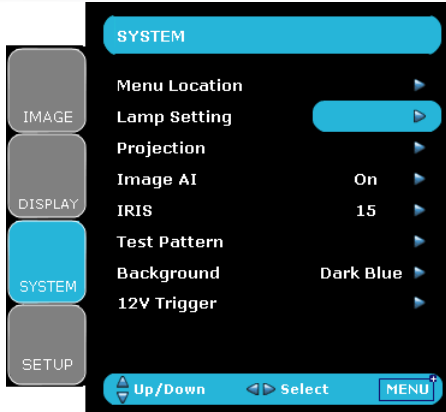

System

Menu Location

Choose the menu location on the display screen.

Projection

- ▶  Front-Desktop

The factory default setting.

- ▶  Rear-Desktop

When you select this function, the projector reverses the image so you can project behind a translucent screen.

- ▶  Front-Ceiling

When you select this function, the projector turns the image upside down for ceiling-mounted projection.

- ▶  Rear-Ceiling

When you select this function, the projector reverses and turns the image upside down at same time. You can project from behind a translucent screen with ceiling mounted projection.

Image AI

Image AI improves the contrast of the picture by optimizing the brightness of the lamp according to the picture content.

- ▶ On: The dynamic image performance manager is active in making sure your greatest pleasure from seeing a movie dynamically

User Controls

with the most dark details revealed, vivid and bright image performed all the way.

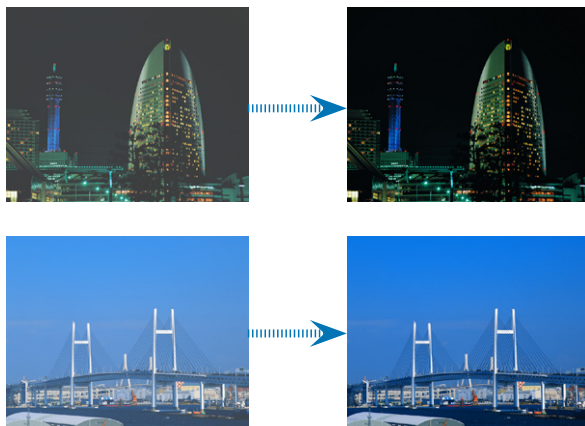

- ▶ Off: The dynamic image performance manager is on standby.

IRIS

The iris function adjusts the contrast optically by opening and closing the lens aperture.

When you press the IRIS button, the current setting appears. When pressing it again while the setting is being displayed, the setting can be changed.

- ▶ 0-16: When 0 is selected, the image becomes brighter. When 1-16 steps is selected, black levels of the image are reproduced with more clarity though the brightness is lowered. There are 16 step for you adjust.
- ▶ Auto: The dynamic image performance manager is active in making sure your greatest pleasure from seeing a movie dynamically with the most dark details revealed, vivid and bright image performed all the way.

Test Pattern

Displays a test pattern. There are Grid, White pattern and None.

Background

Use this feature to display a "Dark Blue", "Black", "Gray" or "Start Logo" screen when no signal is available.

User Controls

12V Trigger

- ▶ STD: When "STD" is selected, 12V Trigger will send 12V when projector turn on.
- ▶ LBX: When 12V trigger set as "LBX" --
 1. Format change to "LBX",12V trigger port will send 12V.
 2. Format is "4:3", "16:9", or "Native", 12V trigger port won't send 12V, it will be 0V.

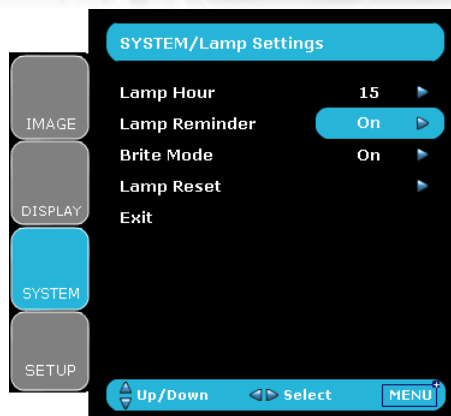

System | Lamp Setting

Lamp Hour

Displays the cumulative lamp operating time.

Lamp Reminder

Choose this function to show or to hide the warning message when the changing lamp message is displayed. The message will appear up 30 hours before suggested replacement of lamp.

Brite Mode

Choose "On" to increase the brightness. Choose "Off" to return normal mode.

Lamp Reset

Reset the lamp life hour after replacing the lamp.

Troubleshooting

If you experience a problem with your projector, please refer to the following information. If a problem persists, please contact your local reseller or service center. (See page 47 for details)

Image Problems

[?] No image appears on-screen

- ▶ Ensure all the cables and power connections are correctly and securely connected as described in the “Installation” section.
- ▶ Ensure the pins of connectors are not crooked or broken.
- ▶ Check if the projection lamp has been securely installed. Please refer to the “Replacing the lamp” section.
- ▶ Make sure you have removed the lens cap and the projector is switched on.

[?] Partial, scrolling or incorrectly displayed image

- ▶ Press “Re-Sync” on the control panel.
- ▶ If you are using a PC:

For Windows 95, 98, 2000, XP:

1. From the “My Computer” icon, open the “Control Panel” folder, and double click the “Display” icon.
2. Select the “Settings” tab.
3. Verify that your display resolution setting is lower than UXGA (1600 x 1200). (*)
4. Click on the “Advanced Properties” button.

If the projector is still not projecting the whole image, you will also need to change the monitor display you are using. Refer to the following steps.

5. Verify the resolution setting is lower than or equal to UXGA (1600 x 1200) resolution. (*)

Note

(*) The resolution: HDMI's 1920 x 1080 i/p and component's 1920 x 1080 i is recommended for this projector.

Note

(*) The resolution: HDMI's 1920 x 1080 i/p and component's 1920 x 1080 i is recommended for this projector.

6. Select the "Change" button under the "Monitor" tab.
7. Click on "Show all devices." Next, select "Standard monitor types" under the SP box; choose the resolution mode you need under the "Models" box.
8. Verify that the resolution setting of the monitor display is lower than or equal to UXGA (1600 x 1200). (*)

► If you are using a Notebook:

1. First, follow the steps above to adjust resolution of the computer.
2. Press the toggle output settings. Example: [Fn]+[F4]

Compaq=>	[Fn]+[F4]	Hewlett	=>	[Fn]+[F4]
Dell =>	[Fn]+[F8]	Packard	=>	[Fn]+[F4]
Gateway=>	[Fn]+[F4]	NEC=>	[Fn]+[F3]	
IBM=>	[Fn]+[F7]	Toshiba =>	[Fn]+[F5]	

Mac Apple:

System Preference-->Display-->Arrangement-->Mirror display

► If you experience difficulty changing resolutions or your monitor freezes, restart all equipment including the projector.

? The screen of the Notebook or PowerBook computer is not displaying your presentation

► If you are using a Notebook PC:

Some Notebook PCs may deactivate their own screens when a second display device is in use. Each has a different way to be reactivated. Refer to your computer's manual for detailed information.

? Unstable or flickering image

- Use "Tracking" to correct it. See page 30 for more information.
- Change the monitor color setting on your computer.

? Image has vertical flickering bar

- Use "Phase" to make an adjustment. See page 30 for more information.
- Check and reconfigure the display mode of your graphic card to make it compatible with the projector.

? Image is out of focus

- ▶ Make sure the Lens cap is removed.
- ▶ Adjusts the Focus Ring on the projector lens.
- ▶ Make sure the projection screen is between the required distance 4.9 to 39.4 feet (1.5 to 12.0 meters) from the projector. See page 16.

? The image is stretched when displaying 16:9 DVD title

When you play anamorphic DVD or 16:9 DVD, the projector will show the best image in 16: 9 format on projector side.

If you play the LBX format DVD title, please change the format as LBX in projector OSD.

If you play 4:3 format DVD title, please change the format as 4:3 in projector OSD.

If the image is still stretched, you will also need to adjust the aspect ratio by referring to the following:

- ▶ Please setup the display format as 16:9 (wide) aspect ratio type on your DVD player.

? Image is too small or too large

- ▶ Adjust the zoom lever on the top of the projector.
- ▶ Move the projector closer to or further from the screen.
- ▶ Press [**4:3** 4:3], [**16:9** 16:9], [**L** Letter-Box], [**N** Native] button on the remote control or [Menu] on the projector panel, go to "Display-->Format". Try the different settings.

? Image has slanted sides:

- ▶ If possible, reposition the projector so that it is centered on the screen and below the bottom of the screen.
- ▶ Use "Display-->V.Keystone" from the OSD to make an adjustment.

? Image is reversed

- ▶ Select "System-->Projection" from the OSD and adjust the projection direction.

Intermission Problems

? The projector stops responding to all controls

- ▶ If possible, turn off the projector, then unplug the power cord and wait at least 20 seconds before reconnecting power.

? Lamp burns out or makes a popping sound

- ▶ When the lamp reaches its end of life, it will burn out and may make a loud popping sound. If this happens, the projector will not turn on until the lamp module has been replaced. To replace the lamp, follow the procedures in the “Replacing the Lamp” section on page 41.

Projector Status Indication

? LED states

Message	Power LED (Red)	Power LED (Blue)	Temp-LED	Lamp-LED
Standby State (Input power cord)	☀	○	○	○
Power on (Warming)	○	Flashing	○	○
Power on and Lamp lighting	○	☀	○	○
Power off (Cooling)	○	Flashing	○	○
Error (Lamp fail)	○	○	○	☀
Error (Thermal fail)	○	○	☀	○
Error (Fan fail)	○	○	○	Flashing
Error (Over Temp.)	○	○	Flashing	○

Note

Steady light => ☀
No light => ○

? Message Reminders

- ▶ Fan failed:

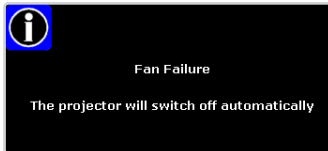

- ▶ Over temperature:



Projector Overheated

The projector will switch off automatically

- ▶ Replacing the lamp:



Lamp is approaching the end of its useful life

Replacement suggested!

Remote Control Problems

? If the remote control does not work

- ▶ Check the operating angle for the remote control is approximately $\pm 22.5^\circ$.
- ▶ Make sure there are not any obstructions between the remote control and the projector. Move to within 6 m (20 ft) of the projector.
- ▶ Make sure batteries are inserted correctly.
- ▶ Make sure batteries are exhausted. If so, replace weak batteries in the remote control.

Replacing the lamp

The projector automatically detects the lamp life. When the lamp life is nearing the end of use, you will receive a warning message.



Warning: Lamp compartment is hot! Allow it to cool down before changing lamp!

When you see this message, please contact your local reseller or service center to change the lamp as soon as possible. Make sure the projector has been cooled down for at least 30 minutes before changing the lamp.

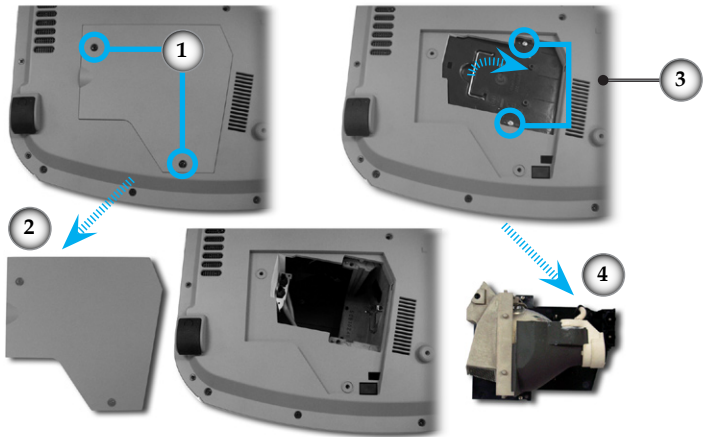

Warning: To reduce the risk of personal injury, do not drop the lamp module or touch the lamp bulb. The bulb may shatter and cause injury if it is dropped.

Lamp Replacing Procedure:

1. Switch off the power to the projector by pressing the Power button.
2. Allow the projector to cool down at least 30 minutes.
3. Disconnect the power cord.
4. Use a screwdriver to remove the screw from the cover. ❶
5. Push up and remove the cover. ❷
6. Remove the 2 screws from the lamp module. ❸
7. Pull out the lamp module. ❹

To replace the lamp module, reverse the previous steps.

8. Turn on the projector and do "Lamp Reset" after the lamp module is replaced.

Lamp Reset: (i) Press "Menu" -> (ii) Select "System" -> (iii) Select "Lamp setting" -> (iv) Select "Lamp reset" -> (v) Select "Yes".

Compatibility Modes

Mode	Resolution	V.Frequency (Hz)	Analog	Digital
VESA SVGA	800 x 600	60	✗	✓
VESA SVGA	800 x 600	72	✗	✓
VESA SVGA	800 x 600	75	✗	✓
VESA XGA	1024 x 768	60	✓	✓
VESA XGA	1024 x 768	70	✗	✓
VESA XGA	1024 x 768	75	✗	✓
VESA XGA	1024 x 768	85	✓	✗
VESA WXGA	1280 x 720	60	✗	✓
VESA WXGA	1280 x 768	60	✓	✗
VESA WXGA	1280 x 768	72	✓	✗
VESA WXGA	1280 x 768	85	✓	✗
HD	1280 x 720	60	✓	✗
HD	1280 x 720	72	✓	✗
VESA SXGA+	1400 x 1200	60	✓	✓
VESA UXGA	1600 x 1200	60	✓	✓
* HD	1920 x 1080	24	✗	✓
* HD	1920 x 1080	60	✗	✓
* MAC	1152 x 870	75.06	✓	✗
MAC G4	640 x 480	60	✓	✗
MAC G4	1024 x 768	75	✓	✗



Remark : “*” compressed computer image.

RS232 Commands and Protocol Function List

RS232 Pin Assignments

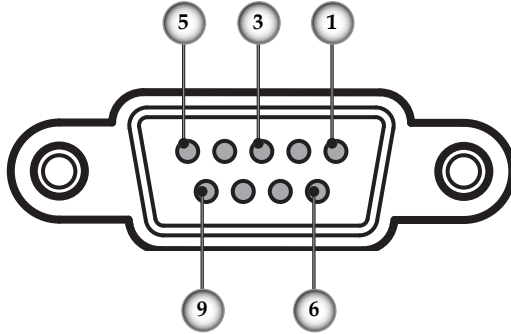

Pin no.	Name	I/O (From Projector Side)
1	NC	—
2	RXD	IN
3	TXD	OUT
4	NC	—
5	GND	—
6	NC	—
7	NC	—
8	NC	—
9	NC	—

Appendices

RS232 Protocol Function List

Interface: 9 wires RS-232C
Baud Rate: 115200

Data Bit: 8
Parity: none
Stop Bits: 1

Flow Control: none

Default ACK:
 ""000<CR>": Received OK
 ""001<CR>": Invalid Command

Terminator:
 <LF> = 0Ah = "\r"
 <CR> = 0Dh = "\n"

Viewed As	Command	Function Description	ACK	Hex
OKOKOKOKOK	OKOKOKOKOK <CR> <LF>	Power On	Default ACK	4F4B4F4B4F4B4F4B0D

Viewed As	Command	Function Description	ACK	Hex
* 0 IR 002	* 0 IR 002 <CR>	Power Off	Default ACK	2A 20 30 20 49 52 20 30 30 32 0D
* 0 IR 008	* 0 IR 008 <CR>	Menu	Default ACK	2A 20 30 20 49 52 20 30 30 38 0D
* 0 IR 009	* 0 IR 009 <CR>	Up	Default ACK	2A 20 30 20 49 52 20 30 30 39 0D
* 0 IR 010	* 0 IR 010 <CR>	Down	Default ACK	2A 20 30 20 49 52 20 30 31 30 0D
* 0 IR 011	* 0 IR 011 <CR>	Right	Default ACK	2A 20 30 20 49 52 20 30 31 31 0D
* 0 IR 012	* 0 IR 012 <CR>	Left	Default ACK	2A 20 30 20 49 52 20 30 31 32 0D
* 0 IR 013	* 0 IR 013 <CR>	Enter	Default ACK	2A 20 30 20 49 52 20 30 31 33 0D
* 0 IR 014	* 0 IR 014 <CR>	Source	Default ACK	2A 20 30 20 49 52 20 30 31 34 0D
* 0 IR 015	* 0 IR 015 <CR>	Re-sync	Default ACK	2A 20 30 20 49 52 20 30 31 35 0D
* 0 IR 016	* 0 IR 016 <CR>	Source: DVI_Digital	Default ACK	2A 20 30 20 49 52 20 30 31 36 0D
* 0 IR 017	* 0 IR 017 <CR>	Source: HDMI 1	Default ACK	2A 20 30 20 49 52 20 30 31 37 0D
* 0 IR 018	* 0 IR 018 <CR>	Source: Composite Video	Default ACK	2A 20 30 20 49 52 20 30 31 38 0D
* 0 IR 019	* 0 IR 019 <CR>	Source: S-Video	Default ACK	2A 20 30 20 49 52 20 30 31 39 0D
* 0 IR 020	* 0 IR 020 <CR>	Source : DVI_Analog	Default ACK	2A 20 30 20 49 52 20 30 32 0D
* 0 IR 021	* 0 IR 021 <CR>	Source: Component	Default ACK	2A 20 30 20 49 52 20 30 32 31 0D
* 0 IR 025	* 0 IR 025 <CR>	Aspect Ratio 16:9	Default ACK	2A 20 30 20 49 52 20 30 32 35 0D
* 0 IR 026	* 0 IR 026 <CR>	Aspect Ratio 4:3	Default ACK	2A 20 30 20 49 52 20 30 32 36 0D
* 0 IR 027	* 0 IR 027 <CR>	Aspect ratio LetterBox	Default ACK	2A 20 30 20 49 52 20 30 32 37 0D
* 0 IR 028	* 0 IR 028 <CR>	Aspect ratio 1:1	Default ACK	2A 20 30 20 49 52 20 30 32 38 0D
* 0 IR 030	* 0 IR 030 <CR>	Source Lock On	Default ACK	2A 20 30 20 49 52 20 30 33 30 0D
* 0 IR 031	* 0 IR 031 <CR>	Source Lock Off	Default ACK	2A 20 30 20 49 52 20 30 33 31 0D
* 0 IR 032	* 0 IR 032 <CR>	IRIS	Default ACK	2A 20 30 20 49 52 20 30 33 32 0D
* 0 IR 033	* 0 IR 033 <CR>	SupperWide	Default ACK	2A 20 30 20 49 52 20 30 33 33 0D

Appendices

Viewed As	HEA D B	ADR B	COM H B	COM	TER M 1	TER M 2	Function Description	ACK	Hex
* 0 IR 035	*	0	IR	035	<CR>	--s	Brightness	Default ACK	2A 20 30 20 49 52 20 30 33 35 0D
* 0 IR 036	*	0	IR	036	<CR>	--s	Contrast	Default ACK	2A 20 30 20 49 52 20 30 33 36 0D
* 0 IR 037	*	0	IR	037	<CR>	--s	Tint	Default ACK	2A 20 30 20 49 52 20 30 33 37 0D
* 0 IR 038	*	0	IR	038	<CR>	--s	Color	Default ACK	2A 20 30 20 49 52 20 30 33 38 0D
* 0 IR 039	*	0	IR	039	<CR>	--s	Image shift up	Default ACK	2A 20 30 20 49 52 20 30 33 39 0D
* 0 IR 040	*	0	IR	040	<CR>	--s	Image shift down	Default ACK	2A 20 30 20 49 52 20 30 34 30 0D
* 0 IR 041	*	0	IR	041	<CR>	--s	mode	Default ACK	2A 20 30 20 49 52 20 30 34 31 0D
* 0 IR 042	*	0	IR	042	<CR>	--s	edge mask(overscan)	Default ACK	2A 20 30 20 49 52 20 30 34 32 0D
* 0 IR 043	*	0	IR	043	<CR>	--s	overscan(zoom)	Default ACK	2A 20 30 20 49 52 20 30 34 33 0D
* 0 IR 046	*	0	IR	046	<CR>	O s	Keystone shift up	Default ACK	2A 20 30 20 49 52 20 30 34 36 0D
* 0 IR 047	*	0	IR	047	<CR>	O s	keystone shift down	Default ACK	2A 20 30 20 49 52 20 30 34 37 0D
* 0 IR 048	*	0	IR	048	<CR>	O s	Image shift left	Default ACK	2A 20 30 20 49 52 20 30 34 38 0D
* 0 IR 049	*	0	IR	049	<CR>	O s	Image shift right	Default ACK	2A 20 30 20 49 52 20 30 34 39 0D
* 0 IR 050	*	0	IR	050	<CR>	--s	Source: HDMI 2	Default ACK	2A 20 30 20 49 52 20 30 35 30 0D

Viewed As	HEA D B	ADR B	COM H B	COM	TER M 1	Function Description	Return	Note	Hex
* 0 IR 801	*	0	IR	801	<CR>	--g	Get Lamp Hour	*002 xxxxx 0 <-> 99999 xx means 00 : no source 01 : DVI_Digital 02 : HDMI 1 03 : Composite Video 04 : S-Video 05 : DVI Analog 06 : Component Video 07 : HDMI 2 08 : Testing	2A 20 30 20 49 52 20 38 30 31 0D
* 0 IR 802	*	0	IR	802	<CR>	--g	Get Video Source	*003 xx	2A 20 30 20 49 52 20 38 30 32 0D
* 0 IR 803	*	0	IR	803	<CR>	--g	Get Lamp Status	*004 xx xx means 00 : Brite Mode Off 01 : Brite Mode	2A 20 30 20 49 52 20 38 30 33 0D
* 0 IR 804	*	0	IR	804	<CR>	--g	Get Projector status	*005 xx xx means projector is in 00 : Standby mode 01 : Power On 03 : Cooling on or cooling off 04 : Lamp error 05 : Thermal error	2A 20 30 20 49 52 20 38 30 34 0D

Ceiling Mount Installation

1. To prevent damaging your projector, please use the ceiling mount package for installation.
2. If you wish to use a third party ceiling mount kit, please ensure the screws used to attached a mount to the projector met the following specifications:

- ▶ **Screw type: M4**
- ▶ **Maximum screw length: 10mm**
- ▶ **Minimum screw length: 8mm**



Please note that damage resulting from incorrect installation will invalidate the warranty.



Warning:

1. If you buy the ceiling mount from other company, please ensure that there is at least 10cm distance between the bottom cover of the projector and the ceiling.
2. Avoid placing the projector near sources of heat such air-conditioning units and heaters otherwise it may overheat and shut down automatically.
3. Ceiling mounting shall be mounting on metal or concrete.

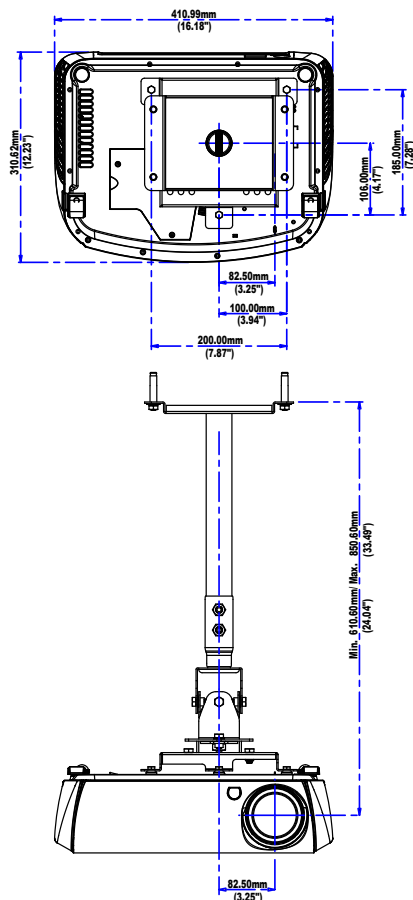

Optoma Global Offices

For service or support please contact your local office.

USA

715 Sycamore Drive
Milpitas, CA 95035, USA
www.optomausa.com

Tel : 408-383-3700
Fax: 408-383-3702
Service : services@optoma.com

Canada

5630 Kennedy Road, Mississauga,
ON, L4Z 2A9, Canada
www.optoma.ca

Tel : 905-361-2582
Fax: 905-361-2581

Europe

42 Caxton Way, The Watford Business Park
Watford, Hertfordshire,
WD18 8QZ, UK
www.optoma.eu

Service Tel : +44 (0)1923 691865

Tel : +44 (0) 1923 691 800
Fax: +44 (0) 1923 691 888
Service : service@tsc-europe.com

France

Bâtiment E
81-83 avenue Edouard Vaillant
92100 Boulogne Billancourt, France

Tel : +33 1 41 46 12 20
Fax: +33 1 41 46 94 35
Service : savoptoma@optoma.fr

Spain

Paseo de la Castellana
135 7 Planta
Madrid, Spain

Tel : +34 91 790 67 01
+34 91 790 67 02
Fax: + 34 91 790 68 69

Deutschland

Werftstrasse 25
D40549 Düsseldorf,
Germany

Tel : +49 (0) 211 506 6670
Fax: +49 (0) 211 506 66799
Service : info@optoma.de

Scandinavia

Grev Wedels Plass 2
3015 Drammen
Norway

Tel : +47 32 26 89 90
Fax: +47 32 83 78 98
Service : info@optoma.de

Latin America

715 Sycamore Drive
Milpitas, CA 95035, USA
www.optoma.com.br

Tel : 408-383-3700
Fax: 408-383-3702
www.optoma.com.mx

Appendices

Taiwan

231,台北縣新店市民權路108號5樓

R.O.C.

電話：+886-2-2218-2360

服務處：services@optoma.com.tw

傳真：+886-2-2218-2313

www.optoma.com.tw

asia.optoma.com

Hong Kong

Unit A, 27/F Dragon Centre, 79 Wing Hong Street,

Cheung Sha Wan Kowloon, Hong Kong

Tel : +852-2396-8968

www.optoma.com.hk

Fax: +852-2370-1222

China

上海市長宁区凱旋路1205号5樓

邮编：200052

www.optoma.com.cn

电话：+86-21-62947376

传真：+86-21-62947375

Japan

東京都足立区綾瀬 3-25-18

オーエス本社ビル

E-Mail: info@osscreen.com

サポートセンター:0120-46-5040

<http://www.os-worldwide.com/>

Korea

WOOMI TECH.CO.,LTD.

4F, Minu Bldg.33-14, Nonhyun-Dong,

Kangnam-Ku, seoul, 135-815, KOREA

Tel : +82+2+34430004

Fax: +82+2+34430005

Regulation & safety notices

This appendix lists the general notices of your Projector.

FCC notice

This device has been tested and found to comply with the limits for a Class B digital device pursuant to Part 15 of the FCC rules. These limits are designed to provide reasonable protection against harmful interference in a residential installation. This device generates, uses, and can radiate radio frequency energy and, if not installed and used in accordance with the instructions, may cause harmful interference to radio communications.

However, there is no guarantee that interference will not occur in a particular installation. If this device does cause harmful interference to radio or television reception, which can be determined by turning the device off and on, the user is encouraged to try to correct the interference by one or more of the following measures:

- Reorient or relocate the receiving antenna.
- Increase the separation between the device and receiver.
- Connect the device into an outlet on a circuit different from that to which the receiver is connected.
- Consult the dealer or an experienced radio/television technician for help.

Notice: Shielded cables

All connections to other computing devices must be made using shielded cables to maintain compliance with FCC regulations.

Caution

Changes or modifications not expressly approved by the manufacturer could void the user's authority, which is granted by the Federal Communications Commission, to operate this device.

Appendices

Operation conditions

This device complies with Part 15 of the FCC Rules. Operation is subject to the following two conditions:

- 1.this device may not cause harmful interference, and
- 2.this device must accept any interference received, including interference that may cause undesired operation.

Notice: Canadian users

This Class B digital apparatus complies with Canadian ICES-003.

Remarque à l'intention des utilisateurs canadiens

Cet appareil numérique de la classe B est conforme a la norme NMB-003 du Canada.

Declaration of Conformity for EU countries

- EMC Directive 2004/108/EC (including amendments)
- Low Voltage Directive 2006/95/EC
- R & TTE Directive 1999/5/EC (if product has RF function)

Disposal instructions



Do not throw this electronic device into the trash when discarding. To minimize pollution and ensure utmost protection of the global environment, please recycle it.