

***myprojectorlamps.com***

**The most trusted, dependable name  
in projector lamp sales.**



<http://www.myprojectorlamps.com>



<http://www.myprojectorlamps.ca>



<http://www.myprojectorlamps.eu>

The following projector manual has not been modified or altered in any way.



# Table of Contents



<b>Table of Contents</b> .....	<b>1</b>
<b>Usage Notice</b> .....	<b>2</b>
<i>Safety Information</i> .....	2
<i>Precautions</i> .....	3
<i>Eye Safety Warnings</i> .....	5
<b>Introduction</b> .....	<b>6</b>
<i>Product Features</i> .....	6
<i>Package Overview</i> .....	7
<i>Product Overview</i> .....	8
<i>Main Unit</i> .....	8
<i>Control Panel</i> .....	9
<i>Connection Ports</i> .....	10
<i>Remote Control</i> .....	11
<b>Installation</b> .....	<b>12</b>
<i>Connecting the Projector</i> .....	12
<i>Powering On/Off the Projector</i> .....	13
<i>Powering On the Projector</i> .....	13
<i>Powering Off the projector</i> .....	14
<i>Warning Indicator</i> .....	14
<i>Adjusting the Projected Image</i> .....	15
<i>Adjusting the Projector's Height</i> .....	15
<i>Adjusting the Projector's Zoom / Focus</i> .....	16
<i>Adjusting Projected Image Size</i> .....	16
<b>User Controls</b> .....	<b>17</b>
<i>Control Panel &amp; Remote Control</i> .....	17
<i>On-screen Display Menus</i> .....	20
<i>How to operate</i> .....	20
<i>Menu Tree</i> .....	21
<i>Image</i> .....	22
<i>Display</i> .....	28
<i>Setup</i> .....	31
<i>Options</i> .....	33
<b>Appendices</b> .....	<b>35</b>
<i>Troubleshooting</i> .....	35
<i>Image Problems</i> .....	35
<i>Intermission Problems</i> .....	38
<i>LED Problems</i> .....	38
<i>Remote Control Problems</i> .....	39
<i>Replacing the Lamp</i> .....	40
<i>Compatibility Modes</i> .....	41
<i>Ceiling Mount Installation</i> .....	42
<i>Optoma Global Office</i> .....	43



## Safety Information

	The lightning flash with arrowhead within an equilateral triangle is intended to alert the user to the presence of uninsulated "dangerous voltage" within the product's enclosure that may be of sufficient magnitude to constitute a risk of electric shock to persons.
	The exclamation point within an equilateral triangle is intended to alert the user to the presence of important operating and maintenance (servicing) instructions in the literature accompanying the appliance.

**WARNING: TO REDUCE THE RISK OF FIRE OR ELECTRIC SHOCK, DO NOT EXPOSE THIS APPLIANCE TO RAIN OR MOISTURE. DANGEROUS HIGH VOLTAGES ARE PRESENT INSIDE THE ENCLOSURE. DO NOT OPEN THE CABINET. REFER SERVICING TO QUALIFIED PERSONNEL ONLY.**

### Class B emissions limits

This Class B digital apparatus meets all requirements of the Canadian Interference-Causing Equipment Regulations.

### Important Safety Instruction

1. Read these instructions –before using this projector.
2. Keep these instructions –for future reference.
3. Follow all instructions.
4. Install in accordance with the manufacturer's instructions :
  - A. Do not block any ventilation openings.** To ensure reliable operation of the projector and to protect it from overheating, put the projector in a position and location that will not interfere with its proper ventilation. For example, do not place the projector on a bed, sofa, carpet, or similar surface that may block the ventilation openings. Do not put it in an enclosure, such as a bookcase or a cabinet that may keep air from flowing through its ventilation openings.
  - B. Do not use this projector near water or moisture.** To reduce the risk of fire or electric shock, do not expose the projector to rain or moisture.
  - C. Do not install near any heat sources,** such as radiators, heaters, stoves or other apparatus (including amplifiers) that produce heat.
5. Clean only with a dry cloth.
6. Only use attachments/accessories specified by the manufacturer.
7. Refer all servicing to qualified service personnel. Servicing is required when the projector has been damaged in any way:
  - Such as power supply cord or plug is damaged.
  - Liquid has been spilled or objects have fallen into the apparatus.
  - The projector has been exposed to rain or moisture, does not operate normally, or has been dropped.

Do not attempt to service this projector yourself. Opening or removing covers may expose you to dangerous voltages or other hazards. Please call Optoma to be referred to an authorized service center near you.
8. Do not let objects or liquids enter the projector –as they may touch dangerous voltage points or short-out parts that could result in a fire or electric shock.
9. See projector enclosure for safety related markings.
10. The projector should not be adjusted or repaired by anyone except properly qualified service personnel.



## Precautions



*Please follow all warnings, precautions and maintenance as recommended in this user's guide.*

- Warning- Do not look into the projector's lens when the lamp is on. The bright light may hurt your eyes.
- Warning- To reduce the risk of fire or electric shock, do not expose this projector to rain or moisture.
- Warning- Please do not open or disassemble the projector as this may cause electric shock.
- Warning- When replacing the lamp, please allow unit to cool down, and follow all replacement instructions. See page 40.
- Warning- This projector will detect the life of the lamp itself. Please be sure to change the lamp when it shows warning messages.
- Warning- Reset the "Lamp Reset" function from the on-screen display "Options|Lamp Settings" menu after replacing the lamp module (refer to page 34).
- Warning- When switching the projector off, please ensure the cooling cycle has been completed before disconnecting power. Allow 90 seconds for the projector to cool down.
- Warning- Do not use lens cap when projector is in operation.
- Warning- When the lamp is approaching to the end of its life time, the message "Replacement suggested" will show on the screen. Please contact your local reseller or service center to change the lamp as soon as possible.



❖ When the lamp reaches the end of its life, the projector will not turn back on until the lamp module has been replaced. To replace the lamp, follow the procedures listed under "Replacing the Lamp" section on page 40.



# Usage Notice

## ***Do:***

- ❖ Turn off the product before cleaning.
- ❖ Use a soft cloth moistened with mild detergent to clean the display housing.
- ❖ Disconnect the power plug from AC outlet if the product is not being used for a long period of time.

## ***Don't:***

- ❖ Block the ventilation slots and openings on the unit.
- ❖ Use abrasive cleaners, waxes or solvents to clean the unit.
- ❖ Use under the following conditions:
  - In extremely hot, cold or humid environments.
  - In areas susceptible to excessive dust and dirt.
  - Near any appliance that generates a strong magnetic field.
  - In direct sunlight.



## Eye Safety Warnings



- Avoid staring directly into the projector beam at all times.
- Minimize standing facing into the beam. Keep your back to the beam as much as possible.
- A stick or laser pointer is recommended to avoid the need for the user to enter the beam.
- Ensure that projectors are located out of the line of sight from the screen to the audience; this ensures that, when presenters look at the audience, they do not also have to stare at the projector lamp. The best way to achieve this is by ceiling-mounting rather than floor or table-mounting the projector.
- When projector is used in a classroom, adequately supervise students when they are asked to point out something on the screen.
- In order to minimize the lamp power needed, use room blinds to reduce ambient light levels.



## Product Features

*This product is an 720P single chip DLP® projector. Outstanding features include:*

- **Single 16:9 1280 x 720 Dark Chip2™ DLP® technology**
- **Uses 7 segment color wheel GRBWGRB cycle**
- **480i - NTSC/NTSC4.43**
- **576i - PAL/PAL-M/PAL-N/SECAM**
- **HDTV compatible (480p, 576p, 720p, 1080i)**
- **Full function IR remote control with back light**
- **Advanced 2D digital keystone correction and high quality full screen image re-scaling**
- **User friendly control panel**
- **SXGA+, SXGA compression and XGA, SVGA, VGA re-sizing**
- **Macintosh compatible**
- **HDMI support with HDCP compliant**
- **True Vivid and Brilliant Color™ Image technology**
- **16:9, integrate with complete image function: Format, Overscan, Digital Image Shift construction (Vertical/Horizontal)**



## Package Overview

*This projector comes with all the items shown below. Check to make sure your unit is complete. Contact your dealer immediately if anything is missing.*



Projector with lens cap



Power Cord 1.8m



Composite Video Cable  
1.8m



❖ Due to the difference in applications for each country, some regions may have different accessories.



S-Video Cable 1.8m



IR Remote Controller



2 x AAA Batteries



RCA Component Cable  
for YPbPr 1.8m

### Documentation :

- User's Manual
- Warranty Card
- Quick Start Card

### Available in European version only



SCART RGB/S-Video  
Adaptor



VGA Cable 1.8m



## Product Overview

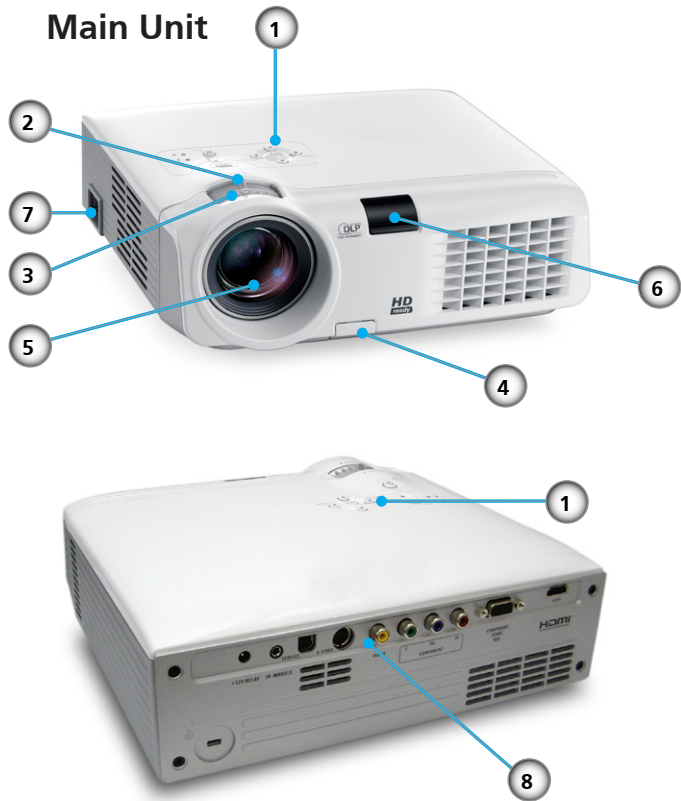

1. Control Panel
2. Zoom Lever
3. Focus Ring
4. Elevator Button
5. Zoom Lens
6. IR Receivers
7. Power Socket
8. Connection Ports



## Control Panel

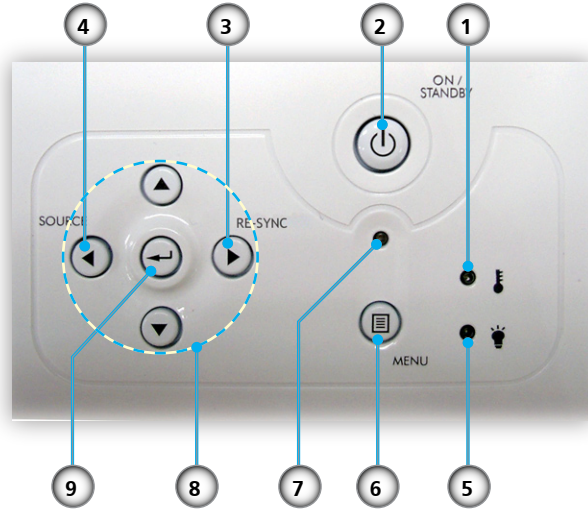

1. Temp Indicator LED
2. On/Standby
3. Re-Sync
4. Source
5. Lamp Indicator LED
6. Menu (On/Off)
7. On/Standby LED
8. Four Directional Select Keys
9. Enter

## Connection Ports

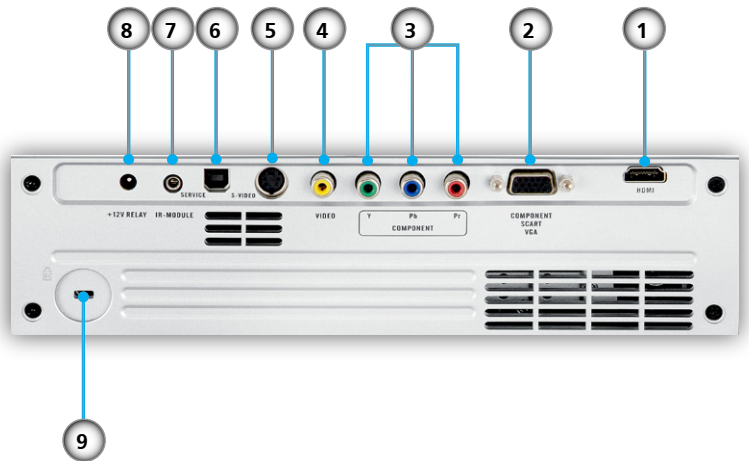

1. HDMI Connector
2. Component/SCART/VGA Input Connector
3. Component Video Input Connector
4. Composite Video Input Connector
5. S-Video Input Connector
6. Service Connector
7. IR Module
8. +12V Relay Connector
9. Kensington Microsaver™ Lock Port



## Remote Control

1. Power On/Off
2. Mode
3. 16:9
4. Native
5. Contrast
6. Menu Format
7. Enter
8. Four Directional Select Keys
9. Re-Sync
10. D-Sub Source
11. Video Source
12. YPbPr Source
13. HDMI Source
14. Source
15. Overscan
16. Brightness
17. LBX
18. 4:3
19. V Keystone
20. H Keystone
21. S-Video Source
22. Source Lock

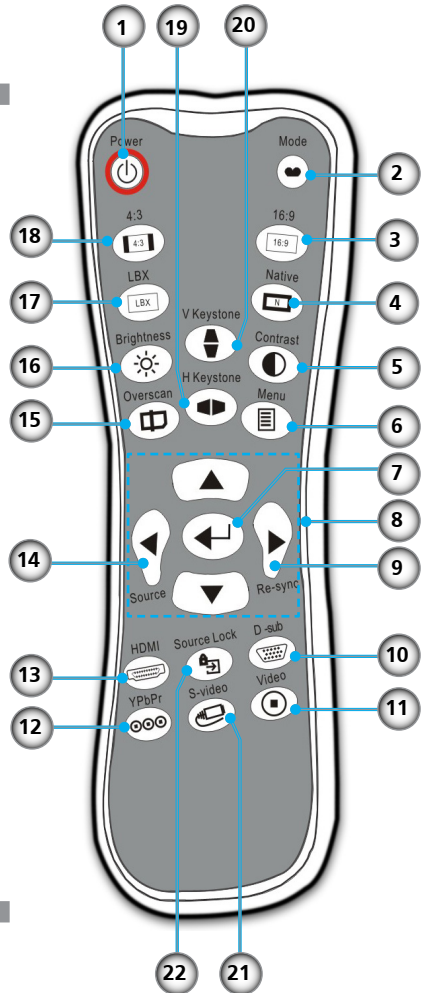



## Connecting the Projector

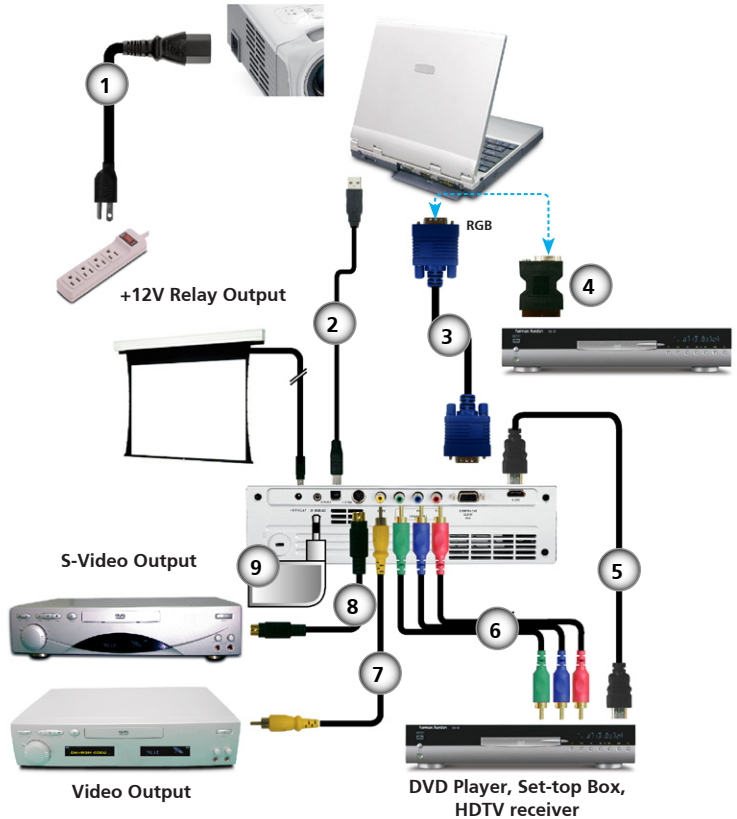

❖ Due to the difference in applications for each country, some regions may have different accessories.

- |        |                                 |
|--------|---------------------------------|
| 1..... | Power Cord                      |
| 2..... | USB Cable (Optional Accessory)  |
| 3..... | VGA Cable                       |
| 4..... | SCART RGB/S-Video Adaptor       |
| 5..... | HDMI Cable (Optional Accessory) |
| 6..... | RCA Component Cable for YPbPr   |
| 7..... | Composite Video Cable           |
| 8..... | S-Video Cable                   |
| 9..... | IR Module                       |



## Powering On/Off the Projector

### Powering On the Projector

1. Remove the lens cap. ❶
2. Ensure that the power cord and signal cable are securely connected. ❷ The Power LED will flash green.
3. Turn on the lamp by pressing “On/Standby” button either on the top of the projector or on the remote. The Power LED will turn green.

The startup screen will display in approximately 30 seconds. The first time you use the projector, you can select your preferred language from quick menu after the startup screen display.

4. Turn on your source (computer, notebook, video player, etc.). The projector will detect your source automatically.
- ❖ If you connected multiple sources at the same time, press the “Source” button on the control panel or direct source key on the remote control to switch between inputs.



❖ Turn on the projector first and then select the signal sources.



## Powering Off the Projector

1. Press the “On/Standby” button to turn off the projector lamp, you will see a message displayed on the projector’s screen.

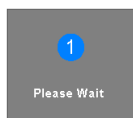
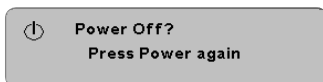

2. Press the “On/Standby” button again to confirm, otherwise the message will disappear after 5 seconds.

When you press “On/Standby” button second, the system will show the timing countdown on the screen.

3. The cooling fans continue to operate for about 10 seconds for cooling cycle and the Power LED will turn green. When the Power LED begins flashing, the projector has entered standby mode.

If you wish to turn the projector back on, you must wait until the projector has completed the cooling cycle and has entered standby mode. Once in standby mode, simply press “On/Standby” button to restart the projector.

4. Disconnect the power cord from the electrical outlet and the projector.
5. Do not turn on the projector immediately following a power off procedure.

## Warning Indicator

- ❖ When the “LAMP” indicator lights solid orange, the projector will automatically shut itself down. Please contact your local reseller or service center. See page 43.
- ❖ When the “TEMP” indicator lights solid red, it indicates the projector has overheated. The projector will automatically shut itself down. Under normal conditions, the projector can be switched on again after it has cooled down. If the problem persists, you should contact your local dealer or our service center. See page 43.
- ❖ When the “TEMP” indicator flashes red, it indicates the fan has failed. Please contact your local dealer or our service center. See page 43.



## Adjusting the Projected Image

### Adjusting the Projector's Height

*The projector is equipped with elevator feet for adjusting the image height.*

To raise the image:

1. Press the elevator button ❶.
2. Raise the image to the desired height angle ❷, then release the button to lock the elevator feet into position.
3. Use screw in feet ❸ to fine-tune the display angle.

To lower the image:

1. Press the elevator button.
2. Lower the image, then release the button to lock the elevator feet into position.
3. Use screw in feet ❸ to fine-tune the display angle.







## Adjusting the Projector's Zoom / Focus

Turn the Zoom Lever to zoom in or zoom out. To focus the image, turn the focus ring until you see a clear image. The projector will focus at distances from 4.9 to 39.4 feet (1.5 to 10.0 meters) and the projection screen size from 0.92m~8.857m (36"~349") at 16:9 mode with mechanical travel.



Zoom Lever  
Focus Ring

## Adjusting Projection Image Size

Side View

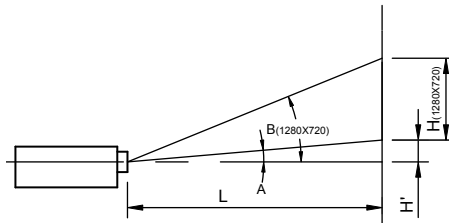

Front View

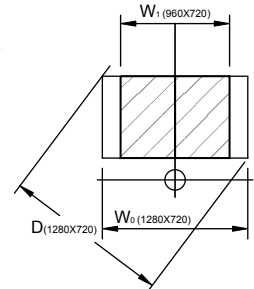

Throw Ratio (TR)=1.96 as Wide mode

$A=8.13^\circ$

$B$   
(1280x720)= $26.50^\circ$   $W_0$  (1280x720)= $L/R$

$H'=L \times \tan(A)$

$W_1$  (960x720)= $W_0$  (1280x720)  $\times$  0.75

$H$  (1280x720)= $W_0$  (1280x720)  $\times$  0.56

$H$  (960x720)= $W_1$  (960x720)  $\times$  0.75

Display Format	A	B	L (cm)	W (cm)	H (cm)	H' (cm)	D (cm)	D' (in)
16:9 (1280x720)	8.13	26.50	210	132.83	74.72	30.00	152.4	60.00
4:3 (960x720)	8.13	26.50	210	99.62	74.72	30.00	124.53	49.03
Projection Distance (M)	2.0	3.0	5.0	6.0	7.0	8.0	9.0	
Screen Size 16:9 (inch)	Max	57.18	85.77	142.95	171.54	200.12	228.71	257.30
	Min	47.55	71.32	118.87	142.65	166.42	190.19	213.97
Screen Size 4:3 (inch)	Max	46.72	70.08	116.80	140.16	163.52	186.88	210.24
	Min	38.85	58.28	97.13	116.56	135.98	155.41	174.83



## Control Panel & Remote Control

*There are two ways for you to control the functions: Control Panel and Remote Control.*

### Control Panel



---

#### Using the Control Panel

---

<b>On/Standby</b>	Refer to the "Power On/Off the Projector" section on pages 13-14.
<b>Menu</b>	Press "Menu" to launch the on-screen display (OSD) menu. To exit OSD, Press "Menu" again.
<b>Re-Sync</b>	Automatically synchronizes the projector to the input source.
<b>Source</b>	Press "Source" to select an input signal.
<b>Four Directional Select Keys</b>	Use ▲ ▼ ◀ ▶ to select items or make adjustments to your selection.
<b>Enter</b>	Confirm your item selection.

---

## Remote Control



### Using the Remote Control

<b>Power</b>	Refer to the "Power On/Off the Projector" section on pages 13-14.
<b>Mode</b>	Select the display mode from Cinema, Bright, TV, sRGB and User.
<b>16:9</b>	Scale the image at a 16:9 aspect ratio.
<b>Native</b>	The input source will be displayed without scaling.
<b>Contrast</b>	Control the degree of difference between the lightest and darkest parts of the picture.
<b>Menu</b>	Press "Menu" to launch the on-screen display (OSD) menu. To exit OSD, Press "Menu" again.
<b>Re-Sync</b>	Automatically synchronizes the projector to the input source.
<b>D-Sub</b>	Press "D-Sub" to choose D-Sub (15 pins) connector source.
<b>Video</b>	Press "Video" to choose Composite video source.
<b>Source Lock</b>	Select auto detection all connector ports or lock current connector port.
<b>S-Video</b>	Press "S-Video" to choose S-Video source.
<b>YPbPr</b>	Press "YPbPr" to choose Component video source.
<b>HDMI</b>	Press "HDMI" to choose source from HDMI connector.
<b>Source</b>	Press "Source" to select an input signal.
<b>Overscan</b>	Mask off a few pixels on each edge of the image to be displayed. Use this function to adjust if image source happens to have noise near any edge of the display image.
<b>Brightness</b>	Adjust the brightness of the image.



<b>Letter-Box</b>	Enable the viewing of the letterboxed non-anamorphically enhanced movie at full screen width. Part of the original image will be lost if the image aspect ratio is less than 1.78:1.
<b>4:3</b>	Scale the image at a 4:3 aspect ratio.
<b>H. Keystone</b> ◀ / ▶	Adjust image distortion horizontally and makes a squarer image.
<b>V. Keystone</b> ▼ / ▲	Adjust image distortion vertically and makes a squarer image.
<b>Four Directional Select Keys</b>	Use ▲ ▼ ◀ ▶ to select items or make adjustments to your selection.
<b>Enter</b>	Confirm your item selection.



## On-screen Display Menus

*The Projector has multilingual On-screen Display menus that allow you to make image adjustments and change a variety of settings. The projector will automatically detect the source.*

### How to operate

1. To open the OSD menu, press “Menu” on the Remote Control or on the Control Panel.
2. When OSD is displayed, use ◀ ▶ keys to select any item in the main menu. While making a selection on a particular page, press ▼ or “Enter” key to enter sub menu.
3. Use ▲ ▼ keys to select the desired item and adjust the settings by ◀ ▶ key.
4. Select the next item to be adjusted in the sub menu and adjust as described above.
5. Press “Enter” to confirm, and the screen will return to the main menu.
6. To exit, press “Menu” again. The OSD menu will close and the projector will automatically save the new settings.

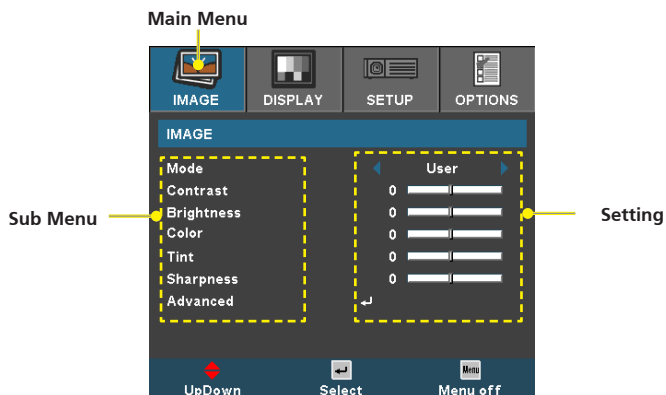



## Menu Tree

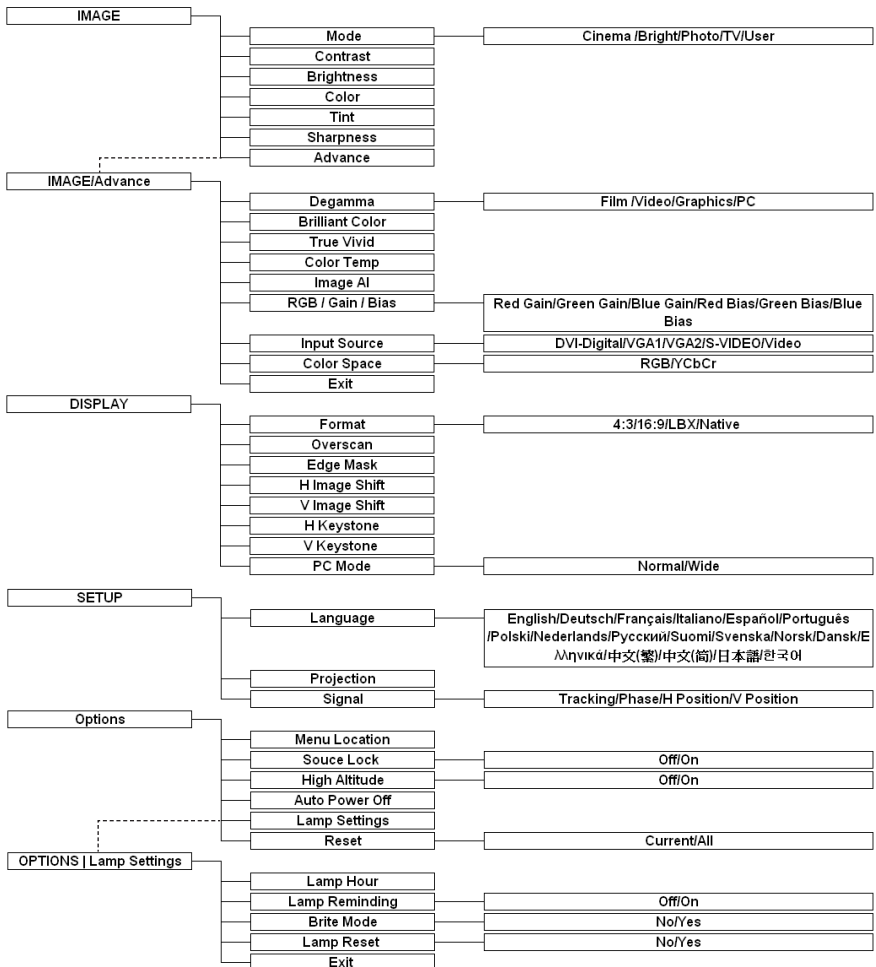



## *Image*

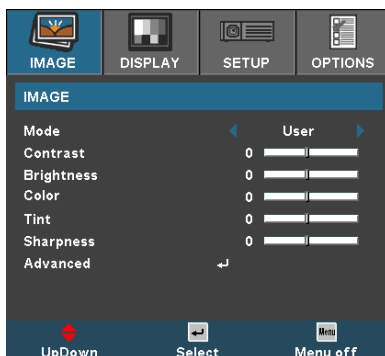

### Mode

There are many factory presets optimized for various types of images.

- ▶ Cinema: For home theater.
- ▶ Bright
- ▶ TV
- ▶ Photo
- ▶ User: Memorize user's settings.

### Contrast

The contrast controls the degree of difference between the lightest and darkest parts of the picture. Adjusting the contrast changes the amount of black and white in the image.

- ▶ Press the ◀ to decrease the contrast.
- ▶ Press the ▶ to increase the contrast.

### Brightness

Adjust the brightness of the image.

- ▶ Press the ◀ to darken image.
- ▶ Press the ▶ to lighten the image.

### Color

Adjusts a video image from black and white to fully saturated color.

- ▶ Press the ◀ to decrease the amount of color in the image.
- ▶ Press the ▶ to increase the amount of color in the image.



## Tint

Adjusts the color balance of red and green.

- ▶ Press the ◀ to increase the amount of green in the image.
- ▶ Press the ▶ to increase the amount of red in the image.

## Sharpness

Adjusts the sharpness of the image.

- ▶ Press the ◀ to decrease the sharpness.
- ▶ Press the ▶ to increase the sharpness.





## Image | Advance



### Degamma

This allows you to choose a degamma table that has been fine-tuned to bring out the best image quality for the input.

- ▶ **Film:** For home theater.
- ▶ **Video:** For video or TV source.
- ▶ **Graphics:** For image source.
- ▶ **PC:** For PC or computer source.

### Brilliant Color

This adjustable item utilizes a new color-processing algorithm and system level enhancements to enable higher brightness while providing true, more vibrant colors in picture. The range is from " 0 " to " 10 ". If you prefer a stronger enhanced image, adjust toward the maximum setting. For a smoother, more natural image, adjust toward the minimum setting.

### True Vivid

This adjustable item utilizes a new color-processing algorithm and enhancements to enable the picture's vividness to be significantly increased. The range is from " 0 " to " 3 ".

### Color Temp.

Adjust the color temperature. The range is from " 0 " to " 2 ". At higher temperature, the screen looks colder; at lower temperature, the screen looks warmer.

### Image AI

Image AI improves the contrast of the picture by optimizing the brightness of the lamp according to the picture content.



- ▶ **On:** The dynamic image performance manager is active in making sure your greatest pleasure from seeing a movie dynamically with the most dark details revealed, vivid and bright image performed all the way.

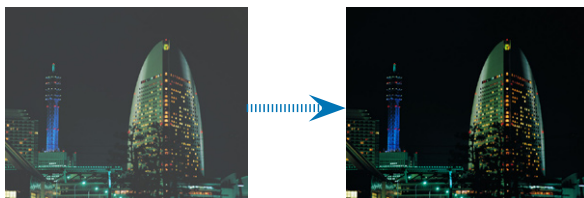

- ▶ **Off:** The dynamic image performance manager is on standby.

## RGB/Gain/Bias

Press ◀ or ▶ into the next menu as below and then use ▲ or ▼ to select item. Use ◀ or ▶ to select Red, Green, or Blue for brightness (Gain) and contrast (Bias).

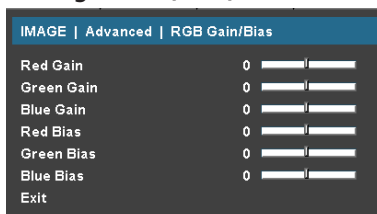



## Input Source

Enable input sources. Press ◀ or ▶ into the next menu as below and then use ▲ or ▼ to select. Press "Enter" to finalize the selection. The projector will not search inputs that are de-selected.

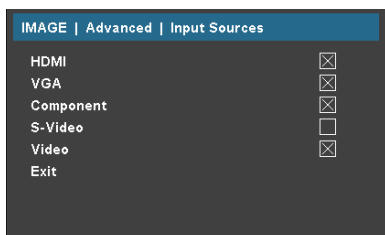

## Color Space

Select an appropriate color matrix type from RGB or YPbPr.



## Display

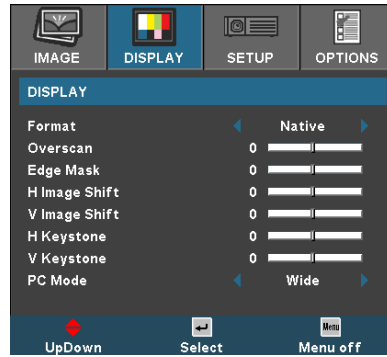

### Format

Use this function to choose your desired aspect ratio.

- ▶ **4:3:** This format is for 4x3 input sources not enhanced for Widescreen TV.
- ▶ **16:9:** This format is for 16x9 input sources, like HDTV and DVD enhanced for Widescreen TV.
- ▶ **LBX:** This format is for non-16x9, letterbox source and for users who use external 16x9 lens to display 2.35:1 aspect ratio using full resolution.
- ▶ **Native:** This format displays the original image without any scaling.

Input Signal

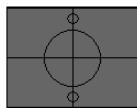

4 : 3 format

□ : Display area  
■ : Picture area

Display on Screen

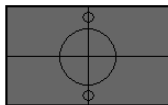
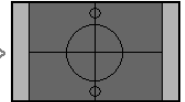

Or

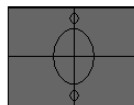

16 : 9 format

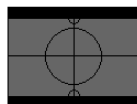
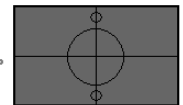

LBX format

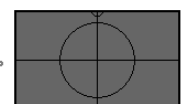



Detail informations about LBX mode :

1. Some Letter-Box DVD contents are not enhanced for 16x9 TV, then image will not look right in 16:9 display. One can use 4:3 mode to view the correct info. But if the content itself is not 4:3, it will have black bars around the image in a 16:9 display. For this kind of content, you can use LBX mode to fill the image in the 16x9 display as much as possible.
2. If you use an external 16x9 lens, this LBX mode also allows you to watch a 2.35:1 content (include Anamorphic DVD and HDTV film source) that support anamorphic wide is enhanced for 16x9 Display in a wide 2.35:1 image.

In this case, there are no black bars, the full lamp power and vertical resolution is fully utilized for maximum viewing effects.

Other than these two occasions, one should stay with 16:9 and 4:3 modes for most viewing experiences.

---

## Overscan

Overscan function removes the noise in a video image. Over-scan the image to remove video encoding noise on the edge of video source.

---

## Edge Mask

- ▶ Press the ◀ to reduce the size of an image.
- ▶ Press the ▶ to magnify an image on the projection screen.

---

## H Image Shift

Shifts the projected image position horizontally.

---

## V Image Shift

Shifts the projected image position vertically.

---

## H Keystone

Press the ◀ or ▶ to adjust image distortion horizontally and makes a squarer image.

---

## V Keystone

Press the ◀ or ▶ to adjust image distortion vertically and makes a squarer image.



## PC Mode

This Mode is only for use when using this projector with a PC signal, either Analogue connector.



❖ "PC Mode" function is only supported under RGB source.

- ▶ **Wide:** If your PC output is a wide screen format resolution you must select this setting.

*Examples of Wide screen resolutions are: 720 x 400 / 854 x 480 / 1280 x 720 / 1280 x 768.*

- ▶ **Normal:** If your PC output is a Normal (4:3) resolution you must select this setting.

*Examples of Normal resolutions are: 640 x 480 / 800 x 600 / 1024 x 768 / 1152 x 870 (\* for MAC) / 1280 x 1024 / 1400 x 1050.*

**\*All supported resolutions are listed on page 41.**



## Setup



### Language

Choose the multilingual OSD menu. Press ◀ or ▶ into the sub menu and then use the ▲ or ▼ key to select your preferred language. Press "Enter" to finalize the selection.

### Projection

- ▶  Front-Desktop

The factory default setting.

- ▶  Rear-Desktop

When you select this function, the projector reverses the image so you can project behind a translucent screen.

- ▶  Front-Ceiling

When you select this function, the projector turns the image upside down for ceiling-mounted projection.

- ▶  Rear-Ceiling

When you select this function, the projector reverses and turns the image upside down at same time. You can project from behind a translucent screen with ceiling mounted projection.

### Signal

- ▶ Phase: Changes the display data frequency to match the frequency of your computer's graphic card. When you expe-



rience a vertical flickering bar, use this function to make an adjustment.

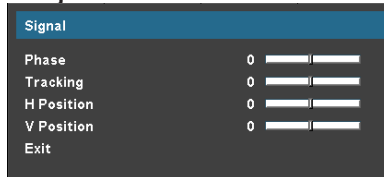

- ▶ **Tracking :** Synchronizes the signal timing of the display with the graphics card. If you experience an unstable or flickering image, use this function to correct it.
- ▶ **H. Position:** Adjusts the horizontal position.
- ▶ **V. Position:** Adjusts the vertical position.





## Options

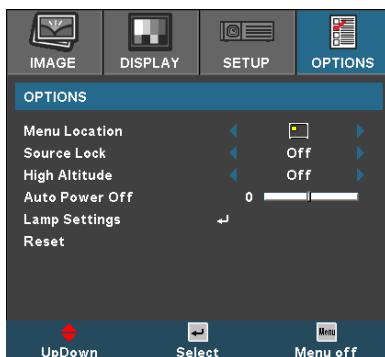

### Menu Location

Choose the menu location on the display screen.

### Source Lock

When this function is turned off, the projector will search for other signals if the current input signal is lost. When this function is turned on, it will search for a specified connection port.

### High Altitude

Choose "On" to turn on High Altitude mode. Operates the fans at full speed continuously to allow for proper high altitude cooling of the projector.

### Auto Power Off (min)

Sets the interval of power-off of the system, if there is no signal input. (In minutes)



## *Options | Lamp Settings*

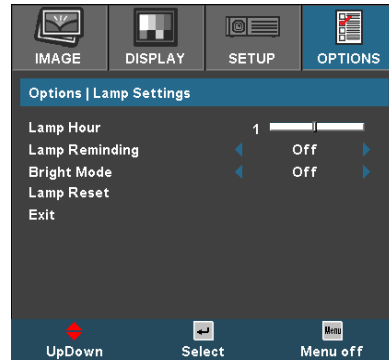

### Lamp Hour

Displays the cumulative lamp operating time.

### Lamp Reminding

Choose this function to show or to hide the warning message when the changing lamp message is displayed. The message will appear up 30 hours before suggested replacement of lamp.

### Bright Mode

Choose "On" to increase the brightness. Choose "Off" to return normal mode.

### Lamp Reset

Reset the lamp life hour after replacing the lamp.

## Troubleshooting

*If you experience a problem with your projector, please refer to the following information. If a problem persists, please contact your local reseller or service center. (See page 43 for details)*

### Image Problems

#### **[?] No image appears on-screen**

- ▶ Ensure all the cables and power connections are correctly and securely connected as described in the "Installation" section.
- ▶ Ensure the pins of connectors are not crooked or broken.
- ▶ Check if the projection lamp has been securely installed. Please refer to the "Replacing the lamp" section.
- ▶ Make sure you have removed the lens cap and the projector is switched on.

#### **[?] Partial, scrolling or incorrectly displayed image**

- ▶ Press "Re-Sync" on the remote control or control panel.
- ▶ If you are using a PC:

##### For Windows 95, 98, 2000, XP:

1. Open the "My Computer" icon, the "Control Panel" folder, and then double click on the "Display" icon.
2. Select the "Settings" tab.
3. Verify that your display resolution setting is lower than or equal to SXGA+ (1400 x 1050). (\*)
4. Click on the "Advanced Properties" button.

If the projector is still not projecting the whole image, you will also need to change the monitor display you are using. Refer to the following steps.

5. Verify the resolution setting is lower than or equal to SXGA+ (1400 x 1050) resolution.



❖ (\*) The resolution WXGA (1280 x 720) is recommend for computer signal.



❖(\*) The resolution: WXGA (1280 x 720) is recommended for this projector.

6. Select the "Change" button under the "Monitor" tab.
  7. Click on "Show all devices." Next, select "Standard monitor types" under the SP box; choose the resolution mode you need under the "Models" box.
  8. Verify that the resolution setting of the monitor display is lower than or equal to SXGA+ (1400 x 1050). (\*)
- ▶ If you are using a Notebook:
1. First, follow the steps above to adjust resolution of the computer.
  2. Press the toggle output settings. Example: [Fn]+[F4]

Compaq ⇨	[Fn]+[F4]	Hewlett	⇨	[Fn]+[F4]
Dell ⇨	[Fn]+[F8]	Packard	⇨	[Fn]+[F4]
Gateway ⇨	[Fn]+[F4]	NEC ⇨		[Fn]+[F3]
IBM ⇨	[Fn]+[F7]	Toshiba ⇨		[Fn]+[F5]

Mac Apple:  
System Preference ⇨ Display ⇨ Arrangement ⇨ Mirror display

**[?] The screen of the Notebook or PowerBook computer is not displaying your presentation**

- ▶ **If you are using a Notebook PC:**  
Some Notebook PCs may deactivate their own screens when a second display device is in use. Each has a different way to be reactivated. Refer to your computer's manual for detailed information.

**[?] Unstable or flickering image**

- ▶ Use "Tracking" to correct it. See page 31 for more information.  
▶ Change the monitor color setting on your computer.

**[?] Image has vertical flickering bar**

- ▶ Use "Phase" to make an adjustment. See page 31 for more information.  
▶ Check and reconfigure the display mode of your graphic card to make it compatible with the projector.

## **[?] Image is out of focus**

- ▶ Make sure the Lens cap is removed.
- ▶ Adjusts the Focus Ring on the projector lens.
- ▶ Make sure the projection screen is between the required distance 4.9 to 39.4 feet (1.5 to 10.0 meters) from the projector. See page 16.

## **[?] The image is stretched when displaying 16:9 DVD title**

When you play anamorphic DVD or 16:9 DVD, the projector will show the best image in 16: 9 format on projector side.

If you play the LBX format DVD title, please change the format as LBX in projector OSD.

If you play 4:3 format DVD title, please change the format as 4:3 in projector OSD.

If the image is still stretched, you will also need to adjust the aspect ratio by referring to the following:

- ▶ Please setup the display format as 16:9 (wide) aspect ratio type on your DVD player.

## **[?] Image is too small or too large**

- ▶ Adjust the zoom lever on the top of the projector.
- ▶ Move the projector closer to or further from the screen.
- ▶ Press [4:3], [16:9], [Letter Box], [Native] button on the remote control or [Projector menu] on the projector panel, go to "Display → Format". Try the different settings.

## **[?] Image has slanted sides:**

- ▶ If possible, reposition the projector so that it is centered on the screen and below the bottom of the screen.
- ▶ Press [Keystone +/-] button until the sides are vertical on the remote control.

## **[?] Image is reversed**

- ▶ Select "Setup → Projection" from the OSD and adjust the projection direction.



❖ Use of Keystone is not recommended.



## Intermission Problems

### **[?]** The projector stops responding to all controls

- ▶ If possible, turn off the projector, then unplug the power cord and wait at least 30 seconds before reconnecting power.

### **[?]** Lamp burns out or makes a popping sound

- ▶ When the lamp reaches its end of life, it will burn out and may make a loud popping sound. If this happens, the projector will not turn on until the lamp module has been replaced. To replace the lamp, follow the procedures in the “Replacing the Lamp” section on page 40.

## LED Problems

### **[?]** LED lighting message

Message	On/Standby LED	Temp-LED	Lamp-LED
	(Green)	(Red)	(Orange)
Standby State (Input power cord)	Flashing	○	○
Power on (warming)	☀	○	○
Lamp lighting	☀	○	○
Power off (Cooling)	☀	○	○
Error (Lamp fail)	☀	○	☀
Error (Fan fail)	☀	Flashing	○
Error (Over Temp.)	☀	☀	○



Steady light ⇨ ☀

No light ⇨ ○

## **[?] Message Reminders**

### ▶ Fan failed:



Fan Failure

Lamp will automatically turn off soon.

### ▶ Over temperature:



Over Temperature

Lamp will automatically turn off soon.

### ▶ Thermal Warning:



Thermal Warning

Lamp will automatically turn off soon.

### ▶ Replacing the lamp:



Replacement Suggested !

Lamp is approaching the end of its useful life.



## Remote Control Problems

### **?** If the remote control does not work

- ▶ Check the operating angle for the remote control is approximately  $\pm 22.5^\circ$ .
- ▶ Make sure there are not any obstructions between the remote control and the projector. Move to within 6 m (20 ft) of the projector.
- ▶ Make sure batteries are inserted correctly.
- ▶ Make sure batteries are exhausted. If so, replace weak batteries in the remote control.



## Replacing the lamp

The projector automatically detects the lamp life. When the lamp life is nearing the end of use, you will receive a warning message.



**Warning:** Lamp compartment is hot! Allow it to cool down before changing lamp!

**Replacement Suggested !**  
Lamp is approaching the end of its useful life.

When you see this message, please contact your local reseller or service center to change the lamp as soon as possible. Make sure the projector has been cooled down for at least 30 minutes before changing the lamp.

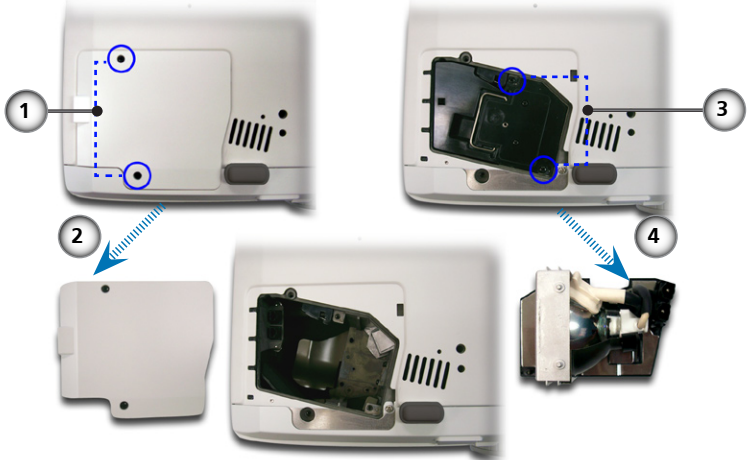

**Warning:** To reduce the risk of personal injury, do not drop the lamp module or touch the lamp bulb. The bulb may shatter and cause injury if it is dropped.

### Lamp Replacing Procedure:

1. Switch off the power to the projector by pressing the Power button.
2. Allow the projector to cool down at least 30 minutes.
3. Disconnect the power cord.
4. Use a screwdriver to remove the 2 screws from the cover. ❶
5. Push up and remove the cover. ❷
6. Remove the 2 screws from the lamp module. ❸
7. Pull out the lamp module. ❹

To replace the lamp module, reverse the previous steps.

8. Turn on the projector and do "Lamp Reset" after the lamp module is replaced.

Lamp Reset: (i) Press "Menu" → (ii) Select "Options" → (iii) Select "Lamp settings" → (iv) Select "Lamp reset" → (v) Select "Yes".



## Compatibility Modes

Mode	Resolution	V.Frequency (Hz)	V.Frequency (Hz)
		Analog	Digital
VESA VGA	640 x 350	70,85	70,85
VESA VGA	640 x 400	85	85
VESA VGA	640 x 480	60,72,75,85	60,72,75,85
VESA VGA	720 x 400	70,85	70,85
VESA SVGA	800 x 600	56,60,72,75,85	56,60,72,75,85
VESA XGA	1024 x 768	60,70,75,85	60,70,75
VESA WXGA	1280 x 720	60,70,75,85	60,70,75,85
*VESA WXGA	1280 x 768	60,70,75,85	60,70,75,85
*SXGA	1280 x 1024	60,75	60
*SXGA+	1400 x 1050	60	-
MAC	1152 x 870	75.06	-
MAC G4	640 x 480	60	-



Remark : "\*" compressed computer image.

## Ceiling Mount Installation

1. To prevent damaging your projector, please use the ceiling mount package for installation.
2. If you wish to use a third party ceiling mount kit, please ensure the screws used to attached a mount to the projector met the following specifications:

- ▶ Screw type: M3
- ▶ Maximum screw length: 10mm
- ▶ Minimum screw length: 7.5mm



❖ Please note that damage resulting from incorrect installation will invalidate the warranty.



### ⚠ Warning:

1. If you buy the ceiling mount from other company, please ensure that there is at least 10cm distance between the bottom cover of the projector and the ceiling.
2. Avoid placing the projector near sources of heat such air-conditioning units and heaters otherwise it may overheat and shut down automatically.

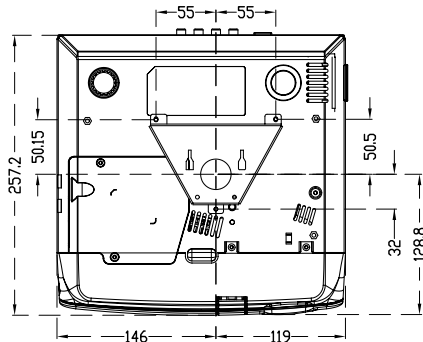
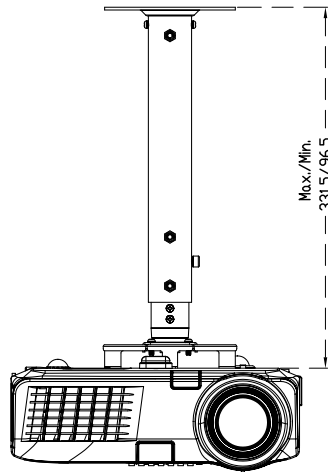



## Optoma Global Office

*For service or support please contact your local office.*

### USA

715 Sycamore Drive  
Milpitas, CA 95035, USA  
[www.optomausa.com](http://www.optomausa.com)

Tel : 408-383-3700  
Fax: 408-383-3702  
Service : [service@optoma.com](mailto:service@optoma.com)

### Canada

120 West Beaver Creek Road Unit #9  
Richmond Hill, ON L4B 1L2, Canada  
Tel : 905-882-4228  
[www.optoma.com](http://www.optoma.com)

Fax: 905-882-4229

### Europe

42 Caxton Way, The Watford Business Park  
Watford, Hertfordshire, WD18 8QZ, UK  
Tel : +44 (0) 1923 691 800  
[www.optomaeurope.com](http://www.optomaeurope.com)

Fax: +44 (0) 1923 691 888

Service Tel : +44 (0)1923 691865 Service : [service@tsc-europe.com](mailto:service@tsc-europe.com)

### Taiwan

5F., No. 108, Minchiuan Rd.  
Shindian City, Taipei Taiwan 231,  
R.O.C.  
Service : [services@optoma.com.tw](mailto:services@optoma.com.tw)

Tel : +886-2-2218-2360  
Fax: +886-2-2218-2313  
[www.optoma.com.tw](http://www.optoma.com.tw)  
[asia.optoma.com](http://asia.optoma.com)

### Hong Kong

Unit 901, 9/F., Vogue Centre, No. 696  
Castle Peak Road, Kowloon, Hong Kong  
Tel : +852-2396-8968  
[www.optoma.com.cn](http://www.optoma.com.cn)

Fax: +852-2370-1222

### China

5F, No. 1205, Kaixuan Rd.,  
Changning District  
Shanghai, 200052, China

Tel : +86-21-62947376  
Fax: +86-21-62947375  
[www.optoma.com.cn](http://www.optoma.com.cn)

### Latin America

715 Sycamore Drive  
Milpitas, CA 95035, USA  
[www.optoma.com.br](http://www.optoma.com.br)

Tel : 408-383-3700  
Fax: 408-383-3702  
[www.optoma.com.mx](http://www.optoma.com.mx)