

myprojectorlamps.com

**The most trusted, dependable name
in projector lamp sales.**



<http://www.myprojectorlamps.com>



<http://www.myprojectorlamps.ca>



<http://www.myprojectorlamps.eu>









The following projector manual has not been modified or altered in any way.

Table of Contents

Table of Contents	1
Usage Notice	2
<i>Precautions</i>	2
Introduction	4
<i>Product Features</i>	4
<i>Package Overview</i>	5
<i>Product Overview</i>	6
<i>Main Unit</i>	6
<i>Control Panel</i>	7
<i>Connection Ports</i>	8
<i>Wireless Remote Control</i>	9
Installation	10
<i>Connecting the Projector</i>	10
<i>Powering On/Off the Projector</i>	11
<i>Powering On the Projector</i>	11
<i>Powering Off the Projector</i>	12
<i>Warning Indicator</i>	12
<i>Adjusting the Projected Image</i>	13
<i>Adjusting the Image Height</i>	13
<i>Adjusting the Projector's Zoom/Focus</i>	14
User Controls	15
<i>Control Panel & Remote Control</i>	15
<i>On-Screen Display Menus</i>	18
<i>How to operate</i>	18
<i>Menu Tree</i>	19
<i>Image-I (Computer mode)</i>	20
<i>Image-I (Video mode)</i>	22
<i>Image-II (Computer mode)</i>	24
<i>Image-II (Video mode)</i>	26
<i>Management</i>	28
<i>System</i>	30
Appendices	32
<i>Troubleshooting</i>	32
<i>Replacing the lamp</i>	35
<i>Ceiling Mount Installation</i>	36
<i>Throw Angle</i>	37

Precautions

Follow all warnings, precautions, and maintenance procedures as recommended in this user's guide.

-  **Warning-** Do not look into the projector's lens when the lamp is on. The bright light may hurt your eyes.
-  **Warning-** To reduce the risk of fire or electric shock, do not expose this product to rain or moisture.
-  **Warning-** Please do not open or disassemble the product as this may cause electric shock.
-  **Warning-** When changing the lamp, please allow unit to cool down, and follow all changing instructions.
-  **Warning-** This product will detect the life of the lamp itself. Please be sure to change the lamp when it shows warning messages.
-  **Warning-** Reset the "Lamp Reset" function from the On Screen Display "System-->Lamp Setting" menu after replacing the lamp module (refer to page 30).
-  **Warning-** When switching the projector off, please ensure the projector completes its cooling cycle before disconnecting power.
-  **Warning-** Turn on the projector first and then the signal sources.
-  **Warning-** Do not use lens cap when projector is in operation.

Do:

- ❖ Turn off the product before cleaning.
- ❖ Use a soft cloth moistened with mild detergent to clean the display housing.
- ❖ Disconnect the power plug from AC outlet if the product is not being used for a long period of time.

Do not:

- ❖ Block the slots and openings on the unit provided for ventilation.
- ❖ Place in direct sunlight.
- ❖ Use abrasive cleaners, waxes, or solvents to clean the unit.
- ❖ Use under the following conditions:
 - Extreme heat, cold, or humidity.
 - In areas susceptible to excessive dust and dirt.
 - Near any appliance generating a strong magnetic field.

Product Features

This product is a 480p single chip DLP™ projector featuring:

- ◆ Single 16:9 854x480 DarkChip2™ chip DLP™ technology
- ◆ Uses 4x color wheel RGBRGB cycle
- ◆ NTSC/NTSC4.43/PAL/PAL-M/PAL-N/SECAM, and HDTV (480i/p, 576i/p, 720p, 1080i) compatible
- ◆ High-Definition connection for digital signal with HDCP function and supports 480p, 576p, 720p and 1080i
- ◆ Built-in de-interlacing with 3:2 and 2:2 pulldown
- ◆ Full function remote control
- ◆ User-friendly multilingual on-screen display menu
- ◆ Advanced **digital** keystone correction and high quality full screen image re-scaling
- ◆ SXGA, XGA compression and SVGA, VGA re-sizing
- ◆ User-friendly control panel

Package Overview

This projector comes with all the items shown below. Check to make sure your unit is complete.



Projector with lens cap



Power Cord 1.8m



RCA Component Cable for YPbPr 1.8m



S-Video Cable 1.8m



Composite Video Cable 1.8m
(Not for European Use)



SCART RGB/S-Video Adaptor
(For European Use Only)



❖ Due to the difference in applications for each country, some regions may have different accessories.



Wireless Remote Controller



Battery x 2

Documents :

- User's Manual
- Warranty Card

Product Overview

Main Unit

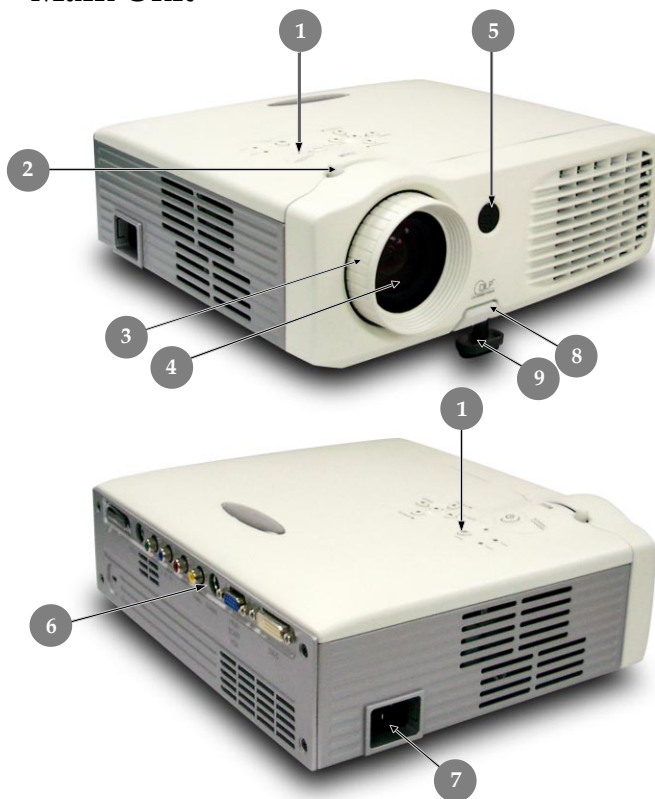

1. Control Panel
2. Zoom Lever
3. Focus Ring
4. Zoom Lens
5. IR Receivers
6. Connection Ports
7. Power Socket
8. Elevator Button
9. Elevator Foot

Control Panel

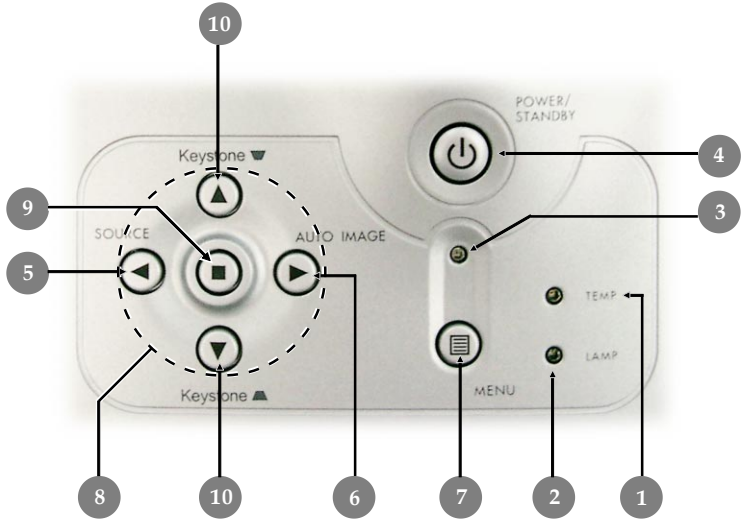

1. Temp Indicator LED
2. Lamp Indicator LED
3. Power Indicator LED
4. Power/Standby
5. Source
6. Auto Image
7. Menu (On/Off)
8. Four Directional Select Keys
9. Enter
10. Keystone Correction

Introduction

Connection Ports

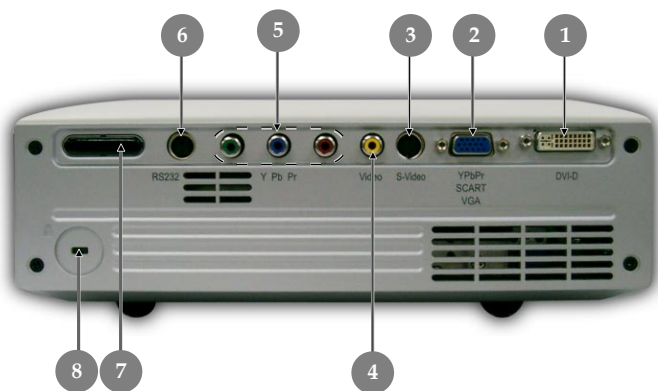

1. DVI-D Input Connector (PC Digital and DVI-HDCP)
2. PC Analog signal/SCART RGB/HDTV/Component Video Input Connector
3. S-Video Input Connector
4. Composite Video Input Connector
5. Component Video Input RCA Connectors
6. RS232 Input Connector
7. IR Receiver
8. Kensington™ Lock Port

Wireless Remote Control

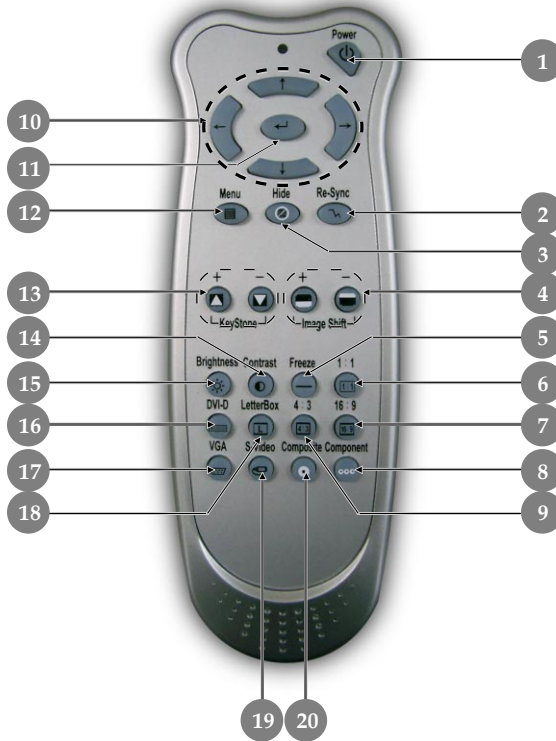

- | | |
|-------------------------------------|-------------------------|
| 1. Power On/Off | 12. Menu/Exit |
| 2. Re-sync | 13. Keystone Adjustment |
| 3. Hide | 14. Contrast |
| 4. Image Shift | 15. Brightness |
| 5. Freeze | 16. DVI-D Source |
| 6. 1:1 | 17. VGA Source |
| 7. 16:9 | 18. Letterbox |
| 8. Component Source | 19. S-Video Source |
| 9. 4:3 | 20. Composite Source |
| 10. Four Directional Select
Keys | |
| 11. Enter | |

Connecting the Projector

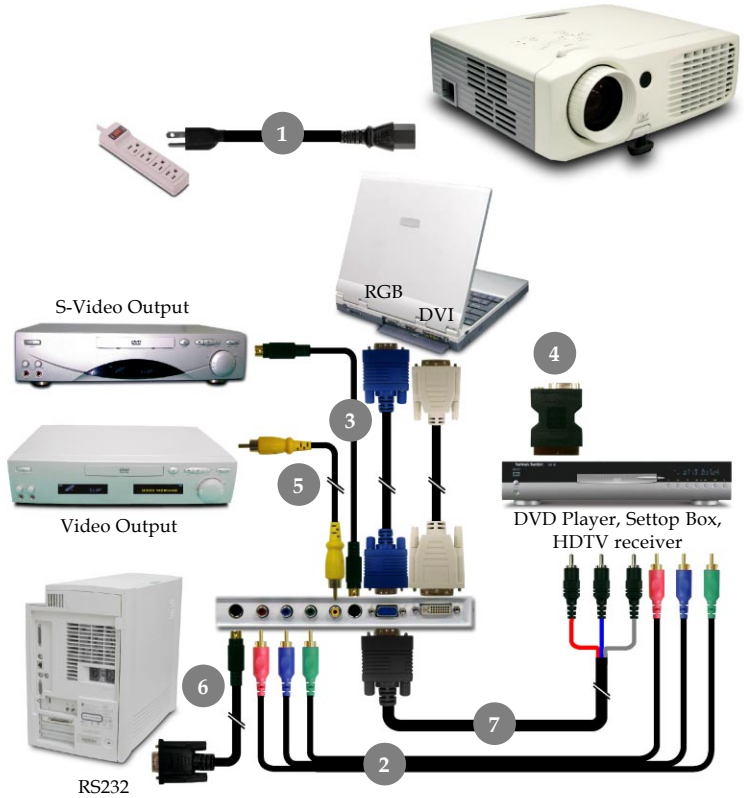

❖ Due to the difference in applications for each country, some regions may have different accessories.

1. Power Cord
2. RCA Component Cable for YPbPr
3. S-Video Cable
4. SCART RGB/S-Video Adaptor
5. Composite Video Cable
6. RS232 Cable
7. VGA to RCA Cable for YPbPr

Powering On/Off the Projector

Powering On the Projector

1. Remove the lens cap.
2. Ensure that the power cord and signal cable are securely connected. The Power LED will flash **green**.
3. Turn on the lamp by pressing “Power/Standby” button on the control panel. **1** And the **Power LED** will turn **green**.

The first time you use the projector, you can select your preferred language from quick menu after the startup screen display.

English	Español	Russian	Finnish	日本語	한국어
Deutsch	Italiano	Dutch	Greek	繁體中文	简体中文
Français	Português	Polish	No/Dk	Swedish	

4. Turn on your source (computer, notebook, video player, etc.). The projector will detect your source automatically.
- ❖ If the screen displays “No Signal”, please make sure the signal cables are securely connected.
 - ❖ If you connect multiple sources at the same time, use the “Source” button on the control panel to switch.



- ❖ Turn on the projector first followed by the signal sources.

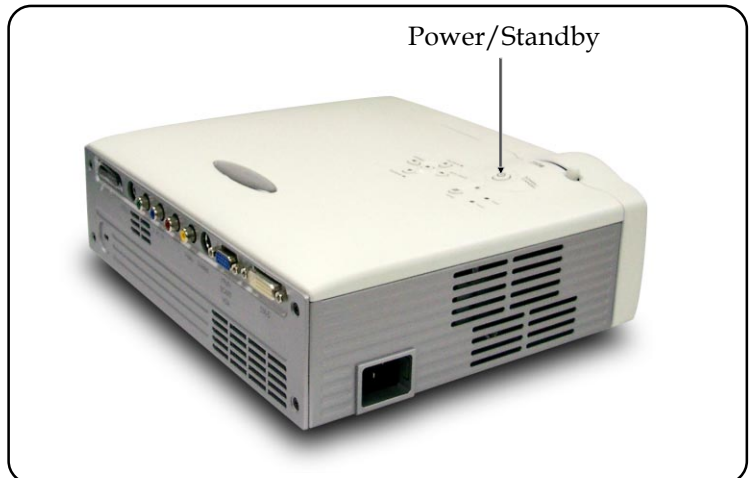

Powering Off the Projector

1. Press the “Power/Standby” button to turn off the projector lamp, you will see a message “Power off the lamp? Picture Mute” displayed on the projector’s screen. Press the “Power/Standby” button again to confirm, otherwise the message will disappear after 25 seconds.

Please note that if the ► key is pressed instead, the projector will enter the “Picture Mute” mode and no image will be displayed. To exit the “Picture Mute” mode, press the “Power/Standby” button again, or press “Hide” on the remote control.

2. The cooling fans continue to operate for about **60** seconds for cooling cycle and the Power LED will turn **green**. When the Power LED begins flashing, the projector has entered standby mode.

If you wish to turn the projector back on, you must wait until the projector has completed the cooling cycle and has entered standby mode. Once in standby mode, simply press “Power/Standby” button to restart the projector.

3. Disconnect the power cord from the electrical outlet and the projector.
4. Do not turn on the projector immediately following a power off procedure.

Warning Indicator

- ❖ *When the “LAMP” indicator lights solid red, the projector will automatically shut itself down. Please contact your local reseller or service center.*
- ❖ *When the “TEMP” indicator lights solid red for about **20** seconds, it indicates the projector has been overheated. You will see a message “Projector Overheated. Lamp will automatically turn off soon.” on the on-screen display. The projector will automatically shut itself down. Under normal conditions, the projector can be switched on again after it has cooled down. If the problem persists, you should contact your local dealer or our service center.*
- ❖ *When the “TEMP” indicator flashes red for about **10** seconds, you will see a message “Fan fail. Lamp will automatically turn off soon.” on the on-screen display. Please contact your local dealer or our service center.*

Adjusting the Projected Image

Adjusting the Image Height

The projector is equipped with an elevator foot to adjust the image height.

To raise or lower the image :

1. Turn the projector over and locate the elevator foot. Press the elevator button **1** to extend the foot so it may be adjusted.
2. While holding down the elevator button, adjust the foot to the desired height, **2** then release the button to lock the elevator foot into position.
3. Use **3** to fine-tune tilt-adjustment
4. Lower the projector so it rests on its foot; adjust as needed.

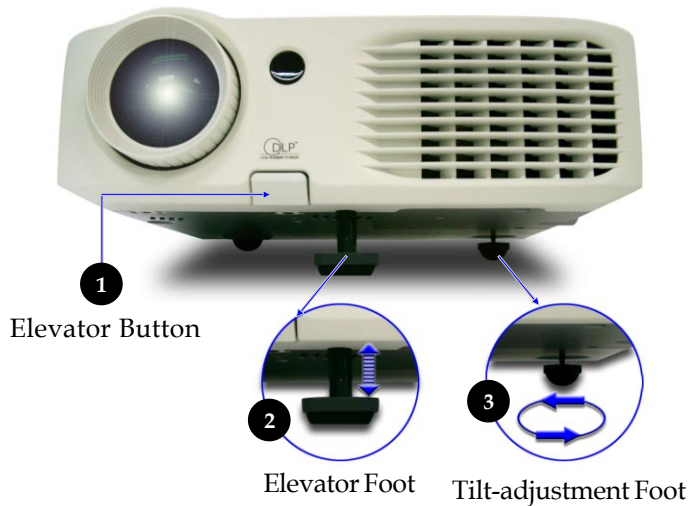

Adjusting the Projector's Zoom/Focus

You may adjust the zoom to zoom the lens in or out. Turn the zoom lever to zoom in or zoom out. To focus on the image, turn the focus ring until you see a clear image. The projector will focus at distances from 4.9 to 40.7 feet (1.5 to 12.5 meters).

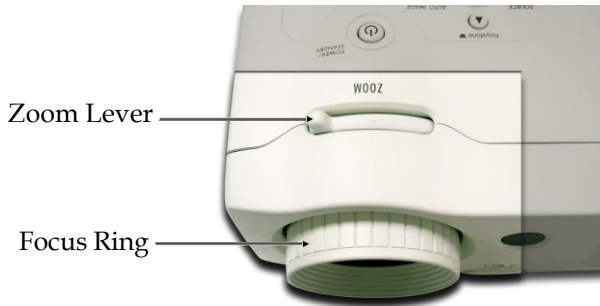

Control Panel & Remote Control

There are two ways to control the projector: through the remote control or through the control panel on the projector.

Remote Control



Control Panel



Using the Remote Control

Power

- ▶ “Power” turns on the projector’s lamp. Refer to the “Powering On/Off the Projector” section on page 11~ 12 for more details.

Hide

- ▶ “Hide” immediately turns the screen black. Press “Hide” again to restore the displayed image.

Freeze

- ▶ “Freeze” pauses the screen image, press “Freeze” again to un-pause.

Re-Sync

- ▶ Automatically synchronizes the projector with the input source.

Brightness

- ▶ Adjust the brightness of the image.

Contrast

- ▶ Control the degree of difference between the lightest and darkest parts of the picture.

Keystone +/-

- ▶ Correct image distortion caused by tilting the projector.

4 : 3

- ▶ Scale the image at a 4:3 aspect ratio.

16 : 9

- ▶ Scale the image at a 16:9 aspect ratio.

1:1

- ▶ The input source will be displayed without scaling.

Letterbox

- ▶ Enable the viewing of the letterboxed non-anamorphically enhanced movie at full screen width. Part of the original image will be lost if the image aspect ratio is less than 1.78:1.

Image shift +/-

- ▶ Shifts the projected image position vertically.

Four Directional Select Keys

- ▶ Press "Menu", then use ▲ ▼ ◀ ▶ to select menu items or to make adjustments to your selection.

Enter

- ▶ Confirm your selection.

Menu/Exit

- ▶ Display or exits the on-screen display menu.

VGA

- ▶ Press "VGA" to change source to VGA/YPbPr/SCART connector.

DVI-D

- ▶ Press "DVI-D" to change source to DVI-D connector.

Composite

- ▶ Press "Composite" to change source to Composite Video source.

S-Video

- ▶ Press "S-Video" to change source to S-Video source.

Component

- ▶ Press "Component" to change source to component connector.

Using the Control Panel

Power/Standby

- ▶ Refer to the “Power On/Off the Projector” section on pages 11-12.

Source

- ▶ Press “Source” to choose DVI, RGB, S-Video, SCART RGB, Composite, Component and HDTV sources.





Menu

- ▶ Display or exits the onscreen display menus.

Keystone + / -

- ▶ Adjusts image distortion caused by tilting the projector (± 16 degrees).

Four Directional Select Keys

- ▶ Press “Menu,” then use     to select items or make adjustments to your selection.

Enter

- ▶ Confirm your selection of items.

Auto Image

- ▶ Automatically synchronizes the projector with the input source.

On-screen Display Menus

How to Operate

- ▶ The projector has multilingual on-screen display menus that allow you to make image adjustments and change a variety of settings. The projector automatically detects the source.
- ▶ Press “Menu” on the Remote Control or Control Panel.
- ▶ When the menu is displayed, use ▲ ▼ ◀ ▶ to navigate the main menu. To Select a specific icon, press “Enter” to access related.
 - ◆ To exit the main menu, press ◀ or “Menu” .
- ▶ When a sub menu is displayed, use ▲ ▼ to select the desired item and adjust the settings with ◀ ▶.
 - ◆ To exit the sub menu, press ◀ or “Menu” .
- ▶ After using ◀ ▶ to make selections within the sub menu, press “Enter” to confirm your changes and return to the sub menu.
 - ◆ Press ◀ or “Menu” to return to the main menu. If you do not press “Enter” to confirm your changes before exiting, the items will not to be modified.

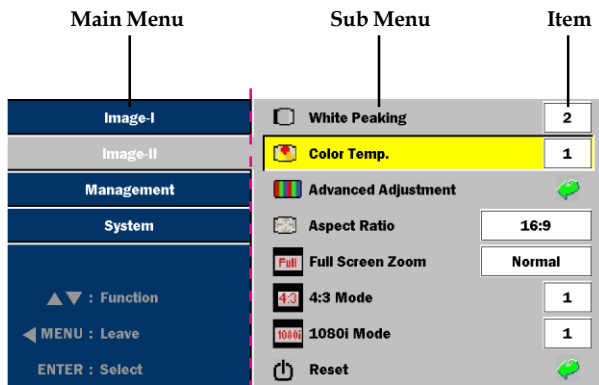

Menu Tree

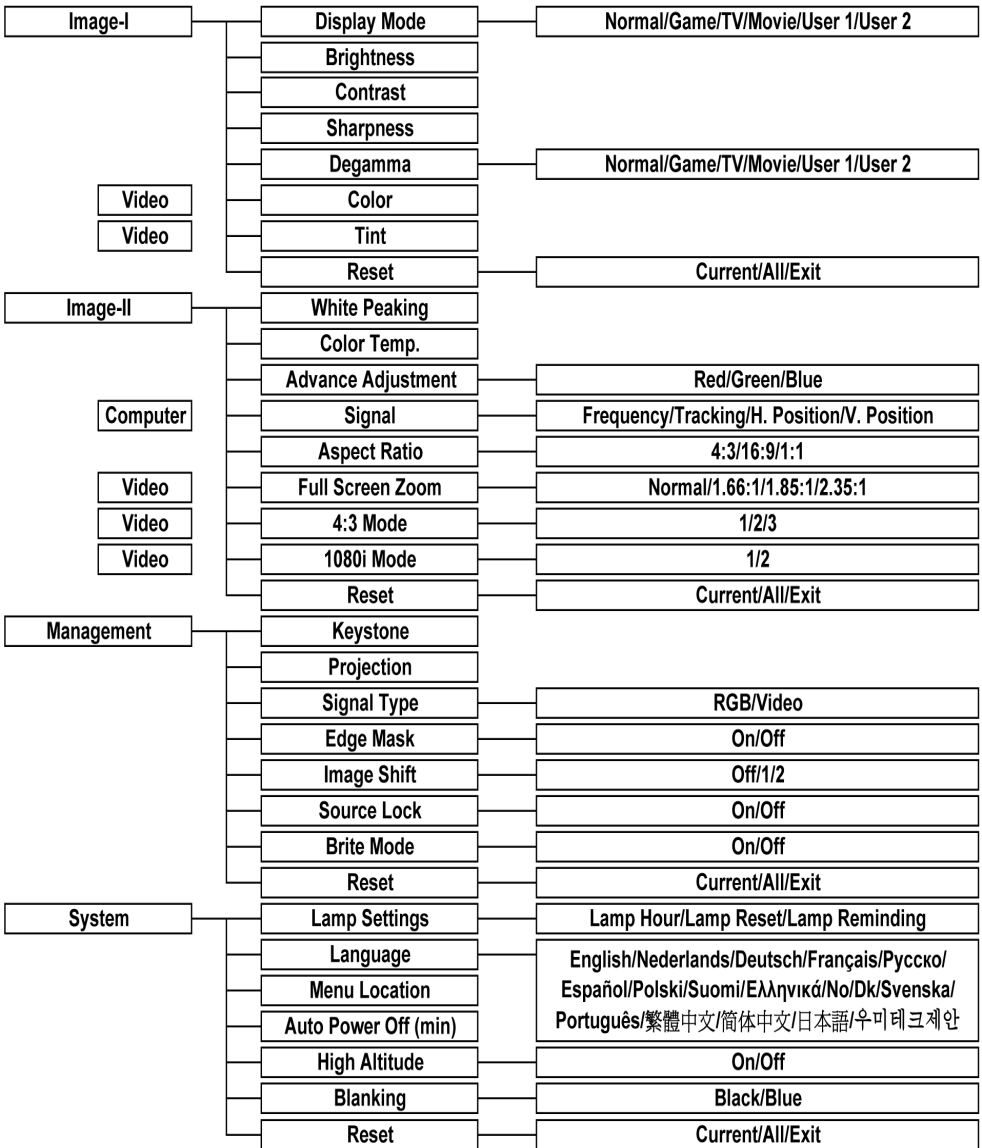

User Controls

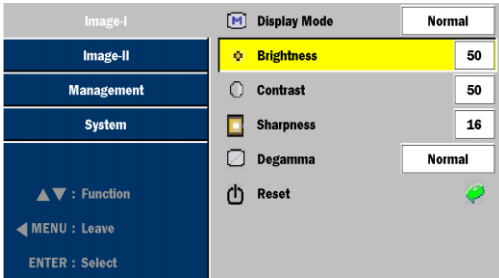

Image-I (Computer Mode)

Display Mode

There are many factory presets optimized for various types of images.

- ▶ Normal : For normal status.
- ▶ Movie : For home theater.
- ▶ Game : For game.
- ▶ TV : For TV standard color.
- ▶ User 1 / User 2: Memorize user's settings.

Brightness

Adjust the brightness of the image.

- ▶ Press ◀ to darken image.
- ▶ Press ▶ to lighten image.

Contrast

Contrast controls the degree of difference between the lightest and darkest parts of the picture. Adjusting the contrast changes the amount of black and white in the image.

- ▶ Press ◀ to decrease the contrast.
- ▶ Press ▶ to increase the contrast.

Sharpness

Adjusts the sharpness of the image.

- ▶ Press the ◀ to decrease the sharpness.
- ▶ Press the ▶ to increase the sharpness.

Degamma

This allows you to choose a degamma table that has been fine-tuned to bring out the best image quality for the input.

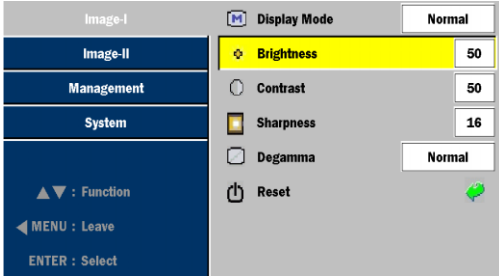

Image-I (Computer Mode)

- ▶ Normal : For normal status.
- ▶ Movie : For home theater.
- ▶ Game : For game.
- ▶ TV : For TV standard color.
- ▶ User 1 / User 2: Memorize user's settings.

Reset

Return the adjustments and settings to the factory default values.

- ▶ Current: Returns the current menu's settings to factory default values.
- ▶ All: Returns the settings for all menus to factory default values.
- ▶ Exit: Cancel the revised settings.

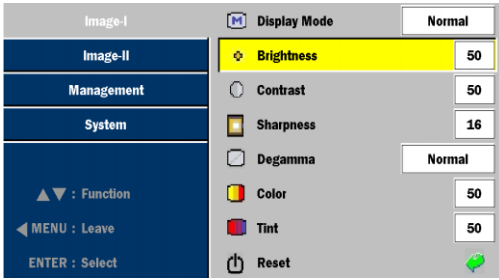

Image-I (Video Mode)

Display Mode

There are many factory presets optimized for various types of images.

- ▶ Normal : For normal status.
- ▶ Movie : For home theater.
- ▶ Game : For game.
- ▶ TV : For TV standard color.
- ▶ User 1 / User 2: Memorize user's settings.

Brightness

Adjust the brightness of the image.

- ▶ Press ◀ to darken image.
- ▶ Press ▶ to lighten image.

Contrast

Contrast controls the degree of difference between the lightest and darkest parts of the picture. Adjusting the contrast changes the amount of black and white in the image.

- ▶ Press ◀ to decrease the contrast.
- ▶ Press ▶ to increase the contrast.

Sharpness

Adjusts the sharpness of the image.

- ▶ Press the ◀ to decrease the sharpness.
- ▶ Press the ▶ to increase the sharpness.

Degamma

This allows you to choose a degamma table that has been fine-tuned to bring out the best image quality for the input.

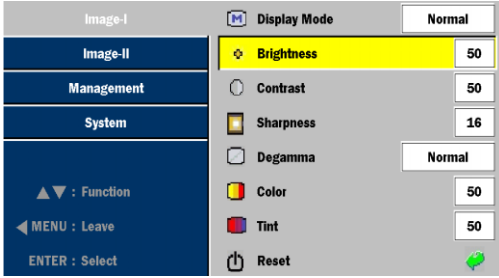

Image-I (Video Mode)

- ▶ Normal : For normal status.
- ▶ Movie : For home theater.
- ▶ Game : For game.
- ▶ TV : For TV standard color.
- ▶ User 1 / User 2: Memorize user's settings.

Color

Adjusts a video image from black and white to fully saturated color.

- ▶ Press the ◀ to decrease the amount of color in the image.
- ▶ Press the ▶ to increase the amount of color in the image.

Tint

Adjusts the color balance of red and green.

- ▶ Press the ◀ to increase the amount of green in the image.
- ▶ Press the ▶ to increase the amount of red in the image.

Reset

Return the adjustments and settings to the factory default values.

- ▶ Current: Returns the current menu's settings to factory default values.
- ▶ All: Returns the settings for all menus to factory default values.
- ▶ Exit: Cancel the revised settings

User Controls

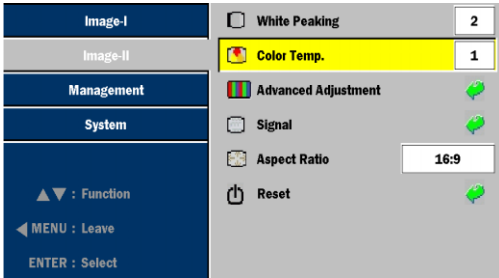

Image-II (Computer Mode)

White Peaking

Use the white peaking control to set the white peaking level of DMD chip. 0 stands for minimal peaking, and 10 stands for maximum peaking. If you prefer a stronger image, adjust towards the maximum setting. For a smooth and more natural image, adjust towards the minimum setting.

Color Temp.

Adjust the color temperature. At higher temperature, the screen looks colder; at lower temperature, the screen looks warmer.

Advanced Adjustment

Press "Enter" to adjust the red, green and blue colors for advanced adjustment of brightness and contrast of the individual colors.



Signal

- ▶ Frequency: Changes the display data frequency to match the frequency of your computer's graphic card. When you experience a vertical flickering bar, use this function to make an adjustment.
- ▶ Tracking : Synchronizes the signal timing of the display with the graphics card. If you experience an unstable or flickering image, use this function to correct it.
- ▶ H. Position: Adjusts the horizontal position.
- ▶ V. Position: Adjusts the vertical position.

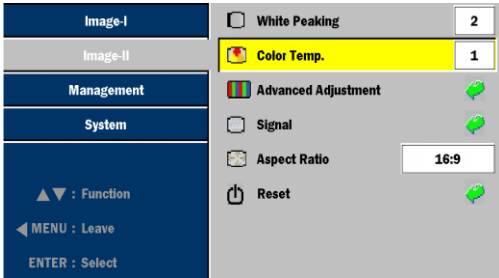

Image-II (Computer Mode)

Aspect Ratio

Use this function to choose your desired aspect ratio.

- ▶ 4:3 : The input source will be scaled to fit the projection screen.
- ▶ 16:9 : The input source will be scaled to fit the width of the screen.
- ▶ 1:1 :The input source will be displayed without scaling.

Reset

Return the adjustments and settings to the factory default values.

- ▶ Current: Returns the current menu's settings to factory default values.
- ▶ All: Returns the settings for all menus to factory default values.
- ▶ Exit: Cancel the revised settings

User Controls

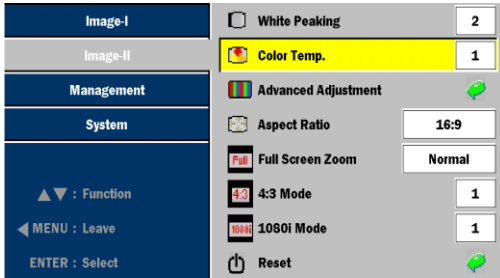

Image-II (Video Mode)

White Peaking

Use the white peaking control to set the white peaking level of DMD chip. 0 stands for minimal peaking, and 10 stands for maximum peaking. If you prefer a stronger image, adjust towards the maximum setting. For a smooth and more natural image, adjust towards the minimum setting.

Color Temp.

Adjust the color temperature. At higher temperature, the screen looks colder; at lower temperature, the screen looks warmer.

Advanced Adjustment

Press "Enter" to adjust the red, green and blue colors for advanced adjustment of brightness and contrast of the individual colors.



Aspect Ratio

Use this function to choose your desired aspect ratio.

- ▶ 4:3 : The input source will be scaled to fit the projection screen.
- ▶ 16:9 : The input source will be scaled to fit the width of the screen.
- ▶ 1:1 :The input source will be displayed without scaling.

Full Screen Zoom

Intend to fill up full 16:9 screen for video with aspect ratio such 1.85:1, 1.66:1, 2.35:1 and Normal (Original image pixel).

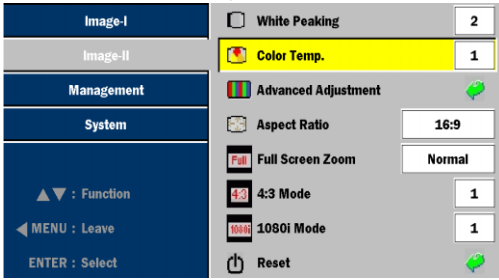

Image-II (Video Mode)

4:3 Mode (only Video 4:3 mode)

- ▶ 1 : Scale to 640 x 480 pixel.
- ▶ 2 : Scale to 854 x 480 pixel stretch horizontally.
- ▶ 3 : Scale to 854 x 640 pixel crop to 854 x 480.

1080i Mode (only Video 1080i mode)

- ▶ 1 : Scale to 854 x 480 pixel.
- ▶ 2 : Scales 1080i signal to 960 x 540 and displays the middle 854 x 480 pixels.

Reset

Return the adjustments and settings to the factory default values.

- ▶ Current: Returns the current menu's settings to factory default values.
- ▶ All: Returns the settings for all menus to factory default values.
- ▶ Exit: Cancel the revised settings

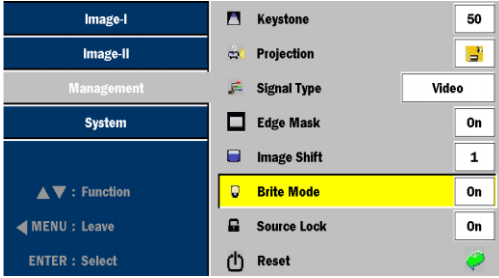

Management

Keystone (Keystone Correction)

Adjust image distortion caused by tilting projector. (± 16 degrees)

Projection

▶  **Front-Desktop**

The factory default setting.

▶  **Rear-Desktop**

When you select this function, the projector reverses the image so you may project from behind a translucent screen.

▶  **Front-Ceiling**

When you select this function, the projector turns the image upside down to accommodate ceiling-mounted projection.

▶  **Rear-Ceiling**

When you select this function, the projector reverses and turns the image upside down at same time. You can display an image from behind a translucent screen with ceiling mounted projection.

Signal Type

Select signal type RGB or Video surces.

Edge Mask

Choose “On” to mask off a few pixels on each edge of the image to be displayed. Use Edge Mask “On” if image source happens to have encoding error near any edge of the displayable image.

Image Shift

Shifts the projected image position vertically. 0 is middle of the screen. You can be stored to preset values by selecting either preset memory 1 or 2 or OFF before adjusting image.



❖ The “Edge Mask” sub menu is supported only when the “Full Screen Zoom” select to “Normal”.

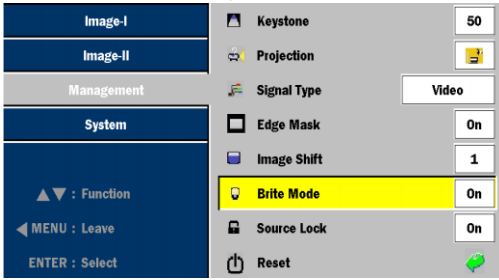

Management

Source Lock

When source lock is turned off, the projector will search for other signals if the current input signal is lost. When source lock is turned on, it will show “No Signal” on the screen and keeps searching for the current input signal.

Brite Mode

Choose “On” to increase light output. Choose “Off” to return normal mode.

Reset

Return the adjustments and settings to the factory default values.

- ▶ Current: Returns the current menu’s settings to factory default values.
- ▶ All: Returns the settings for all menus to factory default values.
- ▶ Exit: Cancel the revised settings.

User Controls

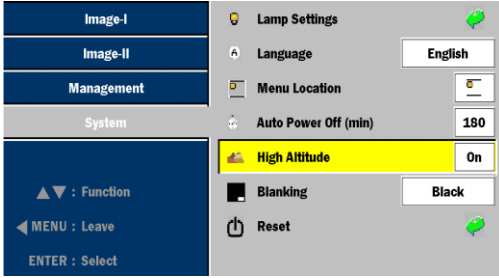

System

Lamp Settings

- ▶ Lamp Hour: Displays the cumulative lamp operating time.
- ▶ Lamp Reset: Reset the lamp setting only when the new lamp is replaced.
- ▶ Lamp Reminding: Choose this function to show or to hide the warning message when the changing lamp message is displayed. The message will show up 30 hours before end of life.

Language

Choose the multilingual OSD menu . Use the ◀ or ▶ key to select your preferred language.

Press **Enter** to finalize the selection.

Menu Location

Choose the menu location on the display screen.

Auto Power Off (min)

Sets the interval of power-off of the system, if there is no signal input. (In minutes)

High Altitude

Choose "ON" to turn on High Altitude mode. Operates the fans at full speed continuously to allow for proper high altitude cooling of the projector.

Blanking

Use this feature to display a black or blue screen when no signal is available.

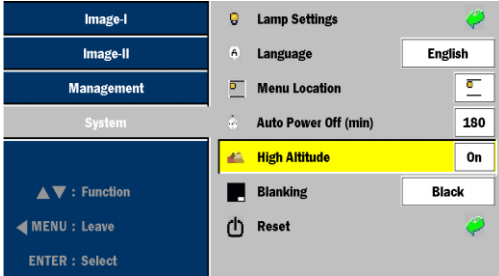

System

Reset

Return the adjustments and settings to the factory default values.

- ▶ Current: Returns the current menu's settings to factory default values.
- ▶ All: Returns the settings for all menus to factory default values.
- ▶ Exit: Cancel the revised settings.

Troubleshooting

If you experience trouble with the projector, please refer to the following information (listed below). If the problem persists, contact your local reseller or service center immediately.

Problem: No image appears on screen.

- ▶ Ensure that all cables and power connections are correctly and securely connected as described in the “Installation” section.
- ▶ Ensure that the pins of connectors are not crooked or broken.
- ▶ Check to see if the projection lamp has been securely installed. Please refer to the “Replacing the Lamp” section for more information.
- ▶ Make sure that you have removed the lens cap and that the projector is powered on.
- ▶ Ensure that the “Hide” feature is not turned on.

Problem: Partial, scrolling or incorrectly displayed images

- ▶ Press “Re-Sync” on the Remote Control or press “Auto Image” on the Control Panel.
- ▶ If you are using a PC:

For Windows 3.x:

1. In the Windows Program Manager, double click the “Windows Setup” icon in the Main group.
2. Verify that your display resolution setting is less than or equal to 1280 x 1024.

For Windows 95, 98, 2000, XP:

1. From the “My Computer” icon, open the “Control Panel” folder, and double click the “Display” icon.
2. Select the “Settings” tab
3. Click on the “Advanced Properties” button.

If the projector is still not displaying the entire image, you may need to change the monitor display that you are using. Refer to the following steps.

4. Verify the resolution setting is less than or equal to 1280 x 1024 resolution.
 5. Select the “Change” button under the “Monitor” tab .
 6. Click on “Show all devices.” Next, select “Standard monitor types” under the SP box; choose the resolution mode you need under the “Models” box.
 7. Verify that the resolution setting of the monitor display is less than or equal to 1280 x 1024.
- ▶ If you are using a Notebook PC:
 1. First, follow the steps above to adjust resolution of the computer.
 2. Switch the Notebook PC display to the “external display only” or “CRT only” mode.
 - ▶ If you experience difficulty changing resolutions or your monitor freezes, restart all equipment including the projector.

Problem: The screen of the Notebook or PowerBook computer is not displaying a presentation.

- ▶ If you are using a Notebook PC:

Some Notebook PCs may deactivate their own screens when a second display device is in use. Each has a different way to be reactivated. Refer to your computer’s documentation for detailed information.

Problem: Image is unstable or flickering

- ▶ Use “Tracking” to correct it. See page 24 for more information.
- ▶ Change the monitor color setting or the frequency on your computer.

Problem: Image has vertical flickering bar

- ▶ Use “Frequency” to make an adjustment. See page 24 for more information.
- ▶ Check and reconfigure the display mode of your graphics card to ensure compatibility.

Problem: Image is out of focus

- ▶ Adjusts the Focus Ring on the projector lens. Refer to page 14.
- ▶ Make sure the projection screen is between the required distance 4.9 to 40.7 feet (1.5 to 12.5 meters) from the projector.









Problem: Image is reversed.

- ▶ Press “Menu”, then select “Management” to adjust the projection mode.

Problem: Lamp burns out or makes a popping sound

- ▶ When the lamp reaches its end of life, it will burn out and may make a loud popping sound. If this happens, the projector will not turn back on until the lamp module has been replaced. To replace the lamp, follow the procedures in “Replacing the Lamp” page 35.

Problem: LED lighting message

Message	Power LED Green	Temp LED	Lamp LED
Standby State (Input power cord)	Flashing	○	○
Lamp lighting		○	○
Power on		○	○
Power off (Cooling)		○	○
Error (Lamp fail)	○	○	
Error (Thermal fail)			○
Error (Fan fail)	○	Flashing	○
Error (Over Temp.)	○		○
Error (Lamp Breakdown)	○	○	

Problem: Message Reminders

- ▶ “Lamp is approaching the end of its useful life in full power operation. Replacement Suggested!” will be shown about 10 seconds, when lamp is nearing end of life.
- ▶ “Projector Overheated. Lamp will automatically turn off soon.” will be shown when the system temperature is too high.
- ▶ “Fan fail. Lamp will automatically turn off soon.” will be shown when the fan is out of order.

Replacing the Lamp

The projector will detect the lamp life itself. It will show you a warning message “Lamp may fail soon ! Replacement Suggested !” When you see this message, please contact your local reseller or service center.



Warning: Lamp compartment is hot! Allow it to cool down before replacing lamp!

Make sure the projector has cooled down for at least 30 minutes before replacing the lamp.

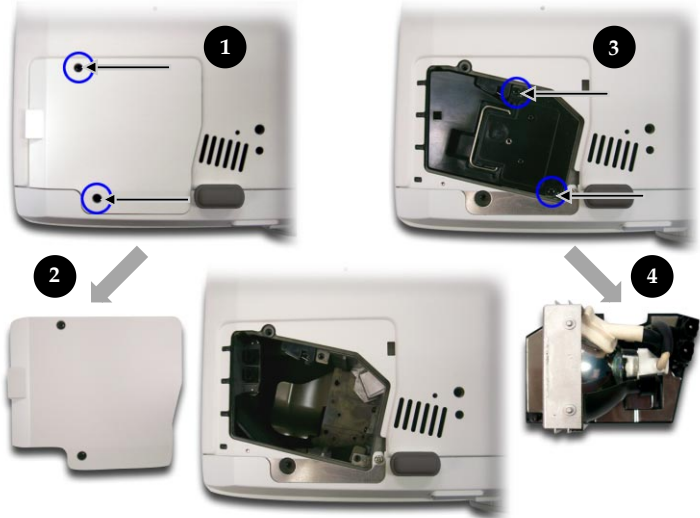

Warning: To reduce the risk of personal injury, avoid dropping the lamp module or touching the lamp bulb. If dropped, the bulb may shatter and cause injury.

Lamp Replacing Procedure:

1. Switch off the power to the projector by pressing the Power button.
2. Allow the projector to cool down at least 30 minutes.
3. Disconnect the power cord.
4. Use a screwdriver to remove the screw from the cover. ❶
5. Push up and remove the cover. ❷
6. Remove the 2 screws from the lamp module. ❸
7. Pull out the lamp module. ❹

To replace the lamp module, reverse the previous steps.

Ceiling Mount Installation

1. To prevent damaging your projector, please use the ceiling mount package for installation.
2. If you wish to use a third party ceiling mount kit, please ensure the screws used to attached a mount to the projector met the following specifications:



❖ Please note that damage resulting from incorrect installation will invalidate the warranty.

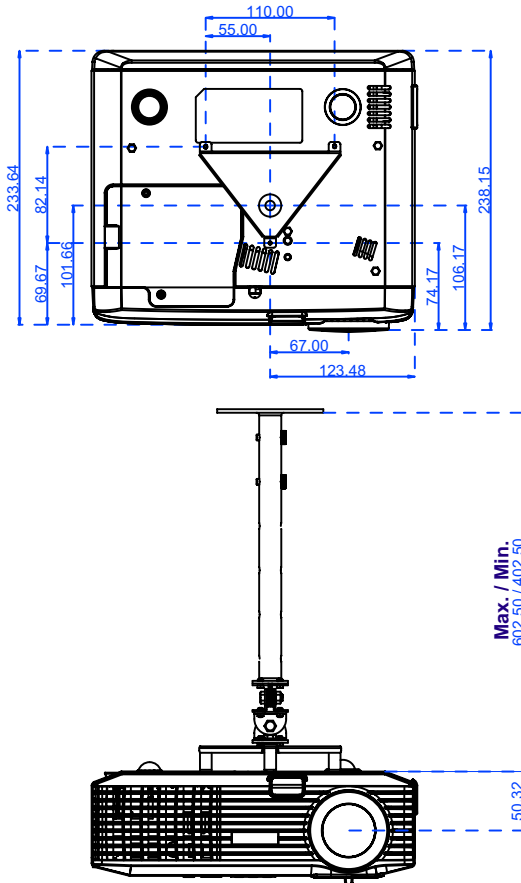

Throw Angle

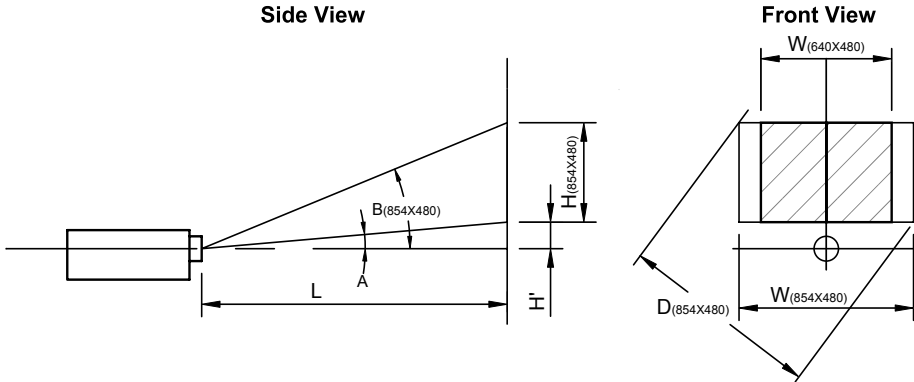

Throw Ratio (TR) = 1.87 as Wide mode

$$A = 9.23^\circ$$

$$B \text{ (854 x 480)} = 24.86^\circ$$

$$W \text{ (854 x 480)} = L / \text{TR}$$

$$W \text{ (640 x 480)} = W \text{ (854 x 480)} \times 0.75$$

$$H' = L \times \tan(A)$$

$$H \text{ (854 x 480)} = W \text{ (854 x 480)} \times 0.5625,$$

$$H \text{ (640 x 480)} = W \text{ (640 x 480)} \times 0.75$$

Display Format		A	B	L (cm)	W (cm)	H (cm)	H' (cm)	D (cm)	D (in)
16:9	854 x 480	9.23	24.86	244.00	130.48	73.40	39.64	149.70	58.94
4:3	640 x 480	9.23	24.86	244.00	97.86	73.40	39.64	122.30	48.15