

***myprojectorlamps.com***

**The most trusted, dependable name  
in projector lamp sales.**



<http://www.myprojectorlamps.com>



<http://www.myprojectorlamps.ca>





<http://www.myprojectorlamps.eu>

The following projector manual has not been modified or altered in any way.

# Table of Contents

Table of Contents .....	1
Usage Notice.....	2
Safety Information .....	2
Precautions.....	3
Eye Safety Warnings .....	5
Introduction.....	6
Product Features .....	6
Package Overview.....	7
Product Overview .....	8
Main Unit.....	8
Control Panel .....	9
Connection Ports .....	10
Remote Control.....	11
Installation .....	12
Connecting the Projector .....	12
Connect to Computer/Notebook .....	12
Connect to Video Sources .....	14
Powering On/Off the Projector.....	16
Powering On the Projector.....	16
Powering Off the projector .....	17
Warning Indicator.....	17
Adjusting the Projected Image.....	18
Adjusting the Projector's Height.....	18
Adjusting the Projector's Zoom / Focus .....	19
Adjusting Projected Image Size .....	19
User Controls .....	20
Control Panel & Remote Control .....	20
On-screen Display Menus .....	23
How to operate .....	23
Menu Tree.....	24
Image .....	25
Display .....	29
Setup.....	32
Options.....	38
Appendices.....	41
Troubleshooting.....	41
Image Problems .....	41
Intermission Problems .....	44
Projector Status Indication .....	44
Remote Control Problems .....	46
Replacing the Lamp.....	47
Compatibility Modes .....	49
RS232 Commands .....	50
Ceiling Mount Installation .....	53
Optoma Global Offices .....	54
Regulation & Safety notices .....	56

## Safety Information

	The lightning flash with arrow symbol within an equilateral triangle is intended to alert the user to the presence of uninsulated "dangerous voltage" within the product's enclosure that may be of sufficient magnitude to constitute a risk of electric shock to persons.
	The exclamation point within an equilateral triangle is intended to alert the user to the presence of important operating and maintenance (servicing) instructions in the literature accompanying the appliance.

WARNING: TO REDUCE THE RISK OF FIRE OR ELECTRIC SHOCK, DO NOT EXPOSE THE PROJECTOR TO RAIN OR MOISTURE. DANGEROUS HIGH VOLTAGES ARE PRESENT INSIDE THE ENCLOSURE. DO NOT OPEN THE CABINET. REFER SERVICING TO QUALIFIED PERSONNEL ONLY.

### Class B emissions limits

This Class B digital apparatus meets all requirements of the Canadian Interference-Causing Equipment Regulations.

### Important Safety Instruction

1. Read these instructions -before using this projector.
  2. Keep these instructions -for future reference.
  3. Follow all instructions.
  4. Install in accordance with the manufacturer's instructions :
    - A. Do not block any ventilation openings.** To ensure reliable operation of the projector and to protect it from overheating, put the projector in a position and location that will not interfere with its proper ventilation. For example, do not place the projector on a bed, sofa, carpet, or similar surface that may block the ventilation openings. Do not put it in an enclosure, such as a bookcase or a cabinet that may keep air from flowing through its ventilation openings.
    - B. Do not use this projector near water or moisture.** To reduce the risk of fire or electric shock, do not expose the projector to rain or moisture.
    - C. Do not install near any heat sources,** such as radiators, heaters, stoves or other apparatus (including amplifiers) that produce heat.
  5. Clean only with a dry cloth.
  6. Only use attachments/accessories specified by the manufacturer.
  7. Refer all servicing to qualified service personnel. Servicing is required when the projector has been damaged in any way:
    - Such as power supply cord or plug is damaged.
    - Liquid has been spilled or objects have fallen into the apparatus.
    - The projector has been exposed to rain or moisture, does not operate normally, or has been dropped.
- Do not attempt to service this projector yourself. Opening or removing covers may expose you to dangerous voltages or other hazards. Please call Optoma to be referred to an authorized service center near you.
8. Do not let objects or liquids enter the projector -as they may touch dangerous voltage points or short-out parts that could result in a fire or electric shock.
  9. See projector enclosure for safety related markings.
  10. The projector should not be adjusted or repaired by anyone except properly qualified service personnel.

## Precautions



*Please follow all warnings, precautions and maintenance as recommended in this user's guide.*

- Warning- Do not look into the projector's lens when the lamp is on. The bright light may damage your eyes.
- Warning- To reduce the risk of fire or electric shock, do not expose this projector to rain or moisture.
- Warning- Please do not open or disassemble the projector as this may cause electric shock.
- Warning- When replacing the lamp, please allow unit to cool down, and follow all replacement instructions. See pages 47-48.
- Warning- This projector will detect the life of the lamp itself. Please be sure to change the lamp when it shows warning messages.
- Warning- Use the "Lamp Reset" function from the on-screen display "Options | Lamp Settings" menu after replacing the lamp module (refer to page 40).
- Warning- When switching the projector off, please ensure the cooling cycle has been completed before disconnecting the power. Allow 90 seconds for the projector to cool down.
- Warning- Do not close the lens door when projector is in operation.
- Warning- When the lamp is approaching to the end of its life time, the message "Lamp Warning: Lamp life exceeded." will show on the screen. Please contact your local reseller or service center to change the lamp as soon as possible.
- Warning- To reduce the risk of injury to the eyes, do not look directly into the laser beam on the remote control and do not point the laser beam into anyone's eyes. This remote control is equipped with a Class II laser that emits radiation.



- ❖ When the lamp reaches the end of its life, the projector will not turn back on until the lamp module has been replaced. To replace the lamp, follow the procedures listed under "Replacing the Lamp" section on pages 47-48.

# Usage Notice

## **Do:**

- ❖ Turn off the product before cleaning.
- ❖ Use a soft cloth moistened with a mild detergent to clean the display housing.
- ❖ Disconnect the power plug from the AC outlet if the product is not being used for a long period of time.

## **Don't:**

- ❖ Do not block the ventilation slots and openings on the unit.
- ❖ Do not use abrasive cleaners, waxes or solvents to clean the unit.
- ❖ Do not use under the following conditions:
  - In extremely hot, cold or humid environments.
  - In areas susceptible to excessive dust and dirt.
  - Near any appliance that generates a strong magnetic field.
  - In direct sunlight.

## Eye Safety Warnings



- ■ Avoid staring directly into the projector's beam of light at all times.
- ■ Minimize standing facing into the beam. Keep your back to the beam as much as possible.
- ■ Using a stick or laser pointer is recommended to avoid the need for the presenter to enter the beam.
- ■ Ensure that projectors are located out of the line of sight from the screen to the audience; this ensures that, when presenters look at the audience, they do not also have to stare at the projector lamp. The best way to achieve this is by ceiling-mounting the projector rather than placing it on floor or table top.
- ■ When projector is used in a classroom, adequately supervise students when they are asked to point out something on the screen.
- ■ In order to minimize the lamp power needed, use room blinds to reduce ambient light levels.

## Product Features

*This product is a XGA single chip 0.55" DLP® projector.  
Outstanding features include:*

- ◆ True XGA, 1024 x 768 addressable pixels
- ◆ Texas Instruments Single chip DLP® Technology
- ◆ NTSC/NTSC4.43/PAL/PAL-M/PAL-N/SECAM and HDTV compatible (480i/p, 576i/p, 720p, 1080i)
- ◆ Auto source detection with user definable settings
- ◆ Full function IR remote mouse control with laser pointer
- ◆ User friendly multilingual On Screen Menu
- ◆ Advanced digital keystone correction and high quality full screen image re-scaling
- ◆ User friendly control panel
- ◆ One built-in speaker with 2 Watt amplifier
- ◆ 4 dedicated audio inputs
- ◆ WXGA, SXGA, SXGA+ compression and VGA, SVGA re-sizing
- ◆ Macintosh and PC compatible
- ◆ DVI-D support (HDCP compliant)

# Introduction

## Package Overview

*This projector comes with all the items shown below. Check to make sure your unit is complete. Contact your dealer immediately if anything is missing.*



Projector



Power Cord 1.8m



VGA Cable 1.8m



USB Cable 1.8m



IR Remote Control



Carrying Case



❖ Due to the difference in applications for each country, some regions may have different accessories.



2 x AAA Batteries

### Documentation :

- User's Manual
- Warranty Card
- Quick Start Card
- WEEE Card



# Introduction

## Product Overview

### Main Unit



- |                    |                          |
|--------------------|--------------------------|
| 1. Control Panel   | 7. Elevator foot         |
| 2. Zoom            | 8. IR Receivers          |
| 3. Focus           | 9. Connection Ports      |
| 4. Zoom Lens       | 10. Power Socket         |
| 5. Lens door       | 11. Tilt-Adjustment Feet |
| 6. Elevator Button |                          |

# Introduction

## Control Panel

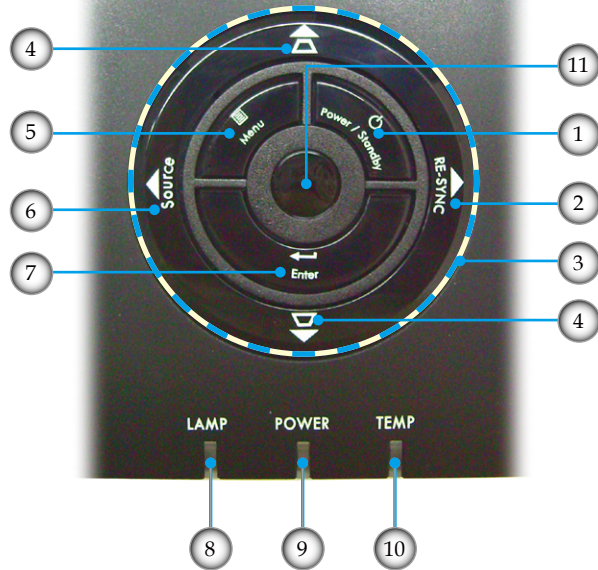

1. Power/Standby
2. Re-Sync
3. Four Directional Select Keys
4. Keystone Correction
5. Menu
6. Source
7. Enter
8. Lamp LED
9. Power LED
10. Temp LED
11. IR Receiver

# Introduction

## Connection Ports

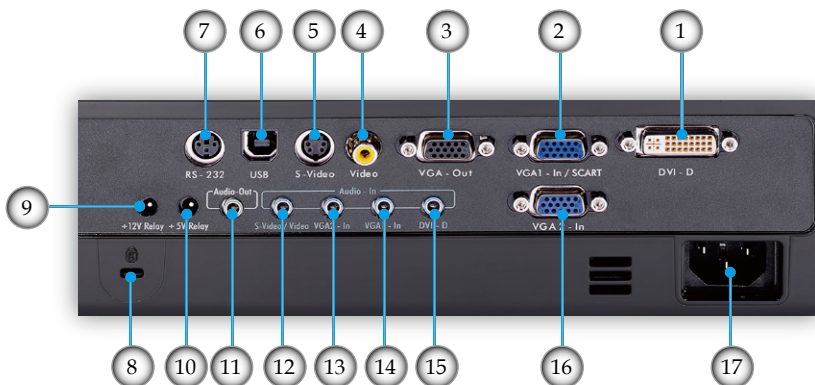

1. DVI-D Input Connector (PC Digital and HDCP)
2. VGA1-In/ SCART Connector (PC Analog Signal/ Component Video Input, HDTV/SCART Input)
3. VGA-Out Connector (Monitor Loop-through Output)
4. Composite Video Input Connector
5. S-Video Input Connector
6. USB Connector (Connect to PC for Remote Mouse function)
7. RS-232 Connector
8. Kensington™ Lock Port
9. +12V Relay Connector
10. +5V Relay Connector
11. Audio-Out Connector
12. Audio-In (for S-Video/Video Connector)
13. Audio-In (for VGA2-In Connector)
14. Audio-In (for VGA1-In Connector)
15. Audio-In (for DVI-D Connector)
16. VGA2-In Connector (PC Analog Signal/Component Video Input/HDTV)
17. Power Socket

# Introduction

## Remote Control

1. Button LED
2. Power On/Off
3. Laser Button
4. Page Up
5. Mouse Right Click
6. Four Directional Select Keys
7. Re-Sync
8. Re-Sync
9. Volume +/-
10. Zoom
11. AV mute
12. Video Source
13. VGA-2 Source
14. VGA-1 Source
15. S-Video Source
16. DVI-D Source
17. Brightness
18. Menu
19. Keystone +/-
20. Source
21. Enter
22. Mouse Left Click
23. PC/Mouse control



# Installation

## Connecting the Projector

### Connect to Computer/Notebook/DVI

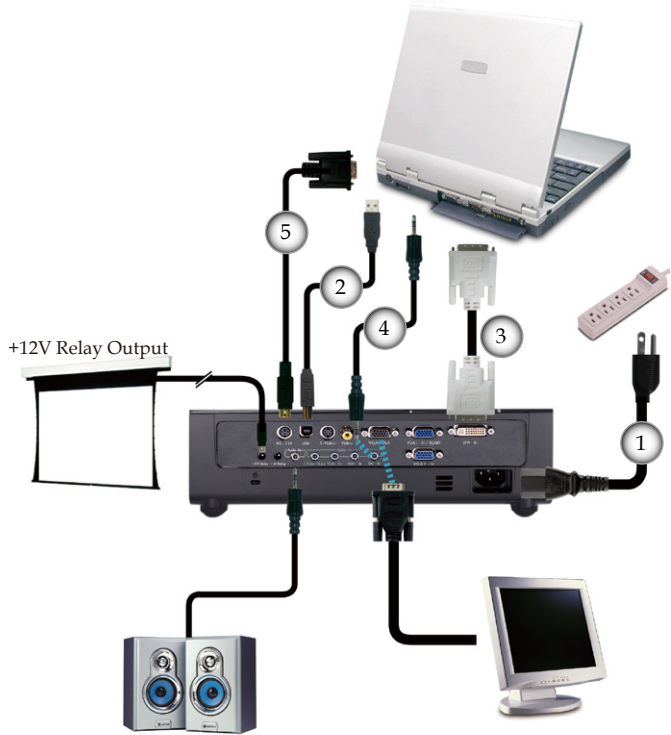

❖ Due to the difference in applications for each country, some regions may have different accessories.

- 1.....Power Cord
- 2..... USB Cable
- 3..... DVI Cable (Optional Accessory)
- 4..... Audio Input Cable (Optional Accessory)
- 5..... RS232 Cable (Optional Accessory)

# Installation

## Connect to Computer/Notebook/VGA-In

### VGA1-In



### VGA2-In

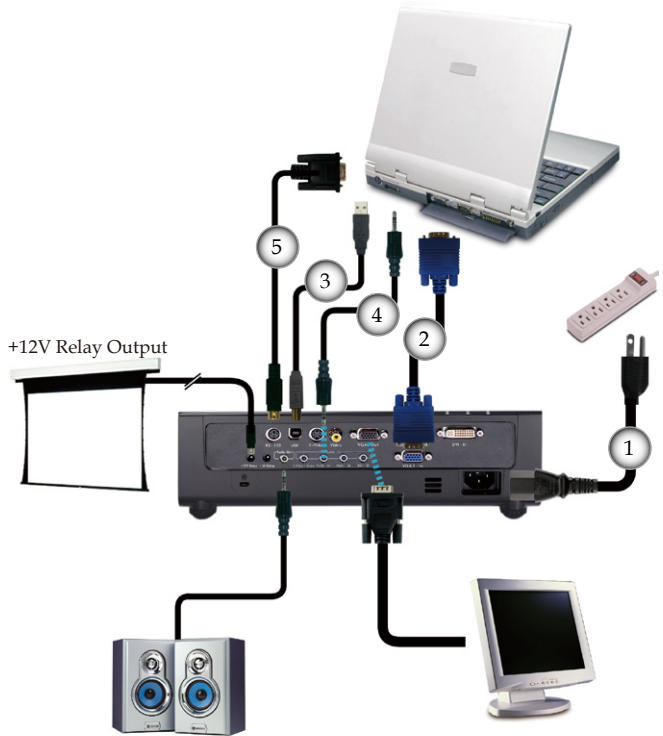

❖ Due to the difference in applications for each country, some regions may have different accessories.

- 1.....Power Cord
- 2.....VGA Cable
- 3.....USB Cable
- 4.....Audio Input Cable (Optional Accessory)
- 5.....RS232 Cable (Optional Accessory)

# Installation

## Connect to Video/DVI, VGA2-In

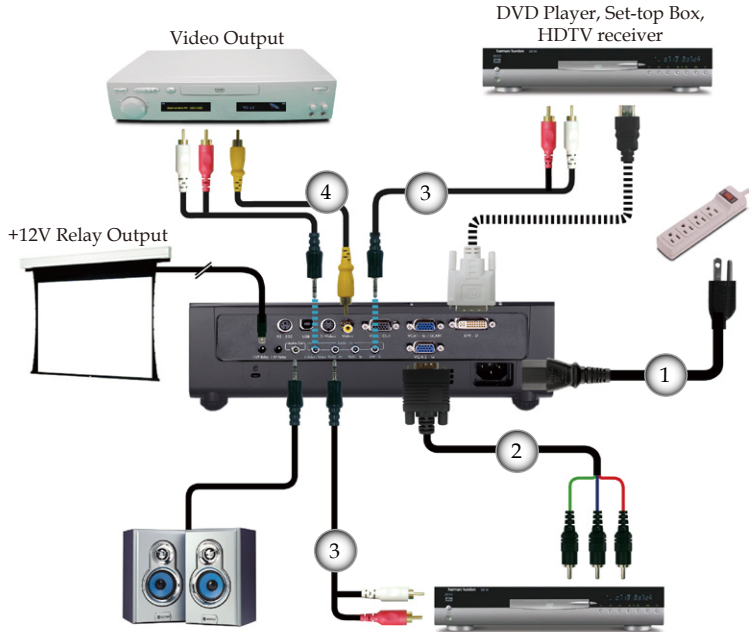

❖ Due to the difference in applications for each country, some regions may have different accessories.

- 1.....Power Cord
- 2....D-Sub to RCA Cable for HDTV/Component Cable (Optional Accessory)
- 3.....Audio Input Cable (Optional Accessory)
- 4.....Composite Video Cable (Optional Accessory)

# Installation

## Connect to Video/VGA1-In/SCART

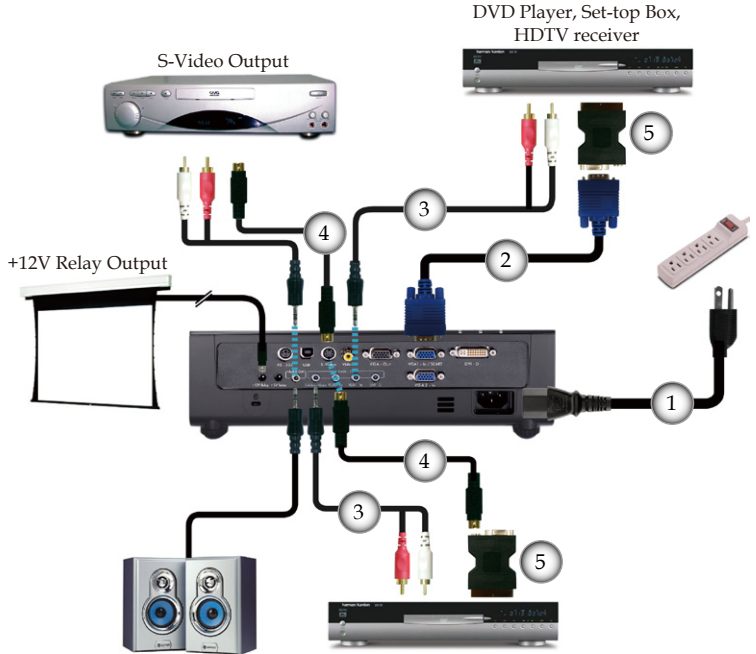

❖ Due to the difference in applications for each country, some regions may have different accessories.

- |        |  |
|--------|--|
| 1..... | Power Cord                                     |
| 2..... | VGA Cable                                      |
| 3..... | Audio Input Cable (Optional Accessory)         |
| 4..... | S-Video Cable (Optional Accessory)             |
| 5..... | SCART RGB/S-Video Adaptor (Optional Accessory) |



# Installation

## Powering On/Off the Projector

### Powering On the Projector

1. Open the lens door. ❶
2. Ensure that the power cord and signal cable are securely connected. ❷ The Power LED will be Amber.
3. Turn on the lamp by pressing “Power/Standby” button either on the top of the projector or on the remote. The Power LED will flash green.

The startup screen will display in approximately 10 seconds. The first time you use the projector, you can select your preferred language from quick menu after the startup screen display.

4. Turn on your source (computer, notebook, video player, etc.). The projector will detect your source automatically.
- ❖ If you connect multiple sources at the same time, press the “Source” button on the control panel or direct source key on the remote control to switch between inputs.

❷ Power/Standby

❶ Lens Door

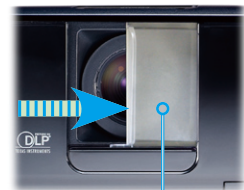

Power LED



- ❖ Turn on the projector first and then select the signal sources.



## Powering Off the Projector

1. Press the “Power/Standby” button to turn off the projector lamp, you will see a message displayed on the projector’s screen.

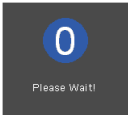
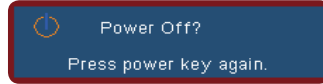

2. Press the “Power/Standby” button again to confirm, otherwise the message will disappear after 15 seconds. When you press “Power/Standby” button second, the system will show the timing countdown on the screen.
3. The cooling fans continue to operate for about 10 seconds for cooling cycle. When the Power LED turn Amber, the projector has entered standby mode.  
If you wish to turn the projector back on, you must wait until the projector has completed the cooling cycle and has entered standby mode. Once in standby mode, simply press “Power/Standby” button to restart the projector.
4. Disconnect the power cord from the electrical outlet and the projector.
5. Do not turn on the projector immediately following a power off procedure.

## Warning Indicator

- ❖ When the “LAMP” indicator lights red, the projector will automatically shut itself down. Please contact your local reseller or service center. See pages 54-55.
- ❖ When the “TEMP” indicator lights red, it indicates the projector has overheated. The projector will automatically shut itself down.  
Under normal conditions, the projector can be switched on again after it has cooled down. If the problem persists, you should contact your local dealer or our service center. See pages 54-55.
- ❖ When the “LAMP” indicator flashes red, it indicates the fan has failed. Please contact your local dealer or our service center. See pages 54-55.

## Adjusting the Projected Image

### Adjusting the Projector's Height

*The projector is equipped with elevator feet for adjusting the image height.*

To raise the image:

1. Press the elevator button **1**.
2. Raise the image to the desired height angle **2**, then release the button to lock the elevator feet into position.
3. Use screw in feet **3** to fine-tune the display angle.

To lower the image:

1. Press the elevator button.
2. Lower the image, then release the button to lock the elevator feet into position.
3. Use screw in feet **3** to fine-tune the display angle.

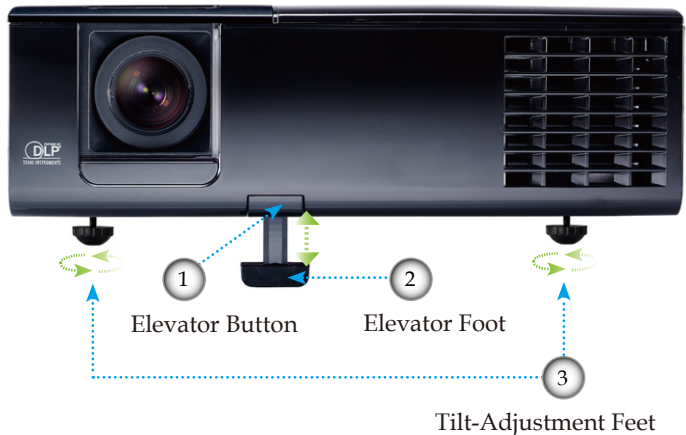

# Installation

## Adjusting the Projector's Zoom / Focus

You may turn the zoom lever to zoom in or out. To focus the image, rotate the focus ring until the image is clear. The projector will focus at distances from 3.9 to 39.4 feet (1.2 to 12.0 meters).



## Adjusting Projection Image Size

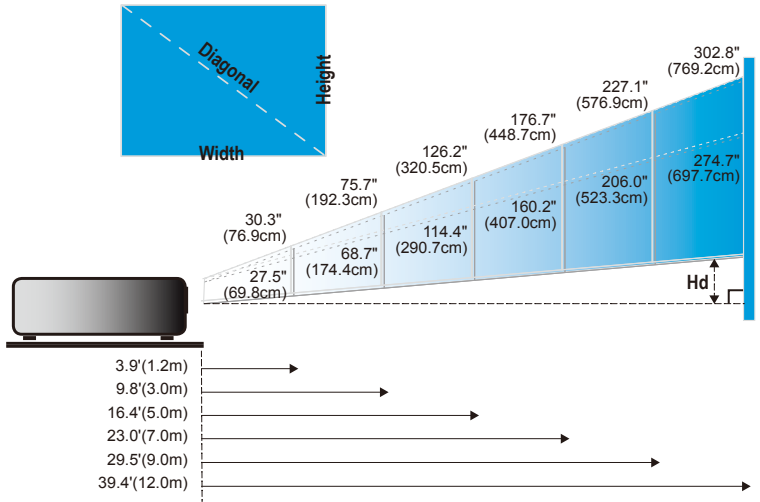

Screen (Diagonal)	Max.	30.3" (76.9cm)	75.7" (192.3cm)	126.2" (320.5cm)	176.7" (448.7cm)	227.1" (576.9cm)	302.8" (769.2cm)
	Min.	27.5" (69.8cm)	68.7" (174.4cm)	114.4" (290.7cm)	160.2" (407.0cm)	206.0" (523.3cm)	274.7" (697.7cm)
Screen Size	Max. (WxH)	24.2" x 18.2" 61.5 x 46.2cm	60.6" x 45.4" 153.8 x 115.4cm	100.9" x 75.7" 256.4 x 192.3cm	141.3" x 106.0" 359.0 x 269.2cm	181.7" x 136.3" 461.5 x 346.2cm	242.3" x 181.7" 615.4 x 461.5cm
	Min. (WxH)	22.0" x 16.5" 55.8 x 41.9cm	54.9" x 41.2" 139.5 x 104.7cm	91.6" x 68.7" 232.6 x 174.4cm	128.2" x 96.1" 325.6 x 244.2cm	164.8" x 123.6" 418.6 x 314.0cm	219.7" x 164.8" 558.1 x 418.6cm
Hd	Max.	3.57" (9.07cm)	8.93" (22.7cm)	14.88" (37.8cm)	20.83" (52.9cm)	26.78" (68.0cm)	35.71" (90.7cm)
	Min.	2.73" (6.9cm)	6.81" (17.3cm)	11.36" (28.8cm)	15.90" (40.4cm)	20.44" (51.9cm)	27.26" (69.2cm)
Distance		3.9' (1.2m)	9.8' (3.0m)	16.4' (5.0m)	23.0' (7.0m)	29.5' (9.0m)	39.4' (12.0m)

❖ This graph is for user's reference only.

# User Controls

## Control Panel & Remote Control

There are two ways for you to control the functions:  
Control Panel and Remote Control.

### Control Panel



#### Using the Control Panel

Power/Standby	Refer to the "Power On/Off the Projector" section on pages 16-17.
Menu	Press "Menu" to launch the on-screen display (OSD) menu. To exit OSD, Press "Menu" again.
Enter	Confirm your item selection.
Source	Press "Source" to select an input signal.
Re-Sync	Automatically synchronizes the projector to the input source.
Keystone ▽/△	Adjusts image distortion caused by tilting the projector (±16 degrees)
Four Directional Select Keys	Use ▲ ▼ ◀ ▶ to select items or make adjustments to your selection.

# User Controls

## Remote Control



### Using the Remote Control

**Power**  Refer to the "Power On/Off the Projector" section on pages 16-17.

**Laser**  Aim the remote at the viewing screen, press and hold this button to activate the laser pointer.

**PC/Mouse control** The PC/Mouse control can be used to control mouse movement. The mouse function is enabled using the USB cable to connect your computer and the projector.

**L Button** Mouse left click.

**R Button** Mouse right click.

**Page +** Use this button to page up.

**Page -** Use this button to page down.

**Enter**  Confirm your item selection.

**Source** Press "Source" to select an input signal.

**Re-Sync** Automatically synchronizes the projector to the input source.

**Four Directional Select Keys** Use  to select items or make adjustments to your selection.

**Keystone +/-** Adjusts image distortion caused by tilting the projector.

**Volume +/-** Adjusts to increase/decrease the volume.

**Brightness** Adjust the brightness of the image.

# User Controls

## Remote Control



### Using the Remote Control

Menu	Press "Menu" to launch the on-screen display (OSD) menu. To exit OSD, Press "Menu" again.
Zoom	Press "+/-" button to zoom in of an image.
DVI-D	Press "DVI-D" to choose DVI-D source.
VGA-1	Press "VGA-1" to choose source from VGA1-In/SCART connector.
AV Mute	Momentarily turns off/on the audio and video.
S-Video	Press "S-Video" to choose S-Video source.
VGA-2	Press "VGA-2" to choose source from VGA2-In connector.
Video	Press "Video" to choose Composite video source.



## On-screen Display Menu

The Projector has multilingual On-screen Display menus that allow you to make image adjustments and change a variety of settings. The projector will automatically detect the source.

### How to operate

1. To open the OSD menu, press “Menu” on the Remote Control or Projector Keypad.
2. When OSD is displayed, use ◀▶ keys to select any item in the main menu. While making a selection on a particular page, press ▼ or “Enter” key to enter sub menu.
3. Use ▲▼ keys to select the desired item and adjust the settings by ◀▶ key.
4. Select the next item to be adjusted in the sub menu and adjust as described above.
5. Press “Enter” to confirm, and the screen will return to the main menu.
6. To exit, press “Menu” again. The OSD menu will close and the projector will automatically save the new settings.

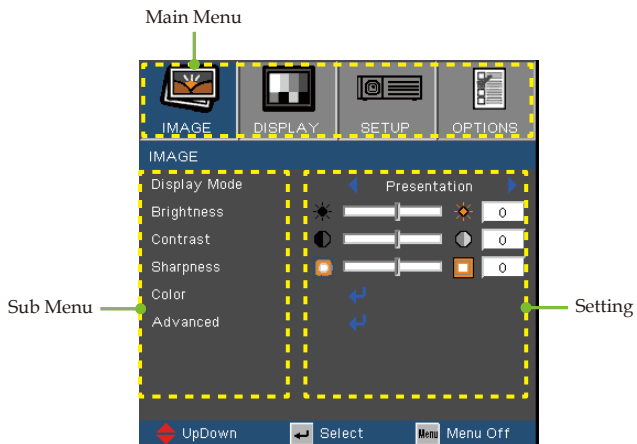



# User Controls

## Menu Tree

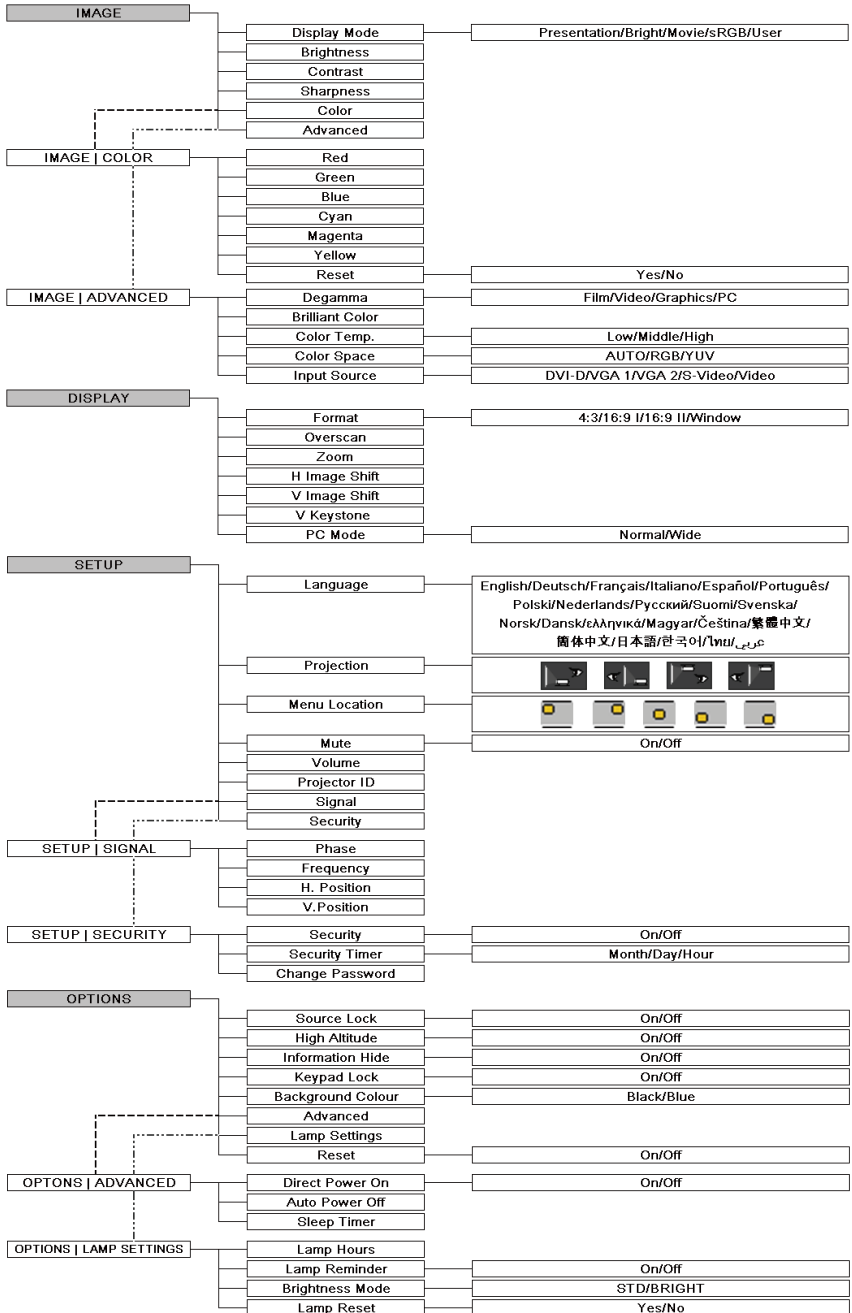

## Image

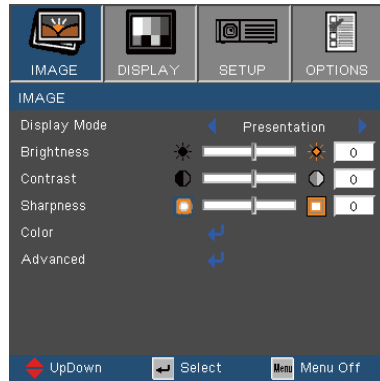

### Display Mode

There are many factory presets optimized for various types of images.

- ▶ Presentation: Good colour and brightness from PC input.
- ▶ Bright: Maximum brightness from PC input.
- ▶ Movie: For home theater.
- ▶ sRGB: Standardised accurate colour.
- ▶ User: User's own settings.

### Brightness

Adjust the brightness of the image.

- ▶ Press the ◀ to darken image.
- ▶ Press the ▶ to lighten the image.

### Contrast

The contrast controls the degree of difference between the lightest and darkest parts of the picture. Adjusting the contrast changes the amount of black and white in the image.

- ▶ Press the ◀ to decrease the contrast.
- ▶ Press the ▶ to increase the contrast.

### Sharpness

Adjusts the sharpness of the image.

- ▶ Press the ◀ to decrease the sharpness.
- ▶ Press the ▶ to increase the sharpness.

## Image | Color

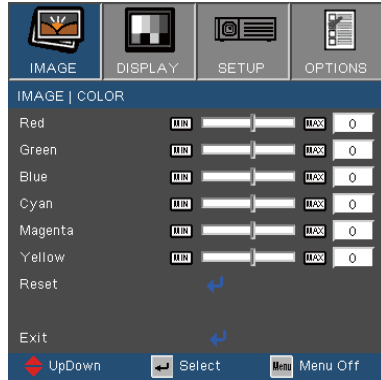

### Color

Adjusts the Red, Green, Blue, Cyan, Magenta and Yellow colors or returns to the factory default settings for advanced adjustment of the individual colors.

## Image | Advanced

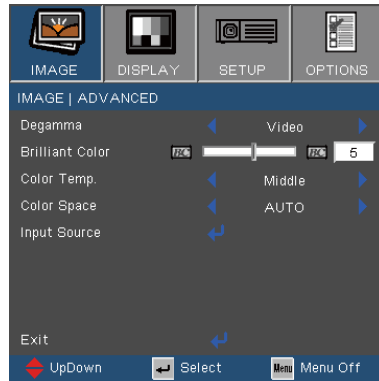

### Degamma

This allows you to choose a degamma table that has been fine-tuned to bring out the best image quality for the input.

- ▶ Film: for home theater.
- ▶ Video: for video or TV source.
- ▶ Graphics: for image source.
- ▶ PC: for PC or computer source.

### Brilliant Color

This adjustable item utilizes a new color-processing algorithm and system level enhancements to enable higher brightness while providing true, more vibrant colors in picture. The range is from "0" to "10". If you prefer a stronger enhanced image, adjust toward the maximum setting. For a smoother, more natural image, adjust toward the minimum setting.

### Color Temp.

Adjust the color temperature. With high temperature, the screen looks colder; with low temperature, the screen looks warmer.

### Color Space

Select an appropriate color matrix type from AUTO, RGB, YUV.

## Image | Advanced

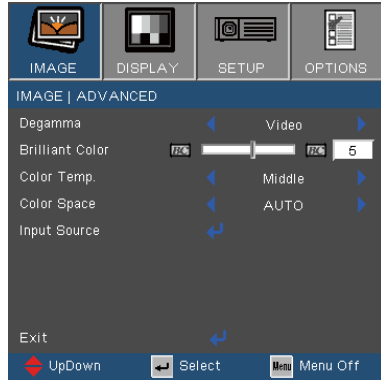

### Input Source

Enable input sources. Press ◀ or ▶ into the next menu as below and then use ▲ or ▼ to select. Press “Enter” to finalize the selection. The projector will not search inputs that are de-selected.

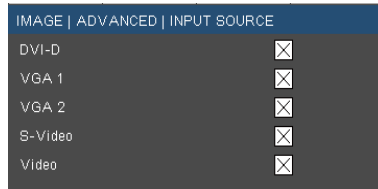

## Display

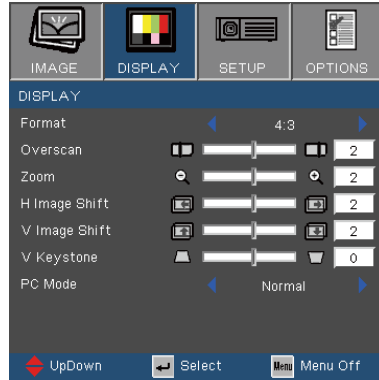

### Format

Use this function to choose your desired aspect ratio.

- ▶ 4:3: This format is for 4x3 input sources not enhanced for Wide screen TV.
- ▶ 16:9 I: This format is for 16x9 input sources, like HDTV and DVD enhanced for Wide screen TV.
- ▶ 16:9 II: The non-standard wide-screen display format of the projector. Part of the original image will be cut if the image aspect ratio is less than 1.67:1.
- ▶ Window: When a 4:3 image is bigger than a 16:9 screen, select the "Window" mode to fit the image onto the screen without changing the projection distance.

Source	480i/p	576i/p	720p	1080i	PC
4:3	Scale to 1024 x 768				
16:9 I	Scale to 1024 x 576				
16:9 II	Scale to 854 x 480				
Window	Scale to 800 x 600				

# User Controls

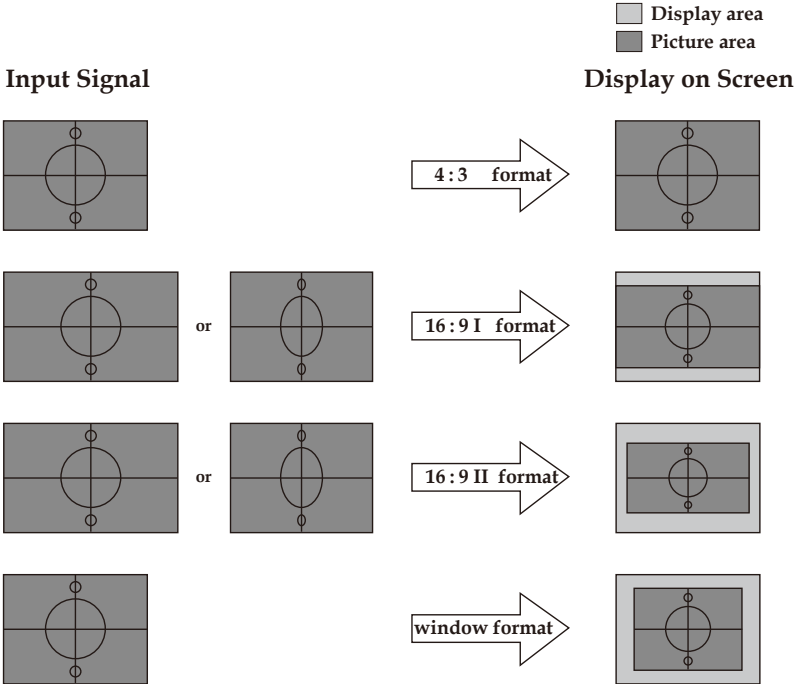

## Display

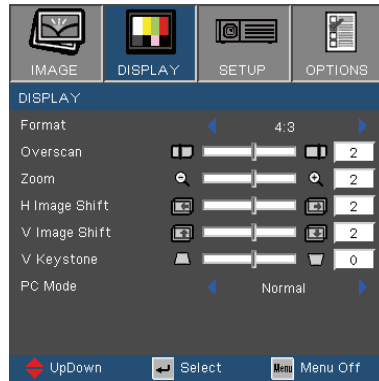

### Overscan

Overscan function removes the noise in a video image. Overscan the image to remove video encoding noise on the edge of video source.

### Zoom

- ▶ Press the ◀ to reduce the size of an image.
- ▶ Press the ▶ to magnify an image on the projection screen.

### H Image Shift

Shifts the projected image position horizontally.

### V Image Shift

Shifts the projected image position vertically.

### V Keystone

Press the ◀ or ▶ to adjust image distortion vertically and makes a squarer image.

### PC Mode

This mode is only functional when the projector unit is used with a PC signal, either via an Analog or Digital connector.

- ▶ Wide: If your PC output is a wide screen format resolution you must select this setting.

*Examples of Wide screen resolutions are: 720 x 400 / 854 x 480 / 1280 x 720 / 1280 x 768.*

- ▶ Normal: If your PC output is a Normal (4:3) resolution you must select this setting.

*Examples of Normal resolutions are: 640 x 480 / 800 x 600 / 1024 x 768 / 1152 x 870 (\* for MAC) / 1280 x 1024 / 1400 x 1050.*

\*All supported resolutions are listed on page 49.



- ❖ "PC Mode" function is only supported under RGB source.



## Setup | Language

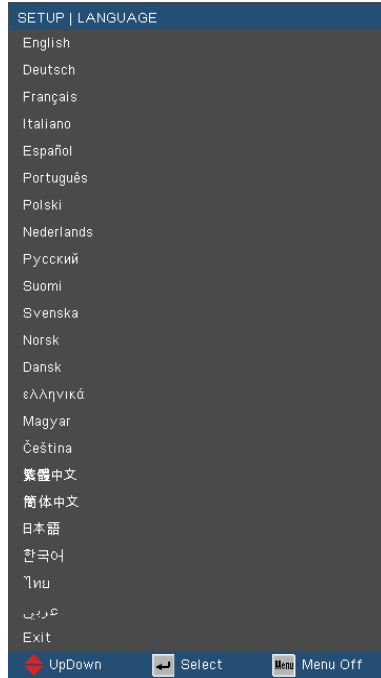

### Language

Choose the multilingual OSD menu. Press ◀ or ▶ into the sub menu and then use the ▲ or ▼ key to select your preferred language. Press “Enter” to finalize the selection.

## Setup

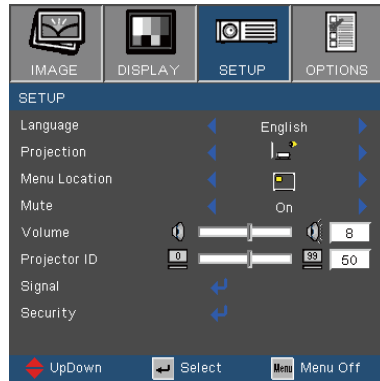

### Projection



Front-Desktop

The factory default setting.



Rear-Desktop

When you select this function, the projector reverses the image so you can project behind a translucent screen.



Front-Ceiling

When you select this function, the projector turns the image upside down for ceiling-mounted projection.



Rear-Ceiling

When you select this function, the projector reverses and turns the image upside down at same time. You can project from behind a translucent screen with ceiling mounted projection.

### Menu Location

Choose the menu location on the display screen.

### Mute

- ▶ Choose the "On" to turn mute on.
- ▶ Choose the "Off" to turn mute off.

## Setup

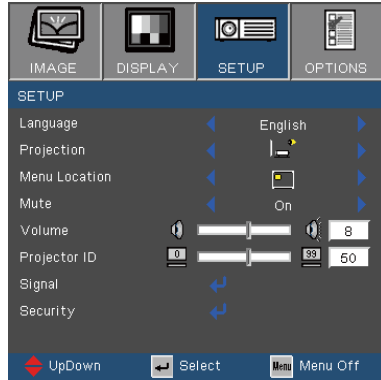

### Volume

- ▶ Press the ◀ to decrease the volume.
- ▶ Press the ▶ to increase the volume.

### Projector ID

Allows RS232 control of an individual projector. Range 01-99.

## Setup | Signal

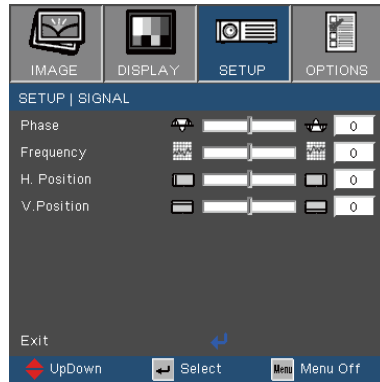

### Phase

“Phase” synchronizes the signal timing of the display with the graphic card. If you experience an unstable or flickering image, use this function to correct it.

### Frequency

“Frequency” changes the display data frequency to match the frequency of your computer’s graphic card. If you experience a vertical flickering bar, use this function to make an adjustment.

### H. Position

- ▶ Press the ◀ to move the image left.
- ▶ Press the ▶ to move the image right.

### V. Position

- ▶ Press the ◀ to move the image down.
- ▶ Press the ▶ to move the image up.

## Setup | Security

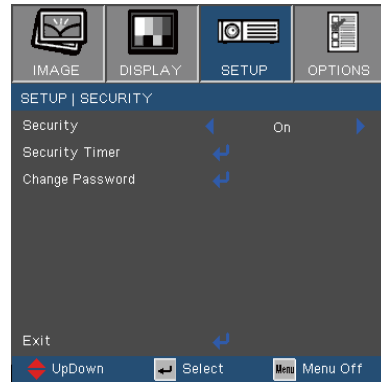

### Security

- ▶ On: Choose “On” to use security verification when the turning on the projector.
- ▶ Off: Choose “Off” to be able to switch on the projector without password verification.

### Security Timer

Can be select the time (Month/Day/Hour) function to set the number of hours the projector can be used. Once this time has elapsed you will be requested to enter your password again.



## Setup | Security

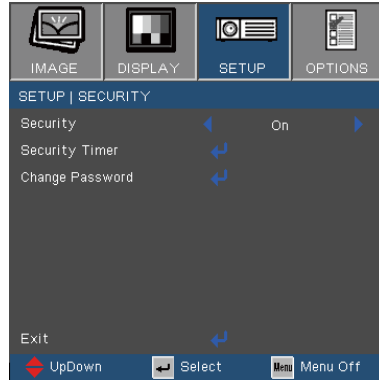

### ■ First Time:

1. The Password is 4 digits, DEFAULT VALUE is "0000".  
(first time)
2. Use number buttons on the remote to select your password, and then press "↵" key to confirm your selection.

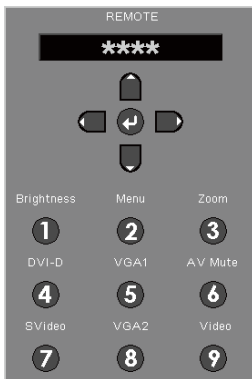

## Change Password

1. Press "↵" to input old password.
2. Use number button to enter current password, and then press "↵" key again to reveal next OSD menu.
3. Scroll down to highlight Password, and then press "↵" to activate.
4. Enter new password (4 digits in length) using the number buttons on the remote, then press "↵" to confirm.
5. Enter new password again and press "↵" to confirm.

## Options

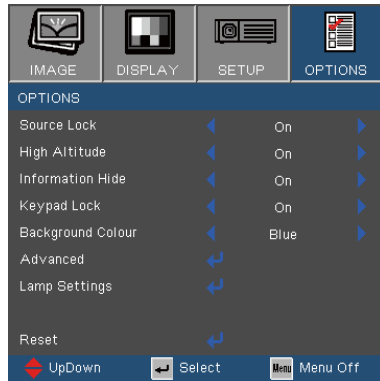

### Source Lock

- ▶ On: The projector will search for other signals if the current input signal is lost.
- ▶ Off: The projector will search specified connection port.

### High Altitude

Choose "On" to turn on High Altitude mode. Operates the fans at full speed continuously to allow for proper high altitude cooling of the projector.

### Information Hide

- ▶ On: Choose "On" to hide the searching message.
- ▶ Off: Choose "Off" to show the searching message.

### Keypad Lock

When the keypad lock function is on, the control panel will be locked, but the projector can still be operated by the remote control. If canceling this function, use the remote control or press the "Enter" key on the control panel for 3 seconds to turn it off.

### Background Colour

Use this feature to display a "Blue" or "Black" screen when no signal is available.

### Reset

Choose "Yes" to return the display parameters on all menus to the factory default settings.

## Options | Advanced

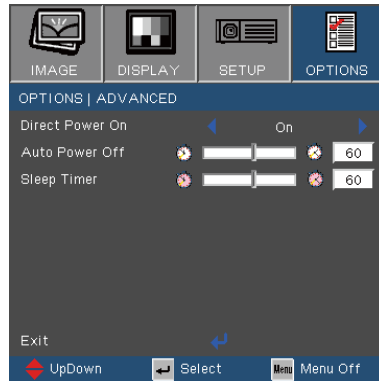

### Direct Power On

Choose "On" to turn on Direct Power On mode. The projector will automatically power on when AC power is supplied, without pressing the "Power/Standby" key on the projector control panel or "Power" key on the remote control.

### Auto Power Off

Sets the countdown timer interval. The countdown timer will start, when there is no signal being sent to the projector. Then projector will automatically power off when the countdown has finished (in minutes).

### Sleep Timer

Sets the countdown timer interval. The timer will begin, with or without a signal input. Then the projector will automatically power off then the sleep timer countdown has finished. (in minutes)



## Options | Lamp Settings

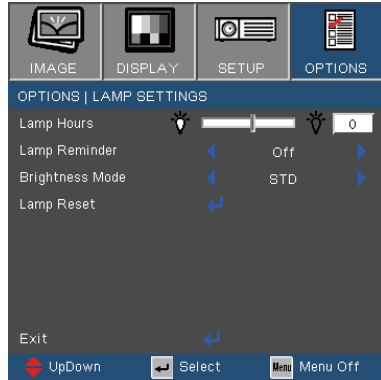

### Lamp Hours

Displays the projection time.

### Lamp Reminder

Choose this function to show or to hide the warning message when the changing lamp message is displayed. The message will appear 30 hours before suggested replacement of lamp.

### Brightness Mode

- ▶ STD: Choose "STD" to dim the projector lamp which will lower power consumption and extend the lamp life by up to 130%.
- ▶ BRIGHT: Choose "BRIGHT" to increase the brightness.

### Lamp Reset

Reset the lamp life hour after replacing the lamp.

## Troubleshooting

*If you experience a problem with your projector, please refer to the following information. If a problem persists, please contact your local reseller or service center.  
(See pages 54-55 for details)*

### Image Problems

#### **[?]** No image appears on-screen

- ▶ Ensure all the cables and power connections are correctly and securely connected as described in the “Installation” section.
- ▶ Ensure all the pins of connectors are not bent or broken.
- ▶ Check if the projection lamp has been securely installed. Please refer to the “Replacing the lamp” section.
- ▶ Make sure you have opened the lens door and the projector is switched on.

#### **[?]** Partial, scrolling or incorrectly displayed image

- ▶ Press “Re-Sync” on the remote control or control panel.
- ▶ If you are using a PC:

For Windows 95, 98, 2000, XP:

1. Open the “My Computer” icon, the “Control Panel” folder, and then double click on the “Display” icon.
2. Select the “Settings” tab.
3. Verify that your display resolution setting is lower than or equal to SXGA+ (1400 x 1050). (\*)
4. Click on the “Advanced Properties” button.

If the projector is still not projecting the whole image, you will also need to change the monitor display you are using. Refer to the following steps.

5. Verify the resolution setting is lower than or equal to SXGA+ (1400 x 1050) resolution.



❖ (\*) The resolution XGA (1024 x 768) is recommended for computer signal.

# Appendices



❖ (\*) The resolution XGA (1024 x 768) is recommend for computer signal.

6. Select the “Change” button under the “Monitor” tab.
  7. Click on “Show all devices”. Next, select “Standard monitor types” under the SP box; choose the resolution mode you need under the “Models” box.
  8. Verify that the resolution setting of the monitor display is lower than or equal to SXGA+ (1400 x 1050). (\*)
- ▶ If you are using a Notebook:
1. First, follow the steps above to adjust resolution of the computer.
  2. Press the toggle output settings. Example: [Fn]+[F4]

Compaq ⇒	[Fn]+[F4]	Hewlett ⇒	[Fn]+[F4]
Dell ⇒	[Fn]+[F8]	Packard ⇒	[Fn]+[F4]
Gateway ⇒	[Fn]+[F4]	NEC ⇒	[Fn]+[F3]
IBM ⇒	[Fn]+[F7]	Toshiba ⇒	[Fn]+[F5]

Mac Apple:  
System Preference ⇒ Display ⇒ Arrangement ⇒ Mirror display

- ▶ If you experience difficulty changing resolutions or your monitor freezes, restart all equipment including the projector.

**[?]** The screen of the Notebook or PowerBook computer is not displaying your presentation

- ▶ If you are using a Notebook PC  
Some Notebook PCs may deactivate their own screens when a second display device is in use. Each has a different way to be reactivated. Refer to your computer’s manual for detailed information.

**[?]** Image is unstable or flickering

- ▶ Use “Phase” to correct it. See page 35 for more information.  
▶ Change the monitor color setting on your computer.

**[?]** Image has vertical flickering bar

- ▶ Use “Frequency” to make an adjustment. See page 35 for more information.  
▶ Check and reconfigure the display mode of your graphic card to make it compatible with the projector.

## **[?]** Image is out of focus

- ▶ Make sure the lens door is opened.
- ▶ Adjusts the Focus Ring on the projector lens.
- ▶ Make sure the projection screen is between the required distance 3.9 to 39.4 feet (1.2 to 12.0 meters) from the projector. See page 19.

## **[?]** The image is stretched when displaying 16:9 DVD title

When you play anamorphic DVD or 16:9 DVD, the projector will show the best image in 16:9 format on projector side.

If you play 4:3 format DVD title, please change the format as 4:3 in projector OSD.

If the image is still stretched, you will also need to adjust the aspect ratio by referring to the following:

- ▶ Please setup the display format as 16:9 (wide) aspect ratio type on your DVD player.

## **[?]** Image is too small or too large

- ▶ Adjust the Zoom Ring on the top of the projector.
- ▶ Move the projector closer to or further from the screen.
- ▶ Press [Menu] button on the remote control or projector panel, go to "Display → Format" and try the different settings.

## **[?]** Image has slanted sides

- ▶ If possible, reposition the projector so that it is centered on the screen and below the bottom of the screen.
- ▶ Press [Keystone +/-] button on the remote control or [ ▽ / ▴ ] on the projector panel, until the sides are vertical on the remote control.



❖ Use of Keystone is not recommended.

## **[?]** Image is reversed

- ▶ Select "Setup → Projection" from the OSD and adjust the projection direction.

## Intermission Problems

- [?]** The projector stops responding to all controls
  - ▶ If possible, turn off the projector, then unplug the power cord and wait at least 60 seconds before reconnecting power.
- [?]** Lamp burns out or makes a popping sound
  - ▶ When the lamp reaches its end of life, it will burn out and may make a loud popping sound. If this happens, the projector will not turn on until the lamp module has been replaced. To replace the lamp, follow the procedures in the “Replacing the Lamp” section on pages 47-48.

## Projector Status Indication

- [?]** LED lighting message

Message	Power/Standby LED	Temp-LED	Lamp-LED
	(Green/Amber)	(Red)	(Red)
Standby State (Input power cord)	Amber	○	○
Power on (Warming)	Flashing Green	○	○
Lamp lighting	Green	○	○
Error (Over Temp.)	○	☀	○
Error (Fan fail)	○	○	Flashing (1sec. ON, 1sec. OFF)
Error (Lamp fail)	○	○	☀



Steady light ⇔ ☀

No light ⇔ ○

## Message Reminders

### ▶ Fan failed:

Warning! FAN LOCKED

The projector will switch off automatically.

Please contact a service centre for repair.

### ▶ Temperature warning:

Warning! TEMPERATURE TOO HIGH

Please:

1. Make sure air in and outlets are not blocked.

2. Make sure the environment temperature is under 40 degree C.

If the problem persists in spite of the above.

Please contact a service centre for repair.

### ▶ Replacing the lamp:



Lamp Warning

Lamp life exceeded.

### ▶ Out of range: (refer to page 49)



Video

Out of display range.

## Remote Control Problems

- ?** If the remote control does not work
- ▶ Check the operating angle for the remote control is approximately  $\pm 22.5^\circ$ .
  - ▶ Make sure there are no obstructions between the remote control and the projector. Move to within 6 m (20 ft) of the projector.
  - ▶ Make sure the batteries are inserted correctly.
  - ▶ Replace weak batteries in the remote control.

## Replacing the lamp

The projector automatically detects the lamp life. When the lamp life is nearing the end of use, you will receive a warning message.





Lamp Warning

Lamp life exceeded.

When you see this message, please contact your local reseller or service center to change the lamp as soon as possible. Make sure the projector has been cooled down for at least 30 minutes before changing the lamp.

### **! Caution !**

If ceiling mounted, use caution when opening lamp panel - Please see user manual for details

-  Warning: If ceiling mounted, please use caution when opening the lamp access panel. It is recommended to wear safety glasses if changing the bulb when ceiling mounted. "Caution must be used to prevent any loose parts from falling out of projector."
-  Warning: Lamp compartment may be hot! Allow it to cool down before changing the lamp!
-  Warning: To reduce the risk of personal injury, do not drop the lamp module or touch the lamp bulb. The bulb may shatter and cause injury if it is dropped.



# Appendices

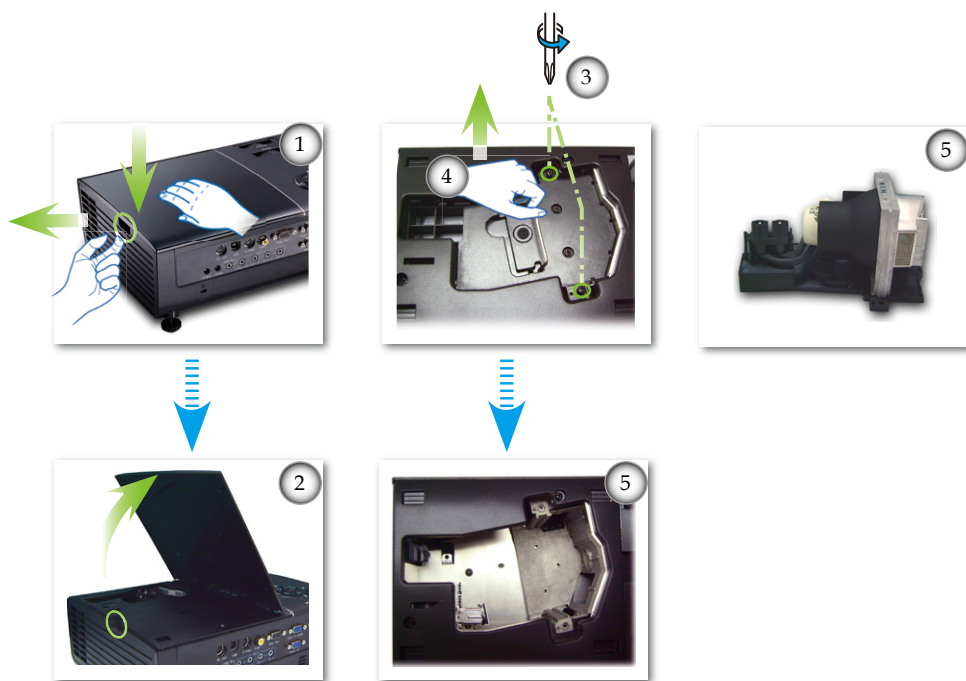

## ○ Lamp Replacement Procedure: ○

1. Switch off the power to the projector by pressing the "Power/Standby" button.
2. Allow the projector to cool down for at least 30 minutes.
3. Disconnect the power cord.
4. Press down and then pull the cover carefully. ❶
5. Open the top cover. ❷
6. Use a screwdriver to remove the 2 screws from the lamp module. ❸
7. Pull up the lamp handle. ❹
8. Remove the lamp module. ❺

To replace the lamp module, reverse the previous steps.

9. Turn on the projector and use "Lamp Reset" after the lamp module is replaced.

Lamp Reset: (i) Press "Menu" → (ii) Select "Options" → (iii) Select "Lamp settings" → (iv) Select "Lamp reset" → (v) Select "Yes".

## Compatibility Modes

### ▶ Computer Compatibility

Mode	Resolution	V-Sync (Hz)	
		Analog	Digital
VGA	640 x 350	70, 85	70, 85
VGA	640 x 400	85	85
VGA	640 x 480	60, 72, 75, 85	60, 72, 75, 85
VGA	720 x 400	70, 85	70, 85
SVGA	800 x 600	56, 60, 72, 75, 85	56, 60, 72, 75, 85
XGA	1024 x 768	60, 70, 75, 85	60, 70, 75
*WXGA	1280 x 720	60, 70, 75, 85	60, 70, 75, 85
*WXGA	1280 x 768	60, 70, 75, 85	60, 70, 75, 85
*SXGA	1280 x 1024	60, 75	60
*SXGA+	1400 x 1050	60	60
MAC LC 13"	640 x 480	66.66	***
MAC II 13"	640 x 480	66.68	***
MAC 16"	832 x 624	74.55	***
MAC 19"	1024 x 768	75	***
* MAC	1152 x 870	75.06	***
MAC G4	640 x 480	60	60, 70
i MAC DV	1024 x 768	75	***
* i MAC DV	1152 x 870	75	***
* i MAC DV	1280 x 960	75	***
MAC G5	800 x 600	60, 72, 75, 85	56, 60, 72, 75
MAC G5	1024 x 768	60, 70, 75, 85	60, 70, 75
MAC G5	1280 x 720	60, 75, 85	60, 75
MAC G5	1280 x 1024	60	60
MAC G5	1400 x 1050	60	***



❖ "\*" compressed computer image.

### ▶ Video Compatibility

NTSC	M (3.58MHz), 4.43 MHz, 480i/p @60Hz
PAL	B, D, G, H, I, M, N, 576i/p @50Hz
SECAM	B, D, G, K, K1, L
HDTV	480p, 576p, 720p, 1080i (50/60 Hz)

## RS232 Commands

### RS232 Connector

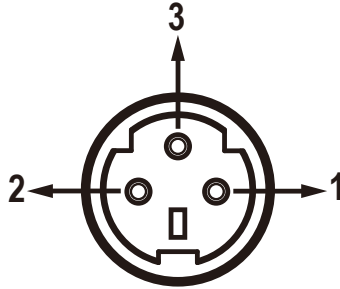

Pin no.	Name	I/O (From Projector Side)
1	TXD	OUT
2	RXD	IN
3	GND	—

### VGA-In Connector

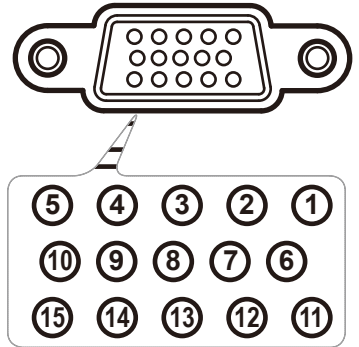

Pin no.	Spec.
1	R(RED)/Cr
2	G(GREEN)/Y
3	B(BLUE)/Cb
4	GND
5	GND
6	GND
7	GND
8	GND
9	DDC 5V
10	GND
11	GND
12	DDC Data
13	HD/CS
14	VD
15	DDC Clock

# Appendices

## RS232 Protocol Function List

### RS232 Commands

**SEND to projector**

Baud Rate : 9600  
 Data Bits: 8  
 Parity: None  
 Stop Bits: 1  
 Flow Control : None  
 UART16550 FIFO: Disable  
 Projector Return (Pass): P  
 Projector Return (Fail): F

232 ASCH Code	HEX Code	Function	Description
-XX00 1	7E 30 30 30 30 20 31	Power ON	
-XX00 2	7E 30 30 30 30 20 32	Power OFF	
-XX00 1 -nmm		Power On with Password	
-XX01 1	7E 30 30 30 31 20 31	Resync	
-XX02 1	7E 30 30 30 32 20 31	AV Mute	On
-XX02 2	7E 30 30 30 32 20 32		Off
-XX03 1	7E 30 30 30 33 20 31	Mute	On
-XX03 2	7E 30 30 30 33 20 32		Off
-XX04 1	7E 30 30 30 34 20 31	Freeze	
-XX04 2	7E 30 30 30 34 20 32	Unfreeze	
-XX05 1	7E 30 30 30 35 20 31	Zoom Plus	
-XX06 1	7E 30 30 30 36 20 31	Zoom Minus	
-XX07 1	7E 30 30 30 37 20 31	Up (Pan under zoom)	
-XX08 1	7E 30 30 30 38 20 31	Down (Pan under zoom)	
-XX09 1	7E 30 30 30 39 20 31	Left (Pan under zoom)	
-XX10 1	7E 30 30 31 30 20 31	Right (Pan under zoom)	
-XX20 1		Display Mode	Presentation
-XX20 2			Bright
-XX20 3			Movie
-XX20 4			sRGB
-XX20 5			User 1
-XX21 n		Brightness	n= -50 - +50
-XX22 n		Contrast	n= -50 - +50
-XX23 n		Sharpness	n= -50 - +50
-XX27 n		Colour	Red n= -45 - +45
-XX28 n			Green n= -45 - +45
-XX29 n			Blue n= -45 - +45
-XX30 n			Cyan n= -45 - +45
-XX31 n			Yellow n= -45 - +45
-XX32 n			Magenta n= -45 - +45
-XX33 1			Reset
-XX34 n		BrilliantColor™	n= -45 - +45
-XX35 1	7E 30 30 33 35 20 31	Degamma	Film
-XX35 2	7E 30 30 33 35 20 32		Video
-XX35 3	7E 30 30 33 35 20 33		Graphics
-XX35 4	7E 30 30 33 35 20 34		PC
-XX36 1	7E 30 30 33 36 20 31	Colour Temp.	Low
-XX36 2	7E 30 30 33 36 20 32		Medium
-XX36 3	7E 30 30 33 36 20 33		High
-XX37 1	7E 30 30 33 37 20 31	Colour Space	Auto
-XX37 2	7E 30 30 33 37 20 32		RGB
-XX37 3	7E 30 30 33 37 20 33		YUV
-XX39 2	7E 30 30 33 39 20 32	Input Source	DVI-D
-XX39 5	7E 30 30 33 39 20 35		VGA 1
-XX39 6	7E 30 30 33 39 20 36		VGA 2
-XX39 9	7E 30 30 33 39 20 39		S-Video
-XX39 10	7E 30 30 33 39 20 31 30		Video
-XX60 1	7E 30 30 36 30 20 31	Format	4:3
-XX60 2	7E 30 30 36 30 20 32		16:9-I
-XX60 3	7E 30 30 36 30 20 33		16:9-II
-XX60 4	7E 30 30 36 30 20 34		Window
-XX61 n		Overscan	n= 0 - 25
-XX62 n		Zoom	n= 0 - 10
-XX63 n		H Image Shift	n= -50 - +50
-XX64 n		V Image Shift	n= -50 - +50
-XX66 n		V Keystone	n= -50 - +50
-XX67 1	7E 30 30 36 37 20 31	PC Mode	Normal
-XX67 2	7E 30 30 36 37 20 32		Wide
-XX70 1	7E 30 30 37 30 20 31	Language	English
-XX70 2	7E 30 30 37 30 20 32		German
-XX70 3	7E 30 30 37 30 20 33		French
-XX70 4	7E 30 30 37 30 20 34		Italian
-XX70 5	7E 30 30 37 30 20 35		Spanish
-XX70 6	7E 30 30 37 30 20 36		Portuguese
-XX70 7	7E 30 30 37 30 20 37		Polish
-XX70 8	7E 30 30 37 30 20 38		Dutch
-XX70 9	7E 30 30 37 30 20 39		Swedish
-XX70 10	7E 30 30 37 30 20 31 30		Norwegian/Danish
-XX70 11	7E 30 30 37 30 20 31 31		Finnish
-XX70 12	7E 30 30 37 30 20 31 32		Greek
-XX70 13	7E 30 30 37 30 20 31 33		Traditional Chinese
-XX70 14	7E 30 30 37 30 20 31 34		Simplified Chinese
-XX70 15	7E 30 30 37 30 20 31 35		Japanese
-XX70 16	7E 30 30 37 30 20 31 36		Korean
-XX70 17	7E 30 30 37 30 20 31 37		Russian
-XX70 18	7E 30 30 37 30 20 31 38		Hungarian
-XX70 19	7E 30 30 37 30 20 31 39		Czechoslovak
-XX70 20	7E 30 30 37 30 20 32 30		Arabic
-XX70 21	7E 30 30 37 30 20 32 31		Thai

# Appendices

232 ASCII Code	HEX Code	Function	Description
~XX71 1	7E 30 30 37 31 20 31	Projection	Front-Desktop
~XX71 2	7E 30 30 37 31 20 32		Rear-Desktop
~XX71 3	7E 30 30 37 31 20 33		Front-Ceiling
~XX71 4	7E 30 30 37 31 20 34		Rear-Ceiling
~XX72 1	7E 30 30 37 32 20 31	Menu Location	Top Left
~XX72 2	7E 30 30 37 32 20 32		Top Right
~XX72 3	7E 30 30 37 32 20 33		Centre
~XX72 4	7E 30 30 37 32 20 34		Bottom Left
~XX72 5	7E 30 30 37 32 20 35		Bottom Right
~XX73 n		Signal	Frequency
~XX74 n			Phase
~XX75 n			H. Position
~XX76 n			V. Position
~XX77 n		Security	Security Timer
~XX78 1	7E 30 30 37 38 20 31		Security Settings
~XX78 2	7E 30 30 37 38 20 32		Month/Day/Hour Enable Disable
~XX79 n		Projector ID	n=00-99
~XX80 1	7E 30 30 38 30 20 31	Mute	On
~XX80 2	7E 30 30 38 30 20 32		Off
~XX81 n		Volume	n=0-15
~XX100 1	7E 30 30 31 30 30 20 31	Source Lock	On
~XX100 2	7E 30 30 31 30 30 20 32		Off
~XX101 1	7E 30 30 31 30 31 20 31	High Altitude	On
~XX101 2	7E 30 30 31 30 31 20 32		Off
~XX102 1	7E 30 30 31 30 32 20 31	Information Hide	On
~XX102 2	7E 30 30 31 30 32 20 32		Off
~XX103 1	7E 30 30 31 30 33 20 31	Keypad Lock	On
~XX103 2	7E 30 30 31 30 33 20 32		Off
~XX104 1	7E 30 30 31 30 34 20 31	Background Colour	Blue
~XX104 2	7E 30 30 31 30 34 20 32		Black
~XX105 1	7E 30 30 31 30 35 20 31	Advanced	Direct Power On
~XX105 2	7E 30 30 31 30 35 20 32		On Off
~XX106 n			Auto Power Off (min)
~XX107 n			Sleep Timer (min)
~XX108 1	7E 30 30 31 30 38 20 31	Lamp Setting	Lamp Hour
~XX109 1	7E 30 30 31 30 39 20 31		Lamp Reminder
~XX109 2	7E 30 30 31 30 39 20 32		On Off
~XX110 1	7E 30 30 31 31 30 20 31		Brightness Mode
~XX110 2	7E 30 30 31 31 30 20 32		Bright STD
~XX111 1	7E 30 30 31 31 31 20 31		Lamp Reset
~XX111 2	7E 30 30 31 31 31 20 32		Yes No
~XX112 1	7E 30 30 31 31 32 20 31		Reset
~XX112 2	7E 30 30 31 31 32 20 32	No	
<b>SEND to Remote</b>			
~XX140 1	7E 30 30 31 34 30 20 31		Power
~XX140 3	7E 30 30 31 34 30 20 33		Remote Mouse Up
~XX140 4	7E 30 30 31 34 30 20 34		Remote Mouse Left
~XX140 5	7E 30 30 31 34 30 20 35		Remote Mouse Enter
~XX140 6	7E 30 30 31 34 30 20 36		Remote Mouse Right
~XX140 7	7E 30 30 31 34 30 20 37		Remote Mouse Down
~XX140 8	7E 30 30 31 34 30 20 38		Mouse Left Click
~XX140 9	7E 30 30 31 34 30 20 39		Mouse Right Click
~XX140 10	7E 30 30 31 34 30 20 31 30		Up/Page +
~XX140 11	7E 30 30 31 34 30 20 31 31		Left/Source
~XX140 12	7E 30 30 31 34 30 20 31 32		Enter (for projection MENU)
~XX140 13	7E 30 30 31 34 30 20 31 33		Right/Re-SYNC
~XX140 14	7E 30 30 31 34 30 20 31 34		Down/Page -
~XX140 15	7E 30 30 31 34 30 20 31 35		Keystone +
~XX140 16	7E 30 30 31 34 30 20 31 36		Keystone -
~XX140 17	7E 30 30 31 34 30 20 31 37		Volume -
~XX140 18	7E 30 30 31 34 30 20 31 38		Volume +
~XX140 19	7E 30 30 31 34 30 20 31 39		Brightness
~XX140 20	7E 30 30 31 34 30 20 32 30		Menu
~XX140 21	7E 30 30 31 34 30 20 32 31		Zoom
~XX140 22	7E 30 30 31 34 30 20 32 32		DVI-D
~XX140 23	7E 30 30 31 34 30 20 32 33		VGA-1
~XX140 24	7E 30 30 31 34 30 20 32 34		AV Mute
~XX140 25	7E 30 30 31 34 30 20 32 35		S-Video
~XX140 26	7E 30 30 31 34 30 20 32 36		VGA-2
~XX140 27	7E 30 30 31 34 30 20 32 37		Video

## Ceiling Mount Installation

1. To prevent damaging your projector, please use Optoma's recommended mount package for installation.
2. If you wish to use a third party ceiling mount kit, please ensure the screws used to attached a mount to the projector met the following specifications:

- ▶ Screw type: M3
- ▶ Maximum screw length: 10mm
- ▶ Minimum screw length: 7.5mm



❖ Please note that damage resulting from incorrect installation will invalidate the warranty.



### ⚠ Warning:

1. If you buy the ceiling mount from other company, please ensure that there is at least 10cm distance between the bottom cover of the projector and the ceiling.
2. Avoid placing the projector near sources of heat such as air-conditioning units and heaters, otherwise, it may overheat and shut down automatically.

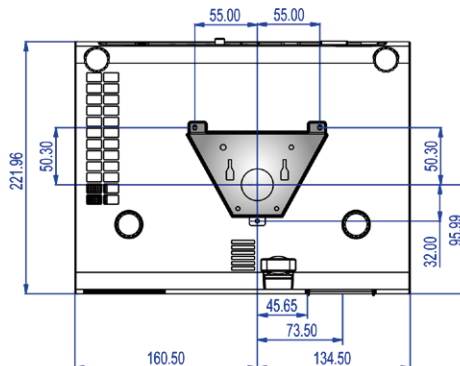
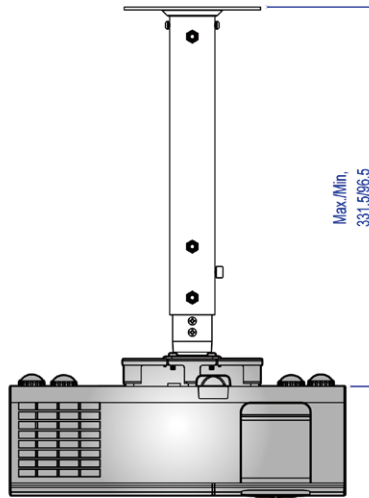

## Optoma Global Offices

*For service or support please contact your local office.*

### USA

715 Sycamore Drive  
Milpitas, CA 95035, USA  
www.optomausa.com

Tel : 408-383-3700  
Fax : 408-383-3702  
Service : [services@optoma.com](mailto:services@optoma.com)

### Canada

5630 Kennedy Road, Mississauga,  
ON, L4Z 2A9, Canada  
www.optoma.ca

Tel : 905-361-2582  
Fax : 905-361-2581

### Europe

42 Caxton Way, The Watford Business Park  
Watford, Hertfordshire,  
WD18 8QZ, UK  
www.optoma.eu  
Service Tel : +44 (0)1923 691865

Tel : +44 (0) 1923 691 800  
Fax : +44 (0) 1923 691 888  
Service : [service@tsc-europe.com](mailto:service@tsc-europe.com)

### Optoma France

Bâtiment E  
81-83 avenue Edouard Vaillant  
92100 Boulogne Billancourt, France

Tel.: +33 1 41 46 12 20  
Fax : +33 1 41 46 94 35  
Service : [savoptoma@optoma.fr](mailto:savoptoma@optoma.fr)

### Optoma Spain

Paseo de la Castellana  
135 7 Planta  
Madrid, Spain

Tel.: +34 91 790 67 01  
+34 91 790 67 02  
Fax : + 34 91 790 68 69

### Optoma Deutschland

Werttstrasse 25  
D40549 Düsseldorf,  
Germany

Tel : +49 (0) 211 506 6670  
Fax : +49 (0) 211 506 66799  
Service : [info@optoma.de](mailto:info@optoma.de)

### Optoma Scandinavia

Grev Wedels Plass 2  
3015 Drammen  
Norway

Tel : +47 32 26 89 90  
Fax : +47 32 83 78 98  
Service : [info@optoma.no](mailto:info@optoma.no)

### Latin America

715 Sycamore Drive  
Milpitas, CA 95035, USA  
www.optoma.com.br

Tel : 408-383-3700  
Fax : 408-383-3702  
www.optoma.com.mx

## Korean

WOOMI TECH.CO.,LTD.

4F,Minu Bldg.33-14, Kangnam-Ku, Tel : +82+2+34430004

seoul,135-815, KOREA

Fax : +82+2+34430005

## Japanese

東京都足立区綾瀬3-25-18

オーエス本社ビル

サポートセンター: 0120-46-5040

E-mail : [info@osscreen.com](mailto:info@osscreen.com)

[www.os-worldwide.com](http://www.os-worldwide.com)

## Taiwan

5F., No. 108, Minchiuan Rd.

Shindian City,

Taipei Taiwan 231, R.O.C.

[www.optoma.com.tw](http://www.optoma.com.tw)

Tel : +886-2-2218-2360

Fax : +886-2-2218-2313

Service : [services@optoma.com.tw](mailto:services@optoma.com.tw)

[www.asia.optoma.com](http://www.asia.optoma.com)

## Hong Kong

Unit A, 27/F Dragon Centre,

79 Wing Hong Street,

Cheung Sha Wan,

Kowloon, Hong Kong

Tel : +852-2396-8968

Fax : +852-2370-1222

[www.optoma.com.hk](http://www.optoma.com.hk)

## China

5F, No. 1205, Kaixuan Rd.,

Changning District

Shanghai, 200052, China

Tel : +86-21-62947376

Fax : +86-21-62947375

[www.optoma.com.cn](http://www.optoma.com.cn)



## Regulation & Safety notices

*This appendix lists the general notices of your projector.*

### *FCC notice*

This device has been tested and found to comply with the limits for a Class B digital device pursuant to Part 15 of the FCC rules. These limits are designed to provide reasonable protection against harmful interference in a residential installation. This device generates, uses, and can radiate radio frequency energy and, if not installed and used in accordance with the instructions, may cause harmful interference to radio communications.

However, there is no guarantee that interference will not occur in a particular installation. If this device does cause harmful interference to radio or television reception, which can be determined by turning the device off and on, the user is encouraged to try to correct the interference by one or more of the following measures:

- Reorient or relocate the receiving antenna.
- Increase the separation between the device and receiver.
- Connect the device into an outlet on a circuit different from that to which the receiver is connected.
- Consult the dealer or an experienced radio/television technician for help.

### ***Notice: Shielded cables***

All connections to other computing devices must be made using shielded cables to maintain compliance with FCC regulations.

### ***Caution***

Changes or modifications not expressly approved by the manufacturer could void the user's authority, which is granted by the Federal Communications Commission, to operate this computer.

## *Operation conditions*

This device complies with Part 15 of the FCC Rules. Operation is subject to the following two conditions:

1. This device may not cause harmful interference, and
2. This device must accept any interference received, including interference that may cause undesired operation.

## *Notice: Canadian users*

This Class B digital apparatus complies with Canadian ICES-003.

## *Remarque à l'intention des utilisateurs canadiens*

Cet appareil numérique de la classe B est conforme à la norme NMB-003 du Canada.

## *Declaration of Conformity for EU countries*

- EMC Directive 89/336/EEC (including amendments)
- Low Voltage Directive 73/23/EEC (amended by 93/68/EEC)
- R & TTE Directive 1999/EC (if product has RF function)

## **Disposal instructions**



**Do not throw this electronic device into the trash when discarding. To minimize pollution and ensure utmost protection of the global environment, please recycle it.**