

myprojectorlamps.com

**The most trusted, dependable name
in projector lamp sales.**



<http://www.myprojectorlamps.com>



<http://www.myprojectorlamps.ca>



<http://www.myprojectorlamps.eu>

The following projector manual has not been modified or altered in any way.

Regulation & safety notices

This appendix lists the general notices of your Projector.

FCC notice

This device has been tested and found to comply with the limits for a Class B digital device pursuant to Part 15 of the FCC rules. These limits are designed to provide reasonable protection against harmful interference in a residential installation. This device generates, uses, and can radiate radio frequency energy and, if not installed and used in accordance with the instructions, may cause harmful interference to radio communications.

However, there is no guarantee that interference will not occur in a particular installation. If this device does cause harmful interference to radio or television reception, which can be determined by turning the device off and on, the user is encouraged to try to correct the interference by one or more of the following measures:

- Reorient or relocate the receiving antenna.
- Increase the separation between the device and receiver.
- Connect the device into an outlet on a circuit different from that to which the receiver is connected.
- Consult the dealer or an experienced radio/television technician for help.

Notice: Shielded cables

All connections to other computing devices must be made using shielded cables to maintain compliance with FCC regulations.

Caution

Changes or modifications not expressly approved by the manufacturer could void the user's authority, which is granted by the Federal Communications Commission, to operate this computer.

Operation conditions

This device complies with Part 15 of the FCC Rules. Operation is subject to the following two conditions:

1. this device may not cause harmful interference, and
2. this device must accept any interference received, including interference that may cause undesired operation.

Notice: Canadian users

This Class B digital apparatus complies with Canadian ICES-003.

Remarque à l'intention des utilisateurs canadiens

Cet appareil numérique de la classe B est conforme à la norme NMB-003 du Canada.

Declaration of Conformity for EU countries

EMC Directive 89/336/EEC (including amendments)

Low Voltage Directive 73/23/EEC (amended by 93/68/EEC)

R & TTE Directive 1999/EC (if product has RF function)











Table of Contents

Table of Contents	1
Usage Notice	2
<i>Precautions</i>	2
Introduction	4
<i>Product Features</i>	4
<i>Package Overview</i>	5
<i>Product Overview</i>	6
<i>Main Unit</i>	6
<i>Control Panel</i>	7
<i>Connection Ports</i>	8
<i>Remote Control with Mouse Function and Laser Pointer</i>	9
Installation	10
<i>Connecting the Projector</i>	10
<i>Connect the Computer/Notebook</i>	10
<i>Connect the Video</i>	11
<i>Powering On/Off the Projector</i>	12
<i>Powering On the Projector</i>	12
<i>Powering Off the projector</i>	13
<i>Warning Indicator</i>	13
<i>Adjusting the Projected Image</i>	14
<i>Adjusting the Projector Image Height</i>	14
<i>Adjusting the Projector Zoom / Focus</i>	15
<i>Adjusting Projected Image Size</i>	15
User Controls	16
<i>Control Panel & Remote Control</i>	16
<i>On-Screen Display Menus</i>	18
<i>How to Operate</i>	18
<i>Menu Tree</i>	19
<i>Image-I</i>	20
<i>Image-II</i>	22
<i>Colour Setting</i>	24
<i>Language</i>	26
<i>Management</i>	27
<i>Lamp Setting</i>	30
Appendices	32
<i>Troubleshooting</i>	32
<i>Replacing the Lamp</i>	36
<i>Compatibility Modes</i>	37
<i>RS232 Commands</i>	38
<i>Ceiling Mount Installation</i>	39
<i>Optoma Global Offices</i>	40

Usage Notice

Precautions

Follow all warnings, precautions and maintenance as recommended in this user's guide to maximize the life of your unit.

-  Warning- Do not look into the projector's lens when the lamp is on. The bright light may hurt your eyes.
-  Warning- To reduce the risk of fire or electric shock, do not expose this product to rain or moisture.
-  Warning- Please do not open or disassemble the product as this may cause electric shock.
-  Warning- When changing the lamp, please allow unit to cool down, and follow all changing instructions.
-  Warning- This product will detect the life of the lamp itself. Please be sure to change the lamp when it shows warning messages.
-  Warning- Reset the "Reset Lamp Hours" function from the On Screen Display "Lamp Setting" menu after replacing the lamp module (refer to page 30).
-  Warning- When switching the projector off, please ensure the projector completes its cooling cycle before disconnecting power.
-  Warning- Turn on the projector first and then the signal sources.
-  Warning- Do not use lens cap when projector is in operation.
-  Warning- When the lamp reaches the end of its life, it will burn out and may make a loud popping sound. If this happens, the projector will not turn back on until the lamp module has been replaced. To replace the lamp, follow the procedures listed under "Replacing the Lamp". (see page 36)

Usage Notice

Do:

- ❖ Turn off the product before cleaning.
- ❖ Use a soft cloth moistened with mild detergent to clean the display housing.
- ❖ Disconnect the power plug from AC outlet if the product is not being used for a long period of time.

Don't:

- ❖ Block the slots and openings on the unit provided for ventilation.
- ❖ Use abrasive cleaners, waxes or solvents to clean the unit.
- ❖ Use under the following conditions:
 - In extremely hot, cold or humid environments.
 - In areas susceptible to excessive dust and dirt.
 - Near any appliance that generates a strong magnetic field.
 - In direct sunlight.

Introduction

Product Features

Congratulations and Thank You for choosing Optoma projector. This product is a XGA single chip 0.55" DLP® projector. Outstanding features include:

- ◆ True XGA, 1024 x 768 addressable pixels
- ◆ Texas Instruments Single chip DLP® Technology
- ◆ NTSC/NTSC4.43/PAL/PAL-M/PAL-N/SECAM and HDTV compatible (480i/p, 576i/p, 720p, 1080i)
- ◆ Multi-Auto functions: Auto detection, Automatic saving of user adjustments
- ◆ Full function IR remote control with laser pointer
- ◆ User friendly multilingual on screen menu
- ◆ Advanced digital keystone correction and high quality full screen image re-scaling
- ◆ User friendly control panel
- ◆ One built-in speaker with 2 Watt amplifier
- ◆ SXGA+, SXGA compression and SVGA, VGA re-sizing
- ◆ Mac compatible
- ◆ DVI support (HDCP compliant)

Package Overview

This projector comes with all the items shown below. Check to make sure your unit is complete. Contact your dealer immediately if anything is missing.



Projector with lens cap



Power Cord 1.8m



VGA Cable 1.8m



Composite Video Cable
1.8m



Carry Bag



RS232 Cable 1.8m



❖ Due to the difference in applications for each country, some regions may have different accessories.



Wireless Remote
Controller



2 x AA Batteries

Documents :

- User's Guide
- Quick Start Card
- Warranty Card
- Quick Troubleshooting Guide

Product Overview

Main Unit

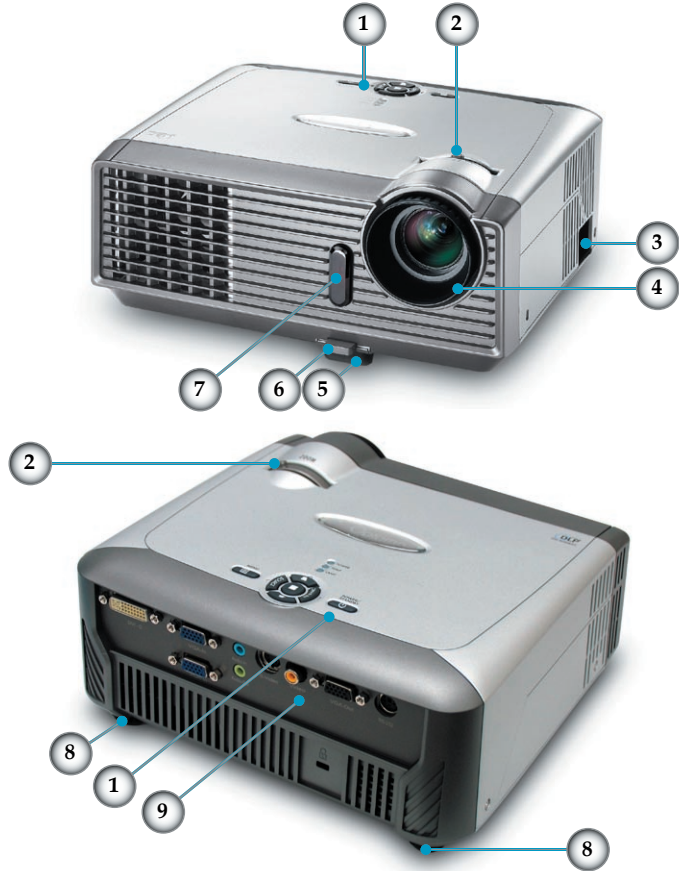

1. Control Panel
2. Zoom Lever
3. Power Socket
4. Focus Ring
5. Elevator Foot
6. Elevator Button
7. IR Receiver
8. Tilt Adjusting Feet
9. Connection Ports

Control Panel

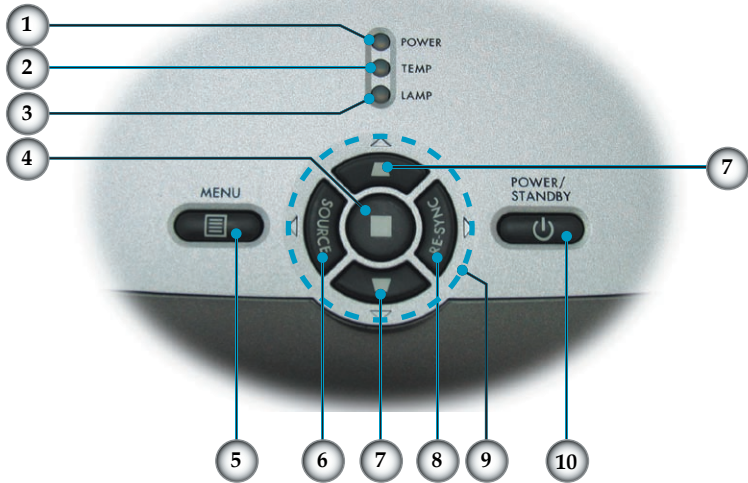

1. Power/Standby LED
2. Temp Indicator LED
3. Lamp Indicator LED
4. Enter
5. Menu (On/Off)
6. Source Select
7. Keystone +/-
8. Re-Sync
9. Four Directional Select Keys
10. Power/Standby

Introduction

Connection Ports

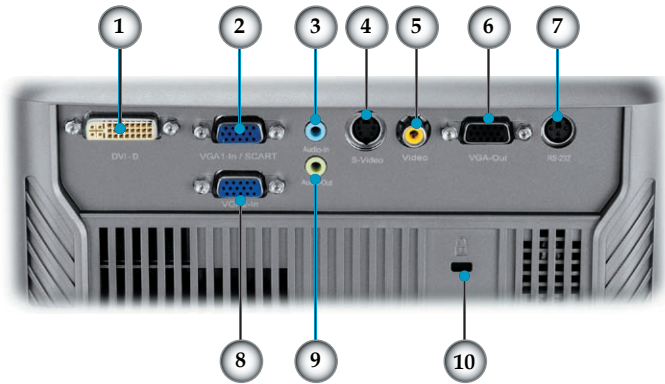

1. DVI-D Input Connector (PC Digital/HDTV/HDCP Input)
2. VGA1-In SCART Connector (PC Analog signal/SCART RGB/HD/Component Video Input)
3. Audio Input Connector
4. S-Video Input Connector
5. Composite Video Input Connector
6. Monitor Loop-through Output Connector
7. RS232 Connector
8. VGA2-In Connector (PC Analog signal/HD/Component Video Input)
9. Audio Output Connector
10. Kensington™ Lock Port

Remote Control with Mouse Function and Laser Pointer

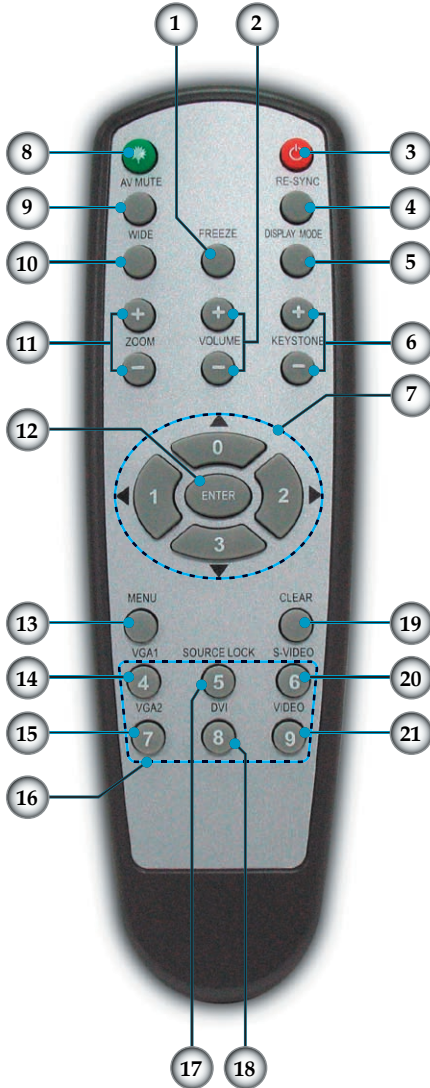
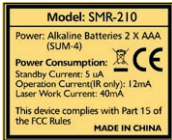

1. Freeze
2. Volume +/-
3. Power
4. Re-Sync
5. Display Mode
6. Keystone +/-
7. Four Directional Select Keys & Number Buttons (0~3)
8. Laser Button
9. AV Mute
10. Wide Mode
11. Zoom In/Zoom Out
12. Enter
13. Menu
14. VGA1 Source
15. VGA2 Source
16. Number Buttons (4~9)
17. Source Lock
18. DVI Source
19. Clear
20. S-Video Source
21. Composite Video Source

Installation

Connecting the Projector

Connect the Computer/Notebook



Audio Output (For Active Speakers)



❖ Due to the difference in applications for each country, some regions may have different accessories.

- | | |
|---------|--------------------|
| 1. | Power Cord |
| 2. | RS232 Cable |
| 3. | Audio Input Cable |
| 4. | VGA to VGA Cable |
| 5. | DVI to DVI Cable |
| 6. | Audio Output Cable |

Installation

Connect the Video

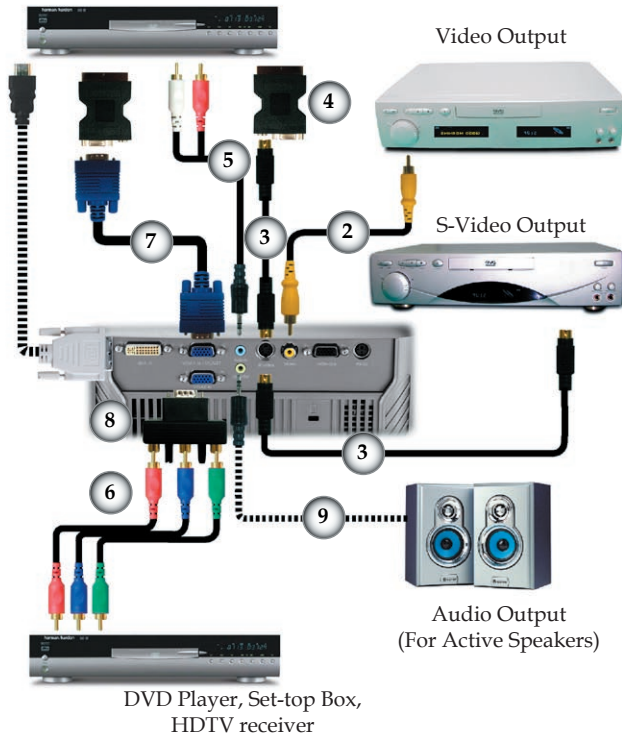

❖ Due to the difference in applications for each country, some regions may have different accessories.

1.Power Cord
2. Composite Video Cable
3. S-Video Cable
4.SCART VGA/S-Video Adapter
5. Audio Input Cable
6. RCA Component Cable for YPbPr
7. VGA to VGA Cable
8. VGA to 3 RCA Component/HDTV Adapter
9.Audio Output Cable

Installation

Powering On/Off the Projector

Powering On the Projector

1. Remove the lens cap. ❶
2. Ensure that the power cord and signal cable are securely connected. The Power LED will turn red.
3. Turn on the lamp by pressing “Power/Standby” button on the control panel. ❷ And the Power LED will turn green.
4. Turn on your source (computer, notebook, video player, etc.). The projector will detect your source automatically within “Management” menu; check that “Source Lock” has been set to “Off”.

Text Pattern



- ❖ If the screen displays “No Signal”, please make sure the signal cables are securely connected.
- ❖ You can calling out test image method is under “AV Mute” button, then press ▲ key to select pattern for view and settle 4 sides, area and focus.
- ❖ If you connect multiple sources at the same time, use the “Source” button on the control panel or direct source key on remote control to switch.

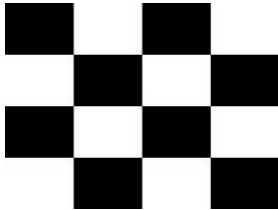

- ❖ Turn on the projector first and then the signal sources.



1
Lens Cap



2
Power/Standby

Powering Off the Projector

1. Press the “Power/Standby” button to turn off the projector lamp; you will see a message

Wait 1 minutes before you can switch on again.

Press Power key again to confirm.

Press "Enter" key to remove this warning.

- displayed on the projector’s screen. Press the “Power/Standby” button again to confirm, otherwise the message will disappear after 5 seconds.
2. The cooling fans continue to operate for about 30 seconds for cooling cycle and the Power LED will flash red. When the Power LED stops flashing, the projector has entered standby mode.
Once in standby mode, simply press “Power/Standby” button to restart the projector.
 3. Disconnect the power cord from the electrical outlet and the projector.
 4. Do not turn on the projector immediately following a power off procedure.

Warning Indicator

- ❖ When the “TEMP” indicator turns red, it indicates the projector has overheated. The projector will automatically shut itself down.
- ❖ When the “LAMP” indicator turns red, it indicates a problem with the lamp. Turn off the projector and disconnect the power cord from the electrical outlet, then contact your local dealer or our service center. See page 40.
- ❖ When the “LAMP” indicator flashes red, it indicates the fan has failed. Stop using the projector and disconnect the power cord from the electrical outlet, then contact your local dealer or our service center. See page 40.

Adjusting the Projected Image

Adjusting the Projector Image Height

The projector is equipped with elevator foot for adjusting the image height.

To raise the image:

1. Press the elevator button **1**.
2. Raise the image to the desired height angle **2**, then release the button to lock the elevator foot into position.
3. Use screw in feet **3** to fine-tune the display angle.

To lower the image:

1. Press the elevator button.
2. Lower the image, then release the button to lock the elevator foot into position.
3. Use screw in feet **3** to fine-tune the display angle.

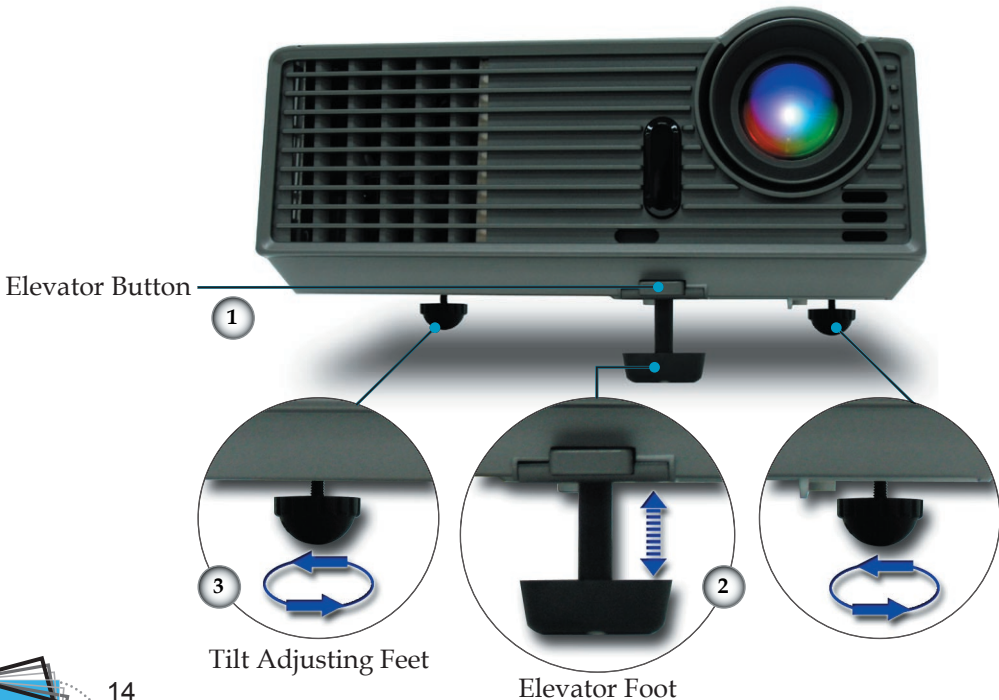

Installation

Adjusting the Projector Zoom / Focus

You may turn the zoom lever to zoom in or out. To focus the image, rotate the focus ring until the image is clear. The projector will focus at distances from 3.9 to 39.4 feet (1.2 to 12.0 meters).



Adjusting Projection Image Size

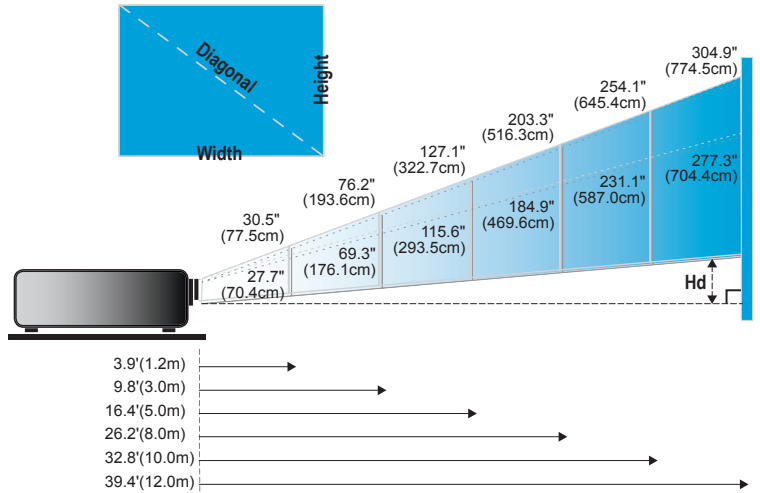

Screen (Diagonal)	Max.	30.5" (77.5cm)	76.2" (193.6cm)	127.1" (322.7cm)	203.3" (516.3cm)	254.1" (645.4cm)	304.9" (774.5cm)
	Min.	27.7" (70.4cm)	69.3" (176.1cm)	115.6" (293.5cm)	184.9" (469.6cm)	231.1" (587.0cm)	277.3" (704.4cm)
Screen Size (WxH)	Max.	24.4" x 18.3"	61.0" x 45.7"	101.7" x 76.3"	162.6" x 122"	203.3" x 152.5"	243.9" x 182.9"
	Min.	62.0 x 46.5cm	154.9 x 116.2cm	258.2 x 193.6cm	413.0 x 309.8cm	516.3 x 387.2cm	619.6 x 464.7cm
Hd	Max.	22.2" x 16.6"	55.4" x 41.6"	92.5" x 69.4"	147.9" x 110.9"	184.9" x 138.7"	221.8" x 166.4"
	Min.	56.3 x 42.2cm	140.9 x 105.7cm	234.8 x 176.1cm	375.7 x 281.8cm	469.6 x 352.2cm	563.5 x 422.6cm
Hd	Max.	2.75" (7.0cm)	6.86" (17.4cm)	11.44" (29.0cm)	18.30" (46.5cm)	22.87" (58.1cm)	27.44" (69.7cm)
	Min.	2.49" (6.3cm)	6.24" (15.9cm)	10.40" (26.4cm)	16.64" (42.3cm)	20.80" (52.8cm)	24.96" (63.4cm)
Distance		3.9' (1.2m)	9.8' (3.0m)	16.4' (5.0m)	26.2' (8.0m)	32.8' (10.0m)	39.4' (12.0m)

❖ This graph is for user's reference only.

Control Panel & Remote Control

There are two ways for you to control the functions: Remote Control and Control Panel.

Using the Control Panel





Power/Stand-by	Refer to the “Power On/Off the Projector” section on pages 12-13.
Source ◀	Press “Source” to select an input signal.
Menu	Turns the menu On or Off.
Four Directional Select Keys	Use ▲ ▼ ◀ ▶ to navigate through the menus.
Enter	Confirm your item selection.
Keystone	Adjusts image distortion caused by tilting the projector (±16 degrees).
Re-Sync ▶	Automatically synchronizes the projector to the input source.

User Controls



Using the Remote Control

 Power	Refer to the “Power On/Off the Projector” section on pages 12-13.
Re-Sync	Automatically synchronizes the projector to the input source.
Keystone	Adjusts image distortion caused by tilting the projector (± 16 degrees).
 Laser Button	Aim the remote at the viewing screen, press and hold this button to activate the laser pointer.
AV Mute	Momentarily turns off the audio and video. Press this button again to unlock.
Volume +/-	Increases/decreases speaker volume.
Freeze	Press “Freeze” to pause the screen image. Press this button again to unlock.
Display Mode	Select the display mode from PC, Photo, Movie, sRGB and User.
Wide	Fix to 16:9 screen.
Zoom In	Zoom in to magnify the image.
Zoom Out	Zoom out to reduce the image.
Four Directional Select Keys	Use \blacktriangle \blacktriangledown \blacktriangleleft \blacktriangleright to navigate through the menus.
Menu	Display or exits the on-screen display menus for projector.
Clear	Clear your selection.
Enter	Confirm your item selection.
Source Lock	Select auto detection all connector ports or lock current connector port. (See page 27 for more)
Video	Choose composite video source.
S-Video	Choose S-Video source.
VGA1	Choose primary VGA-In or SCART source.
VGA2	Choose secondary VGA-In source.
DVI	Choose DVI-D source.

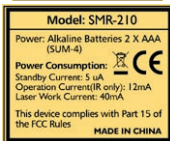

On Screen Display Menus

The Projector has multilingual On Screen Display menus that allow you to make image adjustments and change a variety of settings. The projector will automatically detect the source.

How to Operate

1. To open the OSD menu, press "Menu" on the Remote Control or Control Panel.
2. When OSD is displayed, use ◀ ▶ keys to select any item in the main menu. While making a selection on a particular page, press ▼ key to enter sub menu.
3. Use ▲ ▼ keys to select the desired item and adjust the settings by ◀ ▶ key.
4. Select the next item to be adjusted in the sub menu and adjust as described above.
5. Press "Menu" to confirm, and the screen will return to the main menu.
6. To exit, press "Menu" again. The OSD menu will close and the projector will automatically save the new settings.

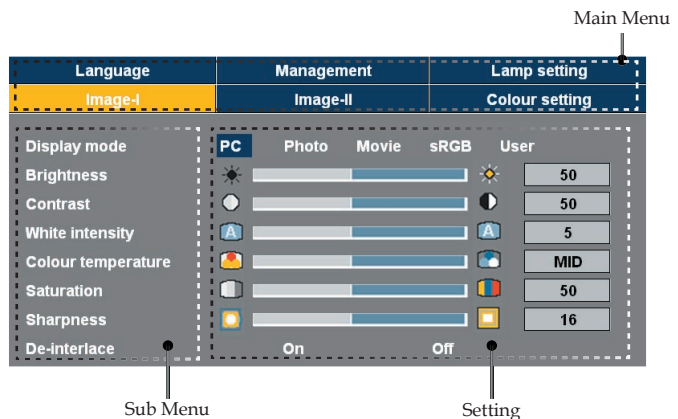

User Controls

Menu Tree

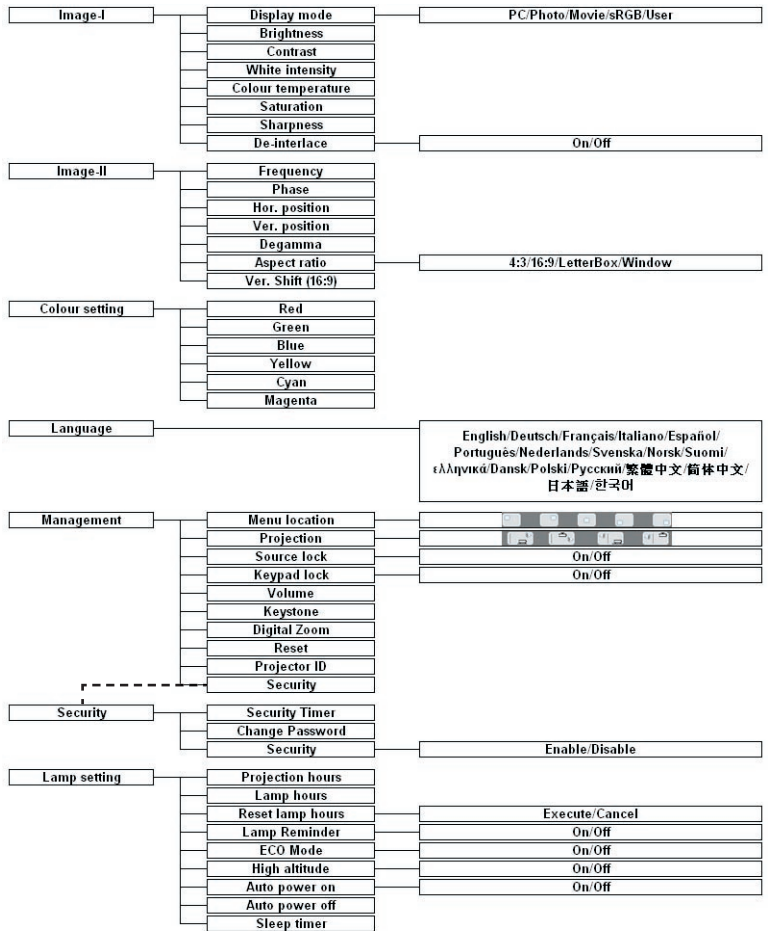

User Controls

Language	Management	Lamp setting
Image-I	Image-II	Colour setting
Display mode	PC Photo Movie sRGB User	
Brightness		50
Contrast		50
White intensity		5
Colour temperature		MID
Saturation		50
Sharpness		16
De-interface	On Off	

Image-I

Display Mode

There are many factory presets optimized for various types of images.

- ▶ PC: For computer or notebook. (brightest image)
- ▶ Photo: For optimum colour at high brightness.
- ▶ Movie: For home theater.
- ▶ sRGB: For standard PC colour. (best colour reproduction)
- ▶ User: Memorize user's settings.

Brightness

Adjust the brightness of the image.

- ▶ Press the ◀ to darken image.
- ▶ Press the ▶ to lighten the image.

Contrast

The contrast controls the degree of difference between the lightest and darkest parts of the picture. Adjusting the contrast changes the amount of black and white in the image.

- ▶ Press the ◀ to decrease the contrast.
- ▶ Press the ▶ to increase the contrast.

White Intensity

Use the white peaking control to set the white peaking level of DMD chip. 0 stands for minimal peaking, and 10 stands for maximum peaking. If you prefer a brighter image, adjust towards the maximum setting. For a smooth and more natural image, adjust towards the minimum setting.

Colour Temperature

Adjusts the colour temperature. At higher temperature, the screen looks colder; at lower temperature, the screen looks warmer.

Each display mode has its own colour temperature and can memorize user's selection. For example:

Display mode	PC	Photo	Movie	sRGB	User
Colour Temp.	sRGB	Low	User	High	Mid

When you adjust the colour setting item, the colour temperature will be set as "User" automatically. And this set "User" is the same for all display mode. (See the section of "Colour Setting" for details).

Saturation

Adjusts a video image from black and white to fully saturated colour.

- ▶ Press the ◀ to decrease the amount of saturation in the image.
- ▶ Press the ▶ to increase the amount of saturation in the image.

Sharpness

Adjusts the sharpness of the image.

- ▶ Press the ◀ to decrease the sharpness.
- ▶ Press the ▶ to increase the sharpness.

De-interlace

This function converts an interlaced video signal into progressive signal.

- ▶ On: Automatically switch the mode of Deinterlace.
- ▶ Off: Switch Deinterlace mode to video mode for video source or TV source.



- ❖ "Saturation" and "De-interlace" functions are only supported under Video mode.

User Controls

Language	Management	Lamp setting
Image-I	Image-II	Colour setting
Frequency		50
Phase		50
Hor. position		50
Ver. position		50
Degamma		3
Aspect ratio	4:3 16:9 LetterBox Window	
Ver. Shift (16:9)		50

Image-II



- ❖ “Frequency”, “Phase”, “Hor. position” and “Ver. position” functions are only supported under Computer mode.

Frequency

“Frequency” changes the display data frequency to match the frequency of your computer’s graphic card. If you experience a vertical flickering bar, use this function to make an adjustment.

Phase

“Phase” synchronizes the signal timing of the display with the graphic card. If you experience an unstable or flickering image, use this function to correct it.

Hor. Position (Horizontal Position)

- ▶ Press the ◀ to move the image left.
- ▶ Press the ▶ to move the image right.

Ver. Position (Vertical Position)

- ▶ Press the ◀ to move the image down.
- ▶ Press the ▶ to move the image up.

Degamma

This allows you to choose a degamma table that has been fine-tuned to bring out the best image quality for the input.

Aspect Ratio

Use this function to choose your desired aspect ratio.

- ▶ 4:3 : The input source will be scaled to fit the projection screen.
- ▶ 16:9 : The input source will be scaled to fit the width of the screen.
- ▶ LBX: This format is for non-16x9, letterbox source and for users who use external 16x9 lens to display 2.35:1 aspect ratio using full resolution.
- ▶ Window: When a 4:3 image is bigger than a 16:9 screen, select the “Window” mode to fit the image onto the screen without changing the projection distance.

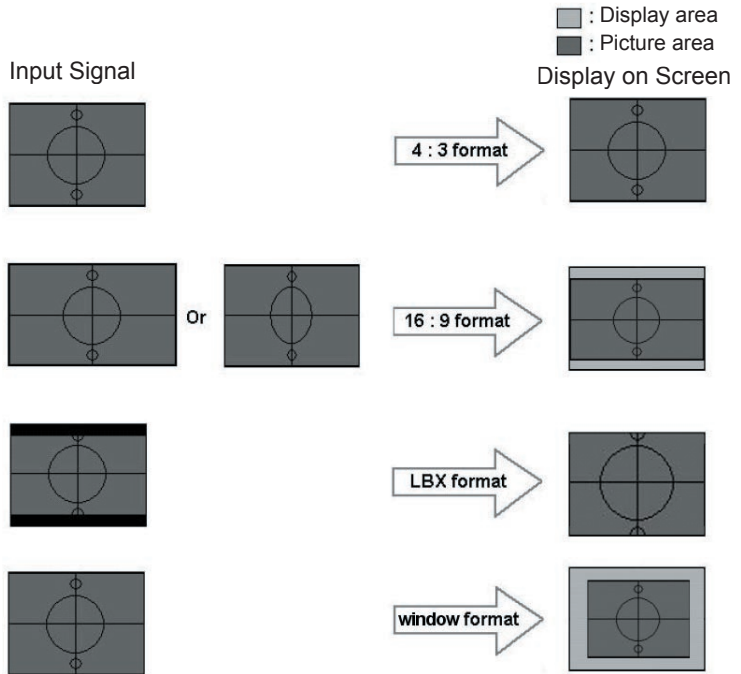

❖ Ver. Shift (16:9):
Image Position at
window mode will
also be moved ac-
cordingly.

Ver. Shift (16:9)

Adjust the image position up or down, when you select the aspect ratio of 16:9.

- ▶ Press the ◀ to move the image down.
- ▶ Press the ▶ to move the image up.

User Controls



Colour Setting

Colour Setting

- ▶ Full Range: Adjust the Red, Green and Blue color for all screen.
- ▶ Enhance Individual: Adjust the Red, Green, Blue, Yellow, Cyan and Magenta colors for advanced adjustment of the individual colors.

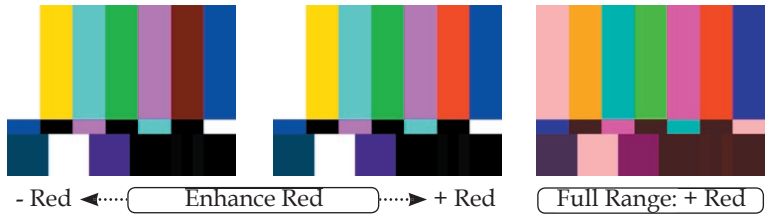

When you adjust the colour setting item, the colour temperature will be set as "User" automatically. And this set "User" is the same for all display mode. For example:

Icon	Colour Temp.
L	Low
M	Mid
U	User
S	sRGB
H	High

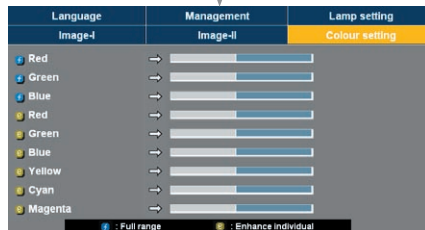
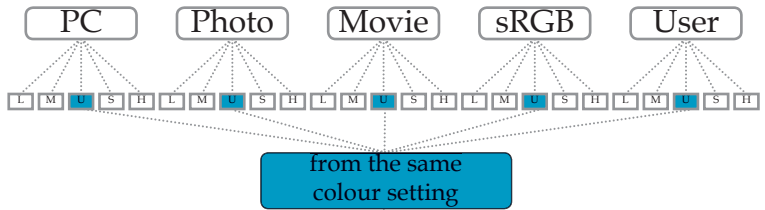

User Controls

Different color setting will be memorized at 4 different source groups. But they will be same under same source.

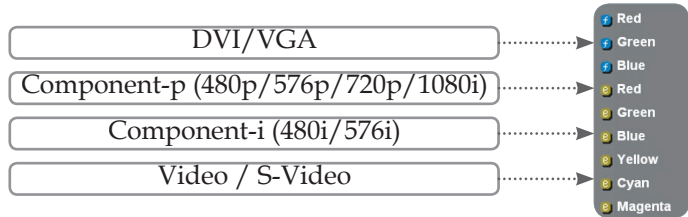

When we adjust color setting the current color temperature will be memorized before it auto switch to “User”. Because the memorized color temperature will be a base of “User”. For example:

1.) Colour temp. is Mid



2.) User creates his favorite color based on “Mid” setting of colour temperature. So when user switches colour temperature to “User”, will find the image color temperature close to “Mid”.

Language	Management	Lamp setting
Image-I	Image-II	Colour setting
f Red	→	50
f Green	→	60
f Blue	→	50
B Red	→	80
B Green	→	70
B Blue	→	60
B Yellow	→	50
B Cyan	→	40
B Magenta	→	30

User Controls

Image-I	Image-II	Colour setting
Language	Management	Lamp setting
English	Nederlands	简体中文
Français	Suomi	繁體中文
Deutsch	ελληνικά	日本語
Italiano	Dansk	한국어
Español	Norsk	
Português	Polski	
Svenska	Русский	

Language

Language

Choose the multilingual OSD menu. Use the ▲ or ▼ key to select your preferred language.

Press “Enter” to finalize the selection.

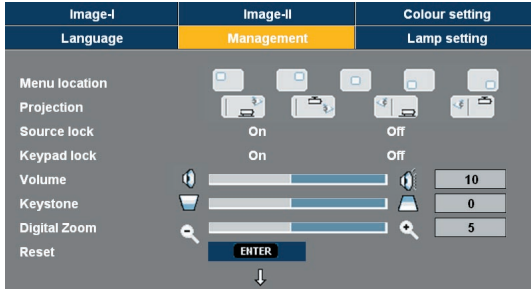

Management

Menu Location

Choose the menu location on the display screen.

Projection

- ▶  Front-Desktop

The factory default setting.

- ▶  Rear-Desktop

When you select this function, the projector reverses the image so you can project from behind a translucent screen.

- ▶  Front-Ceiling

When you select this function, the projector turns the image upside down for ceiling-mounted projection.

- ▶  Rear-Ceiling

When you select this function, the projector reverses and turns the image upside down. You can project from behind a translucent screen with ceiling mounted projection.

Source Lock

- ▶ On: The projector will search specified connection port.
- ▶ Off: The projector will search for other signals if the current input signal is lost.

Keypad Lock

- ▶ On: All buttons will lock on the control panel. When you unlock, press "Enter" for about 3 seconds on the control panel.
- ▶ Off: The control panel is worked.

User Controls

Volume

- ▶ Press ◀ to decrease the volume.
- ▶ Press ▶ to increase the volume.

Keystone (Keystone Correction)

Adjusts image distortion caused by tilting projector. (± 16 degrees)

Digital Zoom

- ▶ Press the ◀ to reduce the size of an image.
- ▶ Press the ▶ to magnify an image on the projection screen.

Reset

Choose "Enter" to return the adjustments and settings to the factory default values.

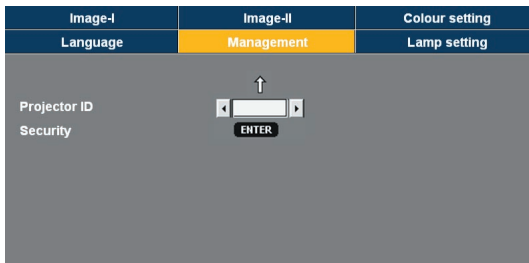

Management

Projector ID

Allows RS232 control of an individual projector. Range 01-99.

Security

- First Time:
 1. Press "Enter" to set password.
 2. The Password is 4 digits, DEFAULT VALUE is "0000". (**first time**)
 3. Use number buttons on the remote to select your password, and then press "Enter" key to confirm your selection.
- Change Password:
 1. Press "Enter" to input old password.



User Controls



2. Use number button to enter current password, and then press “Enter” key again to reveal next OSD menu.
3. Scroll down to highlight Password, and then press “Enter” to activate.
4. Enter new password (4 digits in length) using the number buttons on the remote, then press “Enter” to confirm.
5. Enter new password again and press “Enter” to confirm.

▶ Security Mode



- Security Timer: Can be select the time (month/day/hour) function to set the number of hours the projector can be used. Once this time has elapsed you will be requested to enter your password again (Use number buttons on remote. To change password, follow change password instructions above).
- Enable: Choose “Enable” to enable security verification when turning on the projector.
- Disable: Choose “Disable” to be able to switch on the projector without password verification.



Image-I	Image-II	Colour setting
Language	Management	Lamp setting
Projection hours	 <input type="text" value="50"/> hr	
Lamp hours	 <input type="text" value="50"/> hr	
Reset lamp hours	Execute	<input type="button" value="Cancel"/>
Lamp Reminder	On	<input type="button" value="Off"/>
ECO Mode	On	<input type="button" value="Off"/>
High altitude	On	<input type="button" value="Off"/>
Auto power on	On	<input type="button" value="Off"/>
Auto power off	<input type="text" value=""/>	<input type="text" value="0"/> min
Sleep timer	<input type="text" value=""/>	<input type="text" value="0"/> min

Lamp Setting

Projection Hours

Displays the projection time.

Lamp Hours

Displays the cumulative lamp operating time.

Reset Lamp Hours

Resets the lamp life hour counter after replacing the lamp.

Lamp Reminder

Choose this function to show or to hide the warning message when the changing lamp message is displayed. The message will appear 30 hours before end of life.

ECO Mode

Choose "On" to dim the projector lamp which will lower power consumption and extend the lamp life by up to 130%. Choose "Off" to return to normal mode.

High Altitude

Choose "On" to turn on High Altitude mode. Operates the fans at full speed continuously to allow for proper high altitude cooling of the projector.

Auto Power On

Choose "On" to power on the projector automatically when the power cord has connected. Choose "Off" to return to normal mode.

Auto Power Off

Sets the countdown timer interval. The countdown timer will start, when there is no signal being sent to the projector. Then projector will automatically power off when the countdown has finished.

Sleep Timer

Sets the countdown timer interval. The timer will begin, with or without a signal input. Then the projector will automatically power off then the sleep timer countdown has finished.

Troubleshooting

If you experience trouble with the projector, refer to the following information. If the problem persists, please contact your local reseller or service center, see page 40 for details.

Problem: No image appears on screen

- ▶ Ensure all the cables and power connections are correctly and securely connected as described in the “Installation” section.
- ▶ Ensure the pins of connectors are not crooked or broken.
- ▶ Check if the projection lamp has been securely installed. Please refer to the “Replacing the lamp” section.
- ▶ Make sure you have removed the lens cap and the projector is switched on.
- ▶ Ensure that the “AV Mute” feature is not turned on.

Problem: Left of right edge of the image is missing or the image is unstable or noisy

- ▶ Press “Re-Sync” on the remote control or on control panel.
- ▶ If you are using a PC:

For Windows 3.x:

1. In the Windows Program Manager, double click the “Windows Setup” icon in the Main group.
2. Verify that your display resolution setting is less than or equal to 1400 x 1050.

For Windows 95, 98, 2000, XP:

1. From the “My Computer” icon, open the “Control Panel” folder, and double click the “Display” icon.
2. Select the “Settings” tab.
3. Click on the “Advanced Properties” button.

If the projector is still not projecting the whole image, you will also need to change the monitor display you are using. Refer to the following steps.

4. Verify the resolution setting is less than or equal to 1400 x 1050 resolution.

Appendices

5. Select the “Change” button under the “Monitor” tab.
 6. Click on “Show all devices.” Next, select “Standard monitor types” under the SP box; choose the resolution mode you need under the “Models” box.
- ▶ If you are using a Notebook:
1. First, follow the steps above to adjust resolution of the computer.
 2. Press the toggle output settings. example: [Fn]+[F4]

Compaq=>	[Fn]+[F4]	Hewlett =>	[Fn]+[F4]
Dell =>	[Fn]+[F8]	Packard =>	[Fn]+[F4]
Gateway=>	[Fn]+[F4]	NEC=>	[Fn]+[F3]
IBM=>	[Fn]+[F7]	Toshiba =>	[Fn]+[F5]

Mac Apple:
System Preference-->Display-->Arrangement-->Mirror display

- ▶ If you experience difficulty changing resolutions or your monitor freezes, restart all equipment including the projector.

Problem: The screen of the Notebook or PowerBook computer is not displaying a presentation

- ▶ If you are using a Notebook PC:

Some Notebook PCs may deactivate their own screens when a second display device is in use. Each has a different way to be reactivated. Refer to your computer’s documentation for detailed information.

Problem: Image is unstable or flickering

- ▶ Use “Phase” to correct it. (See page 22)
- ▶ Change the monitor colour setting on your computer.

Problem: Image has vertical flickering bar

- ▶ Use “Frequency” to make an adjustment. (See page 22)
- ▶ Check and reconfigure the display mode of your graphic card to make it compatible with the product.

Problem: Image is out of focus

- ▶ Adjusts the Focus Ring on the projector lens.

- ▶ Make sure the projection screen is between distance 3.9 to 39.4 feet (1.2 to 12.0 meters) from the projector. (See page 15)

Problem: The image is stretched when displaying 16:9 DVD

The projector automatically detects 16:9 DVD and adjusts the aspect ratio by digitizing to full screen with 4:3 default setting.

If the image is still stretched, you will also need to adjust the aspect ratio by referring to the following:

- ▶ Please select 4:3 aspect ratio type on your DVD player if you are playing a 16:9 DVD.
- ▶ If you can't select 4:3 aspect ratio type on your DVD player, please select 4:3 aspect ratio in the on screen menu.

Problem: Image is reversed

- ▶ Select "Management-->Projection" from the OSD and adjust the projection direction. (See page 27)

Problem: Lamp burns out or makes a popping sound

- ▶ When the lamp reaches its end of life, it will burn out and may make a loud popping sound. If this happens, the projector will not turn on until the lamp module has been replaced. To replace the lamp, follow the procedures in the "Replacing the Lamp". (See page 36)

Problem: LED lighting message

Message	Power-LED		Temp-LED	Lamp-LED
	(Green)	(Red)		
Standby State (Input power cord)	○	☀	○	○
Warming	Flashing	○	○	○
Normal Mode	☀	○	○	○
Cooling	○	Flashing	○	○
Error (Lamp failed)	○	○	○	☀
Error (Fan failed)	○	○	○	Flashing
Error (Over Temp.)	○	○	☀	○



Steady light => ☀
No light => ○

Problem: Message Reminders

▶ Fan fail:

Warning ! FAN LOCKED

The projector will switch off automatically

Please contact a service centre for repair

▶ Over temperature:

Warning ! TEMPERATURE TOO HIGH

The projector will switch off automatically

Please:

1. Allow cool down for 3 minutes

2. Make sure air in and outlets are not blocked

3. Make sure the environment temperature is under 35 degree C

If the problem persists in spite of the above,
please contact a service centre for repair.

▶ Power Off:

Wait 1 minutes before you can switch on again.

Press Power key again to confirm.

Press "Enter" key to remove this warning.

▶ Replace the lamp:

! Lamp life exceeded.

Replacing the Lamp

The projector keeps track of the lamp usage. It will show you a warning message

 **Lamp life exceeded.**



 **Warning:** Lamp compartment is hot! Allow 30 minutes to cool down before changing lamp!

When you see this message, change the lamp as soon as possible. Make sure the projector has cooled down for at least 30 minutes before changing the lamp.

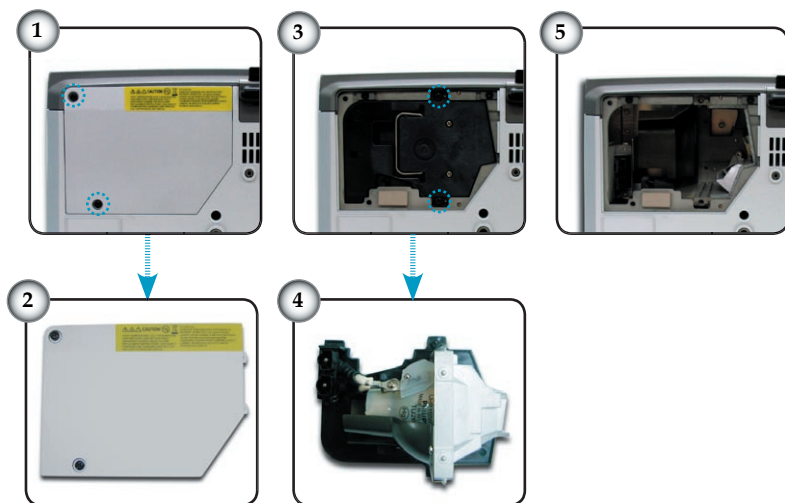

 **Warning:** To reduce the risk of personal injury, do not drop the lamp module or touch the lamp bulb. The bulb may shatter and cause injury if it is dropped.

Lamp Replacement Procedure:

1. Switch off the power to the projector by pressing the Power/ Standby button.
2. Allow the projector to cool down for at least 30 minutes.
3. Disconnect the power cord.
4. Use a screwdriver to remove the screws from the cover. ❶
5. Push up and remove the cover. ❷
6. Remove the 2 screws from the lamp module. ❸
7. Pull out the lamp module. ❹

To replace the lamp module, reverse the previous steps.

Compatibility Modes

Mode	Resolution	(ANALOG)		(DIGITAL)	
		V.Frequency (Hz)	H.Frequency (kHz)	V.Frequency (Hz)	H.Frequency (kHz)
VESA VGA	640 x 350	70	31.5	70	31.5
VESA VGA	640 x 350	85	37.9	85	37.9
VESA VGA	640 x 400	85	37.9	85	37.9
VESA VGA	640 x 480	60	31.5	60	31.5
VESA VGA	640 x 480	72	37.9	72	37.9
VESA VGA	640 x 480	75	37.5	75	37.5
VESA VGA	640 x 480	85	43.3	85	43.3
VESA VGA	720 x 400	70	31.5	70	31.5
VESA VGA	720 x 400	85	37.9	85	37.9
VESA SVGA	800 x 600	56	35.2	56	35.2
VESA SVGA	800 x 600	60	37.9	60	37.9
VESA SVGA	800 x 600	72	48.1	72	48.1
VESA SVGA	800 x 600	75	46.9	75	46.9
VESA SVGA	800 x 600	85	53.7	85	53.7
VESA XGA	1024 x 768	60	48.4	60	48.4
VESA XGA	1024 x 768	70	56.5	70	56.5
VESA XGA	1024 x 768	75	60.0	75	60.0
VESA XGA	1024 x 768	85	68.7	85	68.7
* VESA SXGA	1152 x 864	70	63.8	70	63.8
* VESA SXGA	1152 x 864	75	67.5	75	67.5
* VESA SXGA	1152 x 864	85	77.1	85	77.1
* VESA SXGA	1280 x 1024	60	63.98	60	63.98
* VESA SXGA	1280 x 1024	75	79.98	75	79.98
* VESA SXGA+	1400 x 1050	60	63.98	60	63.98
MAC LC 13"	640 x 480	66.66	34.98	***	***
MAC II 13"	640 x 480	66.68	35	***	***
MAC 16"	832 x 624	74.55	49.725	***	***
MAC 19"	1024 x 768	75	60.24	***	***
* MAC	1152 x 870	75.06	68.68	***	***
MAC G4	640 x 480	60	31.35	***	***
i MAC DV	1024 x 768	75	60	***	***
* i MAC DV	1152 x 870	75	68.49	***	***
* i MAC DV	1280 x 960	60	60	***	***



Remark : "*" compressed computer image.

RS232 Commands

RS232 Connector

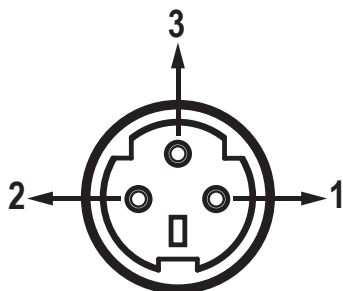

Pin no.	Name	I/O (From Projector Side)
1	TXD	OUT
2	RXD	IN
3	GND	—

VGA-In Connector

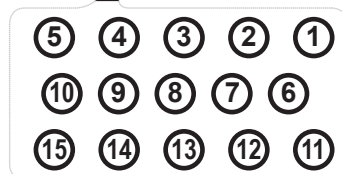
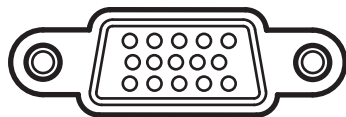

Pin no.	Spec.
1	R(REDF)/Cr
2	G(GREEN)/Y
3	B(BLUE)/Cb
4	NC
5	GND
6	GND
7	GND
8	GND
9	DDC 5V
10	HOT_DET
11	NC
12	DDC Date
13	HS/CS
14	VS
15	DDC Clock

Ceiling Mount Installation

1. To prevent damaging your projector, please use the ceiling mount package for installation.
2. If you wish to use a third party ceiling mount kit, please ensure the screws used to attached a mount to the projector meet the following specifications:

- ▶ **Screw type: M3**
- ▶ **Maximum screw length: 10mm**
- ▶ **Minimum screw length: 8mm**



❖ Please note that damage resulting from incorrect installation will invalidate the warranty.



⚠ Warning:

1. If you buy the ceiling mount from another manufacturer, please ensure that there is at least 10cm distance between the bottom cover of the projector and the ceiling.
2. Avoid placing the projector near sources of heat such as air-conditioning units and heaters otherwise it may overheat and shut down automatically.

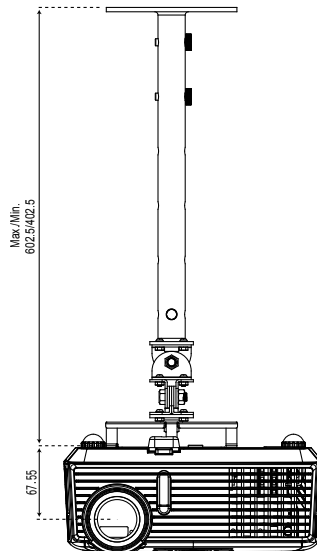
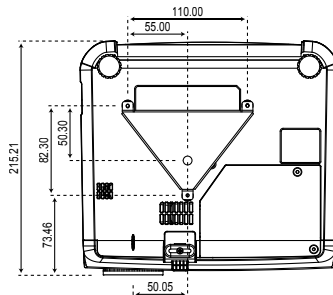

Optoma Global Offices

For service or support please contact your local office.

USA

715 Sycamore Drive
Milpitas, CA 95035, USA
www.optomausa.com

Tel : 408-383-3700
Fax: 408-383-3702
Service : service@optoma.com

Canada

120 West Beaver Creek Road Unit #9
Richmond Hill, ON L4B 1L2, Canada
Tel : 905-882-4228
www.optoma.com

Fax: 905-882-4229

Europe

42 Caxton Way, The Watford Business Park
Watford, Hertfordshire, WD18 8QZ, UK

Tel : +44 (0) 1923 691 800
www.optomaeurope.com

Fax: +44 (0) 1923 691 888

Service Tel : +44 (0)1923 691865

Service : service@tsc-europe.com

Taiwan

5F., No. 108, Minchiuan Rd.
Shindian City, Taipei Taiwan 231,
R.O.C.

Service : services@optoma.com.tw

Tel : +886-2-2218-2360

Fax: +886-2-2218-2313

www.optoma.com.tw

asia.optoma.com

Hong Kong

Rm. 2507, 25/F., China United Plaza,
No. 1008 Tai Nan West St., Kowloon, H.K.

Tel : +852-2396-8968

Fax: +852-2370-1222

www.optoma.com.hk

China

5F, No. 1205, Kaixuan Rd.,
Changning District
Shanghai, 200052, China

Tel : +86-21-62947376

Fax: +86-21-62947375

www.optoma.com.cn

Latin America

715 Sycamore Drive
Milpitas, CA 95035, USA
www.optoma.com.br

Tel : 408-383-3700

Fax: 408-383-3702

www.optoma.com.mx