

myprojectorlamps.com

**The most trusted, dependable name
in projector lamp sales.**



<http://www.myprojectorlamps.com>



<http://www.myprojectorlamps.ca>



<http://www.myprojectorlamps.eu>

The following projector manual has not been modified or altered in any way.











Table of Contents

Table of Contents	1
Usage Notice.....	2
<i>Precautions</i>	2
Introduction.....	4
<i>Product Features</i>	4
<i>Package Overview</i>	5
<i>Product Overview</i>	6
<i>Main Unit</i>	6
<i>Control Panel</i>	7
<i>Connection Ports</i>	8
<i>Remote Control with Mouse Function and Laser Pointer</i>	9
Installation	10
<i>Connecting the Projector</i>	10
<i>Connect the Computer/Notebook</i>	10
<i>Connect the Video</i>	11
<i>Powering On/Off the Projector</i>	12
<i>Powering On the Projector</i>	12
<i>Powering Off the projector</i>	13
<i>Warning Indicator</i>	13
<i>Adjusting the Projected Image</i>	14
<i>Adjusting the Projector Image Height</i>	14
<i>Adjusting the Projector Zoom / Focus</i>	15
<i>Adjusting Projected Image Size</i>	15
User Controls	16
<i>Control Panel & Remote Control</i>	16
<i>On-Screen Display Menus</i>	19
<i>How to Operate</i>	19
<i>Menu Tree</i>	20
<i>Image</i>	21
<i>Display</i>	25
<i>Setup</i>	28
<i>Options</i>	30
Appendices.....	34
<i>Troubleshooting</i>	34
<i>Replacing the Lamp</i>	38
<i>Compatibility Modes</i>	39
<i>RS232 Commands</i>	40
<i>Ceiling Mount Installation</i>	41
<i>Optoma Global Offices</i>	42



Precautions

Follow all warnings, precautions and maintenance as recommended in this user's guide to maximize the life of your unit.

-  Warning - Do not look into the projector's lens when the lamp is on. The bright light may hurt your eyes.
-  Warning - To reduce the risk of fire or electric shock, do not expose this product to rain or moisture.
-  Warning - Please do not open or disassemble the product as this may cause electric shock.
-  Warning - When changing the lamp, please allow unit to cool down, and follow all changing instructions.
-  Warning - This product will detect the life of the lamp itself. Please be sure to change the lamp when it shows warning messages.
-  Warning - Reset the "Reset Lamp Hours" function from the On Screen Display "Lamp Setting" menu after replacing the lamp module (refer to page 31).
-  Warning - When switching the projector off, please ensure the projector completes its cooling cycle before disconnecting power.
-  Warning - Turn on the projector first and then the signal sources.
-  Warning - Do not use lens cap when projector is in operation.
-  Warning - When the lamp reaches the end of its life, it will burn out and may make a loud popping sound. If this happens, the projector will not turn back on until the lamp module has been replaced. To replace the lamp, follow the procedures listed under "Replacing the Lamp". (see page 38)



Usage Notice

Do:

- ❖ Turn off the product before cleaning.
- ❖ Use a soft cloth moistened with mild detergent to clean the display housing.
- ❖ Disconnect the power plug from AC outlet if the product is not being used for a long period of time.

Don't:

- ❖ Block the slots and openings on the unit provided for ventilation.
- ❖ Use abrasive cleaners, waxes or solvents to clean the unit.
- ❖ Use under the following conditions:
 - In extremely hot, cold or humid environments.
 - In areas susceptible to excessive dust and dirt.
 - Near any appliance that generates a strong magnetic field.
 - In direct sunlight.



Product Features

Congratulations and Thank You for choosing an EP1690 projector, an Optoma Product. This product is a WXGA single chip 0.65" DLP™ projector. Outstanding features include:

- ◆ True WXGA, 1280 X 768 addressable pixels
- ◆ Texas Instruments Single chip DLP™ Technology
- ◆ NTSC/NTSC4.43/PAL/PAL-M/PAL-N/SECAM and HDTV compatible (480i/p, 576i/p, 720p, 1080i)
- ◆ Multi-Auto functions: Auto detection, Automatic saving of user adjustments
- ◆ Full function IR remote control with laser pointer
- ◆ User friendly multilingual on screen menu
- ◆ Advanced digital keystone correction and high quality full screen image re-scaling
- ◆ User friendly control panel
- ◆ One built-in speaker with 3 Watt amplifier
- ◆ Multiple for Audio inputs
- ◆ SXGA, SXGA+ compression and XGA, SVGA, VGA re-sizing
- ◆ Mac compatible
- ◆ DVI support (HDCP compliant)



Introduction

Package Overview

This projector comes with all the items shown below. Check to make sure your unit is complete. Contact your dealer immediately if anything is missing.



Projector with lens cap



Power Cord 1.8m



VGA Cable 1.8m



RS232 Cable 1.8m



USB Cable 1.8m



Wireless Remote Controller



Due to the difference in applications for each country, some regions may have different accessories.



2 x AA Batteries



Composite Video Cable 1.8m (available in USA and ASIA regions only)



SCART VGA/S-Video Adaptor (available in European region only)



S-Video Cable 1.8m (available in European region only)

Documents :

- User's Guide*
- Quick Start Card*
- Warranty Card*
- Quick Troubleshooting Guide*



Product Overview

Main Unit



1. Control Panel
2. Zoom Lever
3. Focus Ring
4. Elevator Button (one on each side)
5. Elevator Foot
6. IR Receivers
7. Power Button
8. Power Socket
9. Connection Ports



Introduction

Control Panel

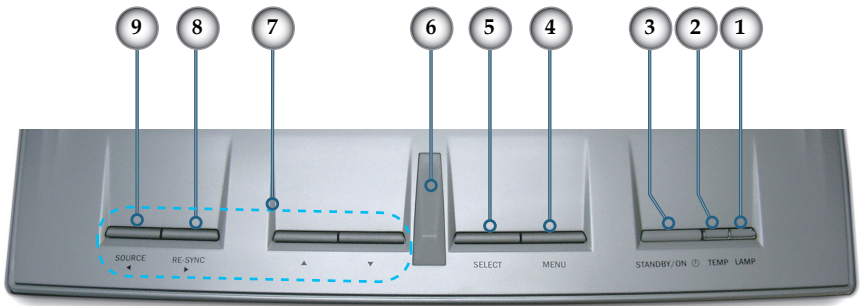

1. Lamp Indicator LED
2. Temp Indicator LED
3. Standby/ON LED
4. Menu (On/Off)
5. Select
6. IR Receiver
7. Four Directional Select Keys
8. Re-Sync
9. Source



Connection Ports

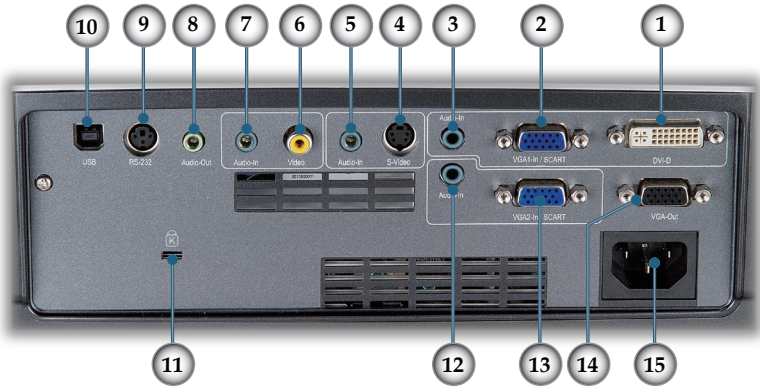

1. DVI-D Input Connector (PC Digital/HDCP Input)
2. VGA-In Connector (PC Analog signal/HDTV/Component Video Input)
3. Audio Input Connector (For DVI-D or VGA1-In SCART)
4. S-Video Input Connector
5. Audio Input Connector (For S-Video)
6. Composite Video Input Connector
7. Audio Input Connector (For Composite)
8. Audio Output Connector
9. RS232 Connector
10. USB Connector (Connect to PC for Remote Mouse function)
11. Kensington™ Lock Port
12. Audio Input Connector (For VGA2-In SCART)
13. VGA-In SCART Connector (PC Analog signal/HDTV/Component Video Input)
14. Monitor Loop-through Output Connector
15. Power Socket



Introduction

Remote Control with Mouse Function and Laser Pointer

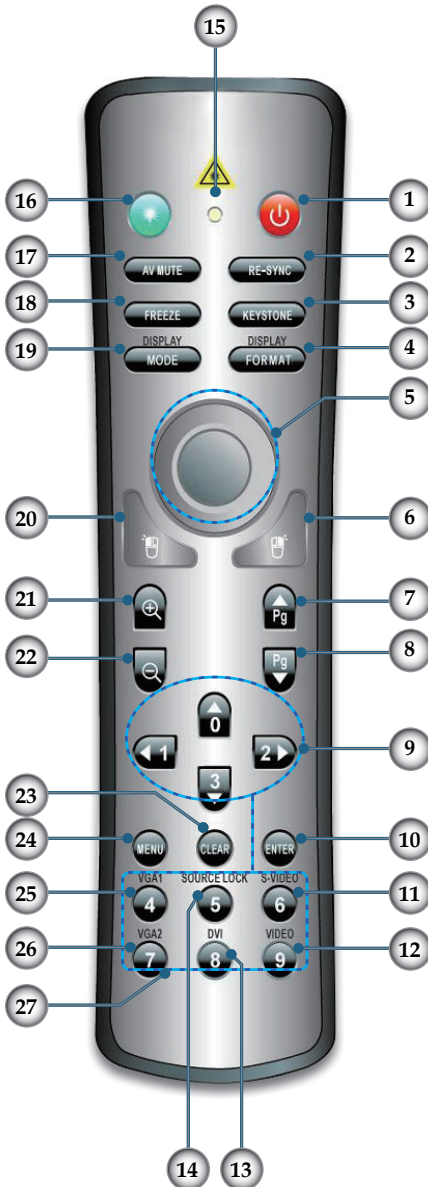

1. Power
2. Re-sync
3. Vertical Keystone
4. Display Format
5. Mouse
6. Mouse Right Click
7. Mouse Page Up
8. Mouse Page Down
9. Four Directional Select Keys
10. Enter
11. S-Video Source
12. Composite Video Source
13. DVI Source
14. Source Lock
15. Button LED
16. Laser Button
17. AV Mute
18. Freeze
19. Display Mode
20. Mouse Left Click
21. Zoom In
22. Zoom Out
23. Clear
24. Menu
25. VGA1 Source
26. VGA2 Source
27. Number Buttons



Connecting the Projector

Connecting Computer/Notebook



Due to the difference in applications for each country, some regions may have different accessories.

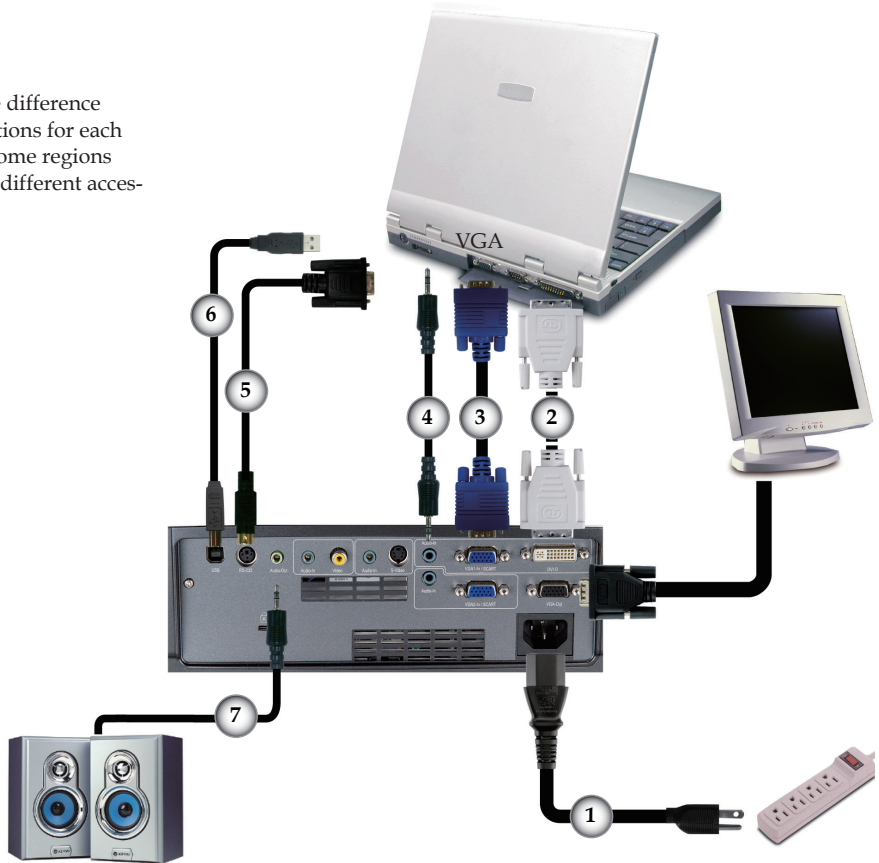

Audio Output (For Active Speakers)

- | | |
|--------|--------------------|
| 1..... | Power Cord |
| 2..... | DVI to DVI Cable |
| 3..... | VGA to VGA Cable |
| 4..... | Audio Input Cable |
| 5..... | RS232 Cable |
| 6..... | USB Cable |
| 7..... | Audio Output Cable |



Installation

Connecting Video

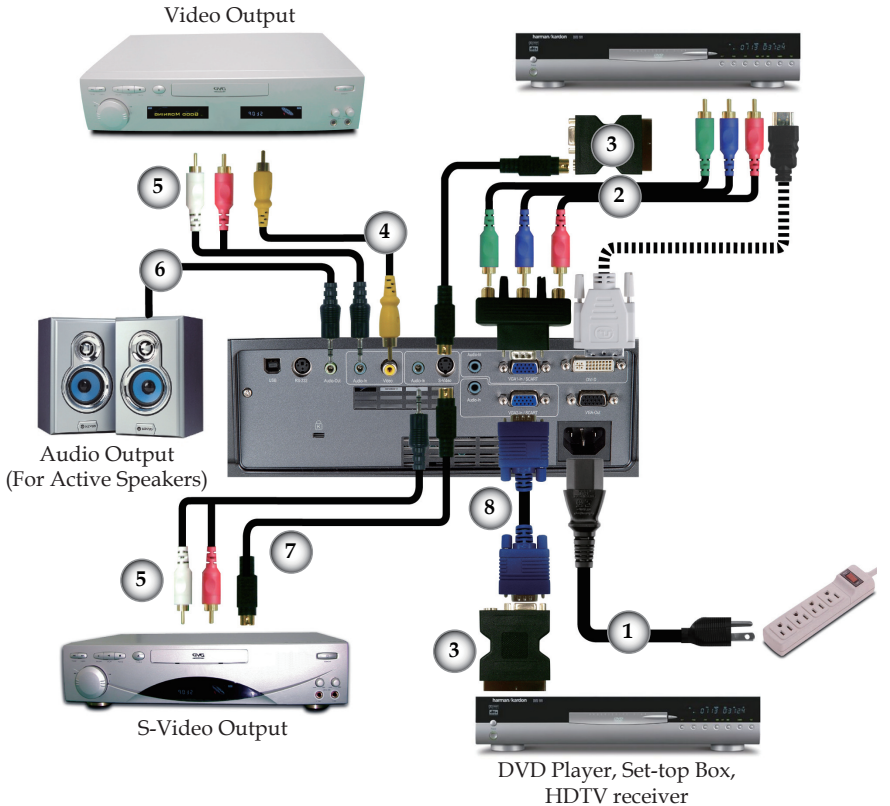

- 1.....Power Cord
- 2.....RCA Component Cable for YPbPr
- 3.....SCART VGA/S-Video Adaptor
- 4.....Composite Video Cable
- 5.....Audio Input Cable
- 6.....Audio Output Cable
- 7.....S-Video Cable
- 8.....VGA to VGA Cable



Due to the difference in applications for each country, some regions may have different accessories.



Powering On/Off the Projector

Powering On the Projector

1. Remove the lens cap. ❶
2. Ensure that the power cord and signal cable are securely connected. The Power LED will flash green.
3. Turn on the lamp by pressing “Standby/ON” button on the control panel. ❷ And the Power LED will turn green.
4. Turn on your source (computer, notebook, video player, etc.). The projector will detect your source automatically.

❖ *If you connect multiple sources at the same time, use the “Source” button on the control panel or direct source key on remote control to switch.*



NOTE

Turn on the projector first and then the signal sources.



Powering Off the Projector

1. Press the “Standby/ON” button to turn off the projector lamp; you will see a message displayed on the projector’s screen.

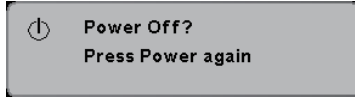

Press the “Standby/ON” button again to confirm, otherwise the message will disappear after 5 seconds.

2. The cooling fans continue to operate for about 30 seconds for the cooling cycle. When the Power LED starts flashing, the projector has entered standby mode.
Once in standby mode, simply press “Standby/ON” button to restart the projector.
3. Disconnect the power cord from the electrical outlet and the projector.
4. Do not turn on the projector immediately following a power off procedure.

Warning Indicator

- ❖ When the “TEMP” indicator turns red, it indicates the projector has overheated. The projector will automatically shut itself down.
- ❖ When the “LAMP” indicator turns red, it indicates a problem with the lamp. Turn off the projector and disconnect the power cord from the electrical outlet, then contact your local dealer or our service center. See page 42.
- ❖ When the “LAMP” indicator flashes red, it indicates the fan has failed. Stop using the projector and disconnect the power cord from the electrical outlet, then contact your local dealer or our service center. See page 42.



Adjusting the Projected Image

Adjusting the Projector Image Height

The projector is equipped with elevator feet for adjusting the image height.

To raise the image:

1. Press the elevator buttons **1**.
2. Raise the image to the desired height, then release the button to lock the elevator foot **2** into position.
3. Use tilt adjusting feet **3** to fine tune the display angle.

To lower the image:

1. Press the elevator buttons.
2. Lower the image, then release the button to lock the elevator feet into position.
3. Use tilt adjusting feet **3** to fine tune the display angle.



Installation

Adjusting the Projector Zoom / Focus

You may turn the zoom lever to zoom in or out. To focus the image, rotate the focus ring until the image is clear. The projector will focus at distances from 4.9 to 40.0 feet (1.5 to 12.2 meters).



Adjusting Projection Image Size

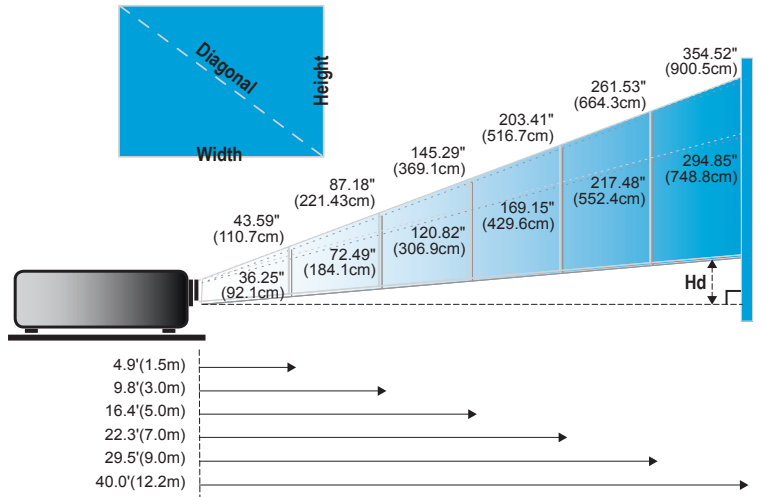

Screen (Diagonal)	Max.	43.59" (110.7cm)	87.18" (221.4cm)	145.29" (369.0cm)	203.41" (516.7cm)	261.53" (664.3cm)	354.52" (900.5cm)
	Min.	36.25" (92.1cm)	72.49" (184.1cm)	120.82" (306.9cm)	169.15" (429.6cm)	217.48" (552.4cm)	294.85" (748.8cm)
Screen Size	Max. (WxH)	37.38" x 22.43" 94.94x 56.96cm	74.75" x 44.85" 189.9 x 113.9cm	124.59" x 74.75" 316.5 x 189.9cm	174.42" x 104.65" 443.0 x 265.8cm	224.26" x 134.56" 569.6 x 341.8cm	304.00" x 182.40" 772.2 x 463.3cm
	Min. (WxH)	31.08" x 18.65" 78.9 x 47.4cm	62.16" x 37.30" 157.9 x 94.7cm	103.61" x 62.16" 263.2 x 157.9cm	145.05" x 87.03" 368.4 x 221.1cm	186.49" x 111.89" 473.7 x 284.2cm	252.80" x 151.68" 642.1 x 385.3cm
Hd	Max.	7.18" (18.2cm)	14.35" (36.5cm)	23.92" (60.8cm)	33.49" (85.1cm)	43.06" (109.4cm)	58.37" (148.3cm)
	Min.	5.97" (15.2cm)	11.94" (30.3cm)	19.89" (50.5cm)	27.85" (70.7cm)	35.81" (90.9cm)	48.54" (123.3cm)
Distance		4.9' (1.5m)	9.8' (3.0m)	16.4' (5.0m)	22.3' (7.0m)	29.5' (9.0m)	40.0' (12.2m)

❖ This graph is for user's reference only.



Control Panel & Remote Control

There are two ways for you to control the functions: Remote Control and Control Panel.

Control Panel



Using the Control Panel

Standby/ON	Refer to the “Power On/Off the Projector” section on pages 12-13.
Source	Press “Source” to select an input signal.
Menu	Turns the menu On or Off.
Four Directional Select Keys	Use ▲ ▼ ◀ ▶ to navigate through the menus.
Select	Confirm your item selection.
Re-Sync	Automatically synchronizes the projector to the input source.



User Controls

Remote Control



❖ Mouse controls require USB connection to computer.

Using the Remote Control

Power	Refer to the “Power On/Off the Projector” section on pages 12-13.
Re-Sync	Automatically synchronizes the projector to the input source.
Vertical Keystone	Adjusts image distortion caused by tilting the projector .
Display Format	Display the “Format” section of the on-screen display menu to select the desired format.
Laser Button	Aim the remote at the viewing screen, press and hold this button to activate the laser pointer.
AV Mute	Momentarily turns off the audio and video.
Freeze	Press “Freeze” to pause the screen image.
Display Mode	Select the display mode from Cinema, sRGB, Bright, TV and User.
Mouse Control	Use this button to navigate the mouse on the page.
Mouse Right Click	Mouse right click.
Mouse Left Click	Mouse left click.
Mouse Page Up	Use this button to page up.
Mouse Page Down	Use this button to page down.
Zoom In	Zoom in to magnify the image.
Zoom Out	Zoom out to reduce the image.
Four Directional Select Keys	Use ▲ ▼ ◀ ▶ to navigate through the menus.
Menu	Display or exits the on-screen display menus for projector.
Clear	Clear your selection.
Enter	Confirm your item selection.
Source Lock	Select auto detection all connector ports or lock current connector port.



Using the Remote Control

Video	Choose composite video source.
S-Video	Choose S-video source.
VGA1	Choose primary VGA-In source or SCART source.
VGA2	Choose secondary VGA-In source or SCART source.
DVI	Choose DVI-D source.



On-screen Display Menus

The Projector has multilingual On-screen Display menus that allow you to make image adjustments and change a variety of settings. The projector will automatically detect the source.

How to operate

1. To open the OSD menu, press “Menu” on the Remote Control or Control Panel.

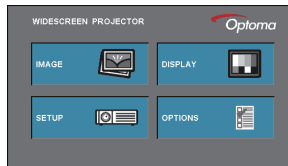

2. When OSD is displayed, use ◀ ▶ keys to select any item in the main menu. While making a selection on a particular page, press “Select (Enter)” key to enter sub menu.
3. Use ▲ ▼ keys to select the desired item and adjust the settings by ◀ ▶ key.
4. Select the next item to be adjusted in the sub menu and adjust as described above.
5. Press “Select (Enter)” to confirm, and the screen will return to the main menu.
6. To exit, press “Menu” again. The OSD menu will close and the projector will automatically save the new settings.

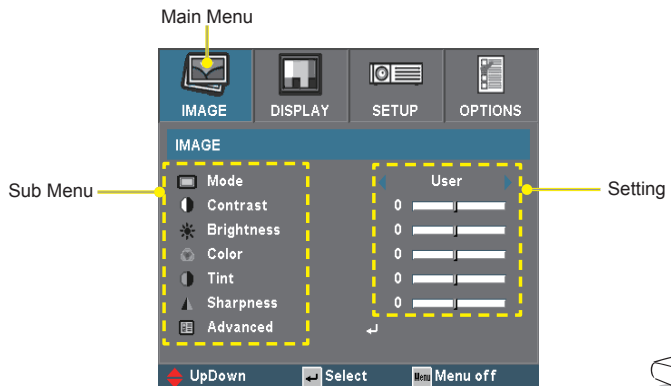

Menu Tree

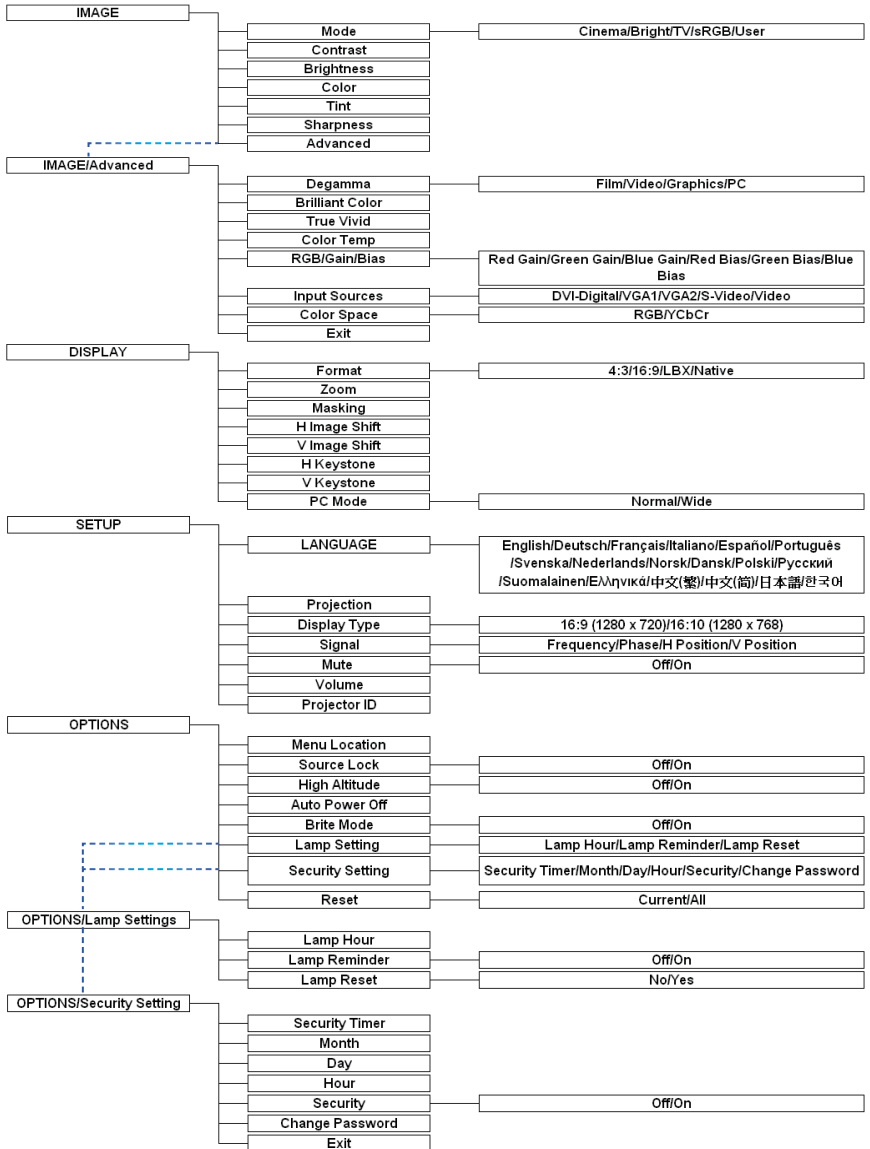

Image

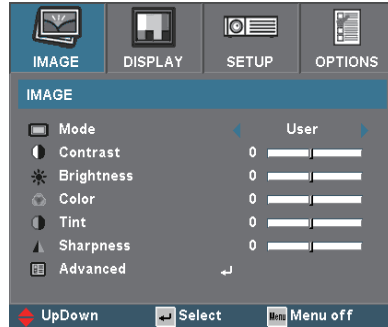

Mode

There are many factory presets optimized for various types of images.

- ▶ Cinema: For home theater.
- ▶ Bright
- ▶ TV
- ▶ sRGB: For Standard PC color (best color reproduction).
- ▶ User: Memorize user's settings.

Contrast

The contrast controls the degree of difference between the lightest and darkest parts of the picture. Adjusting the contrast changes the amount of black and white in the image.

- ▶ Press the ◀ to decrease the contrast.
- ▶ Press the ▶ to increase the contrast.

Brightness

Adjust the brightness of the image.

- ▶ Press the ◀ to darken image.
- ▶ Press the ▶ to lighten the image.

Color

Adjusts a video image from black and white to fully saturated color.

- ▶ Press the ◀ to decrease the amount of color in the image.
- ▶ Press the ▶ to increase the amount of color in the image.



"Color" function is only supported under Video mode.



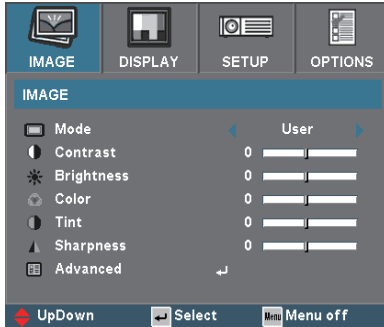

Image



“Tint” function is only supported under Video mode.

Tint

Adjusts the color balance of red and green.

- ▶ Press the ◀ to increase the amount of green in the image.
- ▶ Press the ▶ to increase the amount of red in the image.

Sharpness

Adjusts the sharpness of the image.

- ▶ Press the ◀ to decrease the sharpness.
- ▶ Press the ▶ to increase the sharpness.



Image/Advanced

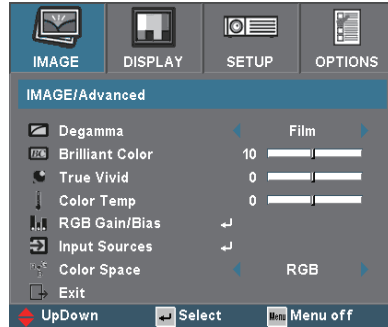

Degamma

This allows you to choose a degamma table that has been fine-tuned to bring out the best image quality for the input.

- ▶ Film: For home theater.
- ▶ Video: For video or TV source.
- ▶ Graphics: For image source.
- ▶ PC: For PC or computer source.

Brilliant Color

This adjustable item utilizes a new color-processing algorithm and system level enhancements to enable higher brightness while providing true, more vibrant colors in picture. The range is from "0" to "10". If you prefer a stronger enhanced image, adjust toward the maximum setting. For a smoother, more natural image, adjust toward the minimum setting.

True Vivid

This follows you to choose the degamma mode and enhancements to enable the picture's vividness to be significantly increased. The range is from "0" to "3".

Color Temp.

Adjust the color temperature. The range is from "0" to "2". At higher temperature, the screen looks colder; at lower temperature, the screen looks warmer.



User Controls

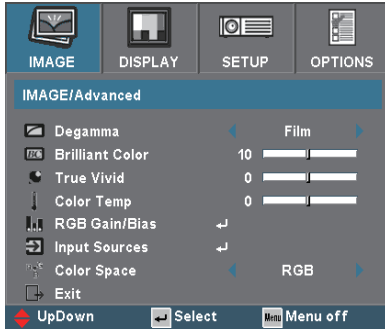
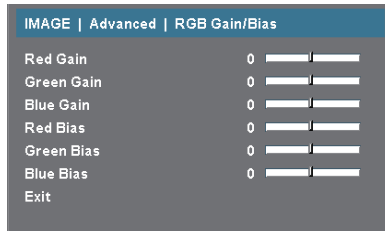

Image / Advanced

RGB/Gain/Bias

Press ◀ or ▶ into the next menu as below and then use ▲ or ▼ to select item. Use ◀ or ▶ to select Red, Green, or Blue for brightness (Gain) and contrast (Bias).



Input Source

Enable or disable input sources. Press ◀ or ▶ into the next menu as below and then use ▲ or ▼ to select. Press "Select (Enter)" to finalize the selection. The projector will not search inputs that are de-selected.

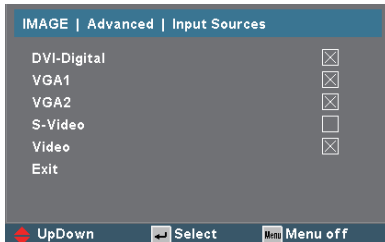

Color Space

Select an appropriate color matrix type from RGB or YPbPr.



Display



Format

Use this function to choose your desired aspect ratio.

- ▶ 4:3: This format is for 4x3 input sources not enhanced for Wide-screen Display.
- ▶ 16:9: This format is for 16x9 input sources, like HDTV and DVD enhanced for Widescreen Display.
- ▶ LBX: This format is for non-16x9, letterbox source and for users who use external 16x9 lens to display 2.35:1 aspect ratio using full resolution.
- ▶ Native: This format displays the original image without any scaling.

Input Signal

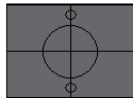

4 : 3 format

Display area
Picture area

Display on Screen

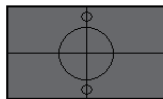

Or

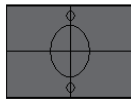

16 : 9 format

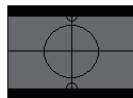
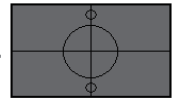

LBX format



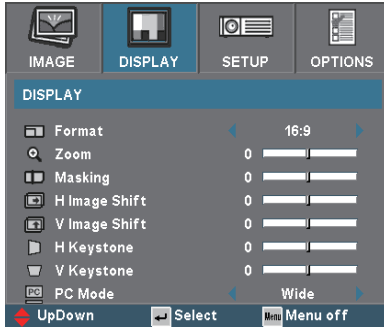

Display

Detail informations about LBX mode :

1. Some Letter-Box DVD contents are not enhanced for 16x9 TV, then image will not look right in 16:9 display.
One can use 4:3 mode to view the correct info.
But if the content itself is not 4:3, it will have black bars around the image in a 16:9 display. For this kind of content, you can use LBX mode to fill the image in the 16x9 display as much as possible.
2. If you use an external 16x9 lens, this LBX mode also allows you to watch a 2.35:1 content (include Anamorphic DVD and HDTV film source) that support anamorphic wide is enhanced for 16x9 Display in a wide 2.35:1 image.
In this case, there are no black bars, the full lamp power and vertical resolution is fully utilized for maximum viewing effects.
Other than these two occasions, one should stay with 16:9 and 4:3 modes for most viewing experiences.

Zoom

- ▶ Press the ◀ to reduce the size of an image.
- ▶ Press the ▶ to magnify an image on the projection screen.

Masking

Masking function cover the noise on the edge of a video image. Masking the image to cover video encoding noise on the edge of video source.



Display

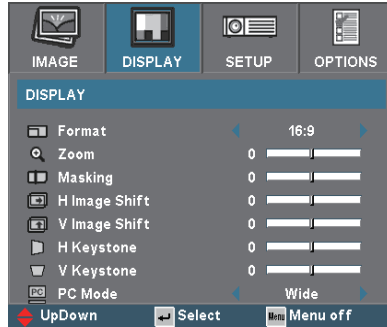

H Image Shift

Shifts the projected image position horizontally.

V Image Shift

Shifts the projected image position vertically.

H Keystone

Press the ◀ or ▶ to adjust image distortion horizontally and makes a squarer image.

V Keystone

Press the ◀ or ▶ to adjust image distortion vertically and makes a squarer image.

PC Mode

This Mode is only for use when using the EP1690 with a PC signal, either Analogue or VGA1 via the VGA2 connector.

- ▶ Wide: If your PC output is a wide screen format resolution you must select this setting.

Examples of Wide screen resolutions are: 854 x 480 / 1280 x 720 / 1280 x 768 / 1920 x 1080.

- ▶ Normal: If your PC output is a Normal (4:3) resolution you must select this setting.

Examples of Normal resolutions are: 640 x 480 / 800 x 600 / 1024 x 768 / 1152 x 864 / 1152 x 870 (for MAC) / 1280 x 960 / 1280 x 1024 / 1400 x 1050.*

*All supported resolutions are listed on page 39.



NOTE

“PC Mode” function is only supported under PC signal via VGA1 or VGA2 connector.



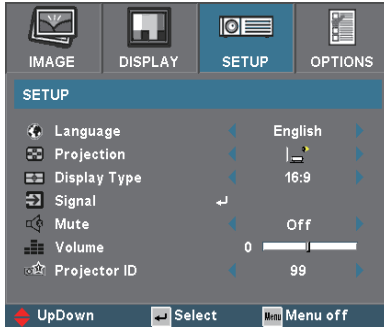

Setup

Language

Choose the multilingual OSD menu. Press ◀ or ▶ into the sub menu and then use the ▲ or ▼ key to select your preferred language. Press “Select (Enter)” to finalize the selection.

Projection

- ▶  Front-Desktop

The factory default setting.

- ▶  Rear-Desktop

When you select this function, the projector reverses the image so you can project behind a translucent screen.

- ▶  Front-Ceiling

When you select this function, the projector turns the image upside down for ceiling-mounted projection.

- ▶  Rear-Ceiling

When you select this function, the projector reverses and turns the image upside down at same time. You can project from behind a translucent screen with ceiling mounted projection.

Display Type

Choose the display type as 16:9 (1280 x 720) or 16:10 (1280 x 768).



Setup

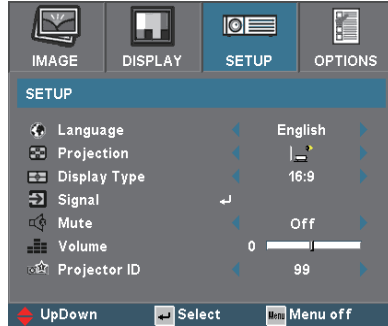

Signal

- ▶ Phase: Synchronizes the signal timing of the display with the graphics card. If you experience an unstable or flickering image, use this function to correct it.
- ▶ Frequency : Changes the display data frequency to match the frequency of your computer's graphic card. When you experience a vertical flickering bar, use this function to make an adjustment.

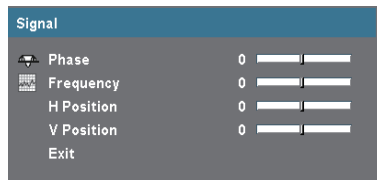

- ▶ H. Position: Adjusts the horizontal position.
- ▶ V. Position: Adjusts the vertical position.

Mute

- ▶ Choose the "On" to turn mute on.
- ▶ Choose the "Off" to turn mute off.

Volume

- ▶ Press ◀ to decrease the volume.
- ▶ Press ▶ to increase the volume.

Projector ID

Allows RS232 control of an individual projector. Range 01~99.



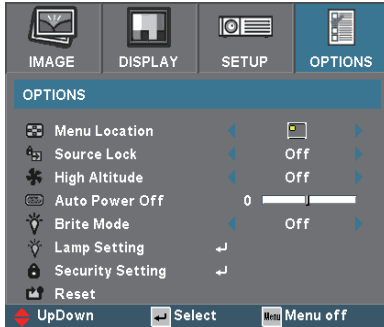

Options

Menu Location

Choose the menu location on the display screen.

Source Lock

When this function is turned off, the projector will search for other signals if the current input signal is lost. When source lock is turned on, it will "Lock" the current source channel before you press "Source Lock" button on remote control for next channel.

High Altitude

Choose "On" to turn on High Altitude mode. Operates the fans at full speed continuously to allow for proper high altitude cooling of the projector.

Auto Power Off (min)

Sets the interval of power-off of the system, if there is no signal input. (In minutes)

Brite Mode

Choose "Off" to dim the projector lamp which will lower power consumption, extend the lamp life and reduce noise. Choose "On" to return normal mode.



Options | Lamp settings

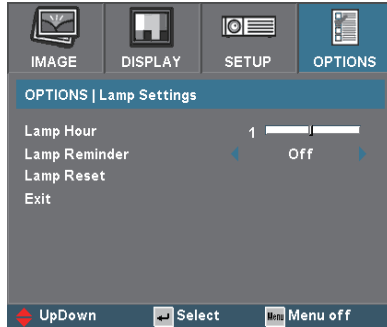

Lamp Hour

Displays the cumulative lamp operating time.

Lamp Reminder

Choose this function to show or to hide the warning message when the changing lamp message is displayed. The message will appear up 30 hours before suggested replacement of lamp.

Lamp Reset

Reset the lamp life hour after replacing the lamp.



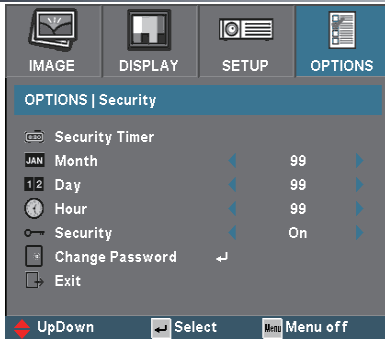

Options | Security Setting

Security Timer

Can be select the month/day/hour function.

Month

Can be select the month function to set the number of month the projector can be used . Once the time has elapsed you will be requested to enter your password again.

Day

Can be select the day function to set the number of day the projector can be used . Once the time has elapsed you will be requested to enter your password again.

Hour

Can be select the hour function to set the number of hour the projector can be used . Once the time has elapsed you will be requested to enter your password again.

Security

- ▶ On: Choose “on” to use security verification when the turning on the projector.
- ▶ Off: Choose “Off” to be able to switch on the projector without password verification.

Change Password

Use number buttons to select your password, and then press “Enter” key to confirm your selection.

1. Scroll down to highlight Change Password, and press “Enter” to input old password.
2. The Password is 4 digits, DEFAULT VALUE is “0000” (first time).
3. Enter new Password (4 digits) and press “Enter”.
4. Enter new Password again to confirm and press “Enter”.



Options

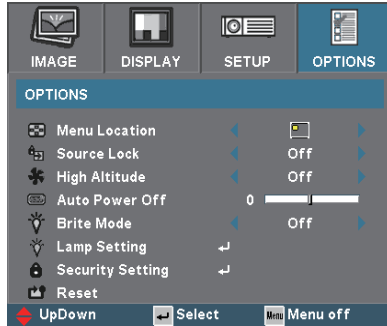

Reset

Return the adjustments and settings to factory default values.

- ▶ **Current** : Returns the current source's settings to factory default.
- ▶ **All** : Returns the settings for all menus to factory default values.



Troubleshooting

If you experience trouble with the projector, refer to the following information. If the problem persists, please contact your local reseller or service center, see page 42 for details.

Problem: No image appears on screen

- ▶ Ensure all the cables and power connections are correctly and securely connected as described in the "Installation" section.
- ▶ Ensure the pins of connectors are not crooked or broken.
- ▶ Check if the projection lamp has been securely installed. Please refer to the "Replacing the lamp" section.
- ▶ Make sure you have removed the lens cap and the projector is switched on.
- ▶ Ensure that the "AV Mute" feature is not turned on.

Problem: Left of right edge of the image is missing or the image is unstable or noisy

- ▶ Press "Re-Sync" on the remote control or control panel.
- ▶ If you are using a PC:

For Windows 3.x:

1. In the Windows Program Manager, double click the "Windows Setup" icon in the Main group.
2. Verify that your display resolution setting is less than or equal to 1400 x 1050(*).

For Windows 95, 98, 2000, XP:

1. Open the "My Computer" icon, the "Control Panel" folder, and then double click on the "Display" icon.
2. Select the "Settings" tab.
3. Click on the "Advanced Properties" button.

If the projector is still not projecting the whole image, you will also need to change the monitor display you are using. Refer to the following steps.

4. Verify the resolution setting is less than or equal to 1400 x 1050 resolution.
5. Select the "Change" button under the "Monitor" tab.
6. Click on "Show all devices." Next, select "Standard monitor types" under the SP box; choose the resolution mode you need under the "Models" box.



NOTE

❖ (*) The resolution WXGA (1280 x 768) is recommended for computer signal.



Appendices

- ▶ If you are using a Notebook:
 1. First, follow the steps above to adjust resolution of the computer.
 2. Press the toggle output settings. example: [Fn]+[F4]

Compaq ⇒	[Fn]+[F4]	Packard	⇒	[Fn]+[F4]
Dell ⇒	[Fn]+[F8]	Hewlett	⇒	[Fn]+[F4]
Gateway ⇒	[Fn]+[F4]	NEC ⇒	[Fn]+[F3]	
IBM ⇒	[Fn]+[F7]	Toshiba ⇒	[Fn]+[F5]	

Mac Apple:

System Preference ⇒ Display ⇒ Arrangement ⇒ Mirror display

- ▶ If you experience difficulty changing resolutions or your monitor freezes, restart all equipment including the projector.

Problem: The screen of the Notebook or PowerBook computer is not displaying a presentation

- ▶ If you are using a Notebook PC:

Some Notebook PCs may deactivate their own screens when a second display device is in use. Each has a different way to be reactivated. Refer to your computer's documentation for detailed information.

Problem: Image is unstable or flickering

- ▶ Use "Phase" to correct it.
- ▶ Change the monitor colour setting on your computer.

Problem: Image has vertical flickering bar

- ▶ Use "Frequency" to make an adjustment.
- ▶ Check and reconfigure the display mode of your graphic card to make it compatible with the product.

Problem: Image is out of focus

- ▶ Adjusts the Focus Ring on the projector lens.
- ▶ Make sure the projection screen is between distance 4.9 to 40.0 feet (1.5 to 12.2 meters) from the projector. See page 15.



Problem: The image is stretched when displaying 16:9 DVD

The projector automatically detects 16:9 DVD and adjusts the aspect ratio by digitizing to full screen with 4:3 default setting.

If the image is still stretched, you will also need to adjust the aspect ratio by referring to the following:

- ▶ Please select 4:3 aspect ratio type on your DVD player if you are playing a 16:9 DVD.
- ▶ If you can't select 4:3 aspect ratio type on your DVD player, please select 4:3 aspect ratio in the on screen menu.

Problem: Image is reversed

- ▶ Select "Setup → Projection" from the OSD and adjust the projection direction.

Problem: Lamp burns out or makes a popping sound

- ▶ When the lamp reaches its end of life, it will burn out and may make a loud popping sound. If this happens, the projector will not turn on until the lamp module has been replaced. To replace the lamp, follow the procedures in the "Replacing the Lamp".

Problem: LED lighting message

Message	Power-LED (Green)	Temp-LED	Lamp-LED
Standby State (Input power cord)	Flashing	○	○
Warming	☀	○	○
Normal Mode	☀	○	○
Cooling	☀	○	○
Error (Lamp failed)	☀	○	☀
Error (Fan failed)	☀	Flashing	○
Error (Over Temp.)	☀	☀	○



Steady light ⇨ ☀

No light ⇨ ○



Problem: Message Reminders

- ▶ Fan fail:



- ▶ Over heated:

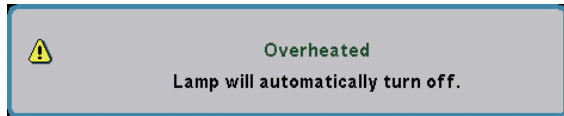

- ▶ Power Off:

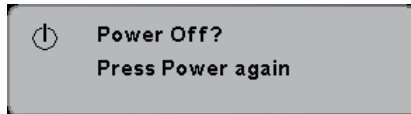

- ▶ Replace the lamp:



Replacing the Lamp



NOTE

 **Warning :**
Lamp compartment is hot! Allow 30 minutes to cool down before changing lamp!

The projector keeps track of the lamp usage. It will show you a warning message



When you see this message, change the lamp as soon as possible. Make sure the projector has cooled down for at least 30 minutes before changing the lamp.

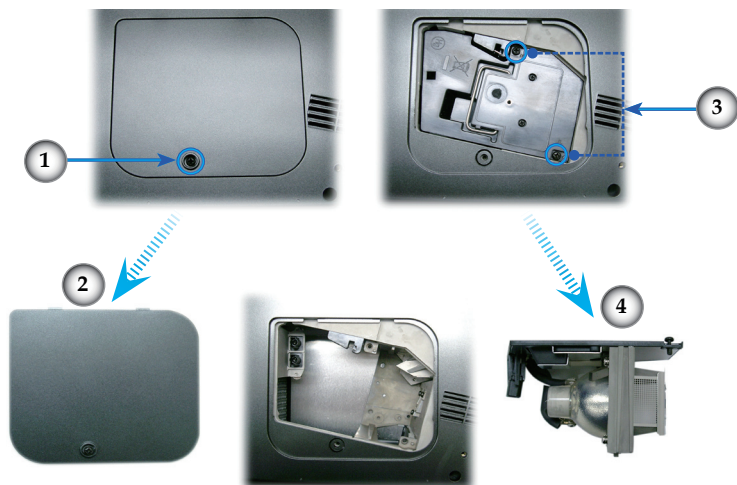

NOTE

 **Warning :**
To reduce the risk of personal injury, do not drop the lamp module or touch the lamp bulb. The bulb may shatter and cause injury if it is dropped.

Lamp Replacement Procedure:

1. Switch off the power to the projector by pressing the Standby/ON button.
2. Allow the projector to cool down for at least 30 minutes.
3. Disconnect the power cord.
4. Use a screwdriver to remove 1 screw from the cover. **①**
5. Push up and remove the cover. **②**
6. Remove the 2 screws from the lamp module. **③**
7. Pull out the lamp module. **④**

To replace the lamp module, reverse the previous steps.



Compatibility Modes



Remark :
 “*” compressed
 computer image.

Mode	Resolution	(ANALOG)		(DIGITAL)	
		V.Frequency (Hz)	H.Frequency (kHz)	V.Frequency (Hz)	H.Frequency (kHz)
VESA VGA	640 x 350	70	31.5	70	31.5
VESA VGA	640 x 350	85	37.9	85	37.9
VESA VGA	640 x 400	85	37.9	85	37.9
VESA VGA	640 x 480	60	31.5	60	31.5
VESA VGA	640 x 480	72	37.9	72	37.9
VESA VGA	640 x 480	75	37.5	75	37.5
VESA VGA	640 x 480	85	43.3	85	43.3
VESA VGA	720 x 400	70	31.5	70	31.5
VESA VGA	720 x 400	85	37.9	85	37.9
VESA SVGA	800 x 600	56	35.2	56	35.2
VESA SVGA	800 x 600	60	37.9	60	37.9
VESA SVGA	800 x 600	72	48.1	72	48.1
VESA SVGA	800 x 600	75	46.9	75	46.9
VESA SVGA	800 x 600	85	53.7	85	53.7
VESA XGA	1024 x 768	60	48.4	60	48.4
VESA XGA	1024 x 768	70	56.5	70	56.5
VESA XGA	1024 x 768	75	60.0	75	60.0
VESA XGA	1024 x 768	85	68.7	85	68.7
* VESA SXGA	1280 x 1024	60	63.98	60	63.98
* VESA SXGA	1280 x 1024	75	79.98	75	79.98
* VESA SXGA+	1400 x 1050	60	63.98	60	63.98
MAC LC 13"	640 x 480	66.66	34.98	***	***
MAC II 13"	640 x 480	66.68	35	***	***
MAC 16"	832 x 624	74.55	49.725	***	***
MAC 19"	1024 x 768	75	60.24	***	***
* MAC	1152 x 870	75.06	68.68	***	***
MAC G4	640 x 480	60	31.35	***	***
i MAC DV	1024 x 768	75	60	***	***
* i MAC DV	1152 x 870	75	68.49	***	***
* i MAC DV	1280 x 960	75	75	***	***



RS232 Commands

RS232 Connector

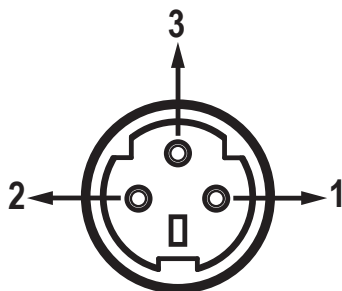

Pin no.	Name	I/O (From Projector Side)
1	TXD	OUT
2	RXD	IN
3	GND	—

VGA-In Connector

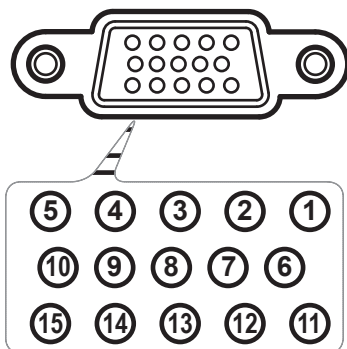

Pin no.	Spec.
1	R(RED)/Cr
2	G(GREEN)/Y
3	B(BLUE)/Cb
4	GND
5	GND
6	GND
7	GND
8	GND
9	DDC 5V
10	GND
11	GND
12	DDC Data
13	HD/CS
14	VD
15	DDC Clock



Ceiling Mount Installation



Please note that damage resulting from incorrect installation will invalidate the warranty.

1. To prevent damaging your projector, please use the ceiling mount package for installation.
2. If you wish to use a third party ceiling mount kit, please ensure the screws used to attached a mount to the projector meet the following specifications:

- ▶ **Screw type: M3**
- ▶ **Maximum screw length: 10mm**
- ▶ **Minimum screw length: 7.5mm**



⚠ Warning:

1. If you buy the ceiling mount from another manufacturer, please ensure that there is at least 10cm distance between the bottom cover of the projector and the ceiling.
2. Avoid placing the projector near sources of heat such as air-conditioning units and heaters otherwise it may overheat and shut down automatically.

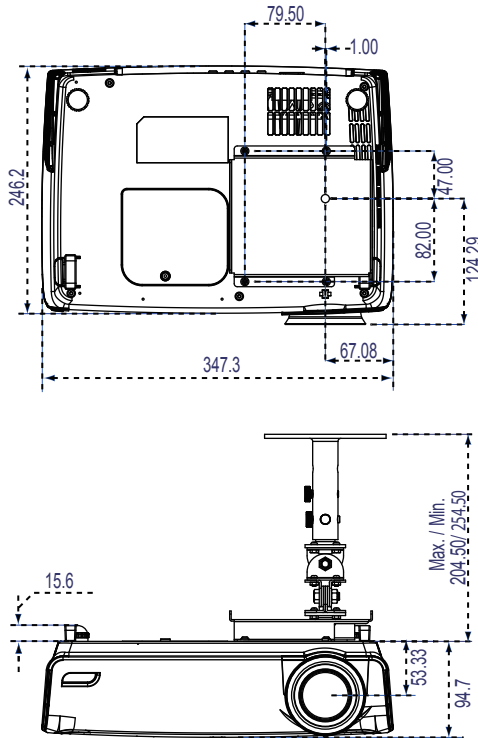

Optoma Global Offices

For service or support please contact your local office.

USA

715 Sycamore Drive
Milpitas, CA 95035, USA
www.optomausa.com

Tel : 408-383-3700
Fax: 408-383-3702
Service : service@optoma.com

Canada

120 West Beaver Creek Road Unit #9
Richmond Hill, ON L4B 1L2, Canada
Tel : 905-882-4228
www.optoma.com

Fax: 905-882-4229

Europe

42 Caxton Way, The Watford Business Park
Watford, Hertfordshire, WD18 8QZ, UK

Tel : +44 (0) 1923 691 800

Fax: +44 (0) 1923 691 888

www.optomaeurope.com

Service Tel : +44 (0)1923 691865

Service : service@tsc-europe.com

Taiwan

5F., No. 108, Minchiuan Rd.
Shindian City, Taipei Taiwan 231,
R.O.C.

Tel : +886-2-2218-2360

Fax: +886-2-2218-2313

www.optoma.com.tw

Service : services@optoma.com.tw asia.optoma.com

Hong Kong

Unit 901, 9/F., Vogue Centre, No. 696
Castle Peak Road, Kowloon, Hong Kong

Tel : +852-2396-8968

Fax: +852-2370-1222

www.optoma.com.cn

China

5F, No. 1205, Kaixuan Rd.,
Changning District
Shanghai, 200052, China

Tel : +86-21-62947376

Fax: +86-21-62947375

www.optoma.com.cn

Latin America

715 Sycamore Drive
Milpitas, CA 95035, USA
www.optoma.com.br

Tel : 408-383-3700

Fax: 408-383-3702

www.optoma.com.mx

