

myprojectorlamps.com

**The most trusted, dependable name
in projector lamp sales.**



<http://www.myprojectorlamps.com>



<http://www.myprojectorlamps.ca>



<http://www.myprojectorlamps.eu>

The following projector manual has not been modified or altered in any way.

NEC

Portable Projector

NP200/NP100

User's Manual

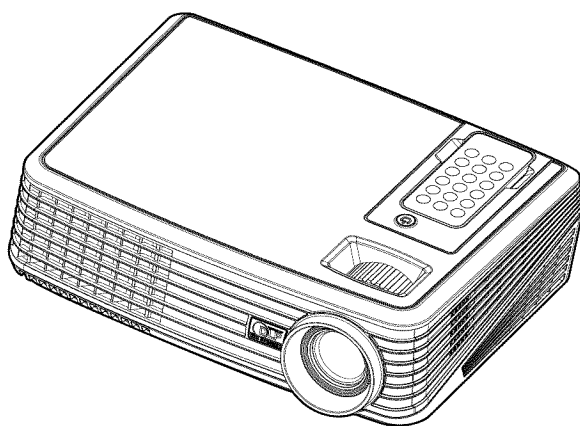

- DLP and BrilliantColor are trademarks of Texas Instruments.
- IBM is a trademark or registered trademark of International Business Machines Corporation.
- Macintosh, PowerBook, iMac, and Power Mac are trademarks of Apple, Inc., registered in the U.S. and other countries.
- Windows, Windows 98, Windows Me, Windows XP, Windows 2000, or Windows Vista are trademarks or registered trademarks of Microsoft Corporation.
- Other product and company names mentioned in this user's manual may be the trademarks or registered trademarks of their respective holders.

NOTES

- (1) The contents of this user's manual may not be reprinted in part or whole without permission.
- (2) The contents of this user's manual are subject to change without notice.
- (3) Great care has been taken in the preparation of this user's manual; however, should you notice any questionable points, errors or omissions, please contact us.
- (4) Notwithstanding article (3), NEC will not be responsible for any claims on loss of profit or other matters deemed to result from using the Projector.

Important Information

Safety Cautions

Precautions

Please read this manual carefully before using your NEC NP100/NP200 projector and keep the manual handy for future reference.

CAUTION



To turn off main power, be sure to remove the plug from power outlet. The power outlet socket should be installed as near to the equipment as possible, and should be easily accessible.

CAUTION



TO PREVENT SHOCK, DO NOT OPEN THE CABINET. THERE ARE HIGH-VOLTAGE COMPONENTS INSIDE. REFER SERVICING TO QUALIFIED SERVICE PERSONNEL.



This symbol warns the user that uninsulated voltage within the unit may be sufficient to cause electrical shock. Therefore, it is dangerous to make any kind of contact with any part inside of the unit.



This symbol alerts the user that important information concerning the operation and maintenance of this unit has been provided. The information should be read carefully to avoid problems.

WARNING: TO PREVENT FIRE OR SHOCK, DO NOT EXPOSE THIS UNIT TO RAIN OR MOISTURE. DO NOT USE THIS UNIT'S PLUG WITH AN EXTENSION CORD OR IN AN OUTLET UNLESS ALL THE PRONGS CAN BE FULLY INSERTED.

DOC Compliance Notice (for Canada only)

This Class B digital apparatus meets all requirements of the Canadian Interference-Causing Equipment Regulations.

Machine Noise Information Regulation - 3. GPSGV,

The highest sound pressure level is less than 70 dB (A) in accordance with EN ISO 7779.

Disposing of your used product



EU-wide legislation as implemented in each Member State requires that used electrical and electronic products carrying the mark (left) must be disposed of separately from normal household waste. This includes projectors and their electrical accessories or lamps. When you dispose of such products, please follow the guidance of your local authority and/or ask the shop where you purchased the product.

After collecting the used products, they are reused and recycled in a proper way. This effort will help us reduce the wastes as well as the negative impact such as mercury contained in a lamp to the human health and the environment at the minimum level. The mark on the electrical and electronic products only applies to the current European Union Member States.

WARNING TO CALIFORNIA RESIDENTS:

Handling the cables supplied with this product will expose you to lead, a chemical known to the State of California to cause birth defects or other reproductive harm. **WASH HANDS AFTER HANDLING.**

RF Interference (for USA only)

WARNING

The Federal Communications Commission does not allow any modifications or changes to the unit EXCEPT those specified by NEC Display Solutions of America, Inc. in this manual. Failure to comply with this government regulation could void your right to operate this equipment. This equipment has been tested and found to comply with the limits for a Class B digital device, pursuant to Part 15 of the FCC Rules. These limits are designed to provide reasonable protection against harmful interference in a residential installation. This equipment generates, uses, and can radiate radio frequency energy and, if not installed and used in accordance with the instructions, may cause harmful interference to radio communications. However, there is no guarantee that interference will not occur in a particular installation. If this equipment does cause harmful interference to radio or television reception, which can be determined by turning the equipment off and on, the user is encouraged to try to correct the interference by one or more of the following measures:

- Reorient or relocate the receiving antenna.
- Increase the separation between the equipment and receiver.
- Connect the equipment into an outlet on a circuit different from that to which the receiver is connected.
- Consult the dealer or an experienced radio / TV technician for help.

For UK only: In UK, a BS approved power cable with moulded plug has a Black (five Amps) fuse installed for use with this equipment. If a power cable is not supplied with this equipment please contact your supplier.

Important Safeguards

These safety instructions are to ensure the long life of your projector and to prevent fire and shock. Please read them carefully and heed all warnings.

Installation

- Do not place the projector in the following conditions:
 - on an unstable cart, stand, or table.
 - near water, baths, or damp rooms.
 - in direct sunlight, near heaters, or heat radiating appliances.
 - in a dusty, smoky or steamy environment.
 - on a sheet of paper or cloth, rugs or carpets.
- If you wish to have the projector installed on the ceiling:
 - Do not attempt to install the projector yourself.
 - The projector must be installed by qualified technicians in order to ensure proper operation and reduce the risk of bodily injury.
 - In addition, the ceiling must be strong enough to support the projector and the installation must be in accordance with any local building codes.
 - Please consult your dealer for more information.

Place the projector in a horizontal position

The tilt angle of the projector should not exceed 15 degrees, nor should the projector be installed in any way other than the desktop and ceiling mount, otherwise lamp life could decrease dramatically.

Fire and Shock Precautions

- Ensure that there is sufficient ventilation and that vents are unobstructed to prevent the build-up of heat inside your projector. Allow at least 4 inches (10cm) of space between your projector and a wall.
- Do not try to touch the ventilation outlet as it can become heated while the projector is turned on and immediately after the projector is turned off.
- Prevent foreign objects such as paper clips and bits of paper from falling into your projector. Do not attempt to retrieve any objects that might fall into your projector. Do not insert any metal objects such as a wire or screwdriver into your projector. If something should fall into your projector, disconnect it immediately and have the object removed by a qualified service personnel.
- Do not place any objects on top of the projector.
- Do not touch the power plug during a thunderstorm. Doing so can cause electrical shock or fire.
- The projector is designed to operate on a power supply of 100-240V AC 50/60 Hz. Ensure that your power supply fits this requirement before attempting to use your projector.
- Do not look into the lens while the projector is on. Serious damage to your eyes could result.
- Keep any items such as magnifying glass out of the light path of the projector. The light being projected from the lens is extensive, therefore any kind of abnormal objects that can redirect light coming out of the lens, can cause unpredictable outcome such as fire or injury to the eyes.
- Do not cover the lens with the black lens cap or equivalent while the projector is on. Doing so can lead to melting of the cap and possibly burning your hands due to the heat emitted from the light output.
- Do not place any objects, which are easily affected by heat, in front of the projector lens or a projector exhaust vent.
Doing so could lead to the object melting or getting your hands burned from the heat that is emitted from the light output and exhaust.
- Handle the power cable carefully. A damaged or frayed power cable can cause electric shock or fire.
 - Do not use any power cables than the supplied one.
 - Do not bend or tug the power cable excessively.
 - Do not place the power cable under the projector, or any heavy object.
 - Do not cover the power cable with other soft materials such as rugs.
 - Do not heat the power cable.
- Turn off the projector, unplug the power cable and have the projector serviced by a qualified service personnel under the following conditions:
 - When the power cable or plug is damaged or frayed.
 - If liquid has been spilled into the projector, or if it has been exposed to rain or water.
 - If the projector does not operate normally when you follow the instructions described in this user's manual.
 - If the projector has been dropped or the cabinet has been damaged.
 - If the projector exhibits a distinct change in performance, indicating a need for service.
- Disconnect the power cable and any other cables before carrying the projector.
- Turn off the projector and unplug the power cable before cleaning the cabinet or replacing the lamp.
- Turn off the projector and unplug the power cable if the projector is not to be used for an extended period of time.

CAUTION

- Do not use the tilt-foot for purposes other than originally intended. Misuses such as using the tilt foot to carry or hang (from the wall or ceiling) the projector can cause damage to the projector.
- Do not send the projector in the soft case by parcel delivery service or cargo shipment. The projector inside the soft case could be damaged.
- Select [On] in Fan mode if you continue to use the projector for consecutive days. (From the menu, select [Default setting] → [Fan Control] → [On].)
- Do not turn off the AC power for 60 seconds after the lamp is turned on and while the POWER indicator is blinking blue.
Doing so could cause premature lamp failure.

Remote Control Precautions

- Handle the remote control carefully.
- If the remote control gets wet, wipe it dry immediately.
- Avoid excessive heat and humidity.
- Do not place the battery upside down.

NOTE:

* Keep the coin cell battery out of reach of children so as not to allow them to swallow the cell battery.

CAUTION:

Danger of explosion if battery is incorrectly replaced.
Replace only with the same or equivalent type recommended by the manufacturer.
Dispose of used batteries according to your local regulations.

CAUTION:

Use the remote control away from audio tapes, video tapes, credit cards, hard disk drive of the computer, or cardiac pacemakers.
The remote control contains a magnet that may affect or damage them.

Lamp Replacement

- To replace the lamp, follow all instructions provided on page 33 to 34.
- Be sure to replace the lamp when the message appears. If you continue to use the lamp after the lamp has reached the end of its usable life, the lamp bulb may shatter, and pieces of glass may be scattered in the lamp case. Do not touch them as the pieces of glass may cause injury.
If this happens, contact your dealer for lamp replacement.

A Lamp Characteristic

The projector has a high-pressure mercury lamp as a light source.
A lamp has a characteristic that its brightness gradually decreases with age. Also repeatedly turning the lamp on and off will increase the possibility of its lower brightness.

CAUTION:

When removing the lamp from a ceiling-mounted projector, make sure that no one is under the projector.
Glass fragments could fall if the lamp has been burned out.

Note for US Residents

The lamp in this product contains mercury. Please dispose according to Local, State or Federal Laws.

Table of Contents

Table of Contents	1
Usage Notice.....	2
<i>Precautions</i>	2
Introduction.....	4
<i>Product Features</i>	4
<i>Package Overview</i>	5
<i>Product Overview</i>	6
<i>Projector</i>	6
<i>Connection Ports</i>	7
<i>Wireless Remote Control</i>	8
<i>Replacing the Coin Cell</i>	10
Installation	11
<i>Connecting the Projector</i>	11
<i>Powering On/Off the Projector</i>	12
<i>Powering On the Projector</i>	12
<i>Powering Off the projector</i>	14
<i>Warning Indicator</i>	14
<i>Adjusting the Projected Image</i>	15
<i>Adjusting the Height of Projector Image</i>	15
<i>Adjusting the Projector Zoom / Focus</i>	16
<i>Adjusting Projected Image Size</i>	16
User Controls	17
<i>On Screen Display</i>	17
<i>How to operate</i>	17
<i>Image (PC Mode)</i>	18
<i>Image (Video Mode)</i>	20
<i>Display Setting</i>	22
<i>Default Setting</i>	24
<i>Language</i>	26
<i>Information</i>	27
Appendices.....	28
<i>Troubleshooting</i>	28
<i>Replacing the lamp</i>	33
<i>Specifications</i>	35
<i>Compatibility Modes</i>	36
<i>Cabinet Dimensions</i>	37

Troubleshooting Check List / TravelCare Guide

Usage Notice

Precautions



Follow all warnings, precautions and maintenance as recommended in this user's guide to maximize the life of your unit.

- Warning- Do not look into the projector's lens when the lamp is on. The bright light may hurt your eyes.
- Warning- To reduce the risk of fire or electric shock, do not expose this projector to rain or moisture.
- Warning- Please do not open or disassemble the projector as this may cause electric shock.
- Warning- When replacing the lamp, please allow unit to cool down, and follow all replacement instructions..
- Warning- This projector will detect the life of the lamp itself. Please be sure to change the lamp when it shows warning messages.
- Warning- Reset the "Clear Lamp Hours" function from the on-screen display "Default Setting" menu after replacing the lamp module (refer to page 25).
- Warning- When switching the projector off, please ensure the cooling cycle has been completed before disconnecting power. Allow 120 seconds for the projector to cool down.
- Warning- Do not use lens cap when projector is powered on.
- Warning- Turn on the projector first and then the signal sources.
- Warning- When the lamp reaches the end of its life, it will burn out and may make a loud popping sound. If this happens, the projector will not turn back on until the lamp module has been replaced. To replace the lamp, follow the procedures listed under "Replacing the Lamp".

Usage Notice

Do:

- ⊗ Turn off the product before cleaning.
- ⊗ Use a soft cloth moistened with mild detergent to clean the display housing.
- ⊗ Disconnect the power plug from AC outlet if the product is not being used for a long period of time.

Do not:

- ⊗ Block the slots and openings on the unit provided for ventilation.
- ⊗ Use abrasive cleaners, waxes or solvents to clean the unit.
- ⊗ Use under the following conditions:
 - Extremely heat, cold or humidity.
 - In areas susceptible to excessive dust and dirt.
 - Near any appliance generating a strong magnetic field.
 - In direct sunlight.

Product Features

This product is an SVGA/XGA single chip 0.55" DLP™ projector. Outstanding features include:

- NP100: True SVGA, 800 × 600 addressable pixels
NP200: True XGA, 1024 × 768 addressable pixels
- Single chip DarkChip2™ DLP™ technology
- NTSC/NTSC4.43/PAL/PAL-M/PAL-N/SECAM and SDTV(480i/576i), EDTV(480p/576p), HDTV(720p/1080i) compatible
- Multi-Auto functions: Auto detection, Auto image and Auto saving the adjustments
- Full function remote control
- User friendly multilingual on screen display
- Advanced digital keystone correction and high quality full screen image re-scaling
- Built-in mono 2-Watt speaker.
- NP100: SXGA, XGA compression and VGA re-sizing
NP200: SXGA+, SXGA compression and VGA, SVGA re-sizing
- Macintosh compatible

Package Overview

This projector comes with all the items shown below. Check to make sure your unit is complete. Contact your dealer immediately if anything is missing.



❖ Due to the difference in applications for each country, some regions may have different accessories.

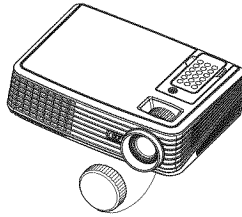

Projector with lens cap
(P/N:79TC1011)

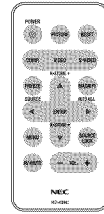

Wireless Remote Control
(P/N:79TC1021)

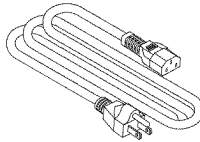

Power Cable
US (P/N:79TC1031)
EU (P/N: 79TC1041)
CH (P/N: 79TC1051)

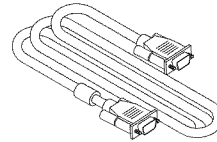

VGA Cable
(P/N : 79TC1001)

Documentation:

- CD-ROM User's Manual
- Quick Setup Guide
- Important Information

For North America:

- Registration Card
- Limited Warranty

For Europe:

- Guarantee Policy

Introduction

Product Overview

Projector

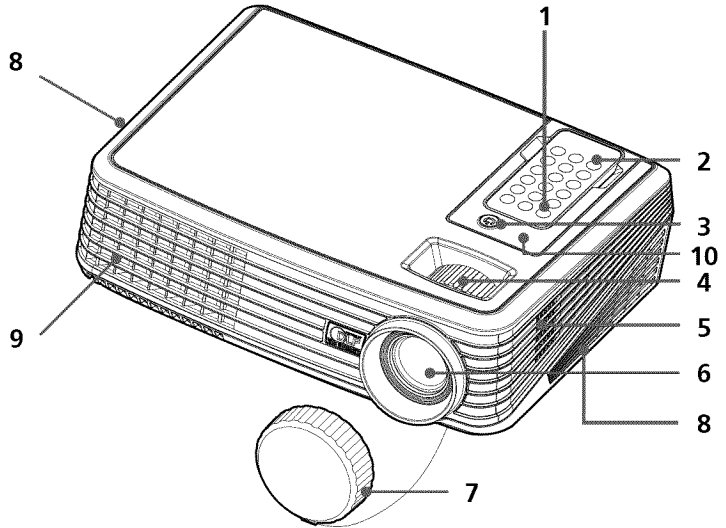

NOTE

❖ To release the remote control from the projector gently press down on the top of the remote control above the "Picture" button. This will cause the bottom of the remote control to pop-up for removal from the cabinet. Be careful not to push any of the buttons on the remote control while removing it from the cabinet.

NOTE

❖ Point the remote control toward the remote sensor. (You can also point the remote control toward the ceiling when in the front desk to bounce the signal off the ceiling.)

1. Power
2. Remote Control
3. Power (LED indicator)
4. Zoom and Focus Rings
5. Speaker
6. Lens
7. Lens Cap
8. Ventilation (inlet)
9. Ventilation (outlet)
10. Remote Sensor

Connection Ports

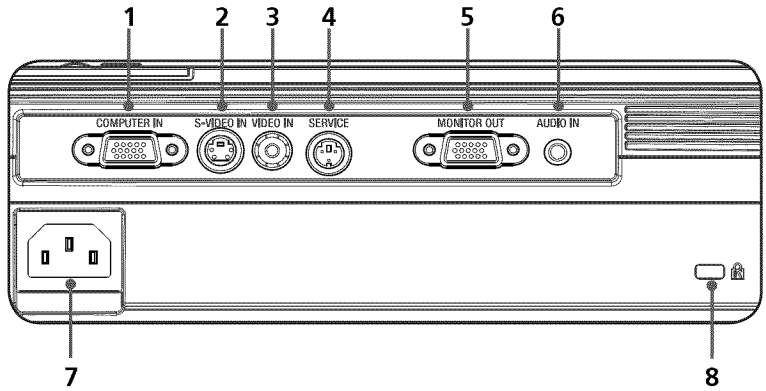

1. COMPUTER IN Connector
2. S-VIDEO IN Connector
3. VIDEO IN Connector
4. SERVICE Port
5. MONITOR OUT Connector
6. AUDIO IN Jack
7. AC IN
8. Kensington™ Lock Port

Introduction

Wireless Remote Control

NOTE

❖ Before using the remote control for the first time, remove the transparent insulation tape. See page 10 for battery installation.

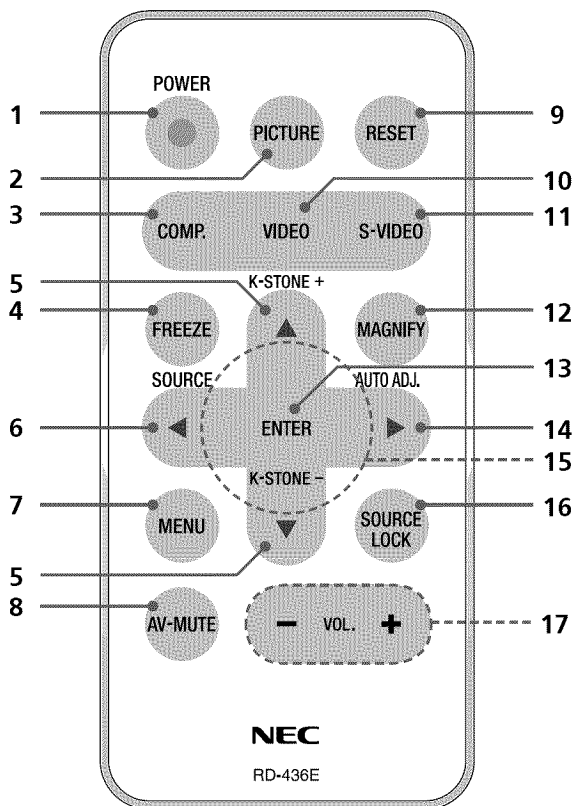
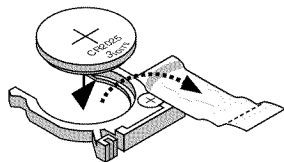

1	 Power	Refer to the "Power On/Off the Projector" section on pages 12-13.
2	Picture Mode	Select the Picture mode from Presentation, Movie, sRGB, Game and User.
3	Computer Source	Press "Computer" to choose Computer connector.
4	Freeze	Freeze To pause the screen image. Press again to resume the screen image.

Introduction

5	Keystone Correction	Adjust the image to compensate for distortion caused by tilting the projector (vertical \pm 40 degrees).
6	Source	Press "Source" to choose RGB, Component, S-Video, Composite and HDTV sources.
7	Menu	Press "Menu" to launch the Onscreen display (OSD), back to the top level of OSD for the OSD main menu operation
8	AV-Mute	Momentarily turn off/on the audio and video.
9	Reset	Change the adjustments and settings to the factory default value.
10	Video Source	Press "Video" to choose Video connector.
11	S-Video Source	Press "S-Video" to choose S-Video connector.
12	Magnify	Zoom the projector display in or out. Use "Magnify", not ◀ or ▶
13	Enter	Confirm your section of items in sub menu operation.
14	Auto Adjust	Automatically synchronize the projector to the input source.
15	 Four Directional Select Keys	Use ▲ or ▼ or ◀ or ▶ to select items or make adjustments to your selection.
16	Source Lock	Press "Source Lock" to lock specified connection port; press this again to unlock.
17	Volume +/-	Increase/decrease speaker volume.

Introduction

Battery Installation

1. Press firmly and slide the battery cover off.

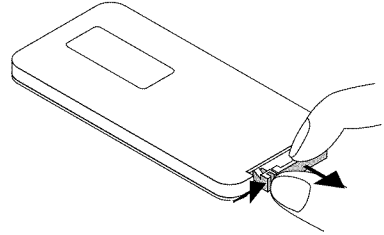
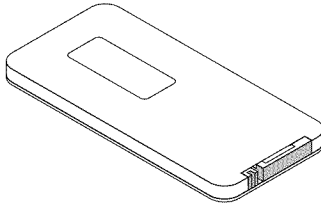

2. Remove the old Lithium coin cell and install new one (CR2025). Ensure that the side with a "+" is facing up.

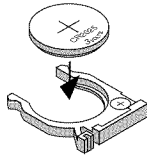

3. Put the cover back.

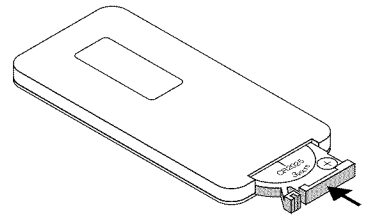

NOTE

❖ Keep the coin cell battery out of reach of children so as not to allow them to swallow the cell battery.

Remote Control Precautions

- Handle the remote control carefully.
- If the remote control gets wet, wipe it dry immediately.
- Avoid excessive heat and humidity.
- Do not place the battery upside down.

⚠ CAUTION:

Danger of explosion if battery is incorrectly replaced.
Replace only with the same or equivalent type recommended by the manufacturer.
Dispose of used batteries according to your local regulations.

⚠ CAUTION:

Use the remote control away from audio tapes, video tapes, credit cards, hard disk drive of the computer, or cardiac pacemakers.
The remote control contains a magnet that may affect or damage them.

Connecting the Projector

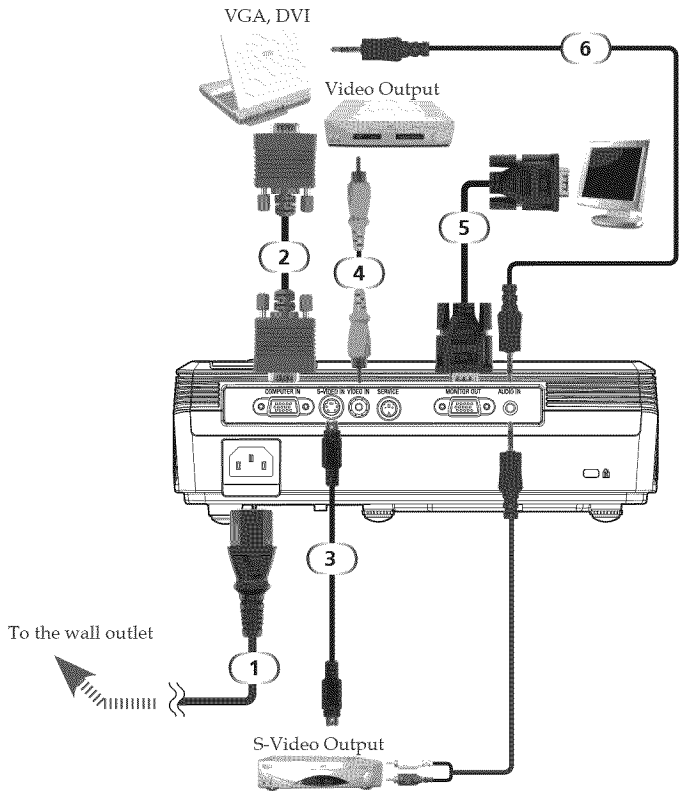

NOTE

❖ Make sure that the power plug is fully inserted into both the projector AC inlet and the wall outlet.

NOTE

❖ Due to the difference in applications for each country, some regions may have different accessories.

1.....	Power cable (supplied)
2.....	VGA cable (supplied)
3.....	S-Video cable
4.....	Composite video cable
5.....	VGA out cable
6.....	Audio cable jack to jack

❖ To ensure the projector works well with your computer, please make sure the timing of the display mode is compatible with your projector.

Installation

Powering On/Off the Projector

Powering On the Projector

1. Ensure that the power cable and signal cable are securely connected. The Power LED will flash blue.
 2. Remove the lens cap. ❶
 3. Turn on the lamp by pressing "Power" on the control panel. ❷ The startup screen (NEC logo) will display and the Power LED will turn blue.
 4. Turn on your source (computer, notebook, video player, etc.) The projector will detect your source automatically.
- ❖ If you connect multiple sources at the same time, use the "Source" on the remote control or use "Computer", "S-Video", "Video" on the remote control to switch inputs.



❖ Turn on the projector first and then the signal sources.

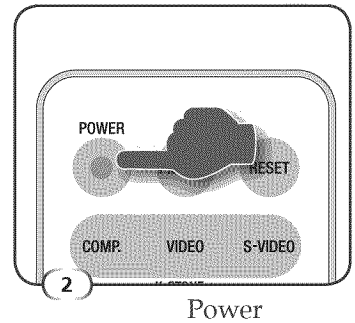
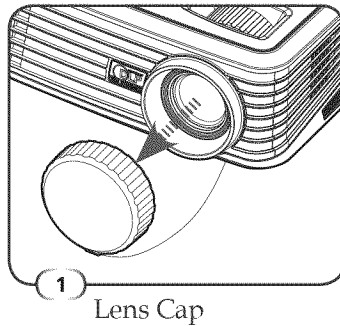

Powering Off the Projector

1. Press the “Power” to turn off the projector lamp, you will see a message as below on the on-screen display.

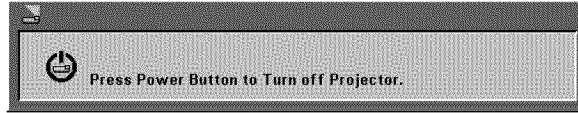

2. Press the “Power” again to confirm.
3. The cooling fan continues to operate for about 120 seconds during the cool down period and the Power LED will flash blue. When the light starts flashing, the projector has entered standby mode.

If you wish to turn the projector back on, you must wait until the projector has completed the cooling cycle and has entered standby mode. Once in standby mode, simply press “Power” to restart the projector.

4. Disconnect the power cable from the electrical outlet and the projector.
5. Do not turn on the projector immediately following a power off procedure.

Warning Indicator

- ❖ When the “Power” LED indicator turns red, it indicates the projector has overheated. The projector will automatically shut itself down.

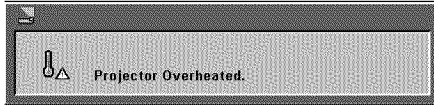

- ❖ When the “Power” LED indicator flashes red and the message below displays on-screen, the projector has detected that the lamp is approaching its end of life. When you see this message, change the lamp as soon as possible or contact your local dealer or our service center.

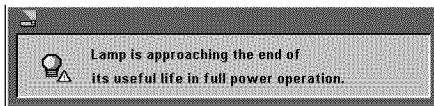

- ❖ When the “Power” LED indicator flashes red and the message below displays on-screen, it indicates the fan failed. Stop using the projector and disconnect the power cable from the electrical outlet, then contact your local dealer or our service center.



Adjusting the Projected Image

Adjusting the Height of Projector Image

The projector is equipped with adjustable feet to raise and lower the image to fill the screen.

To raise/lower the image:

1. Use ❶ to fine-tune the display angle.

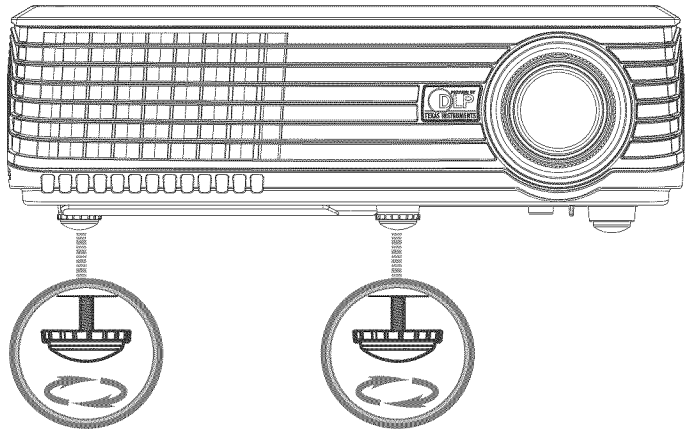

NOTE

❖ The tilt angle of the projector should not exceed 15 degrees, nor should the projector be installed in any way other than the desktop and ceiling mount, otherwise lamp life could decrease dramatically.

❖ You can raise the projector front up to 4 degrees by rotating the tilt foot.

❶ Tilt adjusting wheel

Installation

Adjusting the Projector Zoom / Focus

You may turn the zoom ring to zoom in or out. To focus the image, rotate the focus ring until the image is clear. The projector will focus at distances from 3.9 to 39.4 feet (1.2 to 12.0 meters) with mechanical travel.

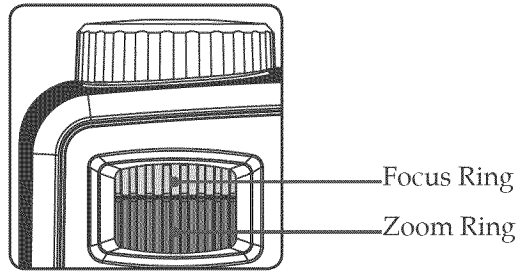

Adjusting Projection Image Size

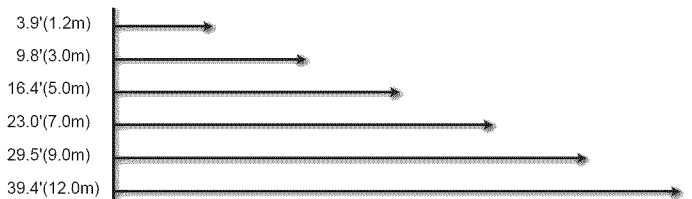
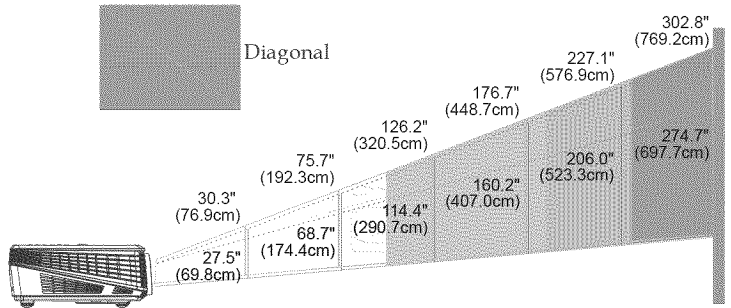

Screen (Diagonal)	Max.	30.3"(76.9cm)	75.7"(192.3cm)	126.2"(320.5cm)	176.7"(448.7cm)	227.1"(576.9cm)	302.8"(769.2cm)
	Min.	27.5"(69.8cm)	68.7"(174.4cm)	114.4"(290.7cm)	160.2"(407.0cm)	206.0"(523.3cm)	274.7"(697.7cm)
Screen Size	Max.(WxH)	24.2" x 16.2" (61.5 x 46.2cm)	60.8" x 45.4" (154.4 x 115.3cm)	101.0" x 76.7" (256.5 x 192.3cm)	141.3" x 106.0" (358.9 x 269.2cm)	181.7" x 136.3" (461.5 x 346.2cm)	242.3" x 181.7" (615.4 x 461.5cm)
	Min.(WxH)	22.0" x 16.5" (55.9 x 41.9cm)	54.9" x 41.2" (139.4 x 104.6cm)	81.9" x 68.7" (208.2 x 174.5cm)	128.2" x 96.1" (325.6 x 244.1cm)	164.8" x 123.6" (418.6 x 313.9cm)	219.7" x 164.8" (558.0 x 418.6cm)
Distance		3.9'(1.2m)	9.8'(3.0m)	16.4'(5.0m)	23.0'(7.0m)	29.5'(9.0m)	39.4'(12.0m)

❖ This graph is for user's reference only.

On Screen Display

The Projector has a multilingual On Screen Display that allows you to make image adjustments and change a variety of settings. The projector will automatically detect the source.

How to operate

1. To open the OSD, press "Menu" on the Remote Control.
2. When OSD is displayed, use ◀ ▶ keys to select any item in the main menu. While making a selection on a particular page, press ▼ key to enter sub menu.
3. Use ▲ ▼ keys to select the desired item in the sub menu and adjust the settings by ◀ ▶ key.
4. If the setting has ↵ icon, you could press "Enter" to enter another sub menu. Press "Menu" to close the sub menu after adjustment.
5. After adjusting the settings, press "Menu" go back to the main menu.
6. To exit, press "Menu" again. The OSD will be closed and the projector will automatically save the new settings.



NOTE

❖ If no button operation is made for 30 seconds, the OSD will be closed automatically.

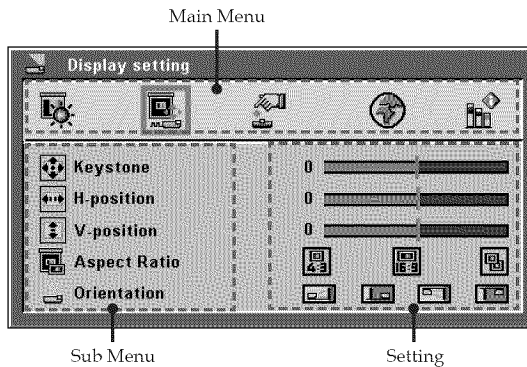

User Controls

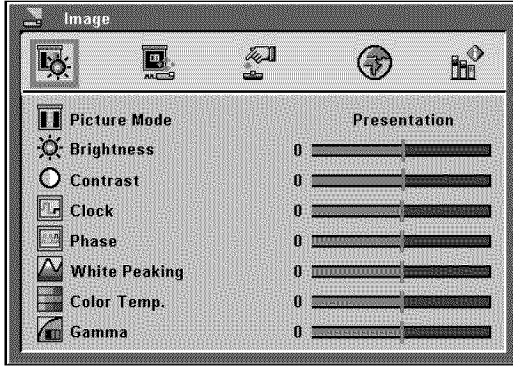

Image (PC Mode)

Picture Mode

There are many factory presets optimized for various types of images. Use the ◀ or ▶ to select the item.

- ▶ Presentation: For computer or notebook.
- ▶ Movie: For home theater.
- ▶ sRGB: For standard color.
- ▶ Game: For game.
- ▶ User: Memorize user's settings.

Brightness

Adjust the brightness of the image.

- ▶ Press the ◀ to darken image.
- ▶ Press the ▶ to lighten the image.

Contrast

The contrast controls the degree of difference between the lightest and darkest parts of the picture. Adjusting the contrast changes the amount of black and white in the image.

- ▶ Press the ◀ to decrease the contrast.
- ▶ Press the ▶ to increase the contrast.

Clock

“Clock” changes the display data frequency to match the frequency of your computer’s graphic card. If you experience a vertical flickering bar, use this function to make an adjustment.

Phase

Synchronize the signal timing of the projector with the graphics card. If you experience an unstable or flickering image, use this function to correct it.

White Peaking

Use the white peaking control to set the white peaking level of DMD chip. 0 stands for minimal peaking, and 10 stands for maximum peaking. If you prefer a stronger image, adjust towards the maximum setting. For a smooth and more natural image, adjust towards the minimum setting.

Color Temp.

Adjust the color temperature. At higher temperature, the screen looks colder; at lower temperature, the screen looks warmer.

Gamma

This allows you to choose a gamma table that has been fine-tuned to bring out the best image quality for the input.

User Controls

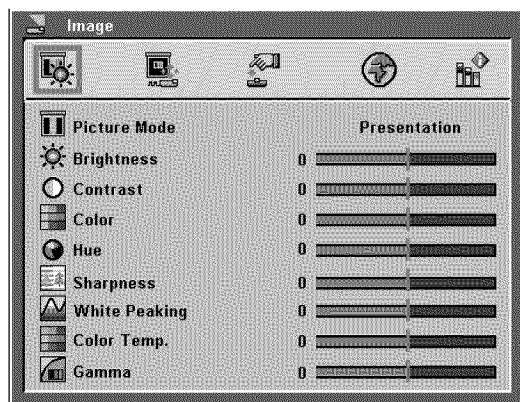

Image (Video Mode)

Picture Mode

There are many factory presets optimized for various types of images. Use the ◀ or ▶ to select the item.

- Presentation: For computer or notebook.
- Movie: For home theater.
- sRGB: For standard color.
- Game: For game.
- User: Memorize user's settings.

Brightness

Adjust the brightness of the image.

- Press the ◀ to darken image.
- Press the ▶ to lighten the image.

Contrast

The contrast controls the degree of difference between the lightest and darkest parts of the picture. Adjusting the contrast changes the amount of black and white in the image.

- Press the ◀ to decrease the contrast.
- Press the ▶ to increase the contrast.

Color

Adjust a video image from black and white to fully saturated color.

- ▶ Press the ◀ to decrease the amount of color in the image.
- ▶ Press the ▶ to increase the amount of color in the image.

Hue

Adjust the color balance of red and green.

- ▶ Press the ◀ to increase the amount of green in the image.
- ▶ Press the ▶ to increase the amount of red in the image.

Sharpness

Adjust the sharpness of the image.

- ▶ Press the ◀ to decrease the sharpness.
- ▶ Press the ▶ to increase the sharpness.

White Peaking

Use the white peaking control to set the white peaking level of DMD chip. 0 stands for minimal peaking, and 10 stands for maximum peaking. If you prefer a stronger image, adjust towards the maximum setting. For a smooth and more natural image, adjust towards the minimum setting.

Color Temp.

Adjust the color temperature. At higher temperature, the screen looks colder; at lower temperature, the screen looks warmer.

Gamma

This allows you to choose a gamma table that has been fine-tuned to bring out the best image quality for the input.

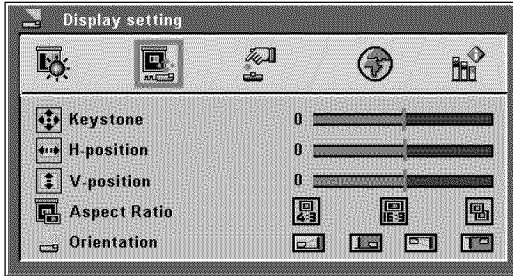

Display Setting

Keystone

Adjust image distortion caused by tilting projector. (± 40 degrees).

H-Position (Horizontal Position)



- ▶ Press the ◀ to move the image left.
- ▶ Press the ▶ to move the image right.

V-Position (Vertical Position)

- ▶ Press the ◀ to move the image down.
- ▶ Press the ▶ to move the image up.

Aspect Ratio

Use this function to choose your desired aspect ratio.

- ▶  4:3
This format is for 4x3 input sources not enhanced for Widescreen TV.
- ▶  16:9
This format is for 16:9 input sources, like HDTV and DVD enhanced for Widescreen TV.
- ▶  Native
This format displays the original image without any scaling.

Orientation

- ▼  Front-Desktop

The factory default setting.

- ▼  Rear-Desktop

When you select this function, the projector reverses the image so you can project behind a translucent screen.

- ▼  Front-Ceiling

When you select this function, the projector turns the image upside down for ceiling-mounted projection.

- ▼  Rear-Ceiling

When you select this function, the projector reverses and turns the image upside down at same time. You can project from behind a translucent screen with ceiling mounted projection.

User Controls

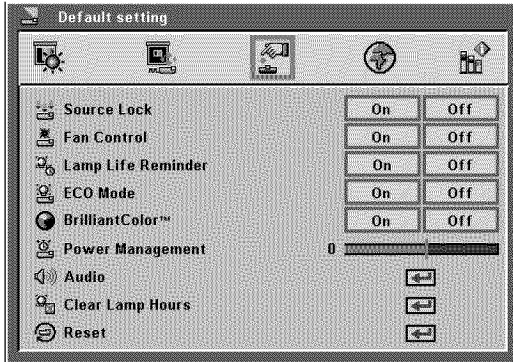

Default Setting

Source Lock

When this function is turned “Off”, the projector will search for other signals if the current input signal is lost. When this function is turned “On”, it will only search a specified connection port.

Fan Control

Choose “On” to turn on Fan Control mode. Operate the fan at full speed continuously to allow for proper high altitude cooling of the projector.

Lamp Life Reminder

Choose this function to show or to hide the lamp end of life warning message. The message will show up 100 hours before end of life.

ECO Mode

Choose “On” to dim the projector lamp which will lower power consumption and extend the lamp life. Choose “Off” to return to normal mode.

BrilliantColor™

Choose “On” to provide true, more vibrant colors.

Power Management

Set the interval of power-off of the system, if there is no signal input. (In minutes)

Audio

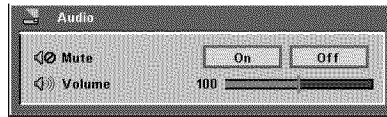

▼ Mute:

- Choose "On" to mute the volume.
- Choose "Off" to restore the volume.

▼ Volume:

- Press the ◀ to decrease the volume.
- Press the ▶ to increase the volume.

Clear Lamp Hours

Reset the lamp life hour after replacing a new lamp.

Reset

Return the adjustments and settings to the factory default values.

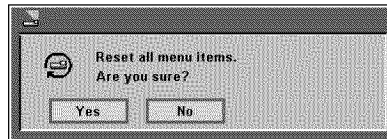

User Controls



Language

Language

Choose the multilingual OSD. Press ▼ into the sub menu and then use the ▲ or ▼ or ◀ or ▶ key to select your preferred language. Press “Enter” to finalize the selection.

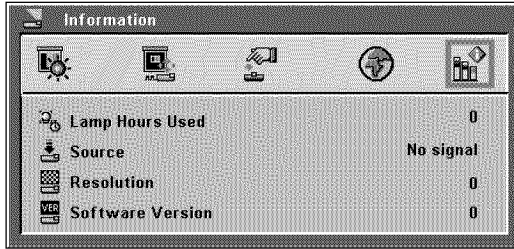

Information

Information

To display the projector information on the screen.

Troubleshooting

If you experience trouble with the projector, refer to the following information. If the problem persists, please contact your local dealer or service center.

Problem: No image appears on screen

- ✦ Ensure all the cables and power connections are correctly and securely connected as described in the “Installation” section.
- ✦ Ensure the pins of connectors are not crooked or broken.
- ✦ Check if the projection lamp has been securely installed. Please refer to the “Replacing the lamp” section.
- ✦ Make sure you have removed the lens cap and the projector is switched on.
- ✦ Ensure that the “AV-Mute” feature is not turned on.

Problem: Partial, scrolling or incorrectly displayed image

- ✦ Press “Auto Adj.” on the remote control.
- ✦ If you are using a PC:
 - For Windows 95, 98, 2000, XP:
 1. From the “My Computer” icon, open the “Control Panel” folder, and double click the “Display” icon.
 2. Select the “Settings” tab
 3. Click on the “Advanced Properties”.
 - For Windows Vista:
 1. From the “My Computer” icon, open the “Control Panel” folder, and double click the “Appearance and Personalization”
 2. Select “Personalization”
 3. Click “Adjust screen resolution” to display “Display Settings”. Click on the “Advanced Settings”.

If the projector is still not projecting the whole image, you will also need to change the monitor display you are using. Refer to the following steps.

Appendices

4. Verify the resolution setting is less than or equal to 1280 x 1024 resolution.
 5. Select the "Change" under the "Monitor" tab .
 6. Click on "Show all devices". Next, select "Standard monitor types" under the SP box; choose the resolution mode you need under the "Models" box.
- If you are using a Notebook:
1. First, follow the steps above to adjust resolution of the computer.
 2. Press the toggle output settings. example: [Fn]+[F4]

Compaq=>	[Fn]+[F4]	Hewlett	=>	[Fn]+[F4]
Dell =>	[Fn]+[F8]	Packard	=>	[Fn]+[F4]
Gateway=>	[Fn]+[F4]	NEC=>	[Fn]+[F3]	
IBM=>	[Fn]+[F7]	Toshiba =>	[Fn]+[F5]	

Macintosh Apple:
System Preference-->Display-->Arrangement-->Mirror display

- If you experience difficulty changing resolutions or your monitor freezes, restart all equipment including the projector.

Problem: The screen of the Notebook or PowerBook computer is not displaying a presentation

- If you are using a Notebook PC:

Some Notebook PCs may deactivate their own screens when a second display device is in use. Each has a different way to be reactivated. Refer to your computer's documentation for detailed information.

Problem: Image is unstable or flickering

- Adjust the "Phase" to correct it. Refer to the "Image" section for more information.
- Change the monitor color setting from your computer.

Problem: Image has vertical flickering bar

- Use “Clock” to make an adjustment.
- Check and reconfigure the display mode of your graphic card to make it compatible with the product.

Problem: Image is out of focus

- Adjust the Focus Ring on the projector lens.
- Make sure the projection screen is between the required distance 3.9 to 39.4 feet (1.2 to 12.0 meters) from the projector (refer to page 16).

Problem: The image is stretched when displaying 16:9 DVD

The projector automatically detects 16:9 DVD and adjusts the aspect ratio by digitizing to full screen with 4:3 default setting.

If the image is still stretched, you will also need to adjust the aspect ratio by referring to the following:

- Please select 4:3 aspect ratio type on your DVD player if you are playing a 16:9 DVD.
- If you can't select 4:3 aspect ratio type on your DVD player, please select 4:3 aspect ratio in the on screen menu.

Problem: Image is reversed

- Select “Display Setting-->Orientation” from the OSD and adjust the projection direction.

Problem: Lamp burns out or makes a popping sound

- When the lamp reaches its end of life, it will burn out and may make a loud popping sound. If this happens, the projector will not turn on until the lamp module has been replaced. To replace the lamp, follow the procedures in the “Replacing the Lamp”.

Problem: LED lighting message

Message	Power-LED		
	(Blue)	(Red)	(Purple)
Standby (Input power cable)	Flashing (0.5 sec.)	○	○
Power on (Warming up)	☀	○	○
Lamp lighting (Displaying)	☀	○	○
Power off (Cooling-I)	☀	○	○
Power off (Cooling-II)	Flashing (0.5 sec.)	○	○
Error (Lamp failed)	○	Flashing (1 sec.)	○
Error (Fan lock)	○	Flashing (0.5 sec.)	○
Error (Over temp.)	○	☀	○
Standby mode (Lamp failed)	○	○	Flashing (1 sec.)
Standby mode (Fan lock)	○	○	Flashing (0.5 sec.)
Standby mode (Over temp.)	○	○	☀

NOTE



Steady light => ☀
No light => ○

Problem: Message Reminders

- Over temperature - the projector has exceeded its recommended operating temperature and must be allowed to cool down before it may be used.



- Replacing the lamp - the lamp is about to reach its maximum life-time. Prepare to replace it soon.

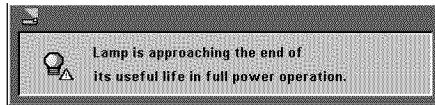

- Fan failed - the system fan is not working.



Replacing the lamp (optional lamp NP10LP)

The projector will detect the lamp life at 3400 hours in Normal mode. When the "Power" LED indicator flashes red and the message below displays on-screen, the projector has detected that the lamp is approaching its end of life. (Use the same explanations on page 14) It will show you a warning message



Warning: To avoid burns, allow the projector to cool for at least 60 minutes before you replace the lamp!

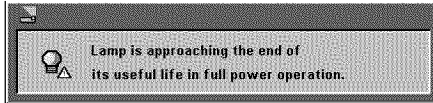

When you see this message, change the lamp as soon as possible. Make sure the projector has been cooled down for at least 60 minutes before changing the lamp.

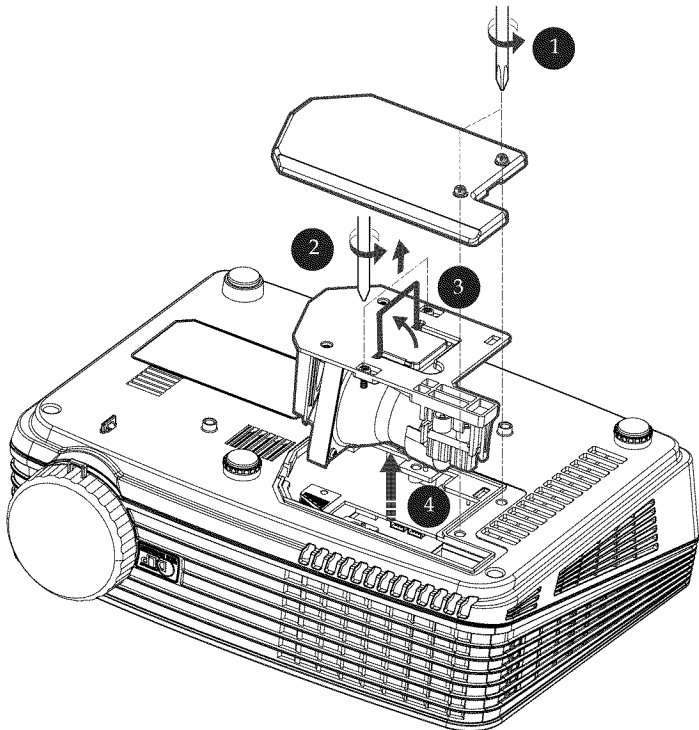



Warning: To reduce the risk of personal injury, do not drop the lamp module or touch the lamp bulb. The bulb may shatter and cause injury if it is dropped.

Lamp Replacing Procedure:

1. Switch off the power to the projector by pressing the Power.
2. Allow the projector to cool down at least 60 minutes.
3. Disconnect the power cable.
4. Use a screwdriver to remove the 2 screws from the cover. ❶
5. Push up and remove the cover.
6. Remove the 2 screws from the lamp module ❷ and pull up the lamp bar. ❸
7. Pull out the lamp module by force. ❹
8. Install the new lamp module by reversing the previous steps.
9. After replacing the lamp, turn on the power, and select the menu ->[Reset] ->[Clear Lamp Hours] to reset the lamp usage hours. See page 25.

Specifications

Projection System	Single Chip DLP™ Technology by Texas Instruments
Number of Pixels*	NP100: 800 pixels(H) X 600 lines(V), up to SXGA (1280 X 1024) with scaling technology NP200: 1024 pixels(H) X 768 lines(V), up to SXGA+(1400 X 1050) with scaling technology
Displayable Color	16.7M colors
Lamp	180W (150W on ECO mode)
Light Output	NP200: 2100 lumens (approx. 80% in ECO mode) NP100: 2000 lumens (approx. 80% in ECO mode)
Contrast Ratio (full white:full black)	NP200: 1300:1 NP100: 1200:1
Projection Lens	F/2.41~2.55 f=21.83~24mm with 1.1x Manual zoom lens
Projection Screen Size (Diag.)	27.5 to 302.8 inches (0.69 to 7.69 meters) Diagonal
Projection Distance	3.9 to 39.4 feet (1.2 to 12.0 meters)
Video Compatibility	- NTSC-M/NTSC-4.43/PAL-M/PAL-B, D, G, H, I/PAL-N/SECAM - Component: SDTV(480i/576i), EDTV(480p, 576p), HDTV(720p, 1080i)
H. Frequency	NP100:31.35kHz~68.7kHz horizontal scan NP200:31.35kHz~80kHz horizontal scan
V. Frequency	56Hz~85Hz vertical refresh
Power Supply	Universal AC input 100-240V ; Input Frequency 50-60Hz
Power Consumption	Normal mode:228W ECO mode:190W Standby mode <7 Watt
Input Current	2.5-1.0A (100-240V AC)
I/O Connectors	- Power: AC power input socket - Computer Input: 1x 15-pin D-Sub VGA for analog/component and HDTV signal - Video Input: 1x Composite video RCA input 1x S-Video input - Audio Input: 1x Stereo Mini Jack - Computer Output: 1x 15-pin D-Sub for Monitor output
Built-in Speaker	2W (monaural)
Weight	5.0 lbs (2.3 kgs)
Dimensions (W x D x H)	10.7 x 7.8 x 3.2 inches (272 x 199 x 80 mm) (not including protrusions)
Environmental	- Operating Temperature: 41~95°F (5~35°C) Humidity: 80% maximum (Non-condensing) - Storage Temperature: -4~140°F (-20~60°C) Humidity: 80% maximum (Non-condensing)
Safety Regulation	Safety Regulation: UL/CUL, TUV-GS EMC: CB Report, CE Class B, FCC Class B, C-Tick

* Effective pixels are more than 99.99%.

Compatibility Modes

Modes	Resolution	V.Frequency (Hz)	H.Frequency (kHz)
VGA	640 × 480	60	31.50
	640 × 480	72	37.90
	640 × 480	75	37.50
	640 × 480	85	43.30
	720 × 400	70	31.50
	720 × 400	85	37.90
SVGA	800 × 600	56	35.20
	800 × 600	60	37.90
	800 × 600	72	48.10
	800 × 600	75	46.90
	800 × 600	85	53.70
XGA	1024 × 768	60	48.40
	1024 × 768	70	56.50
	1024 × 768	75	60.00
	1024 × 768	85	68.70
SXGA	1152 × 864	70	63.80
	1152 × 864	85	77.10
	* 1152 × 864	75	67.50
	1280 × 1024	60	63.98
	* 1280 × 1024	72	76.97
SXGA+	* 1280 × 1024	75	79.98
	* 1400 × 1050	60	63.98
Power Mac G4	640 × 480	66.6 (67)	34.93
	800 × 600	60	37.90
	1024 × 768	60	48.40
	1152 × 870	75	68.68
	* 1280 × 960	75	75.00
PowerBook G4	640 × 480	60	31.35
	640 × 480	66.6 (67)	34.93
	800 × 600	60	37.90
	1024 × 768	60	48.40
	1152 × 870	75	68.68
i Mac DV	* 1280 × 960	75	75.00
	1024 × 768	75	60.00
	1152 × 870	75	68.49

NOTE

Note: "*" for XGA model only.

NOTE

Note: Shaded signals are compressed with scaling technology.

NOTE

Note: The projector only support a separate sync signal. Composite sync and sync on green are not supported.

Cabinet Dimensions

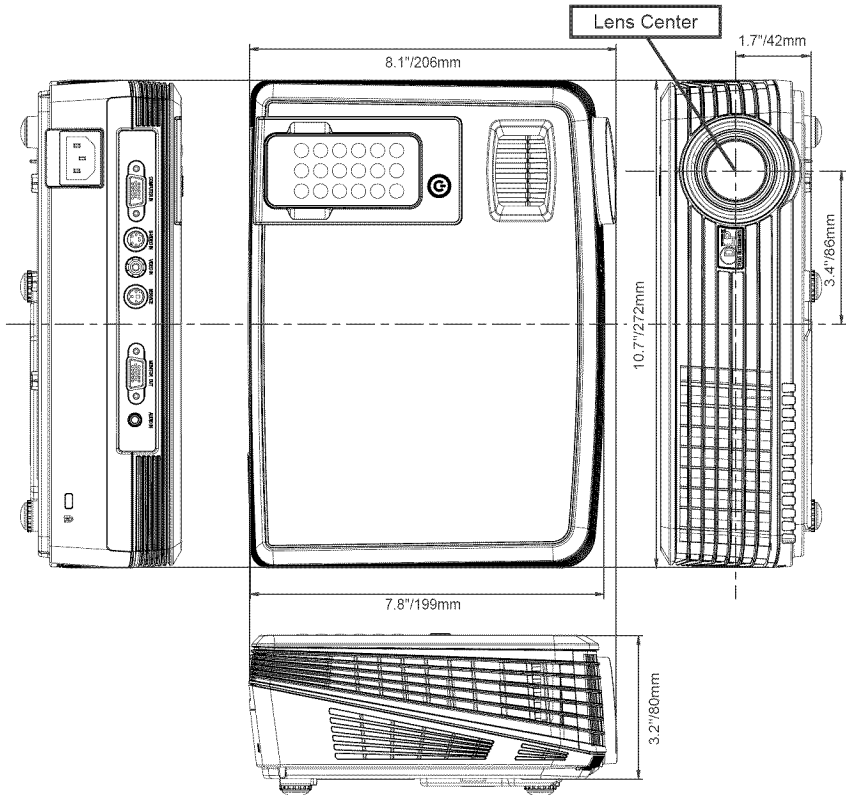

Troubleshooting Check List

Before contacting your dealer or service personnel, check the following list to be sure repairs are needed also by referring to the "Troubleshooting" section in your user's manual. This checklist below will help us solve your problem more efficiently.

* Print the following pages.

Frequency of occurrence always sometimes (How often? _____) other (_____)

Power

- No power (POWER indicator does not light blue).
 - Power cable's plug is fully inserted into the wall outlet.
 - Lamp cover is installed correctly.
 - Lamp Hours Used (lamp operation hours) was cleared after lamp replacement.
 - No power even though you press and hold the POWER button for a minimum of 1 second.
- Shut down during operation.
 - Power cable's plug is fully inserted into the wall outlet.
 - Lamp cover is installed correctly.
 - Power Management is turned off (only models with the Power Management function).

Video and Audio

- No image is displayed from your PC or video equipment to the projector.
 - Still no image even though you connect the projector to the PC first, then start the PC.
 - Enabling your notebook PC's signal output to the projector.
 - A combination of function keys will enable/disable the external display. Usually, the combination of the "Fn" key along with one of the 12 function keys turns the external display on or off.
 - No image (blue background).
 - Still no image even though you press the AUTO ADJUST button.
 - Still no image even though you carry out [RESET] in the projector's menu.
 - Signal cable's plug is fully inserted into the input connector
 - A message appears on the screen. (_____)
 - The source connected to the projector is active and available.
 - Still no image even though you adjust the brightness and/or the contrast.
 - Input source's resolution and frequency are supported by the projector.
- Image is too dark.
 - Remains unchanged even though you adjust the brightness and/or the contrast.
- Image is distorted.
 - Image appears to be trapezoidal (unchanged even though you carry out the [KEystone] adjustment).
- Parts of the image are lost.
 - Still unchanged even though you press the AUTO ADJUST button.
 - Still unchanged even though you carry out [RESET] in the projector's menu.
- Image is shifted in the vertical or horizontal direction.
 - Horizontal and vertical positions are correctly adjusted on a computer signal.
 - Input source's resolution and frequency are supported by the projector.
 - Some pixels are lost.
- Image is flickering.
 - Still unchanged even though you press the AUTO ADJUST button.
 - Still unchanged even though you carry out [RESET] in the projector's menu.
 - Image shows flickering or color drift on a computer signal.
- Image appears blurry or out of focus.
 - Still unchanged even though you checked the signal's resolution on PC and changed it to projector's native resolution.
 - Still unchanged even though you adjusted the focus.
- No sound.
 - Audio cable is correctly connected to the audio input of the projector.
 - Still unchanged even though you adjusted the volume level.

Other

- Remote control does not work.
 - No obstacles between the sensor of the projector and the remote control.
 - Projector is placed near a fluorescent light that can disturb the infrared remote controls.
 - Batteries are new and are not reversed in installation

In the space below please describe your problem in detail.

Information on application and environment where your projector is used

Projector

Model number:

Serial No.:

Date of purchase:

Lamp operating time (hours):

Lamp Mode: Normal Eco

Information on input signal:

Horizontal synch frequency [] kHz

Vertical synch frequency [] Hz

Synch polarity H (+) (-)

V (+) (-)

Synch type Separate Composite

Sync on Green

STATUS Indicator:

Steady light Orange Blue

Flashing light [] cycles

Remote control model number:

Installation environment

Screen size: inch

Screen type: White matte Beads Polarization

Wide angle High contrast

Throw distance: feet/inch/m

Orientation: Ceiling mount Desktop

Power outlet connection:

Connected directly to wall outlet

Connected to power cord extender or other (the number of connected equipment_____)

Connected to a power cord reel or other (the number of connected equipment_____)

Computer

Manufacturer:

Model number:

Notebook PC / Desktop

Native resolution:

Refresh rate:

Video adapter:

Other:

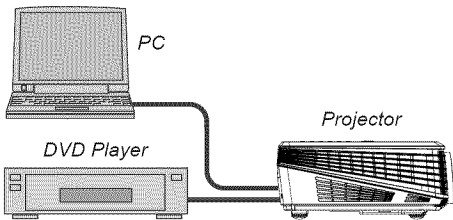

Signal cable

NEC standard or other manufacturer's cable?

Model number: Length: inch/m

Distribution amplifier

Model number:

Switcher

Model number:

Adapter

Model number:

Video equipment

VCR, DVD player, Video camera, Video game or other

Manufacturer:

Model number:

TravelCare Guide

TravelCare - a service for international travelers

This product is eligible for "TravelCare", NEC's unique international warranty.

Please note that TravelCare coverage differs in part from coverage under the warranty included with the product.

Services offered with TravelCare

This warranty allows customers to receive service on their product at the NEC and NEC-designated service stations in the countries listed herein when temporarily traveling internationally for business or pleasure.

For details on services offered by the different service stations, please refer to the "List of TravelCare Outlets" below.

1 Repair services

The product will be repaired and delivered within 10 business days, not including shipping time.

During the term of warranty, the cost of maintenance parts, labor costs for repairs and shipping costs within the service station's coverage area are covered by the warranty.

2 Replacement product rental service

If the customer desires, he or she can rent a replacement product while the original product is being repaired.

Fee: US\$200 for 12 days

This fee must be paid at the local service station in cash or credit card.

The US\$200 rental fee is non-refundable even if the customer rents it less than 12 days before returning.

The replacement product will be delivered within 3 business days.

If the customer did not return the replacement product within 12 days, the customer will be charged the price of the unit.

If the customer returned the replacement product in a faulty or damaged condition, the repair cost will be charged to the customer. Note that this service is not offered in all countries and regions. Please refer to the "List of TravelCare Outlets".

In addition, this replacement product rental service is not offered after the product's warranty has expired.

Term of warranty

- 1
- Upon presentation of the warranty or receipt received upon purchase:

Valid for the term indicated on the warranty or the normal term of warranty for the country of purchase.

- When only the product is brought in:

Valid for a period of within 14 months of the date of manufacture indicated by the serial number attached to the product.

- 2 When a product whose term of warranty is expired is brought in:
Repairs will be offered for a fee. In this case the customer is not eligible for the replacement product rental service.
- 3 In the following cases, repairs may be charged, even if the product's warranty is still in effect:
- If the term of warranty, model name, serial number and name of the store of purchase are not indicated on the warranty or have been altered.
 - Problems or damage caused by dropping or shocks during shipment or movement by the customer or by improper handling by the customers.
 - Problems or damage caused by improper usage or unwarrantable alterations or repairs by the customer.
 - Problems or damage caused by fire, salt damage, gas damage, earthquakes, lightning damage, storm or flood damage or other natural disasters or such external factors as dust, cigarette smoke, abnormal voltage, etc.

- Problems or damage caused by use in hot or humid places, in vehicles, boats or ships, etc.
- Problems or damage caused by expendable supplies or devices connected to the product other than those designated by NEC.
- Problems caused by natural consumption, wear or deterioration of parts under normal usage conditions.
- Problems or damage to lamps and other expendable supplies, included parts or optional parts.
- Other conditions stipulated in the warranty included with the product also apply.

NOTE: The product can be used overseas with voltages of 100 to 120V and 200 to 240V by using a power cable suited for the standards and power source voltage of the country in which the product is being used.

List of TravelCare Outlets

This list applies as of October 1, 2007.

For the most up-to-date information, please refer to the websites of the service stations in the various countries on the List of TravelCare Outlets or to the NEC website at <http://www.nec-pj.com>.

In Europe

NEC Europe, Ltd. / European Technical Centre
Address: Unit G, Stafford Park 12, Telford TF3 3BJ, U.K.
Telephone: +44 1952 237000
Fax Line: +44 1952 237006
Email Address: AFR@uk.neceur.com
WEB Address: <http://www.neceur.com>

(Regions Covered)

EU: Austria*, Belgium*, Denmark*, Finland*, France*, Germany*, Greece*, Ireland*, Italy*, Luxembourg*, The Netherlands*, Portugal*, Spain*, Sweden* and the United Kingdom*
EEA: Norway*, Iceland and Liechtenstein

In North America

NEC Display Solutions of America, Inc.
Address: 500 Park Boulevard, Suite 1100
Itasca, Illinois 60143, U.S.A.
Telephone: +1 800 836 0655
Fax Line: +1 800 356 2415
Email Address: vsd.tech-support@necdisplay.com
WEB Address: <http://www.necdisplay.com/>

(Regions Covered)

U.S.A. *, Canada*

In Oceania

NEC Australia Pty., Ltd.
Address:
New South Wales;
184 Milperra Road, Reversby NSW 2212
Telephone: +61 2 9780 8688 Fax Line: +61 2 9780 8659
Victoria;
Unit 1/6 Garden Road, Clayton VIC 3168
Telephone: +61 3 8562 6245 Fax Line: +61 3 8562 6220
Newcastle;
120 Parry Street Newcastle West NSW 2300
Telephone: +61 2 4926 2466
Queensland;
Unit 4/305 Montague Road West End QLD 4101
Telephone: +61 7 3840 5858 Fax Line: +61 7 3840 5866
Goldcoast QLD;
Shop1 48 Ferry Road Southport QLD 4215
Telephone: +61 7 5591 3670
South Australia;
84A Richmond Road, Keswick SA 5035
Telephone: +61 8 8375 5707 Fax Line: +61 8 8375 5757
Western Australia;
45 Sarich Court Osborne Park WA 6017
Telephone: +61 8 9445 5901 Fax Line: +61 8 9445 5999

WEB Address: <http://www.nec.com.au>

(Regions Covered)

Australia*, New Zealand

In Asia and Middle East

NEC Display Solutions, Ltd.

Address: 686-1, Nishioi, Oi-Machi, Ashigarakami-Gun,
Kanagawa 258-0017, Japan

Telephone: +81 465 85 2369

Fax Line: +81 465 85 2393

Email Address: support_pjweb@gw.neds.nec.co.jp

WEB Address: <http://www.nec-pj.com>

(Regions Covered)

Japan*

NEC Solutions (China) Co., Ltd.

Address: Rm 1903, Shining Building, 35 Xueyuan Rd,
Haidian District Beijing 100083, P.R.C.

Telephone: +8610 82317788

Fax Line: +8610 82331722

Email Address: Lily@necsl.com.cn
Johnson_liu@necsl.com.cn

WEB Address: <http://www.necsl.com.cn>

(Regions Covered)

China

NEC Hong Kong Ltd.

Address: 25/F, The Metropolis Tower, 10 Metropolis Drive,
Hungghom, Kowloon, Hong Kong

Telephone: +852 2369 0335

Fax Line: +852 2795 6618

Email Address: nechksc@nechk.nec.com.hk
esmond_au@nechk.nec.com.hk

WEB Address: <http://www.nec.com.hk>

(Regions Covered)

Hong Kong

NEC Taiwan Ltd.

Address: 7F, No.167, SEC.2, Nan King East Road, Taipei,
Taiwan, R.O.C.

Telephone: +886 2 8500 1714

Fax Line: +886 2 8500 1420

Email Address: chenguanfu@nec.com.tw

WEB Address: <http://www.nec.com.tw>

(Regions Covered)

Taiwan

NEC Asia Pte.Ltd.

Address: 401 Commonwealth Drive, #07-02, Haw Par
Technocentre, Singapore 149598

Telephone: +65 6 273 8333

Fax Line: +65 6 274 2226

Email Address: tehgh@rsc.ap.nec.com.sg

WEB Address: <http://www.nec.com.sg/ap>

(Regions Covered)

Singapore

NEC Systems Integration Malaysia Sdn Bhd

Address: Ground Floor, Menara TA One, 22, Jalan P. Ramlee,
50250 Kuala Lumpur, Malaysia

Telephone: +6 03 2178 3600 (ISDN)

Fax Line: +6 03 2178 3789

Email Address: necare@nsm.nec.co.jp

WEB Address: <http://www.necarecenter.com>

(Regions Covered)

Malaysia

Hyosung ITX Co., Ltd.

Address: 2nd Fl., Ire B/D. #2, 4Ga, Yangpyeng-Dong,
Youngdeungpo-Gu, Seoul, Korea 150-967

Telephone: +82 2 2163 4193

Fax Line: +82 2 2163 4196

Email Address: moneybear@hyosung.com

(Regions Covered)

South Korea

Lenso Communication Co., Ltd.

Address: 292 Lenso House 4, 1st Floor, Srinakarin Road,
Huamark, Bangkok, Bangkok 10240, Thailand

Telephone: +66 2 375 2425

Fax Line: +66 2 375 2434

Email Address: pattara@lenso.com

WEB Address: <http://www.lenso.com>

(Regions Covered)

Thailand

ABBA Electronics L.L.C.

Address: Tariq Bin Ziyad Road, P.O.Box 327, Dubai,
United Arab Emirates

Telephone: +971 4 371800

Fax Line: +971 4 364283

Email Address: ABBA@emirates.net.ae

(Regions Covered)

United Arab Emirates

Samir Photographic Supplies

Address: P.O.Box 599, Jeddah 21421, Saudi Arabia

Telephone: +966 2 6828219

Fax Line: +966 2 6830820

Email Address: asif@samir-photo.com

Riyadh

Address: P.O.Box 5519, Riyadh 11432, Saudi Arabia

Telephone: +966 1 4645064

Fax Line: +966 1 4657912

Email Address: bhimji@samir-photo.com

Alkhubar

Address: P.O.Box 238, Alkhubar 31952, Saudi Arabia

Telephone: +966 3 8942674

Fax Line: +966 3 8948162

Email Address: chamsedin@samir-photo.com

(Regions Covered)

Saudi Arabia

NOTE: In countries designated with an asterisk(*), replacement product rental service are offered.

Date: / / ,

P-1/ ,

TO: NEC or NEC's Authorized Service Station:

FM:

(Company & Name with signature)

Dear Sir (s),

I would like to apply your TravelCare Service Program based on attached registration and qualification sheet and agree with your following conditions, and also the Service fee will be charged to my credit card account, if I don't return the Loan units within the specified period. I also confirm following information is correct. Regards.

Application Sheet for TravelCare Service Program

Country, product purchased :	
User's Company Name :	
User's Company Address : Phone No., Fax No. :	
User's Name :	
User's Address :	
Phone No., Fax No. :	
Local Contact office :	
Local Contact office Address :	
Phone No., Fax No. :	
User's Model Name :	
Date of Purchase :	
Serial No. on cabinet :	
Problem of units per User :	
Required Service :	(1) Repair and Return (2) Loan unit
Requested period of Loan unit :	
Payment method :	(1) Credit Card (2) Travelers Cheque (3) Cash
In Case of Credit Card : Card No. w/Valid Date :	

Condition of your TravelCare Service Program

Enduser is requested to understand following condition of TravelCare Service Program and complete the necessary information on the application sheet.

1. Service Options:

There are 3 types of "Service" available. Enduser has to understand following condition and is required to fill in the Application Sheet.

1) Repair and Return:

The 'Faulty unit' is sent or collected from the customer. It is repaired and returned within 10 days to the customer, excluding transport time.

There may have a case, repair and return can't be done by NEC Authorized Service Station, because of shortage of spare parts due to same model is not sold in the territory.

2) Repair and Return with Loan: (This service is limited to some Service Stations)

This service is offered to the Enduser, who cannot wait until their unit is repaired.

The customer can borrow a unit for \$200 up to 12 days. Customer then sends in inoperable unit to nearest NEC Authorized Service Station for service. In order to prevent collection problem, Enduser is required to fill in Application Sheet.

Enduser needs to confirm the availability of the Service to NEC Authorized Service Stations.

3) Loan Only:

For this service, NEC Authorized Service Station supplies the customer with a loan unit for US\$200 up to 12 days. Customer keeps the inoperable unit and when customer returns home, customer arranges to have the projector serviced in the home country.

2. Warranty Exclusions:

This program does not apply if the Projector's serial number has been defaced, modified or removed.

If, in the judgement of NEC Authorized Service Station or its agent the defects or failures result from any cause other than fair wear and tear or NEC neglect, or fault including the following without limitation:

- 1) Accidents, transportation, neglect, misuse, abuse, water, dust, smoke or default of or by the Customer its employees or agents or any third party;
- 2) Failure or fluctuation of electrical power, electrical circuitry, air conditioning, humidity control or other environmental conditions such as use it in smoking area;
- 3) Any fault in the attachments or associated products or components (whether or not supplied by NEC or its agents which do not form part of the Product covered by this warranty);
- 4) Any act of God, fire, flood, war, act of violence or any similar occurrence;
- 5) Any attempt by any person other than any person authorized by NEC to adjust, modify, repair, install or service the product.
- 6) Any Cross-border charges such as, duty, insurance, tax etc.

3. Charges for Warranty Exclusions and Out of Warranty Case:

In case faulty unit is under warranty exclusions case or under Out of Warranty period, NEC Authorized Service Station will Inform estimation of actual service cost to the Enduser with reason.

4. Dead on Arrival (DOA):

Enduser must take this issue up with their original supplier in the country of purchase.

NEC Authorized Service Station will repair the DOA unit as a Warranty repair, but will not exchange DOA unit with new units.

5. Loan Service Charges and Conditions:

Upon acceptance of this NEC Projector, Customer agrees to assume liability for this loan unit.

The current cost of use of this loan unit is \$200.00 USD for 12 calendar days.

If Customer does not return the unit within the 12 calendar days, Customer will be charged the next highest cost up to and including the full list price to Credit Cards, which price will be informed by NEC Authorized Service Stations. Please see the attached listing of contacts for each country to arrange for pickup of the loan unit.

If you return to their country of origin with the loan unit, you will be charged additional freight to return the unit to the loaning country.

Thank you for your understanding of this program.