

myprojectorlamps.com

**The most trusted, dependable name
in projector lamp sales.**



<http://www.myprojectorlamps.com>



<http://www.myprojectorlamps.ca>



<http://www.myprojectorlamps.eu>

The following projector manual has not been modified or altered in any way.

NEC

CD-ROM version

Portable Projector

LT260/LT240/LT220

User's Manual

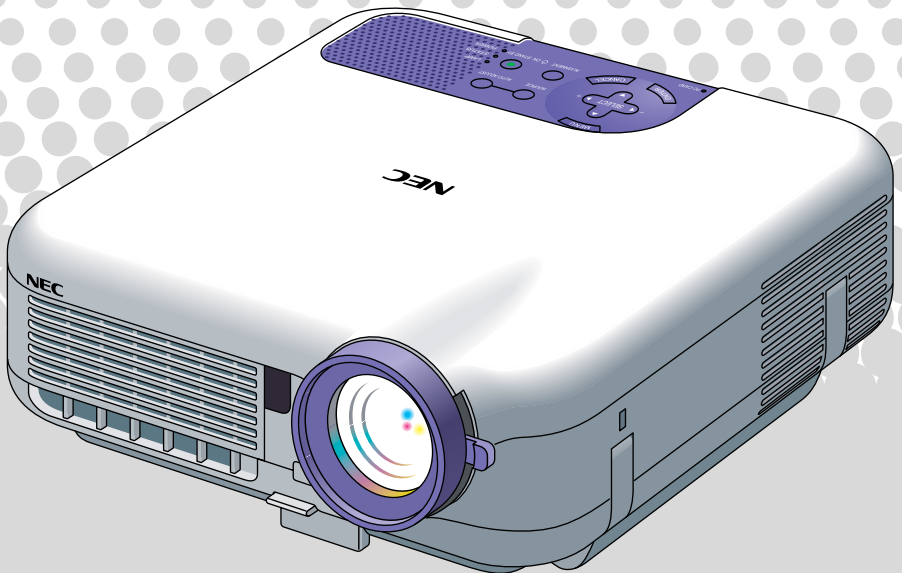

About this user's manual

The fastest way to get started is to take your time and do everything right the first time. Take a few minutes now to review the user's manual. This may save you time later on. At the beginning of each section of the manual you'll find an overview. If the section doesn't apply, you can skip it.

INTRODUCTION

Introduction to the Projector

This section introduces you to your new LT260/LT240/LT220 Projector and describes the features and controls.

Congratulations on Your Purchase of The LT260/LT240/LT220 Projector

The LT260/LT240/LT220 is one of the very best projectors available today. The LT260/LT240/LT220 enables you to project precise images up to 500 inches across (measured diagonally) from your PC or Macintosh computer (desktop or notebook), VCR, DVD player, document camera, a laser disc player or Viewer.

You can use the projector on a tabletop or cart, you can use the projector to project images from behind the screen, and the projector can be permanently mounted on a ceiling*¹. The remote control can be used wirelessly.

*¹ Do not attempt to mount the projector on a ceiling yourself.

The projector must be installed by qualified technicians in order to ensure proper operation and reduce the risk of bodily injury.

In addition, the ceiling must be strong enough to support the projector and the installation must be in accordance with any local building codes. Please consult your dealer for more information.

Features you'll enjoy:

- The newly developed 3D Reform function allows you to correct trapezoidal distortion for both horizontally and vertically so that the image is square even when projector is positioned off center of the room's screen.
- The LT260/LT240/LT220 projector provides wired and wireless networking. When using as a wireless LAN projector, no physical signal cable connection to a PC is required.*²

² A wireless LAN card is required. The NEC optional wireless LAN card is available. (SWL-2100N-N)

Safety protect by Passcode and Security functions

Passcode and Security features prevent the projector from being used by unauthorized individuals.

Passcode prevents unauthorized individuals from changing projector settings or adjustments Security offers complete protection by using your PC card as a protect key so that the projector will not project a signal without insertion of the registered PC card and unauthorized use can be discouraged.

- The built-in Viewer allows you to start your presentation even when a PC is not available at the site.
- A high-bright 220 watt DC lamp.
- The Standby mode reduces standby power consumption significantly.
- The supplied wireless remote control that operates the projector from the front side or rear.
- The image can be projected between 30 and 500 inches (measured diagonally).
- The "Capture" enables you to capture the current projected image.
- An image can be projected from in front or behind a screen, and the projector can even be installed on the ceiling.
- NEC's exclusive Advanced AccuBlend intelligent pixel blending technology - an extremely accurate image compression technology - offers a crisp image with UXGA (1600 × 1200) resolution*³.
- Supports most IBM VGA, SVGA, XGA, SXGA/UXGA(with Advanced AccuBlend)*³, Macintosh, component signal (YCbCr/YPbPr) or any other RGB signals within a horizontal frequency range of 24 to 100 kHz and a vertical frequency range of 50 to 120 Hz. This includes NTSC, PAL, PAL-N, PAL-M, PAL60, SECAM and NTSC4.43 standard video signals.

*³ A UXGA (1600 × 1200) and SXGA image (1280 × 1024) are displayed with NEC's Advanced AccuBlend on LT260/LT240/LT220.

An XGA image (1024 × 768) is displayed with NEC's Advanced AccuBlend on LT220.

NOTE: Composite video standards are as follows:

NTSC: U.S. TV standard for video in U.S. and Canada.

PAL: TV standard used in Western Europe.

PAL-N: TV standard used in Argentine, Paraguay and Uruguay.

PAL-M: TV standard used in Brazil.

PAL60: TV standard used for NTSC playback on PAL TVs.

SECAM: TV standard used in France and Eastern Europe.

NTSC4.43: TV standard used in Middle East countries.

INTRODUCTION > Introduction to the Projector

- The supplied remote control can be used without a cable, and you can even use the remote control to operate your PC's mouse wirelessly from across the room with the built-in remote mouse function.
- You can control the projector with a PC using the PC Control port.
- USB port allows USB mouse operation*⁴.
 - *⁴ The USB ports meet the USB1.1 specification.
- The contemporary cabinet design is light, compact, easy to carry, and complements any office, boardroom or auditorium.
- Eight pointers are available for your presentation.

Part Names of the Projector

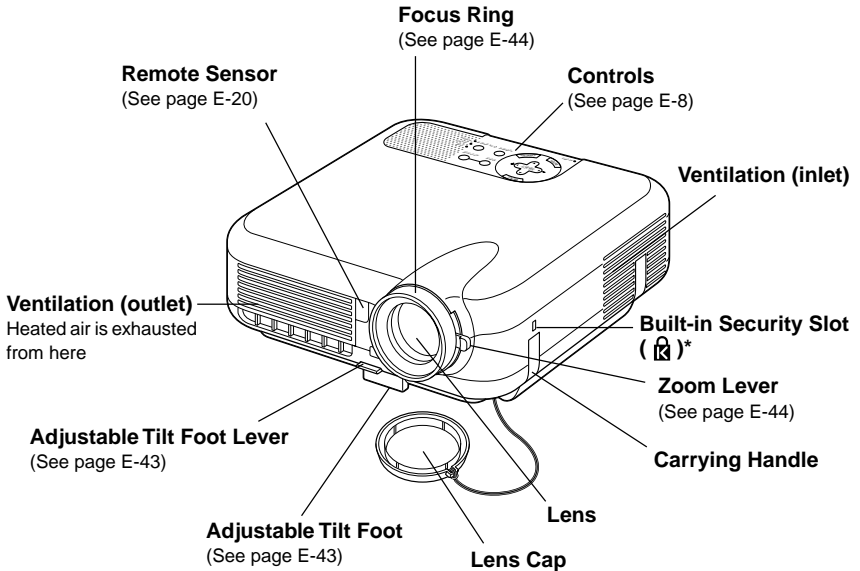

- * This security slot supports the MicroSaver® Security System. MicroSaver® is a registered trademark of Kensington Microware Inc. The logo is trademarked and owned by Kensington Microware Inc.

Attaching the lens cap

To attach the lens cap to the bottom with the supplied string and rivet:

1. Thread the string through the hole on the lens cap and then tie a knot in the string.
2. Use the rivet to attach the string to the bottom of the projector.

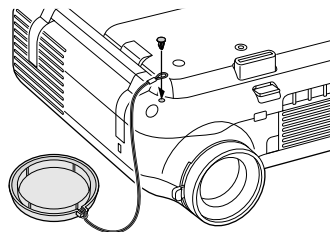
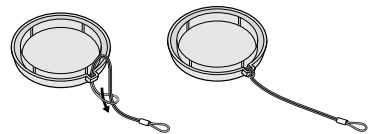

INTRODUCTION > Part Names of the Projector

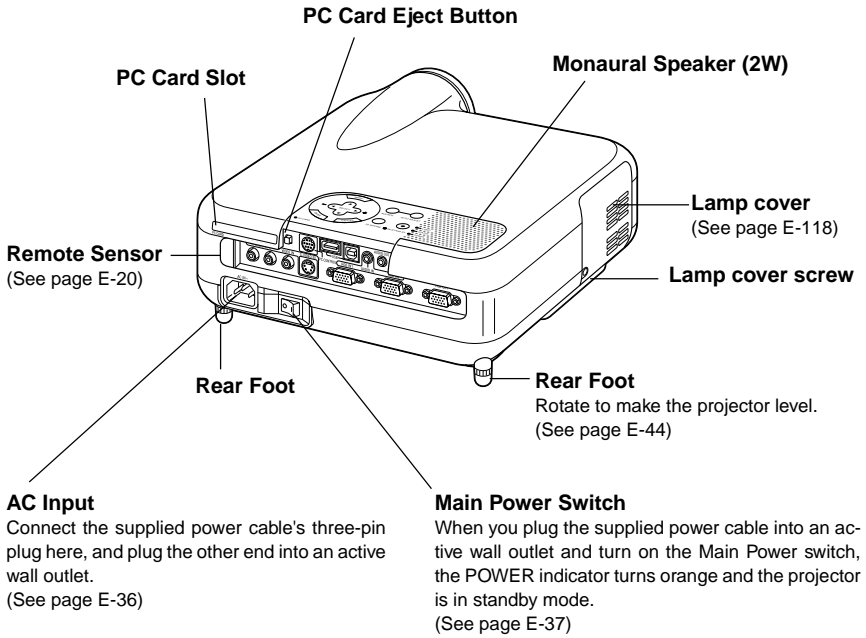

Top Features

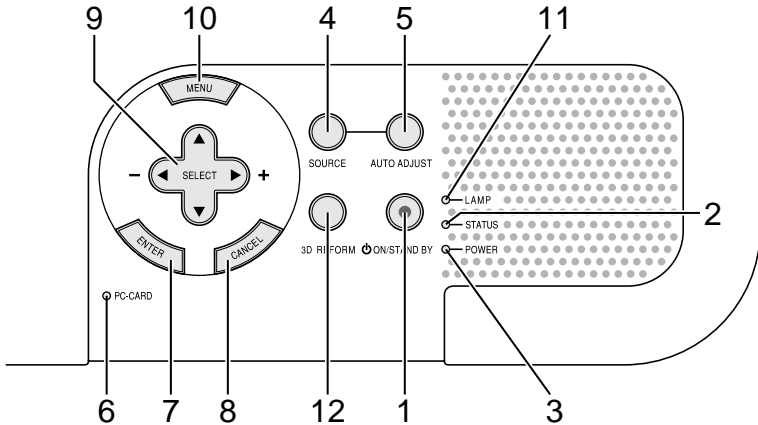

1. POWER Button (ON / STAND BY)

Use this button to turn the power on and off when the main power is supplied and the projector is in standby mode.

NOTE: To turn on or off the projector, press and hold this button for a minimum of two seconds.

2. STATUS Indicator

If this light blinks red rapidly, it indicates that an error has occurred, the lamp cover is not attached properly or the projector has overheated. If this light remains orange, it indicates that you have pressed a cabinet key while the Control Panel Key Lock is enabled. See the Status Indicator section on page E-123 for more details.

3. POWER Indicator ()

When this indicator is green, the projector is on; when this indicator is orange, it is in standby or idle mode. See the Power Indicator section on page E-123 for more details.

4. SOURCE Button

Use this button to select a video source such as a PC, VCR, DVD player, Viewer (PC card), or LAN.

Press and release this button quickly to display the Source List.

Each time this button is pressed for a minimum of TWO seconds, the input source will change as follows:

RGB1 → RGB2 → Video → S-Video → Viewer → RGB1 → ...

If no input signal is present, the input will be skipped.

5. AUTO ADJUST Button

Use this button to adjust Position-H/V and Pixel Clock/Phase for an optimal picture. Some signals may not be displayed correctly or take time to switch between sources.

6. PC CARD Access Indicator

Lights while accessing a PC card.

7. ENTER Button

Executes your menu selection and activates items selected from the menu.

8. CANCEL Button

Press this button to exit "Menus". Press this button to return the adjustments to the last condition while you are in the adjustment or setting menu.

9. SELECT ▲▼◀▶ (+) (-) / Volume Buttons

▲▼ : Use these buttons to select the menu of the item you wish to adjust. When no menus appear, these buttons work as a volume control.

◀▶ : Use these buttons to change the level of a selected menu item. A press of the ▶ button executes the selection. When the menus or the Viewer tool bar is not displayed, these buttons can be used to select a slide, or to move the cursor in Folder List or Slide List.

When the pointer is displayed, these ▲▼◀▶ buttons move the pointer.

10. MENU Button

Displays the menu.

11. LAMP Indicator

If this light blinks red rapidly, it's warning you that the projection lamp has exceeded 1500 hours (up to 2000 hours in Eco mode) of service. After this light appears, replace the lamp as soon as possible. (See page E-118). If this is lit green continually, it indicates that the lamp mode is set to Eco. See the Lamp Indicator section on page E-124 for more details.

12. 3D REFORM Button

Press this button to enter 3D Reform mode to correct the keystone (trapezoidal) distortion, and make the image square.

Terminal Panel Features

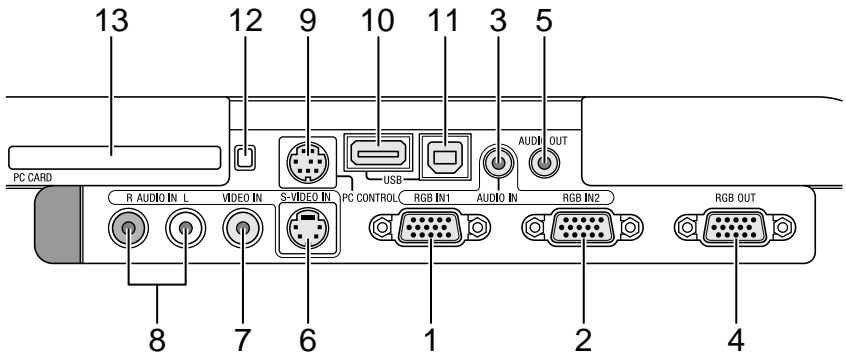

1. RGB IN 1 / Component Input Connector (Mini D-Sub 15 Pin)
Connect your computer or other analog RGB equipment such as IBM compatible or Macintosh computers. Use the supplied RGB cable to connect to your computer. This also serves as a component input connector that allows you to connect a component video output of component equipment such as a DVD player. This connector also supports SCART output signal. See page E-29 for more details.

2. RGB IN 2 / Component Input Connector (Mini D-Sub 15 Pin)
This connector has the same function as the RGB IN 1 connector.

NOTE: The RGB IN 2 does not support SCART output signal and Plug & Play.

3. RGB AUDIO IN Mini Jack (Stereo Mini)
This is where you connect audio output from your computer or DVD player. A commercially available audio cable is required.
4. RGB OUT Connector (Mini D-Sub 15 Pin)
You can use this connector to loop your computer image to an external monitor from the RGB 1 or 2 input source.
The RGB analog signal set on RGBOUT Terminal is output during idle mode. See pages E-32 and 100.

5. AUDIO OUT Mini Jack (Stereo Mini)

Connect an additional audio equipment here to listen to audio coming from your computer, Video or S- Video input.

Note that there is no audio output from this jack during Standby and Idle.

6 S-VIDEO IN Connector (Mini DIN 4 Pin)

Here is where you connect the S-Video input from an external source like a VCR.

NOTE: S-Video provides more vivid color and higher resolution than the traditional composite video format.

7. VIDEO IN Connector (RCA)

Connect a VCR, DVD player, laser disc player, or document camera here to project video.

8. VIDEO AUDIO IN Jacks (RCA)

L : This is your left channel audio input for stereo sound coming from the VIDEO source.

R : This is your right channel audio input for stereo sound from the VIDEO source.

9. PC CONTROL Port (Mini DIN 8 Pin)

Use this port to connect your PC to control your projector via a serial cable. This enables you to use your PC and serial communication protocol to control the projector. The NEC optional serial cable (CA03D) is required to use this port. You can also control the projector by using Dynamic Image Utility 2.0 included on the supplied CD-ROM.

To do so you must first have Dynamic Image Utility 2.0 installed on your PC. If you are writing your own program, typical PC control codes are on page E-133. A cap is put on the port at the factory. Remove the cap when using the port.

10. USB Port (Type A)

Connect a commercially available mouse that supports USB. You can operate the menu or Viewer with the USB mouse via this port.

Note that this port should not be connected to a computer and that there may be some brands of USB mouse that the projector does not support.

11. USB Port (Type B)

Connect this port to the USB port (type A) of your PC using the supplied USB cable. You can operate your computer's mouse functions from the remote control.

12. PC CARD Eject Button

Press to eject a PC card partially.

13. PC CARD Slot

Insert a PC card, commercially available LAN card or NEC optional wireless LAN card here.

Part Names of the Remote Control

NOTE: If you are using a Macintosh computer, you can click either the right-click or left-click button to activate the mouse.

1. Infrared Transmitter

Direct the remote control toward the remote sensor on the projector cabinet.

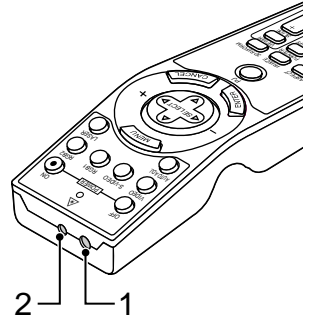

2. LASER Pointer

Beams a laser light when the LASER button is pressed.

3. LED

Flashes when any button is pressed.

4. POWER ON Button

If the main power is applied, you can use this button to turn your projector on.

NOTE: To turn on the projector, press and hold the POWER ON button for a minimum of two seconds.

5. POWER OFF Button

You can use this button to turn your projector off.

NOTE: To turn off the projector, press and hold the POWER OFF button for a minimum of two seconds.

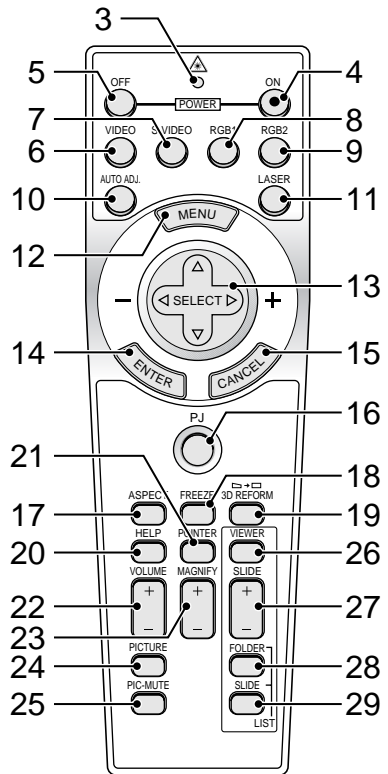

INTRODUCTION > Part Names of the Remote Control

6. VIDEO Button

Press this button to select an NTSC, PAL, PAL-N, PAL-M, PAL60, SECAM or NTSC4.43 compatible video source from a VCR, DVD player, or laser disc player.

7. S-VIDEO Button

Press this button to select an S-Video source from a VCR.

8. RGB 1 Button

Press this button to select a video source from computer or component equipment connected to your RGB IN 1 port.

9. RGB 2 Button

Press this button to select a video source from computer or component equipment connected to your RGB IN 2 port.

10. AUTO ADJ Button

Use this button to adjust an RGB source for an optimal picture. Some signals may not be displayed correctly or take time to be displayed. See page E-48.

11. LASER Button

Press and hold this button to activate the laser pointer. When lit, you can use the laser to draw your audience's attention to a red dot that you can place on any object.

12. MENU Button

Displays the menu for various settings and adjustments.

13. SELECT ▲▼◀▶ (Mouse) Button

When you are in the Computer mode, these buttons work as a computer mouse. When you are in the Projector mode, which is indicated by lighting the PJ button. See page E-53.

▲▼ : Use these buttons to select the menu of the item you wish to adjust.

◀▶ : Use these buttons to change the level of a selected menu item. A press of the ▶ button executes the selection.

When the pointer is displayed, these ▲▼◀▶ buttons move the pointer. When the pointer is not displayed, these ▲▼◀▶ buttons are for adjusting the image.

14. ENTER (Left Click) Button

When you are in the Computer mode, this button works as the mouse left button. When this button is pressed and held for a minimum of 2 seconds, the drag mode is set. When you are in the Projector mode, which is indicated by lighting the PJ button:

Use this button to enter your menu selection. It works the same way as the ENTER button on the cabinet. See page E-9.

15. CANCEL (Right Click) Button

When you are in the Computer mode, this button works as the mouse right button. When you are in the Projector mode, which is indicated by lighting the PJ button: Press this button to exit the Menus. It works the same way as the CANCEL button on the cabinet.

16. PJ Button

Press this button to switch the SELECT, CANCEL, and ENTER buttons between the Projector mode (lit red) and the Computer mode. Press this button or any one of the POWER ON/OFF, MENU, ASPECT, 3D REFORM, HELP, POINTER, MAGNIFY, PICTURE, VIEWER, FOLDER LIST or SLIDE LIST buttons to switch to the Projector mode and the PJ button lights red. To switch back to the Computer mode, press the PJ button again. See page E-53.

INTRODUCTION > Part Names of the Remote Control

17. ASPECT Button

Press this button to display the Aspect Ratio select screen. See page E-86.

18. FREEZE Button

This button will freeze a picture. Press again to resume motion.

19. 3D REFORM Button

Press this button to enter 3D Reform to correct the keystone (trapezoidal) distortion, and make the image square. See page E-45.

20. HELP Button

Provides the online help or the set information.

21. POINTER Button

Press this button to display one of the eight pointers; press again to hide the pointer. You can move your pointer icon to the area you want on the screen using the Select **▲▼◀▶** button. See page E-55.

22. VOLUME (+) (-) Button

Press (+) to increase the volume and (-) to decrease it.

23. MAGNIFY (+) (-) Button

Use this button to adjust the image size up to 400%. When the pointer is displayed, the image is magnified about the center of the pointer. When the pointer is not displayed, the image is magnified about the center of the screen. When the image is magnified, the pointer is changed to the magnifying icon. See page E-56.

24. PICTURE Button

Press this button to display the Picture adjustment screen such as Brightness, Contrast, Color, Hue, and Sharpness. See page E-85.

25. PICTURE MUTE Button

This button turns off the image and sound for a short period of time. Press again to restore the image and sound.

NOTE: When the menu is displayed, a press of this button mutes an image and sound without turning off the menu.

26. VIEWER Button

Press this button to select the Viewer source.

27. SLIDE (+) (-) Button

Press (+) to select the next folder or slide and (-) to select the previous folder or slide. See page E-67.

28. FOLDER LIST Button

Press this button to select Viewer source to display a list of folders included in a PC card. See page E-67.

29. SLIDE LIST Button

Press this button to select Viewer source to display a list of slides included in a PC card. See page E-67.

NOTE: The default is the Computer mode, which allows you to use the SELECT, CANCEL, and ENTER buttons as your computer mouse. When the POWER ON/OFF, MENU, ASPECT, 3D REFORM, HELP, POINTER, MAGNIFY, PICTURE, VIEWER, FOLDER LIST, or SLIDE LIST button is pressed, the PJ button lights red to indicate that you are in the Projector mode. If no buttons are pressed within 60 seconds, the light goes out and the Projector mode is canceled.

Battery Installation

- 1. Press firmly and slide the battery cover off.**

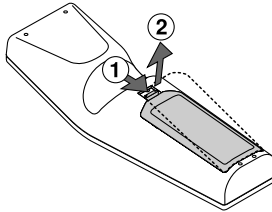

- 2. Remove both old batteries and install new ones (AA). Ensure that you have the batteries' polarity (+/-) aligned correctly.**

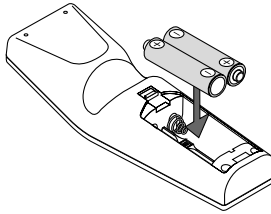

- 3. Slip the cover back over the batteries until it snaps into place. Do not mix different types of batteries or new and old batteries.**

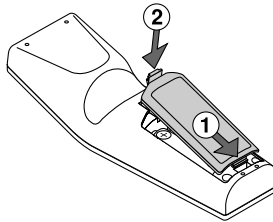

Note on Remote Control Operation:

If you press and hold the SELECT ▲▼◀▶ button while installing new batteries, the remote control may fail to work properly.

Should this happen, remove the batteries and then install them again without touching the SELECT button.

Remote Control Precautions

- Handle the remote control carefully.
- If the remote control gets wet, wipe it dry immediately.
- Avoid excessive heat and humidity.
- If you will not be using the remote control for a long time, remove the batteries.
- Do not place the batteries upside down.
- Do not use new and old batteries together, or use different types of batteries together

Operating Range

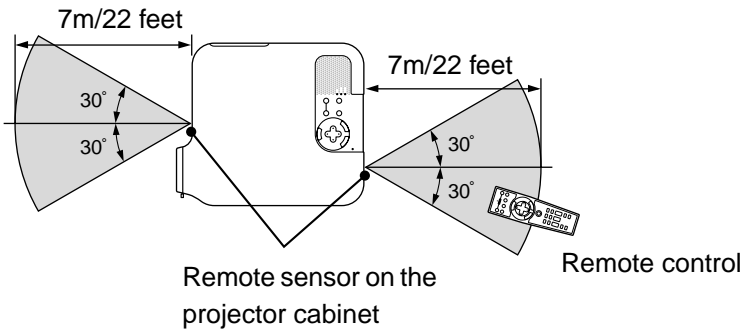

- The infrared signal operates by line-of-sight up to a distance of about 22 feet/7 m and within a 60-degree angle of the remote sensor on the projector cabinet.
- The projector will not respond if there are objects between the remote control and the sensor, or if strong light falls on the sensor. Weak batteries will also prevent the remote control from properly operating the projector.

INSTALLATION AND CONNECTIONS

This section describes how to set up your projector and how to connect video and audio sources.

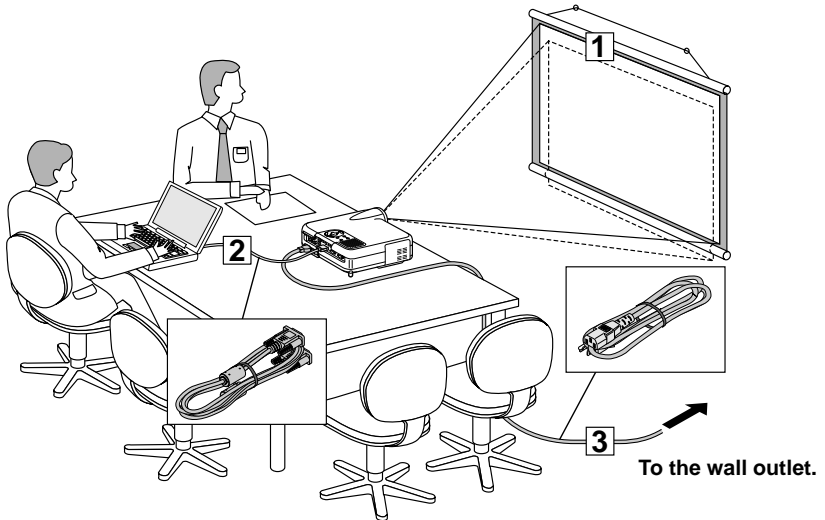

Your projector is simple to set up and use. But before you get started, you must first:

- 1 Set up a screen and the projector.**
- 2 Connect your computer or video equipment to the projector. See page E-28.**
- 3 Connect the supplied power cable. See page E-36.**

NOTE: Ensure that the power cable and any other cables are disconnected before moving the projector.

When moving the projector or when it is not in use, cover the lens with the lens cap.

Setting Up the Screen and the Projector

Selecting a Location

The further your projector is from the screen or wall, the larger the image. The minimum size the image can be is approximately 30" (0.8 m) measured diagonally when the projector is roughly 4 feet (1.3 m) from the wall or screen. The largest the image can be is 500" (12.7 m) when the projector is about 80.83 feet (24.64 m) from the wall or screen. Use the drawing below as a guide.

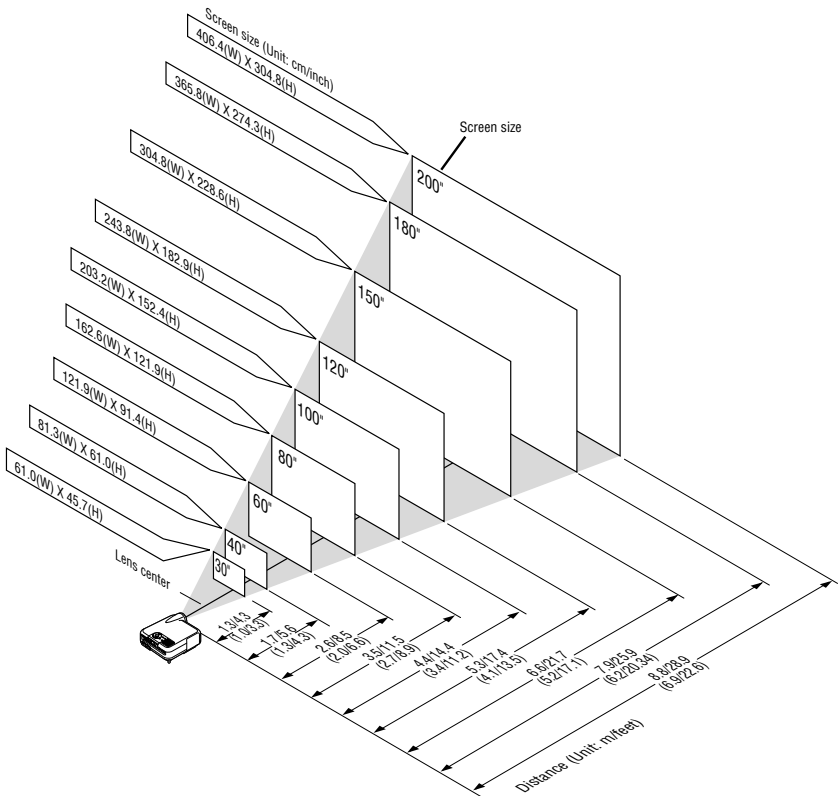

NOTE: Values in parentheses for LT240.

Throw Distance and Screen Size

The following shows the proper relative positions of the projector and screen. Refer to the table to determine the position of installation.

Distance Chart

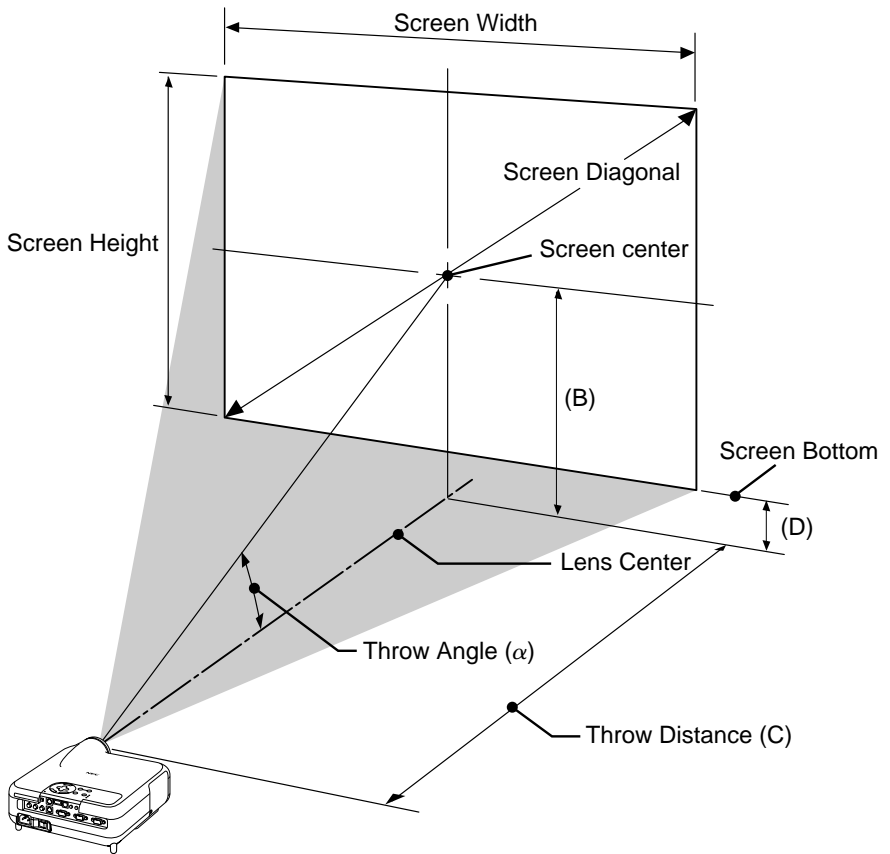

B = Vertical distance between lens center and screen center

C = Throw distance

D = Vertical distance between lens center and bottom of screen

α = Throw angle

**INSTALLATION AND CONNECTIONS > Setting Up the Screen and the Projector
<LT260>**

B = Vertical distance between lens center and screen center

C = Throw distance

D = Vertical distance between lens center and bottom of screen

α = Throw angle

NOTE: Distances may vary +/-5%.

Screen Size			B inch	C Wide – Tele inch	D inch	α Wide – Tele degree
Diagonal inch	Width inch	Height inch				
30	24	18	12.6	46.4 – 57.0	3.6	15.2 - 12.5
40	32	24	16.8	62.4 – 76.4	4.8	15.1 - 12.4
60	48	36	25.3	94.5 – 115.3	7.3	15.0 - 12.4
67	54	40	28.2	105.8 – 128.9	8.1	14.9 - 12.3
72	58	43	30.3	113.8 – 138.6	8.7	14.9 - 12.3
80	64	48	33.7	126.6 – 154.1	9.7	14.9 - 12.3
84	67	50	35.4	133.0 – 161.9	10.2	14.9 - 12.3
90	72	54	37.9	142.7 – 173.6	10.9	14.9 - 12.3
100	80	60	42.1	158.7 – 193.0	12.1	14.9 - 12.3
120	96	72	50.5	190.8 – 231.8	14.5	14.8 - 12.3
150	120	90	63.2	239.0 – 290.1	18.2	14.8 - 12.3
180	144	108	75.8	287.1 – 348.4	21.8	14.8 - 12.3
200	160	120	84.2	319.2 – 387.2	24.2	14.8 - 12.3
210	168	126	88.4	335.3 – 406.7	25.4	14.8 - 12.3
240	192	144	101.1	383.4 – 464.9	29.1	14.8 - 12.3
261	209	157	109.9	417.1 – 505.7	31.6	14.8 - 12.3
270	216	162	113.7	431.6 – 523.2	32.7	14.8 - 12.3
300	240	180	126.3	479.7 – 581.5	36.3	14.8 - 12.3
350	280	210	147.4	560.0 – 678.6	42.4	14.7 - 12.3
400	320	240	168.5	640.2 – 775.7	48.5	14.7 - 12.3
450	360	270	189.5	720.5 – 872.9	54.5	14.7 - 12.2
500	400	300	210.6	800.7 – 970.0	60.6	14.7 - 12.2

Screen Size			B mm	C Wide – Tele mm	D mm	α Wide – Tele degree
Diagonal mm	Width mm	Height mm				
762	610	457	321	1178 - 1448	92	15.2 - 12.5
1016	813	610	428	1586 - 1942	123	15.1 - 12.4
1524	1219	914	642	2401 - 2928	184	15.0 - 12.4
1702	1361	1021	716	2686 - 3274	206	14.9 - 12.3
1829	1463	1097	770	2890 - 3520	221	14.9 - 12.3
2032	1626	1219	855	3216 - 3915	246	14.9 - 12.3
2134	1707	1280	898	3379 - 4113	258	14.9 - 12.3
2286	1829	1372	962	3624 - 4409	277	14.9 - 12.3
2540	2032	1524	1069	4032 - 4902	307	14.9 - 12.3
3048	2438	1829	1283	4847 - 5889	369	14.8 - 12.3
3810	3048	2286	1604	6070 - 7369	461	14.8 - 12.3
4572	3658	2743	1925	7293 - 8849	554	14.8 - 12.3
5080	4064	3048	2139	8108 - 9836	615	14.8 - 12.3
5334	4267	3200	2246	8516 - 10329	646	14.8 - 12.3
6096	4877	3658	2567	9739 - 11810	738	14.8 - 12.3
6629	5304	3978	2792	10595 - 12846	803	14.8 - 12.3
6858	5486	4115	2888	10962 - 13290	831	14.8 - 12.3
7620	6096	4572	3209	12185 - 14770	923	14.8 - 12.3
8890	7112	5334	3744	14223 - 17237	1077	14.7 - 12.3
10160	8128	6096	4279	16261 - 19704	1231	14.7 - 12.3
11430	9144	6858	4814	18299 - 22171	1385	14.7 - 12.2
12700	10160	7620	5349	20338 - 24638	1539	14.7 - 12.2

**INSTALLATION AND CONNECTIONS > Setting Up the Screen and the Projector
<LT240>**

B = Vertical distance between lens center and screen center

C = Throw distance

D = Vertical distance between lens center and bottom of screen

α = Throw angle

NOTE: Distances may vary +/-5%.

Screen Size			B inch	C Wide – Tele inch	D inch	α Wide – Tele degree
Diagonal inch	Width inch	Height inch				
30	24	18	12.6	35.7 - 43.4	3.6	19.4 - 16.2
40	32	24	16.8	48.2 - 58.4	4.8	19.2 - 16.0
60	48	36	25.2	73.2 - 88.5	7.2	19.0 - 15.9
67	54	40	28.1	81.9 - 99.0	8.0	19.0 - 15.9
72	58	43	30.2	88.1 - 106.5	8.6	18.9 - 15.8
80	64	48	33.6	98.1 - 118.6	9.6	18.9 - 15.8
84	67	50	35.3	103.1 - 124.6	10.1	18.9 - 15.8
90	72	54	37.8	110.6 - 133.6	10.8	18.9 - 15.8
100	80	60	42.0	123.1 - 148.6	12.0	18.8 - 15.8
120	96	72	50.4	148.1 - 178.7	14.4	18.8 - 15.8
150	120	90	63.0	185.5 - 223.8	18.0	18.8 - 15.7
180	144	108	75.6	223.0 - 268.9	21.6	18.7 - 15.7
200	160	120	84.0	248.0 - 298.9	24.0	18.7 - 15.7
210	168	126	88.2	260.5 - 314.0	25.2	18.7 - 15.7
240	192	144	100.8	297.9 - 359.1	28.8	18.7 - 15.7
261	209	157	109.7	324.1 - 390.6	31.4	18.7 - 15.7
270	216	162	113.4	335.4 - 404.1	32.4	18.7 - 15.7
300	240	180	126.1	372.8 - 449.2	36.1	18.7 - 15.7
350	280	210	147.1	435.3 - 524.4	42.1	18.7 - 15.7
400	320	240	168.1	497.7 - 599.6	48.1	18.7 - 15.7
450	360	270	189.1	560.1 - 674.7	54.1	18.7 - 15.7
500	400	300	210.1	622.5 - 749.9	60.1	18.6 - 15.7

Screen Size			B mm	C Wide – Tele mm	D mm	α Wide – Tele degree
Diagonal mm	Width mm	Height mm				
762	610	457	320	907 - 1102	91	19.4 - 16.2
1016	813	610	426	1224 - 1484	122	19.2 - 16.0
1524	1219	914	640	1858 - 2248	183	19.0 - 15.9
1702	1361	1021	715	2080 - 2515	204	19.0 - 15.9
1829	1463	1097	768	2239 - 2706	219	18.9 - 15.8
2032	1626	1219	853	2493 - 3011	244	18.9 - 15.8
2134	1707	1280	896	2620 - 3164	256	18.9 - 15.8
2286	1829	1372	960	2810 - 3393	274	18.9 - 15.8
2540	2032	1524	1067	3127 - 3775	305	18.8 - 15.8
3048	2438	1829	1280	3761 - 4538	366	18.8 - 15.8
3810	3048	2286	1601	4713 - 5684	458	18.8 - 15.7
4572	3658	2743	1921	5664 - 6829	549	18.7 - 15.7
5080	4064	3048	2134	6298 - 7593	610	18.7 - 15.7
5334	4267	3200	2241	6615 - 7975	641	18.7 - 15.7
6096	4877	3658	2561	7567 - 9120	732	18.7 - 15.7
6629	5304	3978	2785	8233 - 9922	797	18.7 - 15.7
6858	5486	4115	2881	8518 - 10265	824	18.7 - 15.7
7620	6096	4572	3202	9470 - 11411	916	18.7 - 15.7
8890	7112	5334	3735	11055 - 13320	1068	18.7 - 15.7
10160	8128	6096	4269	12641 - 15229	1221	18.7 - 15.7
11430	9144	6858	4803	14227 - 17138	1374	18.7 - 15.7
12700	10160	7620	5336	15813 - 19046	1526	18.6 - 15.7

**INSTALLATION AND CONNECTIONS > Setting Up the Screen and the Projector
<LT220>**

B = Vertical distance between lens center and screen center

C = Throw distance

D = Vertical distance between lens center and bottom of screen

α = Throw angle

NOTE: Distances may vary +/-5%.

Screen Size			B inch	C Wide – Tele inch	D inch	α Wide – Tele degree
Diagonal inch	Width inch	Height inch				
30	24	18	13.0	48.0 - 59.0	4.0	15.2 - 12.4
40	32	24	17.4	64.5 - 79.0	5.4	15.1 - 12.4
60	48	36	26.0	97.6 - 119.0	8.0	14.9 - 12.3
67	54	40	29.1	109.1 - 133.0	9.0	14.9 - 12.3
72	58	43	31.2	117.4 - 143.0	9.6	14.9 - 12.3
80	64	48	34.7	130.6 - 159.0	10.7	14.9 - 12.3
84	67	50	36.4	137.2 - 167.0	11.2	14.9 - 12.3
90	72	54	39.0	147.1 - 179.0	12.0	14.9 - 12.3
100	80	60	43.4	163.7 - 199.0	13.4	14.8 - 12.3
120	96	72	52.1	196.7 - 239.0	16.1	14.8 - 12.3
150	120	90	65.1	246.3 - 299.0	20.1	14.8 - 12.3
180	144	108	78.1	295.9 - 359.0	24.1	14.8 - 12.3
200	160	120	86.8	328.9 - 399.0	26.8	14.8 - 12.3
210	168	126	91.1	345.4 - 419.0	28.1	14.8 - 12.3
240	192	144	104.1	395.0 - 479.0	32.1	14.8 - 12.3
261	209	157	113.2	429.7 - 521.0	34.9	14.8 - 12.3
270	216	162	117.1	444.6 - 539.0	36.1	14.8 - 12.3
300	240	180	130.1	494.2 - 599.0	40.1	14.8 - 12.3
350	280	210	151.8	576.8 - 699.0	46.8	14.7 - 12.3
400	320	240	173.5	659.4 - 799.0	53.5	14.7 - 12.3
450	360	270	195.2	742.0 - 899.0	60.2	14.7 - 12.2
500	400	300	216.9	824.7 - 999.0	66.9	14.7 - 12.2

Screen Size			B mm	C Wide – Tele mm	D mm	α Wide – Tele degree
Diagonal mm	Width mm	Height mm				
762	610	457	331	1219 - 1498	102	15.2 - 12.4
1016	813	610	441	1639 - 2006	136	15.1 - 12.4
1524	1219	914	661	2478 - 3022	204	14.9 - 12.3
1702	1361	1021	738	2772 - 3378	228	14.9 - 12.3
1829	1463	1097	793	2982 - 3632	245	14.9 - 12.3
2032	1626	1219	882	3318 - 4038	272	14.9 - 12.3
2134	1707	1280	926	3485 - 4242	286	14.9 - 12.3
2286	1829	1372	992	3737 - 4546	306	14.9 - 12.3
2540	2032	1524	1102	4157 - 5054	340	14.8 - 12.3
3048	2438	1829	1322	4996 - 6070	408	14.8 - 12.3
3810	3048	2286	1653	6256 - 7595	510	14.8 - 12.3
4572	3658	2743	1983	7515 - 9119	612	14.8 - 12.3
5080	4064	3048	2203	8354 - 10135	679	14.8 - 12.3
5334	4267	3200	2314	8774 - 10643	713	14.8 - 12.3
6096	4877	3658	2644	10033 - 12167	815	14.8 - 12.3
6629	5304	3978	2875	10915 - 13234	887	14.8 - 12.3
6858	5486	4115	2975	11292 - 13691	917	14.8 - 12.3
7620	6096	4572	3305	12552 - 15215	1019	14.8 - 12.3
8890	7112	5334	3856	14650 - 17755	1189	14.7 - 12.3
10160	8128	6096	4407	16749 - 20295	1359	14.7 - 12.3
11430	9144	6858	4958	18848 - 22835	1529	14.7 - 12.2
12700	10160	7620	5508	20946 - 25375	1698	14.7 - 12.2

WARNING

- * Installing your projector on the ceiling must be done by a qualified technician. Contact your NEC dealer for more information.
- * Do not attempt to install the projector yourself.
- Only use your projector on a solid, level surface. If the projector falls to the ground, you can be injured and the projector severely damaged.
- Do not use the projector where temperatures vary greatly. The projector must be used at temperatures between 41°F (5°C) and 95°F (35°C).
- Do not expose the projector to moisture, dust, or smoke. This will harm the screen image.
- Ensure that you have adequate ventilation around your projector so heat can dissipate. Do not cover the vents on the side or the front of the projector.

Reflecting the Image

Using a mirror to reflect your projector's image enables you to enjoy a much larger image. Contact your NEC dealer if you need a mirror. If you're using a mirror and your image is inverted, use the MENU and SELECT buttons on your projector cabinet or ▲▼ buttons on your remote control to correct the orientation. (See page E-95.)

Making Connections

Wiring Diagram

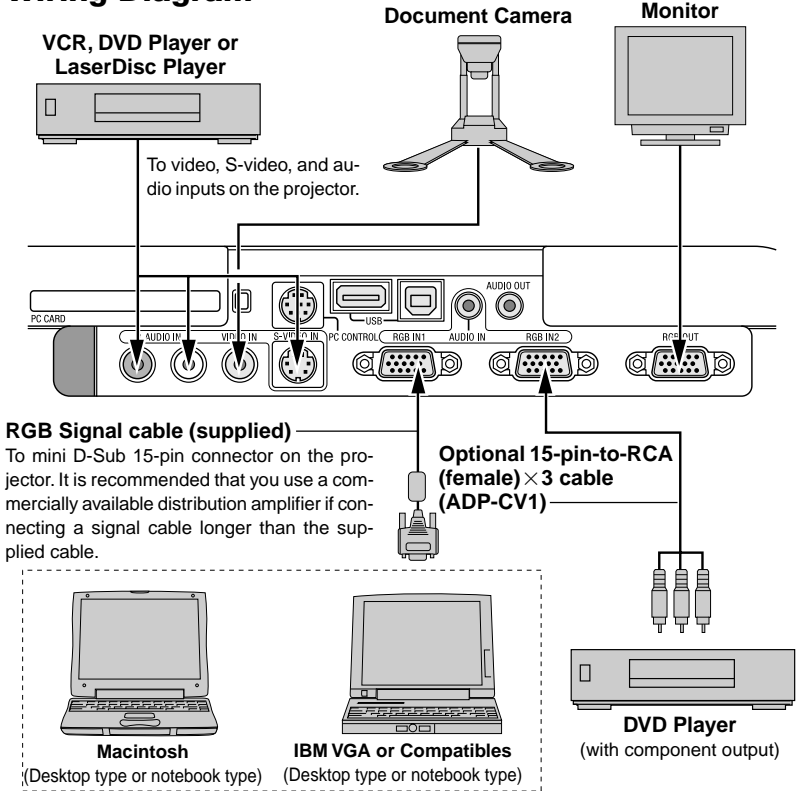

NOTE: When using with a notebook PC, be sure to connect between the projector and the notebook PC before turning on the power to the notebook PC. In most cases signal cannot be output from RGB output unless the notebook PC is turned on after connecting with the projector.

- * *If the screen goes blank while using your remote control, it may be the result of the computer's screen-saver or power management software.*
- * *If you accidentally hit the POWER button on the remote control, wait 90 seconds and then press the POWER button again to resume.*

To connect SCART output (RGB)

Before connections: An exclusive SCART adapter (ADP-SC1) and a commercially available SCART cable are required for this connection.

NOTE:

- *Audio signal is not available for this connection.*
 - *The RGB IN 2 connector does not support SCART signal and Plug & Play.*
-

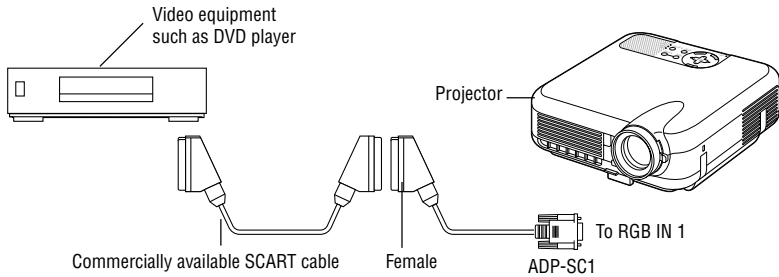

- 1. Turn off the power to the projector and your video equipment.**
- 2. Use the NEC ADP-SC1 SCART adapter and a commercially available SCART cable to connect the RGB 1 input of your projector and a SCART output (RGB) of your video equipment.**
- 3. Turn on the power to the projector and your video equipment.**
- 4. Use the RGB 1 button on the remote control to select the RGB 1 input.**
- 5. Press the MENU button on the remote control to display the menu.**
- 6. From the Advanced menu, select [Projector Options] → [Setup] → [Page 3] → [Signal Select RGB1] → [Scart].**

SCART is a standard European audio-visual connector for TVs, VCRs and DVD players. It is also referred to as Euro-connector.

NOTE: The ADP-SC1 SCART adapter is obtainable from your NEC dealer in Europe. Contact your NEC dealer in Europe for more information.

Connecting Your PC or Macintosh Computer

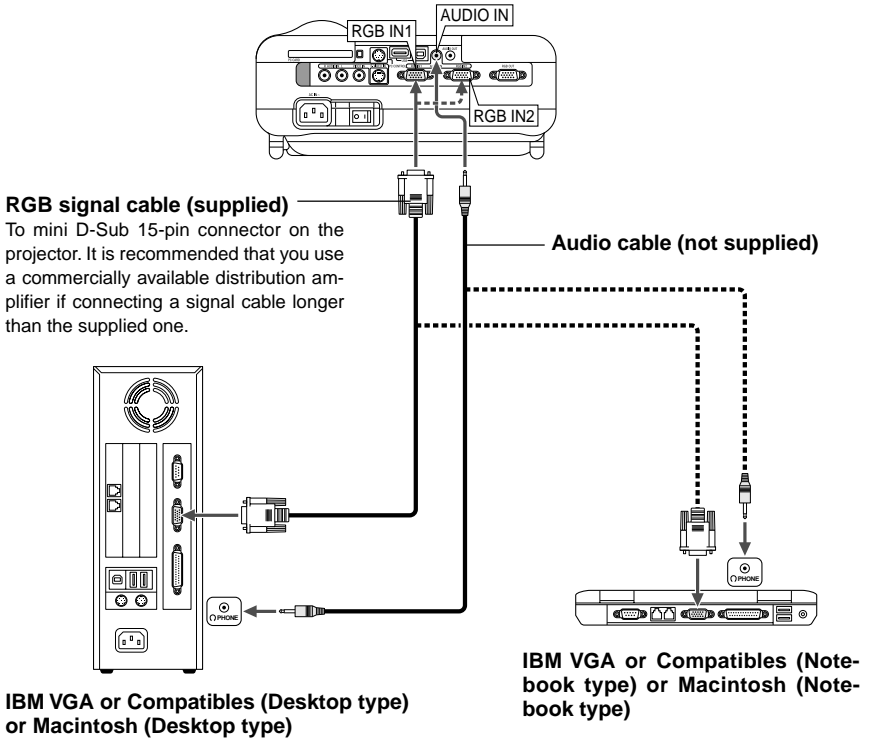

NOTE: For older Macintosh, use a commercially available pin adapter (not supplied) to connect to your Mac's video port.

INSTALLATION AND CONNECTIONS > Making Connections

Connecting your PC or Macintosh computer to your projector will enable you to project your computer's screen image for an impressive presentation.

To connect to a PC or Macintosh, simply:

- 1. Turn off the power to your projector and computer.**
- 2. Use the supplied signal cable to connect your PC or Macintosh to the projector.**
- 3. Turn on the projector and the computer.**
- 4. If the projector goes blank after a period of inactivity, it may be caused by a screen saver installed on the computer you've connected to the projector.**

NOTE: The LT260/LT240/LT220 is not compatible with video decoded outputs of NEC ISS-6020 and ISS-6010.

Connecting an External Monitor

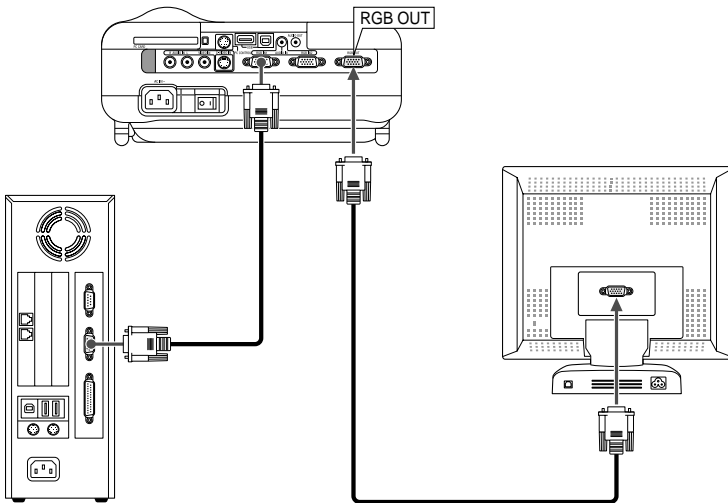

You can connect a separate, external monitor to your projector to simultaneously view on a monitor the RGB analog image you're projecting. To do so:

- 1. Turn off the power to your projector, monitor and computer.**
- 2. Use a 15-pin cable to connect your monitor to the RGB OUT (Mini D-Sub 15 pin) connector on your projector.**
- 3. Turn on the projector, monitor and the computer.**

NOTE: The RGB OUT connector outputs RGB signal during idle mode (See page E-100). When the projector goes into idle mode, the image on an external monitor disappears for a moment. Note that the RGB OUT connector will not output RGB signal during Standby mode.

- *Daisy chain connection is not possible.*
-

Connecting Your Video Equipment

Connecting Your DVD Player

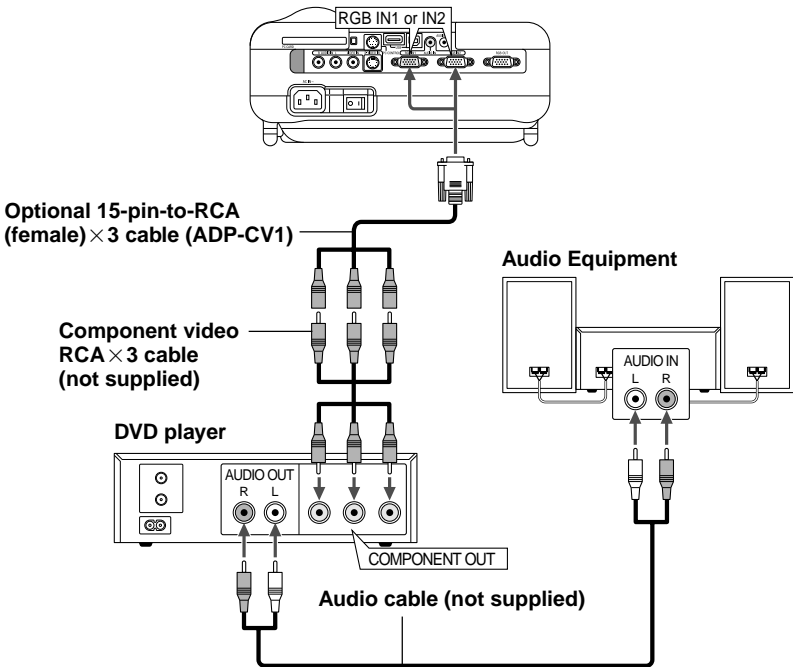

You can connect your projector to a DVD player with component output or Video output. To do so, simply:

1. Turn off the power to your projector and DVD player.
2. If your DVD player has the component video (Y,Cb,Cr) output, use a commercially available component video cable (RCA × 3) and the optional 15-pin-to-RCA (female) × 3 cable to connect your DVD player to the RGB IN1 or IN2 connector on the projector.

For a DVD player without component video (Y,Cb,Cr) output, use common RCA cables (not provided) to connect a composite VIDEO output of the DVD player to the Video Input of the projector.

3. Turn on the projector and DVD player.

NOTE: Refer to your DVD player's owner's manual for more information about your DVD player's video output requirements,

Connecting Your VCR or Laser Disc Player

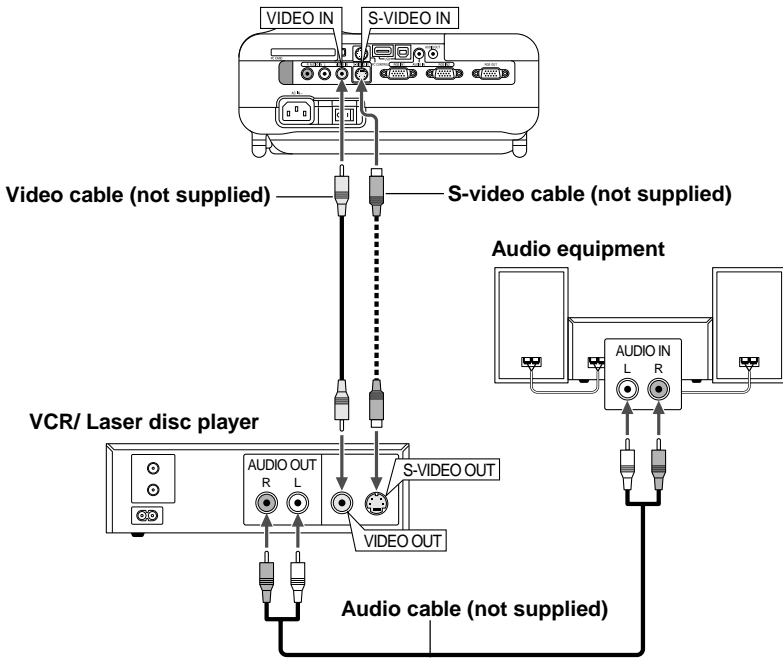

Use common RCA cables (not provided) to connect your VCR, laser disc player or document camera to your projector.

To make these connections, simply:

- 1. Turn off the power to the projector and VCR, laser disc player or document camera.**
- 2. Connect one end of your RCA cable to the video output connector on the back of your VCR or laser disc player, connect the other end to the Video input on your projector. Use an audio cable (not supplied) to connect the audio from your VCR or laser disc player to your audio equipment (if your VCR or laser disc player has this capability). Be careful to keep your right and left channel connections correct for stereo sound.**

3. Turn on the projector and the VCR or laser disc player.

NOTE: Refer to your VCR or laser disc player owner's manual for more information about your equipment's video output requirements.

NOTE: An image may not be displayed correctly when a Video or S-Video source is played back in fast-forward or fast-rewind via a scan converter.

Connecting the Supplied Power Cable

Connect the supplied power cable to the projector.

First connect the supplied power cable's three-pin plug to the AC IN of the projector, and then connect the other plug of the supplied power cable in the wall outlet.

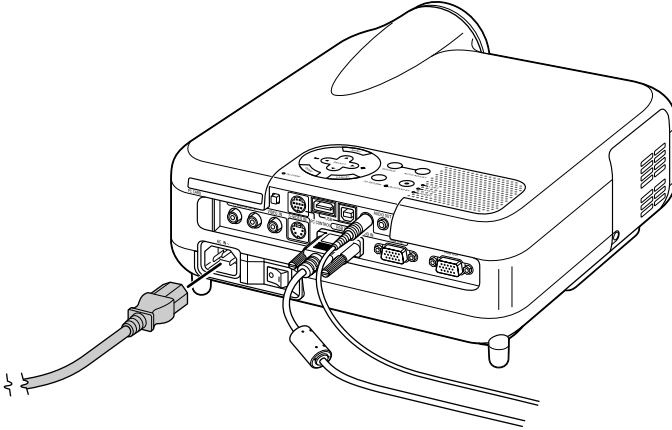

PROJECTING AN IMAGE

(BASIC OPERATION)

This section describes how to turn on the projector and to project a picture onto the screen.

Turning on the Projector

NOTE:

- When plugging in or unplugging the supplied power cable, make sure that the main power switch is pushed to the off[O] position. Failure to do so may cause damage to the projector.
 - The projector has two power switches: main power switch and POWER button (POWER ON and OFF on the remote control)
 - The projector has a feature to prevent itself from being used by unauthorized individuals. To use this feature, register your PC card as a protect key. See "Security" in "Projector Options" on page E-111 for more details.
-

To turn on the main power to the projector, press the Main Power switch to the ON position (I).

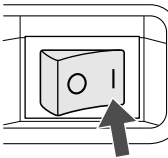

Before you turn on your projector, ensure that the computer or video source is turned on and that your lens cap is removed.

Only after you press the ON/STAND BY button on the projector cabinet or POWER ON button on the remote control for a minimum of 2 seconds will the power indicator turn to green and the projector become ready to use.

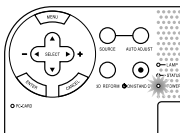

Note on Startup screen (Menu Language Select screen)

When you first turn on the projector, you will get the Startup screen. This screen gives you the opportunity to select one of the seven menu languages: English, German, French, Italian, Spanish, Swedish and Japanese.

To select a menu language, follow these steps:

- 1. Use the SELECT ▲ or ▼ button to select one of the seven languages for the menu.**

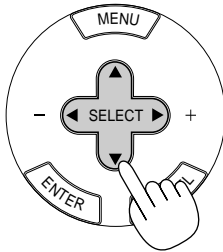

- 2. Press the ENTER button to execute the selection.**

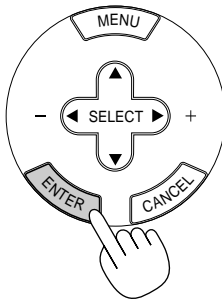

3. The Basic menu will be displayed in the language you have selected.

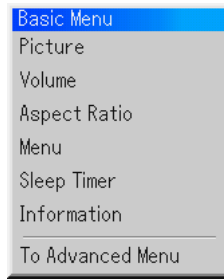
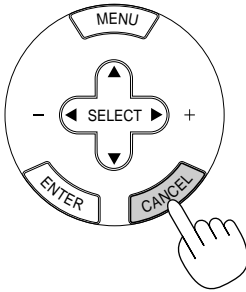

To close the menu, press the CANCEL button.

After this has been done, you can proceed to the advanced menu operation.

If you want, you can select the menu language later. See "Language" on page E-93.

NOTE: To turn the projector on by plugging in the power cable, first turn on the Main Power switch to ON and use the menu and enable the "Auto Start" feature. (See page E-99.)

Immediately after turning on the projector, screen flicker may occur. This is not a fault. Wait 3 to 5 minutes until the lamp lighting is stabilized.

When the Lamp mode is set to Eco, the Lamp indicator will light green.

If one of the following things happens, the projector will not turn on.

- * If the internal temperature of the projector is too high, the projector detects abnormal high temperature. In this condition the projector will not turn on to protect the internal system. If this happens, wait for the projector's internal components to cool down.
- * When the lamp reaches its end of usable life, the projector will not turn on. If this happens, replace the lamp.
- * If the lamp fails to light, and if the STATUS indicator flashes on and off in a cycle of six times, wait a full minute and then turn on the power.

Selecting a Source

Selecting the computer or video source

Using the Remote Control

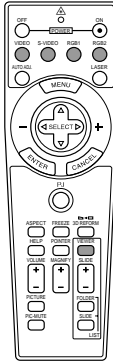

Press any one of the RGB1, RGB2, VIDEO, S-VIDEO or VIEWER buttons.

NOTE: If no input signal is available, the projector will display a blue background (factory preset).

Selecting from Source List

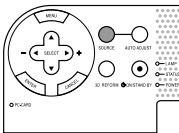

Source List



Press and quickly release the SOURCE button on the projector cabinet to display the Source list. Each time the SOURCE button is pressed, the input source will change as follows: "Video" (VCR, document camera, or laser disc player), S-Video, "RGB1" or "RGB2" (computer or DVD with component output), "Viewer" (slides on a PC card), or "LAN" (wired or wireless signal aired from a PC).

To display the selected source, press the SOURCE button a few times to select the signal you wish to project.

Adjusting the Picture Size and Position

Place your projector on a flat level surface and ensure that the projector is square to the screen.

Lift the front edge of the projector to center the image vertically.

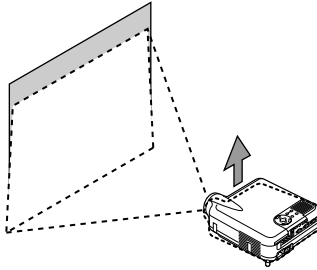

Move the projector left to center the image horizontally on the screen.

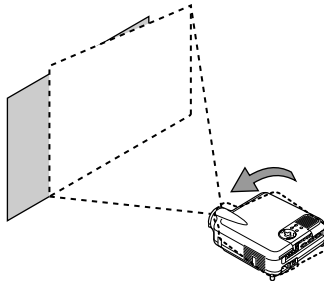

Use the 3D REFORM feature for proper adjustment. See page E-45.

Adjust the Tilt Foot

- ① **Lift the front edge of the projector.**

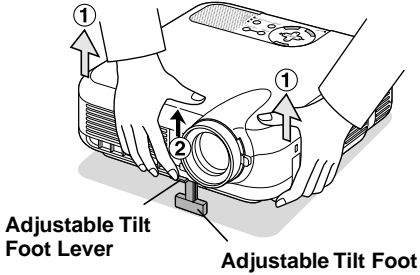

- ② **Push up the Adjustable Tilt Foot Lever on the front of the projector to extend the adjustable tilt foot (maximum height).**
- ③ **Push down the Adjustable Tilt Foot Lever.**

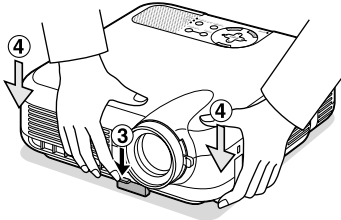

- ④ **Lower the front of the projector to the desired height and release the Adjustable Tilt Foot Lever to lock the Adjustable tilt foot. There is approximately 7 degrees of up and down adjustment for the front of the projector.**

PROJECTING AN IMAGE > Adjusting the Picture Size and Position

The rear foot height can be changed. Rotate the rear foot to the desired height, but the vertical distance from the bottom to the desk or floor should be 1" (25 mm) to make the projector horizontal on the flat surface.

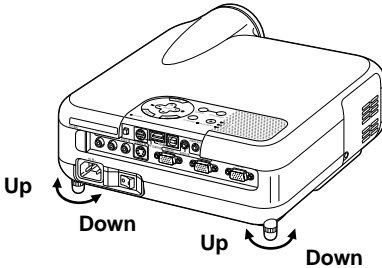

* If the projected image does not appear square to the screen then use the 3D Reform feature for proper adjustment. See page E-45.

CAUTION:

Do not use the tilt-foot for purposes other than originally intended. Mis-uses such as gripping the tilt-foot or hanging on the wall can cause damage to the projector.

Zoom

Use the Zoom lever to fine adjust the image size on the screen

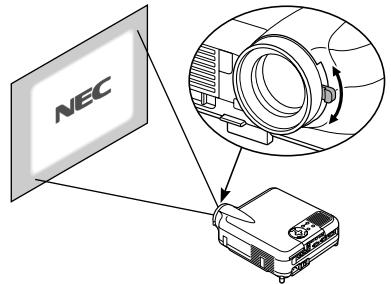

Focus

Use the Focus ring to obtain the best focus.

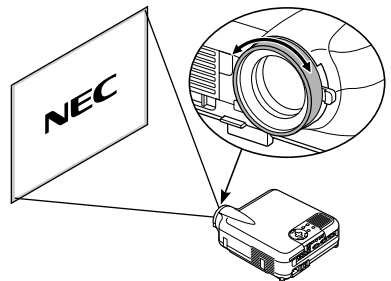

Correcting the Horizontal and Vertical Keystone Distortion (3D Reform)

Use the 3D Reform feature to correct keystone (trapezoidal) distortion to make the top or bottom and the left or right side of the screen longer or shorter so that the projected image is rectangular.

You can also use a mouse to correct the Cornerstone distortion. To do so with your mouse, pick and left-click on one corner of the image you want to correct.

Do this for the remaining 3 corners. Right-click to display the confirmation screen.

- 1. Project an image so that the screen is smaller than the area of the raster.**
- 2. Pick up any one of the corners and align the corner of the screen with the one of the image.**

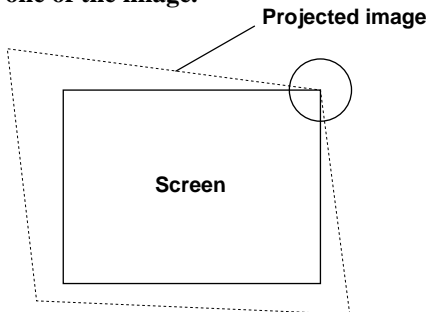

(The drawing shows the upper right corner.)

- 3. Press the 3D REFORM button on the remote control.**



The CORNERSTONE adjustment screen is displayed.

NOTE: Press the 3D REFORM button to toggle between "Cornerstone" and "Keystone."

PROJECTING AN IMAGE

4. Use the SELECT ▲▼◀▶ button to select one icon which points in the direction you wish to move the projected image frame.

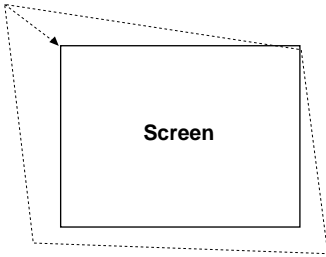

5. Press the ENTER button.
6. Use the SELECT ▲▼◀▶ button to move the projected image frame as shown on the example.
7. Press the ENTER button.

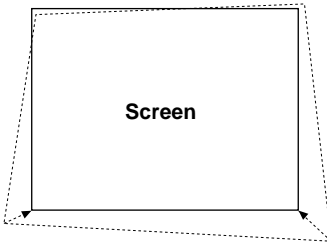

8. Use the SELECT ▲▼◀▶ button to select another icon which points in the direction.

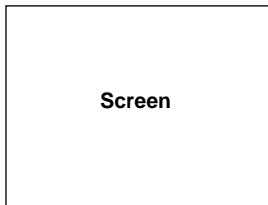

On the Cornerstone adjustment screen, select "Exit" and then "OK", or press the CANCEL button on the remote control.

The confirmation screen is displayed.

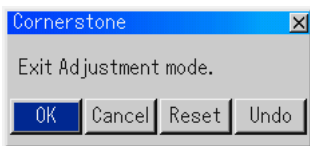

PROJECTING AN IMAGE

9. Press the SELECT ◀ or ▶ button to highlight the [OK] and press the ENTER button.

This completes the keystone correction.

Selecting "Cancel" will return to the adjustment screen without saving changes (Step 3).

Selecting "Reset" will return to the factory default.

Selecting "Undo" will exit without saving changes.

NOTE: To return the 3D Reform correction setting values to the factory default, press and hold the 3D REFORM button for a minimum of 2 seconds.

NOTE: During 3D Reform adjustment, "Aspect Ratio" and "Screen" may not be available. Should this happen, first reset the 3D Reform data and then do each setting. Second repeat the 3D Reform adjustment. Changing Aspect Ratio and/or Screen setting can limit 3D Reform in its adjustable range.

The adjustable ranges for 3D Reform are as follows:

Horizontal Max $\pm 30^\circ$ approx. (Max $\pm 25^\circ$ approx. on LT240)

Vertical Max $\pm 40^\circ$ approx.

- * The following are conditions at the above maximum angle when all of the following are met
 - Image is projected in Wide (Zoom)
 - Resolution is XGA
 - Higher resolution than XGA limits 3D Reform in its adjustable range.
 - Menu items should be set as follows:
 - Aspect Ratio 4:3
 - Screen Type 4:3
 - Screen Position 0
 - Horizontal and Vertical are adjusted separately.
 - A combination of both adjustments limits 3D Reform in its adjustable range.

Optimizing RGB Picture Automatically

Adjusting the Image Using Auto Adjust

Optimizing RGB image automatically

Press the Auto Adjust button to optimize an RGB image automatically.

[Poor picture]

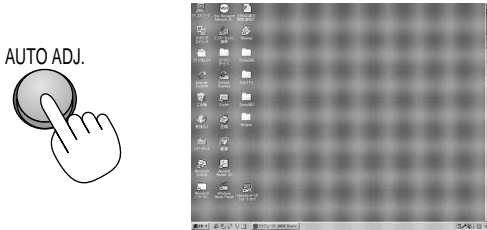

[Normal picture]

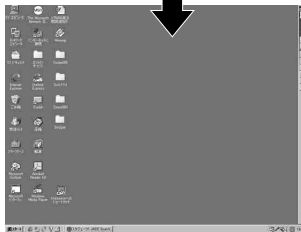

Press the Auto Adjust button to fine-tune the computer image or to remove any vertical banding that might appear and to reduce video noise, dot interference or cross talk (this is evident when part of your image appears to be shimmering). This function adjusts the clock frequencies that eliminate the horizontal banding in the image. This function also adjusts the clock phase to reduce video noise, dot interference or cross talk. (This is evident when part of your image appears to be shimmering.)

This adjustment may be necessary when you connect your computer for the first time.

NOTE:

- Some signals may not be displayed correctly or take time.
 - The Auto Adjust function does not work for component and video signal.
 - If the Auto Adjust operation cannot optimize the RGB signal, try to adjust Clock and Phase manually. See page E-88.
-

Turning Up or Down Volume

Sound level from the speaker and the AUDIO OUT mini jack on the projector can be adjusted.

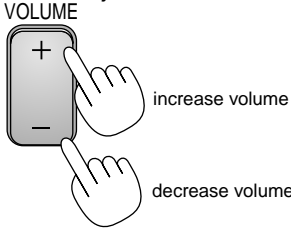

Using the Laser Pointer

You can use the laser to draw your audience's attention to a red dot that you can place on any object. Press and hold the LASER button to activate the laser pointer.

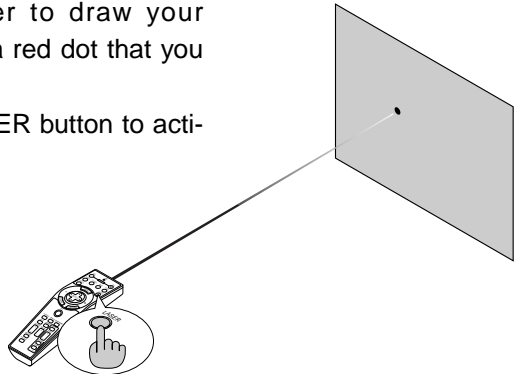

 **CAUTION:**

- Do not look into the laser pointer while it is on.
- Do not point the laser beam at a person.

Setting the function switch

There are two switches on the bottom of the battery case: an applicable projector selector switch (1) and laser enable/disable switch (2). Check the projector being used and decide whether to enable or disable laser, then set these switches as necessary using the tip of a thin ball-point pen. On this model, an applicable projector selector switch (1) is not used.

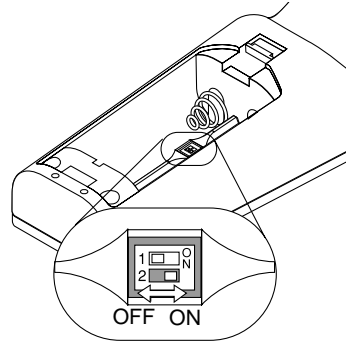

Switch (2)

- On: Enabled (the laser lights when the LASER button is pressed)
[Factory default]
- Off: Disabled (the laser does not light even when the LASER button is pressed)

Disable the laser when using in an environment in which the unit is accessible to children.

Turning off the Projector

To turn off the projector:

First press the POWER (ON/STAND BY) button on the projector cabinet or the POWER OFF button on the remote control for a minimum of two seconds. The power indicator will glow orange. After the projector turns off, the cooling fans keep operating for 90 seconds (Cooling-off time).

Second, turn off the Main Power switch. The power indicator will go out. Last unplug the power cable.



CAUTION

Do not unplug the power cable from the wall outlet or do not turn off the main power under any one of the following circumstances. Doing so can cause damage to the projector:

- While the Hour Glass icon appears.
- While the message "Please wait a moment." appears. This message will be displayed after the projector is turned off.
- While the cooling fans are running. (The cooling fans continue to work for 90 seconds after the projector is turned off).
- While accessing a PC card. (The PC Card Access indicator lights.)

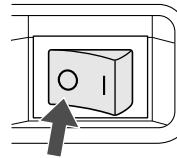

CONVENIENT FEATURES

Using the Remote Mouse Function

The built-in remote mouse function enables you to operate your computer's mouse functions from the remote control (Computer mode). It is a great convenience for clicking through your computer-generated presentations. To return to the projector operation mode (Projector mode), press the PJ button (lit red).

Connecting to your computer for the remote mouse function

If you wish to use the remote mouse function, use the supplied USB cable to connect the USB port (type B) of the projector and the USB port (type A) of your computer.

NOTE: Depending on the type of connection or OS installed on your computer, you may have to restart your computer or change your computer settings.

When using the USB Port

For PC, the mouse receiver function can only be used with a Windows 98, Windows ME, Windows XP or Windows 2000 operating system.

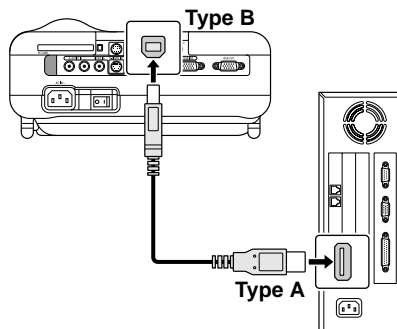

NOTE: Wait at least 5 seconds after disconnecting the USB cable before reconnecting it and vice versa. The computer may not identify the built-in mouse receiver if it is repeatedly connected and disconnected in rapid intervals.

Switching operation mode between computer and projector

The three shaded buttons shown on the drawing work as a computer mouse in the Computer mode.

In the Computer mode the PJ button is not lit.

Works as a mouse for your computer.

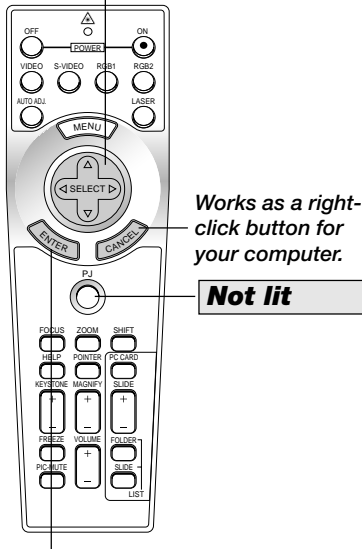

Works as a left-click button for your computer.

Works as the Select button on the projector.

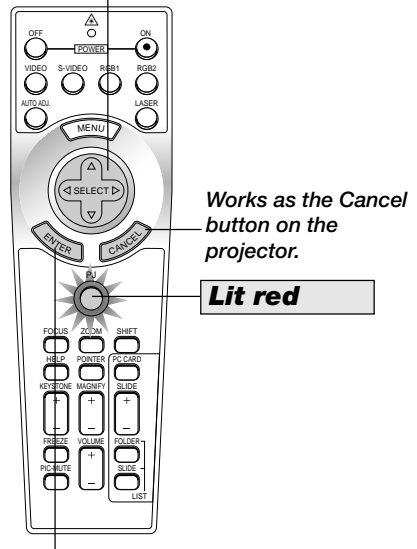

Works as the Enter button on the projector.

CONVENIENT FEATURES > Using the Remote Mouse Function

- When the MENU button is pressed, the PJ button lights red to indicate that you are in the Projector mode, which allows the projector menu operation using the three buttons.
- When the POINTER button is pressed, the PJ button lights red to indicate that you are in the Projector mode and that the SELECT ▲▼◀▶ button works as a moving button for the POINTER or magnified image.
- If no buttons are pressed within 60 seconds, the PJ button's light goes out to indicate that you are in the Computer mode. To enable the projector menu operation again, press the PJ button to light red. To move the pointer or a magnified image again, turn off the pointer and then turn on the pointer (press the POINTER button two times).
- When the PJ button is lit, if you want to use the mouse function immediately, press the PJ button to return to the Computer mode (not lit).

During Computer mode:

In Computer mode, by pressing the ENTER button for 2 seconds or more then releasing, the drag mode is set and the drag operation can be performed simply by pressing the SELECT ▲▼◀▶ (mouse) button. To cancel the drag mode, press the ENTER (left click) button again or press the CANCEL (right click) button.

CONVENIENT FEATURES

Turning Off the Image and Sound

Press the Picture Mute button to turn off the image and sound for a short period of time. Press again to restore the image and sound.

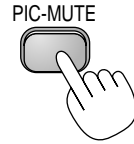

Freezing a Picture

Press the Freeze button to freeze a picture. Press again to resume motion.



Using the Pointer

You can use one of eight pointers to draw your audience's attention to the portion of a projected image you want.

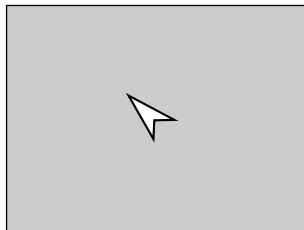

Press the Pointer button to display the pointer.

Press the Pointer button to display the pointer.

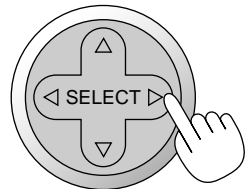
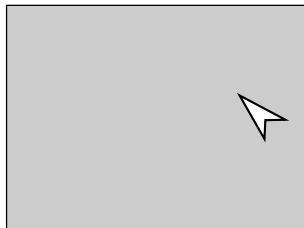

Use the Select button to move the pointer.

Use the Select button to move the pointer.

Enlarging and Moving a Picture

You can enlarge the area you want up to 400 percent.

To do so:

1. Press the Pointer button to display the pointer.

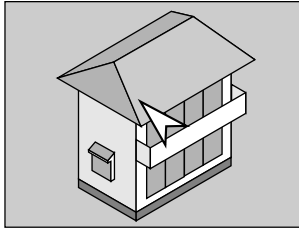

2. Move the pointer to the area you want to enlarge.

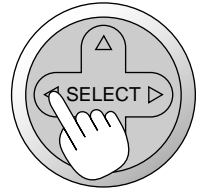
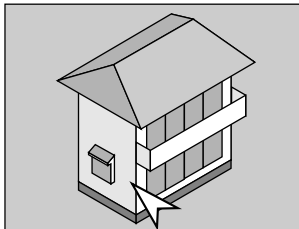

3. Enlarge the selected area.

When the Magnify (+) button is pressed, the pointer is changed to a magnifying glass. To move the magnifying glass, use the SELECT button.

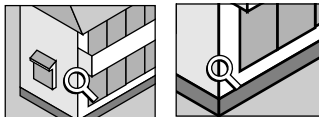

4. Return the image to the original size.

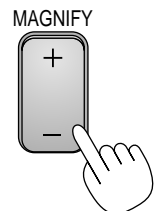
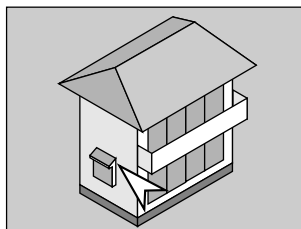

Getting the On-line Help

You get the contents about Help.



Display Help

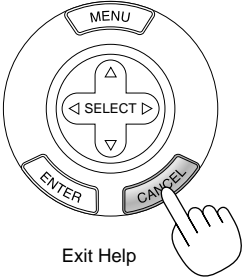

Exit Help

Using a USB Mouse

Using a USB mouse gives you a smooth operation. A commercially available USB mouse is required.

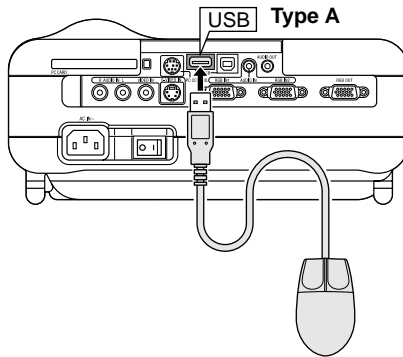

NOTE: There may be some brands of USB mouse that the projector does not support.

Operate the Menus using the USB mouse

Mouse Cursor

When connecting a USB mouse to the projector, you get a mouse cursor on the screen.

Unless you use your USB mouse within 10 seconds, the mouse cursor disappears.

Menu Display

Clicking with a mouse button displays the menu.

Clicking ► displays the pull-down menu. To close the menu, click anywhere in the background.

Adjusting and Setting Display

You can select a menu item and click with a mouse button to make adjustments and setting.

CONVENIENT FEATURES

Examples

Click (or press and hold) the mouse button ◀ or ▶ to adjust the brightness. Or click and drag the mouse button on the slide bar horizontally to adjust it.

To save the adjustments, click ✕. The display is closed. If you click anywhere in the background while displaying adjustment and setting menu or dialog box, you will get the main menu at the clicking point.

Changing Background Logo

You can change the default background logo using the PC Card Files feature.

NOTE: File size must be 256KB or less. Other file formats than JPEG and BMP are not available.

1. From the menu, select [Tools] → [PC Card Files] to display a list of all the files stored in the PC card so that you can select a file you want to use as a background logo.

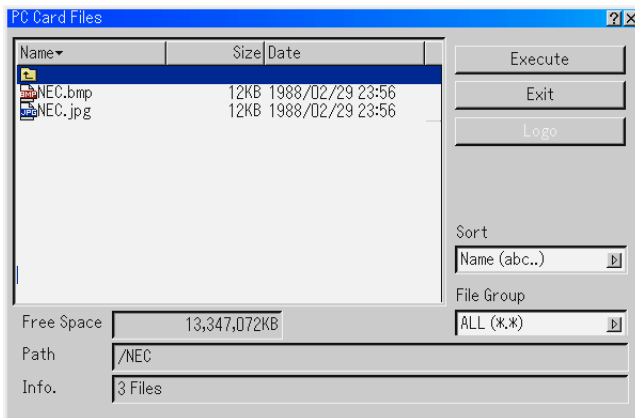

2. The Logo button allows you to select a background logo from graphic files on a PC card and change to it as the background logo.
3. Use the SELECT ▲ or ▼ button to select a JPEG or BMP file for your background logo.

CONVENIENT FEATURES > Changing Background Logo

- 4. Use the SELECT ► and then ▼ button to select "Logo".**
- 5. Press the ENTER on the remote control or the cabinet. You will get the confirmation dialog box.**
- 6. Select "OK" and press the ENTER button. This completes changing a logo for the background.**



- * Once you have changed the background from the NEC logo to another, you cannot return the logo to background even by using Factory Default. To do so, repeat the above steps. The NEC logo file is included on the supplied CD-ROM NEC Projector User Supportware (/Logo/nec_b_x.jpg). (LT220 : /Logo/nec_b_s2.jpg)

CONVENIENT FEATURES

Making Freehand Drawings on a Projected Image (ChalkBoard)

The ChalkBoard feature allows you to write and draw messages on a projected image.

NOTE: The ChalkBoard feature is available only when a USB mouse is used.

From the menu, select [Tools] → [ChalkBoard] to display the ChalkBoard tool bar that contains the following icons.

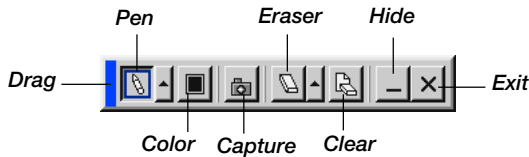

Drag Drags to move the tool bar by clicking on the blue part. (for USB mouse operation only)

Pen Left-click and drag to draw. Left-click [▲] or right-click the pen icon to display the pen palette containing four lines of different thickness from which you can select a line you prefer by left-clicking.

Color Selects a color. Left-click to display the color palette from which you can select a color you prefer by left-clicking.

Capture Left click to capture and save freehand drawings in the PC card.

Eraser ... Left-click and drag to erase part of a drawing. Left-click [▲] or right-click the eraser icon to display the eraser palette containing four eraser of different thickness from which you can select an eraser you prefer by left-clicking.

Clear Left-click to clear the drawing completely from the ChalkBoard screen.

Hide Hides the tool bar by left-clicking. Right-clicking anywhere on the screen displays the ChalkBoard tool bar again.

Exit Clears the complete drawing and exits the ChalkBoard.

NOTE:

- *The menu is not available while you display the ChalkBoard screen.*
 - *Switching slides clears a drawing completely.*
-

USING THE VIEWER

NOTE: To use the Viewer, first you need to create presentation materials on your PC using the Dynamic Image Utility 2.0 contained on the supplied NEC Projector User Supportware CD-ROM.

For installation, see the printed Application Guide. For creating presentation materials, see the Slide show function on the on-line manual of the Dynamic Image Utility 2.0.

Making the Most out of the Viewer Function

Features

You can view presentation data, capture, and play images on the projector. A PC card is used to view presentation data prepared on the computer and to capture and play images projected with the projector.

The Viewer feature allows you to view slides stored on a PC memory card (referred to as PC card in this manual) on the projector. Even if no computer is available, presentations can be conducted simply with the projector. This feature is convenient for holding presentations at meetings and in offices, as well as for playing images taken on digital cameras.

Easy to use

- Presentations can be started immediately simply by inserting a PC card (not supplied)
- Easy slide switching
- Remote control operation
- Jumping to list of slides or any specific slide

High quality images

- High resolution up to 1024 x 768 dots (800 x 600 on LT220)
- 24-bit full color playback
- Viewing of digital camera images

Simple utility software (for computer)

- Dynamic Image Utility 2.0 operable on Windows 95/98/Me/XP/NT4.0(SP3 or later)/2000
- Slides can be created by capturing the currently displayed image
- Control screen for displaying lists of slides and editing
- * Microsoft, Windows and PowerPoint are registered trademarks of Microsoft Corporation.

Inserting and Removing a PC Card

Inserting the PC Card

- Hold the PC card horizontally and insert it slowly into card slot with its top facing up.
- The eject button pops out once the PC card is fully inserted. Check that the PC card is fully inserted.

NOTE: Do not try to force the PC card into the slot.

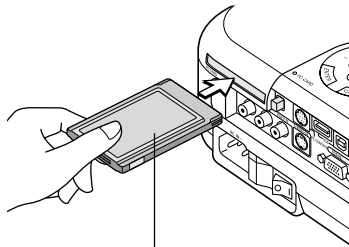

PC card (not supplied)

USING THE VIEWER

Removing the PC Card

Press the eject button. The PC card pops out a little. Grasp the edges of the PC card and pull it out.

NOTE: Do not eject the PC card while its data is being accessed.

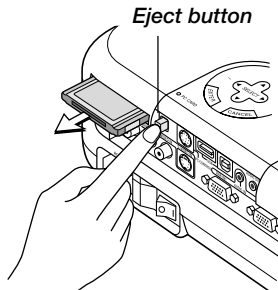

Direction for Inserting the PC Card

The PC card has a top and bottom and must be inserted into the PC card slot in a specific direction. It cannot be inserted backwards or upside-down. Attempting to force it into the slot in the wrong direction may break the internal pin and damage the card slot. Refer to the PC card's operating instructions for the proper direction of insertion.

PC Card Type

The PC Card slot accepts PCMCIA Type II only.

Operating the Viewer Function from the Projector (playback)

This section describes the operation for showing slides of presentation documents created using the Viewer function with the projector. It is also possible to make slides directly from the images projected with the projector.

Projecting slides (Viewer)

1. Insert a PC card into the PC card slot.

Insert the PC card with the side with the insertion direction arrow on the top.

- * Press the eject button to eject the card.

2. Select the "Viewer" from the Source Select menu.

3. Project slides.

Checking "**Show Folder List**", means that selecting Viewer input displays a list of the folders in the PC card and if "**Auto Play**" is checked the projector automatically starts to play slides at the first slide of the folder you have selected.

A tool bar will appear when you press the MENU button on the remote control or the projector cabinet or clicking with the right button of a mouse.

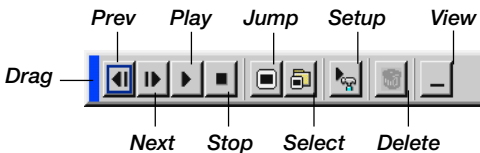

The tool bar includes the following buttons:

Drag Drags to move the tool bar. This is available for USB mouse operation only.

Prev Returns to the previous slide or folder. Or this lets you play slides back in reverse.

Next Advances to the next slide or folder. Or this lets you play slides back.

USING THE VIEWER

- Play Plays back automatically or manually depending on the setting on Viewer Options of the menu. This allows you to move on to the next slide when "Manual Play" is selected.
- Stop This allows you to stop Auto Play while you are playing back and to resume playing from the selected slide or folder when "Auto Play" is selected.
- Jump Displays a list of slides while you are playing back.
- Select Displays a list of folders while you are playing back.
- Setup Displays the Viewer Options dialog box on Page 2 of the Setup dialog box.
- Delete Deletes a captured slide(s) or all the captured slides in the Capture - specific folder.
- View Hides the tool bar while you are playing back. Pressing the MENU button or clicking with the right button of a mouse shows it again.

NOTE: If no memory card is inserted in the PC CARD slot, there is no signal, and a black, blue or logo background is displayed, depending on the setting. Playback is stopped when SLIDE +/- button on the remote control or ◀▶ button on the cabinet is pressed in Auto Play mode.

Up to 12 indexes can be displayed on the list of folders. The folder in the right bottom is always a folder exclusively for captured images, but is only displayed when images have been captured.

When the tool bar is not displayed:

Press the FOLDER LIST button or the SLIDE LIST button on the remote control to display folders or from a PC card in the projector's PC Card slot.

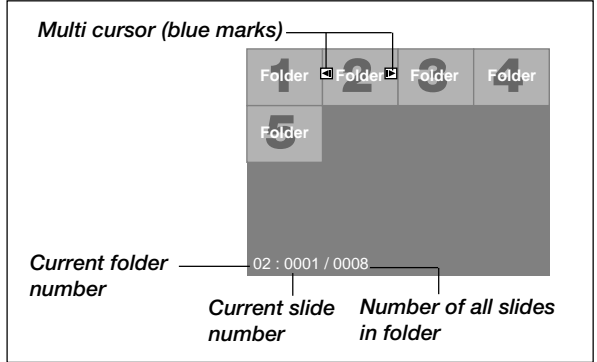

Use the SLIDE +/- button to advance to the next folder or return to the previous folder.



Use the SLIDE +/- button to advance to the next slide or return to the previous slide.

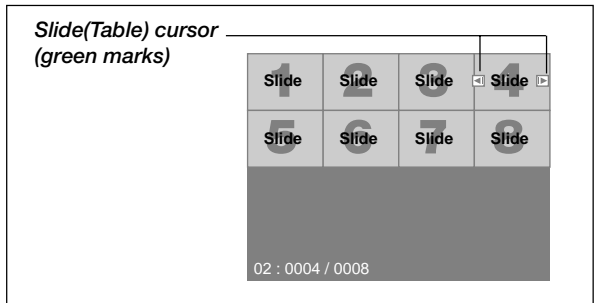

USING THE VIEWER

NOTE: You can also use the ◀ and ▶ button on the remote control to select folders or slides.

If you use the ◀ and ▶ button on the remote control for Viewer operation, press the PJ button to switch to the Projector mode and the PJ button lights red.

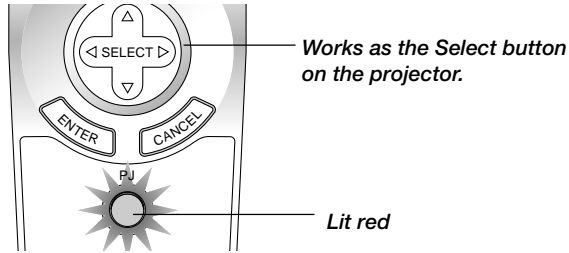

Auto Play Mode

If the "Auto Play" option is selected in "Viewer Options" of the menu, any given slide will start to play automatically.

You can also specify Auto Play Interval between 5 and 300 seconds.

Switching to Slides Directly from Other Input Modes

With this function it is possible to switch directly to a slide when the picture of a VCR or computer is being projected.

Example: When conducting presentations using a combination of slides and moving pictures from a VCR, etc., it is possible to switch from a Viewer slide to the video picture then back to the Viewer slide simply by using the Viewer button.

NOTE: Even if you switch the current Viewer source to another source, the current slide is retained. When you return back to the Viewer, you will get the slide that has been retained.

The PC card editing operation cannot be performed from the projector. Do so using the Dynamic Image Utility 2.0 software.

Viewing Digital Images

Digital images can be played with the Viewer if the following conditions are met:

- If the image can be stored on an MS-DOS format PC card
- If the image can be stored in a format supported by the Viewer. With the Viewer, images on the card are searched for in directories and images in JPEG or BMP format are recognized as slides. Searchable directories are directories within two steps from the root directory, and searchable images are images within the first 12 files in the directory. Only file and slide switching are possible.

NOTE: The maximum number of images recognized as slides within one directory is 128.

Storing Images Displayed on the Projector on the PC card (Capture)

The Capture features allows you to capture an image from a source that is currently being displayed. The image is saved as JPEG in the PC card. When you select Capture from the menu, you will get a tool bar. You can capture an image directly using the tool bar when the menu is not displayed.

The tool bar includes the following buttons:



- Drag Drags to move the tool bar by clicking on the blue part.
(for USB mouse operation only)
- Capture Captures an image and saves it as a JPEG file on a PC card.
- Freeze Freezes and unfreezes images.
- Exit Exits the Capture function.

USING THE VIEWER

NOTE:

- * Unless a PC card is inserted into the PC Card slot of the projector, the Capture feature is not available.
 - * The "Card Error" display means that the free space of the PC card is insufficient for saving images. Make more space available on the card by erasing unwanted images with your PC. The number of images that can be captured depends on the size of the PC card.
 - * Be sure not to turn off the power or remove the PC card while capturing an image. Doing so could cause a loss of the data in the PC card or damage to the card itself.
-

Preparations:

Insert the PC card into the card slot.

Insert the PC card so that the end with the insertion direction arrow on the top goes in first.

- * Press the eject button to eject the card.

1. Project the image you wish to store on the projector.

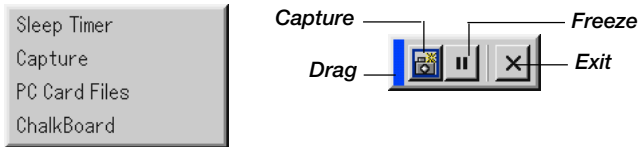

2. Select the "Capture" from the Tools menu.

3. A tool bar will appear.

The tool bar includes the following buttons:

Drag Drags to move the tool bar by clicking on the blue part (for USB mouse operation only).

Capture Captures an image and save it as a JPEG file in a PC card.

Freeze Freezes and unfreezes images.

USING THE VIEWER

Exit Exits the Capture function. Another option to exit the Capture function is to press MENU or CANCEL button on the remote control or projector cabinet.

NOTE:

You can compress a captured file (JPEG) using the Capture Options in the Setup dialog. See page E-97.

Captured images with higher resolution than the projector's native resolution cannot be displayed correctly.

- *File size of the captured image varies depending on the resolution of an input signal.*
 - *An hourglass indicating that an image is being captured appears on the projector's display. Do not eject the PC card or turn off the projector's power while this icon is displayed. Doing so will damage the PC card data. If the PC card data is damaged, use a computer to repair the data.*
 - *Up to 12 indexes can be displayed on the list of folders. The folder in the right bottom is always a folder exclusively for captured images, but is only displayed when images have been captured.*
-

Deleting Captured Images

Using the Delete button on the tool bar for Viewer can delete captured images.

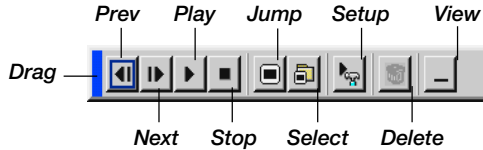

To delete captured images:

1. **Select Viewer and display a folder list of captured images.**
2. Use **▶** button to select the Capture folder [Cap] in the right bottom of the screen.
3. **Press the MENU button to display the tool bar.**
4. **Use the ◀ or ▶ button to select the Delete icon and press the ENTER button or click with a mouse button.**

Using the PC Card Files Function (PC Card Files)

The PC Card Files function allows you to display a list of all the files stored in the PC card so that you can select a file you want to display. You can also sort files by file name or date, or display the file. Although a list of all the files in the PC card is displayed, you can view files in idx, text, HTML, JPEG and BMP format only. Selecting BMP and JPEG files automatically switches to the Viewer source. See also page E-81.

NOTE: This option is not available for selection unless a PC card is inserted properly.

Selecting "Execute" displays the file you selected.

When you select a JPEG or BMP file and press the Enter button on the remote or the cabinet, or "Execute" on the above, you will get a toolbar. This toolbar is used to return to the PC Card Files screen.

- Drag Drags to move the tool bar. (for USB mouse operation only)
- Return Returns to the PC Card Files screen.
- Close Close the toolbar.

USING ON-SCREEN MENU

Basic Menu Operation

Using the Menus

NOTE: The on-screen menu may not be displayed correctly while interlaced motion video image is projected.

1. Press the **MENU** button on the remote control or projector cabinet to display the Basic, Advanced or Custom Menu.

NOTE: When using a USB mouse, click the mouse button to display the menu. For other operations, do the same way as you use your PC mouse.

2. Press the **SELECT ▲▼** buttons on the remote control or the projector cabinet to highlight the menu for the item you want to adjust or set.
3. Press the **SELECT ►** button or the **ENTER** button on the remote control or the projector cabinet to select a submenu or item.
4. Adjust the level or turn the selected item on or off by using **SELECT ◀** or **▶** buttons on the remote control or the projector cabinet.

The on-screen slide bar will show you the amount of increase or decrease.

5. Changes are stored until you adjust it again.

ENTER Stores the setting or adjustments.

CANCEL Return to the previous screen without storing settings or adjustments.

NOTE: You can close the main and sub menus simultaneously by pressing the PJ button on the remote control to cancel the Projector mode.

6. Repeat steps 2-5 to adjust an additional item, or press the **CANCEL** button on the projector cabinet or the remote control to quit the menu display.

Customizing the Menu

The Custom menu can be customized to meet your requirements. Selecting a menu item from the "Custom Menu Edit" list, allows you to custom tailor the menu items to your needs.

- 1. Select "Custom Menu Edit" to display the "Custom Menu Edit" screen.**
- 2. Use the SELECT ▲ or ▼ buttons to highlight your selection and press the Enter button to place a check mark next to an option.**

This action enables that feature. Press the Enter button again to clear the check box.

If you select an item with a solid triangle ► and press the Enter button on the remote control or the projector cabinet, you can enable all the items within that submenu. Also you can turn on an item within the submenu without placing a check mark on the main menu item.

NOTE: Up to 12 main menu items (within Custom Menu Edit, not including submenu items) can be selected.

- 3. In order for the changes to take effect, use the SELECT ◀ or ▶ button on the remote control or the projector cabinet to highlight "OK", then press the Enter button. To cancel the changes, use the SELECT ▲ or ▼ buttons to highlight "Cancel" and press the ENTER button.**

To return to the factory default, select "Reset" then press the ENTER button.

The default Custom Menu items are:

Source Select (RGB 1/2, Video, S-Video, Viewer and LAN), Picture, Volume, Image Options (Aspect Ratio), Picture Management, Projector Options (3D Reform, Menu, Setup, Screen and LAN Mode), Tools (Sleep Timer, Capture, PC Card Files and ChalkBoard) and Help (Contents and Information).

NOTE: Once you have selected OK on the Custom Menu Edit screen, you cannot cancel the changes on the Menu screen. However, you can reedit the menu items over again as described in the steps above.

USING ON-SCREEN MENU > Basic Menu Operation

NOTE: If the "Advanced Menu" item has been selected on the Menu mode, you get the "Confirmation Change Menu" upon completion of "Custom Menu" editing. In this case, selecting "Yes" then "Enter" will close all the menus and apply the changes from the Advanced menu to the Custom Menu. If you select "No" then "Enter" functions, then all menu items will return to the Advanced menu, but your changes will still be available within the "Custom Menu" selection. To display the previously tailored Custom Menu, select "Custom Menu" from the "Menu Mode".

An item "To Advanced Menu" will be added to the bottom of the Custom Menu.

Selecting this item and pressing the ENTER button will display the "Advanced Menu" features.

Menu tree

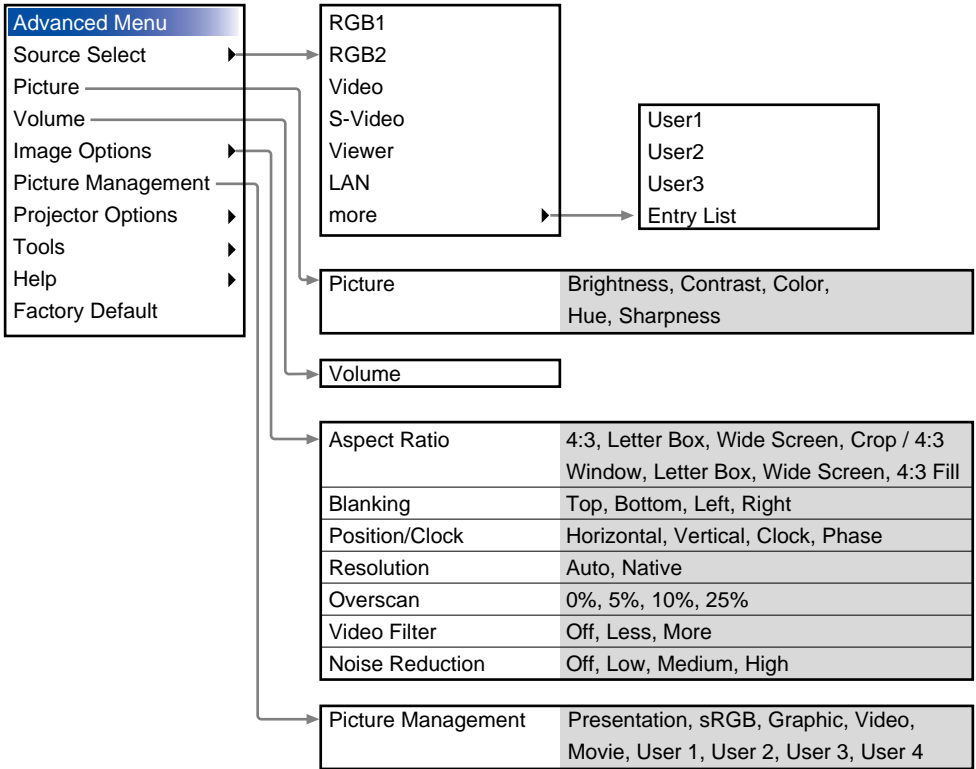

USING ON-SCREEN MENU > Basic Menu Operation

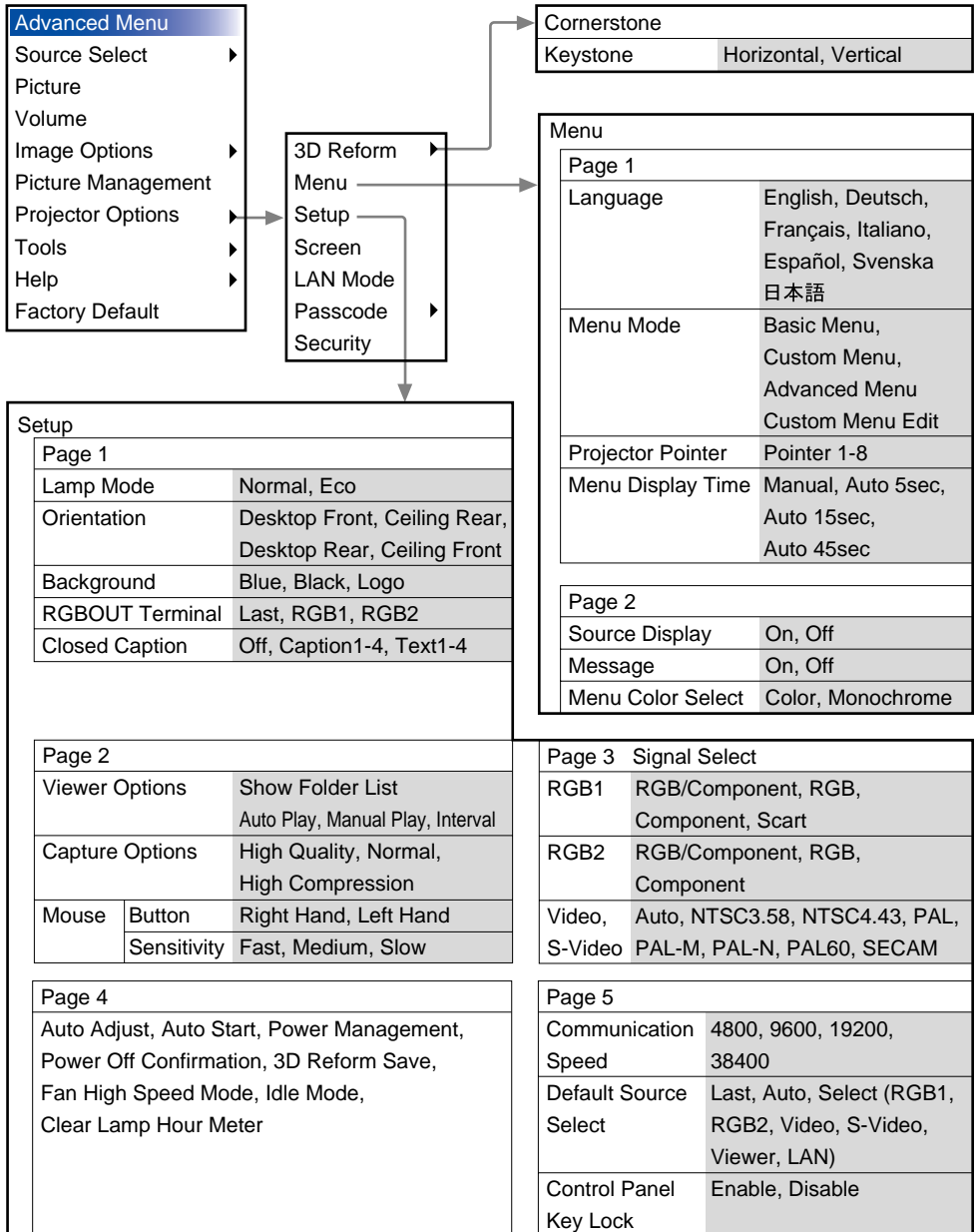

USING ON-SCREEN MENU > Basic Menu Operation

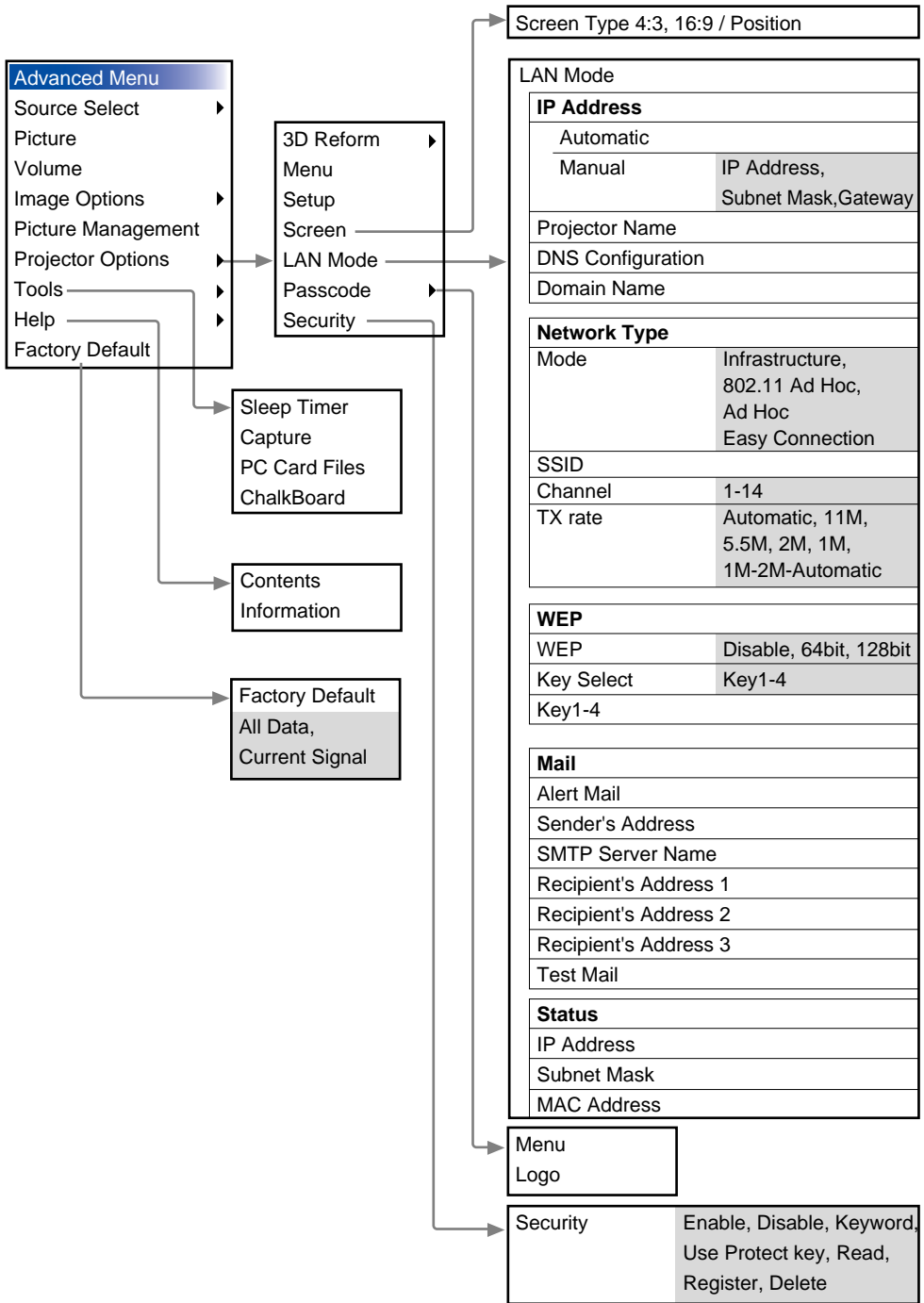

Menu Elements

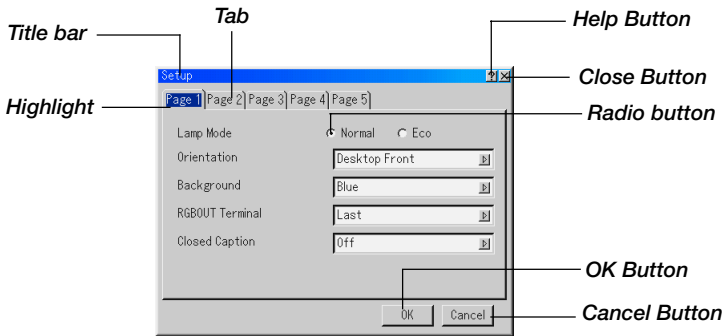

Check box

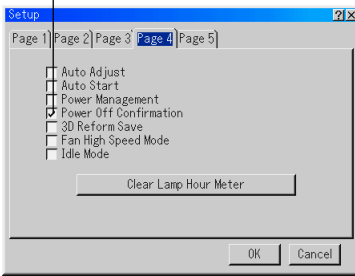

Solid triangle

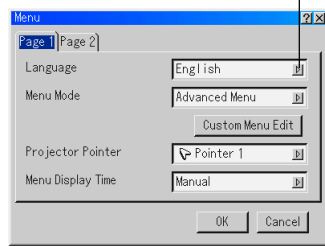

Drag

Tool bar



Slide bar

Menu windows or dialog boxes typically have the following elements:

- Title bar Indicates the menu title.
- Highlight Indicates the selected menu or item.
- Solid triangle ... Indicates further choices are available. A highlighted triangle indicates the item is active.
- Tab Indicates a group of features in a dialog box. Selecting on any tab brings its page to the front.
- Radio button Use this round button to select an option in a dialog box.

USING ON-SCREEN MENU > Basic Menu Operation

- Check box Place a checkmark in the square box to turn the option On.
- Slide bar Indicates settings or the direction of adjustment.
- OK button Press to confirm your setting. You will return to the previous menu.
- Cancel button .. Press to cancel your setting. You will return to the previous menu.
- Close button Click to close the window with saving changes. (USB mouse only)
- Help button Indicates that help about that feature is available (USB mouse only). Press the Help button on the remote control to display help.
- Toolbar Contains several icons for specific tasks. It is also referred to as “launcher”.
- Drag Point the mouse here, and click and drag to move a toolbar.



Entering Alphanumeric Characters by Using the Menu

Alphabet or numeric characters are used for your IP address or projector name. To enter IP Address or projector name, use the software keyboard. For using the software keyboard, see page E-134.

Menu Descriptions & Functions

Source Select

Selecting a Source

Enables you to select a video source such as a VCR, DVD player, laser disc player, computer or document camera depending on what is connected to your inputs. Press the SELECT ▲▼ button on the projector cabinet or on your remote control to highlight the menu for the source you want to project.

RGB

Selects the computer connected to your RGB1, RGB2 or component signal.

NOTE: An optional component cable (Component V or ADP-CVI cable) is needed for a component signal.

Video

Selects what is connected to your Video input-VCR, laser disc player, DVD player or document camera.

S-Video

Selects what is connected to your S-Video input-VCR, DVD player, or laser disc player.

NOTE: A frame may freeze for a brief period of time when a video is played back in fast-forward or fast-rewind with a Video or S-Video source.

Viewer

This feature enables you to make presentations using a PC card that contains captured images and slides created with the exclusive Dynamic Image Utility 2.0 contained in the CD-ROM. See the supplied Application Guide for installing the Dynamic Image Utility 2.0. The starting screen for the Viewer varies depending on the settings of the Setup's Page 2. See Setup on page E-96.

USING ON-SCREEN MENU > Menu Descriptions & Functions

NOTE: Even if you switch the current Viewer source to another source, the current slide is retained. When you return back to the Viewer, you will get the slide that has been retained. A launcher will appear when you press the MENU button.

A press of the MENU button displays the toolbar; a press of the MENU button again displays the Menu and hereafter each press of the MENU button switches displaying between the Menu and the toolbar.

The launcher is a tool bar including the following buttons:

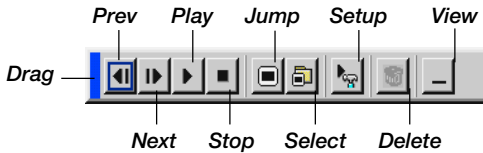

- Drag Drags to move the tool bar. (for USB mouse operation only)
- Prev Returns to the previous slide or folder.
- Next Advances to the next slide or folder.
- Play Plays back automatically or manually depending on the setting on Viewer Options of the menu. This allows you to move on to the next slide when "Manual Play" is selected.
- Stop Stops Auto Play while you are playing back and to resume playing from the selected slide or folder when "Auto Play" is selected.
- Jump Displays a list of slides while you are playing back.
- Select Displays a list of folders while you are playing back.
- Setup Displays the Viewer Options dialog box on Page 2 of the Setup dialog box.
- Delete Deletes a captured slide(s) or all the captured slides in the selected folder.
- View Hides the tool bar while you are playing back. Clicking with the right button of a mouse shows it again. Provides access to controls for your image. Use the SELECT button on the projector cabinet or the remote control to highlight the menu for the item you want to adjust.

LAN

Selects a signal from a LAN card plugged into the projector's card slot.

Entry List

Displays the list of the entry signals. Use the SELECT ▲▼ buttons on your remote control or the projector cabinet to select the signal and press the ENTER button on the remote control or the projector cabinet to display the Entry Edit Command screen.

Using the Entry List

Making any adjustments to the current picture will automatically register its adjustments to the Entry List. The registered signal can be loaded any time from the Entry List.

NOTE: Up to 100 presets can be registered.

Entry Edit Command

You can edit signals on the Entry List.

Load: Enables you to select a signal from the list.

Store: Enables you to store the currently projected signal that currently projected.

Cut: Enables you to remove a selected signal from the list and place it on the "clipboard" in the projector.

Copy: Enables you to copy a selected signal from the list and place it on the "clipboard" in the projector.

Paste: Enables you to paste the signal placed on the "clipboard" to any other line of the list. To do this, select "Paste" and then select the line number you want to paste to. Last press ENTER.

Edit: Enables you to change source names or add source names to "More" in the Source Select.

Source Name: Enter a signal name. Up to 18 alphanumeric characters can be used.

Input Terminal: Change the input terminal. RGB1 and RGB2 are available for RGB signal; Video and S-Video are available for composite signal.

Source List: Set signal selection method.

Lock: Set so that the selected signal cannot be deleted when "All Delete" is executed.

Skip: Set so that the selected signal will be skipped during auto search.

When complete, select OK and press ENTER. To exit without storing setting, select Cancel. Select "Source Name" and press ENTER to display the Source Name Edit window. You can change source name on this window. Press [▼] to display the software keyboard, which you can enter alphanumeric characters. See page E-134 for the key function of the software keyboard.

The following buttons are not available for the currently projecting signals:

- 1) The Cut and Paste buttons on the Entry Edit Command screen
- 2) The Input Terminal button on the Entry Edit screen

All Delete: This feature enables you to delete all the registered signals in the Entry List.

NOTE: When all the signals in the Entry List are deleted, the currently projected signal will be also deleted except locked signals.

Select "Input Terminal" and press ENTER to display the Input Terminal window.

Picture (not available for Viewer and LAN)

Adjusting Brightness, Contrast, Color, Hue, and Sharpness

Brightness Adjusts the brightness level or the back raster intensity.

Contrast Adjusts the intensity of the image according to the incoming signal.

Color Increases or decreases the color saturation level (not valid for RGB).

Hue Varies the color level from +/- green to +/-blue. The red level is used as reference. This adjustment is only valid for Video and Component inputs (not valid for RGB).

Sharpness Controls the detail of the image for Video (Not valid for RGB).

Volume

Controlling Volume

Adjusts the sound level of the projector speaker and AUDIO OUT.

Image Options

Selecting Aspect Ratio (not available for Viewer and LAN)

Aspect Ratio allows you to select the best Aspect mode to display your source image.

When screen size 4:3 is selected for the source, the following selections will display:

4:3 Standard 4:3 aspect

Letter Box Reduced to display the true aspect with black borders on top and bottom

Wide Screen ... Left & Right stretched with black borders on top and bottom

Crop Left & Right stretched.

Left & Right sides cut. Available for 4:3 only.

When screen size 16:9 is selected for the source, the following selections will display:

4:3 Window Reduced to display the true aspect with black borders on right and left

Letter Box Standard 16:9 aspect

Wide Screen ... Left and right stretched to display the true aspect

4:3 Fill Stretched to display in 16:9 aspect ratio











NOTE: You can adjust image positions vertically for source with black borders. See page E-101 for setting image positions.

Copyright

Please note that using this projector for the purpose of commercial gain or the attraction of public attention in a venue such as a coffee shop or hotel and employing compression or expansion of the screen image with a "Aspect Ratio" or "Screen" setting may raise concern about the infringement of copyrights which are protected by copyright law.

NOTE: During 3D Reform adjustment, "Aspect Ratio" may not be available. Should this happen, first reset the 3D Reform data and then do setting again. Second repeat the 3D Reform adjustment.

Changing the aspect ratio can limit 3D Reform in its adjustable range.

Input Signal Screen Type	 4:3	 Letter Box	 Squeeze
4:3 Screen	 4:3	 Letter Box	  Wide Screen Crop
16:9 Screen	  4:3 Window 4:3 Fill	 Letter Box	 Wide Screen

Masking Unwanted Area (Blanking)

This feature allows you to mask any unwanted area of the screen image.

NOTE: Adjustment of vertical display range

Adjust the Top, Bottom, Left or Right blanking with the SELECT ◀ or ▶ button.

Adjusting Position and Clock

This allows you to manually adjust the image horizontally and vertically, and adjust Clock and Phase.

Horizontal/Vertical Position:

..... Adjusts the image location horizontally and vertically using the SELECT ◀ and ▶ buttons. This adjustment is made automatically when the Auto Adjust is turned on. See "Auto Adjust" on page E-98 for turning on or off the Auto Adjust feature.

Clock Use this item to fine tune the computer image or to remove any vertical banding that might appear. This function adjusts the clock frequencies that eliminate the horizontal banding in the image.

Press the SELECT ◀ and ▶ buttons until the banding disappears. This adjustment may be necessary when you connect your computer for the first time. This adjustment is made automatically when the Auto Adjust is turned on.

Phase Use this item to adjust the clock phase or to reduce video noise, dot interference or cross talk. (This is evident when part of your image appears to be shimmering.) Use the SELECT ◀ and ▶ buttons to adjust the image.

Use "Phase" only after the "Clock" is complete. This adjustment is made automatically when the Auto Adjust is turned on.

Selecting Resolution

This allows you to activate or deactivate the Advanced AccuBlend feature.

Auto Turns on the Advanced AccuBlend feature. The projector automatically reduces or enlarges the current image to fit the full screen.

Native Turns off the Advanced AccuBlend feature. The projector displays the current image in its true resolution. See "Auto Adjust" on page E-98 for turning on or off the Auto Adjust feature.

NOTE:

- * When "Resolution" is set to "Native", "3D Reform", "Aspect Ratio" and "Screen" are not available.
 - * If you are displaying an image with a resolution higher than the projector's native resolution (i.e. 1024×768 for LT260/240 and 800×600 for LT220) and "Native" mode is selected in the menu system, the portion of the image that lies off screen will be lost because of a change in the horizontal-to-vertical ratio. This is due to the image having a larger horizontal resolution than the panels native resolution. This is not a malfunction and it can be corrected using the 'Phase' adjustment in the menu system. After adjusting 'Phase', set the resolution mode to "Auto".
-

Selecting Overscan Percentage

Select overscan percentage (0%, 5%, 10% and 25%) for signal.

NOTE: When "Resolution" is set to "Native", this feature is not available, and the stored settings and adjustments are invalid.

NOTE: When "4:3 Fill" or "Crop" is selected in "Aspect Ratio", this feature is not available.

Selecting Video Filter Level (not available for Video, Viewer and LAN)

This function reduces video noise.

Off The filter is removed.

Less The low-pass filter is applied partially.

More The low-pass filter is applied fully.

Selecting Noise Reduction Level (not available for RGB, Viewer and LAN)

Select one of the three levels for reducing video noise: Low, Medium or High.

NOTE: The lower the Noise Reduction level, the better the image quality by way of higher video bandwidth.

Picture Management

This option allows you to adjust neutral tint for yellow, cyan or magenta. There are 5 factory presets optimized for various types of images, or you can set 4 user adjustable settings.

Presentation Recommended for making a presentation using a PowerPoint file

sRGB Standard color values (not available on LT220)

Graphic Recommended for graphics

Video Recommended for regular picture such as TV program

Movie Recommended for movie

User 1-4 User adjustable

NOTE: When "sRGB", "Graphic", "Video" or "Movie" is selected, the brightness decreases slightly when compared to "Presentation." This is not a malfunction.

User Adjust (when using User 1 to 4)

When selecting one of four user adjustable presettings (User 1 through 4), the submenu will be displayed.

You can customize each gamma or color. To do so, first select [Setting] and press the ENTER button, and then proceed the following steps.

Selecting Gamma Correction Mode

Use the ◀ or ▶ buttons to choose one mode from three options.

Each mode is recommended for :

Dynamic For true color reproduction of natural tones

Black Detail For dark portions of a picture

Natural Normal settings

Selecting Color Correction (not available on LT220)

Adjusts red, green, blue, yellow, magenta, cyan and color gain each independently to correct the tint on whole screen.

Selecting White Peaking

Adjust the brightness of the white areas by using the slide bar. As the picture becomes dim, it looks more natural.

Adjusting Color Temperature (not available on LT220) and White Balance

This feature adjusts the color temperature using the slide bar.

Checking "Color Temperature" enables the color temperature slide bar and disables the "White Balance" button.

Press the White Balance button to access the Contrast/Brightness adjustment for each R, G, and B.

NOTE: "Color Temperature" and "White Balance" are a trade-off.

The Color Correction, Color Temperature and Base Setting items are not available on LT220.

The White Balance is not available for Viewer and LAN.

NOTE: When "Presentation" is selected, the available items are "Gamma" and "White Balance" only.

Selecting Base Setting

This feature allows you to use color correction or gamma values as reference data to optimize for various types of images. You can select one of the following five settings.

- Presentation
- Video
- Movie
- Graphic
- sRGB (not available on LT220)

Projector Options

Using 3D Reform

This feature corrects trapezoidal distortion so that the projected image is rectangular.

Two options are available for correcting procedures.

You can save adjustment settings by using the 3D Reform Save option on Setup (See page E-99).

Cornerstone

See page E-45

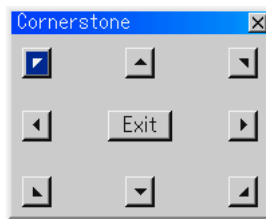

Keystone

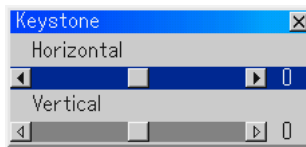

1. Press the SELECT ◀▶ button to adjust the horizontal keystone.
2. Press the SELECT ▲▼ button to select "Vertical".
3. Press the SELECT ◀▶ button to adjust the vertical keystone.
4. After completing, press the ENTER button. This will return to the menu screen.

* When "Resolution" is set to "Native", "Cornerstone" and "Keystone" are not available.

Menu

Allows you to set preferences for the on-screen menu. Press "OK" to save your changes for all the features of Page 1 and Page 2.

[Page1]

Selecting Menu Language [Language]:

You can choose one of seven languages for on-screen instructions. The options are: English, German, French, Italian, Spanish, Swedish and Japanese.

Selecting Menu Mode [Menu Mode]:

This feature allows you to select 3 menu modes: Advanced Menu, Custom Menu and Basic Menu.

Advanced Menu

..... This is the menu that contains all the available menus and commands.

Basic Menu This is the basic menu that contains minimum essentials of menus and commands.

Custom Menu .. This is the menu that you can customize using the Custom Menu Edit to fit your needs.

Customizing the Menu:

See page E-74 for instructions about how to customize the Menu.

Selecting Projecting Pointer Icon [Projector Pointer]:

This enables you to select from eight different Pointer icons for the "Pointer" button on your remote control.

After moving your Pointer icon to the area you want on the screen, press the Magnify button on the remote control to enlarge the selected area on the screen. See page E-55 for more details.

NOTE: There may be cases where the Pointer function is not available (ex. a non-interlace signal at 15kHz such as video game.)

Selecting Menu Display Time :

This option allows you to select how long the projector waits after the last touch of a button to turn off the menu.

The preset choices are "Manual", "Auto 5 sec", "Auto 15 sec", and "Auto 45 sec". The "Auto 45 sec" is the factory preset.

Manual The menu can be turned off manually.

Auto 5 sec The menu will automatically be turned off in 5 seconds if no buttons are pressed within 5 seconds.

Auto 15 sec The menu will automatically be turned off in 15 seconds if no buttons are pressed within 15 seconds.

Auto 45 sec The menu will automatically be turned off in 45 seconds if no buttons are pressed within 45 seconds.

[Page 2]

Turning On / Off Source Display [Source Display]:

This option turns on or off input name display such as RGB1/2, Video, and No Input to be displayed in the top right corner of the screen.

Turning On / Off Message [Message]:

This option turns on and off messages for lamp life warning, 3-minute before power off time and "This feature is not available."

Selecting Menu Color [Menu Color Select]:

You can choose between two color modes for menu color: color and monochrome.

Setup

Enables you to set operating options.

Press "OK" to save your changes for all the features of Page1, Page2, Page3, Page 4 and Page 5.

[Page 1]

Setting Lamp Mode to Normal or Eco [Lamp Mode]:

This feature enables you to select two brightness mode of the lamp: Normal and Eco modes. The lamp life can be extended up to 2000 hours by using the Eco mode.

Normal Mode .. This is the default setting (100% Brightness).

Eco Mode Select this mode to increase the lamp life (80% Brightness).

Selecting Projector Orientation [Orientation]:

This reorients your image for your type of projection. The options are: desktop front projection, ceiling rear projection, desktop rear projection, and ceiling front projection.

Selecting a Color or Logo for Background [Background]:

Use this feature to display a blue/ black screen or logo when no signal is available. The default background is blue. You can change the logo screen using the PC Card Files feature. See pages E-59 and 115.

Setting RGB 1 or 2 for RGB OUT [RGBOUT Terminal]

This option allows you to determine which RGB source is output from the RGBOUT connector during Idle mode.

Last The signal from the last RGB input will be output to the RGBOUT connector.

RGB 1 The signal from RGB IN1 will be output to the RGBOUT connector.

RGB 2 The signal from RGB IN2 will be output to the RGBOUT connector.

NOTE: The AUDIO OUT mini jack will not output sound during the Idle mode.

Setting Closed Caption

This option sets several closed caption modes that allows text to be superimposed on the projected image.

CAPTION 1-4 Text is superimposed.

TEXT 1-4 Text is displayed in full screen.

OFF This exits the closed caption mode.

[Page 2]

Setting Viewer Options [Viewer Options]

Show Folder List:

If this option is checked, when the Viewer source is selected on the projector, the folder lists will be displayed and allows you to select the presentation from a PC card.

Auto Play:

If this option is checked, when the Viewer source is selected on the projector any given slide will start to play automatically.

Auto Play Interval:

You can specify interval time between 5 and 300 seconds.

NOTE: The Auto Play Interval time set on "Slide Show Settings" of the Dynamic Image Utility 2.0 overrides the one set here.

Manual Play:

Views a slide manually when the Viewer source is selected.

Selecting Capture Options [Capture Option]: (available for JPEG only)

These options are used for the Capture function that you can select from Tools. You have three options for JPEG compression quality: High quality, Normal and High Compression.

High Quality Gives quality of JPEG a priority.

Normal Gives normal JPEG quality.

High Compression Gives compression a priority.

Setting Mouse Button and Sensitivity [Mouse]:

This option lets you to change your USB mouse settings. The mouse settings feature is available for USB mouse only. Choose the settings you want:

Mouse Button "Right Hand" or "Left Hand"

Mouse Sensitivity "Fast", "Medium" or "Slow"

[Page 3]

Selecting Signal Format [Signal Select]

RGB1/2:

Allows you to choose "RGB" for an RGB source such as a computer, or "Component" for a component video source such as a DVD player. Normally select "RGB/Component" and the projector automatically detects an either incoming signal. However there may be some component signals that the projector is unable to detect. If this is the case, select "Component". Select "Scart" in RGB 1 for the European Scart.

VIDEO and S-VIDEO:

This feature enables you to select composite video standards manually. Normally select "Auto". Select the video standard from the pull-down menu. This must be done for Video and S-Video separately.

[Page 4]

Enabling Auto Adjust [Auto Adjust]:

When "Auto Adjust" is set to "On", the projector automatically determines the best resolution for the current RGB input signal to project an image using NEC's Advanced AccuBlend Intelligent Pixel Blending Technology.

The image can be automatically adjusted for position and stability; "Horizontal Position", "Vertical Position", "Clock", "Phase", and "Resolution".

On Automatically adjusts image "Horizontal Position", "Vertical Position", "Clock", "Phase" and "Resolution".

Off User can adjust the image display functions ("Horizontal Position", "Vertical Position", "Clock", "Phase" and "Resolution") manually.

Enabling Auto Start [Auto Start]:

Turns the projector on automatically when the power cable is inserted into an active power outlet and the main power switch is turned on. This eliminates the need to always use the "Power" button on the remote control or projector cabinet.

Enabling Power Management [Power Management]:

When this option is on and there is no input for five minutes or more, the projector will automatically turn itself off.

Enabling Power Off Confirmation [Power Off Confirmation]:

This option determines whether a confirmation dialog for turning off the projector will appear or not.

NOTE: When the confirmation message is displayed, you must be in the Projector mode to operate your projector using the remote control. If not, press the PJ button on the remote control to change your projector to the Projector mode. The button lights to indicate that you are in the Projector mode.

**Enabling Horizontal and Vertical Keystone Correction Save:
[3D Reform Save]**

This option enables you to save your current 3D Reform settings. Saving your change once affects all sources. The changes are saved when you turn off the projector.

Enabling Fan High Speed Mode [Fan High Speed Mode]:

This option allows you to select two modes for fan speed: high-speed mode and normal speed mode.

When you wish to cool down the temperature inside the projector quickly, check this box.

NOTE: Enable Fan High-Speed mode if you continue to use the projector for consecutive days.

Enabling Idle Mode [Idle Mode]:

The projector has two standby modes: Standby and Idle.

Standby is the mode that allows you to put the projector in the standby condition which consumes less power than the idle mode. The projector is preset for Standby at the factory.

When this check box is turned on, you allow the RGB OUT connector to output RGB signal during Idle mode.

NOTE:

- * *The RGB OUT connector will not output signal during the Standby mode.*
 - * *Via the serial interface the projector can be turned on from your PC using Dynamic Image Utility 2.0 during the Standby or Idle mode. On the LAN connection the projector can be controlled or monitored from your PC using Dynamic Image Utility 2.0 only in the Idle mode.*
 - * *The HTTP server functions are not available during Standby mode.*
-

Clearing Lamp Hour Meter [Clear Lamp Hour Meter]:

Resets the lamp clock back to zero. Pressing this button appears a confirmation dialog box. To reset the lamp usage hour, press "OK".

NOTE: The projector will turn off and go into standby mode after 1600 hours (up to 2100 hours in Eco mode) of service. In this condition you cannot clear the lamp hour meter on the menu. If this happens, press the "Help" button on the remote control for ten seconds to reset the lamp clock back to zero. Do this only after replacing the lamp.

[Page 5]

Selecting Communication Speed [Communication Speed]:

This feature sets the baud rate of the PC Control port (Mini DIN 8 Pin). It supports data rates from 4800 to 38400 bps.

The default is 38400 bps. Select the appropriate baud rate for your equipment to be connected (depending on the equipment, a lower baud rate may be recommended for long cable runs).

Selecting Default Source [Default Source Select]:

You can set the projector to default to any one of its inputs each time the projector is turned on.

- Last Sets the projector to default to the previous or last active input each time the projector is turned on.
- Auto Searches for an active source in order of RGB1 → RGB2 → Video → S-Video → Viewer → RGB1 and displays the first found source.
- Select Displays the selected source input every time the projector is started up. Select an input from the pull-down menu.

Disabling the Cabinet Buttons [Control Panel Key Lock]:

This option turns on or off the Control Panel Key Lock function.

NOTE:

- * *This Control Panel Key Lock does not affect the remote control and the PC Control functions.*
 - * *When the cabinet buttons are disabled, pressing and holding the CANCEL button for about 10 seconds will change the setting to enabled.*
-

Selecting Aspect Ratio and Position for Screen [Screen]

Screen Type:

Select either 4:3 Screen or 16:9 Screen for the screen to be used. See also "Aspect Ratio" on page E-86.

NOTE: When "Resolution" is set to "Native", this selection is inactive.

Position:

This feature adjusts the vertical position of the image when viewing video with an aspect ratio selected.

When some aspect ratios are selected in Image Options, the image is displayed with black borders on the top and bottom.

You can adjust the vertical position between top and bottom.

NOTE: This option is available only when "16:9" is selected in Screen Type.

NOTE: During 3D Reform adjustment, "Screen Type" and "Screen Position" may not be available. To make available, first reset the 3D Reform data and then do settings again. Secondly repeat the 3D Reform adjustment. Changing "Screen Type" and "Screen Position" can limit 3D Reform in its adjustable range.

Setting LAN Mode

This feature allows you to set various setting items when the projector is used on your network.

Consult with your network administrator about these settings.

NOTE: A LAN card is required for LAN connection; NEC's optional wireless LAN card is available. For more information on inserting or ejecting a LAN card, see pages E-63 and 64.

CAUTION: Make sure that the LAN card is removed during Standby mode (NOT Idle mode) or with the main power off.

Failure to do so may cause damage to the data on your PC card.

NOTE: LAN card is not available when a PC card is used for the Viewer function. Viewer is not available when LAN card is used for LAN connection.

IP Address

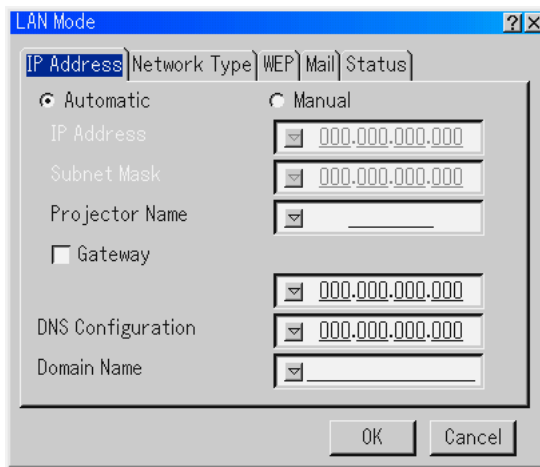

An IP address can be automatically assigned to this projector by your DHCP server. If your network does not automatically assign IP address, ask your network administrator for an address, and then register it manually.

USING ON-SCREEN MENU > Menu Descriptions & Functions

Automatic Automatically assigns an IP address to the projector from a DHCP server.

Manual Provides a space for you to register the IP address or subnet mask number obtained from your network administrator.

IP Address Set your IP address. Press to display the software keyboard and type in 12 numeric characters.

Subnet Mask ... Set your subnet mask number. Press to display the software keyboard and type in 12 numeric characters.

Projector Name

..... Specify a unique projector name. Press to display the software keyboard and type in. Up to 16 alphanumeric characters can be used.

Gateway Set the default gateway of the network connected to the projector. Press to display the software keyboard and type in 12 numeric characters.

Checking this box will make the set default route valid. When data is sent from the LAN card, the transfer location will be searched according to the previously set routing information; however, when the transfer location has not been found as a result of the search, the data will be sent to the device that holds the IP address set here. The IP address that is set here must be one that can be identified by a search of the routing information.

DNS Configuration

..... Type in the IP address of DNS server on the network connected to the projector. 12 numeric characters are used.

Domain Name . Type in domain name of the network connected to the projector. Up to 60 alphanumeric characters can be used.

Network Type (required for wireless only)

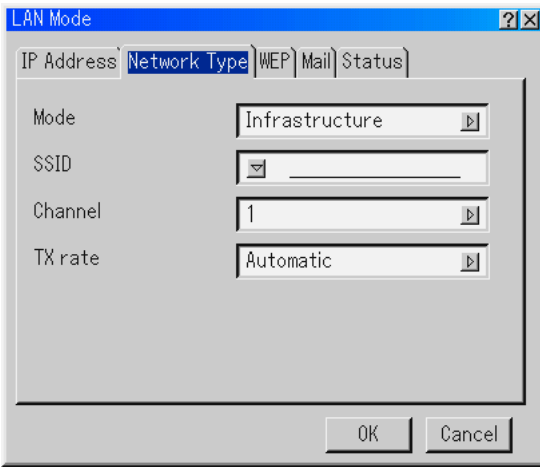

Mode:

Select communication method when using wireless LAN.

Infrastructure ... Select this option when communicating with one or more equipment connected to the wireless or wired LAN network via an access point.

802.11 Ad Hoc Select this option when using the wireless LAN to communicate with a computer in a one-to-one correspondence. This is a method that meets the IEEE802.11 wireless standard.

Ad Hoc Select this option when using the wireless LAN to communicate with a computer in a one-to-one correspondence.

Easy Connection

..... This allows you to easily set up wireless LAN connection. See the supplied Application Guide for more information.

SSID (Network name):

Enter an identifier (SSID) for wireless LAN when selecting [Infrastructure] or [802.11 Ad Hoc] in [Mode]. Communication can be done only with equipment whose SSID matches SSID for your wireless LAN. Up to 16 alphanumeric characters can be used.

NOTE: To disable SSID, select a space (null) or "ANY"(All caps).

Channel:

Set this option when selecting [802.11 Ad Hoc] or [Ad Hoc] in [Mode]. Select a channel number from the pull-down list. The channel must match for all wireless devices communicating on your wireless LAN.

NOTE: Channels in the pull-down list are different depending on which country you live in.

TX rate:

Select a wireless transmission speed. Normally leave it as Automatic. Try another transmission speed when the connection fails.

WEP (for Wireless only)

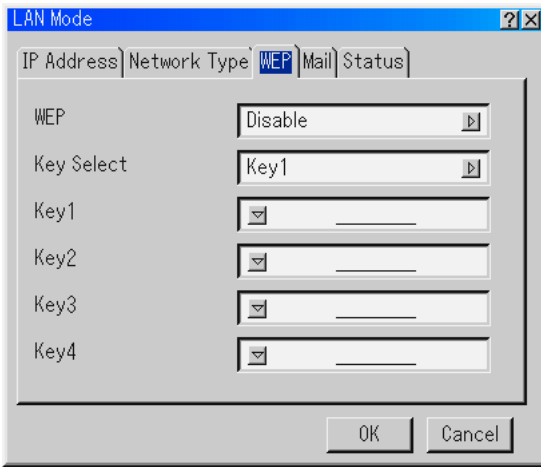

Select this option whether using the WEP (Wired Equivalent Privacy) key for encryption or not. To use encryption, specify WEP key.

Disable Will not turn on the encryption feature. Your communications may be monitored by someone.

64bit Uses 64-bit datalength for secure transmission.

128bit Uses 128-bit datalength for secure transmission. This option will increase privacy and security when compared to use of 64bit datalength encryption.

NOTE: The WEP settings must be the same as communication devices such as PC or access point in your wireless network. When you use WEP, your image transmission speed will slow down.

Key Select:

Selects one key from the four keys below when selecting [64bit] or [128bit] in [WEP].

Key1-4:

Enter encryption key when selecting [64bit] or [128bit] in [WEP].
The key can also be set in hexadecimal digit.

- * Enter 0X(numeral and alphabet respectively) right in front of your key code.
- * Hexadecimal uses 0 to 9 and A to F.
- * Up to 10 characters can be set in 64 bit and up to 26 characters in 128 bit.

Mail

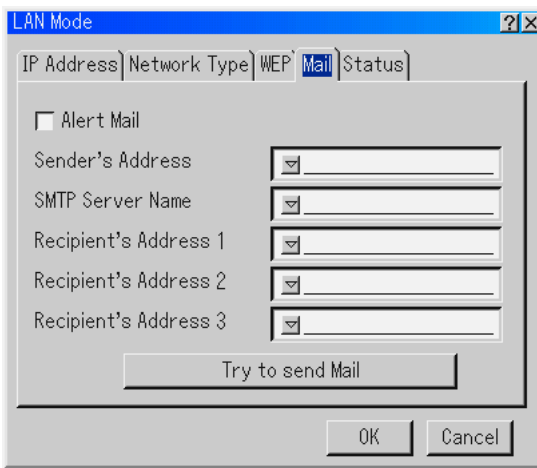

NOTE: To the Mail Alert feature on wireless LAN connection, select "Infrastructure" for "Mode" in "Network Type."

"Test Mail" is available only when there is a LAN card in the PC card slot of the projector.

Alert Mail:

Checking this box enables Alert Mail feature.

This option notifies your computer of an error message via e-mail when using wireless or wired LAN. The error message will be notified when the projector lamp has reached the end of its usable life or an error occurs in the projector.

USING ON-SCREEN MENU > Menu Descriptions & Functions

Sample of a message sent from the projector:

The lamp is at the end of its usable life. Please replace the lamp.

Projector Name: X X X X

Lamp Hour Meter: xxxx [H]

Projector Usage: xxxxxx [H]

Sender's Address:

Specify the senders address. Use the Software keyboard. Up to 60 alphanumeric and symbols characters can be used. See "Using Software Keyboard" in Appendix for more details.

SMTP Server Name:

Type in the SMTP server name to be connected to the projector. Up to 60 alphanumeric characters can be used.

Recipient's Address 1 to 3:

Type in your recipient's address. Up to 60 alphanumeric and symbols characters can be used.

Test Mail:

Send a test mail to check if your settings are correct.

NOTE: If you entered an incorrect address in a test, you may not receive an Alert mail. Should this happen, check if the Recipient's Address is correctly set.

NOTE: Unless any one of the "Sender's Address", "SMTP Server's Name" or "Recipient's Address 1-3" is selected, "Test Mail" is not available.

Status

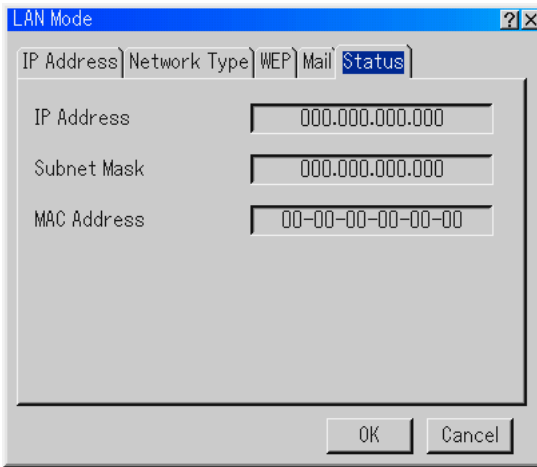

Displays the status of the LAN settings.

IP Address Indicates the IP address of the projector.

Subnet Mask ... Indicates the subnet mask of the projector.

MAC Address .. Indicates the MAC address of the LAN card.

Setting a Passcode

A passcode can be set for your projector to avoid operation by an unauthorized.

There are two kinds of passcode: one for menu and the other for logo. When a passcode is set, doing any one of the following four operations will display the Passcode input screen.

For Menu:

- * Changing the menu to Advanced
- * Editing the custom menu

For Logo:

- * Changing the background
- * Changing the logo data in PC Card Files

Procedures for Passcode setting apply to both Menu and Logo.

Entry

To assign your passcode:

NOTE: Up to 15 digits can be assigned.

1. **Select [Entry] and press the ENTER button. The [Entry] screen will be displayed.**
2. **Type in a combination of SELECT buttons ▲▼◀▶ and press the ENTER button.**

The [Confirm Passcode] screen will be displayed.

3. **Type in the same combination of SELECT buttons ▲▼◀▶ and press the ENTER button.**

Your passcode has been assigned.

Delete

To delete your passcode:

1. **Select [Delete] and press the ENTER button. The [Delete] screen will be displayed.**
2. **Type in your passcode and press the ENTER button.**

Your passcode has been deleted.

In case you forget your passcode, follow the steps below to delete it.

1. **Select the Advanced menu from the Basic/Custom menu. The Passcode entry screen will be displayed.**
2. **Press the SELECT ▲ (up) button four times and then press the ENTER button.**

The "Warning Passcode!!!" message will be displayed.

3. **Press the SELECT ▼ (down) button four times and then press the ENTER button.**

The "Warning Passcode!!!" message will be displayed.

4. **Press the SELECT ▶ (right) button four times and then press the ENTER button.**

The "Delete Passcode / Are you sure?" message will be displayed.

Use the SELECT ◀ or ▶ button to select "Yes" and press the ENTER button. Your passcode has been deleted.

Security

The Security function enables you to protect your projector so that the projector will not project a signal unless you enter a keyword. There is also an option to lock the projector by using a registered PC card as a protect key. Once you have registered your PC card as a protect key, you are required to insert the registered PC card into the PC card slot of the projector each time you turn on the projector. You can enable the Security function by using a keyword only.

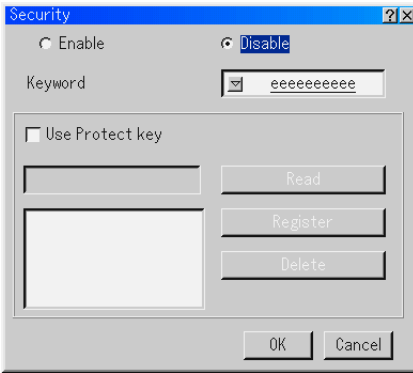

- Enable/Disable This turns the Security function on or off.
- Keyword Enter an appropriate keyword when you use the Security function.
(Up to 10 characters can be used.)
The Security function is available only when your keyword is entered.
- Use Protect key Check this box to lock your projector when using a PC card. To use a keyword without a PC card, do not check this box.
- Read Reads data of a PC card.
- Register Registers data of the PC card.
The Security function is not available unless at least one PC card is registered. (if the “Use Protect key” check box is selected)
Up to 5 PC cards can be registered.
- Delete Deletes data of a registered PC card.

To set up a keyword to enable the Security function without using a registered PC card

1. Use the SELECT ▲▼ button to select “Keyword” and use the software keyboard to enter a keyword.

NOTE: Please make a note of your keyword.

2. Use the SELECT ▲▼ button to select “Enable” and use the SELECT ▲▼ button to select “OK”, then the Security function will be enabled. An “Are you sure?” message will appear. Use the SELECT ◀▶ button and press the ENTER button.

The Security function takes effect.

To register a PC card as a protect key

1. Insert a PC card into the PC card slot of the projector.
2. Use the SELECT ▲▼ button to select "Read" and press the ENTER button.

Data of the PC card will be read into the projector.

3. Use the SELECT ▲▼ button to select "Register" and press the ENTER button.

Downloaded data will be registered and be displayed in the list window.

4. Use the SELECT ▲▼ button to select "Keyword" and use the software keyboard to enter a keyword.

NOTE: To use a PC card as a protect key, you must also set up a keyword. Please make a note of your keyword.

This completes registration of your PC card.

To enable Security, use the SELECT ▲▼ button to select "Enable" and use the SELECT ▲▼ button to select "OK" and "Security function will be enabled. An “Are you sure?” message will appear. Use the SELECT ◀▶ button and press the ENTER button.

The Security function takes effect.

To turn on the projector when Security is enabled (when using your keyword only)

1. **Press and hold the POWER button for a minimum of two seconds.**

The projector will be turned on and display a message to the effect that the projector is security-protected.

2. **Select [Projector Options] → [Security] from the menu and press the ENTER button.**

The Release Code input screen will be displayed.

3. **Enter your keyword in the Release Code input screen.**

You can view the projected image.

NOTE: Do not forget your keyword. However, if you forget your keyword, NEC or your dealer will provide you with your Release Code. See more information at the end of this section.

To turn on the projector when Security is enabled (when using a PC card as a protect key)

1. **Insert your registered PC card into the PC card slot.**
2. **Press and hold the POWER button for a minimum of two seconds.**

The projector will turn on and then recognize the PC card. Once the image has been projected, it will stay on without the PC card.

To delete PC card data you registered

1. **Use the SELECT ▲▼ button to select "Register" and use the SELECT ◀ button to select the list window.**
2. **Use the SELECT ▲▼ button to select the PC card data you wish to delete.**
3. **Press the SELECT ▶ button to select "Delete" and press the ENTER button.**

The PC card data will be deleted.

If you've lost your registered PC card, proceed as follows:

NOTE: NEC or your dealer will provide you with your Release Code in exchange for your registered keyword and Request Code. See more information at the end of this section.

1. Press and hold the POWER button for a minimum of two seconds.

The projector will be turned on and display a message to the effect that the projector is security-protected.

2. Select [Projector Options] → [Security] from the menu and press the ENTER button.

The Release Code input screen will be displayed as well as your Request Code (24 alphanumeric characters).

3. Enter your Release Code in the Release Code Input screen.

The projector will turn on.

- * If the projector is turned on by entering the Release Code, your Security will be disabled.

NOTE:

* *Some types of PC cards cannot be registered as your protect key.*

* *It is recommended that you register two or more PC cards in case you lose or damage your registered PC card.*

* *Formatting your registered PC card will disable your protect key function.*

NOTE:

For additional information visit:

US : <http://www.necvisualsystems.com>

Europe : <http://www.nec-europe.com/>

Global : <http://www.nec-pj.com/>

Tools

Provides tools for setting sleep timer, capturing images, displaying files or changing your background logo in a PC Card and drawing.

NOTE: The "Capture" and "PC Card Files" features are required for a PC card.

Using Sleep Timer

- 1. Select your desired time between 30 minutes and 16 hours: Off, 0:30, 1:00, 2:00, 4:00, 8:00, 12:00, 16:00.**
- 2. Select "Set" and press the ENTER button on the remote control.**
- 3. The remaining time starts counting down.**
- 4. The projector will turn off after the countdown is complete.**

NOTE:

- To cancel the preset time, set "Off" for the preset time or turn off the power.*
 - When the remaining time reaches 3 minutes before the projector is turned off, the "Projector will turn off in 3 minutes" message will be displayed on the bottom of the screen.*
-

Using Capture

Allows you to capture an image from a source that is currently being displayed. The image is saved as JPEG in the PC card. When you select Capture from the menu, you will get a tool bar. You can capture an image directly using the tool bar when the menu is not displayed.

See page E-69.

Using PC Card Files

The PC Card Files feature allows you to display a list of all the files stored in the PC card so that you can select a file you want to display. You can also sort files by file name or date, or display the file. See page E-59.

Changing Background Logo:

You can change the default background logo using the PC Card Files feature.

NOTE: File size must be 256KB or less. Other file formats than JPEG and BMP are not available. See page E-59.

Using ChalkBoard

The ChalkBoard feature allows you to write and draw messages on a projected image. See page E-61

NOTE: This feature is available only when using with USB mouse. See page E-58.

Help

Contents

Provides an online help about how to use the menus. An underlined link means that you can move to an adjustment item directly.

Selecting the underlined link and pressing ENTER moves to the corresponding adjustment item.

Information

Displays the status of the current signal, and the lamp and the projector usage hours. This dialog box has three pages.

The information included are as follows:

[Page 1]	[Page 2]	[Page 3]
Source Name	Signal Type	Remaining Lamp Time (%)
Input Terminal	Video Type	Lamp Hour Meter (H)
Entry No.	Sync Type	Projector Usage (H)
Horizontal Frequency	Interlace	
Vertical Frequency		
Sync Polarity		

NOTE: The progress indicator shows the percentage of remaining bulb life. The value informs you of the amount of lamp and projector usage respectively.

Remaining Lamp Time Display:

When the remaining lamp time reaches 0, the Remaining Lamp Time bar indicator changes from 0% to 100 Hours and starts counting down.

If the remaining lamp time reaches 0 hours, the projector will not turn on regardless of whether the lamp mode is set to Normal or Eco.

Returning to Factory Default

The Factory Default feature allows you to change adjustments and setting to the factory preset for source except the following:

All Data Reset all the adjustments and settings for all the signals to the factory preset except Remaining Lamp Time, Lamp Hour Meter, Projector Usage, Language, Background, Entry List, Communication Speed, Security and Passcode. (To reset the lamp usage time, see "Clear Lamp Hour Meter" on page E-100)

Current Signal . Resets the adjustments for the current signal to the factory preset levels.

All the items in "Picture", "Volume", "Image Options" and "Picture Management" can be reset.

MAINTENANCE

This section describes the simple maintenance procedures you should follow to replace the lamp, and to clean the cabinet and the lens.

Replacing the Lamp

After your lamp has been operating for 1500 hours (up to 2000 hours : Eco mode) or longer, the "Lamp" indicator in the cabinet will blink red and the message will appear. Even though the lamp may still be working, replace it at 1500 hours (up to 2000 hours : Eco mode) to maintain optimal projector performance.

CAUTION

- DO NOT TOUCH THE LAMP immediately after it has been used. It will be extremely hot. Turn the projector off, wait 90 seconds, turn off the main power switch, and then disconnect the power cable. Allow at least one hour for the lamp to cool before handling.
- DO NOT REMOVE ANY SCREWS except the lamp cover screw and two lamp case screws. You could receive an electric shock.
- The projector will turn off and go into stand by mode after 1600 hours (up to 2100 hours : Eco mode) of service. If this happens, be sure to replace the lamp. If you continue to use the lamp after 1500 hours (up to 2000 hours : Eco mode) of use, the lamp bulb may shatter, and pieces of glass may be scattered in the lamp housing. Do not touch them as the pieces of glass may cause injury.

If this happens, contact your NEC dealer for lamp replacement.

To replace the lamp:

1. Loosen the lamp cover screw until the screwdriver goes into a freewheeling condition and remove the lamp cover. The lamp cover screw is not removable.

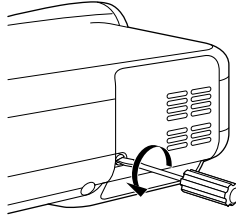

2. Loosen the two screws securing the lamp housing until the screwdriver goes into a freewheeling condition. The two screws are not removable.

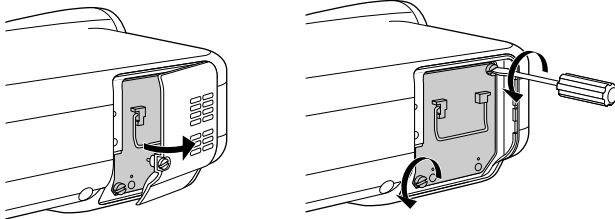

3. Remove the lamp housing by pulling out the handle.

NOTE: There is an interlock on this case to prevent the risk of electrical shock. Do not attempt to circumvent this interlock.

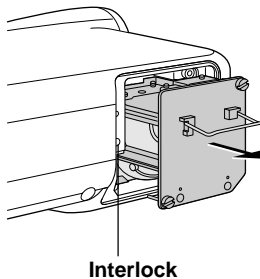

MAINTENANCE

4. Insert a new lamp housing until the lamp housing is plugged into the socket.

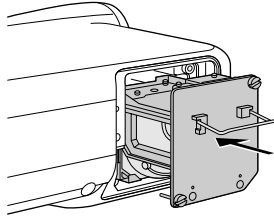

CAUTION

Do not use a lamp other than the NEC replacement lamp (LT60LP).

5. Secure it in place with the two screws.

Be sure to tighten the screws.

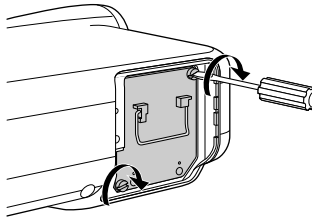

6. Reattach the lamp cover.

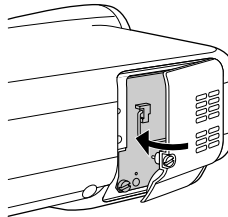

7. Tighten the lamp cover screw.

Be sure to tighten the screw.

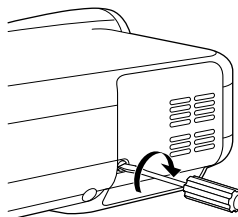

MAINTENANCE

8. After you install a new lamp, from the menu select [Projector Options] → [Setup] → [Page 4] → [Clear Lamp Hour Meter] to reset the lamp usage hours.

If the projector will not be turned on after using 1600 hours (up to 2100 hours : Eco mode) of service, press and hold the [Help] button on the remote control for ten seconds or longer to reset the lamp time clock to zero.

Cleaning

Cleaning the Cabinet and the Lens

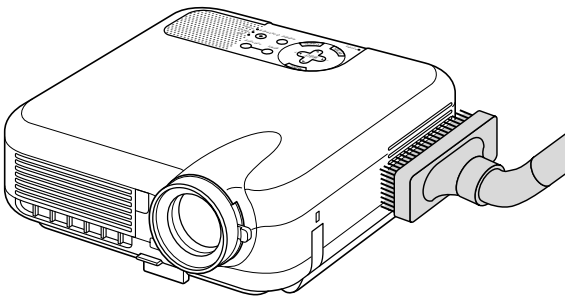

1. Turn off the projector before cleaning.
2. Clean the cabinet periodically with a damp cloth. If heavily soiled, use a mild detergent. Never use strong detergents or solvents such as alcohol or thinner.
3. Use a blower or lens paper to clean the lens, and be careful not to scratch or mar the lens.

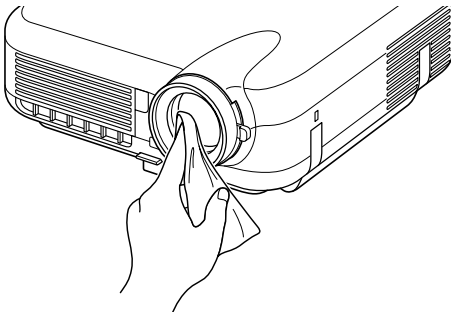

MAINTENANCE

Lens Protector

The lens barrel has threads on the outside for mounting a commercially available lens protector (ϕ 62mm for LT260/LT220 and ϕ 72mm for LT240) to protect the lens from dirt, dust, scratches and damage. Note that both a lens protector and the supplied lens cap cannot be used at the same time.

CAUTION: Use only transparent lens protectors designed for lens protection. Use of filters for light reduction and special effects, such as ND (Neutral Density) filters and color filters, can absorb heat, resulting in damage to the filter and the projector.

TROUBLESHOOTING

This section helps you resolve problems you may encounter while setting up or using the projector.

Power Indicator

Indicator Condition			Projector Condition	Note
Off			The main power is off	–
Blinking light	Green blinking	0.5 sec ON, 0.5 sec OFF	The projector is getting ready to turn on.	Wait for a moment.
	Green blinking	2.5 sec ON, 0.5 sec OFF	The projector is in Sleep mode.	–
	Orange blinking	0.5 sec ON, 0.5 sec OFF	The projector is cooling down.	Wait for a moment.
Steady light	Green		The projector is turned on.	–
	Orange		The projector is in Standby or Idle.	–

Status Indicator

Indicator Condition			Projector Condition	Note
Off			Normal	–
Blinking light	Red blinking	1 cycle (0.5 sec ON, 2.5 sec OFF)	Lamp cover error	Replace the lamp cover correctly.
		2 cycle (0.5 sec ON, 0.5 sec OFF)	Temperature error	The projector is overheated. Move the projector to a cooler location.
		3 cycle (0.5 sec ON, 0.5 sec OFF)	Power error	Power unit will not work correctly.
		4 cycle (0.5 sec ON, 0.5 sec OFF)	Fan error	Fans will not work correctly.
		6 cycle (0.5 sec ON, 0.5 sec OFF)	Lamp error	Lamp fails to light. Wait a full minute and then turn on again.
	Green blinking	Re-firing the lamp	The projector is re-firing 3 times at an interval of 15 sec.	
Steady light	Orange		Control key locked	You have pressed control panel key when Control Key Lock is enabled.
	Green		Idle condition	–

TROUBLESHOOTING

Lamp Indicator

Indicator Condition		Projector Condition	Note
Off		Normal	–
Blinking light	Red	Lamp has reached its end of life. Lamp replacement message will be displayed.	Replace the lamp.
Steady light	Red	Lamp has been used beyond its limit. The projector will not turn on until the lamp is replaced.	Replace the lamp.
	Green	Lamp mode is set to Eco mode	–

TROUBLESHOOTING

Common Problems & Solutions

Problem	Check These Items
Does not turn on	<ul style="list-style-type: none">• Check that the power cable is plugged in and that the power button on the projector cabinet or the remote control is on. See pages E-36 and 37.• Ensure that the lamp cover is installed correctly. See page E-120.• Check to see if the projector has overheated or the lamp usage exceeds 1600 hours (up to 2100 hours : Eco mode). If there is insufficient ventilation around the projector or if the room where you're presenting is particularly warm, move the projector to a cooler location.
No picture	<ul style="list-style-type: none">• Use the menu to select your source (RGB 1/2, Video, S-Video, Viewer or LAN). See page E-40.• Ensure your cables are connected properly.• Use menus to adjust the brightness and contrast. See page E-85.• Remove the lens cap.• Reset the settings or adjustments to factory preset levels using the Factory Default in the Adjustment Menu. See page E-117.
Image isn't square to the screen	<ul style="list-style-type: none">• Reposition the projector to improve its angle to the screen. See page E-42 or 43.• Use the 3DReform function to correct the trapezoid distortion. See page E-45.
Picture is blurred	<ul style="list-style-type: none">• Adjust the focus. See page E-44.• Reposition the projector to improve its angle to the screen. See page E-42 or 43.• Ensure that the distance between the projector and screen is within the adjustment range of the lens. See page E-22-26.• Condensation may form on the lens if the projector is cold, brought into a warm place and is then turned on. Should this happen, let the projector stand until there is no condensation on the lens.
Image is scrolling vertically, horizontally or both	<ul style="list-style-type: none">• Use menus or Source button on the remote control or the cabinet to select the source you want to input.
Remote control does not work	<ul style="list-style-type: none">• Install new batteries. See page E-19.• Make sure there are no obstacles between you and the projector.• Stand within 22 feet (7 m) of the projector. See page E-20.• Make sure that you are in the Projector mode and the PJ button lights in red. If not, press the PJ button. See page E-53.
Indicator is lit or blinking	<ul style="list-style-type: none">• See the Status Indicator on pages E-123 and 124.
Cross color in RGB mode	<ul style="list-style-type: none">• If Auto Adjust is off, turn it on or adjust the image manually with the Position/Clock in the Image Options. See pages E-87, 88 and 98.
USB mouse does not work	<ul style="list-style-type: none">• Make sure that your USB mouse is properly connected to the projector. The projector may not support some brands of a USB mouse.

TROUBLESHOOTING

When using the Viewer function

Problem	Check These Items
No picture	<ul style="list-style-type: none">• Is "Viewer" selected from the Source menu?• Is the PC card seated in the PC Card slot completely?• Are slide data stored in the PC card?• Have the contents of the PC card been destroyed?
Part of a slide is not displayed	<ul style="list-style-type: none">• While an image with over 1024 × 768 dots (800 × 600 on LT220) is projected, several lines of information will be lost. Use the supplied software change the image to 1024 × 768 (800 × 600 on LT220) dots in size.
Contents of PC Card are damaged	<ul style="list-style-type: none">• Use a computer, etc., to repair the data.

For more information contact your dealer.

SPECIFICATIONS

This section provides technical information about the LT260/LT240/LT220 Projector's performance

Model Number

LT260/LT240/LT220

Optical

DMD™	Single Chip Digital Micromirror Device(DMD™)
Resolution	1024×768 pixels (LT220 : 800×600 pixels) up to UXGA with Advanced AccuBlend
Lens	Manual zoom and focus: LT260/LT220 : F2.2 - 2.5 f=28.4mm - 34.0mm LT240 : F2.5 - 2.8 f=22.4mm - 27.0mm
Lamp	220 W DC standard (The lamp is warranted for 1500 hours of operation time within 6 months.)
Image Size	30 inches - 500 inches (0.8 m - 12.7 m) diagonal
Projection Distance	LT260 : 3.8ft - 80.7ft / 1.18m - 24.6m LT240 : 2.95ft - 62.3ft / 0.90m - 19.0m LT220 : 4.0ft - 83.3ft / 1.22m - 25.4m
Projection Angle	LT260/LT220 : 14.7°-15.2°(wide) / 12.2°-12.4°(tele) LT240 : 18.6°-19.4°(wide) / 15.7°-16.2°(tele)

Electrical

Inputs	2 RGB, 1 S-Video, 1 Video, 1 PC Card, 1 Stereo Mini Audio, 1 (L/R) RCA Audio, 1 PC Control
Outputs	1 RGB, 1 Stereo Mini Audio
USB Port	1 A Type, 1 B Type
Video Compatibility	NTSC, NTSC4.43, PAL, PAL-60, PAL-N, PAL-M, SECAM, HDTV:1080i, 720p, 480p, 480i (w/optional cable)
Scan Rate	Horizontal: 15 kHz to 100 kHz (RGB: 24 kHz or over) Vertical: 50 Hz to 120 Hz
Video Bandwidth	RGB: 100 MHz (-3dB)
Pixel Clock Freq	Less than 135 MHz
Color Reproduction	16.7 million colors simultaneously, Full color
Horizontal Resolution	NTSC / NTSC4.43/PAL / YCbCr: 540 TV lines SECAM: 300 TV lines RGB: LT260/LT240 : 1024 dots (H)×768 dots (V), LT220 : 800 dots (H)×600 dots (V)

SPECIFICATIONS

External Control	RS232, IR, LAN (optional)
Sync Compatibility	Separate Sync / Composite Sync / Sync on G
Built-in Speakers	2W × 1 (monaural)
Power Requirement	100 - 120V AC / 200 - 240V AC, 50 / 60 Hz
Input Current	3.0A (100 - 120V AC) / 1.5A (200 - 240V AC)
Power Consumption	280W (0.6W at Standby)

Mechanical

Installation	Orientation: Floor/Front, Floor/Rear, Ceiling/Front, Ceiling/Rear
Dimensions	10.2" (W) × 3.6" (H) × 10.8" (D) 260mm (W) × 92mm (H) × 275mm (D) (not including protrusions)
Net Weight	LT260/LT220: 6.5 lbs / 2.9 kg LT240: 7.1 lbs / 3.2 kg
Environmental Considerations	
Operational Temperatures :	41° to 95°F (5° to 35°C), 20% to 80% humidity (non-condensing)
Storage Temperatures :	14° to 122°F (-10° to 50°C), 20% to 80% humidity (non-condensing)
Regulations	UL Approved (UL 1950, CSA 950) Meets DOC Canada Class B requirements Meets FCC Class B requirements Meets AS/NZS3548 Class B Meets EMC Directive (EN55022:1998, EN55024-1998, EN61000-3-2, EN61000-3-3) Meets Low Voltage Directive (EN60950, TUV GS Approved) CE

For additional information visit:

US : <http://www.necvisualsystems.com>

Europe : <http://www.nec-europe.com/>

Global : <http://www.nec-pj.com/>

Digital Light Processing, DLP, Digital Micromirror Device and DMD are trademarks of Texas Instruments.

The specifications are subject to change without notice.

APPENDIX

Cabinet Dimensions

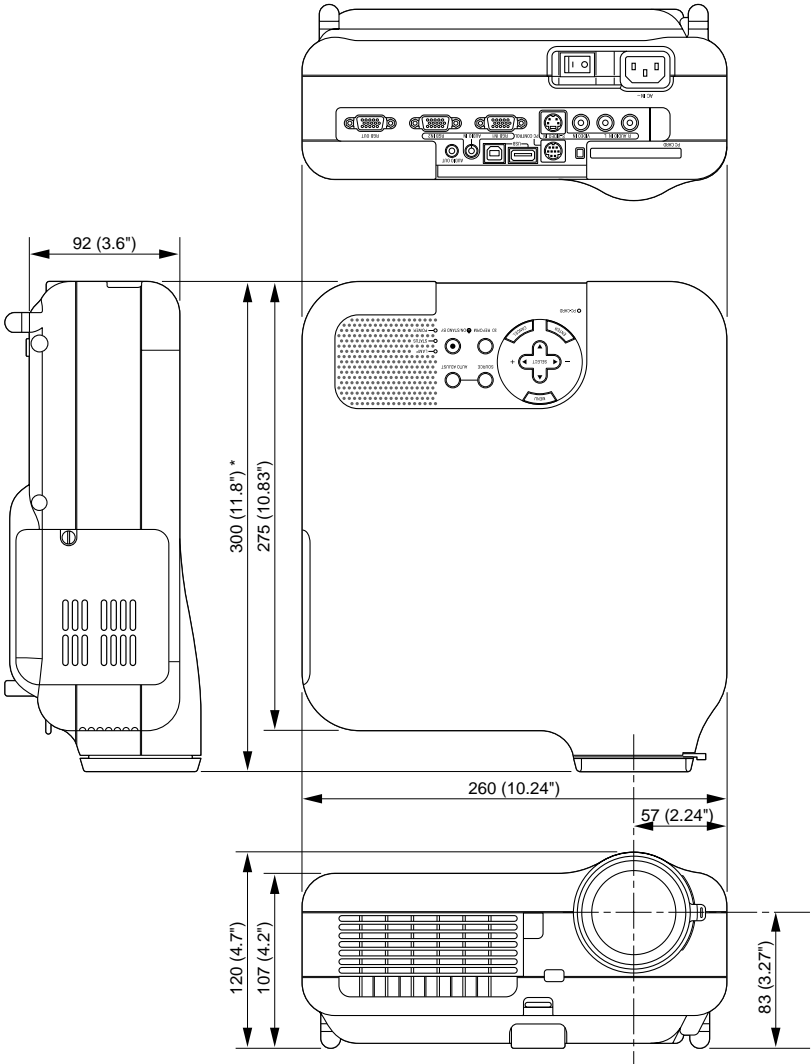

* LT240: 319mm (12.56")

Unit = mm (inch)

Pin Assignments of D-Sub RGB Input Connector

Mini D-Sub 15 Pin Connector

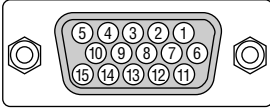

Signal Level

Video signal : 0.7Vp-p (Analog)

Sync signal : TTL level

* RGB 1 Input only

Pin No.	RGB Signal (Analog)	YCbCr Signal
1	Red	Cr
2	Green or Sync on Green	Y
3	Blue	Cb
4	Ground	
5	Ground	
6	Red Ground	Cr Ground
7	Green Ground	Y Ground
8	Blue Ground	Cb Ground
9	No Connection	
10	Sync Signal Ground	
11	Ground	
12	Bi-directional DATA (SDA)*	
13	Horizontal Sync or Composite Sync	
14	Vertical Sync	
15	Data Clock*	

Compatible Input Signal List

Signal	Resolution (Dots)	Frequency H. (kHz)	Refresh Rate (Hz)	Dot Clock (MHz)
NTSC	–	15.734	60	–
PAL	–	15.625	50	–
SECAM	–	15.625	50	–
VESA	640 × 480	31.47	59.94	25.175
IBM	640 × 480	31.47	60	25.175
MAC	640 × 480	31.47	60	25.175
MAC	640 × 480	34.97	66.67	31.334
MAC	640 × 480	35	66.67	30.24
VESA	640 × 480	37.86	72.81	31.5
VESA	640 × 480	37.5	75	31.5
IBM	640 × 480	39.375	75	31.49
VESA	640 × 480	43.269	85.01	36
IBM	720 × 350	31.469	70.09	28.322
VESA	720 × 400	37.927	85.04	35.5
IBM	720 × 350	39.44	87.85	35.5
IBM	720 × 400	39.44	87.85	35.5
VESA	800 × 600	35.16	56.25	36
VESA	800 × 600	37.879	60.32	40
VESA	800 × 600	48.077	72.19	50
VESA	800 × 600	46.88	75	49.5
VESA	800 × 600	53.674	85.06	56.25
MAC	832 × 624	49.725	74.55	57.283
@ VESA	1024 × 768	35.5	43 Interlaced	44.9
@ VESA	1024 × 768	48.363	60	65
@ VESA	1024 × 768	56.476	70.07	75
@ MAC	1024 × 768	60.241	74.93	80
@ VESA	1024 × 768	60.023	75.03	78.75
@ VESA	1024 × 768	68.677	85	94.5
#@ VESA	1152 × 864	67.5	75	108
#@ MAC	1152 × 870	68.681	75.06	100
#@ SUN	1152 × 900	61.796	65.95	92.94
#@ SGI	1152 × 900	71.736	76.05	105.6
#@ VESA	1280 × 960	60	60	108
#@ VESA	1280 × 1024	63.981	60.02	108

APPENDIX

Signal	Resolution (Dots)	Frequency H. (kHz)	Refresh Rate (Hz)	Dot Clock (MHz)
#@ MAC	1280 × 1024	69.89	65.2	118.5
#@ HP	1280 × 1024	78.125	72.01	135
#@ SUN	1280 × 1024	81.13	76.11	135
#@ VESA	1280 × 1024	79.976	75.03	135
#@ VESA	1280 × 1024	91.146	85.02	157.5
#@ HDTV (1080i)(1125i)	1920 × 1080	33.75	60 Interlace	74.25
#@ HDTV (1080i)(1125i)	1920 × 1080	28.13	50 Interlace	74.25
#@ HDTV (720p)(750p)	1280 × 720	45	60 Progressive	74.25
#@ SDTV (480p)(525p)	–	31.47	59.94 Progressive	27
#@ VESA	1600 × 1200	75.0	60	162
#@ VESA	1600 × 1200	81.3	65	175.5
#@ VESA	1600 × 1200	87.5	70	189
#@ VESA	1600 × 1200	93.75	75	202.5
DVD YCbCr	–	15.734	59.94 Interlaced	–
DVD YCbCr	–	15.625	50 Interlaced	–

#:Images in above flagged with # are compressed with Advanced AccuBlend on LT260 and LT240.

@:Images in above flagged with @ are compressed with Advanced AccuBlend on LT220.

NOTE: Some composite sync signals may not be displayed correctly.

Signals other than those specified in the table above may not be displayed correctly. If this should happen, change the refresh rate or resolution on your PC. Refer to Display Properties help section of your PC for procedures.

UXGA (1600 × 1200) is supported for separate sync signal only.

PC Control Codes and Cable Connection

PC Control Codes

Function	Code Data								
POWER ON	02H	00H	00H	00H	00H	02H			
POWER OFF	02H	01H	00H	00H	00H	03H			
INPUT SELECT RGB 1	02H	03H	00H	00H	02H	01H	01H	09H	
INPUT SELECT RGB 2	02H	03H	00H	00H	02H	01H	02H	0AH	
INPUT SELECT VIDEO	02H	03H	00H	00H	02H	01H	06H	0EH	
INPUT SELECT S-VIDEO	02H	03H	00H	00H	02H	01H	0BH	13H	
INPUT SELECT VIEWER	02H	03H	00H	00H	02H	01H	1FH	27H	
PICTURE MUTE ON	02H	10H	00H	00H	00H	12H			
PICTURE MUTE OFF	02H	11H	00H	00H	00H	13H			
SOUND MUTE ON	02H	12H	00H	00H	00H	14H			
SOUND MUTE OFF	02H	13H	00H	00H	00H	15H			
ON SCREEN MUTE ON	02H	14H	00H	00H	00H	16H			
ON SCREEN MUTE OFF	02H	15H	00H	00H	00H	17H			

NOTE: Contact your local dealer for a full list of PC Control Codes if needed.

Cable Connection

Communication Protocol

Baud rate : 38400 bps

Data length : 8 bits

Parity : No parity

Stop bit : One bit

X on/off : None

Communications procedure : Full duplex

NOTE: Depending on the equipment, a lower baud rate may be recommended for long cable runs.

PC Control Connector (DIN-8P)

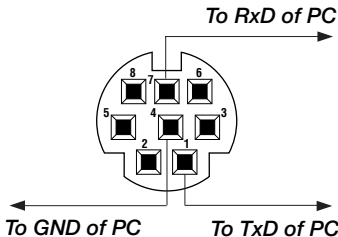

NOTE: Pins 2, 3, 5, 6 and 8 are used inside the projector.

Using Software Keyboard

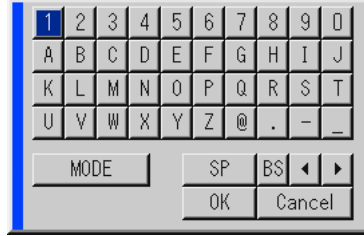

- 1 to 0 and Characters Use to type in IP address or projector name
- SP Inserts a space
- BS Deletes one character backward
- ◀ Returns to the previous
- ▶ Advances to the next
- OK Executes the selection
- Cancel Cancels the selection
- Drag bar Use to move the software keyboard on the screen.
- MODE Selects one of three modes for alphabet and special characters.

Operation Using an HTTP Browser

Overview

The use of HTTP server functions will allow control of the projector from a web browser without the installation of special software. Please be sure to use “Microsoft Internet Explorer 4.x” or a higher version for the web browser. (This device uses “JavaScript” and “Cookies” and the browser should be set to accept these functions. The setting method will vary depending on the version of browser. Please refer to the help files and the other information provided in your software.)

NOTE:

- * *The use of HTTP server functions is not available during Standby mode.*
- * *The display’s or button’s response can be slowed down or operation may not be accepted depending the settings of your network. Should this happen, consult your network administrator.*
- * *The projector may not respond if its buttons are repeatedly pressed in rapid intervals. Should this happen, wait a moment and repeat. If you still can’t get any response, pull out and then re-insert the LAN card.*

*Access is gained to the HTTP server functions by specifying
http:// <the projector’s IP address> /index.html
in the entry column of the URL.*

Preparation Before Use

Make network connections and set up the projector and confirm that it is complete before engaging in browser operations. (See “Setting LAN Mode” on page E-102.)

Operation with a browser that uses a proxy server may not be possible depending on the type of proxy server and the setting method. Although the type of proxy server will be a factor, it is possible that items that have actually been set will not be displayed depending on the effectiveness of the cache, and the contents set from the browser may not be reflected in operation. It is recommended that a proxy server not be used unless it is unavoidable.

Handling of the Address for Operation via a Browser

Regarding the actual address that is entered for the address or entered to the URL column when operation of the projector is via a browser, the host name can be used as it is when the host name corresponding to the IP address of the projector has been registered to the domain name server by a network administrator, or the host name corresponding to the IP address of the projector has been set in the “HOSTS” file of the computer being used.

- Example 1: When the host name of the projector has been set to “pj.nec.co.jp”,
`http://pj.nec.co.jp/index.html`
is specified for the address or the entry column of the URL.
- Example 2: When the IP address of the projector is “192.168.73.1”,
access is gained to the
HTTP server functions by specifying
`http://192.168.73.1/index.html`
for the address or the entry column of the URL.

Structure of the HTTP Server

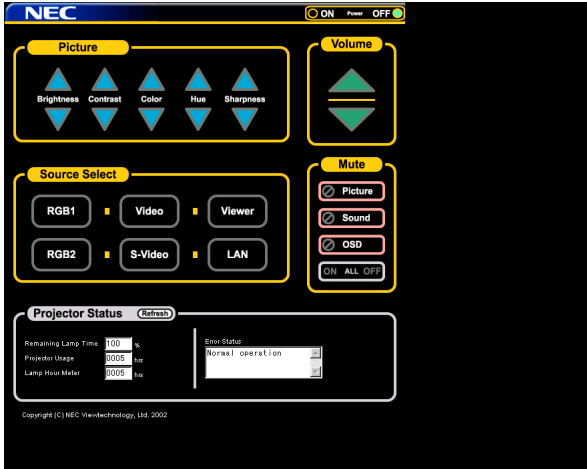

Power: This controls the power of the projector.

On Power is switched on.

Off Power is switched off.

Volume: This controls the volume of the projector.

▲ Increments the volume adjustment value.

▼ Decrements the volume adjustment value.

Mute: This controls the mute function of the projector.

All On Mutes each of the video, audio, and on-screen display functions.

All Off Cancels the muting of each of the video, audio, and on-screen display functions.

Picture On Mutes the video.

Picture Off Cancels the video muting.

Sound On Mutes the audio.

Sound Off Cancels the audio muting.

OSD On Mutes the on-screen display.

OSD Off Cancels the muting of the on-screen display.

APPENDIX

Picture: Controls the video adjustment of the projector.

Brightness ▲ ... Increments the brightness adjustment value.

Brightness ▼ ... Decrements the brightness adjustment value.

Contrast ▲ Increments the contrast adjustment value.

Contrast ▼ Decrements the contrast adjustment value.

Color ▲ Increments the color adjustment value.

Color ▼ Decrements the color adjustment value.

Hue ▲ Increments the hue adjustment value.

Hue ▼ Decrements the hue adjustment value.

Sharpness ▲ ... Increments the sharpness adjustment value.

Sharpness ▼ ... Decrements the sharpness adjustment value.

* The functions that can be controlled will vary depending on the signal being input to the projector.

Source Select: This switches the input connector of the projector.

RGB1 Switches to the RGB 1 connector.

RGB2 Switches to the RGB 2 connector.

Video Switches to the Video connector.

S-Video Switches to the S-Video connector.

Viewer Switches to the Viewer.

LAN Switches to a LAN signal.

Projector Status: This displays the condition of the projector.

Remaining Lamp Time ... Displays the remaining life of the lamp as a percentage.

Lamp Hour Meter Displays how many hours the lamp has been used.

Projector Usage Displays how many hours the projector has been used.

Error Status Displays the status of errors occurring within the projector.

Refresh Updates the display of the following conditions.

TravelCare Guide

TravelCare - a service for international travelers

This product is eligible for "TravelCare", NEC's unique international warranty.

Please note that TravelCare coverage differs in part from coverage under the warranty included with the product.

Services offered with TravelCare

This warranty allows customers to receive service on their product at the NEC and NEC-designated service stations in the countries listed herein when temporarily traveling internationally for business or pleasure.

For details on services offered by the different service stations, please refer to the "List of TravelCare Outlets" below.

1 Repair services

The product will be repaired and delivered within 10 business days, not including shipping time.

During the term of warranty, the cost of maintenance parts, labor costs for repairs and shipping costs within the service station's coverage area are covered by the warranty.

2 Replacement product rental service

If the customer desires, he or she can rent a replacement product while the original product is being repaired.

Fee: US\$200 for 12 days

This fee must be paid at the local service station in cash or credit card. The \$200 rental fee is non-refundable even if the customer rents it less than 12 days before returning.

The replacement product will be delivered within 3 business days.

If the customer did not return the replacement product within 12 days, the customer will be charged the price of the unit.

If the customer returned the replacement product in a faulty or damaged condition, the repair cost will be charged to the customer.

Note that this service is not offered in all countries and regions. Please refer to the "List of TravelCare Outlets".

In addition, this replacement product rental service is not offered after the product's warranty has expired.

Term of warranty

- 1 a. Upon presentation of the warranty or receipt received upon purchase:
Valid for the term indicated on the warranty or the normal term of warranty for the country of purchase.
- b. When only the product is brought in:
Valid for a period of within 14 months of the date of manufacture indicated by the serial number attached to the product.

- 2 When a product whose term of warranty is expired is brought in:
Repairs will be offered for a fee. In this case the customer is not eligible for the replacement product rental service.

- 3 In the following cases, repairs may be charged, even if the product's warranty is still in effect:
 - 1) If the term of warranty, model name, serial number and name of the store of purchase are not indicated on the warranty or have been altered.
 - 2) Problems or damage caused by dropping or shocks during shipment or movement by the customer or by improper handling by the customers.
 - 3) Problems or damage caused by improper usage or unwarrantable alterations or repairs by the customer.
 - 4) Problems or damage caused by fire, salt damage, gas damage, earthquakes, lightning damage, storm or flood damage or other natural disasters or such external factors as dust, cigarette smoke, abnormal voltage, etc.
 - 5) Problems or damage caused by use in hot or humid places, in vehicles, boats or ships, etc.
 - 6) Problems or damage caused by expendable supplies or devices connected to the product other than those designated by NEC.

APPENDIX

- 7) Problems caused by natural consumption, wear or deterioration of parts under normal usage conditions.
- 8) Problems or damage to lamps and other expendable supplies, included parts or optional parts.
- 9) Other conditions stipulated in the warranty included with the product also apply.



The product can be used overseas with voltages of 100 to 120V and 200 to 240V by using a power cable suited for the standards and power source voltage of the country in which the product is being used.

List of TravelCare Outlets

This list applies as of June 1, 2002.

For the most up-to-date information, please refer to the websites of the service stations in the various countries on the List of TravelCare Outlets or to the NEC website at <http://www.nec-pj.com>.

List of TravelCare Outlets

In Europe

NEC Europe, Ltd. / European Technical Centre

Address: Unit G, Stafford Park 12, Telford TF3 3BJ, U.K.

Telephone: +44 1952 237000

Fax Line: +44 1952 237006

Email Address: AFR@uk.neceur.com

WEB Address: <http://www.neceur.com>

(Regions Covered)

EU: Austria*, Belgium*, Denmark*, Finland*, France*, Germany*, Greece*, Ireland*, Italy*, Luxembourg*, The Netherlands*, Portugal*, Spain*, Sweden* and the United Kingdom*

EEA: Norway*, Iceland and Liechtenstein

APPENDIX

In North America

NEC Solutions (America), Inc.

Address: 1250 Arlington Heights Road, Itasca,
Illinois 60143, U.S.A.

Telephone: +1 800 836 0655

Fax Line: +1 800 356 2415

Email Address: vsd-tech-support@necsam.com

WEB Address: <http://www.necvisualsystems.com>

(Regions Covered)

U.S.A. *, Canada*

In Oceania

NEC Australia Pty., Ltd.

Address: New South Wales;
184 Milperra Road, Reversby 2212
Victoria;
480 Princess Hwy Noble Park 3174
South Australia;
84A Richmond Road, Keswick 5035
Queensland;
116 Ipswich Road, Woollongabba 4102
Western Australia;
45 Sarich Court Osborne Park 6017

Telephone: 131 632 (from domestic)
+61 8 8375 5706 (from overseas)

Fax Line: +61 8 8375 5757

Email Address: lee.gramola@nec.com.au

WEB Address: <http://www.nec.com.au>

(Regions Covered)

Australia*, New Zealand

APPENDIX

In Asia and Middle East

NEC Viewtechnology, Ltd.

Address: 686-1, Nishioi, Oi-Machi, Ashigarakami-Gun,
Kanagawa 258-0017, Japan

Telephone: +81 465 85 2369

Fax Line: +81 465 85 2393

Email Address: support_pjweb@nevt.nec.co.jp

WEB Address: <http://www.nec-pj.com>

(Regions Covered)

Japan*

NEC Hong Kong Ltd.

Address: 11th Floor, Tower B, New Mandarin Plaza, 14 Science
Museum Road,

Tsim Sha Tsui East, Kowloon, Hong Kong

Telephone: +852 2369 0335

Fax Line: +852 2795 6618

Email Address: esmond_au@nechk.nec.com.hk

WEB Address: <http://www.nec.com.hk>

(Regions Covered)

Hong Kong

NEC Taiwan Ltd.

Address: 7F, No.167, SEC.2, Nan King East Road, Taipei,
Taiwan, R.O.C.

Telephone: +886 2 8500 1734

Fax Line: +886 2 8500 1420

Email Address: nickliao@nec.com.tw

WEB Address: <http://www.nec.com.tw>

(Regions Covered)

Taiwan

APPENDIX

NEC Singapore Pte. Ltd

Address: 401 Commonwealth Drive, #07-02, Haw Par Technocentre,
Singapore 149598

Telephone: +65 6 273 8333

Fax Line: +65 6 274 2226

Email Address: daniel@rsc.necsin.nec.com.sg

WEB Address: <http://www.nec.com.sg>

(Regions Covered)

Singapore

Hyosung Data System, Ltd.

Address: 7th Floor, Cheongdam Building, 52, Cheongdam-Dong,
Kangnam-Ku, Seoul, Korea 135-100

Telephone: +82 2 510 0234

Fax Line: +82 2 540 3590

Email Address: hds-ykc@hyosung.com

(Regions Covered)

South Korea

Lenso Communication Co., Ltd.

Address: 292 Lenso House 4, 1st Floor, Srinakarin Road,
Huamark, Bangkok, Bangkok 10240, Thailand

Telephone: +66 2 375 2425

Fax Line: +66 2 375 2434

Email Address: pattara@lenso.com

WEB Address: <http://www.lenso.com>

(Regions Covered)

Thailand

APPENDIX

ABBA Electronics L.L.C.

Address: Tariq Bin Ziyad Road, P.O.Box 327, Dubai,
United Arab Emirates

Telephone: +971 4 371800

Fax Line: +971 4 364283

Email Address: ABBA@emirates.net.ae

(Regions Covered)

United Arab Emirates

Samir Photographic Supplies

Address: P.O.Box 599, Jeddah 21421, Saudi Arabia

Telephone: +966 2 6828219

Fax Line: +966 2 6830820

Email Address: vartkes@samir-photo.com

(Regions Covered)

Saudi Arabia



In countries designated with an asterisk(), replacement product rental service are offered.*

Date: / / ,

P-1/ ,

TO: NEC or NEC's Authorized Service Station:

FM:

(Company & Name with signature)

Dear Sir (s),

I would like to apply your TravelCare Service Program based on attached registration and qualification sheet and agree with your following conditions, and also the Service fee will be charged to my credit card account, if I don't return the Loan units within the specified period. I also confirm following information is correct. Regards.

Application Sheet for TravelCare Service Program

Country, product purchased :	
User's Company Name :	
User's Company Address : Phone No., Fax NO. :	
User's Name :	
User's Name Address :	
Phone No., Fax NO. :	
Local Contact office :	
Local Contact office Address :	
Phone No., Fax NO. :	
User's Model Name :	
Date of Purchase :	
Serial No. on rear panel :	
P Problem of units per User :	
Required Service :	(1) Repair and Return (2) Loan unit
Requested period of Loan unit :	
Payment method :	(1) Credit Card (2) Travelers Cheque, (3) Cash
In Case of Credit Card : Card No. w/Valid Date :	

Condition of your TravelCare Service Program

Enduser is requested to understand following condition of TravelCare Service Program and fill necessary information into the application sheet.

1. Service Options:

There are 3 types of "Service" available. Enduser has to understand following condition and is required to fill in the Application Sheet.

1) Repair and Return:

The 'Faulty unit' is sent or collected from the customer. It is repaired and returned within 10 days to the customer, excluding transport time. There may have a case, repair and return can't be done by NEC Authorized Service Station, because of shortage of spare parts due to same model is not sold in the territory.

2) Repair and Return with Loan: (This service is limited to some Service Stations)

This service is offered to the Enduser, who cannot wait until their unit is repaired.

The customer can borrow a unit for \$200 up to 12 days. Customer then sends in inoperable unit to nearest NEC Authorized Service Station for service. In order to prevent collection problem, Enduser is required to fill in Application Sheet.

Enduser needs to confirm the availability of the Service to NEC Authorized Service Stations.

3) Loan Only:

For this service, NEC Authorized Service Station supplies the customer with a loan unit for US\$200 up to 12 days. Customer keeps the inoperable unit and when customer returns home, customer arranges to have the projector serviced in the home country.

2. Warranty Exclusions:

This program does not apply if the Projector's serial number has been defaced, modified or removed.

If, in the judgement of NEC Authorized Service Station or its agent the defects or failures result from any cause other than fair wear and tear or NEC neglect, or fault including the following without limitation:

- 1) Accidents, transportation, neglect, misuse, abuse, water, dust, smoke or default of or by the Customer its employees or agents or any third party;
- 2) Failure or fluctuation of electrical power, electrical circuitry, air conditioning, humidity control or other environmental conditions such as use it in smoking area;
- 3) Any fault in the attachments or associated products or components (whether or not supplied by NEC or its agents which do not form part of the Product covered by this warranty);
- 4) Any act of God, fire, flood, war, act of violence or any similar occurrence;
- 5) Any attempt by any person other than any person authorized by NEC to adjust, modify, repair, install or service the product.
- 6) Any Cross-border charges such as, duty, insurance, tax etc.

3. Charges for Warranty Exclusions and Out of Warranty Case:

In case faulty unit is under warranty exclusions case or under Out of Warranty period, NEC Authorized Service Station will Inform estimation of actual service cost to the Enduser with reason.

4. Dead on Arrival (DOA):

Enduser must take this issue up with their original supplier in the country of purchase.

NEC Authorized Service Station will repair the DOA unit as a Warranty repair, but will not exchange DOA unit with new units.

APPENDIX

5. Loan Service Charges and Conditions:

Upon acceptance of this NEC Projector, Customer agrees to assume liability for this loan unit.

The current cost of use of this loan unit is \$200.00 USD for 12 calendar days.

If Customer does not return the unit within the 12 calendar days, Customer will be charged the next highest cost up to and including the full list price to Credit Cards, which price will be informed by NEC Authorized Service Stations. Please see the attached listing of contacts for each country to arrange for pickup of the loan unit.

If you return to their country of origin with the loan unit, you will be charged additional freight to return the unit to the loaning country.

Thank you for your understanding of this program.

LIMITED WARRANTY (USA and Canada only)

NEC SOLUTIONS' PROJECTOR PRODUCTS

NEC Solutions (America), Inc. (hereafter NEC Solutions) warrants this product to be free from defects in material and workmanship under the following terms.

HOW LONG IS THE WARRANTY

NEC Solutions' LT260, LT240 and LT220 projectors are covered by a three (3) year limited parts and labor warranty from the date of the first customer purchase. The lamp when used under normal operating conditions is warranted for 1000 hours or six months, whichever comes first.

WHO IS PROTECTED

This warranty may be enforced only by the first purchaser, and is not transferable.

WHAT IS COVERED AND WHAT IS NOT COVERED

Except as specified below, this warranty covers all defects in material or workmanship in this product.

NEC SOLUTIONS' LIABILITY FOR ANY DEFECTIVE PRODUCT IS LIMITED TO THE REPAIR OR REPLACEMENT OF THE PRODUCT AT NEC SOLUTIONS' OPTION. REPLACEMENT PRODUCTS MAY BE NEW OR 'LIKE NEW'. The following are not covered by the limited warranty and NEC Solutions shall not be liable for:

1. Any product which is not distributed in the U.S.A. or Canada by NEC Solutions or which is not purchased, installed, and operated in the U.S.A or Canada.
2. Any product on which the serial number has been defaced, modified or removed.
3. Normal decrease in lamp light output over time.
4. Damage, deterioration or malfunction resulting from:
 - a. Accident, misuse, abuse, neglect, improper ventilation, fire, dust, smoke, water, lightning or other acts of nature, unauthorized product modification, or failure to follow instructions supplied with the product.
 - b. Repair or attempted repair by anyone other than a NEC Solutions authorized service center.
 - c. Any shipment of the product (claims must be presented to the carrier).
 - d. Removal or installation of the product.
 - e. Any other cause which does not relate to a product defect.
 - f. Use of the product beyond normal operating conditions. Normal operating conditions are defined as product use not in excess of 8 hours per day and 260 days per year.
5. Cartons, carrying cases, shipping cases, batteries, external cabinets, magnetic tapes, or any accessories used in connection with the product.
6. Service required as a result of third party components.

WHAT NEC SOLUTIONS WILL PAY FOR

NEC Solutions will pay labor and material expenses for covered items, but NEC Solutions will not pay for the following:

1. Removal or installation charges.
2. Costs of technical adjustments, set-up, maintenance, or adjustment of user controls.
3. Payment of shipping and related charges incurred in returning the product for warranty repair.

HOW YOU CAN GET WARRANTY SERVICE

1. To obtain service on your product, consult the dealer from whom you purchased the product.
2. Whenever warranty service is required, the original dated invoice (or a copy) must be presented as proof of warranty coverage. In order to obtain warranty service, you may be required to describe and demonstrate the problem to your dealer or to NEC Solutions.
3. All products returned to NEC Solutions for service MUST have prior approval. To receive approval or for the name of the nearest NEC Solutions authorized service center, call NEC Solutions at 800-836-0655.
4. It shall be your obligation and expense to ship the product, freight prepaid, or to deliver it to a NEC Solutions authorized service center, in either the original package or a similar package affording an equal degree of protection.
5. In the event a product is returned to NEC Solutions for warranty service, and it is determined that there is no product defect or that the product condition is not covered by this limited warranty, a diagnostic service fee may be charged to the customer.

LIMITATION OF IMPLIED WARRANTIES

EXCEPT AS EXPRESSLY SET FORTH IN THIS LIMITED WARRANTY, NEC SOLUTIONS MAKES NO OTHER WARRANTIES, EXPRESS OR IMPLIED, INCLUDING BUT NOT LIMITED TO ANY IMPLIED WARRANTIES OR CONDITIONS OF MERCHANTABILITY AND FITNESS FOR A PARTICULAR PURPOSE. ANY IMPLIED WARRANTIES THAT MAY BE IMPOSED BY LAW ARE LIMITED TO THE TERMS AND DURATION OF THIS LIMITED WARRANTY.

EXCLUSION OF DAMAGES

NEC SOLUTIONS' LIABILITY FOR ANY DEFECTIVE PRODUCT IS LIMITED TO THE REPAIR OR REPLACEMENT OF THE PRODUCT AT NEC SOLUTIONS' OPTION. NEC SOLUTIONS SHALL NOT BE LIABLE FOR:

1. DAMAGE TO OTHER PROPERTY CAUSED BY ANY DEFECTS IN THIS PRODUCT, DAMAGES BASED UPON INCONVENIENCE, LOSS OF USE OF THE PRODUCT, LOSS OF TIME, COMMERCIAL LOSS; OR
2. ANY OTHER DAMAGES, WHETHER INCIDENTAL, CONSEQUENTIAL OR OTHERWISE.

HOW STATE LAW RELATES TO THE WARRANTY

SOME STATES DO NOT ALLOW LIMITATIONS ON HOW LONG AN IMPLIED WARRANTY LASTS AND/OR DO NOT ALLOW THE EXCLUSION OR LIMITATION OF INCIDENTAL OR CONSEQUENTIAL DAMAGES, SO THE ABOVE LIMITATIONS AND EXCLUSIONS MAY NOT APPLY TO YOU. THIS LIMITED WARRANTY GIVES YOU SPECIFIC LEGAL RIGHTS, AND YOU MAY HAVE OTHER RIGHTS WHICH VARY FROM STATE TO STATE.

FOR MORE INFORMATION, CONTACT:

NEC SOLUTIONS (AMERICA), INC.
1250 N. Arlington Heights Road, Suite 500
Itasca, Illinois 60143-1248
TELEPHONE 800-836-0655
www.necvisualsystems.com

Customers are cautioned that product performance is affected by system configuration, software, the application, customer data, and operator control, among other factors. While NEC Solutions' products are considered to be compatible with many systems, the specific functional implementation by the customers of the product may vary. Therefore, the suitability of a product for a specific purpose or application must be determined by the customer and is not warranted by NEC Solutions.

DECLARATION OF CONFORMITY

This device complies with Part 15 of FCC Rules. Operation is subject to the following two conditions.
(1) This device may not cause harmful interference, and (2) this device must accept any interference received, including interference that may cause undesired operation.

U.S. Responsible Party:	NEC Solutions (America), Inc.
Address:	1250 N. Arlington Heights Road Itasca, Illinois 60143
Tel. No.:	(630) 467-5000

Type of Product:	Projector
Equipment Classification:	Class B Peripheral
Models:	LT260, LT240 and LT220

*We hereby declare that the equipment specified above
conforms to the technical standards as specified in the FCC Rules.*

