

***myprojectorlamps.com***

**The most trusted, dependable name  
in projector lamp sales.**



<http://www.myprojectorlamps.com>



<http://www.myprojectorlamps.ca>



<http://www.myprojectorlamps.eu>

The following projector manual has not been modified or altered in any way.



DATA PROJECTOR

MODEL

**XD60U**

User Manual



**IMPORTANT**

- \* DLP™ (Digital Light Processing) and DMD (Digital Micromirror Device) are registered trademarks of Texas Instruments Incorporated (U.S.A.).
- \* VGA and XGA are trademarks or registered trademarks of International Business Machines Corporation (U.S.A.).
- \* S-VGA is a registered trademark of Video Electronics Standards Association.
- \* Microsoft, Windows, and PowerPoint are registered trademarks of Microsoft Corporation (U.S.A. and other countries).
- \* Macintosh is a trademark of Apple Computer Inc. (U.S.A.).
- \* TMDS is a trademark of Silicon Image, Inc.

Note that even in the absence of explanatory notes, serious attention is paid to the trademarks of the various companies and to the product trademarks.

**XD60**

# IMPORTANT SAFETY INFORMATION

	<b>CAUTION</b> RISK OF ELECTRIC SHOCK DO NOT OPEN	
<b>CAUTION:</b> TO REDUCE THE RISK OF ELECTRIC SHOCK, DO NOT REMOVE COVER (OR BACK) NO USER-SERVICEABLE PARTS INSIDE REFER SERVICING TO QUALIFIED SERVICE PERSONNEL.		



The lightning flash with arrowhead symbol, within an equilateral triangle, is intended to alert the user to the presence of uninsulated “dangerous voltage” within the product’s enclosure that may be of sufficient magnitude to constitute a risk of electric shock.



The exclamation point within an equilateral triangle is intended to alert the user to the presence of important operating and maintenance (servicing) instructions in the literature accompanying the appliance.

**WARNING:**

TO PREVENT FIRE OR SHOCK HAZARD, DO NOT EXPOSE THIS APPLIANCE TO RAIN OR MOISTURE.

**CAUTION:**

TO PREVENT ELECTRIC SHOCK, DO NOT USE THIS (POLARIZED) PLUG WITH AN EXTENSION CORD, RECEPTACLE OR OTHER OUTLET UNLESS THE BLADES CAN BE FULLY INSERTED TO PREVENT BLADE EXPOSURE.

**NOTE:**

SINCE THIS PROJECTOR IS PLUGGABLE EQUIPMENT, THE SOCKET-OUTLET SHALL BE INSTALLED NEAR THE EQUIPMENT AND SHALL BE EASILY ACCESSIBLE.

**WARNING**

Use the attached specified power supply cord. If you use another power-supply cord, it may cause interference with radio and television reception.

Use the attached DVI/Mini D-Sub, Video and S-Video cable with this equipment so as to keep interference within the limit of a FCC Class B device.

This apparatus must be grounded.

**DO NOT LOOK DIRECTLY INTO THE LENS WHEN PROJECTOR IS IN THE POWER ON MODE.**

**CAUTION**

Not for use in a computer room as defined in the Standard for the Protection of Electronic Computer/Data Processing Equipment, ANSI/NFPA 75.

**When using the projector in Europe  
COMPLIANCE NOTICE**

This Projector complies with the requirements of the EC Directive 89/336/EEC “EMC Directive” as amended by Directive 92/31/EEC and 93/68/EEC and 73/23/EEC “Low Voltage Directive” as amended by Directive 93/68/EEC.

The electro-magnetic susceptibility has been chosen at a level that gains proper operation in residential areas, on business and light industrial premises and on small-scale enterprises, inside as well as outside of the buildings. All places of operation are characterised by their connection to the public low voltage power supply system.

**WARNING**

Use the attached DVI/Mini D-Sub, Video and S-Video cable with this equipment so as to keep interference within the limit of an EN55022 Class B device. Please follow WARNINGS instructions.

## IMPORTANT SAFETY INFORMATION

Please read all these instructions regarding your projector and retain them for future reference. Follow all warnings and instructions marked on the projector.

1. Read instructions  
All the safety and operating instructions should be read before the appliance is operated.
2. Retain instructions  
The safety and operating instructions should be retained for future reference.
3. Warnings  
All warnings on the appliance and in the operating instructions should be adhered to.
4. Instructions  
All operating instructions must be followed.
5. Cleaning  
Unplug this projector from the wall outlet before cleaning it. Do not use liquid aerosol cleaners. Use a damp soft cloth for cleaning.
6. Attachments and equipment  
Never add any attachments and/or equipment without the approval of the manufacturer as such additions may result in the risk of fire, electric shock or other personal injury.
7. Water and moisture  
Do not use this projector near water or in contact with water.
8. Accessories  
Do not place this projector on an unstable cart, stand, tripod, bracket or table. Use only with a cart, stand, tripod bracket, or table recommended by the manufacturer or sold with the projector. Any mounting of the appliance should follow the manufacturer's instructions and should use a mounting accessory recommended by the manufacturer.



An appliance and cart combination should be moved with care. Quick stops, excessive force and uneven surfaces may cause the appliance and cart combination to overturn.

9. Ventilation  
Slots and openings in the cabinet are provided for ventilation, ensuring reliable operation of the projector and to protect it from overheating. Do not block these openings or allow them to be blocked by placing the projector on a bed, sofa, rug, or bookcase. Ensure that there is adequate ventilation and that the manufacturer's instructions have been adhered to.

10. Power sources  
This projector should be operated only from the type of power source indicated on the marking label. If you are not sure of the type of power, please consult your appliance dealer or local power company.
11. Power-cord protection  
Power-supply cords should be routed so that they are not likely to be walked on or pinched by items placed upon or against them. Pay particular attention to cords at plugs, convenience receptacles, and points where they exit from the appliance. Do not put the power cord under a carpet.
12. Overloading  
Do not overload wall outlets and extension cords as this can result in a fire or electric shock.
13. Objects and liquids  
Never push objects of any kind through openings of this projector as they may touch dangerous voltage points or short-out parts that could result in a fire or electric shock. Never spill liquid of any kind on the projector.
14. Servicing  
Do not attempt to service this projector yourself. Refer all servicing to qualified service personnel.
15. Damage requiring service  
Unplug this projector from the wall outlet and refer servicing to qualified service personnel under the following conditions:
  - (a) If the power-supply cord or plug is damaged.
  - (b) If liquid has been spilled, or objects have fallen into the projector.
  - (c) If the projector does not operate normally after you follow the operating instructions. Adjust only those controls that are covered by the operating instructions. An improper adjustment of other controls may result in damage and may often require extensive work by a qualified technician to restore the projector to its normal operation.
  - (d) If the projector has been exposed to rain or water.
  - (e) If the projector has been dropped or the cabinet has been damaged.
  - (f) If the projector exhibits a distinct change in performance - this indicates a need for service.
16. Replacement parts  
When replacement parts are required, be sure that the service technician has used replacement parts specified by the manufacturer or parts having the same characteristics as the original part. Unauthorized substitutions may result in fire, electric shock or other hazards.
17. Safety check  
Upon completion of any service or repair to this projector, ask the service technician to perform safety checks determining that the projector is in a safe operating condition.

## IMPORTANT SAFETY INFORMATION

### **WARNING:**

#### **Unplug immediately if there is something wrong with your projector.**

Do not operate if smoke, strange noise or odor comes out of your projector. It might cause fire or electric shock. In this case, unplug immediately and contact your dealer.

#### **Never remove the cabinet.**

This projector contains high voltage circuitry. An inadvertent contact may result in an electric shock. Except as specifically explained in the Owner's Guide, do not attempt to service this product yourself. Please contact your dealer when you want to fix, adjust or inspect the projector.

#### **Do not modify this equipment.**

It can lead to fire or electric shock.

#### **If you break or drop the cabinet.**

Do not keep using this equipment if you break or drop it. Unplug the projector and contact your dealer for inspection. It may lead to fire if you keep using the equipment.

#### **Do not face the projector lens to the sun.**

It can lead to fire.

#### **Use correct voltage.**

If you use incorrect voltage, it can lead to fire.

#### **Do not place the projector on uneven surface.**

Place the projection on a leveled and stable surface only. Please do not place equipment on unstable surfaces.

#### **Do not look into the lens when it is operating.**

It may hurt your eyes. Never let children look into the lens when it is on.

#### **Do not unplug the projector during operation.**

It can lead to lamp breakage, fire, electric shock or other trouble.

#### **Do not touch Air outlet grille and Bottom plate which becomes hot.**

Do not touch them or put other equipment in front of Air outlet grille. The heated Air outlet grille and Bottom plate may cause injury or damage to other equipment. Also, do not set the projector on the desk which is easily affected by heat.

#### **Do not look into the air outlet grille when projector is operating.**

Heat, dust etc. may blow out of it and hurt your eyes.

#### **Do not block the air inlet and outlet grilles.**

If they are blocked, heat may be generated inside the projector, causing deterioration in the projector quality and fire.

#### **Place of installation**

For safety's sake, refrain from setting the projector at any place subjected to high temperature and high humidity. Please maintain an operating temperature, humidity, and altitude as specified below.

- Operating temperature: between +41°F (+5°C) and +95°F (+35°C)
- Operating humidity: between 30 and 85%
- Never put any heat-producing device under the projector so that the projector does not overheat.
- Do not attach the projector to a place that is unstable or subject to vibration.
- Do not install the projector near any equipment that produces a strong magnetic field. Also refrain from installing near the projector any cable carrying a large current.
- Place the projector on a solid, vibration free surface: otherwise it may fall, causing serious injury to a child or adult, and serious damage to the product.
- Do not stand the projector: it may fall, causing serious injury and damage to the projector.
- Slanting the projector more than  $\pm 10^\circ$  (right and left) or  $\pm 15^\circ$  (front and rear) may cause trouble or explosion of the lamp.
- Do not place the projector near air-conditioning unit or heater to avoid hot air to the exhaust and ventilation hole of the projector.

### **COMPLIANCE NOTICE OF FCC**

This equipment has been tested and found to comply with the limits for a Class B digital device, pursuant to Part 15 of the FCC Rules. These limits are designed to provide reasonable protection against harmful interference in a residential installation. This equipment generates, uses and can radiate radio frequency energy and, if not installed and used in accordance with the instructions, may cause harmful interference to radio communications. However, there is no guarantee that interference will not occur in a particular installation. If this equipment does cause harmful interference to radio or television reception, which can be determined by turning the equipment off and on, the user is encouraged to try to correct the interference by one or more of the following measures:

- Reorient or relocate the receiving antenna.
- Increase the separation between the equipment and receiver.
- Connect the equipment into an outlet on a circuit different from that to which the receiver is connected.
- Consult the dealer or an experienced Radio / TV technician for help.

Changes or modifications not expressly approved by Mitsubishi could void the user's authority to operate this equipment.

### **COMPLIANCE NOTICE OF INDUSTRY CANADA**

This Class B digital apparatus complies with Canadian ICES-003.

# Major Features

## ■ **Lightweight (at about 1.5 kg/3.3 lb) high-intensity mobile projector**

The synergy of the DLP™ (Digital Light Processing) display system and our own optical design serve to improve the optical utilization efficiency. The three primary colors (RGB) required in color expression are reproduced with one DMD (Digital Micromirror Device of high precision). These factors have enabled a design that offers both high intensity and small size/lightweight features.

## ■ **Sharp, clear picture**

The DLP™ display system affords RGB color fidelity and inconspicuous gaps between the individual dots, thereby permitting the display of small characters and diagrams with distinct clarity.

## ■ **High contrast ration of 2000:1**

Use of a new generation of DMD devices has given birth to an amazing 2000:1 high contrast ratio.

By widening the difference of brightness between black and white, you can see a degree of sharpness that is greater than just the brightness based on specifications.

## ■ **Great moving image playback capabilities using the same principles as DLP Cinema technology**

DLP type projectors have the same makings as the DLP Cinema technology used in movie theaters. Because of their extremely fast response, even images with much movement – sports, movies – play smoothly without blurring.

## ■ **Security lock function**

The lock can be set so that a password must be input when the projector is started up. Without the correct password, no operations other than turning the power on and off can be performed. This function effectively protects the projector from unauthorized use.

## ■ **Powerful functions for presentations**

A wide variety of easy-to-set functions have been built into the projector, from a digital keystone correction function (used when making settings) that corrects picture distortion, to an auto adjustment function that automatically identifies the PC signal.

There is also a built-in “Presentation Timer” function for further presentation convenience.

## ■ **Beautiful reproduction of high-quality images from DVD**

Faithful reproduction of color tones gives rise to the display of natural images. High-quality images such as those from DVD and digital high-definition television broadcasts bring out the display capabilities that are an essential strength of the DLP™ display system projector.

## ■ **Digital/analog RGB input**

by using a DVI cable to connect the projector with a personal computer equipped with a DVI connector. This will allow fully digital pictures to be enjoyed.

## ■ **Lamp-mode switch function for the lamp output**

Using the lamp Low-mode will extend the life of the lamp and lower the power consumption.

By switching the lamp mode to suit your operating environment, you will save on lamp cost as well as contribute to energy conservation and ecology.

# Table of Contents

## Preparation and Background Knowledge

IMPORTANT SAFETY INFORMATION .....	E-1
Major Features .....	E-4
Table of Contents .....	E-5
Checking the Supplied Accessories .....	E-7
Names of the Main Unit Parts .....	E-9
Names of the Remote Control Parts .....	E-11
Preparing the Remote Control .....	E-12
Button Battery Replacement .....	E-12
Remote Control Range .....	E-12

## Setup and Projection

The Procedure Up to Projecting to the Screen .....	E-13
Placement Guide	

Screen Size and Projection Distance .....	E-14
---	------

### Connecting Personal Computers and Video Equipment

Connections with Personal Computer .....	E-15
Personal Computers with a DVI Connector .....	E-15
Personal Computers with a Mini D-Sub 15-Pin Connector .....	E-16
To Output the External Output Signal of a Notebook Computer .....	E-17

Connections with Composite Signals .....	E-18
Video Equipment with VIDEO Connectors .....	E-18
Video Equipment with S-VIDEO Connectors .....	E-18

Connections with Component Signals .....	E-19
--	------

Connections with Audio Connectors .....	E-20
---	------

### Power Cable Connections and Switching the Power On/Off

Operating .....	E-21
Finishing .....	E-23

### Adjustment of the Projection Screen

Adjustment of the Projection Screen .....	E-24
Making Adjustments with the Adjusters .....	E-25

## General Operation

Input Selection .....	E-26
Automatic Adjustment of Analog RGB .....	E-26
Selection of Aspect Ratio .....	E-27
Freezing a Moving Picture .....	E-28
Cancelling Video and Audio Temporarily .....	E-28
Lamp Mode .....	E-28
Keystone .....	E-29
Adjustment of the Volume .....	E-29
Enlargement of the Image and Video Movement .....	E-30
Using the Presentation Timer .....	E-31
Protecting the Projector with the Security Lock .....	E-32
Using the Quick Menu .....	E-34

## Menu Operations

<b>Menu Operation Method</b> .....	<b>E-35</b>
Names and Functions of Buttons Used for Menu Operations .....	E-35
Menu Screen Names and Functions .....	E-36
Performing Menu Operations .....	E-37
Selecting Another Menu Name with Remote Control Operation .....	E-39
List of Item Names Offering Input Selection and Adjustments/Settings .....	E-40

## Adjustments and Settings

<b>Image</b>	
Brightness / Contrast / Color / Tint / Sharpness .....	E-42
Picture Adj. / Fine Picture / H Position / V Position .....	E-42
Reset .....	E-43
<b>Color</b>	
Quick Color Adj. ....	E-44
Gamma .....	E-44
Color Temp. ....	E-45
White .....	E-45
Color Space .....	E-45
White Balance .....	E-46
<b>View</b>	
Aspect .....	E-47
Filter .....	E-47
Vertical Flip/Horizontal Flip .....	E-48
Keystone .....	E-48
Keystone Save .....	E-48
<b>Setup</b>	
Auto Source .....	E-49
Auto Power Off .....	E-49
Menu Position .....	E-49
Lamp Mode .....	E-50
Input Format .....	E-50
Presentation Timer .....	E-50
<b>Option</b>	
Language .....	E-51
On Screen .....	E-51
Background .....	E-51
Startup Screen .....	E-52
Security Lock .....	E-52
<b>Info.</b>	
Status .....	E-53
Factory Default .....	E-53
Lamp Timer Reset .....	E-53
Resolution / Frequency .....	E-54
Lamp Timer .....	E-54

## Miscellaneous

<b>When the STATUS Indicator is Lit or Blinking</b> .....	<b>E-55</b>
<b>Troubleshooting</b> .....	<b>E-56</b>
<b>Cleaning</b> .....	<b>E-57</b>
<b>Replacing the Lamp Cartridge</b> .....	<b>E-58</b>
<b>Specifications</b> .....	<b>E-61</b>
<b>Table of Supported Frequencies</b> .....	<b>E-62</b>
<b>Cabinet Dimensions</b> .....	<b>E-63</b>

### Declaration of Conformity

Model Number : XD60U  
 Trade Name : MITSUBISHI ELECTRIC  
 Responsible party : Mitsubishi Digital Electronics America, Inc.  
 9351 Jeronimo Road, Irvine, CA 92618 U.S.A.  
 Telephone number : +1-(949) 465-6000

This device complies with Part 15 of the FCC Rules. Operation is subject to the following two conditions:

- (1) this device may not cause harmful interference, and
- (2) this device must accept any interference received, including interference that may cause undesired operation.



# Checking the Supplied Accessories

Remove the main unit and the accessories from the box and check that the following items are included.

## Remote control (includes one button battery) [1]

This controls the projector. Please remove the transportation insulation sheet at time of purchase. (See Page E-12.)

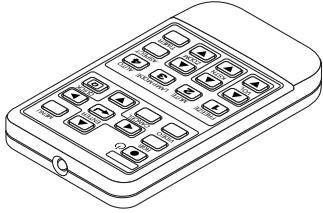

## Power cable (1.8 m / 5.9 feet) [3]

This power cable supplies power to the unit. See Page E-21 about connections.

No. 246C484-10/No. 246C484-20/No. 246C484-30

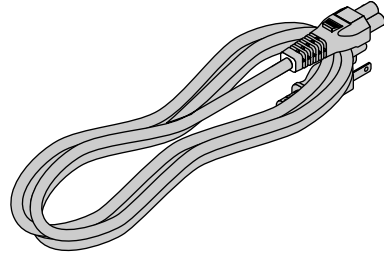

## DVI / Mini D-sub 15-pin conversion cable (2 m / 6.6 feet) [1]

This is used in making connections with a personal computer. See Page E-16 about connections.

No. 246C485-10

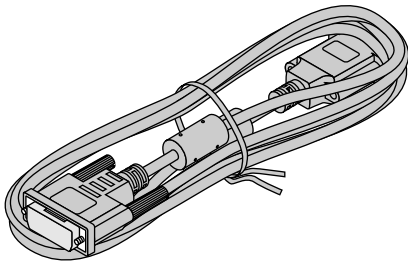

## Video cable (RCA pin plug, 2 m / 6.6 feet) [1]

This cable is used in the connection of video equipment that has a video connector. Connections are described on Page E-18.

No. 246C487-20

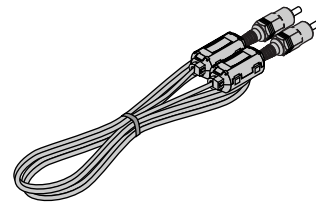

## S-Video cable (Mini DIN 4-pin plug, 2 m / 6.6 feet) [1]

This cable is used in the connection of video equipment that has an S-video connector. Connections are described on Page E-18.

No. 246C486-20

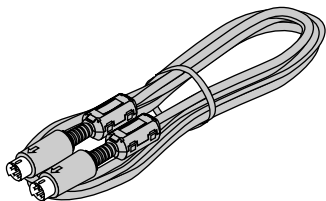

## Audio conversion cable (Mini plug / RCA pin plug, 15 cm / 0.5 feet) [1]

This cable is used with equipment whose audio connector is of the phono pin type. Connections are described on Page E-20.

No. 246C489-10

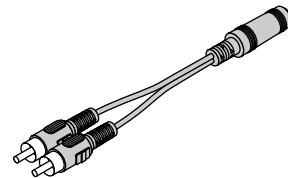

## Audio cable (Mini plug, 2 m / 6.6 feet) [1]

This cable is used with equipment that has phono type audio jacks. Connections are described on Page E-20.

No. 246C488-10

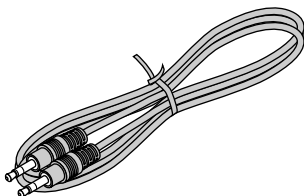

## Checking the Supplied Accessories

### Carrying case (for projector and accessories) [1]

This is a case designed for storing the projector and its accessories.

Use this carrying case when storing or moving the projector.

No. 772C019-10

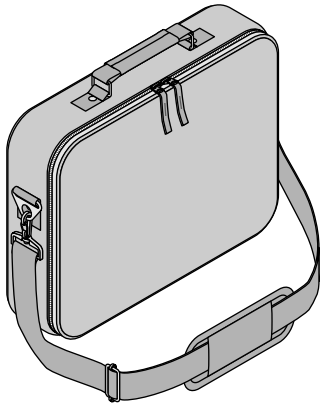

User Manual (CD-ROM Edition) [1]

User Manual (Simplified Edition) [1]

Security Sheet [1]

Security Label [1]

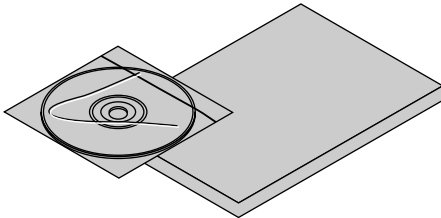

### HOW TO PUT THE PROJECTOR INTO THE CARRYING CASE

Close the lens shutter or lens cap before putting the projector in its case, then fasten the projector in place with the Velcro belt. Place the accessories in the storage pocket.

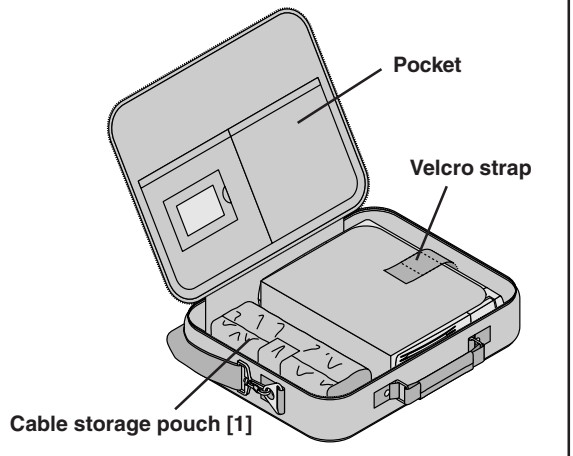

## “WARNING”

Handling the cables supplied with this product, will expose you to lead, a chemical known to the State of California to cause birth defects or other reproductive harm.

Wash hands after handling.



## Names of the Main Unit Parts

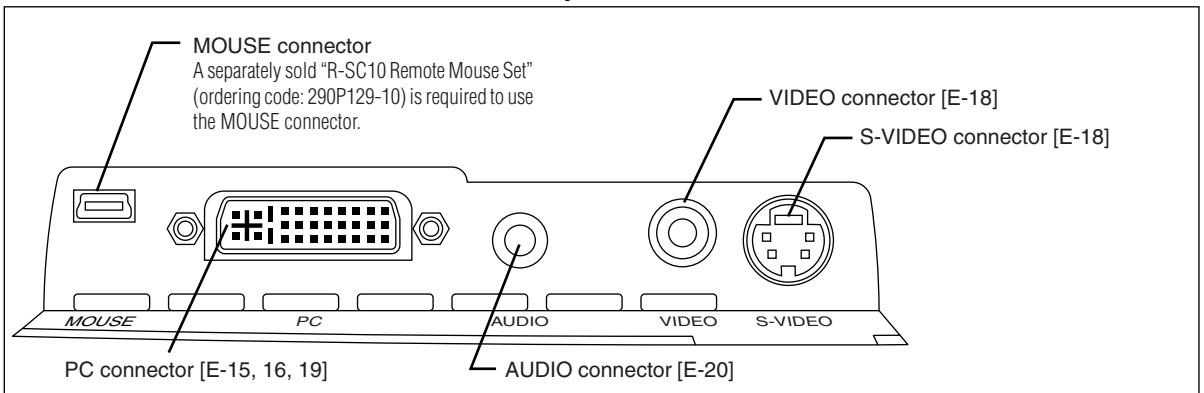
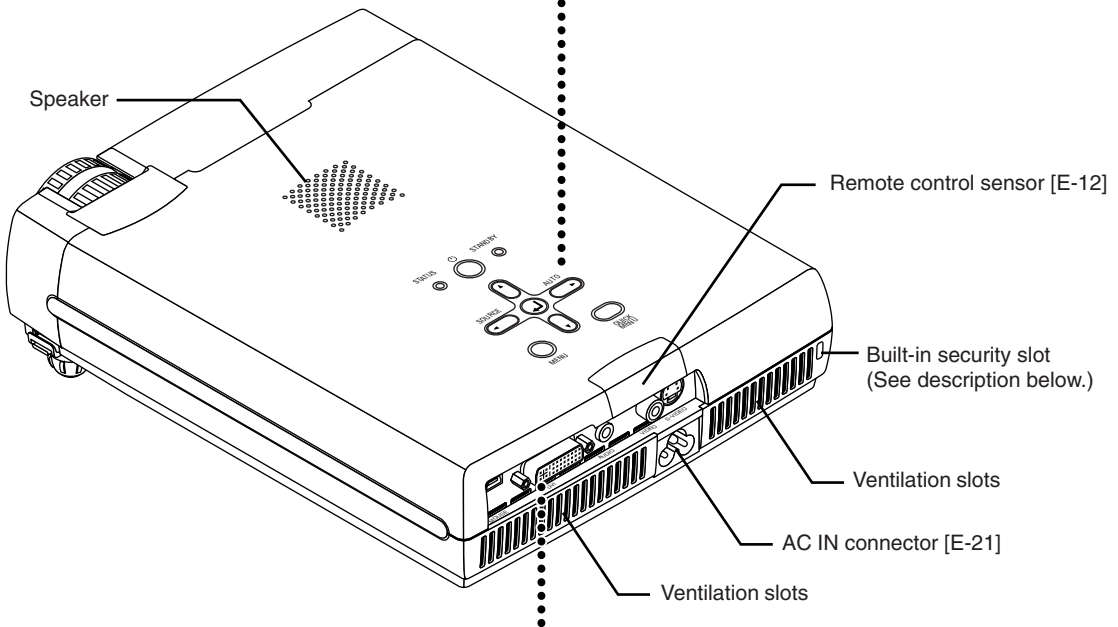
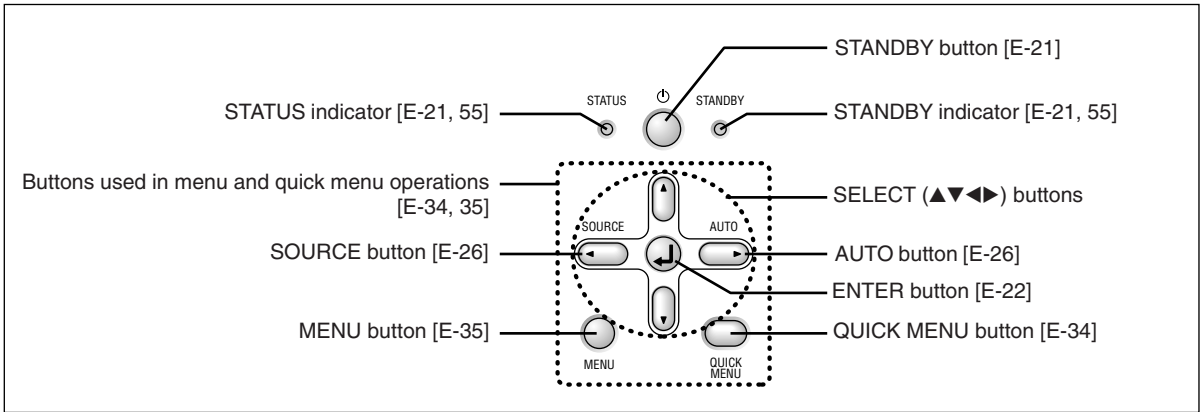

### Built-in Security Slot

This security slot supports the MicroSaver Security System manufactured by Kensington Microware Inc.

# Names of the Remote Control Parts

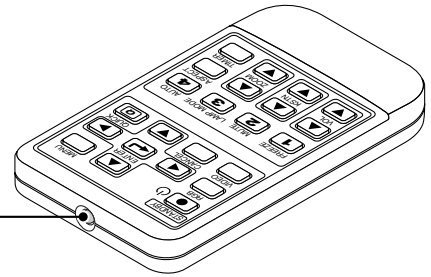

Infrared transmitter [E-12]

STANDBY button [E-21, 23]  
This button is used to switch ON the power and set the unit to the STANDBY mode.

Buttons used for input selection [E-26]  
RGB button and VIDEO button (VIDEO / S-VIDEO)

MUTE button [E-28]  
(Temporarily cancels the video and audio)

Number buttons [E-32]  
(Used for the security lock.)

FREEZE button [E-28]  
(Freezes moving pictures)

VOL button [E-29]  
(Volume adjustment)

KSTN button [E-29]  
(Keystone correction adjustment)

Buttons used for menu operations [E-35]  
The , , and buttons are the select ( , , and ) buttons.

QUICK button [E-34]  
(Displays a simplified menu)

LAMP MODE button [E-28]  
(Selection of lamp mode)

AUTO button [E-26]  
(Automatic adjustment of the Analog RGB moving image)

ASPECT button [E-27]  
(Selects the vertical and horizontal ratio of the screen)

TIMER button [E-31]  
(Presentation timer time setting display)

ZOOM button [E-30]  
(Digital zoom adjustment)

## Note

If a button on the remote control unit is held in continuously for approximately 30 seconds, signal transfer will be suspended. To resume transferring signals, press the button again.

## Precautions

### Handling of the Remote Control

- \* Do not drop the remote control or handle it inappropriately.
- \* Do not expose the remote control to water or other liquids. Should the remote control become wet, wipe it dry immediately.
- \* Try to avoid use in hot and/or humid locations.
- \* Please keep button battery out of the reach of children. If a battery is swallowed, promptly obtain the medical care of a doctor.
- \* Remove the battery from the remote control when it is not going to be used for a long period.
- \* Some operations (such as menu operations) are available only through the use of the remote control and attention should be given to its careful handling.

# Preparing the Remote Control

## Button Battery Replacement

### Using the remote control for the first time

The battery compartment is fitted with a transportation insulation sheet at the time of shipping. Pull out the sheet and remove it. The remote control is now ready for use.

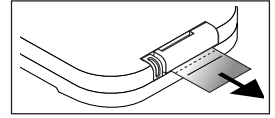

### Replacement Method

**1** (A) With the knob pressed to the right side, (B) draw out the battery case.

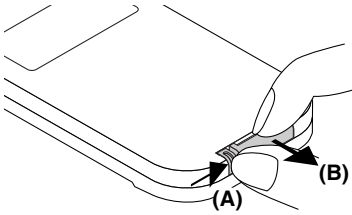

**2** Remove the old battery and install a new button battery with (+) side facing upward in the battery holder.

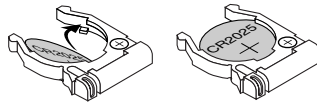

Purchase a CR2025 type battery for replacement.

**3** Insert the battery holder into the remote control and push in until the battery holder closes with a "click" sound.

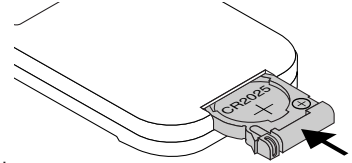

#### CAUTION

Danger of explosion if battery is incorrectly replaced.  
Replace only with the same or equivalent type (CR2025) recommended by the manufacturer.  
Dispose of used batteries according to your local regulations.

#### CAUTION

DISPOSE OF USED BATTERIES ACCORDING TO THE INSTRUCTIONS.

## Remote Control Range

Point the infrared transmitter of the remote control toward the remote control sensor located at the front or rear of the main unit and operate.

Reception of the remote control signal should generally be possible within the range illustrated below.

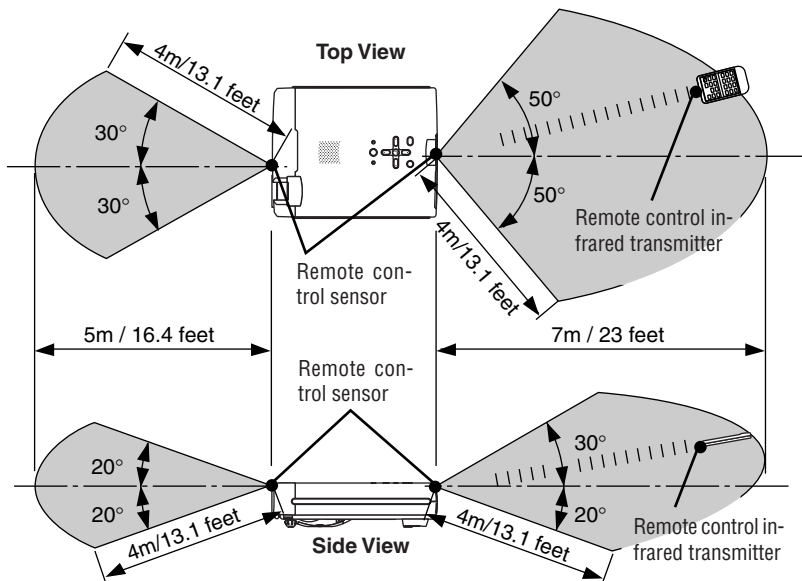

#### Note

- \* Exposure of the main unit's remote control sensor or the remote control infrared transmitter to bright light or the obstruction of the signal by an obstacle located in the pathway may prevent operation.
- \* The remote control will not function when the battery is exhausted.

# The Procedure Up to Projecting to the Screen

Perform setup adjustments in the following order.

## 1 Position the projector

Determine the locations to set up the screen and the projector.  
See “Placement Guide” on Page E-14.

## 2 Connect the video equipment and personal computer

### Connect your equipment to the projector.

When making connections with the personal computer’s DVI connector or RGB connector, see “Connections with Personal Computers” on Page E-15.

When making connections with the video equipment’s video connector or an S-video connector, see “Connections with Composite Signals” on Page E-18.

When making connections with the video equipment’s YCbCr connector or YPbPr connector, see “Connections with Component Signals” on Page E-19.

When playing the audio through the built-in speaker of the projector, see “Connections with Audio Connectors” on Page E-20.

## 3 Opening the lens shutter or lens cap

## 4 Connecting the power cable and switching on the power

See “Operating” on Page E-21.  
See “Finishing” on Page E-23.

## 5 When selecting the language of menu displays, etc. (Only when the power is first switched on following purchase)

See “When [Menu Language Select] Is Displayed Upon Switching On the Power” on Page E-22.

## 6 Switching on the power of the personal computer and video equipment

## 7 Properly adjust the projection image to the screen

See “Adjustment of the Projection Screen” on Page E-24.

## 8 Selecting input equipment

See “Input Selection” on Page E-26.

## 9 Adjust the screen or video image

Adjust the image to the optimum condition as required.  
See the Table of Contents for the adjustment items.

### About DLP projectors

Though careful attention is paid to providing optimum quality, please note that with DLP type projectors, in rare cases there may be black spots or bright spots among the picture elements.

#### Note:

- \* Please purchase a screen.
- \* A DVI-D cable (Not supplied), which is available separately, is required for connections with the DVI connector of the personal computer.
- \* A component cable (Not supplied), which is available separately, is required to connect a DVD player or other equipment with YCbCr connectors.
- \* A component cable (Not supplied), which is available separately, is required to connect high definition (HD) video equipment or other equipment with YPbPr connectors.

# Placement Guide

- Use this information as a guide to find out about the screen size when the projector is placed at a certain location, or to find out the approximate size of a screen that will be required.
- The projection distance over which focussing is adjustable is 1.20 m (3.9 feet) to 14.17 m (46.50 feet). The projector should be placed within this range.

## Screen Size and Projection Distance

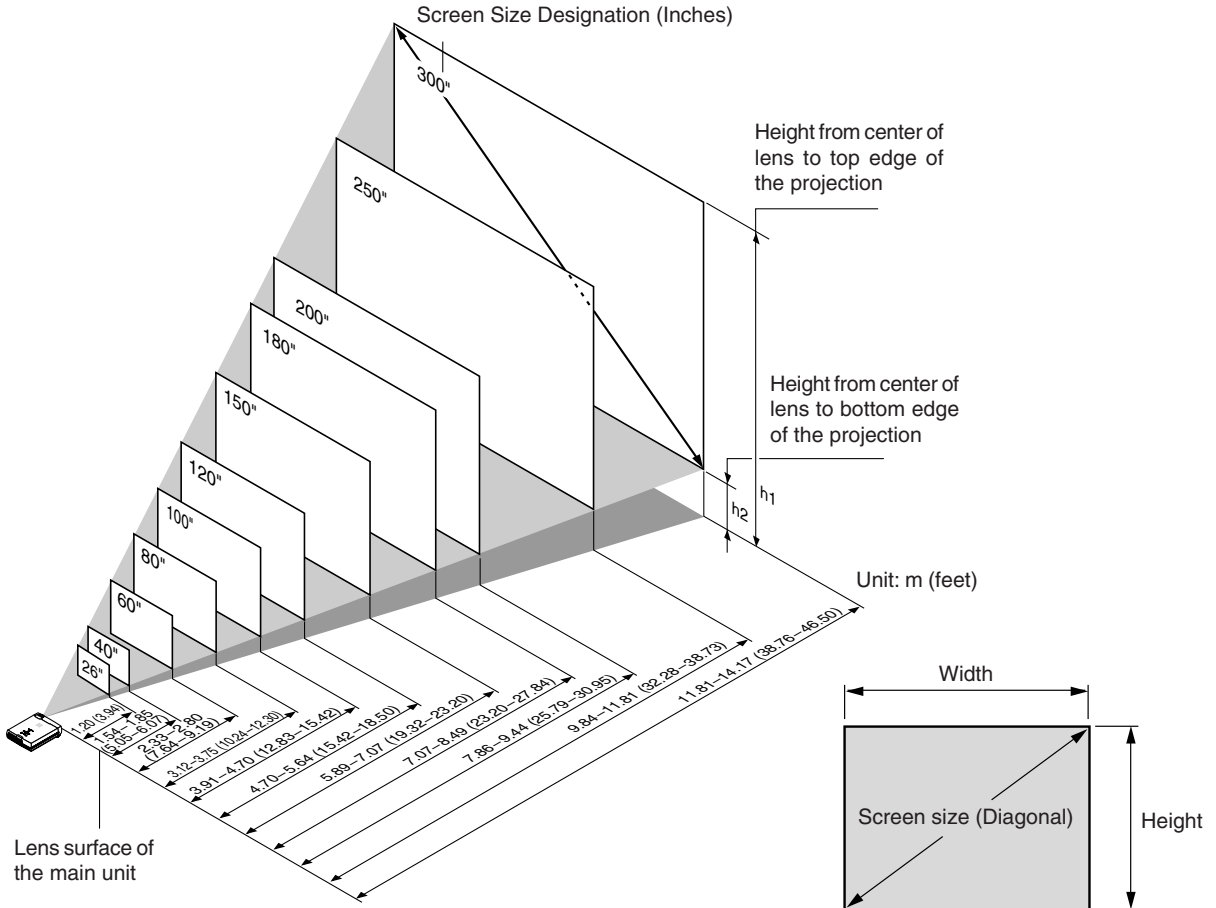

Screen Size Designation (Inches)	Screen Size Width x Height		Projection Distance		Height h1		Height h2	
	(m)	(feet)	(m)	(feet)	(m)	(feet)	(m)	(feet)
26"	0.53 × 0.40	1.73 × 1.30	— — 1.20	— — 3.94	0.47	1.52	0.07	0.22
40"	0.81 × 0.61	2.67 × 2.00	1.54 — 1.85	5.04 — 6.08	0.71	2.34	0.10	0.34
60"	1.22 × 0.91	4.00 × 3.00	2.33 — 2.80	7.64 — 9.19	1.07	3.51	0.16	0.51
80"	1.63 × 1.22	5.33 × 4.00	3.12 — 3.75	10.23 — 12.30	1.43	4.68	0.21	0.68
100"	2.03 × 1.52	6.67 × 5.00	3.91 — 4.70	12.82 — 15.41	1.78	5.85	0.26	0.85
120"	2.44 × 1.83	8.00 × 6.00	4.70 — 5.64	15.42 — 18.52	2.14	7.02	0.31	1.02
150"	3.05 × 2.29	10.00 × 7.50	5.89 — 7.07	19.31 — 23.18	2.68	8.78	0.39	1.28
180"	3.66 × 2.74	12.00 × 9.00	7.07 — 8.49	23.20 — 27.84	3.21	10.53	0.47	1.53
200"	4.06 × 3.05	13.33 × 10.00	7.86 — 9.44	25.79 — 30.95	3.57	11.70	0.52	1.70
250"	5.08 × 3.81	16.67 × 12.50	9.84 — 11.81	32.28 — 38.73	4.46	14.63	0.65	2.13
300"	6.10 × 4.57	20.00 × 15.00	11.81 — 14.17	38.76 — 46.50	5.35	17.55	0.78	2.55

\* There is a tolerance of ±5% due to design values.

\* This table uses the lens apex and lens center as references and requires that the projector be in a horizontal condition (with front and rear adjusters fully withdrawn).



# Connecting Personal Computers and Video Equipment

Connecting this unit with a personal computer permits presentation data to be projected as a large screen display at conferences, lectures, and on other occasions. Furthermore, connecting this unit to a DVD player or other video equipment source in combination with an audio/video amplifier and speaker system will allow you to enjoy convincing home theater.

## Connections with Personal Computer

Please check the following before making connections with the personal computer.

- A suitable resolution for the XD60U is 1024 × 768 dots (XGA) and the maximum displayable resolution is 1280 × 1024 dots (S-XGA).  
Make changes to a displayable resolution at the personal computer side. Please check with “Table of Supported Frequency” on Page E-62.
- The setting method for the personal computer will differ depending on the specific model. Please read the personal computer instruction manual or the on-line help information, or contact the manufacturer of your personal computer.
- Projection might not be possible when connection is with a personal computer that is equipped with a DVI-I connector such as some PowerBook G4 computers and others when the signal is converted to analog RGB (which uses a mini D-sub 15-pin connector) and connection is made with the pertinent equipment. In circumstances such as this, please purchase separately a DVI-D cable and use the unit through the DVI connection.  
Note that connections via DVI will enable the projection of a high quality image compared to connections using analog RGB.

### Personal Computers with a DVI Connector

- Make the connection with a DVI-D cable and the PC connector of the projector.  
When connecting, arrange the connectors in the proper orientation and plug in. Turn the screw knobs and fasten to the connector of the main unit.
- The projector has been set to “Auto” at the factory; however, if it does not project, please change the input setting to “Digital” using the menu sequence of [Setup] → [Input Format] → [PC].  
See “Input Format” on Page E-50.

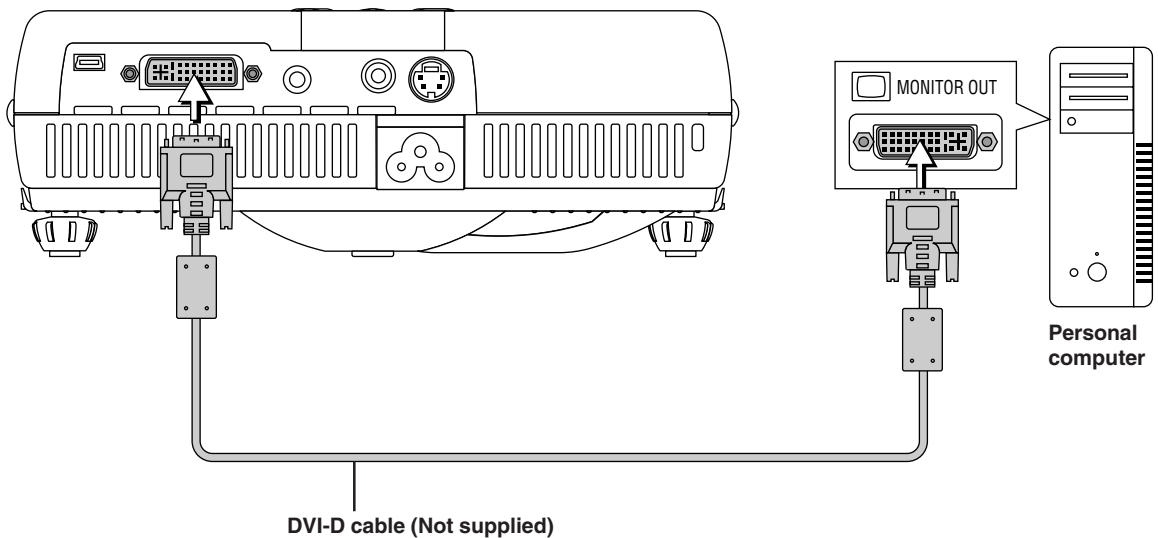

#### Note

This projector uses a 29-pin DVI connector that supports the digital interface. Digital signal TMDS (Transition Minimized Differential Signaling) of the DVI (Digital Visual Interface) standard is used.

## Connecting Personal Computers and Video Equipment

### Personal Computers with a Mini D-Sub 15-Pin Connector

- When making connections with the DVI connector of the projector, please make the connection via the supplied DVI/mini D-Sub 15-pin conversion cable. The projector has been set to “Auto” at the factory; however, if it does not project, please change the input setting to “RGB” using the menu sequence of [Setup] → [Input Format] → [PC]. See “Input Format” on Page E-50.

**Note:**

- \* When the input format has been switched, you may be required to reconnect the input signal.
- \* If the position is off or there are dark vertical bands on the picture, press the AUTO button with the screen as bright as possible (make the screen as bright as possible by for example displaying the trash window over the entire screen). If the problem persists after pressing the AUTO button several times, set manually at the “Picture Adjustment” menu.

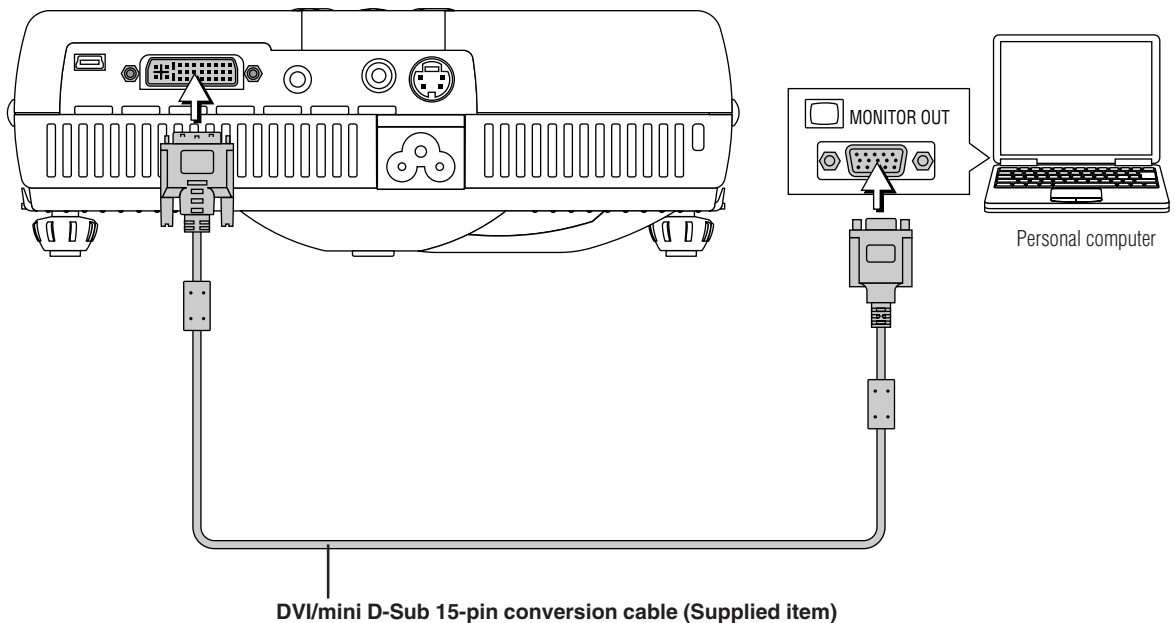

**Note:**

- \* Before making connections, check the power of the projector and the equipment to be connected is switched off.
- \* When projection will be with a notebook computer connected, knowledge will be required for the cable connection and notebook computer startup procedure as well as the operation that follows startup. Please consult the instruction manual of your notebook computer or the on-line help.

### To Output the External Output Signal of a Notebook Computer

When projection will be with a notebook computer connected, knowledge will be required for the cable connection and notebook computer startup procedure as well as the operation that follows notebook startup. Please consult the instruction manual of your notebook computer or the on-line help while performing the following procedure.

- 1** Check whether a signal is being sent from the notebook computer to the projector.  
An indication appearing on the liquid crystal display of the notebook computer does not necessarily mean that an external output signal is being output.
- 2** Should a sign not be output from the notebook computer, please try the operation described below.  
For an IBM PC/AT, DOS/V computer, press the [Fn] key plus any one of the [F1] to [F10] keys. (See the table below.)

Manufacturer	Model	Key
DELL	All computers	Fn + F8
EPSON	All computers	Fn + F8
FUJITSU	All computers	Fn + F10
iiyama	All computers	Fn + F3
IBM	All computers	Fn + F7
NEC	All computers	Fn + F3
Panasonic	All computers	Fn + F3
SHARP	All computers	Fn + F5
SONY	All computers	Fn + F7
SOTEC	All computers	Fn + F3–F5
TOSHIBA	All computers	Fn + F5
Victor	All computers	Fn + F10

Note: Table information is current to December 2003.

#### **Note**

*When the liquid crystal display of the notebook computer and the projector are displayed at the same time, the projected image might not be correct even though the liquid crystal display shows a correct indication. Should this occur, stop the simultaneous display of the notebook computer and try the mode with external output only. (Try an operation such as that described in aforementioned Step 2 and try closing the liquid crystal panel which might result in external output only.)*

### Connections with Composite Signals

#### Video Equipment with VIDEO Connectors

- Make the connection to the VIDEO connector of the projector using the supplied Video cable.
- The input setting of the VIDEO connector has been set to “Auto” at the factory; however, if the projector does not project, please change the input setting to “Your Country’s Television Broadcast System” using the menu sequence of [Setup] → [Input Format] → [Video].  
See “Input Format” on Page E-50.

#### Video Equipment with S-VIDEO Connectors

- Make the connection to the S-VIDEO connector of the projector using the supplied S-video cable.
- The input setting of the S-VIDEO connector has been set to “Auto” at the factory; however, if the projector does not project, please change the input setting to “Your Country’s Television Broadcast System” using the menu sequence of [Setup] → [Input format] → [S-Video].  
See “Input Format” on Page E-50.

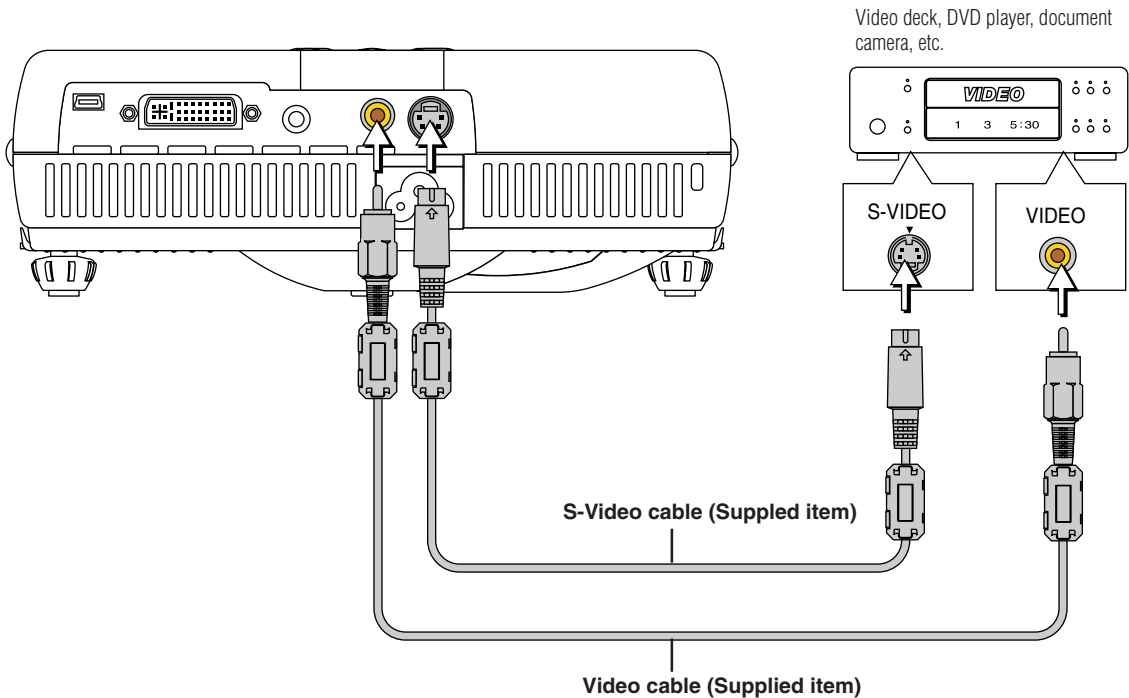

#### Note

The picture may be disturbed when the input format is switched or when the mode is set back to auto. This is not a malfunction. The picture will return to normal when the input is switched, etc.

## Connections with Component Signals

### When the Video Equipment Has a YCbCr Connector or YPbPr Connector

- The projector has been set to “Auto” at the factory; however, if it does not project, please change the input setting to “Component” using the menu sequence of [Setup] → [Input Format] → [PC]. See “Input Format” on Page E-50.
- This projector automatically distinguishes the YCbCr input signal and the YPbPr input signal and projects it. When projecting the YCbCr signal or YPbPr signal, if the color of the overall image strongly leans toward being greenish or another color, change the setting under the menu of [Color] → [Color Space]. See “Color Space” on Page E-45.

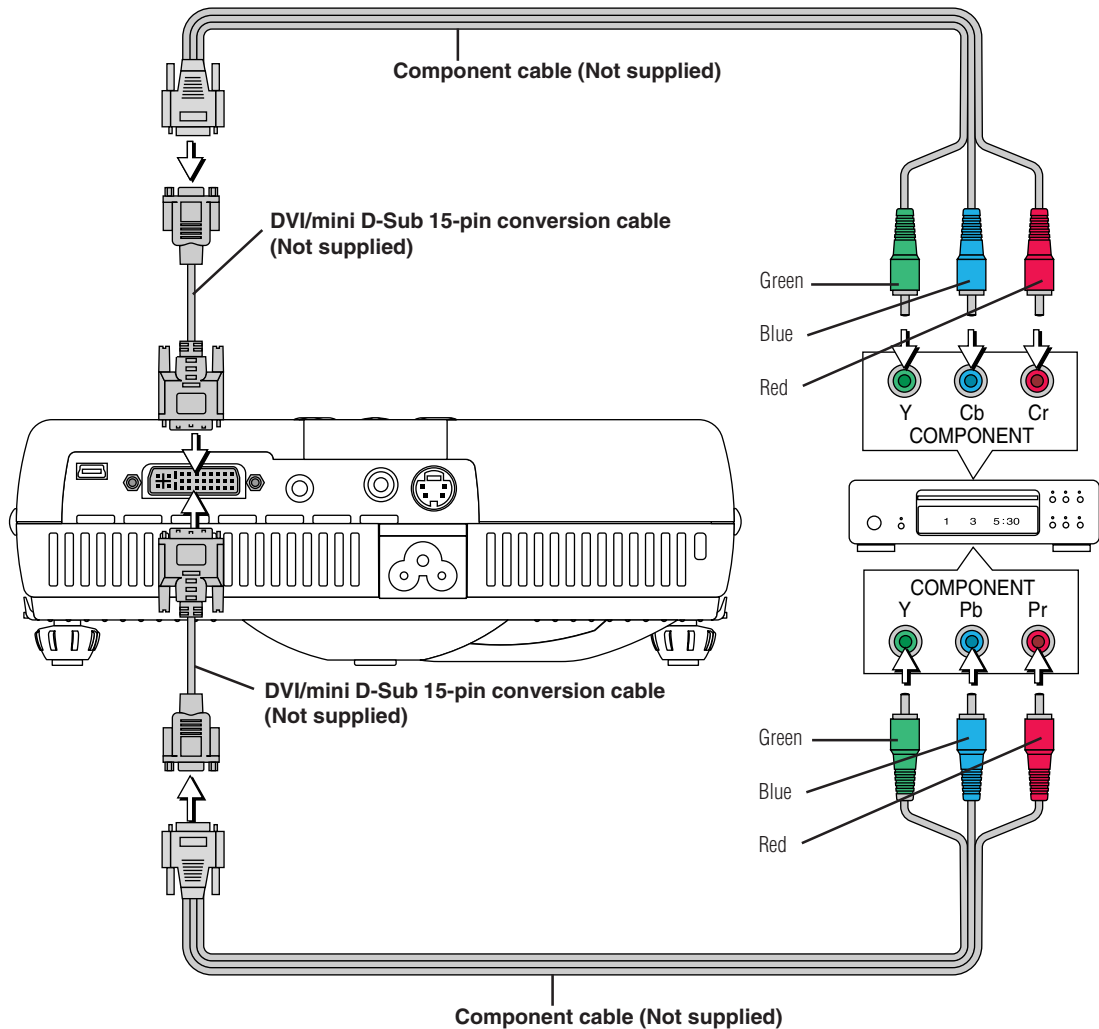

#### Projecting component signals

Please note that when inputting 480i or 576i signals using a separately sold component cable and viewing video images, depending on the connected device and the video source being projected, the picture may be disturbed or may not be projected properly. In such cases, it is possible to achieve a picture with no disturbance that is projected properly by either switching to 480p signals or connecting using an S-Video cable instead.

#### Note

In some rare cases, the picture may not be displayed, depending on the connected device. When the input format has been switched, you may be required to reconnect the input signal.

### Connections with Audio Connectors

- \* Make the connection to the projector's AUDIO connector using the supplied audio cable. When the audio jack of the equipment that is to be connected is of the RCA phono type, make connection via the supplied audio conversion cable.
- \* The built-in speaker of the projector provides monaural audio. To enjoy convincing audio reproduction, please connect the audio output of the video equipment to your audio system.
- \* The built-in speaker outputs the audio of the equipment connected to the AUDIO connector.

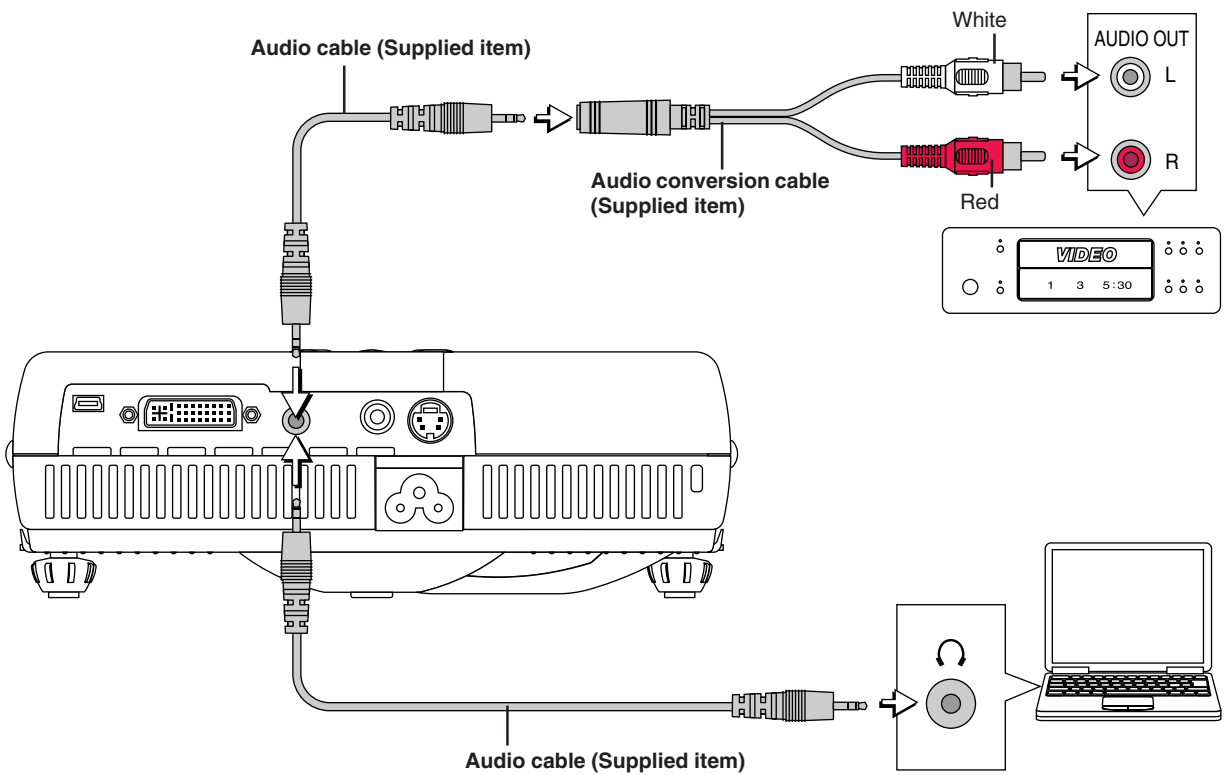

# Power Cable Connections and Switching the Power On/Off

There is an order in which the power cable is connected and the power is switched on/off.

## Operating

- 1 Connect the AC IN connector of the projector and the power outlet using the supplied power cable.**  
The STANDBY indicator will light in amber, and the unit will enter the standby mode.

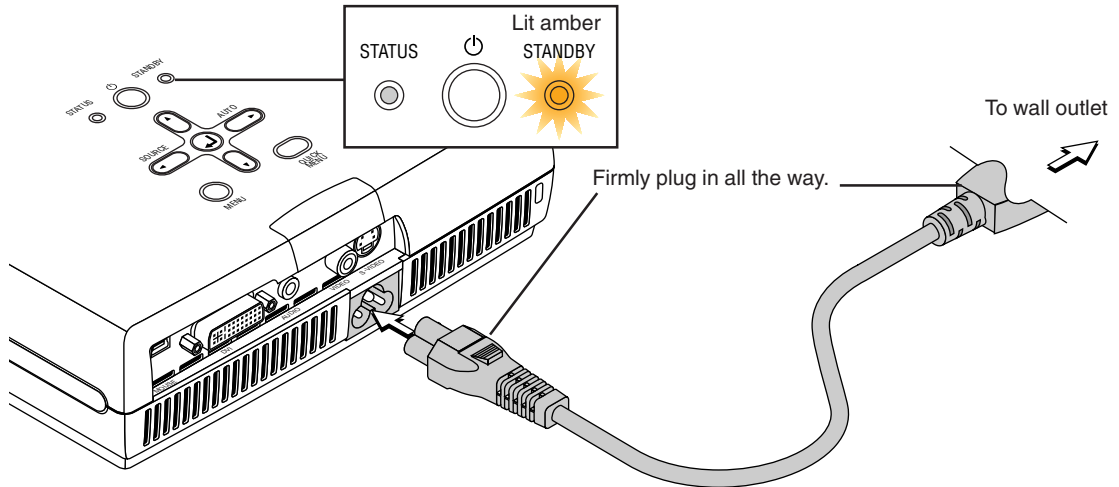

- 2 Switch on the projector power**  
**Main unit operation:** Press the STANDBY button.  
**Remote control operation:** Press the STANDBY button.

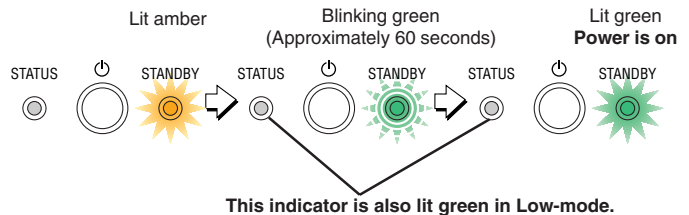
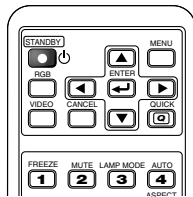

The first time the power is switched on after purchase, [Menu Language Select] will be displayed. See Page E-22 for information about language selection.

- When the power is switched on, the STANDBY indicator changes to blinking green, then lights steadily after about 60 seconds and the projection screen is set to the brightness of normal mode. At this time, if the STATUS indicator is lit in green, [Lamp Mode] is set to "Low". See Pages E-28 and E-50 for information about the selection method.
- If the power does not come on, see "When the STATUS Indicator is Lit or Blinking" on Page E-55.

If the "Password" input window is displayed: See Page E-33.

**A password is set for this projector.**

The projector cannot be used unless the correct password is input.

To turn off the power: See Page E-23.

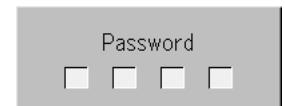

The projector is now capable of regular projection.

- 3 Switch on the power of the connected equipment**

### Note:

- When the power plug will be unplugged from the power outlet, please place the projector near the power outlet so that it may be reached easily.
- Press the STANDBY button after the STANDBY indicator is lit in amber.
- The included power cable is exclusively for use with the XD60U. Never use it with other products.
- Use the appropriate cord for your country.
- The provided power cord for the U.S. is rated at 120 V. Never connect this cord to any outlet or power supply using other voltages or frequencies than rated. If you want to use a power supply using other voltage than rated, prepare an appropriate power cord separately.

## When [Menu Language Select] is Displayed Upon Switching On the Power

The first time the power is switched on after purchase, [Menu Language Select] will be displayed. Follow the procedure described below and select the display language of the projector.

If the image is blurred, turn the focus ring counterclockwise or clockwise to focus it. See Page E-25.

Menu Language Select	
Please select a menu language.	English
Wählen Sie bitte die Menü Sprache aus.	Deutsch
S'il vous plait choisir la langue de menu.	Français
Per favore di scegliere la lingua di menu.	Italiano
Escoja por favor el idioma de menú.	Español
Välj menyn språken.	Svenska
메뉴언어를 선택하십시오	한국어
请选择项目单语言	中文
メニュー言語を選択して下さい。	日本語
Select "▲" "▼" & "ENTER"	

- 1 Press the SELECT ▲▼ buttons of the projector and align the deep blue cursor with [English].

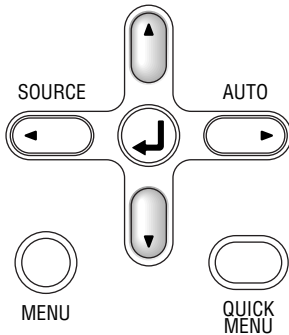

Menu Language Select		Cursor
Please select a menu language.	English	↑
Wählen Sie bitte die Menü Sprache aus.	Deutsch	
S'il vous plait choisir la langue de menu.	Français	
Per favore di scegliere la lingua di menu.	Italiano	
Escoja por favor el idioma de menú.	Español	
Välj menyn språken.	Svenska	
메뉴언어를 선택하십시오	한국어	
请选择项目单语言	中文	
メニュー言語を選択して下さい。	日本語	
Select "▲" "▼" & "ENTER"		

- 2 Press the ENTER button to set.  
This will set the language and [Menu Language Select] will close.

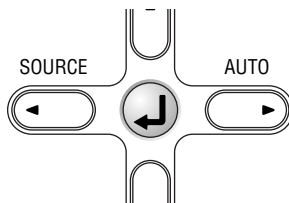

This completes the selection of the display language.

**Caution:**

[Menu Language Select] will not appear the next time the power is switched on. Should a change of language become necessary, see "Language" on Page E-51.



**Finishing**

**1** Switch off the power of the connected equipment

**2** Switch off the power of the projector

**Main unit operation:** Press the STANDBY button.

**Remote control operation:** Press the STANDBY button.

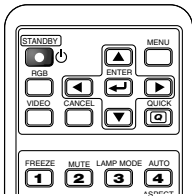

The [Power Off] display appears.

When the level gauge reaches maximum, the projection screen will go off (in about 5 seconds) and the projector will enter the power-off operation.

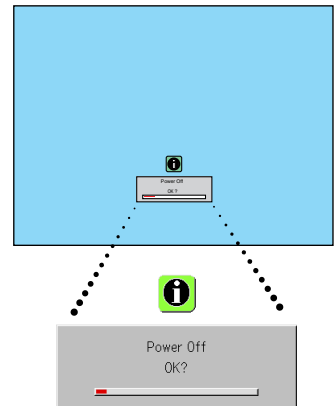

**Note**

- \* The operation can be cancelled by pressing a button other than the STANDBY button.
- \* One more press of the STANDBY button will switch off the power.

The STANDBY indicator changes to blinking amber and lights a steady amber after about 90 seconds (when the unit enters the standby mode).

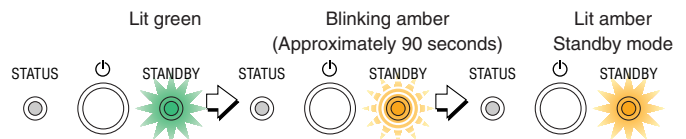

**3** Unplug the power cable

**Check that the STANDBY indicator is lit in amber and then unplug the power cable.**

The STANDBY indicator will go off when the power cable is unplugged.

**Warning**

Do not unplug the power cable while the STANDBY indicator is blinking amber. Doing so may shorten the life of the lamp or damage the projector.

# Adjustment of the Projection Screen

Switch on the power of the connected equipment and make the adjustments with the video signal being input to the projector.

## Adjustment of the Projection Screen

### 1 Turn the zoom ring to adjust the screen size of the projection image.

Adjust the image to match the desired screen size. When outside of the adjustment range, move the projector to the rear or forward.

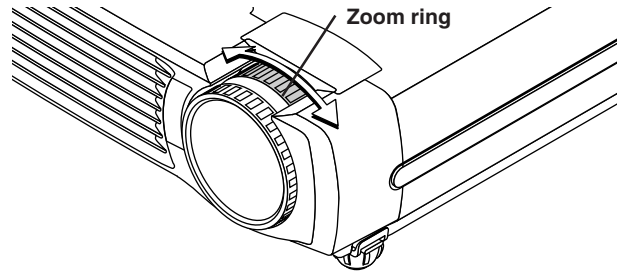

### 2 Adjust the projection image to the screen.

Check that the screen is set level and vertically.

- (1) If the image is shifted to the left or right, move the main unit horizontally. (Align the center of the screen and the center of the projector lens.)
- (2) If the image is shifted vertically, move the image up or down with the adjuster. See "Making Adjustments with the Adjusters" on Page E-25.
- (3) If the image is slanted, adjust by turning the right or left front adjuster. See "Making Adjustments with the Adjusters" on Page E-25.
- (4) A projection image such as that illustrated in the diagram is the result of the projector not being perpendicular to the screen. Set the projector so that it is pointing straight toward the screen.
- (5) If the image shows keystone distortion, adjust using remote control or menu operations. See "Keystone" on Page E-29, 48.

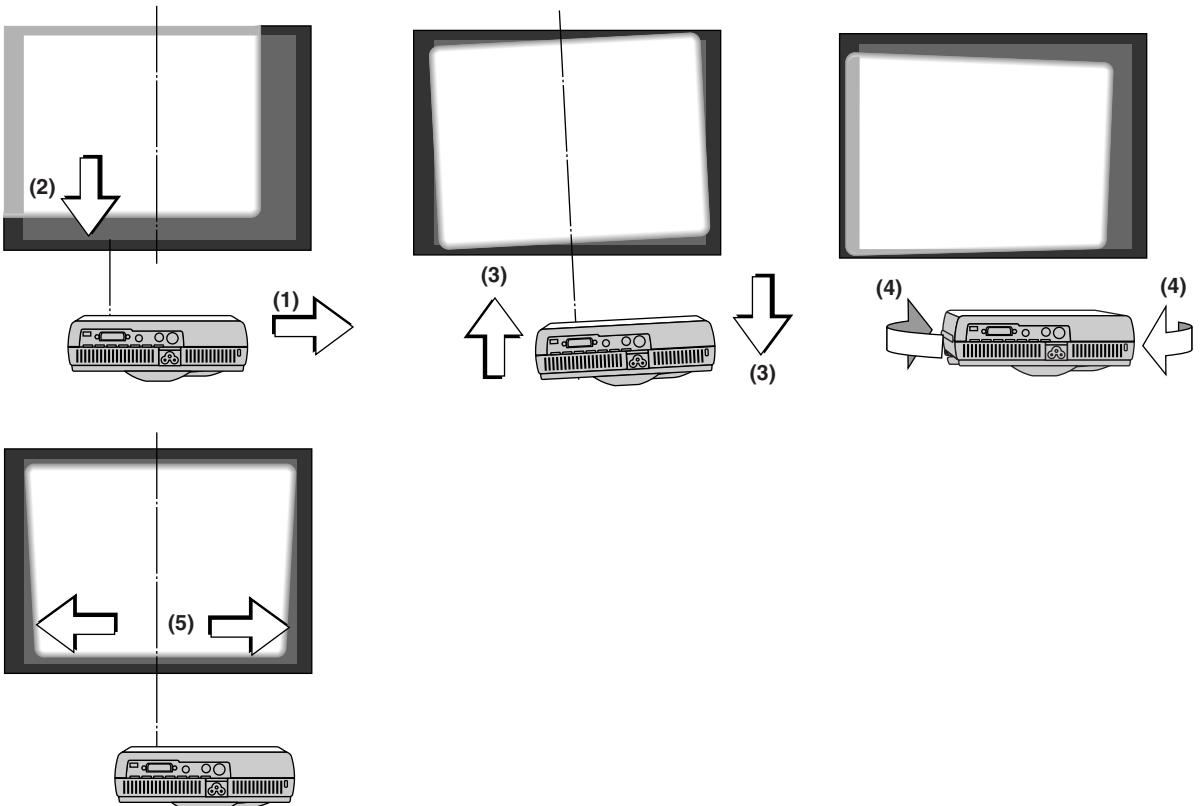

### 3 Turn the focus ring and adjust the focus of the screen

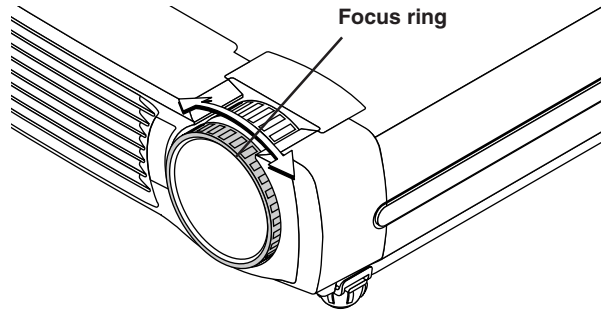

### Making Adjustments with the Adjusters

#### Raising the projection image

While viewing the projection image, (1) press and hold the front adjuster buttons located at the left and right and, (2) raise the projector to align the image with the screen, then release your fingers.

Turn the left and right front adjusters for fine adjustment. Adjust so that there is no shaking of the projector.

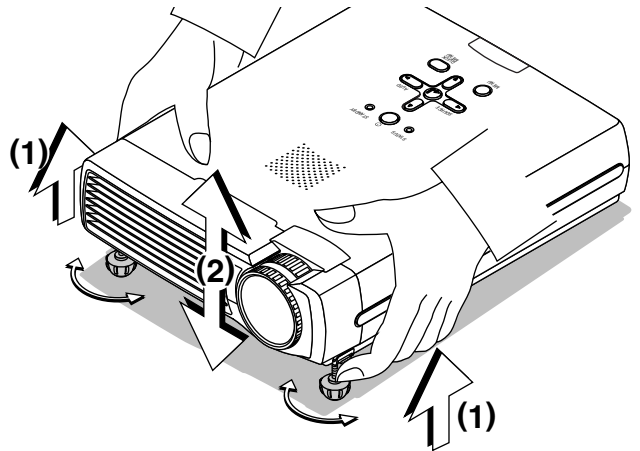

#### Lowering the projection image

Lower the front adjusters using the operation described above.

To lower the projection screen further, raise the rear adjuster. Fine adjustments are made by turning the left and right front adjusters. Make adjustments so that there is no rattling.

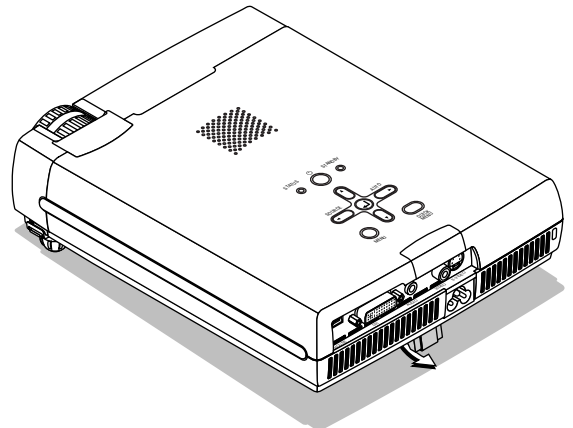

**Note:**

When the projector has a suspended or rear installation is used, the orientation of the projection will need to be changed. Please see "Vertical Flip/Horizontal Flip" on Page E-48.

# General Operation

This section describes the use of direct operation with the main unit or remote control buttons.

For information about operation using the menu, see "Menu Operation Method" on Page E-35 and the various items on Pages E-42 to E-54.

## Input Selection

This operation selects the input signal to be projected.

**Main unit operation: Press the SOURCE button.**

(It will not function while the menu or the quick menu is displayed.)

**When Auto Source is On**

If there is no input signal at the source that was previously used, the projector automatically selects another source that has the next input signal.

**When Auto Source is Off**

Each press of the button switches the selection one step in the sequence of PC → VIDEO → S-VIDEO.

**Remote control operation: Press the desired input selection button.**

RGB button ..... This is used to switch to the PC connector.

VIDEO button ..... Each press of this button switches the input between Video and S-Video.

**When Auto Source is On**

When an input signal is not present at the selected source, the projector automatically selects the next source that has an input signal.

**When Auto Source is Off**

The projector switches to the selected source regardless of whether an input signal is present.

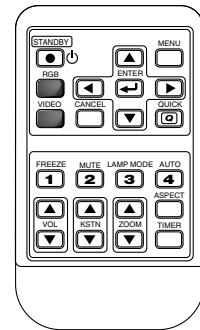
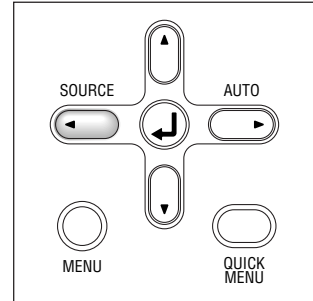

### Note

- \* When you do not operate source selection, the projector will assume the input selection condition that was previously used.
- \* See "Auto Source" on Page E-49 for information about the Auto Source on and off conditions.
- \* When the input format has been switched, you may be required to reconnect the input signal.

## Automatic Adjustment of Analog RGB

This function automatically adjusts the position shift of the analog RGB input signal, the size of the picture, vertical striping, and color infidelity.

Normally, this function is adjusted automatically at the time of signal selection.

**Main unit operation/Remote control operation: Press the AUTO button.** (This will not function while the menu or the quick menu is displayed.)

A press of the AUTO button starts the automatic adjustment.

### Note

- \* If the display position is shifted, vertical lines appear on the picture, or the projection is not good even after using automatic adjustment, please perform image adjustment manually. See "Picture Adj. / Fine Picture / H Position / V Position" on Page E-42.
- \* If the position is off or there are dark vertical bands on the picture, press the AUTO button with the screen as bright as possible (make the screen as bright as possible by for example displaying the trash window over the entire screen). If the problem persists after pressing the AUTO button several times, set manually at the "Picture Adjustment" menu.
- \* When the image extends beyond the boundaries of the screen or is smaller than the screen, set Aspect to "Auto". See "Selection of Aspect Ratio" on Page E-27 and "Aspect" on Page E-47.

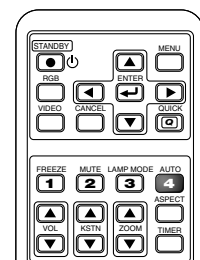
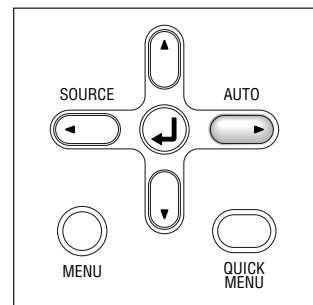

## Selection of Aspect Ratio

This function selects horizontal and vertical picture proportions of the input signal.

Press the ASPECT button while viewing the projected image and select the aspect ratio.

### Personal Computer Signal

Each press of the ASPECT button advances the selection one step in the sequence of Auto → Direct → Real, and then repeats.

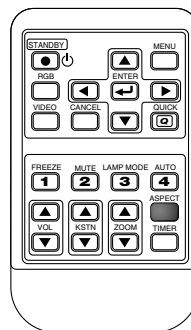

- Auto ..... Automatically enlarges or reduces the image to project a full screen in a ratio of 4:3
- Direct ..... Maintains the aspect ratio and projects a picture of the maximum displayable size
- Real ..... Projects the input signal without pixel conversion.

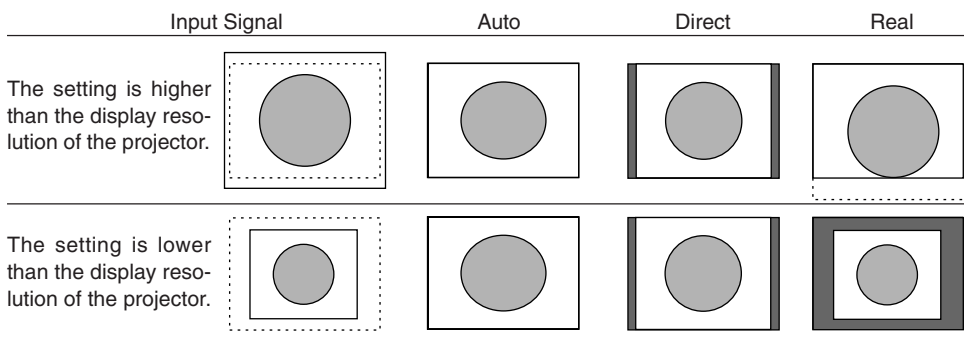

### Video Signals / Component Signals

Each press of the ASPECT button advances the selection one step in the sequence of Auto → Wide → Zoom, and then repeats.

- Auto ..... While maintaining the aspect ratio, projects a full screen so that no portions extend beyond the boundaries of the screen. The top and bottom of the 16:9 image becomes black.
- Wide ..... Projects to fill the full width with the entire image at 16:9. (This feature is used to project a squeezed image in a proper aspect ratio.)
- Zoom ..... Projects only the 4:3 portion within 16:9 image to fill the screen. (Portion that extend off screen is cut.)

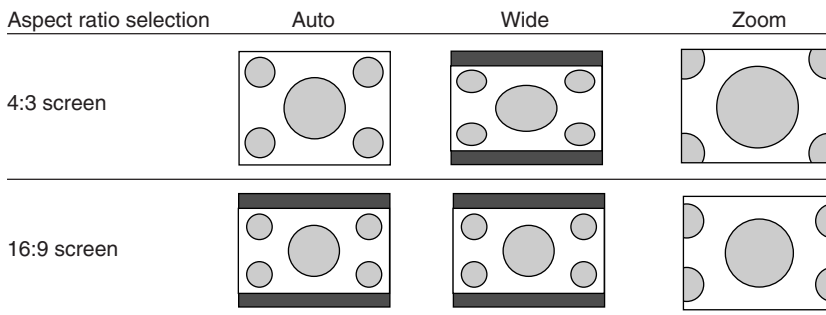

**Note:**  
The "Real" setting under "Aspect" for digital RGB signals can only be adjusted when the input signal is of XGA size or smaller.

**Note:**  
When selection has been made for the "Real" setting of the personal computer signal (i.e., when the input signal and the projector display resolution are high) and the "Zoom" setting of the video signal, pressing the SELECT ▲▼◀▶ buttons on the remote control will permit movement of the display position. Note that there will not be any movement when the menu or the quick menu is displayed.

## General Operation

### Freezing a Moving Picture

This function is used to stop and view a moving picture. Note that the input image continues to advance even though the picture there is a still picture condition.

A press of the **FREEZE** button changes the screen to a still picture. A further press returns the screen to a moving picture.

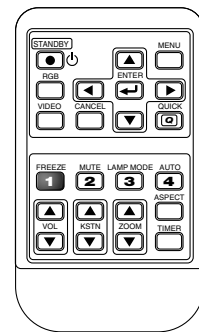

### Canceling Video and Audio Temporarily

This function is used to cancel the video and audio at the same time.

A press of the **MUTE** button will blank the picture and the sound, and the screen will take on the background color that has been set. Another press will cause a return to the original conditions.

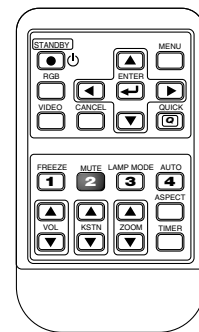

### Lamp Mode

Use this if the picture is projected on a small screen and the picture is too bright or when projecting images in dark rooms.

Pressing the **LAMP MODE** button will set the lamp mode.

#### Low (STATUS indicator is lit green)

Lamp brightness is set to 80% and the lamp life is extended.

#### Normal (STATUS indicator is off)

Lamp brightness is set to 100% and the screen is bright.

**Note:**

*Frequent switching this mode can degrade the lamp.*

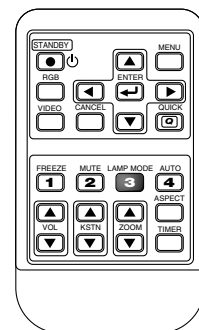
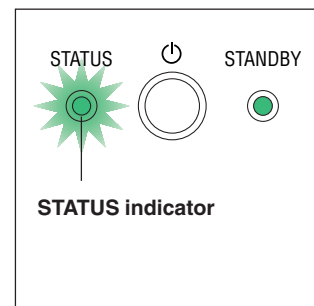

## General Operation

### Keystone

Use this to adjust for trapezoidal (keystone) distortion of the projected image.

#### Adjustment Method

- (1) Press the ▲ or ▼ KSTN button to make the left and right sides parallel.

The keystone adjustment display appears when one of the buttons is pressed.

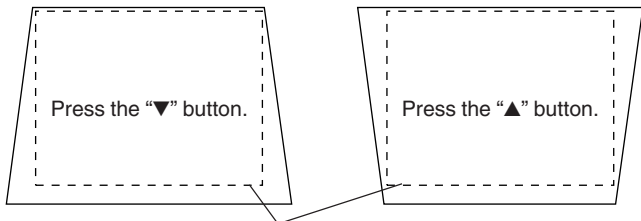
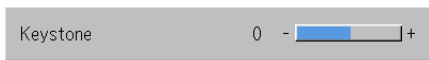

The dotted lines indicate the proper condition

- (2) Press the CANCEL button to immediately close the display.

The display will close when there has not been an operation in about 10 seconds.

#### Note:

- \* Keystone adjustment values can be saved. See "Keystone Save" on Page E-48.
- \* Screen examples have been drawn in an exaggerated style for the purpose of description.
- \* Please note that depending on the projected picture and the projection conditions, it may not be possible to eliminate keystone distortion completely.

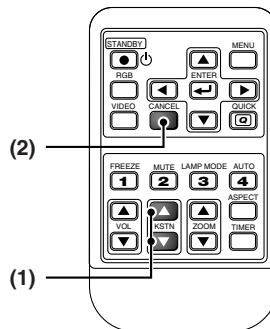

### Adjustment of the Volume

This function adjusts the volume of the built-in speaker.

- (1) Press the ▲ or ▼ VOL button to adjust the volume.

The volume adjustment display appears when one of the buttons is pressed.



The ▲ button increases the volume and the ▼ button decreases the volume.

- (2) Press the CANCEL button to immediately close the display.

The display will close when there has not been an operation in about 10 seconds.

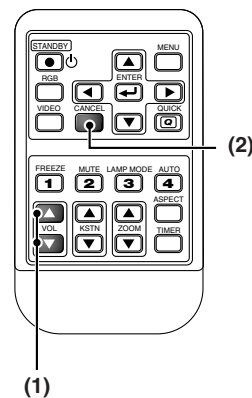

#### Note:

- \* Adjustment of the volume will not produce any sound unless an image is being projected.

## Enlargement of the Image and Video Movement

This function digitally enlarges the personal computer image and video image.

**(1) Press the ZOOM button to enlarge the image.**

The zoom display appears when the ZOOM button is pressed.



When the ▲ button is pressed, the image is enlarged approximately 2 times, and when the ▼ button is pressed the image is reduced (returning to 1:1).

- The enlargement function cannot be used with digital RGB inputs.

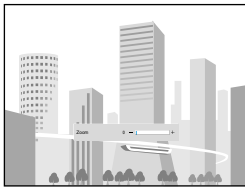

(No enlargement)

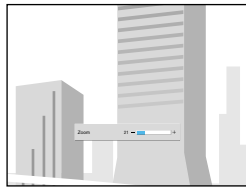

(Approximately 2 times enlargement)

**(2) Pressing the SELECT ▲▼◀▶ buttons on the remote control at the time of the zoom operation will cause the display position to move.**

(There will not be any movement when zoom is at 0.)

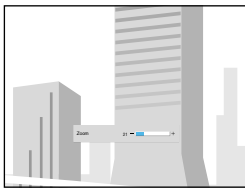

(Approximately 2 times enlargement)

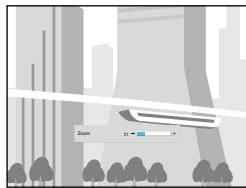

(Movement)

**(3) Press the CANCEL button to immediately close the display.**

The display will close when there has not been an operation in about 10 seconds.

**Note:**

After magnifying the image, be sure to use the ZOOM button to bring the gauge value back to "0".

**The image can also be moved in the following circumstances.**

- When "Aspect" is set to "Real" by the signal of the Analog RGB, and the input resolution is higher than the display resolution of the projector.
- When "Aspect" is set to "Zoom" by the video signal.

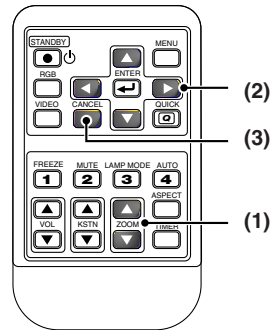

**Note:**

- \* Zoom and image movement functions are cancelled when the input is switched.
- \* Movement of the screen will not be possible when the menu screen is being displayed.
- \* The greater the zoom enlargement, the less distinct the image will appear. The reason for this is that the dots are being digitally corrected so that they are not conspicuous.



## Using the Presentation Timer

The presentation is given while checking the timer displayed on the screen.

The gauge display allows the remaining time to be known at a glance.

**(1) Press the TIMER button to show the settings display.**

The display will close when an operation has not been made for about 10 seconds.

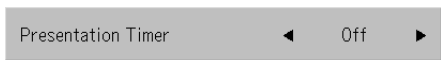

[Timer settings display]

Press the CANCEL button to close the display immediately.

**(2) Use the ◀ and ▶ SELECT buttons to set the time.**

The setting contents are "Off" and from 10 to 60 minutes (in 10-minute intervals)

Settings can also be made with the SELECT ◀▶ buttons.



**(3) Press the ENTER button and start the timer.**

- The display of the timer setting will close, the display of the timer will appear and simultaneously the timer will start.



[Timer Display]

The blue gauge indicates the remaining time. When the gauge disappears, the time is up.

The gauge continues to be displayed when the timer is stopped.



- Press the ENTER button to restart the timer. The timer will start with the same time setting.
- Press the CANCEL button to close the timer display. The timer setting will return to "Off".

**Moving the Position of the Timer Display**

The SELECT ▲▼◀▶ buttons on the remote control permit movement within the movable range of the timer display.

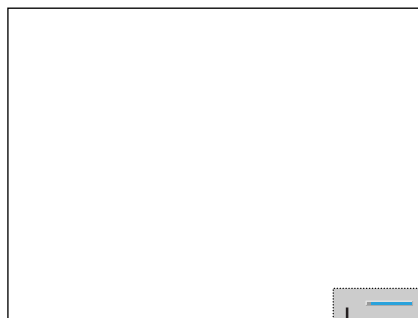
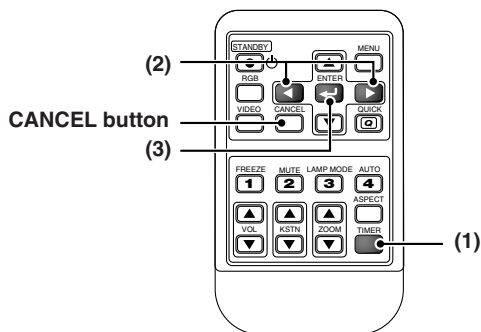

Movable Range of the Timer Display

**Note:**

\* The timer display will be closed while the menu or the quick menu is displayed, and while a message is displayed; however, the timer will still be operating at such times. Also, the timer will not be displayed unless a signal is being input.

\* While the presentation timer is being displayed, screen movement will not be possible in the zoom mode.

## Protecting the Projector with the Security Lock

A password can be registered and the security lock set in order to protect the projector from unauthorized use.

### Registering the password

The password is registered using the menus. For instructions on operating the menus, see “Menu Operation Method” on E-35.

- (1) Select “Security Lock” in the “Option” menu and set it to “Enable”.  
The menu closes and the password registration display appears.

Image	Color	View	Setup	Option	Info.
				Language	↓
				On Screen	◀ On ▶
				Background	◀ Blue ▶
				Startup Screen	◀ Logo ▶
				Security Lock	◀ Enable ▶

- (2) Use the number buttons (1 to 4) to register the password.

Be sure to input a 4-digit number.

Example: Registering the password “2441”

- (1) Press number button “2”. An “★” (asterisk) appears at the first place.  
Next press number buttons “4”, “4” and “1” in that order. Asterisks appear in all four places.

Password				
Register Password	★			
Confirm Password				

Password				
Register Password	★	★	★	★
Confirm Password				

- (2) Input the password again. An “★” appears when the input number matches. If there is a mistake, the asterisks turn off. Start over from step (1) above.  
If the password matches, the password registration display closes.

Password				
Register Password	★	★	★	★
Confirm Password	★			

Password				
Register Password	★	★	★	★
Confirm Password	★	★	★	★

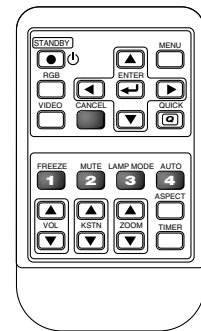

**Note:**

To cancel the number you have input, press the CANCEL button.  
The asterisks disappear and the display returns to the input standby mode at the first place.  
To cancel the password registration mode, press the CANCEL button again. The “Password” display turns off.

**This completes password registration.**

The “Password” input display appears the next time the power is turned on.

**Note:**

The numbers you have input are not displayed. Be sure to write down the password and store it in a safe place.

## General Operation

### If the password input display appears when the power is turned on

When a password has been registered, the "Password" input window appears on the projected image when the power is turned on. The projector continues projecting this image until the correct password is input. At this time, only the STANDBY button (power off) works. Use the procedure described below to input the registered password. For instructions on registering the password, see E-32.

### Input the password using the number buttons (1 to 4).

Be sure to input the registered 4-digit number.

Example: To input the password "2441"  
Press number button "2". An "\*" (asterisk) appears in the first place.



Next press number buttons "4", "4" and "1" in that order. Asterisks appear in all four places.

If the password matches, the window turns off and the projector can be used normally.



[Password input window]

### Canceling the password/Changing the password

The password is canceled and changed using the menus. For instructions on operating the menus, see "Menu Operation Method" on E-35.

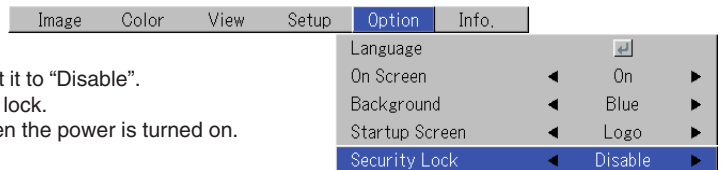

#### Canceling the password

Select "Security Lock" in the "Option" menu and set it to "Disable".

This clears the password and disables the security lock.

The password input display no longer appears when the power is turned on.

#### Changing the password

After setting "Security Lock" to "Disable" as described above, set it back to "Enable". The menu closes and the password registration display appears.

Register the new password. See "Registering the password" on E-32.

## Using the Quick Menu

This function permits frequently used adjustments to be performed quickly.

Note that the Quick Menu will not be displayed unless the signal of the connected equipment is input. Please select the input that you wish to adjust.

### Main unit operation

- (1) Press the QUICK MENU button to display the quick adjustment display. Further presses cause the adjustment display to change in sequence. Press the SELECT ▲ or ▼ button to switch to the desired adjustment display.
- (2) Press the SELECT ◀ or ▶ button to adjust.

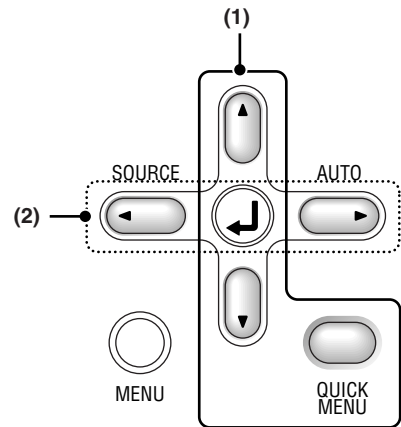

### Remote control operation

- (1) A press of the QUICK MENU button brings up the quick adjustment display. Further presses cause the adjustment display to change in sequence. The adjustment display can be selected with use of either the SELECT ▲ or ▼ button.
- (2) Press the cursor ◀ or ▶ button to make the adjustment.
- (3) To close the display immediately, press the CANCEL button. In the absence of operations for a period of about 10 seconds, the display will close automatically.

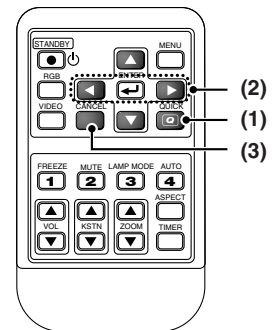

## Content of Adjustments and Settings

### Example: Brightness adjustment display

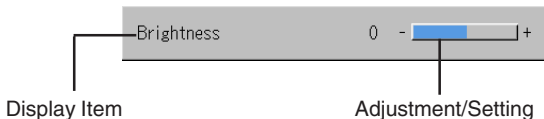

Brightness	Adjusts the brightness of the image. See page E-42.
Contrast	Adjusts the contrast of the image. See page E-42.
Keystone	Corrects (vertical) keystone distortion of the screen. See page E-29, 48.
Volume	This function adjusts the volume of the built-in speaker. See page E-29.
Presentation timer	Sets the time of the presentation timer. See page E-31.
Quick Color Adj.	Select the preset color mode. See page E-44.

# Menu Operation Method

- This section describes only the menu operation method. Please see this item should you need information while performing menu operations.
- For information about a menu function, adjustment, or setting, please see one of the pages containing such descriptions.
- Adjustments and settings are made by projecting an image and adjusting to an optimum condition.
- The remote control should be pointed toward the remote control sensor of the projector and operated.
- To return the various items that have been changed via the menu to their standard values (i.e., default values at time of shipping from the factory), see “Factory Default” on Page E-53. (Some items will not return to their initial values.)
- The adjustment/setting items and contents will differ depending on the input selection and the adjustment/setting items that can be used with the input signal are displayed on the menu.

## Names and Functions of Buttons Used for Menu Operations

### (Remote Control)

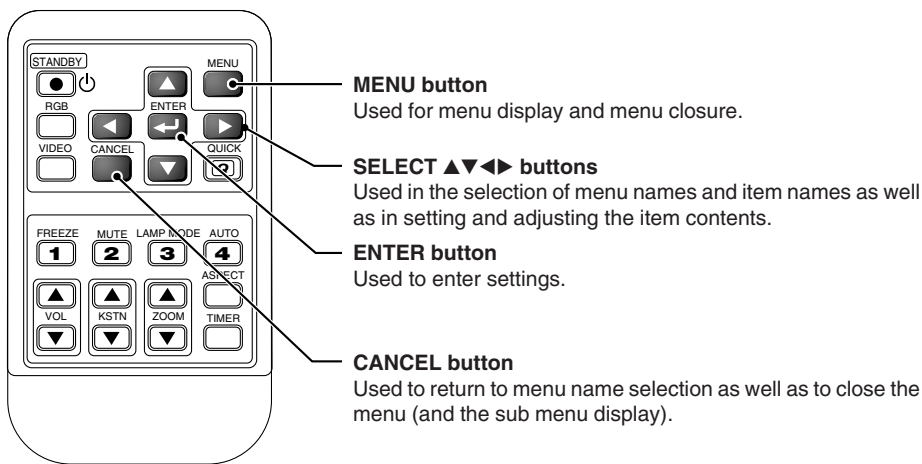

### (Main Unit)

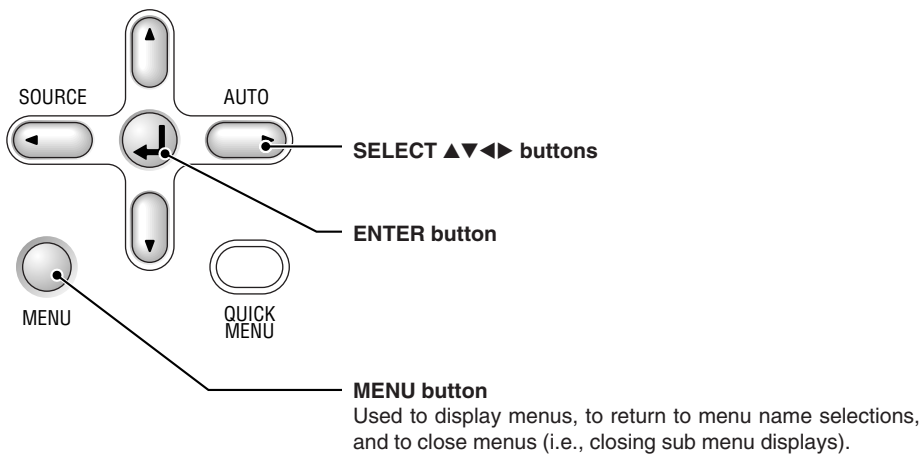

Menu Screen Names and Functions

**Menu Name**

This is the title of the menu.  
There is a change to the title screen when the menu is selected.  
The cursor moves to the selected menu name.

**Cursor (Deep Blue)**

This permits setting/adjustment of the item located at the cursor position.

**Item Name**

This is the name of the adjustment or setting.

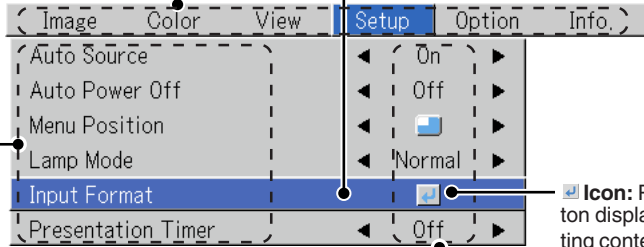

**Icon:** Pressing the ENTER button displays the sub menu or setting contents.

**Adjustment Bar and Settings Contents**

Adjustment Bar: The increases and decreases in bar length express the adjustment condition.  
Setting Contents: Displays the contents that have been set.

**Adjustment Bar**

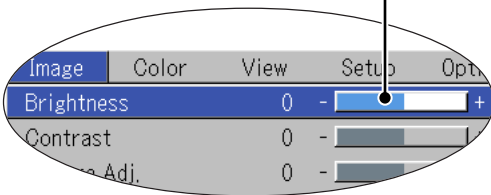

**Sub menu**

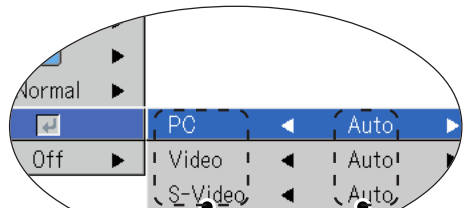

**Item Name**

**Settings Contents**

## Performing Menu Operations

- Only “Setup”, “Options” and “Info.” can be selected when no signal is being input.
- The menu display will close if, after pressing a button, the next button operation is not made within 30 seconds.
- The adjustment and the setting values are stored even when the power is switched off or the plug is disconnected from the power outlet.

(Note that some items are not stored.)

**Preparation** Switch on the power of the connected equipment, start the play operation or another operation, and input the signal to the projector.

Select the input that you wish to adjust.

The menu display of the description diagram depicts an example in which the “Keystone” item name is selected.

## Menu Display

### 1 Press the MENU button to display the menu

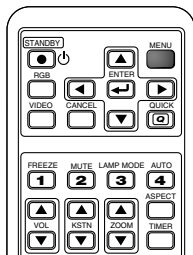

Image	Color	View	Setup	Option	Info.
Brightness		0	-	+	
Contrast		0	-	+	
Picture Adj.		0	-	+	
Fine Picture		0	-	+	
H Position		0	-	+	
V Position		0	-	+	
Reset					

The menu name that existed when the menu was closed previously will be displayed.

## Selection of the Menu Name

### 2 Press the SELECT ◀▶ button to select the menu name

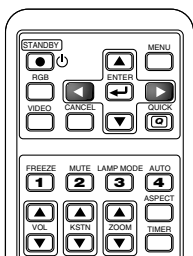

Image	Color	View	Setup	Option	Info.
Aspect				◀	Auto ▶
Filter				◀	3 ▶
Vertical Flip				◀	Off ▶
Horizontal Flip				◀	Off ▶
Keystone		0	-		+
Keystone Save				◀	On ▶

Each press of the SELECT ▶ button advances the selection one step in the sequence of “Color” → “View” → “Setup” → “Option” → “Info.” → “Image”. Each press of the SELECT ◀ button causes a return of one step.

The cursor moves to the selected menu name.

**Note:**

Please check that the cursor of the item name has disappeared at the time of menu name selection.  
Press the CANCEL button to make the cursor disappear.

Displaying the Cursor

**3** Press the **▼ SELECT** button to display the item name selection cursor.

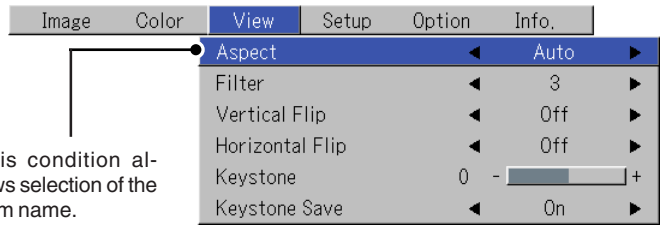
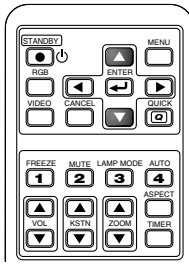

Selection of the Item Name

**4** Press the **SELECT ▲▼** button to align the cursor with the item name

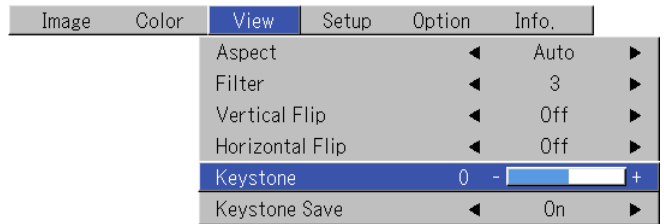
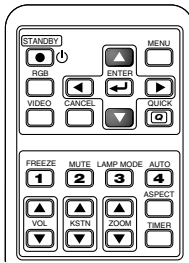

Items for which the **☑** Icon Is Displayed

Press the ENTER button to display the submenu.

Press the SELECT ▲▼ button and align the cursor with the desired item name.

There are also some items for which the setting display or the verification display will appear. Please see the various item descriptions.

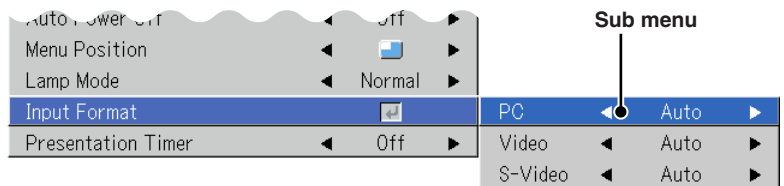
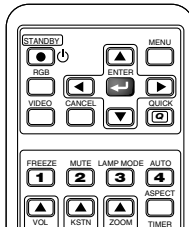

Making Adjustments/Settings

**5** Press the **SELECT ◀▶** button and make the adjustment (or setting) while viewing the image  
When a button is pressed, the image will also change.

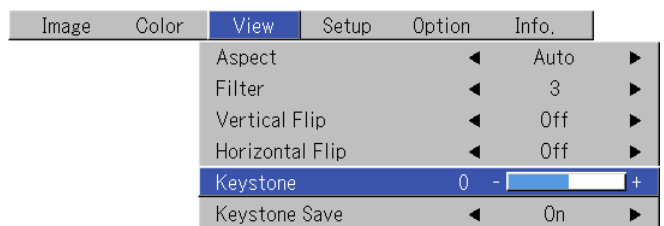
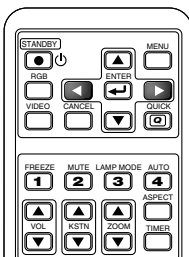

Adjustment display: Each press of the button results in a change of 1 point and continued presses cause changes to proceed in order.

Setting display: The setting contents display changes with each press of the button.



Closing the Menu

**6** Press the MENU button and close the menu display

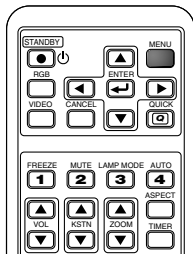

Selecting Another Menu Name with Remote Control Operation

When a sub menu is displayed, press the CANCEL button and close the sub menu.

Press the CANCEL button again to turn off the item name cursor.

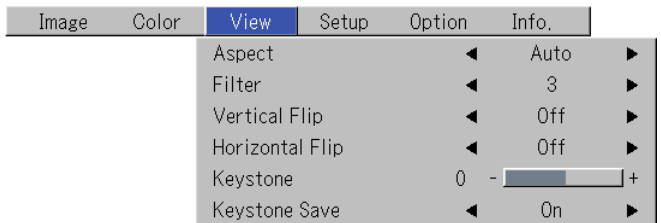
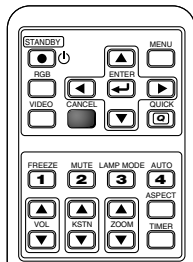
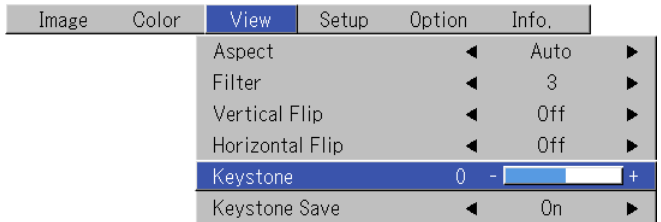

Press the SELECT ◀▶ button and select the menu name. (Menu names cannot be selected when the item name cursor is displayed.)

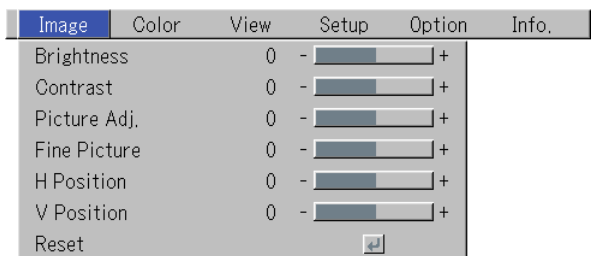
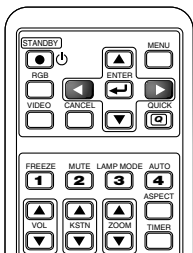

**Note:**

A press of the QUICK button while the menu is displayed will close the menu and display the quick menu. A press of the MENU button while the quick menu is displayed will close the quick menu and display the menu.

**List of Item Names Offering Input Selection and Adjustments/Settings**

The item names that can be adjusted/set will differ depending on the input signal.

[Example of Menu Display Items at the Time of Input Signal RGB Selection]

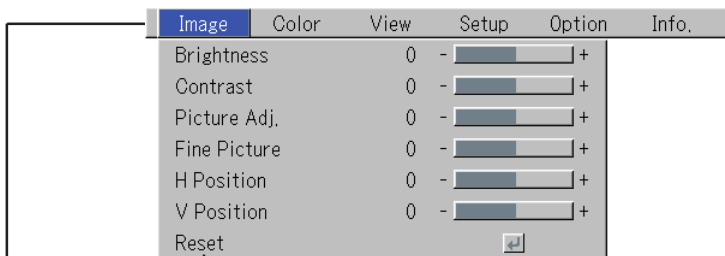

Menu name	Item Name	Sub Menu Item Name	Input Terminal		PC		VIDEO	Reference Page
			Component	Analog RGB	Digital RGB	VIDEO	S-VIDEO	
Image	Brightness		<input type="radio"/>	<input type="radio"/>	<input type="radio"/>	<input type="radio"/>	<input type="radio"/>	E-42
	Contrast		<input type="radio"/>	<input type="radio"/>	<input type="radio"/>	<input type="radio"/>	<input type="radio"/>	E-42
	Color		<input type="radio"/>	<input type="radio"/>	<input type="radio"/>	<input type="radio"/>	<input type="radio"/>	E-42
	Tint		<input type="radio"/>	<input type="radio"/>	<input type="radio"/>	<input type="radio"/>	<input type="radio"/>	E-42
	Sharpness		<input type="radio"/>	<input type="radio"/>	<input type="radio"/>	<input type="radio"/>	<input type="radio"/>	E-42
	Picture Adj.		<input type="radio"/>	<input type="radio"/>	<input type="radio"/>	<input type="radio"/>	<input type="radio"/>	E-42
	Fine Picture		<input type="radio"/>	<input type="radio"/>	<input type="radio"/>	<input type="radio"/>	<input type="radio"/>	E-43
	H Position		<input type="radio"/>	<input type="radio"/>	<input type="radio"/>	<input type="radio"/>	<input type="radio"/>	E-43
	V Position		<input type="radio"/>	<input type="radio"/>	<input type="radio"/>	<input type="radio"/>	<input type="radio"/>	E-43
	Reset		<input type="radio"/>	<input type="radio"/>	<input type="radio"/>	<input type="radio"/>	<input type="radio"/>	E-43
Color	Quick Color Adj.		<input type="radio"/>	<input type="radio"/>	<input type="radio"/>	<input type="radio"/>	<input type="radio"/>	E-44
	Gamma		<input type="radio"/>	<input type="radio"/>	<input type="radio"/>	<input type="radio"/>	<input type="radio"/>	E-44
	Color Temp.		<input type="radio"/>	<input type="radio"/>	<input type="radio"/>	<input type="radio"/>	<input type="radio"/>	E-45
	White		<input type="radio"/>	<input type="radio"/>	<input type="radio"/>	<input type="radio"/>	<input type="radio"/>	E-45
	Color Space		<input type="radio"/>	<input type="radio"/>	<input type="radio"/>	<input type="radio"/>	<input type="radio"/>	E-45
	White Balance		<input type="radio"/>	<input type="radio"/>	<input type="radio"/>	<input type="radio"/>	<input type="radio"/>	E-46
View	Aspect		<input type="radio"/>	<input type="radio"/>	<input type="radio"/>	<input type="radio"/>	<input type="radio"/>	E-47
	Filter		<input type="radio"/>	<input type="radio"/>	<input type="radio"/>	<input type="radio"/>	<input type="radio"/>	E-47
	Vertical Flip		<input type="radio"/>	<input type="radio"/>	<input type="radio"/>	<input type="radio"/>	<input type="radio"/>	E-48
	Horizontal Flip		<input type="radio"/>	<input type="radio"/>	<input type="radio"/>	<input type="radio"/>	<input type="radio"/>	E-48
	Keystone		<input type="radio"/>	<input type="radio"/>	<input type="radio"/>	<input type="radio"/>	<input type="radio"/>	E-48
	Keystone Save		<input type="radio"/>	<input type="radio"/>	<input type="radio"/>	<input type="radio"/>	<input type="radio"/>	E-48

\* "Tint" can be adjusted only at the time of NTSC composite/S signal input.

\* The color space can only be adjusted with high definition TVs.

\* The "Real" setting under "Aspect" for digital RGB signals can only be adjusted when the input signal is of XGA size or smaller.

## Menu Operation Method

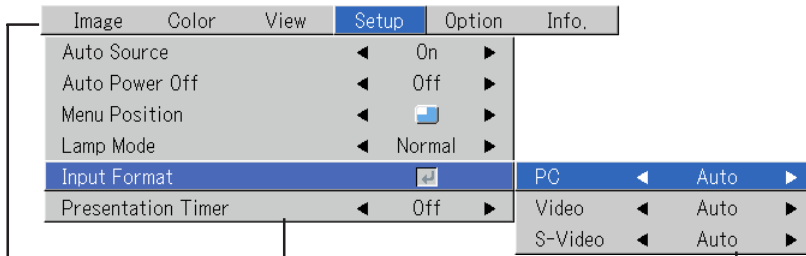

Menu name	Item Name	Sub Menu Item Name	Input Terminal		PC		VIDEO		Reference Page	
			Input Signal Component	Analog RGB	Digital RGB	VIDEO	S-VIDEO			
Setup	Auto Source		<input type="radio"/>	<input type="radio"/>	<input type="radio"/>	<input type="radio"/>	<input type="radio"/>	<input type="radio"/>	E-49	
	Auto Power Off		<input type="radio"/>	<input type="radio"/>	<input type="radio"/>	<input type="radio"/>	<input type="radio"/>	<input type="radio"/>	E-49	
	Menu Position		<input type="radio"/>	<input type="radio"/>	<input type="radio"/>	<input type="radio"/>	<input type="radio"/>	<input type="radio"/>	E-49	
	Lamp Mode		<input type="radio"/>	<input type="radio"/>	<input type="radio"/>	<input type="radio"/>	<input type="radio"/>	<input type="radio"/>	E-50	
	Input Format		PC	<input type="radio"/>	<input type="radio"/>	<input type="radio"/>	<input type="radio"/>	<input type="radio"/>	<input type="radio"/>	E-50
			Video	<input type="radio"/>	<input type="radio"/>	<input type="radio"/>	<input type="radio"/>	<input type="radio"/>	<input type="radio"/>	E-50
S-Video			<input type="radio"/>	<input type="radio"/>	<input type="radio"/>	<input type="radio"/>	<input type="radio"/>	<input type="radio"/>	E-50	
Presentation Timer		<input type="radio"/>	<input type="radio"/>	<input type="radio"/>	<input type="radio"/>	<input type="radio"/>	<input type="radio"/>	E-50		
Option	Language		<input type="radio"/>	<input type="radio"/>	<input type="radio"/>	<input type="radio"/>	<input type="radio"/>	<input type="radio"/>	E-51	
	On Screen		<input type="radio"/>	<input type="radio"/>	<input type="radio"/>	<input type="radio"/>	<input type="radio"/>	<input type="radio"/>	E-51	
	Background		<input type="radio"/>	<input type="radio"/>	<input type="radio"/>	<input type="radio"/>	<input type="radio"/>	<input type="radio"/>	E-51	
	Startup Screen		<input type="radio"/>	<input type="radio"/>	<input type="radio"/>	<input type="radio"/>	<input type="radio"/>	<input type="radio"/>	E-52	
	Security Lock		<input type="radio"/>	<input type="radio"/>	<input type="radio"/>	<input type="radio"/>	<input type="radio"/>	<input type="radio"/>	E-52	
Info.	Status		<input type="radio"/>	<input type="radio"/>	<input type="radio"/>	<input type="radio"/>	<input type="radio"/>	<input type="radio"/>	E-53	
	Factory Default		<input type="radio"/>	<input type="radio"/>	<input type="radio"/>	<input type="radio"/>	<input type="radio"/>	<input type="radio"/>	E-53	
	Lamp Timer Reset		<input type="radio"/>	<input type="radio"/>	<input type="radio"/>	<input type="radio"/>	<input type="radio"/>	<input type="radio"/>	E-53	
	Resolution		<input type="radio"/>	<input type="radio"/>	<input type="radio"/>	<input type="radio"/>	<input type="radio"/>	<input type="radio"/>	E-54	
	Frequency		<input type="radio"/>	<input type="radio"/>	<input type="radio"/>	<input type="radio"/>	<input type="radio"/>	<input type="radio"/>	E-54	
	Lamp Timer		<input type="radio"/>	<input type="radio"/>	<input type="radio"/>	<input type="radio"/>	<input type="radio"/>	<input type="radio"/>	E-54	

# Image

- Perform this operation while projecting the picture for which the adjustment/setting will be made.
- Select the menu name "Image".  
See "Menu Operation Method" on Page E-35 for information about performing menu operations. The item name display will differ depending on the input signal. See "List of Item Names Offering Input Selection and Adjustments/Settings" on Page E-40.

## Brightness / Contrast / Color / Tint / Sharpness

Picture qualities such as brightness and contrast will change depending on the whether the room is bright or dark. Please adjust to suit your preference.

Select the desired item name and then adjust with the SELECT ◀▶ buttons.

Item Name	SELECT ◀ Button	SELECT ▶ Button
Brightness	Darker	Brighter
Contrast	Less contrast	More contrast
Color	Less dense color	Denser color
Tint	More red	More green
Sharpness	Softer image	Sharper image

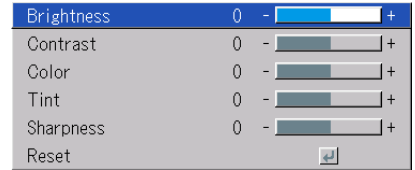

**Note:**

- \* The adjustment values of the adjustable items are stored according to input source.
- \* "Tint" can only be adjusted when inputting NTSC composite/S-Video signals or component signals.

## Picture Adj. / Fine Picture / H Position / V Position

Usually, automatic adjustment is performed at the time of signal selection, but when automatic adjustment is not effective, these adjustments can be performed.

**Note:**

When the image extends beyond the boundaries of the screen or is smaller than the screen, check that the "View" → "Aspect" setting is set to "Auto". See "Aspect" on Page E-47.

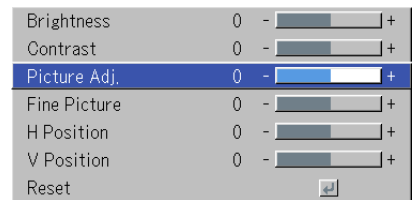

### Picture Adj. (Picture Adjustment)

Adjust this when bright and dark vertical bands appear on the screen.

Select the "Picture Adj." item name and adjust with the SELECT ◀▶ buttons so that the vertical bands disappear and brightness becomes uniform across the screen.

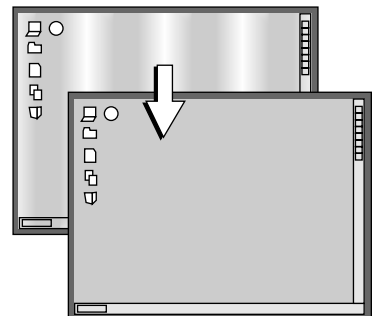

## Image

### Fine Picture

Adjust this when the picture shows a lack of color fidelity or flickering.

Select the "Fine Picture" item name and adjust with the SELECT ◀▶ buttons so that the lack of color fidelity or the flickering disappears.

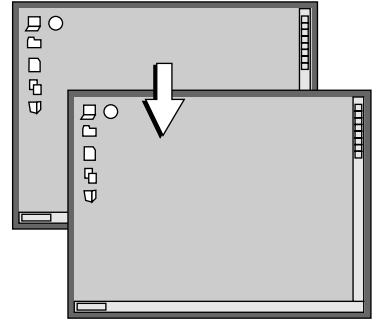

### H Position

Adjust this when the picture is shifted to the left or right.

Select the "H Position" item name and adjust with the SELECT ◀▶ buttons.

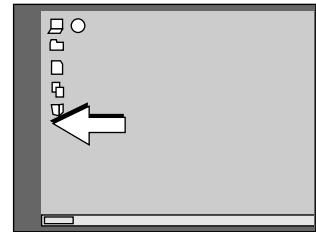

### V Position

Adjust this when the picture is shifted up or down.

Select the "V Position" item name and adjust with the SELECT ◀▶ buttons.

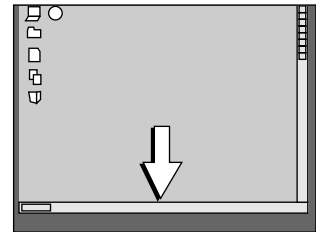

## Reset

This function resets (i.e., returns to the standard settings) the adjustment/setting value of the "Image" menu name.

A press of the ENTER button forces the reset.

Brightness	0	-	+
Contrast	0	-	+
Picture Adj.	0	-	+
Fine Picture	0	-	+
H Position	0	-	+
V Position	0	-	+
Reset			

#### Note:

\* The item name "Fine Picture" at the time of RGB input will not be reset.

\* "Reset" of the menu name "Image" can be reset for each input source.

\* To reset the adjustments/settings of all the menu items (while noting that there are some items that cannot be reset), see "Factory Default" on Page E-53.

# Color

- Do the following operation while displaying the image you want to adjust or set.
- Select the menu name “Color”.  
See “Menu Operation Method” on Page E-35 for information about performing menu operations. The item name display will differ depending on the input signal. See “List of Item Names Offering Input Selection and Adjustments/Settings” on Page E-40.

## Quick Color Adj.

### Select the preset color mode.

Select the “Quick Color Adj.” item name and select the setting contents with the SELECT ◀▶ buttons.

Color ..... Select this to prioritize color.

Standard ..... Select this to prioritize brightness.

\* When “Color” or “Standard” is selected, the “Gamma”, “Color Temp.” and “White” adjustment items are displayed in gray and cannot be selected or adjusted.

Custom ..... “Gamma”, “Color Temp.” and “White” adjustment items can be selected and adjusted

\* The selected values for the different adjustment items are stored in the memory so the desired color adjustments can be set.

Quick Color Adj.	◀	Custom	▶
Gamma	◀	Normal	▶
Color Temp.	◀	Normal	▶
White	◀	Low	▶
White Balance			⏏

## Gamma

**Gamma corrects the proportion of change of the dark portions from the bright portions of the input signal.**

**Set this to reproduce natural color tone or to distinctly project a personal computer picture in a bright conference room.**

Select the “Gamma” item name and select the setting contents with the SELECT ◀▶ buttons.

Normal ..... Correction with standard settings

Natural ..... Corrects for natural color tones

Real ..... Corrects with emphasis on brightness

Quick Color Adj.	◀	Custom	▶
Gamma	◀	Normal	▶
Color Temp.	◀	Normal	▶
White	◀	Low	▶
White Balance			⏏

**Note:**

When “Color” or “Standard” is selected for “Quick Color Adj.”, the “Gamma” adjustment item is displayed in gray and cannot be selected or adjusted.

## Color

### Color Temp.

The screen color is affected by the color of the illumination and other extraneous light.

This function adjusts the white, which is the reference color for video equipment, and improves the quality of color reproduction. Adjustment can also be used to enhance skin colors.

Select the item name "Color Temp." and select the setting contents with the SELECT ◀▶ buttons.

Low ..... Produces warm whites (reddish)  
Medium ..... Produces warm whites (yellowish)  
Normal ..... Produces the white of sunlight  
High ..... Produces cool whites (bluish)

**Note:**

When "Color" or "Standard" is selected for "Quick Color Adj.", the "Color Temp." adjustment item is displayed in gray and cannot be selected or adjusted. See "Quick Color Adj." on E-44.

Quick Color Adj.	◀	Custom	▶
Gamma	◀	Normal	▶
Color Temp.	◀	Normal	▶
White	◀	Low	▶
White Balance			

### White

When projecting, this function is used to emphasize the whites of text or diagrams on the personal computer.

Select the item name "White" and use the SELECT ◀▶ buttons to select the setting contents.

Select the desired degree of white from among "Low", "Medium", and "High".

**Note:**

When "Color" or "Standard" is selected for "Quick Color Adj.", the "White" adjustment item is displayed in gray and cannot be selected or adjusted. See "Quick Color Adj." on E-44.

Quick Color Adj.	◀	Custom	▶
Gamma	◀	Normal	▶
Color Temp.	◀	Normal	▶
White	◀	Low	▶
White Balance			

### Color Space

Set this function when a component signal (YPbPr) is projected and the image is extremely red or extremely green.

Select the item name "Color Space" and use the SELECT ◀▶ buttons to select a color space setting that provides a normal image.

**Selection contents at the time of YPbPr input**

BT.709, SMPTE240

**Note:**

\* When the component signal undergoes conversion processing to red, green, and blue which express the image of the projector, the correct color cannot be reproduced unless a system compliant with the color difference conversion system of the input signal is used. Color Space serves to make this selection.

\* The color space can only be adjusted with high definition TVs.

Gamma	◀	Normal	▶
Color Temp.	◀	Normal	▶
White	◀	Low	▶
Color Space	◀	BT.709	▶

## White Balance

This function automatically adjusts the black level and the white level of the analog RGB input signal to suit the personal computer.

Quick Color Adj.	◀	Standard	▶
Gamma	◀	Normal	▶
Color Temp.	◀	Normal	▶
White	◀	Low	▶
White Balance 			

- 1 Select the item name [White Balance] and press the ENTER button.

The display will change to [Input Black Signal].

- 2 The screen background color of the connected personal computer will be set to black.
3. Press the ENTER button. The display will change to [Adjusting Black] and the black level will be adjusted.



- 4 The adjustment of the black level is completed and the display changes to [Input White Signal].
- 5 The screen background color of the connected personal computer will be set to white.
- 6 Press the ENTER button. The display will change to [Adjusting White] and the white level will be adjusted.



[White balance complete] is displayed for a while and the adjustment is completed.



# View

- Perform this operation while projecting the picture for which the adjustment/setting will be made.
- Select the menu name “View”.  
See “Menu Operation Method” on Page E-35 for information about performing menu operations. The item name display will differ depending on the input signal. See “List of Item Names Offering Input Selection and Adjustments/Settings” on Page E-40.

## Aspect

This function sets the horizontal and vertical picture proportions of the input signal.

Select the item name “Aspect” and select the setting contents with the SELECT ◀▶ buttons.

### Personal Computer Signal

- Auto ..... Automatically enlarges or reduces the image to project a full screen in a ratio of 4:3
- Direct ..... Maintains the aspect ratio and projects a picture of the maximum displayable size
- Real ..... Projects the input signal without pixel conversion

### Video Signals

- Auto ..... While maintaining the aspect ratio, projects a full screen so that no portions extend beyond the boundaries of the screen. The top and bottom of the 16:9 image becomes black.
- Wide ..... Projects to fill the full width with the entire image at 16:9. (This feature is used to project a squeezed image in a proper aspect ratio.)
- Zoom ..... Projects only the 4:3 portion within 16:9 image to fill the screen. (Portion that extend off screen is cut.)

See “Selection of Aspect Ratio” on Page E-27 for diagrams of projection screen images that correspond to the input signals.

#### Note:

The “Real” setting under “Aspect” for digital RGB signals can only be adjusted when the input signal is of XGA size or smaller.

#### Note:

Please note that using this monitor for the purpose of commercial gain or the attraction of public attention in a venue such as a coffee shop or hotel and projecting a 4:3 screen in wide mode or leaving a squeezed screen as a compressed image raises concern about the infringement of the copyright holder’s rights which are protected by copyright law.

Aspect	◀	Auto	▶
Filter	◀	3	▶
Vertical Flip	◀	Off	▶
Horizontal Flip	◀	Off	▶
Keystone	0	-	+ ▶
Keystone Save	◀	On	▶

## Filter

This function sets the sharpness when the input signal is adjusted to the resolution of the projector and enlarged or reduced.

Select the item name “Filter” and select the setting contents with the SELECT ◀▶ buttons.

Smaller numerical values result in a sharper picture and larger values result in a softer picture. Please select your desired setting value.

Aspect	◀	Auto	▶
Filter	◀	3	▶
Vertical Flip	◀	Off	▶
Horizontal Flip	◀	Off	▶
Keystone	0	-	+ ▶
Keystone Save	◀	On	▶

## Vertical Flip/Horizontal Flip

In selecting the method of projecting to the screen, these functions are set when the projector is in a rear screen installation.

Select the item name “Vertical Flip” or “Horizontal Flip” and select the setting contents with the SELECT ◀▶ buttons.

Aspect	◀	Auto	▶
Filter	◀	3	▶
Vertical Flip	◀	Off	▶
Horizontal Flip	◀	Off	▶
Keystone	0	-	+
Keystone Save	◀	On	▶

“Vertical Flip” Off  
“Horizontal Flip” Off



“Vertical Flip” Off  
“Horizontal Flip” On



“Vertical Flip” On  
“Horizontal Flip” On



“Vertical Flip” On  
“Horizontal Flip” Off

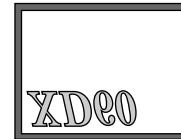

## Keystone

Keystone distortion will occur when the projector and screen are on an angle (in the vertical orientation). This function is used to correct this distortion.

Select the item name “Keystone” and correct the keystone distortion using the SELECT ◀▶ buttons.

Aspect	◀	Auto	▶
Filter	◀	3	▶
Vertical Flip	◀	Off	▶
Horizontal Flip	◀	Off	▶
Keystone	0	-	+
Keystone Save	◀	On	▶

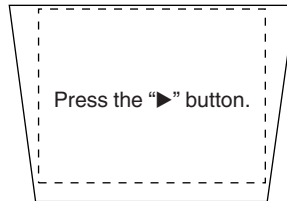
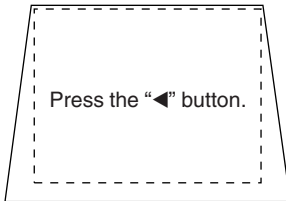

Pressing the button will cause the projection screen to be corrected toward the screen depicted by the dotted lines.

### Note:

- \* The menus and other on-screen displays cannot be adjusted.
- \* Please note that depending on the projected picture and the projection conditions, it may not be possible to eliminate keystone distortion completely.

## Keystone Save

This function is used to save the keystone adjustment values.

Setting Keystone Save to on will set the previous keystone adjustment values when projecting after the power cable has been disconnected and then reconnected.

Select the item name “Keystone Save” and set with the SELECT ◀▶ buttons.

Off ..... The keystone adjustment values return to the initial values when the power cable is unplugged.

On ..... The keystone adjustment values are retained in storage even when the power cable has been unplugged.

Aspect	◀	Auto	▶
Filter	◀	3	▶
Vertical Flip	◀	Off	▶
Horizontal Flip	◀	Off	▶
Keystone	0	-	+
Keystone Save	◀	On	▶

### Note:

Regardless of whether Keystone Save is set to “On” or “Off”, when projection is from the standby condition, the picture is projected using the previous keystone adjustment values.

# Setup

- **Select menu name “Setup”.**

See “Menu Operation Method” on Page E-35 for information about performing menu operations. The item name display will differ depending on the input signal. See “List of Item Names Offering Input Selection and Adjustments/Settings” on Page E-40.

## Auto Source

**The Auto Source function automatically detects the input signal when the power supply is switched on and when the input is switched.**

Select the item name “Auto Source” and select the setting contents with the SELECT ◀▶ buttons.

On ..... Switches on the automatic detection function

Off ..... Switches off the automatic detection function

Auto Source	◀	On	▶
Auto Power Off	◀	Off	▶
Menu Position	◀		▶
Lamp Mode	◀	Normal	▶
Input Format			
Presentation Timer	◀	Off	▶

### Signal Detection Order When On

The sequence of PC → VIDEO → S-VIDEO is searched repeatedly.

When a signal is detected, the search is stopped and the image is projected.



## Auto Power Off

**This function switches off the projector power automatically when the input of the projector enters a no-signal condition.**

Select item name “Auto Power Off” and select the setting contents with the SELECT ◀▶ buttons.

On ..... The power is switched off when there is no signal.

Off ..... The power is not switch off even when there is no signal.

Auto Source	◀	On	▶
Auto Power Off	◀	Off	▶
Menu Position	◀		▶
Lamp Mode	◀	Normal	▶
Input Format			
Presentation Timer	◀	Off	▶

### Operation when Function is On

- The “No Signal Power Off” display appears when a no-signal condition continues for approximately 10 seconds. The power is switched off about 5 minutes after this.
- If a signal is input during the appearance of the display and an operation button other than the STANDBY button is pressed, the display is closed and the function is cancelled.

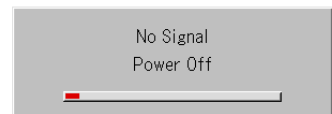

**Note:**

Some video decks and other equipment output a blue background or other video when playback ends. When this happens, a signal is being input to the projector and Auto Power Off is not activated.

## Menu Position

**This function sets the display position of the menu.**

Select item name “Menu Position” and select the setting contents with the SELECT ◀▶ buttons.

 ..... Displays on the left side

 ..... Displays on the right side

Auto Source	◀	On	▶
Auto Power Off	◀	Off	▶
Menu Position	◀		▶
Lamp Mode	◀	Normal	▶
Input Format			
Presentation Timer	◀	Off	▶

## Setup

### Lamp Mode

Use this if the picture is projected on a small screen and the picture is too bright or when projecting images in dark rooms.

Select the item name "Lamp Mode" and select the setting contents with the SELECT ◀▶ buttons.

- Low ..... The lamp brightness is set to 80% and the lamp life is extended.  
(STATUS indicator is green)
- Normal ..... The lamp brightness is set to 100% and the screen is bright.  
(STATUS indicator is off)

**Note:**

Frequent switching this mode can degrade the lamp.

Auto Source	◀ On ▶
Auto Power Off	◀ Off ▶
Menu Position	◀ [Menu] ▶
Lamp Mode	◀ Normal ▶
Input Format	[Input]
Presentation Timer	◀ Off ▶

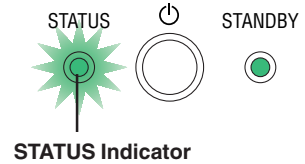

### Input Format

This function is used in setting the input signals of the input connectors.

Normally, this should be set to Auto. When identification is not possible with Auto, make the setting.

Select the item name "Input Format", press the ENTER button, and the sub menu will open.

Select the connector that is to be changed, and select the setting contents with the SELECT ◀▶ buttons.

**[PC]**

This is the signal setting for the DVI connector.

- Auto ..... Automatically identifies the signal.
- RGB ..... Analog RGB signal is set.
- Digital ..... Digital RGB signal is set.
- Component . Component signal is set.

Auto Source	◀ On ▶
Auto Power Off	◀ Off ▶
Menu Position	◀ [Menu] ▶
Lamp Mode	◀ Normal ▶
Input Format	[Input]
Presentation Timer	◀ Off ▶

PC	◀ Auto ▶
Video	◀ Auto ▶
S-Video	◀ Auto ▶

**[Video] and [S-Video]**

["Video" and "S-Video" are the color format settings for the VIDEO connector.

- Auto ..... Automatic identification.
- NTSC ..... Fixed to the NTSC system.
- NTSC 4.43 .. Fixed to the NTSC 4.43 system.
- PAL ..... Fixed to the PAL system.
- PAL M ..... Fixed to the PAL M system.
- PAL N ..... Fixed to the PAL N system.
- PAL 60 ..... Fixed to the PAL 60 system.
- SECAM ..... Fixed to the SECAM system.

**Note:**

\* When the input format has been switched, you may be required to reconnect the input signal.

\* The picture may be disturbed when the input format is switched or when the mode is set back to auto. This is not a malfunction. The picture will return to normal when the input is switched, etc.

### Presentation Timer

The presentation is given while checking the timer displayed on the screen.

The gauge display allows the remaining time to be known at a glance.

Select the item name "Presentation Timer" and select the setting contents with the SELECT ◀▶ buttons.

**Setting contents:** Off, 10 min., 20 min., 30 min., 40 min., 50 min., 60 min.

**To start the timer...**

Press the MENU button and open the menu.

The timer display will appear at the lower right and the timer will start.

See "Using the Presentation Timer" on Page E-31 for details.

Auto Source	◀ On ▶
Auto Power Off	◀ Off ▶
Menu Position	◀ [Menu] ▶
Lamp Mode	◀ Normal ▶
Input Format	[Input]
Presentation Timer	◀ Off ▶

# Option

- **Select menu name “Option”.**

See “Menu Operation Method” on Page E-35 for information about performing menu operations. The item name display will differ depending on the input signal. See “List of Item Names Offering Input Selection and Adjustments/Settings” on Page E-40.

## Language

**This function sets the language that is displayed on screen in the messages and menu displays.**

Select item name “Language” and press the ENTER button to open the Language sub menu.

Select the language with the SELECT ▲▼ buttons.

Language		English
On Screen	◀ On ▶	Deutsch
Background	◀ Blue ▶	Français
Startup Screen	◀ Logo ▶	Italiano
Security Lock	◀ Disable ▶	Español
		Svenska
		한국어
		中文
		日本語

## On Screen

**This function switches on/off the messages displayed with a black frame such as the input signal information and the aspect ratio.**

Select item name “On Screen” and select the setting contents with the SELECT ◀▶ buttons.

On ..... The message is displayed.

Off ..... The message is not displayed.

**Note:**

*Even when set to off, messages that are not in a black frame will be displayed.*

Language		
On Screen	◀ On ▶	
Background	◀ Blue ▶	
Startup Screen	◀ Logo ▶	
Security Lock	◀ Disable ▶	

Example of a display when the ASPECT button is pressed

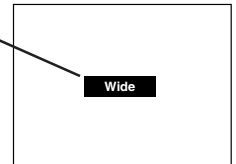

## Background

**This function sets the screen color when the input source is no-signal.**

Select item name “Background” and select the setting contents with the SELECT ◀▶ buttons.

Blue ..... Sets a blue screen when there is no signal

Black ..... Sets a black screen when there is no signal

Language		
On Screen	◀ On ▶	
Background	◀ Blue ▶	
Startup Screen	◀ Logo ▶	
Security Lock	◀ Disable ▶	

## Option

---

### Startup Screen

This is the selection of whether or not to display the logo screen at startup time.

Select item name "Startup Screen" and select the setting contents with the SELECT ◀▶ buttons.

Logo ..... Displays the logo.

Blank ..... Does not display the logo.

**Note:**

When "Logo" is selected at the startup screen, the "PROJECTOR XD60" logo is displayed.

Language		
On Screen	◀	On ▶
Background	◀	Blue ▶
Startup Screen	◀	Logo ▶
Security Lock	◀	Disable ▶

### Security Lock

A password can be registered and the security lock set in order to prevent unauthorized use of the projector.

For instructions on using the security function, see "Protecting the Projector with the Security Lock" on E-32.

Select item name "Security Lock" and select the setting contents with the SELECT ◀▶ buttons.

Disable ..... The security lock is disabled.

The projector can be operated without inputting the password.

Enable ..... The security lock is enabled.

The security lock is activated when the power is turned on, and the password must be input in order to operate the projector.

Language		
On Screen	◀	On ▶
Background	◀	Blue ▶
Startup Screen	◀	Logo ▶
Security Lock	◀	Disable ▶

# Info.

- **Select menu name “Info.”**

See “Menu Operation Method” on Page E-35 for information about performing menu operations. The item name display will differ depending on the input signal. See “List of Item Names Offering Input Selection and Adjustments/Settings” on Page E-40.

## Status

**This displays information about the equipment.**

Select item name “Status” and press the ENTER button.  
There is a change to the status display.  
Press the CANCEL button to return to the menu.

**Display Contents:**  
Projector model, firmware version.

Status	
Factory Default	
Lamp Timer Reset	
Resolution	1024 X 768
Frequency	60 Hz, 78KHz
Lamp Timer	1000 h

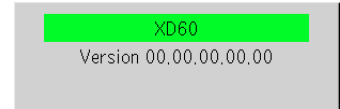

## Factory Default

**This function returns the adjustments and settings of all the input sources to the standard factory default values.**

Select item name “Factory Default” and press the ENTER button.  
There is a change to the display [Press “ENTER” to Factory Default Set].

Press the ENTER button to initialize.  
To cancel, press the CANCEL button and there will be a return to the menu.

**Items that are not set to the factory default:**  
Vertical Flip/Horizontal Flip, Language and Lamp Timer and Security.

Status	
Factory Default	
Lamp Timer Reset	
Resolution	1024 X 768
Frequency	60 Hz, 78KHz
Lamp Timer	1000 h

Press “ENTER” to FactoryDefault Set

## Lamp Timer Reset

**This function resets the lamp timer. Be sure to perform the reset operation when the lamp cartridge has been replaced.**

Select item name “Lamp Timer Reset” and press the ENTER button.

There is a change to the display “Press “ENTER” to Lamp Timer Reset”.

Press the ENTER button to initialize.  
To cancel, press the CANCEL button and there will be a return to the menu.

Status	
Factory Default	
Lamp Timer Reset	
Resolution	1024 X 768
Frequency	60 Hz, 78KHz
Lamp Timer	1000 h

Press “ENTER” to LampTimer Reset

## Info.

---

### Resolution / Frequency

This function displays the resolution and frequency of the detected input signal.

Status	
Factory Default	
Lamp Timer Reset	
Resolution	1024 X 768
Frequency	60 Hz, 78KHz
Lamp Timer	1000 h

### Lamp Timer

This displays the lamp timer.

This projector has Lamp mode function. The lamp life will differ between Normal mode and Low mode.

#### Lamp Life

Use only in Normal mode: approx.1500 hours

Use only in Low mode: approx.2000 hours

\* Lamp life will differ when there has been switching between the modes.

Status	
Factory Default	
Lamp Timer Reset	
Resolution	1024 X 768
Frequency	60 Hz, 78KHz
Lamp Timer	1000 h

- **When Lamp Life Has Been Reached**

“Replace the Lamp Cartridge” is displayed on the screen for 10 seconds in a 1-minute interval.

Please replace the lamp with a new one.

See “Replacing the Lamp Cartridge” on Page E-58 for information about lamp cartridge replacement.

- **When Over 100 Hours Have Elapsed Since Reaching Lamp Life (Including Low Mode)**

[Warning!! System Shutdown] is displayed for 10 seconds and the power is switched off. Pressing the STANDBY button under this condition will not switch on the power. Please replace the lamp cartridge.

---





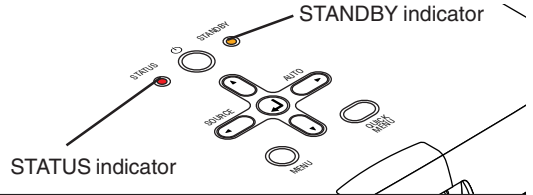

# When an Indicator is Lit or Blinking

The indicators on the projector's control panel lit or blink to notify of problems, as described below.

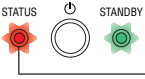
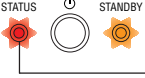
An indicator is also used to notify you of the currently set power mode (under normal circumstances). See "Power Cable Connections and Switching the Power On/Off" on page E-21.

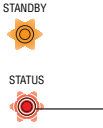

Indicator status	What you should do
 <p><b>When the power is on</b> (Lit green)  <b>Standby</b> (Lit amber)                      Lit red</p>	<p><b>It is time to replace the lamp.</b>                      Replace with a new lamp cartridge.</p>
 <p>Blinks amber for 60 seconds, then lit amber                      Lit red</p>	<p><b>The lamp has reached the end of its service life. The power will no longer turn on.</b>                      The projector can be used for 100 hours after the lamp has reached the end of its service life.                      Replace with a new lamp cartridge.</p>
 <p>Lit red                      Blinks red                      (lit for 1 seconds/off for 1 seconds)</p>	<p><b>The lamp cover is open.</b>                      The lamp cover is not properly mounted. After unplug the power cable and mount the cover properly, plug it again.</p>
 <p>Lit red                      Blinks red                      (lit for 0.5 seconds/off for 0.5 seconds)</p>	<p><b>The temperature is abnormally high.</b></p> <ul style="list-style-type: none"> <li>The temperature protector has been activated. If the room temperature is high, move the projector to a cool place. If the projector's internal temperature is high, check the cooling fan's ventilation slots and clean them if they are clogged.</li> <li>When the temperature protector is activated, the power turns off and in some cases will not turn back on immediately. In this case wait about 90 seconds, then try again.</li> </ul>
 <p>Lit amber                      Blinks red                      (lit for 0.5 seconds/off for 0.5 seconds)</p>	<p><b>The fan has stopped.</b>                      Unplug the power cable and contact a store that sells the XD60U for repairs.</p>
 <p><b>When the lamp has burned out during use</b>                      Blinks amber for 90 seconds, then lit amber  <b>When the lamp does not come on from the start</b>                      Lit amber                      Blinks red                      (lit for 1 seconds/off for 1 seconds)</p>	<p><b>The lamp will not light.</b>                      Wait at least 90 seconds, then turn the power back on. If the problem persists, unplug the power cord and contact a store that sells the XD60U for repairs.</p>

Should an indicator be in a condition other than normal or flash at a rate other than the aforementioned, disconnect the power cable and contact your store of purchase.

## Thermal Protector

When the temperature inside the projector becomes abnormally high, the STATUS indicator blinks red (0.5 seconds on/0.5 seconds off), the STANDBY indicator is a steady red, and at the same time the temperature protector operates and switches off the power of the projector.

Should this happen, please take the following actions.

**1. Switch off the power and disconnect the power plug from the wall outlet.**

**2. Check the following matters and take the required measures.**

When the projector is being used in a location that has a high ambient temperature, set it up again in a cool location. Check the outflow and intake holes and clean them if they are obstructed.

**3. Wait about 60 minutes until the temperature of the projector drops.**

If after having performed the above matters, the problem still has not been solved, please contact your store of purchase.

# Troubleshooting

Check the following matters before requesting servicing.

Problem	Check	Reference Page
<b>Power does not turn on</b>	<ul style="list-style-type: none"> <li>Is the power cord plugged into a power outlet?</li> <li>Is the lamp cover properly mounted?</li> <li>Is the projector's temperature high? To protect the projector, the power cannot be turned on when the projector's temperature is abnormally high.</li> <li>Has the lamp reached the end of its service life?</li> <li>Depending on the timing with which the power cord is plugged in (the power is turned on), it may happen that the STANDBY indicator (LED) does not light and the power does not turn on. This is not a malfunction. If this happens, unplug the power cord then plug it back in.</li> </ul>	<p>E-21 E-60 E-55</p> <p>E-55 —</p>
<b>No image is produced</b>	<ul style="list-style-type: none"> <li>Is a connected input selected?</li> <li>Is the cable properly connected to the input terminal?</li> <li>When a computer is connected, are signals being output from the computer?</li> <li>Does the signal being input have a frequency usable with this projector?</li> <li>Are the brightness and contrast adjusted to the minimum?</li> <li>Is the STATUS indicator lit a steady red or blinking red?</li> <li>When the component signal of the DVD player is connected with the DVI connector and the image is not output, is [Input Settings] of the DVI connector properly selected?</li> <li>For a analog RGB input, has the picture been properly adjusted?</li> </ul>	<p>E-50 E-15–20 E-17 E-62 E-42 E-55 E-50</p> <p>E-42, 43</p>
<b>Image is distorted</b>	<ul style="list-style-type: none"> <li>Is the projector properly installed?</li> <li>For trapezoidal (keystone) distortion, perform keystone adjustment.</li> </ul>	<p>E-24 E-29, 48</p>
<b>Image is out of focus</b>	<ul style="list-style-type: none"> <li>Is the lens properly focused?</li> <li>Are the screen and projector installed at the proper distance?</li> <li>Does the projection distance exceed the focusing range?</li> <li>Is there condensation on the lens, etc.?</li> </ul> <p>If the projector is moved from a cool storage area to a warm place and the power is turned on, condensation may form on the lens or internal optical parts. If this happens, wait until the condensation has evaporated before using the projector.</p>	<p>E-25 E-14 E-14 —</p>
<b>Image is not in proper position and is not displayed properly</b>	<ul style="list-style-type: none"> <li>For a computer input, are the horizontal and vertical positions properly adjusted?</li> <li>Does the input signal have a compatible resolution and frequency? Check the computer's resolution.</li> </ul>	<p>E-43 E-62</p>
<b>Video image is crushed</b>	<ul style="list-style-type: none"> <li>If the image is crushed in the horizontal or vertical direction or if it is not displayed over the entire screen, select a different aspect ratio.</li> </ul>	E-27
<b>Colors of the overall image are strange</b>	<ul style="list-style-type: none"> <li>When a component signal is being input, is the color space setting proper?</li> <li>For a composite input, is the hue properly adjusted?</li> </ul>	<p>E-45 E-42</p>
<b>Characters flicker or colors are offset for analog RGB inputs</b>	<ul style="list-style-type: none"> <li>From the menu, select "Picture" and adjust the clock frequency and phase.</li> </ul>	E-42, 43
<b>Cannot select the menu name</b>	<ul style="list-style-type: none"> <li>Other than [Settings] and [Information], selection will not be possible unless a signal is being input to the projector and the image/picture is projected.</li> </ul>	—
<b>Remote control unit does not operate</b>	<ul style="list-style-type: none"> <li>Are the remote control unit's batteries worn? Replace with new batteries.</li> <li>Is there an obstacle between the remote control unit and the projector's remote control signal sensor?</li> <li>Is the remote control unit outside of range?</li> <li>Are you pointing the remote control unit's transmitter towards the projector's remote control signal sensor?</li> </ul>	<p>E-12 E-12</p> <p>E-12 E-12</p>
<b>STATUS indicator is lit red or blinking red</b>	<ul style="list-style-type: none"> <li>See "When an indicator is lit or blinking".</li> </ul>	E-55

# Cleaning

- Be certain to disconnect the power plug from the power outlet before cleaning.
- Do not spray or otherwise expose the projector, lens, or screen to volatile substances such as insecticides. Do not leave rubber or vinyl products in contact with the projector for long periods. Doing so could cause them to undergo qualitative changes or the coatings may peel, etc.

## Cleaning a Soiled Projector Main Unit

- Wipe with a lint-free, soft, dry cloth.  
When very dirty, wipe with a cloth that has been moistened with a diluted neutral detergent, then finish with a dry cloth. If a chemically-treated cloth is going to be used, please follow any written warnings.
- Do not wipe with thinner, benzene, or other solvents. Doing so could cause them to undergo qualitative changes or the coatings may peel, etc.
- When removing the dust of the outflow and intake holes, use the brush attachment on a vacuum cleaner to clean out the dust. Avoid using the vacuum directly without attaching the adapter as well as the use of a nozzle adapter.
- Do not scratch or otherwise hit the projector body with your nails or other hard object, since this will cause scratches.

## Dirty Lens

- Clean using the same method you would use to clean a camera lens: Use a commercial blower for camera use or cleaning paper for eye glasses. Be careful not to scratch the lens at this time.

## Dust of the Intake and Outflow Holes

Dust that collects in the intake and outflow holes will obstruct the ventilation and cause the internal temperature to rise which could cause damage. Clean this area carefully. As a guideline, clean at least every 100 hours of usage.

- Switch off the power, check that the STANDBY indicator has changed to a steadily lit amber, then unplug the power cable.
- Clean out the holes from the outside using a vacuum cleaner. Use the brush adapter of the vacuum cleaner to do this. Avoid using the vacuum directly without attaching the adapter as well as the use of a nozzle adapter.

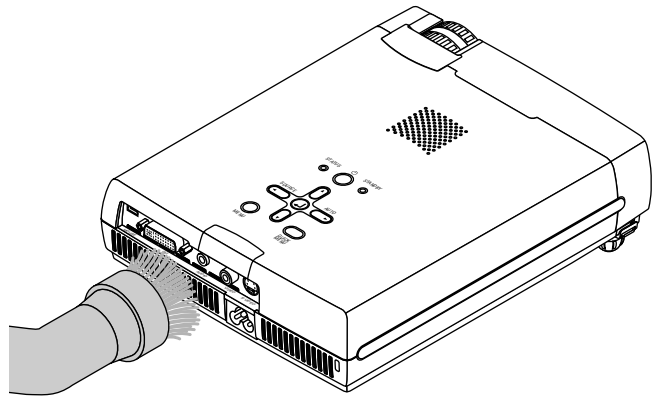

## Cleaning the Inside of the Projector

Cleaning of the inside of the projector is required about once a year. Failure to clean over a long period while dust has collected inside the projector could cause a fire or breakdown. Do not clean the inside of the projector by yourself. Please be sure to contact your dealer.

# Replacing the Lamp Cartridge

- The lamp that is used as a light source in the projector has a limited service life. The rated service life of the lamp is about 1500 hours (when used in normal mode only). This could be shortened depending on conditions of use and other factors.  
Note that lamp life will be extended when the projector is often used in Low mode. (The rated service life of the lamp means the average value of lamp life for lamps that have been manufactured over a long period, and it is derived from test conditions at this company.)
- When the life of the lamp is exceeded, the STATUS indicator lights a steady red and the message [Replace the Lamp Cartridge] is displayed on the screen. When this occurs, it is time to replace the lamp cartridge. Please make the replacement following the procedure below.
- If the projector is used another 100 hours after the lamp's service life is reached, the power is set to the standby mode and no longer turns on.
- Contact a store that sells the XD60U for a replacement lamp. Indicate you need a VLT-XD50LP replacement lamp for the XD60U (order code 915P018-10).

## CAUTION

- Replacement of the lamp cartridge is performed after switching off the power, waiting for the cooling fan to stop, disconnecting the power plug from the power outlet, and then leaving the projector for about 60 minutes before replacement is started. Replacement of the lamp cartridge during operation or immediately after operation stops will cause burns because of the high temperature.
- Do not remove any screws other than those specified.
- Do not touch the lamp with bare hands. Doing so could shorten the life of the lamp.
- If lamp has reached the end of its usable life, the lamp bulb may shatter. When this happens, an explosive sound can be heard and pieces of glass may be scattered in the lamp cartridge. Do not touch them as the pieces of glass may cause injury. If this happens, contact your dealer or the store the projector was purchased.

## Replacing the Lamp Cartridge

**Preparations:** Turning the projector upside-down on top of a soft cloth, etc., so that it does not get scratched makes it easier to replace the lamp cartridge. Turn the projector right-side up after replacing the lamp cartridge.

**1** Unplug the power cord.

**2** Turn the projector upside-down.

**3** Remove the lamp cover.

(1) Turn the lamp cover's set screw counterclockwise and loosen until the screw turns freely. (The screw does not come off.)

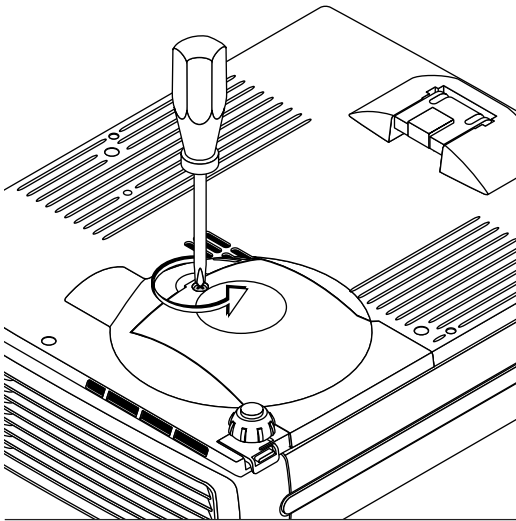

(2) Open the lamp cover a little, then pull it in the direction of the arrow and remove it.

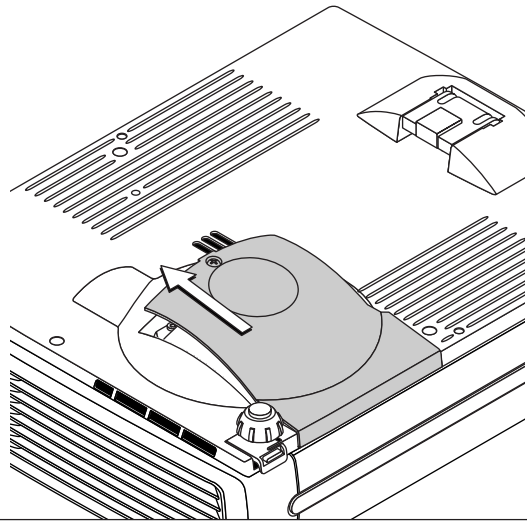

**4** Remove the lamp cartridge.

(1) Turn the lamp cartridge's two set screws counterclockwise and loosen them until the screws turn freely. (The screws do not come off.)

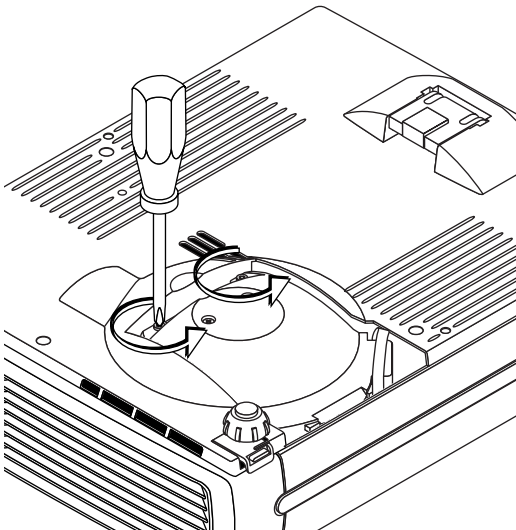

(2) Grasp the lamp cartridge's handle and pull upward to remove the lamp cartridge.

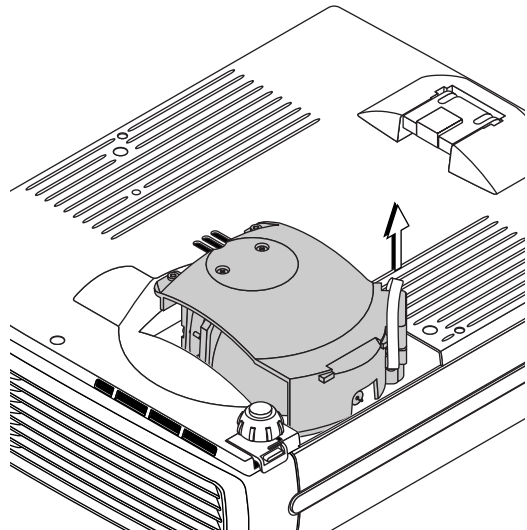

## Replacing the Lamp Cartridge

### 5 Mount the new lamp cartridge.

(1) Place the lamp cartridge with its socket facing to the right and push it in slowly.  
(Line it up with the screw holes in the projector.)

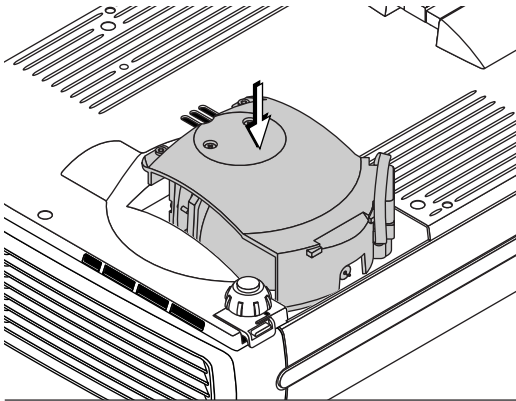

(2) Turn the two lamp cartridge screws clockwise to tighten them.

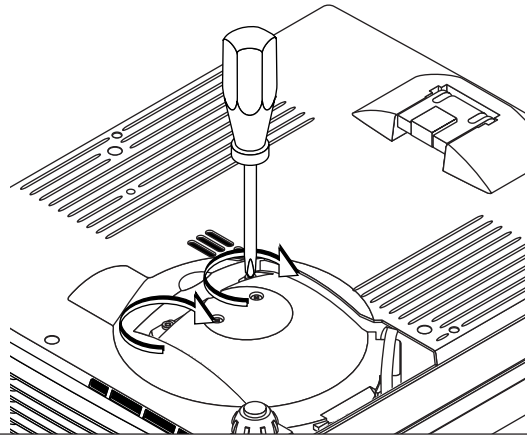

### 6 Mount the lamp cover.

(1) Set the tip of the lamp cover in place, then close the lamp cover.

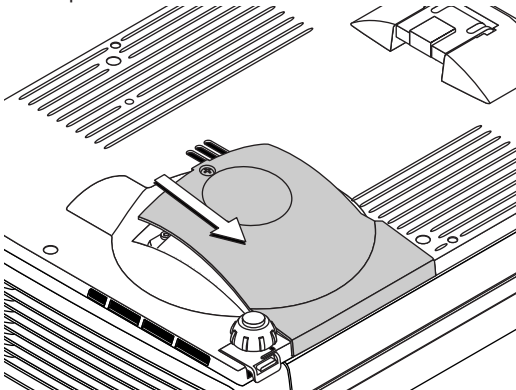

(2) Turn the lamp cover's screw clockwise to tighten it.

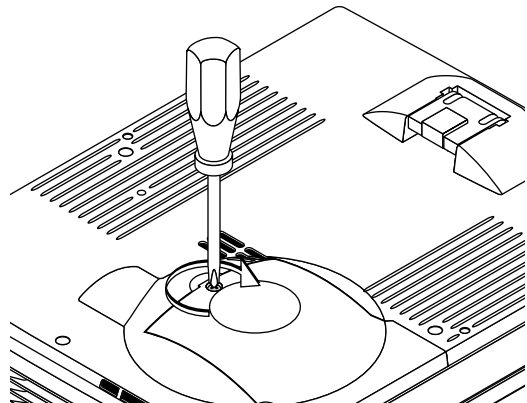

### 7 Reset the Lamp Timer.

Connect the power cable, switch on the power, and then reset.

Select [Info.] → [Lamp Timer Reset] on the menu and press the ENTER button. There is a change to the initialization verification display. Press the ENTER button again. See "Lamp Timer Reset" on Page E-53.

#### Note:

After reaching the lamp service life, if the lamp is used for more than another 100 hours, it will not be possible to switch on the power. Should this happen, while the projector is in the standby mode, simultaneously holding down the projector's SOURCE button and AUTO button for more than 5 seconds will clear the lamp timer. Checking that the STATUS indicator is out will show that the lamp timer has been cleared. Contact a store that sells the XD60U for a replacement lamp. Indicate you need a VLT-XD50LP replacement lamp for the XD60U (order code 915P018-10).

#### CAUTION

This projector uses a lamp that contains mercury. Disposal of the lamp or the projector with the lamp may be regulated due to environmental considerations. For disposal or recycling information, please contact your local authorities or the Electronic Industries Alliance: [www.eiae.org](http://www.eiae.org). (For US only).

# Specifications

**Model** XD60U

## Optical

Method of projection : DLP™ (single chip DMD)  
DMD 0.7 inches 1024 × 768 dots  
Lamp 170 W high pressure mercury lamp  
Projection lens : Manual zoom (× 1.2), Manual focus F = 2.6 – 2.9, f = 27.5 – 33.0 mm  
Image size Minimum 26 inch (at projection distance of 1.20 m / 3.9 feet telephoto)  
Maximum 300 inch (at projection distance of 11.81 m / 38.76 feet wide)  
Light Output 1800 lumens  
Contrast Ratio 2000:1 (Full on/off)

## Electrical

Inputs Video (NTSC3.58/NTSC4.43/PAL/PAL-N/PAL-M/PAL60/SECAM)  
RGB (Horizontal :15 to 80 kHz, Vertical 50 to 85 Hz)  
Color Reproduction Full color (16,770,000 colors)  
Resolution VGA (640 × 480) expansion/true, S-VGA (800 × 600) expansion/true  
XGA (1024 × 768) true, S-XGA (1280 × 1024) compression  
Input Current 2.4 A  
Power Requirement 100 - 240 V AC, 50/60 Hz  
Power Consumption 240 watts (170 watts in Low mode)

## Mechanical

Dimensions Excluding Stand 190 mm (W) × 53 mm (H) × 242 mm (D)  
7.5 in.(W) × 2.1 in.(H) × 9.5 in.(D)  
Weight Approximately 1.5 kg / 3.3 lbs  
Operational Temperatures Data projector: 5° to 35°C (41° to 95°F), 30 to 85% humidity

- Specifications and design are subject to change without notice.

# Table of Supported Frequencies

The projector automatically identifies the signal input from the computer and selects the optimum resolution as shown on the table below.

Manual adjustments may be required for some input signals. See "Picture Adj. / Fine Picture / H Position / V Position" on page E-42, 43.

Signal	Resolution	Frequency		Video	Component	Digital	Analog
		Horizontal (kHz)	Vertical (Hz)				
VIDEO(NTSC)	—	15.734	60.0	○	○	—	—
VIDEO(PAL/SECAM)	—	15.625	50.0	○	○	—	—
VESA	640 × 350	31.5	70.1	—	—	○	○
	640 × 350	37.9	85.1	—	—	○	○
	720 × 350	31.5	70.0	—	—	○	○
	640 × 400	31.5	70.1	—	—	○	○
	640 × 400	37.9	85.1	—	—	○	○
	720 × 400	31.5	70.0	—	—	○	○
	720 × 400	37.9	85.0	—	—	○	○
	640 × 480	31.5	60.0	—	—	○	○
	640 × 480	37.9	72.8	—	—	○	○
	640 × 480	37.5	75.0	—	—	○	○
	640 × 480	43.3	85.0	—	—	○	○
	800 × 600	35.2	56.3	—	—	○	○
	800 × 600	37.9	60.3	—	—	○	○
	800 × 600	46.9	75.0	—	—	○	○
	800 × 600	48.1	72.2	—	—	○	○
	800 × 600	53.7	85.1	—	—	○	○
	1024 × 768	48.4	60.0	—	—	○	○
	1024 × 768	56.5	70.1	—	—	○	○
1024 × 768	60.0	75.0	—	—	○	○	
1024 × 768	68.7	85.0	—	—	○	○	
1280 × 1024	64.0	60.0	—	—	○	○	
Apple Macintosh	640 × 480	35.0	66.7	—	—	○	○
	823 × 624	49.7	74.5	—	—	○	○
	1024 × 768	60.2	74.9	—	—	○	○
	1152 × 870	68.7	75.1	—	—	○	○
HDTV (1080i)	1920 × 1080	33.8	60.0	—	○	—	—
	1920 × 1080	28.1	50.0	—	○	—	—
(720p)	1280 × 720	45.0	60.0	—	○	—	—
SDTV (576p)	720 × 576	31.3	50.0	—	○	—	—
	(480p)	720 × 480	31.5	60.0	—	○	—

\* The projector does not support the ADC connector on Apple Macintosh.

○ : Supported frequency  
 — : Not supported frequency

The display resolution is 1024 × 768 dots. When displaying a signal with resolutions other than 1024 × 768 dots such as 1280 × 1024, sizes of characters or lines may be uneven.



# Cabinet Dimensions

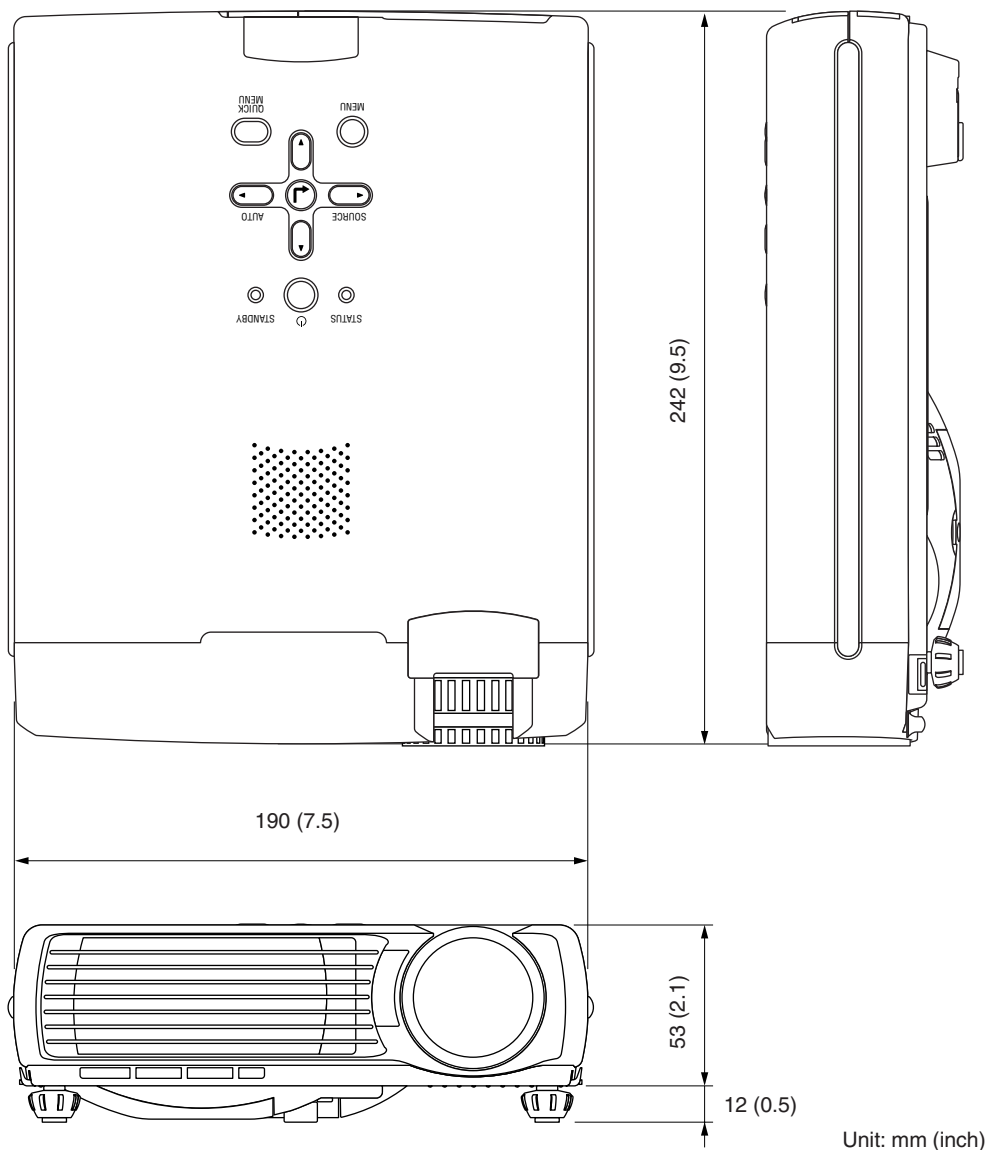

 **MITSUBISHI ELECTRIC CORPORATION**

1 Zusho Baba, Nagaokakyo-City, Kyoto Japan