

myprojectorlamps.com

**The most trusted, dependable name
in projector lamp sales.**



<http://www.myprojectorlamps.com>



<http://www.myprojectorlamps.ca>



<http://www.myprojectorlamps.eu>

The following projector manual has not been modified or altered in any way.

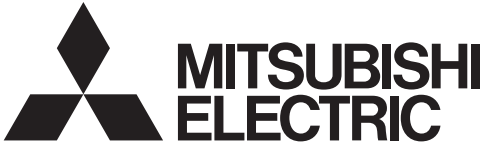

DATA PROJECTOR



MODEL

XD206U

User Manual

XD206U

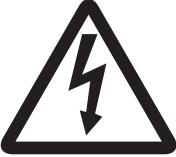
This User Manual is important to you.
Please read it before using your projector.

	CAUTION RISK OF ELECTRIC SHOCK DO NOT OPEN	
<p>CAUTION : TO REDUCE THE RISK OF ELECTRIC SHOCK,</p> <p>DO NOT REMOVE COVER (OR BACK) NO USER-SERVICEABLE PARTS INSIDE REFER SERVICING TO QUALIFIED SERVICE PERSONNEL.</p>		



The lightning flash with arrowhead symbol within an equilateral triangle is intended to alert the user to the presence of uninsulated "dangerous voltage" within the product's enclosure that may be of sufficient magnitude to constitute a risk of electric shock.

The exclamation point within an equilateral triangle is intended to alert the user to the presence of important operating and maintenance (servicing) instructions in the literature accompanying the appliance.

WARNING:

TO PREVENT FIRE OR SHOCK HAZARD, DO NOT EXPOSE THIS APPLIANCE TO RAIN OR MOISTURE.

CAUTION:

TO PREVENT ELECTRIC SHOCK, DO NOT USE THIS (POLARIZED) PLUG WITH AN EXTENSION CORD, RECEPTACLE OR OTHER OUTLET UNLESS THE BLADES CAN BE FULLY INSERTED TO PREVENT BLADE EXPOSURE.

NOTE:

SINCE THIS PROJECTOR IS PLUGGABLE EQUIPMENT, THE SOCKET-OUTLET SHALL BE INSTALLED NEAR THE EQUIPMENT AND SHALL BE EASILY ACCESSIBLE.

WARNING

Use the attached specified power supply cord. If you use another power supply cord, it may cause interference with radio and television reception.

Use the attached RGB cable with this equipment so as to keep interference within the limit of an FCC Class B device.

This apparatus must be grounded.

DO NOT LOOK DIRECTLY INTO THE LENS WHEN THE PROJECTOR IS IN THE POWER ON MODE.

CAUTION

Not for use in a computer room as defined in the Standard for the Protection of Electronic Computer/Data Processing Equipment, ANSI/NFPA 75.

The attached power cord is to be used exclusively for this product. Never use it for other products.

When using the projector in Europe:

COMPLIANCE NOTICE

This Projector complies with the requirements of the EC Directive 89/336/EEC "EMC Directive" as amended by Directive 92/31/EEC and 93/68/EEC, and 73/23/EEC "Low Voltage Directive" as amended by Directive 93/68/EEC.

The electro-magnetic susceptibility has been chosen at a level that gains proper operation in residential areas, on business and light industrial premises and on small-scale enterprises, inside as well as outside of the buildings. All places of operation are characterized by their connection to the public low voltage power supply system.

WARNING

Use the attached RGB cable with this equipment so as to keep interference within the limits of an EN55022 Class B device.

Please follow WARNING instructions.



Note: This symbol mark is for EU countries only.
This symbol mark is according to the directive 2002/96/EC Article 10 Information for users and Annex IV.

Your MITSUBISHI ELECTRIC product is designed and manufactured with high quality materials and components which can be recycled and reused.

This symbol means that electrical and electronic equipment, at their end-of-life, should be disposed of separately from your household waste.

Please, dispose of this equipment at your local community waste collection/recycling centre.

In the European Union there are separate collection systems for used electrical and electronic product.

Please, help us to conserve the environment we live in!

Important safeguards.....	4
Overview.....	6
Remote control	8
Installation	9
Basic connections.....	10
Preparation	12
Basic operation.....	13
Menu operation.....	15
Image adjustment	18
Advanced feature.....	20
Lamp replacement	22
Troubleshooting	23
Indicators	26
Specifications	27

Declaration of Conformity

Model Number : XD206U
Trade Name : MITSUBISHI ELECTRIC
Responsible party : Mitsubishi Digital Electronics America, Inc.
9351 Jeronimo Road, Irvine, CA 92618 U.S.A
Telephone number : +1-(949) 465-6000

This device complies with Part 15 of the FCC Rules. Operation is subject to the following two conditions:

- (1) this device may not cause harmful interference, and
- (2) this device must accept any interference received, including interference that may cause undesired operation.

Trademark, Registered trademark

Macintosh is registered trademark of Apple Computer Inc.
DLP™, Digital Micromirror Device and DMD are all trademarks of Texas Instruments.
Other brand or product names are trademarks or registered trademarks of their respective holders.

Important safeguards

Please read all these instructions regarding your projector and retain them for future reference. Follow all warnings and instructions marked on the projector.

1. **Read instructions**
All the safety and operating instructions should be read before the appliance is operated.
2. **Retain instructions**
The safety and operating instructions should be retained for future reference.
3. **Warnings**
All warnings on the appliance and in the operating instructions should be adhered to.
4. **Instructions**
All operating instructions must be followed.
5. **Cleaning**
Unplug this projector from the wall outlet before cleaning it. Do not use liquid aerosol cleaners. Use a damp soft cloth for cleaning.
6. **Attachments and equipment**
Never add any attachments and/or equipment without the approval of the manufacturer as such additions may result in the risk of fire, electric shock or other personal injury.
7. **Water and moisture**
Do not use this projector near water or in contact with water.
8. **Accessories**
Do not place this projector on an unstable cart, stand, tripod, bracket or table. Use only with a cart, stand, tripod bracket, or table recommended by the manufacturer or sold with the projector. Any mounting of the appliance should follow the manufacturer's instructions and should use a mounting accessory recommended by the manufacturer.



An appliance and cart combination should be moved with care. Quick stops, excessive force and uneven surfaces may cause the appliance and cart combination to overturn.

9. **Ventilation**
Slots and openings in the cabinet are provided for ventilation, ensuring reliable operation of the projector and to protect it from overheating. Do not block these openings or allow them to be blocked by placing the projector on a bed, sofa, rug, or bookcase. Ensure that there is adequate ventilation and that the manufacturer's instructions have been adhered to.
10. **Power sources**
This projector should be operated only from the type of power source indicated on the marking label. If you are not sure of the type of power, please consult your appliance dealer or local power company.
11. **Power-cord protection**
Power-supply cords should be routed so that they are not likely to be walked on or pinched by items placed upon or against them. Pay particular attention to cords at plugs, convenience receptacles, and points where they exit from the appliance. Do not put the power cord under a carpet.

12. **Overloading**
Do not overload wall outlets and extension cords as this can result in a fire or electric shock.
13. **Objects and liquids**
Never push objects of any kind through openings of this projector as they may touch dangerous voltage points or short-out parts that could result in a fire or electric shock. Never spill liquid of any kind on the projector.
14. **Servicing**
Do not attempt to service this projector yourself. Refer all servicing to qualified service personnel.
15. **Damage requiring service**
Unplug this projector from the wall outlet and refer servicing to qualified service personnel under the following conditions:
 - (a) If the power-supply cord or plug is damaged.
 - (b) If liquid has been spilled, or objects have fallen into the projector.
 - (c) If the projector does not operate normally after you follow the operating instructions. Adjust only those controls that are covered by the operating instructions. An improper adjustment of other controls may result in damage and may often require extensive work by a qualified technician to restore the projector to its normal operation.
 - (d) If the projector has been exposed to rain or water.
 - (e) If the projector has been dropped or the cabinet has been damaged.
 - (f) If the projector exhibits a distinct change in performance - this indicates a need for service.
16. **Replacement parts**
When replacement parts are required, be sure that the service technician has used replacement parts specified by the manufacturer or parts having the same characteristics as the original part. Unauthorized substitutions may result in fire, electric shock or other hazards.
17. **Safety check**
Upon completion of any service or repair to this projector, ask the service technician to perform safety checks determining that the projector is in a safe operating condition.

WARNING:**Unplug immediately if there is something wrong with your projector.**

Do not operate if smoke, strange noise or odor comes out of your projector. It may cause fire or electric shock. In this case, unplug immediately and contact your dealer.

Never remove the cabinet.

This projector contains high voltage circuitry. An inadvertent contact may result in an electric shock. Except as specifically explained in User Manual, do not attempt to service this product by yourself. Please contact your dealer when you want to fix, adjust, or inspect the projector.

Do not modify the projector.

It can lead to fire or electric shock.

Do not keep using the damaged projector.

If the projector is dropped and the cabinet is damaged, unplug the projector and contact your dealer for inspection. It may lead to fire if you keep using the damaged projector.

Do not face the projection lens to the sun.

It can lead to fire.

Use correct voltage.

If you use incorrect voltage, it can lead to fire.

Do not place the projector on uneven surface.

Place the projector on a level and stable surface only.

Do not look into the lens when the projector is operating.

It may hurt your eyes. Never let children look into the lens when the projector is on.

Do not unplug the power cord during operation.

It can lead to lamp breakage, fire, electric shock or other trouble. Wait for the fan to stop before unplugging the power cord.

Do not touch the air outlet grilles and bottom plate.

Do not touch them or put other equipment close to the air outlet grilles because they become hot during operation. The heated air outlet grilles and bottom plate may cause injury or damage to other equipment. Also, do not put the projector on a desk that is easily affected by heat.

Do not look into the air outlet grilles when projector is operating.

Heat, dust, etc. may blow out of them and hurt your eyes.

Do not block the air inlet and outlet grilles.

If they are blocked, heat may be generated inside the projector, causing deterioration in the projector quality and fire.

Do not use flammable solvents (benzene, thinner, etc.) and flammable aerosols near the projector.

Flammable substances may ignite causing fire or breakdown because the temperature inside the projector rises very high while the lamp is illuminating.

Place of installation

For safety's sake, do not use the projector at any place subjected to high temperature and high humidity. Please maintain an operating temperature, humidity, and altitude as specified below.

- Operating temperature: between +41°F (+5°C) and +95°F (+35°C)
- Operating humidity: between 30% and 90%
- Never put any heat-producing device under the projector to prevent the projector from being overheated.
- Do not install the projector at a place that is unstable or subject to vibration.
- Do not install the projector near any equipment that produces a strong magnetic field. Also refrain from installing the projector near any cable carrying a large amount of current.
- Place the projector on a solid, vibration-free surface. Otherwise it may fall, causing serious injury or damage.
- Do not stand the projector on its end. It may fall, causing serious injury or damage.
- Slanting the projector more than $\pm 10^\circ$ (right and left) or $\pm 15^\circ$ (front and rear) may cause trouble or explosion of the lamp.
- Do not place the projector near air-conditioning unit or heater to avoid the air outlet and inlet grilles from being exposed to hot air.

COMPLIANCE NOTICE OF FCC

This equipment has been tested and found to comply with the limits for a Class B digital device, pursuant to Part 15 of the FCC Rules. These limits are designed to provide reasonable protection against harmful interference in a residential installation. This equipment generates, uses and can radiate radio frequency energy and, if not installed and used in accordance with the instructions, may cause harmful interference to radio communications. However, there is no guarantee that interference will not occur in a particular installation. If this equipment does cause harmful interference to radio or television reception, which can be determined by turning the equipment off and on, the user is encouraged to try to correct the interference by one or more of the following measures:

- Reorient or relocate the receiving antenna.
- Increase the separation between the equipment and receiver.
- Connect the equipment into an outlet on a circuit different from that to which the receiver is connected.
- Consult the dealer or an experienced Radio / TV technician for help.

Changes or modifications not expressly approved by Mitsubishi could void the user's authority to operate this equipment.

COMPLIANCE NOTICE OF INDUSTRY CANADA

This Class B digital apparatus complies with Canadian ICES-003.

Overview

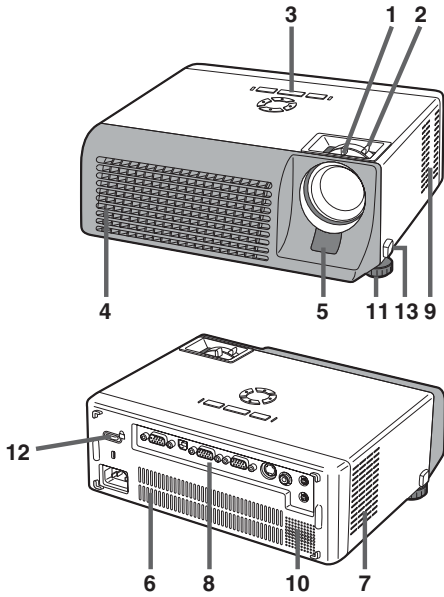

- 1 FOCUS ring
- 2 ZOOM ring
- 3 Control panel
- 4 Air outlet grille
- 5 Remote control sensor
- 6 Air inlet grille
- 7 Air inlet grille
- 8 Terminal board
- 9 Air inlet grille
- 10 Speaker
- 11 Adjustment feet (front)
- 12 Lock bar
- 13 Foot adjustment buttons (Left/Right)

Control panel

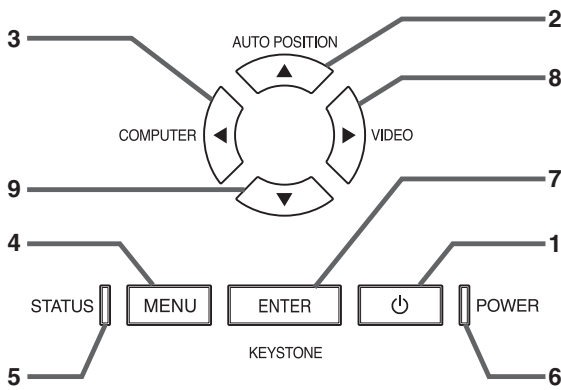

- 1 Power button
- 2 AUTO POSITION / ▲ button
- 3 COMPUTER / ◀ button
- 4 MENU button
- 5 STATUS indicator
- 6 POWER indicator
- 7 KEYSTONE/ENTER button
- 8 VIDEO / ▶ button
- 9 ▼ button

Important:

- While the menu or the screen for the keystone adjustment or password entry is being displayed, the COMPUTER, VIDEO, and AUTO POSITION buttons function as the ◀, ▶, and ▲ buttons respectively.
- While the menu is on the screen, the KEYSTONE button functions as the ENTER button.

Terminal board

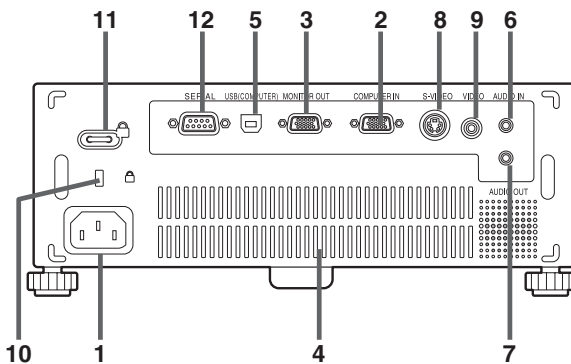

- 1 Power jack
- 2 COMPUTER IN terminal (Mini D-SUB 15-pin)
- 3 MONITOR OUT terminal (Mini D-SUB 15-pin)
- 4 Air inlet grille
- 5 USB (COMPUTER) terminal
- 6 AUDIO IN terminal (Mini jack)
- 7 AUDIO OUT terminal (Mini jack)
- 8 S-VIDEO terminal
- 9 VIDEO terminal
- 10 Kensington Security Lock Standard connector
- 11 Lock bar
- 12 SERIAL (RS-232C) terminal (D-SUB 9-pin)

Bottom side

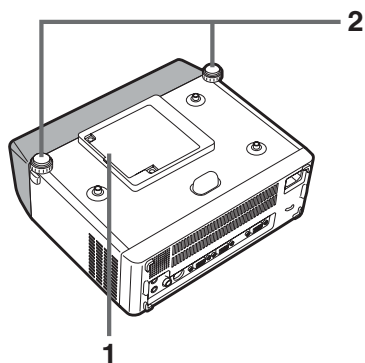

- 1 Lamp cover
- 2 Adjustment feet (front)

Caution:

Do not replace the lamp immediately after using the projector because the lamp would be extremely hot and it may cause burns.

Remote control

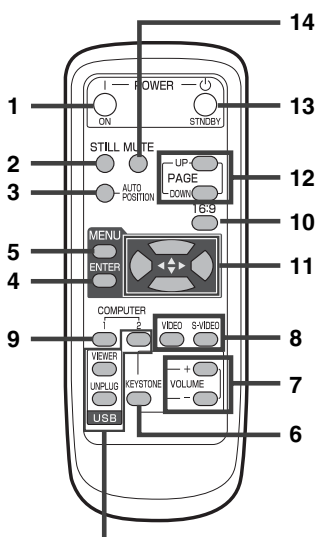

- 1 ON button
- 2 STILL button
- 3 AUTO POSITION button
- 4 ENTER button
- 5 MENU button
- 6 KEYSTONE button
- 7 +, - (VOLUME) buttons
- 8 VIDEO, S-VIDEO button
- 9 COMPUTER button
- 10 16 : 9 button
- 11 Direction buttons
- 12 PAGE UP / DOWN button
- 13 OFF button
- 14 MUTE button (Audio/Video)

•The + and - buttons are used in the KEYSTONE adjustment in addition to the volume control.

This model does not have this function.

Remote control

Battery installation

Use two AA (R6) size batteries.

1. Remove the back cover of the remote control by pushing the battery compartment door in the direction of the arrow.
2. Load the batteries making sure that they are positioned correctly (+ to +, and - to -).
 - Load the batteries from - spring side, and make sure to set them tightly.
3. Replace the back cover.

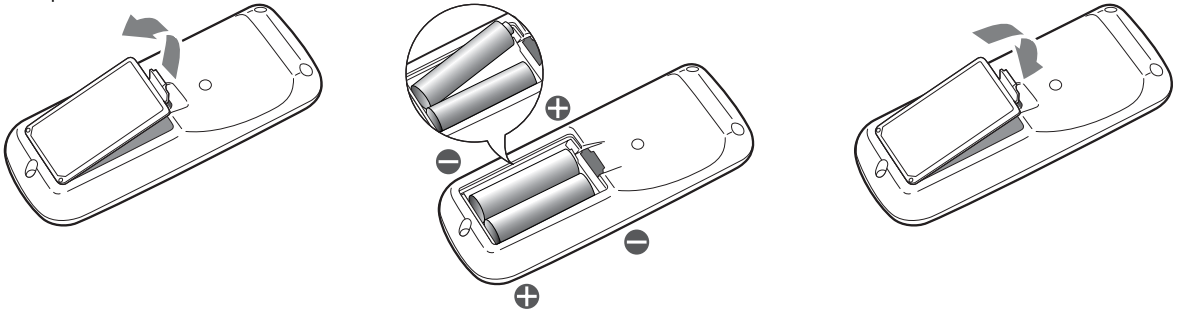

Caution:

- Use of a battery of wrong type may cause explosion.
- Only Carbon-Zinc or Alkaline-Manganese Dioxide type batteries should be used.
- Dispose of used batteries according to your local regulations.
- Batteries may explode if misused. Do not recharge, disassemble, or dispose of in fire.
- Be sure to handle the battery according to the instructions.
- Load the battery with its positive (+) and negative (-) sides correctly oriented as indicated on the remote control.
- Keep batteries out of reach of children and pets.
- Remove the battery, if the remote control is not used for a long time.
- Do not combine a new battery with an old one.
- If the solution of batteries comes in contact with your skin or clothes, rinse with water. If the solution comes in contact with your eyes, rinse them with water and then consult your doctor.

Operation range (of the remote control)

The maximum operation distance of the remote control is about 10 m (or about 32 feet) when the remote control is pointed at the remote control sensor of the projector. When the remote control is pointed to the screen, the distance from the remote control to the projector via the screen should be 5 m or less. However, the operation distance varies depending on the type of the screen used.

Reception angle (vertical)

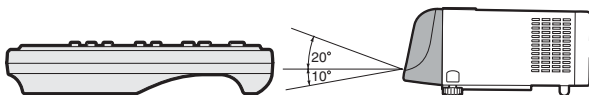

Reception angle (horizontal)

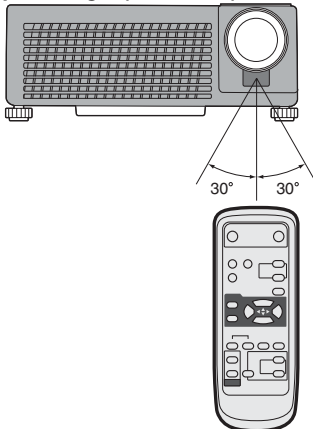

Reception angle (vertical), ceiling mount

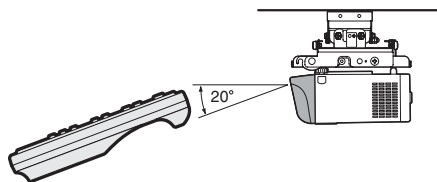

Important:

- Do not expose the remote control sensor to direct sunlight or fluorescent. Keep a distance at least 2 m (6.5 feet) between the remote control sensor and the fluorescent light to ensure correct operation of the remote control. Inverted fluorescent light, if located near the projector, may interfere the remote control.
- When you use the remote control too close to the remote control sensor, the remote control may not work correctly.

Installation

Layout of the projector

Image size varies depending on the distance between the screen and the projector.

Front projection

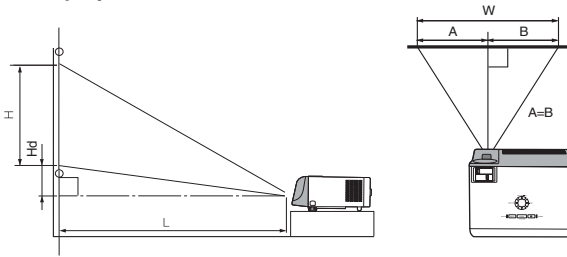

L : Between the screen and the front edge of the projector
Hd : Height of the projected image

Screen						Distance from the screen : L				Hd	
Diagonal size		Width : W		Height : H		Shortest (Wide)		Longest (Tele)			
inch	cm	inch	cm	inch	cm	inch	m	inch	m	inch	cm
40	102	32	81	24	61	54	1.4	63	1.6	3.5	8.8
60	152	48	122	36	91	82	2.1	95	2.4	5.2	13.3
80	203	64	163	48	122	109	2.8	127	3.2	7.0	17.7
100	254	80	203	60	152	137	3.5	160	4.1	8.7	22.1
150	381	120	305	90	229	206	5.2	240	6.1	13.0	33.1
200	508	160	406	120	305	275	7.0	320	8.1	17.4	44.2
250	635	200	508	150	381	344	8.7	400	10.2	21.7	55.2
300	762	240	610	180	457	413	10.5	-	-	26.1	66.3

The above figures are approximate and may be slightly different from the actual measurements.

Front projection, ceiling mounting

For ceiling mounting, you need the ceiling mount kit designed for this projector. Ask a specialist for installation.

For details, consult your dealer.

- The warranty on this projector does not cover any damage caused by use of any non-recommended ceiling mount kit or installation of the ceiling mount kit in an improper location.

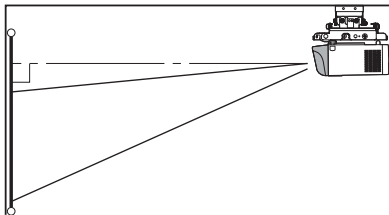

- When using the projector mounted on the ceiling, set IMAGE REVERSE in the INSTALLATION menu to MIRROR INVERT. See page 16.
- When the projector is mounted on the ceiling, images may appear darker than those projected in the case of tabletop mounting. This isn't a product malfunction.

Rear projection

Ask a specialist for installation. For details, consult your dealer.

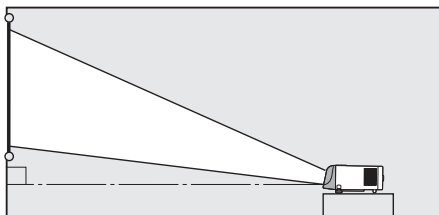

- For rear projection, set IMAGE REVERSE in the INSTALLATION menu to MIRROR. See page 16.

Caution:

- Placing the projector directly on a carpet impairs ventilation by the fans, causing damage or failure. Put a hard board under the projector to facilitate ventilation.
- Place the projector at least 50 cm (or 20 inch) away from the wall to prevent the air inlet grille and the air outlet grilles that emit hot air from being blocked.
- Do not use the projector in the following locations and manners, which may cause fire or electric shock.
 - In a dusty or humid place.
 - In a sideways or upside-down position.
 - Near a heater.
 - In an oily, smoky, or damp place such as a kitchen.
 - In direct sunlight.
 - Where the temperature rises high, such as in a closed car.
 - Where the temperature is lower than +41°F (or +5°C) or higher than +95°F (or +35°C).
- If you move the zoom, the screen will be out of focus. If this is the case, adjust the focus again.

Important:

- Do not apply force to the lens, because the lens may be damaged.

Basic connections

This projector can be connected with various devices such as a VCR, video camera, videodisc player, and personal computer that have analog RGB output connectors.

Important:

- Make sure that the connected device is turned off before starting connection.
- Plug in the power cords of the projector and the connected devices firmly. When unplugging, hold and pull the plug. Do not pull the cord.
- When the projector and the connected devices are located too close to each other, the projected image may be affected by their interference.
- See the owner's guide of each device for details about its connections.

Projector + AV device

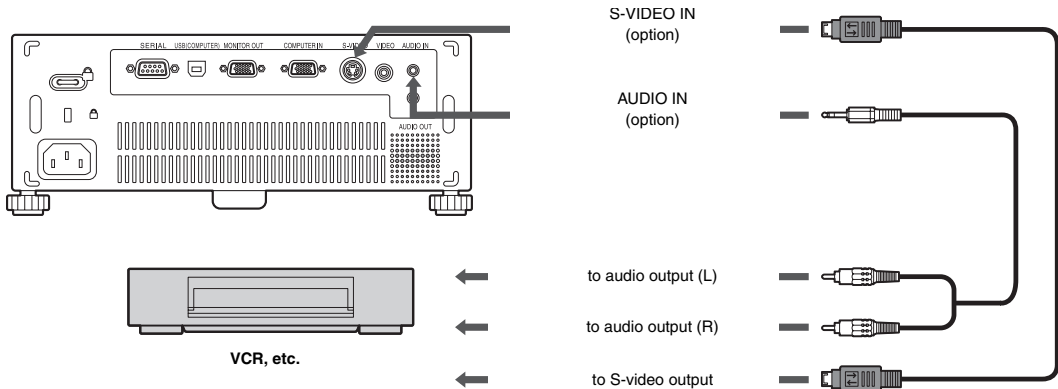

Important:

- Match the colors of the video and audio plugs on the Audio cable with those of the terminals.
- Speaker output is mono.

Projector + DVD player or HDTV decoder

Some DVD players have an output connector for 3-line fitting (Y, CB, CR). When connecting such DVD player with this projector, use the COMPUTER IN terminal.

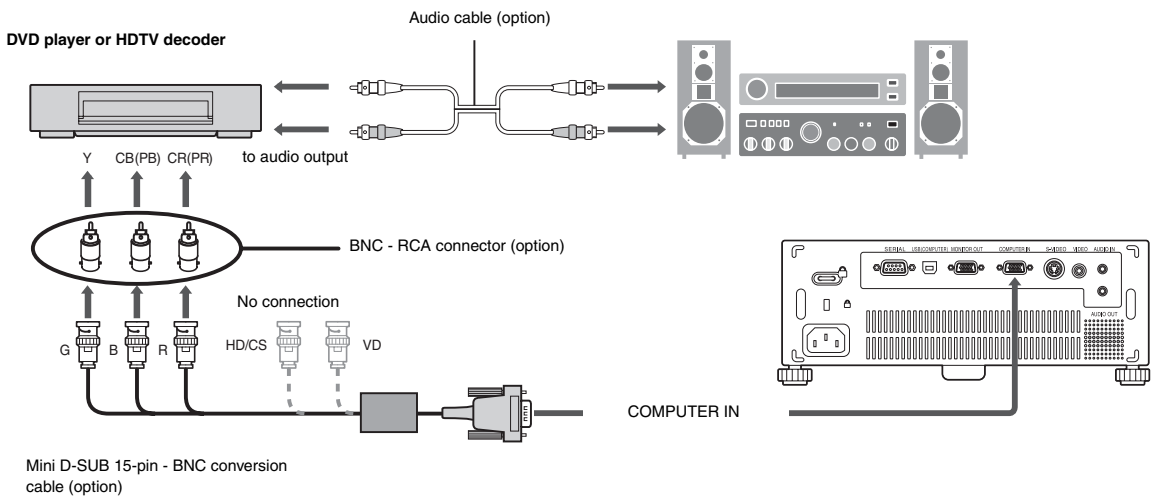

Important:

- The terminal's names Y, PB, and PR are given as examples of when a HDTV decoder is connected.
- The terminal's names vary depending on the connected devices.
- Use a Mini D-SUB 15-pin - BNC conversion cable for connection.
- Image may not be projected correctly with some DVD players.
- When connecting a HDTV decoder having RGB output terminals, set COMPUTER INPUT to RGB in the SIGNAL menu.
- Speaker output is mono.
- When the audio cable is connected to the AUDIO OUT terminal, the speaker output is muted.

Projector + Computer

For computer with Mini D-SUB

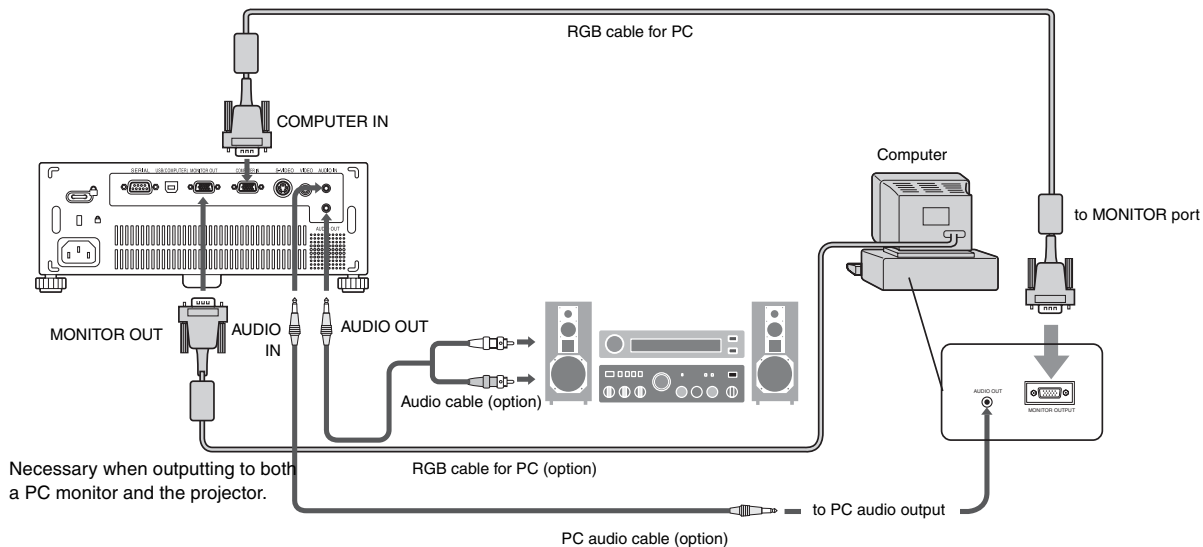

Important:

- When you use a longer RGB cable instead of the provided cable, the image may not be projected correctly.
- Some computers require additional connectors or analog RGB output adapters to be connected with this projector. Contact your dealer for further information.
- This projector uses stereo pin jack for its audio input. Check the type of the audio output terminal of the connected computer and prepare a proper cable for connection. Some computers don't have the audio output terminal.
- Speaker output is mono.
- When the audio cable is connected to the AUDIO OUT terminal, the speaker output is muted.
- MONITOR OUT terminal is not available for SYNC on G (Green) signal.

For Macintosh

- If your Macintosh has no video port, a monitor output adapter is required. Contact your dealer for further information.
- Some Macintoshes require a MAC adapter for the RGB cable for connection with this projector. Contact your dealer for further information.

Preparation

Preparation for projection

1. Attach the provided power cord to the projector.
2. Plug the power cord in the wall outlet.
3. Remove the lens cap.

Warning:

- Do not look into the lens directly when the projector is on.
- The lens cap is for protecting the lens. If you leave the lens cap on the lens with the projector turned on, it may be deformed because of heat build-up. Remove the lens cap when you turn on the projector.
- One of power cords for the U.S., Europe and U.K. is provided appropriately.
- This projector uses the power plug of three-pin grounding type. Do not remove the grounding pin from the power plug. If the power plug doesn't fit your wall outlet, ask an electrician to change the wall outlet.
- In case that the power cord for the U.S. is provided with this projector, never connect this cord to any outlet or power supply using other voltages or frequencies than rated. If you want to use a power supply using other voltage than rated, prepare an appropriate power cord separately.
- Use 100-240 V AC 50/60 Hz to prevent fire or electric shock.
- Do not place any objects on the power cord or do not place the projector near heat sources to prevent damage to the power cord. If the power cord should be damaged, contact your dealer for replacement because it may cause fire or electric shock.
- Do not modify or alter the power cord. If the power cord is modified or altered, it may cause fire or electric shock.

Caution:

- Plug in the power cord firmly. When unplugging, hold and pull the power plug, not the power cord.
- Do not plug in or out the power cord with your hand wet. It may cause electric shock.

Adjustment of the projection angle

For the best projection, project images on a flat screen installed at 90 degrees to the floor. If necessary, tilt the projector using the two adjustment feet on the bottom of the projector.

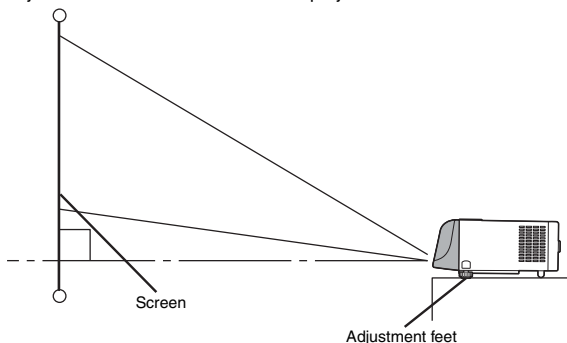

1. Tilt up the project to the appropriate angle.
2. Press the foot adjustment buttons next to the adjustment feet, and the adjustment feet will come out.
3. Release the buttons to lock the adjustment feet to that position.
4. Rotate the adjustment feet for fine adjustment.

After using the projector:

5. Put the adjustment feet back into the projector by pressing the foot adjustment buttons.

Important:

- If necessary, rotate the adjustment feet (front) for fine adjustment.
- Install the screen on a flat wall at 90 degrees to the floor.
- Slanting the projector more than $\pm 10^\circ$ (right and left) or $\pm 15^\circ$ (front and rear) may cause trouble or explosion of the lamp. You can tilt the projector up to 7 degrees using the adjustment feet only.
- Images may not be projected in a shape of a regular rectangle or with its aspect ratio 4:3, depending on the installation conditions of the projector and the screen.
- To correct vertical keystone distortion, press the KEYSTONE button on the projector or the remote control to display KEYSTONE, and adjust the image by pressing the \blacktriangle , \blacktriangledown button (or VOLUME +, - button on the remote control).

In the following cases:



Press the \blacktriangledown
(or -) button.

Press the \blacktriangle
(or +) button.

- When the keystone adjustment is carried out, the adjustment value is indicated. Note that this value doesn't mean a projection angle.
- The allowable range of the adjustment value in the keystone adjustment varies depending on the installation conditions.
- When the keystone adjustment takes effect, the resolution decreases. In addition, stripes may appear or straight lines may bend in images with complicated patterns. They are not due to product malfunctions.
- Noise may appear on the screen during the keystone adjustment because of the type of the video signal being projected and the setting values of the keystone adjustment. In such cases, set the keystone adjustment values in the range where the image is displayed without noise.
- When the keystone adjustment is carried out, the image may not be displayed correctly because of the type of input signal.
- The keystone adjustment doesn't work when no signal.

Basic operation

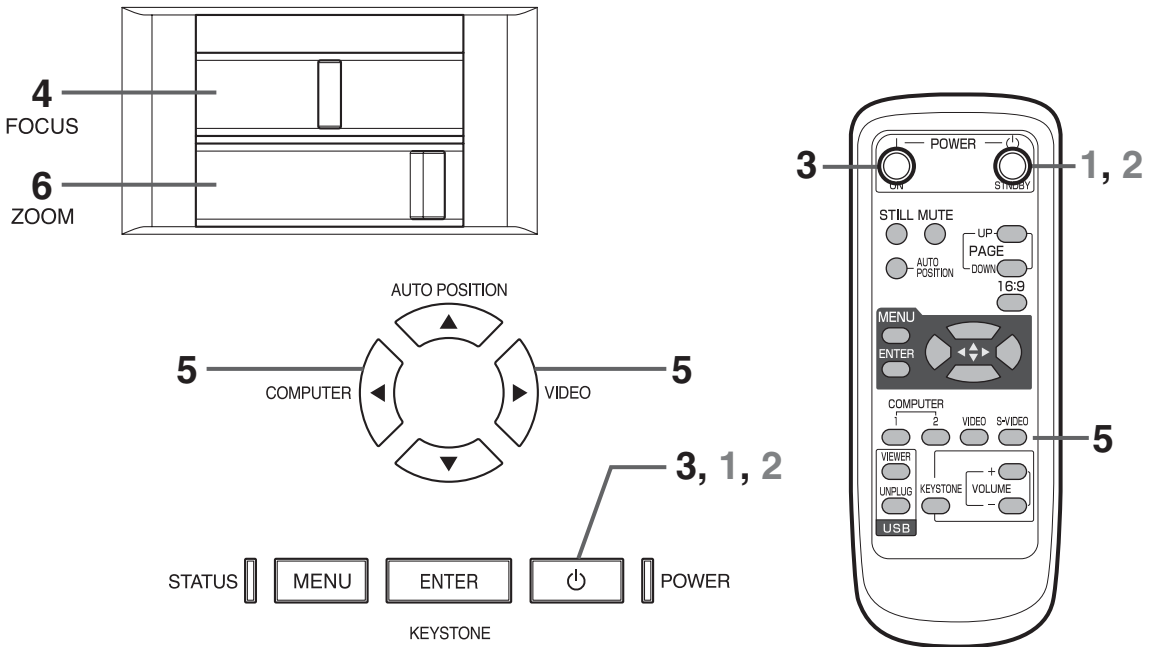

Power-on

1. Turn on the device connected to the projector first.
2. Plug the power cord in the wall outlet.
 - The POWER indicator lights up.
 - If the power cord is unplugged from the wall outlet before the projector is cooled down completely after use, the fans may start rotating when the power cord is plugged in and the POWER button is pressed next time.
3. Press the POWER button on the control panel or the ON button on the remote control.
 - It may take about one minute for the lamp to light up.
 - The lamp occasionally fails to light up and goes to Stand-by mode. In this case, try to light the lamp again. If the temperature of lamp is high, wait a few minutes and try to light the lamp again.
 - After the POWER button is pressed, the image may flicker before the lamp becomes stable. This is not a product malfunction.
 - Regardless of the setting of LAMP MODE in the INSTALLATION menu, the STANDARD lamp mode is activated by default whenever the projector is turned on.
4. Adjust the focus by turning the focus ring.
5. Choose your desired external input source using the COMPUTER or VIDEO button.
 - The input source is switched from VIDEO to COMPUTER at the press of the COMPUTER button on the control panel.
 - The input source is switched between VIDEO and S-VIDEO at every press of the VIDEO button on the control panel.
 - If you use a remote controller, press the VIDEO or S-VIDEO button to directly switch to VIDEO or S-VIDEO.
 - The projector automatically selects the appropriate signal format. The selected signal format is displayed on the screen.
 - To avoid permanently imprinting a fixed image onto your projector, please do not display the same stationary images for long period.
6. Adjust the image size by turning the zoom ring.
 - If necessary, adjust the focus and zoom again.
 - If you move the zoom, the screen will be out of focus. If this is the case, adjust the focus again.

Condition \ Indicator	STATUS	POWER	REMARKS
Stand-by	-	Red	-
Turn on process of the power	-	Blinking red	About 4 seconds
Turn on process of the lamp	Blinking green	Green	Can not turn off about 60 seconds after turning on.
When the lamp is on.	Green	Green	-

Important:

- Do not cover the lens with the lens cap while the lamp is on.
- The projector starts warming up when the POWER button is pressed. During the warm-up process, images may appear dark and no commands are accepted. The projector cannot be turned off within 60 seconds after the lamp is turned on.

Basic operation (continued)

Power-off

Use the following procedure to turn off the projector.

1. Press the POWER button on the control panel or the OFF button on the remote control.
 - The message "POWER OFF? YES : PRESS AGAIN" appears on the screen.
 - To cancel, press any button except the POWER button. (Some buttons on the remote control don't function for cancel.)
2. Press the POWER button on the control panel or the OFF button on the remote control within 10 seconds again.
 - The lamp will go out and the STATUS indicator will start blinking.
 - Though the lamp goes out at this second press of the POWER button (or STANDBY button), the air outlet fans continue operating for approx. 90 seconds to cool down the lamp. The STATUS indicator will stop blinking.
3. Unplug the power cord.
 - The POWER indicator will go out.
 - To light the lamp again, press the POWER button (or ON button). If the lamp doesn't light up immediately, repeat pressing the POWER button (or OFF button) two or three times. If it should still fail to light up, replace the lamp.

Notice:

- When storing the projector in the carrying case, the lens should face up.

Instant Shut Down

You can turn off this projector just by unplugging the power cord without pressing the POWER button.

- Don't shut down the projector while the STATUS indicator is blinking after the lamp lights up because the lamp's life may be shortened.
- Don't turn the projector back on right after shutting it down because the lamp's life may be shortened. (Wait about 10 minutes before turning the projector back on.)
- Before shutting down the projector, be sure to close the menu screen. If you shut down the projector without closing the menu, the setting data of the menu may not be saved.
- If you shut down the projector while controlling the projector using the network function, the application software may fail.

AUTO POSITION button

When the image isn't projected in the right position with COMPUTER selected as the input source, follow the procedure below.

1. Project a bright image such as the "Recycle Bin" window on the full screen.
2. If the screen saver is running, turn it off.
3. Press the AUTO POSITION button.
 - If the image is still not in the right position, adjust the image position using the SIGNAL menu. See page 19.

Volume from the speaker

Press the KEYSTONE button on the remote control to switch the KEYSTONE / VOLUME adjustment. When the VOLUME control bar appears on the screen, press the VOLUME + or -button to change the volume from the speaker.

The volume control bar will appear on the screen.



- The volume control bar will disappear about 10 seconds after the VOLUME button is released.
- When a high-level audio signal, such as a DVD audio signal, is supplied to the AUDIO IN terminal, the output from the speaker may be distorted.

AV mute

The video and audio signals are temporarily muted when the MUTE button is pressed. To cancel muting, press the MUTE button again.

ANAMORPHIC mode

When playing DVD discs containing data of letterboxed image, press the 16:9 button. Exit the ANAMORPHIC mode, by pressing the 16:9 button again.

Important:

- When a letterboxed image is kept displayed for a long time before displaying 4:3 image, the afterimages of the black bars may appear on the 4:3 image screen. Consult your dealer in this case.

Caution:

- After using the projector, wait 90 seconds for the air outlet fans to stop. Then unplug the power cord from the wall outlet.
- While cooling down, the STATUS LED keeps blinking green, the POWER button won't work till it stops blinking.
- The air outlet fans will run for extra 90 seconds before starting the projector if it didn't shut down properly (unplug directly without pressing POWER button) and the temperature is too high.
- The air outlet fans rotate faster as the temperature around the projector rises.
- After shut down due to the high temperature, the Status LED is lit about 10 seconds.

Important:

- Do not display a still picture for a long time because the afterimages may persist on the screen.

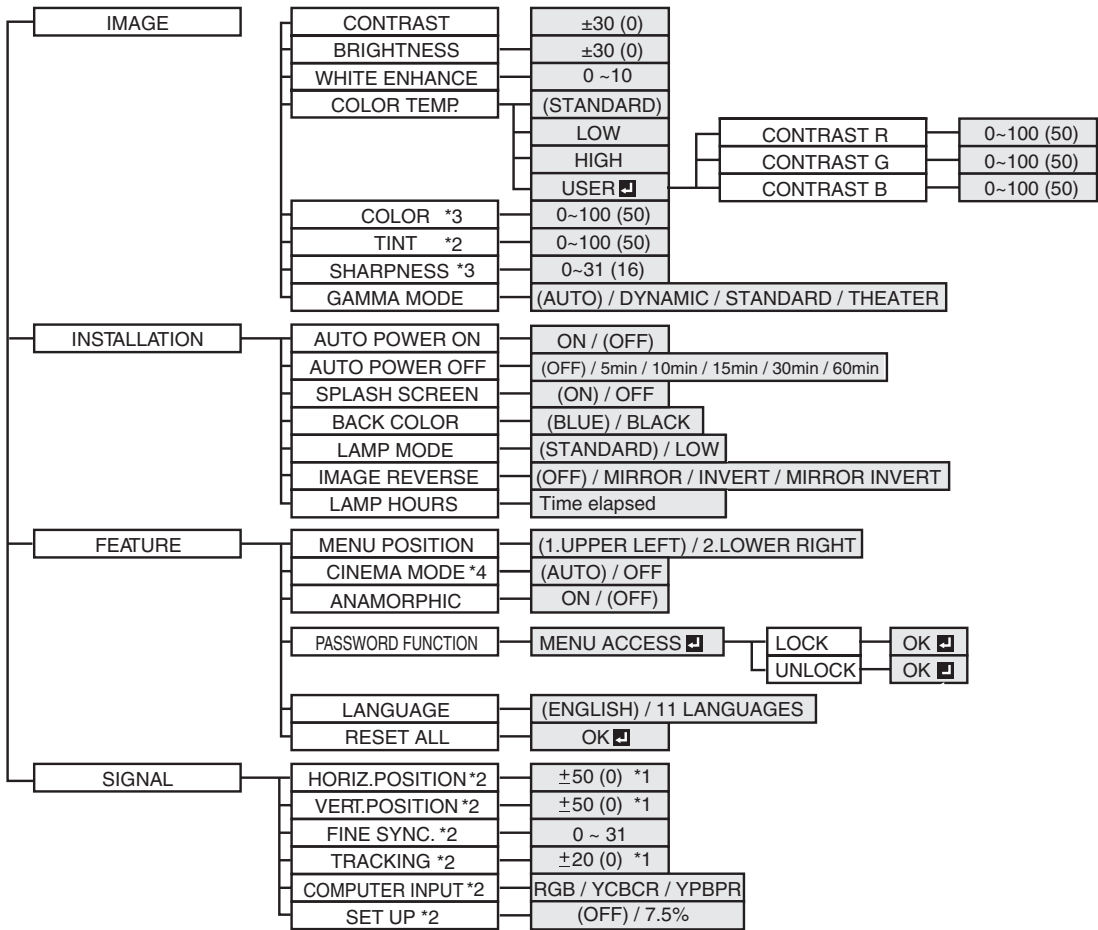

*1: The value range of Horiz. and Vert. Positon may be varied according to different source.

*2: Not available with certain signals.

*3: Not available when the source is PC signal.

*4: Not available when the source is non interlaced signal.

Basic operation

Several settings can be adjusted using the menu.

Example : Auto power off time setting

1. Press the MENU button.



2. Press the ◀ or ▶ button to select INSTALLATION.



3. Press the ENTER button (or ▼ button).

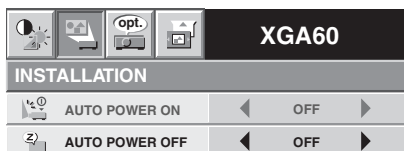

4. Press the ▲ or ▼ button to select AUTO POWER OFF.



5. Press the ◀ or ▶ button to adjust the auto power off time.



6. Exit the menu by pressing the ▲ button several times, and then the MENU button.

Important:

- When the button doesn't function, unplug the power cord from the wall outlet. Wait about 10 minutes, plug the power cord in, and try again.
- After selecting the items marked with , press the ENTER button.
- In case of outline characters on a colored background, it means that function is not available.

Menu operation (continued)

1 IMAGE

CONTRAST	Use to adjust the image contrast. The contrast becomes higher as the value increases.
BRIGHTNESS	Use to adjust the image brightness. The image becomes brighter as the value increases.
WHITE ENHANCE	Use to adjust the white level of the projected image.
COLOR TEMP	Use to adjust the color temperature. See page 18.
COLOR	Use to adjust the color intensity of the image.
TINT	Use to adjust the color balance of the image. The color balance shifts to green as the value increases and shifts to purple as the value decreases. (Available only when VIDEO or S-VIDEO is chosen as the source.) <ul style="list-style-type: none"> When the TV50 (PAL, SECAM) signal is input, TINT can't be adjusted.
SHARPNESS	Use to adjust the image sharpness. The image becomes sharp as the value increases. (Not available with certain signals.)
GAMMA MODE	When AUTO is selected, the appropriate gamma mode is automatically selected depending on the input signal. For normal use, select AUTO. Select DYNAMIC for computer sources. Select STANDARD for sport scenes and video sources. Select THEATER for film sources.



XGA60		
IMAGE		
CONTRAST	◀ 0 ▶	
BRIGHTNESS	◀ 0 ▶	
WHITE ENHANCE	◀ 10 ▶	
COLOR TEMP.	◀ STANDARD ▶	
COLOR	◀ 0 ▶	
TINT	◀ 0 ▶	
SHARPNESS	◀ 0 ▶	
GAMMA MODE	◀ STANDARD ▶	

2 INSTALLATION

AUTO POWER ON	When ON is chosen, the lamp is automatically lit when the power cord is plugged in the wall outlet. Choose ON when using the projector mounted on the ceiling. <ul style="list-style-type: none"> The projector is in the stand-by mode when the lamp is off. Use the remote control to turn on the lamp.
AUTO POWER OFF	Use to set the time elapsed before the projector enters the stand-by mode when there is no signal input from the source.
SPLASH SCREEN	Choose ON to display the splash screen when the power is turned on.
BACK COLOR	Use to select the background from among BLUE and BLACK, which will be displayed when there is no signal input from the source.
LAMP MODE	Use to change the brightness of the lamp. When LOW is chosen, the lamp brightness is kept low and the projector operating noise is reduced, resulting in a longer lamp replacement interval. <ul style="list-style-type: none"> When the lamp mode is switched, the projected image may flicker. This is not a product malfunction. Do not change the setting of LAMP MODE frequently. When LAMP MODE has been set to LOW, the lamp mode changes from STANDARD to LOW about one minute after turn on.
IMAGE REVERSE	Use to reverse the projected image. Select MIRROR for rear projection with the tabletop-mounted projector. Select MIRROR INVERT for front projection with the ceiling-mounted projector.
LAMP HOURS	The duration of illumination of a lamp converted in the Low mode is displayed.

XGA60		
INSTALLATION		
AUTO POWER ON	◀ OFF ▶	
AUTO POWER OFF	◀ OFF ▶	
SPLASH SCREEN	◀ ON ▶	
BACK COLOR	◀ BLUE ▶	
LAMP MODE	◀ STANDARD ▶	
IMAGE REVERSE	◀ OFF ▶	
LAMP HOURS	0	

3 FEATURE

- MENU POSITION Use to select the position of the menu on the screen,  (upper left) or  (lower right).
- CINEMA MODE When AUTO is selected, the film mode will be automatically activated when a film source signal is inputted. When OFF is selected, the film mode will not be activated.
- ANAMORPHIC Select ON when playing DVD discs containing data of widescreen images.
- PASSWORD FUNCTION Use to change the mode of the password lock or to enable or cancel the password lock. See page 21 for details.
- LANGUAGE Use to select the language used in the menu. (ENGLISH / DEUTSCH / 日本語 / 中文 / FRANÇAIS / ESPAÑOL / PORTUGUÊS / ITALIANO / РУССКИЙ / 繁體中文 / 한국어).
- RESET ALL Use to reset the menu settings (except PASSWORD FUNCTION, and LANGUAGE).
 - CINEMA MODE can be adjusted only when a TV50, TV60, 480i, 576i signal is being displayed.

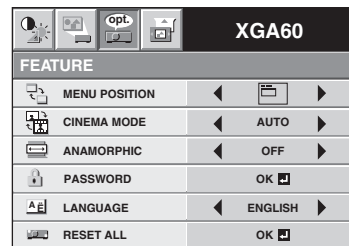

4 SIGNAL

- HORIZ. POSITION Use to adjust the horizontal position of the image.
- VERT. POSITION Use to adjust the vertical position of the image.
- FINE SYNC Use to synchronize the projector with the PC input signal so that the image is not blurred.
- TRACKING Use to eliminate image noise such as wide stripes.
- COMPUTER INPUT The projector adjusts its settings automatically when connected to a DVD player equipped with a component video output (Y, CB, CR). When the projector is connected with a device having an RGB terminal, choose RGB manually.
- SET UP When OFF is selected, the black area becomes make lighter. When 7.5% is selected, the black area becomes thicker.

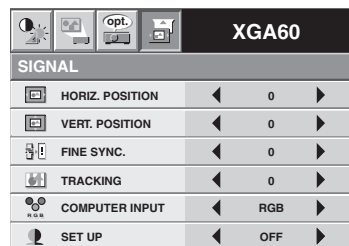

Important:

- You can set the IMAGE, and SIGNAL menus only when the signal is supplied.

Image adjustment

Image adjustment

You can adjust the image using the IMAGE menu.

XGA60		
IMAGE		
▶	CONTRAST	◀ 0 ▶
☀	BRIGHTNESS	◀ 0 ▶
☀	WHITE ENHANCE	◀ 10 ▶
🌡	COLOR TEMP.	◀ STANDARD ▶
🎨	COLOR	◀ 0 ▶
🎨	TINT	◀ 0 ▶
S	SHARPNESS	◀ 0 ▶
↺	GAMMA MODE	◀ STANDARD ▶

To control the white-to-black level of the image :

Adjust CONTRAST in the IMAGE menu. Press the ▶ button to increase the contrast and the ◀ button to reduce it.

To control the light level of the image :

Adjust BRIGHTNESS in the IMAGE menu. Press the ▶ button to lighten the image and the ◀ button to darken it.

To determine the intensity of the color :

Adjust COLOR in the IMAGE menu. Press the ▶ button to increase the amount of color in the image and the ◀ button to decrease it.

To adjust the red-green color balance of the image :

Adjust TINT in the IMAGE menu. Press the ▶ button to increase the amount of green in the image and the ◀ button to increase the amount of red in the image.

To adjust the detail and clarity of the image :

Adjust SHARPNESS in the IMAGE menu. Press the ▶ button to sharpen the image and the ◀ button to soften the image.

Color temperature

1. Select COLOR TEMP. in the IMAGE menu.
2. Press the ◀ or ▶ button to select USER 📄.
3. Press the ENTER button.

IMAGE		
🌡	CONTRAST R	◀ 50 ▶
🌡	CONTRAST G	◀ 50 ▶
🌡	CONTRAST B	◀ 50 ▶

4. Press the ▲ or ▼ button to select the desired item.
5. Press the ◀ or ▶ button to adjust the selected item.
6. Repeat steps 4 and 5 for optimum adjustment results.
7. Exit the menu by pressing the MENU button several times.

Adjustment of the image from the computer

This projector adjusts the format of the video signal supplied from the computer. However, sometimes images are not projected correctly owing to the type of the computer used. When the image from the computer isn't projected correctly, press the AUTO POSITION button. (See page 14.) If the image isn't projected correctly yet, adjust the image from the computer using the menu.

In this menu the setting value is not saved after turning off the projector. This menu is prepared just for temporary use when AUTO POSITION does not work correctly for the current provided signal.

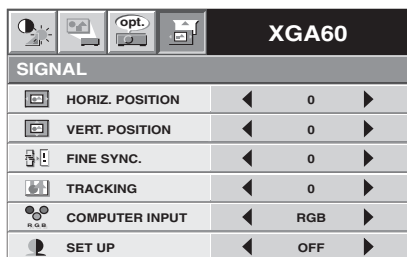

To move the image horizontally :

Adjust HORIZ. POSITION in the SIGNAL menu. Press the ▶ button to move the image to the left. Press the ◀ button to move the image to the right.

To move the image vertically :

Adjust VERT. POSITION in the SIGNAL menu. Press the ▶ button to move the image upward. Press the ◀ button to move the image downward.

When the image flickers or the image is out of focus :

Adjust FINE SYNC. in the SIGNAL menu.

Simple adjustment method

1. Select HORIZ. POSITION in the SIGNAL menu.
2. Press the ◀ or ▶ button to adjust the horizontal start position (or the left side of the image).
3. Select TRACKING in the SIGNAL menu.
4. Press the ◀ or ▶ button to adjust the horizontal end position (or the right edge of the image).
5. Repeat steps 1 to 4 for optimum adjustment results.
6. Select VERT. POSITION in the SIGNAL menu.
7. Press the ◀ or ▶ button to adjust the vertical start position (or the upper edge of the image).

Advanced feature

Still

To stop the motion in the image temporarily (or to display a still image):

Press the STILL button on the remote control.

- The image will freeze temporarily.

To resume the motion in the image:

Press any button on the remote control.

Important:

- Do not display a still picture for a long time because the afterimages may persist on the screen.

Page-up and page-down

You can control the computer to page-up and page-down the presentation data using the remote control. Switch the pages using the PAGE UP or DOWN button on the remote control.

Connection

To control the computer using the remote control, connect the projector with the computer as shown below.

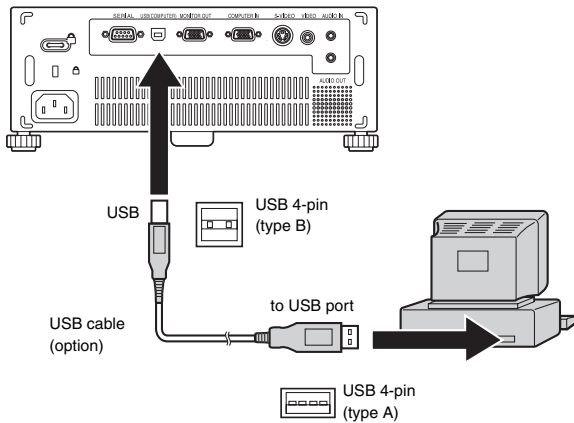

- When it is connected via USB, the "Page up/down" function works on the computer which supports USB connection as a standard function. (But this function may not work via USB connection on any computer.)
- Wait for the lamp to light up before connecting the USB cable.

Password function

This projector is equipped with the password function that is designed for prevention of wrong operation by children and restriction on operation by other than specified users.

MENU ACCESSAll the buttons except for the POWER button on the projector are disabled. (The buttons on the remote control are enabled.) You can use this mode as a measure of prevention of wrong operation by children and restriction on operation by other than specified users.

To enable the password function:

1. Display the FEATURE menu.
2. Press the ▲ or ▼ button to select PASSWORD FUNCTION.
3. Press the ENTER button.
 - The screen for setting the password function will appear.



4. Press the ENTER button.
 - The screen for entering a password will appear.



5. Press the ◀ or ▶ button to select a number from 0 to 9.
6. Press the **ENTER** button.
 - You can set the next digit.
7. Repeat steps 5 and 6 to set a four-digit password.
8. Enter the password again for confirmation using the same steps.
9. When the last digit has been entered, the password set up is complete and the password menu will be off.
 - If the entered passwords don't match, it will jump to the INPUT PASSWORD field to start over again.
 - To cancel the procedure, select Exit and press the ENTER button.
 - You can cancel the procedure by pressing the MENU button alternatively.

To cancel the password function:

1. Display the FEATURE menu.
2. Press the ▲ or ▼ button to select PASSWORD FUNCTION.
3. Press the ENTER button.
 - The screen for canceling the password function will appear.



4. Press the ENTER button.
 - The screen for entering the password will appear.



5. Press the ◀ or ▶ button to select a number from 0 to 9.
6. Press the **ENTER** button.
 - You can set the next digit.
7. Repeat steps 5 and 6 to enter the four-digit password.
8. When the last digit has been entered, the password set up is complete and the password menu will be off.
 - If the entered passwords don't match, it will jump to the INPUT PASSWORD field to start over again.
 - To cancel the procedure, select Exit and press the ENTER button.
 - You can cancel the procedure by pressing the MENU button alternatively.

Important:

- If you forget your password, keep pressing the MENU and ENTER buttons on the control panel at the same time about three seconds to cancel the password function.

Lamp replacement

When the lamp no longer functions, replace it with a new one.

Caution:

- Do not remove the lamp immediately after using the projector. You may get burned because the lamp very hot after use.
- Before replacing the lamp, press the POWER button to turn off the lamp and wait for two minutes for lamp to cool down. Unplug the power cord from wall outlet and wait one hour for the lamp to cool down completely.
- Do not remove the lamp except for replacement. Careless handling can cause injury or fire.
- Do not touch the lamp directly. It may break and cause injury or burn.
- Be sure not to drop the lamp lid screw into the projector. Also be sure not to put metal or any flammable objects inside because it may cause fire or electric shock. If any objects should fall inside, unplug and contact your dealer.
- Install the lamp securely to prevent failure and fire.
- If the lamp should break, small glass fragments may fall out through the grilles and some may remain inside of the projector or the lamp box. When taking the lamp box out, be sure to turn over the projector and hold the handle of the lamp box to avoid injury due to the glass fragments.
- If the lamp should break, never shake the lamp box or hold it in front of your face after removing it. The glass fragments may fall out and cause injury to your eyes.
- When placing the projector upside down to replace the lamp or conduct maintenance, ensure that the projector is securely placed before working with it.
- Be sure to use the lamp exclusive to this projector, VLT-XD206LP. Use of other lamps may cause a failure of the projector.

1. Reverse the projector gently.
2. Loosen the screws (a) using a Phillips screwdriver (+), and remove the lamp cover (b).
3. Loosen the screws (c) using a Phillips screwdriver (+).
4. Pull up the handle.
5. Pull out the lamp box by the handle while holding the projector.
 - Pull the lamp box out of the projector slowly. If it is pulled out quickly, the lamp may break scattering glass fragments.
 - Do not spill liquid on the removed lamp box or do not place it near any flammable object or where children can reach to prevent injury or fire.
6. Load a new lamp box securely into the projector in the right orientation.
7. Put the handle back to the original position.
 - Make sure that the handle is locked.
8. Tighten up the screws (c) using a Phillips screwdriver (+).

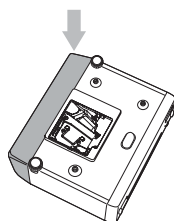
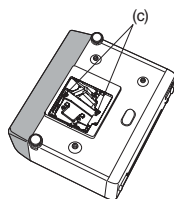
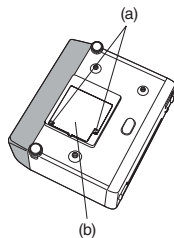
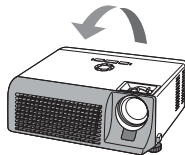

9. Tighten up the screw (a) using a Phillips screwdriver (+) to secure the lamp cover.

Reset of the lamp operation time

Plug in the power cord, and reset the lamp operation time by keep pressing the ◀, ▶, and POWER buttons on the control panel at the same time about 5 seconds.

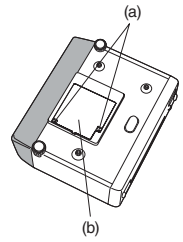

Important:

- Unless these three buttons are pressed at the same time, the lamp operation time isn't reset.
- Make sure that the STATUS indicator is lit once (red) and the lamp operation time is reset successfully.
- The projector doesn't turn on if the lamp cover isn't attached securely.
- Be sure to reset the lamp operation time whenever you replace the lamp.
- Do not reset the lamp operation time unless you replace the lamp.

Caution:

- The lamp is fragile. If it is broken, be careful not to cut yourself with glass fragments.
- Contact your dealer for a new lamp.
- The lamp in this product contains mercury. Please dispose of properly.

Interval of lamp replacement

When the lamp operation time exceeds the time elapsed*1, the POWER LED will light green and STATUS LED will blink red. In this case, replace the lamp immediately.

XD206U
*1 2850 Hours
*2 3000 Hours*3

The times above are when LAMP MODE of the INSTALLATION menu is set to LOW. When it is set to STANDARD, this duration will be shortened.

*3 When LAMP MODE is set to STANDARD, the time elapsed until the lamp shutdown will be shortened to 2000 hours.































Caution:

- This projector uses a lamp that contains mercury. Disposal of the lamp or the projector with the lamp may be regulated due to environmental considerations. For disposal or recycling information, please contact your local authorities or the Electronic Industries Alliance: www.eiae.org. (For US only).

Troubleshooting

The following offers solutions to some of the common problems you may encounter. We suggest that you consult this chart before contacting your dealer.

Images aren't projected on the screen.



Problem	Cause and solution																												
Power isn't turned on.	<ul style="list-style-type: none"> Check the states of the indicators. <table border="1" data-bbox="498 311 1291 836"> <thead> <tr> <th data-bbox="498 311 598 340">POWER</th> <th data-bbox="598 311 701 340">STATUS</th> <th data-bbox="701 311 900 340">CONDITION</th> <th data-bbox="900 311 1291 340">NOTE</th> </tr> </thead> <tbody> <tr> <td data-bbox="498 340 598 401">  Off </td> <td data-bbox="598 340 701 401">  Blinking green </td> <td data-bbox="701 340 900 401">Lamp failure</td> <td data-bbox="900 340 1291 401"> <ul style="list-style-type: none"> Replace the lamp and reset the lamp hour. </td> </tr> <tr> <td data-bbox="498 401 598 463">  Steady green </td> <td data-bbox="598 401 701 463">  Steady amber </td> <td data-bbox="701 401 900 463">Color wheel failure</td> <td data-bbox="900 401 1291 463"> <ul style="list-style-type: none"> Contact your dealer. </td> </tr> <tr> <td data-bbox="498 463 598 546">  Blinking green </td> <td data-bbox="598 463 701 546">  Steady green </td> <td data-bbox="701 463 900 546">Fan failure</td> <td data-bbox="900 463 1291 546"> <ul style="list-style-type: none"> Check if the fan is clogged with dust or dirt and clean it. If the above solution is not effective, contact your dealer. </td> </tr> <tr> <td data-bbox="498 546 598 736">  Steady green </td> <td data-bbox="598 546 701 736">  Steady red </td> <td data-bbox="701 546 900 736"></td> <td data-bbox="900 546 1291 736"> <ul style="list-style-type: none"> Clean the ventilation grilles. Relocate the projector to a cooler place. For the directly shut down, it will check the temperature first, if it's too high, it will start cooling for 90 seconds. If it's normal shut down in the previous time while the temperature is too high, it will start the shut down process after 10 seconds when the temperature is still too high. </td> </tr> <tr> <td data-bbox="498 736 598 797">  Off </td> <td data-bbox="598 736 701 797">  Steady red </td> <td data-bbox="701 736 900 797">Lamp life end</td> <td data-bbox="900 736 1291 797"> <ul style="list-style-type: none"> Replace the lamp and reset the lamp hour. </td> </tr> <tr> <td data-bbox="498 797 598 836">N/A</td> <td data-bbox="598 797 701 836">N/A</td> <td data-bbox="701 797 900 836">Lamp cover open</td> <td data-bbox="900 797 1291 836"> <ul style="list-style-type: none"> Put back the lamp cover. </td> </tr> </tbody> </table>	POWER	STATUS	CONDITION	NOTE	 Off	 Blinking green	Lamp failure	<ul style="list-style-type: none"> Replace the lamp and reset the lamp hour. 	 Steady green	 Steady amber	Color wheel failure	<ul style="list-style-type: none"> Contact your dealer. 	 Blinking green	 Steady green	Fan failure	<ul style="list-style-type: none"> Check if the fan is clogged with dust or dirt and clean it. If the above solution is not effective, contact your dealer. 	 Steady green	 Steady red		<ul style="list-style-type: none"> Clean the ventilation grilles. Relocate the projector to a cooler place. For the directly shut down, it will check the temperature first, if it's too high, it will start cooling for 90 seconds. If it's normal shut down in the previous time while the temperature is too high, it will start the shut down process after 10 seconds when the temperature is still too high. 	 Off	 Steady red	Lamp life end	<ul style="list-style-type: none"> Replace the lamp and reset the lamp hour. 	N/A	N/A	Lamp cover open	<ul style="list-style-type: none"> Put back the lamp cover.
POWER	STATUS	CONDITION	NOTE																										
 Off	 Blinking green	Lamp failure	<ul style="list-style-type: none"> Replace the lamp and reset the lamp hour. 																										
 Steady green	 Steady amber	Color wheel failure	<ul style="list-style-type: none"> Contact your dealer. 																										
 Blinking green	 Steady green	Fan failure	<ul style="list-style-type: none"> Check if the fan is clogged with dust or dirt and clean it. If the above solution is not effective, contact your dealer. 																										
 Steady green	 Steady red		<ul style="list-style-type: none"> Clean the ventilation grilles. Relocate the projector to a cooler place. For the directly shut down, it will check the temperature first, if it's too high, it will start cooling for 90 seconds. If it's normal shut down in the previous time while the temperature is too high, it will start the shut down process after 10 seconds when the temperature is still too high. 																										
 Off	 Steady red	Lamp life end	<ul style="list-style-type: none"> Replace the lamp and reset the lamp hour. 																										
N/A	N/A	Lamp cover open	<ul style="list-style-type: none"> Put back the lamp cover. 																										
Images aren't projected on the screen.	<ul style="list-style-type: none"> Cancel the AV mute by pressing the MUTE button. Remove the lens cap. The lamp sometimes takes about one minute to light up. On rare occasion, the lamp fails to light up. In such cases, wait a few minutes and try to light the lamp again. If the projector was turned off before the lamp cooled down completely, the fans may start rotating and the POWER button may not function when you plug the power cord into the wall outlet next time. Wait for the fans to stop and press the POWER button to turn on the lamp again. Check that the cable connected to the external device isn't broken. When an extension cord is being used, replace it with the supplied cable and check whether images are projected correctly. If images are projected correctly, use an RGB signal amplifier along with the extension cord. 																												
The power is turned off.	<ul style="list-style-type: none"> This condition may occur when an inlet or an outlet is blocked. (If this is the case, the STATUS indicator lights red.) → Remove the object which blocks the inlet or outlet, and then perform the following operations. <ol style="list-style-type: none"> Wait until the air inlet/outlet fan stops (until the STATUS indicator turns off.) Disconnect the power plug from the power outlet. Wait 10 minutes or longer. Connect the power plug to the power outlet. Press the power button. If the STATUS indicator illuminates in red, it indicates the lamp should be exchanged. Exchange the light source lamp. Check whether or not the "Auto power off" function is set. Check whether or not the lifetime indicator of the lamp illuminates. A degraded lamp may illuminate, and go out after a while. 																												
Images suddenly disappear.	<ul style="list-style-type: none"> The air inlet or outlet grille may be blocked. (In such cases, the STATUS indicator lights red.) → Remove the objects blocking the air inlet or outlet grille and carry out the following. <ol style="list-style-type: none"> Wait for the air inlet or outlet fan to stop (or wait for the STATUS indicator to go out.) Unplug the power cord from the wall outlet. Wait about 10 minutes. Plug the power cord into the wall outlet. Press the POWER button. When the STATUS indicator is blinking red, it is indicating that the lamp should be replaced. Replace the lamp in this case. 																												
"NO SIGNAL" is displayed.	<ul style="list-style-type: none"> Turn on the power of the connected device, or check whether there is something wrong with the connected device. Check whether the external device outputs signals. (Check this especially when the external device is a notebook computer.) Check that the cable connected to the external device isn't defective. Check that the projector is connected to the external device using the correct terminals. Check that the connected device is correctly selected as the input source. When an extension cord is being used, replace it with the supplied cable and check whether images are projected correctly. If images are projected correctly, use an RGB signal amplifier along with the extension cord. 																												

Troubleshooting (continued)

Images aren't projected correctly.

Problem	Cause and solution
Projected images are shaking. Projected images are displaced.	<ul style="list-style-type: none"> • Check that the cable connected to the external device isn't intermittent. • Connect the cable's plug with the external device's connector firmly. • Press the AUTO POSITION button. • Some computers output out-of-spec signals on rare occasion. Adjust the SIGNAL menu. (See page 19.)
Projected images are distorted.	<ul style="list-style-type: none"> • Adjust the projector and the screen so that they are perpendicular to each other. (See page 12.)
Projected images are dark.	<ul style="list-style-type: none"> • Adjust BRIGHTNESS in the IMAGE menu. (See page 18.) • Replace the lamp. (See page 22.) • Remove the lens cap.
Projected images are blurred.	<ul style="list-style-type: none"> • Adjust the focus. (See page 13.) • Clean the lens. • Remove the lens cap. • Adjust BRIGHTNESS and CONTRAST in the IMAGE menu. (See page 18.) • Adjust the projector and the screen so that they are perpendicular to each other. (See page 12.)
White dots are seen on projected images. Black dots are seen on projected images.	<ul style="list-style-type: none"> • This symptom is normal for a DLP projector and is not a malfunction. (A very small number of pixels may stay lit or out, but such symptom is not a malfunction. Pixels of 99.99% or more are effective.)
Rainbow blur appears in projected images.	<ul style="list-style-type: none"> • This is due to color breaking noise that occurs in a DLP system and is not a malfunction.
Fine streak pattern appears in projected images.	<ul style="list-style-type: none"> • It occurs because of interference with the screen and isn't a product malfunction. Change the screen or readjust the focus of the projector.
Projected images (and/or audio) appear wavy and distorted.	<ul style="list-style-type: none"> • Connect the cable's plug with the external device's connector firmly. • Keep the projector away from equipment generating interfering radio waves. • When the keystone adjustment is carried out, the image may not be displayed correctly because of the type of input signal. This isn't a product malfunction. In this case, readjust the keystone so that the amount of keystone correction is as small as possible.
Tint in projected images is incorrect.	<ul style="list-style-type: none"> • Check that COMPUTER INPUT in the SIGNAL menu is correctly set. (See page 17.) • Check that the cable connected to the external device isn't broken.
Color shade looks different.	<ul style="list-style-type: none"> • The color shade between several equipment may differ depending on the types of optical parts, however, it does not indicate a malfunction. • Colors may look different from those on the TV or on a display of a personal computer, however, it is due to differences in the range of color reproduction, and is not a malfunction.
Only the motion areas in the images supplied from the computer aren't displayed.	<ul style="list-style-type: none"> • This is caused by the computer being used. Contact the manufacturer of your computer.
Projected images are obscured.	<ul style="list-style-type: none"> • Match the output resolution of your computer with the resolution of the projector. For the method to change the output resolution of the computer, contact the manufacturer of your computer. (See page 29.) • Some images and texts appear obscured during the keystone adjustment. In such cases, use the projector without applying the keystone adjustment. (See page 12.)

Others

Problem	Cause and solution
Hot air is emitted from the air outlet grilles.	<ul style="list-style-type: none"> This air comes out as a result of cooling the inside of the projector. This isn't a product malfunction.
No audio is output.	<ul style="list-style-type: none"> Check that the volume isn't set to low.
Sound cannot be heard from the external audio output (* Only applicable to the models which have the external audio output.)	<ul style="list-style-type: none"> Check whether or not the volume is turned down.
The menu can't be used.	<ul style="list-style-type: none"> The microcomputers inside the projector may be wrongly operating because of noise. → Press the POWER button to turn off the lamp and unplug the power cord from the wall outlet. Wait about 10 minutes, plug the power cord in, and try again.
The remote control doesn't function easily or at all.	<ul style="list-style-type: none"> Check that the battery is loaded in the remote control or the battery isn't weak. (See page 8.) Check that the remote control sensor isn't exposed to direct sunlight or fluorescent light. (See page 8.) Use the remote control within its operation range. (See page 8.) Use the remote control at least 10 cm away from the projector.
The buttons on the control panel (except for the POWER button) don't function.	<ul style="list-style-type: none"> The password function is working. → Cancel the password lock. (See page 21.)
Abnormal sound is heard.	<ul style="list-style-type: none"> Because the color wheel spins at a high speed, metallic sounds may be heard in rare occasions. Such symptom is not a malfunction.
<p>POWER STATUS</p> <p> </p> <p>Steady green Blinking red</p>	<ul style="list-style-type: none"> 95% Lamp life exceed → Replace the lamp and reset the lamp hour.

When the problems below occur after the lamp is replaced, check the following.

Problem	Cause and solution
The power isn't turned on.	<ul style="list-style-type: none"> Attach the lamp cover on the bottom correctly. Reset the lamp operation time. (See page 22.)
The STATUS indicator blinks.	<ul style="list-style-type: none"> Reset the lamp operation time. (See page 22.)

Maintenance

Warning:

Do not use flammable solvents (benzene, thinner, etc.) and flammable aerosols when cleaning the projector body and lens. Flammable substances may ignite causing fire or breakdown while the lamp is illuminating.

Caution:

Be sure to turn off the lamp and unplug the power cord from the wall outlet before you perform any maintenance on the projector.

Cleaning of the projector and the ventilation slots

Use a soft cloth to clean the projector and the ventilation grilles. When the grilles become dirty, wipe them with a soft cloth dampened with diluted mild detergent, and then wipe them with a dry cloth.

To protect the surface of the projector from fading or deteriorating:

- Do not spray insecticide on or inside the projector.
- Do not use benzine or thinner to clean it.
- Do not let rubber or plastic materials contact with projector.

Cleaning of the lens

Use a standard lens-cleaning brush or a piece of lens tissue dampened with lens cleaning fluid. The lens surface is fragile. Use only recommended, nonabrasive lens-cleaning materials. Do not touch the lens with your fingers.

Indicators

This projector has two indicators, each of which shows the operation condition of the projector.

The following offer solutions to possible problems. If these problem persist, turn the projector off and consult your dealer.

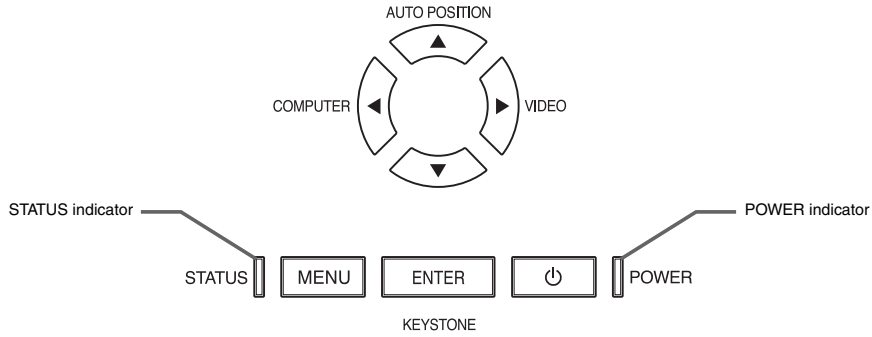

Normal condition

POWER	STATUS	CONDITION	NOTE
Steady red	Off	Stand-by	
Blinking red	Off	Power up process (About 4 seconds)	
Steady green	Steady green	The power is on. (Normal condition)	
Steady green	Blinking green	<ul style="list-style-type: none"> Lamp cooling down. (About 90 seconds) Lamp lit up (About 60 seconds) 	

Abnormal condition

POWER	STATUS	CONDITION	POSSIBLE SOLUTION
Off	Blinking green about 30 seconds after power on.	Lamp failure	<ul style="list-style-type: none"> Replace the lamp and reset the lamp hour.
Steady green	Steady amber about 5 seconds after power on.	Color wheel failure	<ul style="list-style-type: none"> Contact your dealer.
Blinking green	Steady green about 20 seconds after power on.	Fan failure	<ul style="list-style-type: none"> Check if the fan is clogged with dust or dirt and clean it. If the above solution is not effective, contact your dealer.
Steady green	Steady red about 10 seconds after power on.	Abnormal temperature	<ul style="list-style-type: none"> Clean the ventilation grilles. Relocate the projector to a cooler place. For the directly shut down, it will check the temperature first, if it's too high, it will start cooling for 90 seconds. If it's abnormal shut down in the previous time, while the temperature is too high, it will start the cooling process after 90 seconds when the temperature is still too high.
Steady green	Blinking red	95% Lamp life exceed	<ul style="list-style-type: none"> Replace the lamp and reset the lamp hour.
Off	Steady red about 5 seconds after power on.	Lamp life end	<ul style="list-style-type: none"> Replace the lamp and reset the lamp hour.
N/A	N/A	Lamp cover open	<ul style="list-style-type: none"> Put back the lamp cover.

Specifications

Type	DLP™ DATA projector
Model	XD206U
Rated power supply	100 - 240 V AC, 50 / 60 Hz
Rated input	2.9 A
Display Technology	0.55-inch Single chip Digital Micromirror Device (DMD) with R,G,B,W color wheel Pixels 1024 x 768 = 786432 pixels
Colors	16770000 colors
Projection lens	F 2.4 (Wide), f = 19 - 21.9 mm
Light source lamp	205 W
Picture size	40 - 300 inch (Wide), aspect ratio 4:3
PC compatibility	Resolution:640x400 (Expand) - 1024x768 (Real) - 1280x1024 (Compress) Sync on Green available
Video compatibility	NTSC / NTSC 4.43 / PAL (including PAL-M, N) / SECAM, PAL-60 Component Video (DVD/HDTV) (480I, 576I, 480P, 576P, 1080I, 720P)
Speaker	2 W Mono, Round type ø2.5 cm x 1
S-video input	Luminance signal: 1.0 Vp-p 75 Ω (negative sync.) Chroma signal: 0.286 Vp-p 75 Ω (burst signal)
Video input	1.0 Vp-p 75 Ω (negative sync.)
Audio input	350 mVrms, 10 kΩ or more
Analog RGB input	RGB: 0.7 Vp-p 75 Ω (negative sync.) YPBPR/YCBCR : Y:1.0 Vp-p (negative sync.) PBPR/CBCR:0.7 Vp-p HD/CS : TTL level (positive or negative) VD : TTL level (positive or negative)
Control connector	Serial terminal (RS-232C) (D-SUB 9-pin) USB terminal (for Page Up/Down)
Outside dimensions	256 x 102 x 223 mm (width x height x depth)
Weight	Approx. 2.9 kg
Length of power cord	71 inch (1.8 m)
Temperature, humidity (performance guaranteed)	+41°F (+5°C) - +95°F (+35°C), 30 - 90%

- The specifications and outside appearance of the projector are subject to change without prior notice.

Kensington Lock

This projector has a Kensington Security Standard connector for use with Kensington MicroSaver Security System. Refer to the information that came with the Kensington System for instructions on how to use it to secure the projector. Please contact Kensington Technology Group below.

Kensington Technology Group

2855 Campus Drive

San Mateo, CA 94403, U.S.A.

Phone : +1- (650) 572-2700 Fax : +1- (650) 572-9675

Specifications (continued)

Connectors

MONITOR IN/OUT (Mini D-SUB 15-pin)

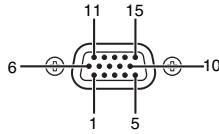

IN

OUT

pin No.	Spec.
1	VRED
2	VGREEN
3	VBBLUE
4	NC
5	GND
6	GND
7	GND
8	GND
9	VDC5V
10	GND
11	NC
12	VSDA
13	HSYNC
14	VSYNC
15	VSCL

pin No.	Spec.
1	DSUB_ROUT
2	DSUB_GOUT
3	DSUB_BOUT
4	NC
5	GND
6	GND
7	GND
8	GND
9	NC
10	GND
11	GND
12	NC
13	DSUB_HOUT
14	DSUB_VOUT
15	NC

Dimensional drawings (unit : mm)

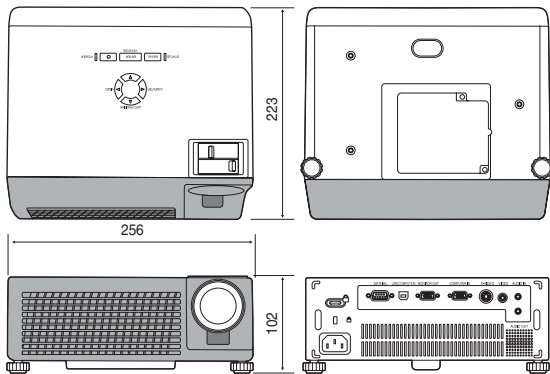

What's included in the box

AC power cord	for US 02552-0063-01	1 Remote control
	for EU 02552-0066-01	1 Safety manual/Quick start up
	for UK 02552-0065-01	1 CD-ROM
1 RGB cable for PC	02552-0072-00	2 Battery
1 VIDEO cable	02552-0068-00	1 Lens cap
		1 Soft case

Replacement part

(Option / Not included in the box)

Spare lamp

VLT-XD206LP

Specification of RGB signals in each computer mode of the projector

Signal mode	resolution (H x V)	horizontal frequency (kHz)	vertical frequency (Hz)	XD206U (H x V)
TV60, 480I	-	15.73	59.94	1024 x 768
TV50, 576I	-	15.63	50.00	1024 x 768
1080I 60 (1080I)	-	33.75	60.00	1024 x 576
1080I 50 (1080I)	-	28.13	50.00	1024 x 576
480P	-	31.47	59.94	1024 x 768
576P	-	31.25	50.00	1024 x 768
720P 60 (720P)	-	45.00	60.00	1024 x 576
720P 50 (720P)	-	37.50	50.00	1024 x 576
PC98 (VGA56)	640 x 400	24.82	56.42	1024 x 640
CGA84 (VGA85)	640 x 400	37.86	84.13	1024 x 640
CGA85 (VGA85)	640 x 400	37.86	85.08	1024 x 640
VGA60	640 x 480	31.47	59.94	1024 x 768
VGA72	640 x 480	37.86	72.81	1024 x 768
VGA75	640 x 480	37.50	75.00	1024 x 768
VGA85	640 x 480	43.27	85.01	1024 x 768
SVGA56	800 x 600	35.16	56.25	1024 x 768
SVGA60	800 x 600	37.88	60.32	1024 x 768
SVGA72	800 x 600	48.08	72.19	1024 x 768
SVGA75	800 x 600	46.88	75.00	1024 x 768
SVGA85	800 x 600	53.67	85.06	1024 x 768
XGA60	1024 x 768	48.36	60.00	1024 x 768
XGA70	1024 x 768	56.48	70.07	1024 x 768
XGA75	1024 x 768	60.02	75.03	1024 x 768
XGA85	1024 x 768	68.68	85.00	1024 x 768
SXGA70a(SXGA70)	1152 x 864	63.85	70.01	1024 x 768
SXGA75a(SXGA75)	1152 x 864	67.50	75.00	1024 x 768
SXGA60b(SXGA60)	1280 x 960	60.00	60.00	1024 x 768
SXGA60	1280 x 1024	63.98	60.02	960 x 768
MAC13 (VGA67)	640 x 480	35.00	66.67	1024 x 768
MAC16 (SVGA75)	832 x 624	49.72	74.55	1024 x 768
MAC19 (XGA75)	1024 x 768	60.24	75.02	1016 x 768
MAC21(SXGA75)	1152 x 870	68.59	74.96	1024 x 768
HP75 (XGA75)	1024 x 768	62.94	74.92	1024 x 768
SUN66a(SXGA66)	1152 x 900	61.85	66.00	984 x 768
SUN76a(SXGA76)	1152 x 900	71.81	76.64	984 x 768

Important:

- Some computers aren't compatible with the projector.
- The projector's maximum resolution is 1024 x 768 pixels. It may not display images of higher resolutions than 1024 x 768 correctly.
- Images with SYNC on G (Green) signal may jitter.
- Images with SYNC on G (Green) signal may be tinged with green.
- If the resolution and frequency of your computer aren't shown on the table, find the compatible resolution and frequency by changing the resolution of your computer.
- Set COMPUTER INPUT in the SIGNAL menu to RGB when inputting the HDTV signal as RGB signal.
- TV60 and TV50 are equivalent to 480I and 576I respectively. When these signals are supplied to the VIDEO or S-VIDEO signal, the signal mode is indicated as TV60 or TV50. When they are supplied to the COMPONENT terminal, the signal mode is indicated as 480I or 576I.
- MONITOR OUT terminal is not available for SYNC on G (Green) signal.
- The component signal is only available for an output connector for 3-line fitting.
- 480I and 576I are indicated as a component signal. (RGB is not available.)

MITSUBISHI Projector Contact Information

North America

MESCA (Mitsubishi Electric Sales Canada Inc.)
<http://www.mitsubishielectric.ca>
Information Technologies Group, 4299 14th Avenue,
Markham, Ontario L3R 0J2, Canada
Sales & Technical Inquiries

Phone : +1-(800) 450-6487

Fax : +1-(905) 475-7958

E-mail : projectors@mitsubishielectric.ca

Customer Care

E-mail :support@mitsubishielectric.ca

MDEA (Mitsubishi Digital Electronics America, Inc.)
(Warranty Registration)

<http://www.mitsubishi-presentations.com/>
Presentation Products Division, 9351 Jeronimo Road,
Irvine, CA 92618 U.S.A

Sales & Inquiries

Phone : +1(888) 307-0349 or +1(949)465-6000

E-mail : pppinfo@mdea.com

Technical Inquiries

Phone : +1-(888) 307-0309

E-mail : TSUPPORT@mdea.com

Europe

MEU-FRA (Mitsubishi Electric Europe B.V French
Branch)25, Boulevard des Bouvets 92 741, Nanterre
CEDEX, France

Sales Inquiries

Phone : +33 (0)1 55-68-55-53

Fax : +33 (0)1 55-68-57-31

Technical Inquiries

Phone : +33 (0)1 55-68-56-42

Fax : +33 (0)1 55-68-57-31

MEU-GER (Mitsubishi Electric Europe B.V. German
Branch)<http://www.mitsubishi-evs.de/>

Gothaer Strasse 8, 40880 Ratingen, Germany

Sales Inquiries

Phone : 0049 - 2102 - 486 9250

Fax : 0049 - 2102 - 486 7320

Technical Inquiries

Phone : 0049 - 2102 - 486 1330

Fax : 0049 - 2102 - 486 1340

MEU-IR (Mitsubishi Electric Europe B.V. Irish
Branch)<http://www.mitsubishi.ie/>

Westgate Business Park, Ballymount, Dublin 24,
Ireland

Sales Inquiries

Phone : +353-1-4198807

Fax : +353-1-4198890

Technical Inquiries

Phone : +353-1-4198808

Fax : +353-1-4198895

MEU-IT (Mitsubishi Electric Europe B.V. Italian
Branch)Centro Direzionale Colleoni, Palazzo Sirio, Viale
Colleoni 7, 20041 Agrate Brianza, Italy

Sales & Technical Inquiries

Phone : +39-(0)39-60531

Fax : +39-(0)39-6053214

E-mail : info.projector@it.mee.com

MEU-NL (Mitsubishi Electric Europe B.V. Benelux
Branch)

<http://www.mitsubishi.nl/LCD/ProdFrame.html>

Nijverheidsweg 23A, 3641 RP Mijdrecht, The
Netherlands

Sales Inquiries

Phone : +31-297-282461

Fax : +31-297-283936

E-mail : info@mitsubishi.nl

Technical Inquiries

Phone : +31-297-282461

Fax : +31-297-283936

E-mail : info@mitsubishi.nl

Russia (Mitsubishi Electric Europe B.V Moscow
Representative Office)

<http://www.mitsubishi-projector.ru/>

Moscow Representative Office, 52/5

Kosmodamianskaya Nab., 115054, Moscow, Russia

Sales & Technical Inquiries

Phone : (7095) 721-2068

Fax : (7095) 721-2071

MEU-SP (Mitsubishi Electric Europe B.V. Spanish
Branch)<http://www.mitsubishielectric.es/Ctra.deRubi>,

76-80, 08173 Sant Cugat del Valles, Barcelona,

Spain

Sales Inquiries

Phone : +34-93.565.31.54

Fax : +34-93.589.43.88

E-mail : mitsubishi.profesional@sp.mee.com

Technical Inquiries

Phone : +34-93.586.27.51

Fax : +34-93.588.53.87

E-mail :mitsubishi.profesional@sp.mee.com

MEU-SWE (Mitsubishi Electric Europe B.V Scandinavian
Branch)Hammarbacken 14, Box 750, S-19127,
Solletuna, Sweden

Sales Inquiries

Phone : +46-(0)8-6251070

Fax : +46-(0)8-6251036

Technical Inquiries

Phone : +46-(0)8-6251052

Fax : +46-(0)8-6251036

MEU-UK (Mitsubishi Electric Europe)
<http://www.mitsubishi.co.uk/evs/Visual> Information
Systems Division, Travellers Lane, Hatfield,
Hertfordshire, AL10 8XB U.K.

Sales Inquiries

Phone : +44 (1707) 278684

Fax : +44 (1707) 278541

E-mail : projector.info@meuk.mee.com

Technical Inquiries

Phone : +44 (870) 606 5008

Fax : +44 (1506) 431927

E-mail : projector.info@meuk.mee.com

AsiaCHINA (Mitsubishi Electric Air-Conditioning & Visual
Information Systems (Shanghai) Ltd.) 26/F.,Oriental
Center ,699 Nanjing Rd(W),Shanghai, 200041,China

Sales Inquiries

Phone : +86(21) 5211-0882-3002

Fax : +86(21) 5211-0576

Technical Inquiries

Phone : +86(21) 5211-0882-3020

Fax : +86(21) 5211-0576

HONG KONG (Mitsubishi Electric Ryoden Air-
Conditioning & Visual Information Systems (HongKong)
Ltd.) 7th Floor, Manulife Tower, 169 Electric Road, North
Point, Hong Kong

Sales Inquiries

Phone : +852-2510-1505

Fax : +852-2510-0463

Technical Inquiries

Phone : +852-2422-0161

Fax : +852-2487-0181

SINGAPORE (Mitsubishi Electric Asia Pte. Ltd.)
<http://www.mitsubishielectric.com.sg307>, Alexandra Road, #05-01/02 Mitsubishi Electric
Building, Singapore 159943

Sales Inquiries

Phone : +65-6473-2308

Fax : +65-6475-9503

E-mail : Peripherals@asia.meap.com

Technical Inquiries

Phone : +65-6470-2666

Fax : +65-6475-9503

INDIA (Mitsubishi Electric Asia Pte. Ltd.)307, Alexandra
Road, #05-01/02 Mitsubishi Electric Building, Singapore
159943

Sales Inquiries

Phone : +65-6473-2308

Fax : +65-6475-9503

E-mail : Peripherals@asia.meap.com

Technical Inquiries

Phone : +65-6470-2666

Fax : +65-6475-9503

INDONESIA (Mitsubishi Electric Asia Pte. Ltd.)307,
Alexandra Road, #05-01/02 Mitsubishi Electric Building,
Singapore 159943

Sales Inquiries

Phone : +65-6473-2308

Fax : +65-6475-9503

E-mail : Peripherals@asia.meap.com

Technical Inquiries

Phone : +65-6470-2666

Fax : +65-6475-9503

PHILLIPINES (Mitsubishi Electric Asia Pte. Ltd.)
<http://www.mitsubishielectric.com.sg307>, Alexandra
Road, #05-01/02 Mitsubishi Electric Building, Singapore
159943

Sales Inquiries

Phone : +65-6473-2308

Fax : +65-6475-9503

E-mail : Peripherals@asia.meap.com

Technical Inquiries

Phone : +65-6470-2666

Fax : +65-6475-9503

PHILLIPINES (Mitsubishi Electric Asia Pte. Ltd.)
<http://www.mitsubishielectric.com.sg307>, Alexandra
Road, #05-01/02 Mitsubishi Electric Building, Singapore
159943

Sales Inquiries

Phone : +65-6473-2308

Fax : +65-6475-9503

E-mail : Peripherals@asia.meap.com

Technical Inquiries

Phone : +65-6470-2666

Fax : +65-6475-9503

E-mail : Peripherals@asia.meap.com

VIETNAM (Mitsubishi Electric Asia Pte. Ltd.) 307,
Alexandra Road, #05-01/02 Mitsubishi Electric Building,
Singapore 159943

Sales Inquiries

Phone : +65-6473-2308

Fax : +65-6475-9503

E-mail : Peripherals@asia.meap.com

Technical Inquiries

Phone : +65-6470-2666

Fax : +65-6475-9503

E-mail : Peripherals@asia.meap.com

STC (Setsuyo Astec Corporation Seoul Branch)
4F,Dongseo Game Channel Bldg,660-11 Deungchon-
Dong, Kangseo-Ku, Seoul, Korea

Sales & Technical Inquiries

Phone : +82-(0)2-2657-9841-3

Fax : +82-(0)2-2657-9900

MALAYSIA (Antah Melco Sales & Services Sdn. Bhd.)6,
Jalan 13/6 46860 Petaling Jaya Selangor, Darul Ehsan,
Malaysia

Sales & Technical Inquiries

Phone : +60-(0)3-79552088 (Ext. 203)

Fax : +60-(0)3-79563950/+60-(0)3-79582576

Technical & Service Inquiries

Phone : +60-(0)3-79552088 (Ext. 106)

Fax : +60-(0)3-79563950/+60-(0)3-79582576

ME-TWN (Mitsubishi Electric Taiwan Co., Ltd.)
<http://www.MitsubishiElectric.com.tw>

11TH FL., 90 SEC. 6, CHUNG SHAN N. RD., TAIPEI,
111 R.O.C.

Sales & Technical Inquiries

Phone : +886-2-2832-8255

Fax : +886-2-2833-9813

MKY (Mitsubishi Electric Kang Yong Watana Co., Ltd.)
<http://www.MitsubishiElectric.com.th>, Ruydamere, N.S.W.
2116, Australia

Sales & Technical Inquiries

Phone : +(612)9684-7777

Fax : +(612)9684-7208

E-mail : diamonddigital@meaust.meap.com

Technical Inquiries

Phone : +(612)9684-7694

Fax : +(612)9684-7684

E-mail : service@meaust.meap.com

BDT (Black Diamond Technologies Ltd.)(Warranty
Registration)
<http://www.bdt.co.nz/projectors/warranty.asp> Parli-
ment St, Lower Hutt, Wellington, New Zealand

Sales Inquiries

Phone : +64-(0)4-560-9100

Fax : +64-(0)4-560-9133

E-mail : projectorsales@bdt.co.nz

Technical Inquiries

Phone : +64-(0)4-560-9100

Fax : +64-(0)4-560-9133

E-mail : service@bdt.co.nz



MITSUBISHI ELECTRIC CORPORATION

1 Zusho Baba, Nagaokakyo-City, Kyoto Japan