

myprojectorlamps.com

**The most trusted, dependable name
in projector lamp sales.**



<http://www.myprojectorlamps.com>



<http://www.myprojectorlamps.ca>



<http://www.myprojectorlamps.eu>

The following projector manual has not been modified or altered in any way.



DLP™ HIGH-DEFINITION TELEVISION

MODELS

WD-Y57

WD-Y65

WD-57732

WD-65732

WD-73732

OWNER'S GUIDE

- For questions:
 - Call Consumer Relations at 800-332-2119.
 - E-mail us at MDEAservice@mdea.com.
 - Visit our website at www.mitsubishi-tv.com.
- For information on **Demo Mode** and **System Reset**, please see the back cover.
- To order replacement or additional remote controls, lamp cartridges, or Owner's Guides, visit our website at www.mitsuparts.com or call 800-553-7278.
- Guidelines for setting up and using your new widescreen TV start on page 34.



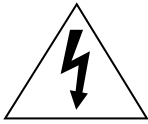

CAUTION

RISK OF ELECTRIC SHOCK
DO NOT OPEN



CAUTION: TO REDUCE THE RISK OF ELECTRIC SHOCK, DO NOT REMOVE COVER (OR BACK). NO USER SERVICEABLE PARTS INSIDE. REFER SERVICING TO QUALIFIED SERVICE PERSONNEL.

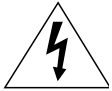

The lightning flash with arrowhead symbol within an equilateral triangle is intended to alert the user of the presence of uninsulated “dangerous voltage” within the product’s enclosure that may be sufficient magnitude to constitute a risk of electric shock.



The exclamation point within an equilateral triangle is intended to alert the user to the presence of important operating and maintenance (servicing) instructions in the literature accompanying the appliance.

WARNING: TO REDUCE THE RISK OF FIRE OR ELECTRIC SHOCK, DO NOT EXPOSE THIS APPLIANCE TO RAIN OR MOISTURE.

FCC Declaration of Conformity

Product: Projection Television Receiver
Models: WD-Y57, WD-Y65, WD-57732, WD-65732, WD-73732
Responsible Party: Mitsubishi Digital Electronics America, Inc.
9351 Jeronimo Road
Irvine, CA 92618-1904
Telephone: (800) 332-2119

This device complies with Part 15 of the FCC Rules. Operation is subject to the following two conditions:

- (1) This device may not cause harmful interference, and
- (2) this device must accept any interference received, including interference that may cause undesired operation.

Note: This equipment has been tested and found to comply with the limits for a Class B digital device, pursuant to part 15 of the FCC Rules. These limits are designed to provide reasonable protection against harmful interference in a residential installation. This equipment generates, uses and can radiate radio frequency energy and, if not installed and used in accordance with the instructions, may cause harmful interference to radio communications. However, there is no guarantee that interference will not occur in a particular installation. If this equipment does cause harmful interference to radio or television reception, which can be determined by turning the equipment off and on, the user is encouraged to try to correct the interference by one or more of the following measures:

- Reorient or relocate the receiving antenna.
- Increase the separation between the equipment and the receiver.
- Connect the equipment into an outlet on a circuit different from that to which the receiver is connected.
- Consult the dealer or an experienced radio/TV technician for help.

Changes or modifications not expressly approved by Mitsubishi could cause harmful interference and would void the user’s authority to operate this equipment.

Our Thanks...

Thank you for choosing Mitsubishi as your premier Home Entertainment provider

This Owner's Guide describes the features and functions of your Mitsubishi widescreen, high definition TV. We urge you to examine this Owner's Guide to become familiar with the innovative features and operations this unique television offers.

The very core of our corporate philosophy is to provide our customers with the very best. Our development team at Mitsubishi has worked to provide you with a television that defines "state-of-the-art," with the capability to meet your needs now and in the future.

Whether this is your first Mitsubishi electronic product, or an addition to your Mitsubishi collection, we believe you and your family will continue to enjoy your Mitsubishi home theater for many years.

Thank you,

Mitsubishi Digital Electronics America, Inc.

For Your Records

Record the model number, serial number, and purchase date of your TV. The model and serial numbers are on the back of the TV. Refer to this page when requesting assistance with this TV.

MODEL NUMBER (check one):

WD-Y57

WD-Y65

WD-57732

WD-65732

WD-73732

SERIAL NUMBER _____

PURCHASE DATE _____

Retailer Information

RETAILER NAME _____

LOCATION _____

Contents

Important Information About Your TV

General Warnings and Cautions, Notes on Installation and Operation	6
Cleaning Recommendations	7
Important Safeguards	8

Chapter 1: Television Overview

Package Contents	12
Special Features of Your TV	12
TV Front Panel	14
TV Back Panel	16
CableCARD™ Technology	18

Chapter 2: TV Connections

Connection Types	20
Digital Video and Home Recording	21
HDTV Cable Box or Satellite Receiver with Component Video	21
Standard Cable Box, Satellite Receiver, or Other Device with S-Video	22
Wall Outlet Cable (no cable box)	22
Antenna with a Single Lead	23
Antennas with Separate UHF and VHF Leads	23
VCR to an Antenna or Wall Outlet Cable	24
VCR to a Cable Box (Audio & Video)	25
HDMI Device (Cable Box, Satellite Receiver, DVD Player, or Other Device)	26
DVI Video Device (Cable Box, Satellite Receiver, DVD Player, or Other Device)	26
DVD Player with Component Video	27
A/V Receiver (Sound System)	27
Older Cable Box	28
Camcorder	28
IEEE 1394 Devices	29
IR Emitter NetCommand® and TV Guide On Screen	31
Helpful Hints for NetCommand Connections	32

Chapter 3: TV Setup

Guidelines for Setting Up and Using Your New Widescreen TV	34
When You First Power On the TV	36
Using the TV's Setup Menu	36
When You First Connect a Device	39
Initial NetCommand® Setup	42
Additional Setup Using the NetCommand Menu	43

Chapter 4: TV Operation and Features

Remote Control	48
Choosing a Program Source	50
ChannelView™ Channel Listings	50
Status Display	51
Split Screen	52
TV Signals and Display Formats	54
Memory Card Playback	56

Chapter 5: TV Menu Settings

3D Graphical ▶ViewPoint® Menu System	60
Main Menu	61
Setup Menu	62
NetCommand Menu	62
Channel Menu	64
Captions Menu	66
Parental Lock Menu	68
Setting a Pass Code	68
Lock TV by Time and Front-Panel Lock	68
Rating Menus	68
Bypassing the Ratings Lock and Lock by Time	70
V-Chip Signal Information	
TV Ratings	71
Movie Ratings	71
Audio/Video Menu	72
Audio Settings	72
Video Settings	74

Chapter 6: NetCommand Functions

NetCommand-Controlled Devices and the Input Selection Menu	78
NetCommand-Controlled Recording	79
Using IEEE 1394 Devices	83

Chapter 7: Using the TV with a Personal Computer

Setup	88
Video Adjustments	88
Connecting a Computer to the TV	89
Adjusting Image Resolution	91
Computer Display Formats	92

Appendices

Appendix A: Bypassing the Parental Lock	95
Appendix B: Specifications	97
Appendix C: Lamp Cartridge Replacement	99
Appendix D: Programming the Remote Control	101
Appendix E: Troubleshooting	111

Trademark and License Information	118
--	-----

Mitsubishi TV Software	119
---	-----

Mitsubishi DLP™ Projection Television Limited Warranty	120
---	-----

Index	122
------------------------	-----

Important Information About Your TV

WARNING: This product contains chemicals known to the State of California to cause cancer and/or birth defects or other reproductive harm.

CAUTION: TO PREVENT ELECTRIC SHOCK, MATCH WIDE BLADE OF PLUG TO WIDE SLOT, FULLY INSERT.

TV WEIGHT: This TV is heavy! Exercise extreme care when lifting or moving it. Lift or move the TV with a minimum of two adults. To prevent damage to the TV, avoid jarring or moving it while it is turned on. Always power off your TV before moving it.

Installation Notes

Stand Requirement

CAUTION: Use these Mitsubishi TV models only with the Mitsubishi stand models shown here. Other stands can result in instability and possibly cause injury.

TV Model	Stand Model
WD-Y57	MB-57GB
WD-Y65	MB-65GB
WD-57732	MB-57GB
WD-65732	MB-65GB
WD-73732	MB-73GB

Custom cabinet installation must allow for proper air circulation around the television.

NOTE TO CATV SYSTEM INSTALLER: THIS REMINDER IS PROVIDED TO CALL THE CATV SYSTEM INSTALLER'S ATTENTION TO ARTICLE 820-40 OF THE NEC THAT PROVIDES GUIDELINES FOR THE PROPER GROUNDING AND, IN PARTICULAR, SPECIFIES THAT THE CABLE GROUND SHALL BE CONNECTED TO THE GROUNDING SYSTEM OF THE BUILDING, AS CLOSE TO THE POINT OF CABLE ENTRY AS PRACTICAL.

Operating Notes

Standby Fan

When the TV is off, you may hear a low-power standby fan. This is normal operation. The fan cools advanced circuitry in this TV that must continue to operate even when the TV is turned off.

Demo Mode

This TV has a demo mode for use in retail stores. To turn off demo mode:

1. Press **MENU**.
2. When the Main menu appears with **Setup** highlighted, press **ENTER**.
3. When the Setup menu opens, press **▶** to highlight the on-screen **Demo Mode Off** button.
4. Press **ENTER**.

TV Guide On Screen® Access Requirements

TV Guide On Screen listings are not provided by Mitsubishi Digital Electronics America, Inc. Operation of TV Guide On Screen requires over-the-air or cable access to stations carrying TV Guide On Screen program listings. If listings are not available in your area or become discontinued by the local provider, TV Guide On Screen will not

operate. TV Guide On Screen does not provide program listings for satellite TV systems.

Lamp Replacement

For lamp-replacement instructions, see Appendix C.

To Order a Replacement Lamp Under Warranty

Call (800) 553-7278. Please have model number, serial number, and TV purchase date available.

Important: All lamps replaced under warranty must be returned to Mitsubishi where they will be inspected for defect verification.

To Purchase a Replacement Lamp After Warranty

Visit our website at www.mitsuparts.com or call (800) 553-7278. Order a new lamp by part number as shown below.

TV Model Number	Lamp Part Number
WD-Y57, WD-Y65, WD-57732, WD-65732	915P049010
WD-73732	915P049020

Cleaning Recommendations

Normally, light dusting with a dry, non-scratching duster will keep your TV clean. If cleaning beyond this is needed, please use the following guidelines:

First, turn off the TV and unplug the power cord from the power outlet.

Top and Sides of the TV

- Gently wipe down your TV with a soft, non-abrasive cloth such as cotton flannel or a clean cloth diaper, lightly moistened with water. Dry with a second dry, soft, non-abrasive cloth.
- For oily dirt, add a few drops of mild liquid detergent, such as dishwashing detergent, to the water used to moisten the cloth. Rinse with a second cloth moistened only with water. Dry with a third dry, soft, non-abrasive cloth.

Screen

- Follow the instructions for the top and sides, wiping gently in an up and down motion, following the grooves in the screen.
- Clean the entire screen evenly, not just sections of the screen.
- Do not allow liquid to drip down the grooves of the screen, as some liquid may enter the TV through the gap between the screen and screen frame.
- You may purchase Mitsubishi Screen Cleaner, part number CLEANER-VSS, by calling (800) 553-7278.

General Cleaning Precautions

- DO NOT allow liquid to enter the TV through the ventilation slots or any crevice.
- DO NOT use any strong or abrasive cleaners, as these can scratch the surfaces.
- DO NOT use any cleaners containing ammonia, bleach, alcohol, benzene, or thinners, as these can dull the surfaces.
- DO NOT spray liquids or cleaners directly on the TV's surfaces.
- DO NOT scrub or rub the TV harshly. Wipe it gently.

TV Software

Unauthorized Software

Do not attempt to update the software of this TV with software or cards that are not provided by or authorized by Mitsubishi Digital Electronics America, Inc. Non-authorized software may damage the TV and will not be covered by the warranty.

IMPORTANT

DO NOT use any kind of abrasive cleaner on the surface of the TV screen.

Important Safeguards

Please read the following safeguards for your TV and retain for future reference. Always follow all warnings and instructions marked on the television.

1. Read, Retain and Follow All Instructions

Read all safety and operating instructions before operating the TV. Retain the safety and operating instructions for future reference. Follow all operating and use instructions.

2. Heed Warnings

Adhere to all warnings on the appliance and in the operating instructions.

3. Cleaning

Unplug the TV from the wall outlet before cleaning. Do not use liquid, abrasive or aerosol cleaners. Cleaners can permanently damage the cabinet and screen. Use a lightly dampened cloth for cleaning.

4. Attachments and Equipment

Never add any attachments and/or equipment without approval of the manufacturer as such additions may result in the risk of fire, electric shock or other personal injury.

5. Water and Moisture

Do not use the TV where contact with or immersion in water is possible. Do not use near bath tubs, wash bowls, kitchen sinks, laundry tubs, swimming pools, etc.

6. Accessories



Do not place the TV on an unstable cart, stand, tripod, or table. The TV may fall, causing serious injury to a child or adult and serious damage to the TV. Use only with a cart, stand, tripod, bracket or table recommended by the manufacturer, or sold with the TV. Any mounting of the TV should follow the manufacturer's instructions, and should use mounting accessories recommended by the manufacturer.

An appliance and cart combination should be moved with care. Quick stops, excessive force, and uneven surfaces may cause the appliance and cart combination to overturn.

7. Ventilation

Slots and openings in the cabinet are provided for ventilation and to ensure reliable operation of the TV and to protect it from overheating. Do not block these openings or allow them to be obstructed by placing the TV on a bed, sofa, rug, or other similar surface. Nor should it be placed over a radiator or heat register. If the TV is to be placed in a rack or bookcase, ensure that there is adequate ventilation and that the manufacturer's instructions have been adhered to.

8. Power Source

This TV should be operated only from the type of power source indicated on the marking label. If you are not sure of the type of power supplied to your home, consult your appliance dealer or local power company.

9. Grounding or Polarization

This TV is equipped with a polarized alternating current line plug having one blade wider than the other. This plug will fit into the power outlet only one way. If you are unable to insert the plug fully into the outlet, try reversing the plug. If the plug should still fail to fit, contact your electrician to replace your obsolete outlet. Do not defeat the safety purpose of the polarized plug.

10. Power-Cord Protection

Power-supply cords should be routed so that they are not likely to be walked on or pinched by items placed upon or against them, paying particular attention to cords at plugs, convenience receptacles, and the point where they exit from the TV.

11. Lightning

For added protection for this TV during a lightning storm, or when it is left unattended and unused for long period of time, unplug it from the wall outlet and disconnect the antenna or cable system. This will prevent damage to the TV due to lightning and power-line surges.

Important Safeguards, continued

12. Power Lines

An outside antenna system should not be located in the vicinity of overhead power lines or other electric light or power circuits, or where it can fall into such power lines or circuits. When installing an outside antenna system, extreme care should be taken to keep from touching such power lines or circuits as contact with them might be fatal.

13. Overloading

Do not overload wall outlets and extension cords as this can result in a risk of fire or electric shock.

14. Object and Liquid Entry

Never push objects of any kind into this TV through openings as they may touch dangerous voltage points or short-out parts that could result in fire or electric shock. Never spill liquid of any kind on or into the TV.

15. Outdoor Antenna Grounding

If an outside antenna or cable system is connected to the TV, be sure the antenna or cable system is grounded so as to provide some protection against voltage surges and built-up static charges.

Article 810 of the National Electric Code, ANSI/NFPA No. 70-2002, provides information with respect to proper grounding of the mast and supporting structure, grounding of the lead in wire to an antenna discharge unit, size of grounding conductors, location of antenna discharge unit, connection to grounding electrodes, and requirements for the grounding electrode.

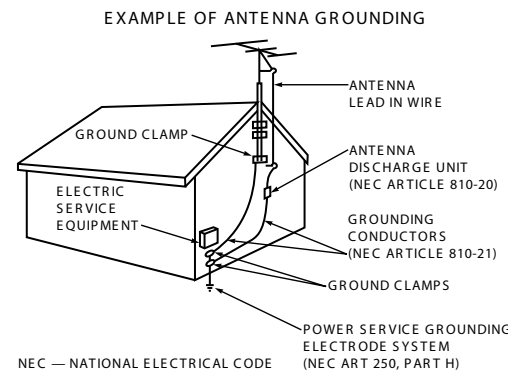

16. Servicing

Do not attempt to service this TV yourself as opening or removing covers may expose you to dangerous voltage or other hazards. Refer all servicing to qualified service personnel.

17. Damage Requiring Service

Unplug the TV from the wall outlet and refer servicing to qualified service personnel under the following conditions:

- When the power-supply cord or plug is damaged.
- If liquid has been spilled, or objects have fallen into the TV.
- If the TV has been exposed to rain or water.
- If the TV does not operate normally by following the operating instructions, adjust only those controls that are covered by the operating instructions as an improper adjustment of other controls may result in damage and will often require extensive work by a qualified technician to restore the TV to its normal operation.
- If the TV has been dropped or the cabinet has been damaged.
- When the TV exhibits a distinct change in performance - this indicates a need for service.

18. Replacement Parts

When replacement parts are required, be sure the service technician has used replacement parts specified by the manufacturer or have the same characteristics as the original part. Unauthorized substitutions may result in fire, electric shock or other hazards.

19. Safety Check

Upon completion of any service or repair to the TV, ask the service technician to perform safety checks to determine that the TV is in safe operating condition.

20. Heat

The product should be situated away from heat sources such as radiators, heat registers, stoves or other products (including amplifiers) that produce heat.



Television Overview

Package Contents	12
Special Features of Your TV	12
TV Front Panel	14
TV Back Panel	16
CableCARD™ Technology	18

Package Contents

Please take a moment to review the following list of items to ensure that you have received everything.

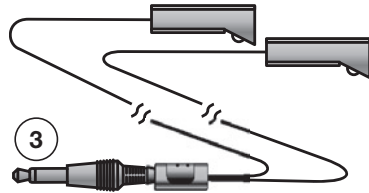
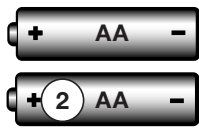
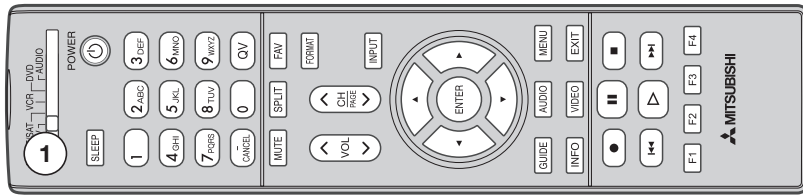

1. Remote Control
2. Two AA Batteries
3. Two-Ended IR Emitter
4. Owner's Guide
5. Quick Reference Guide
6. TV Guide On Screen® Interactive Program Guide User's Manual
7. Product Registration Card

Special Features of Your TV

Your new high-definition widescreen television has many special features that make it the perfect center of your home entertainment system, including:

High Definition DLP™ Display System

Your widescreen Mitsubishi HDTV uses Texas Instruments most advanced Digital Light Processing™ technology for rear-projection televisions. This TV is truly a high-performance multimedia monitor uniquely capable of both stunning high-definition video images and clear, detailed, high-resolution images from a personal computer.

16:9 Widescreen Picture Format

Enjoy a full theatrical experience in the comfort of your home. View pictures as film directors intended them. Digital TV broadcasts, DVDs and newer video game consoles support this widescreen format.

Integrated HDTV Tuner

Your widescreen Mitsubishi HDTV has an internal HDTV tuner able to receive both over-the-air HDTV broadcasts (received via an antenna) and non-scrambled digital cable broadcasts, including non-scrambled HDTV cable programming.

High-Definition Video Inputs

- ◆ **Component Video Inputs**, two on models WD-Y57 and WD-Y65; three on models WD-57732, WD-65732, and WD-73732. Also called Y/Pb/Pr inputs, these inputs receive standard analog video formats of 480i, 480p, 720p, and 1080i high-definition signals. This

provides a high level of flexibility when connecting DVD players/recorders, cable boxes, and satellite receivers.

- ◆ **Two HDMI Inputs** that accept digital 480i, 480p, 720p, 1080i, and 1080p video signals plus PCM digital stereo signals. Used with an adapter, these inputs also accept compatible DVI video signals. HDMI inputs provide additional high-performance, high-definition connections for maximum flexibility in your choice of home theater products. The HDMI inputs are HDCP copy-protection compatible.
- ◆ **Two IEEE 1394 Digital Interfaces** that receive and send compressed digital signals, including high-definition signals, along with digital audio and control signals between devices such as the TV, digital cable boxes, and D-VHS digital video recorders.

ClearThought® Easy Connect Auto Input Sensing

ClearThought® automatically recognizes when you plug in an input and prompts you to assign a name to it. The TV ignores any unused inputs, so the result is an uncluttered Input Selection menu where you can easily find and select connected devices by name.

Digital Cable Ready (CableCARD™)

Your widescreen Mitsubishi HDTV is "Plug-and-Play" digital cable ready. It can descramble a cable provider's

one-way digital signals with the use of a CableCARD security module. The CableCARD is used in place of a traditional cable box to access digital cable programming (including high definition). Contact your local cable provider for availability information and service details.

NetCommand® Home Network Control System

Your widescreen Mitsubishi HDTV offers a new level of networking that can seamlessly integrate selected older A/V products with new and future digital products. NetCommand supports IEEE 1394 connections, Audio Video Control system (AV/C), 5C copy protection, and IR (infrared) control of selected older products, such as VCRs, DVD players, cable boxes, and satellite receivers. NetCommand can learn remote control signals directly from many devices, allowing you to create a customized NetCommand-controlled home-theater system.

Memory Card Reader

(models WD-57732, WD-65732, WD-73732)

You can display a slide show of your favorite JPEG pictures or listen to MP3 or WMA audio selections recorded on compatible memory cards.

DVI-I Input for Computer Video

Connect your personal computer's HDMI or DVI video output to this jack to display computer images on the TV.

TV Guide On Screen® Interactive Program Guide System

An eight-day on-screen program guide for cable, over-the-air, and CableCARD™ reception. This subscription-free guide system lists regular, digital, and high-definition programming. Note that when the system is first set up, it may take up to 24 hours to begin to receive TV program listings and then it may take up to one week to receive all eight days of TV program listings.

TV Front Panel

Control Panel

The shaded buttons on the front control panel duplicate keys on the remote control. The upper labels show control functions when no TV menus are displayed; the lower labels indicate functions when TV menus are displayed or when a special function has been activated. See “Remote Control Overview” in chapter 4, “TV Operation and Features,” for further details on the functions of these buttons.

System Reset Button

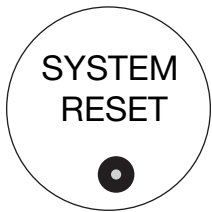

If the TV does not respond to the remote control, front panel controls, or will not power on/off, press the **SYSTEM RESET** button on the front panel with a pointed object, such as the point of a pencil or end tip of a paperclip. The green LED will flash quickly for about one minute. When the green LED stops flashing, you may turn on the TV. The changes you made most recently, before using **SYSTEM RESET**, may be lost.

A/V Reset

If you wish to reset the A/V (Audio/Video) settings back to the factory defaults:

- To reset all settings at once, press **GUIDE** and **FORMAT** on the front panel at the same time.
- To reset the defaults for individual devices, use the **A/V Memory Reset** selection on the Audio/Video menu.

Front Panel Controls and Indicators

1. Shaded buttons are duplicates of keys on the remote control
2. **POWER/TIMER** indicator—lit during normal operation; flashing when auto-on TV Timer is set
3. **LAMP** indicator shows lamp condition (usually off during normal TV operation)
4. **STATUS** indicator (off during normal TV operation)
5. **SYSTEM RESET** (see description this page)

Input 3

INPUT 3 provides an easily accessible set of standard audio/video jacks. These jacks allow for convenient connection of a camcorder or other audio/video device. Note that if you connect to the **S-VIDEO** jack, the **VIDEO** jack is deactivated.

Memory Card Reader

(models **WD-57732**, **WD-65732**, **WD-73732**)

The memory card reader has four card slots that accept a variety of popular memory card types. The reader lets you view JPEG pictures from many digital cameras and allows you to listen to MP3 or WMA audio files recorded from computers or other digital recording devices.

The card slots are designed for the specific types of cards listed below. Other cards or objects should not be inserted into the slots as this may damage the TV. See the discussion of memory cards in chapter 4 “TV Operation and Features” for details about JPEG, MP3 and WMA file types that are compatible with the TV.

Card Compatibility	
A. CARD 1	SmartMedia™
B. CARD 2	MultiMediaCard™ Secure Digital (SD)
C. CARD 3	CompactFlash® (Types I and II) Microdrive®
D. CARD 4	Memory Stick PRO™ Memory Stick™

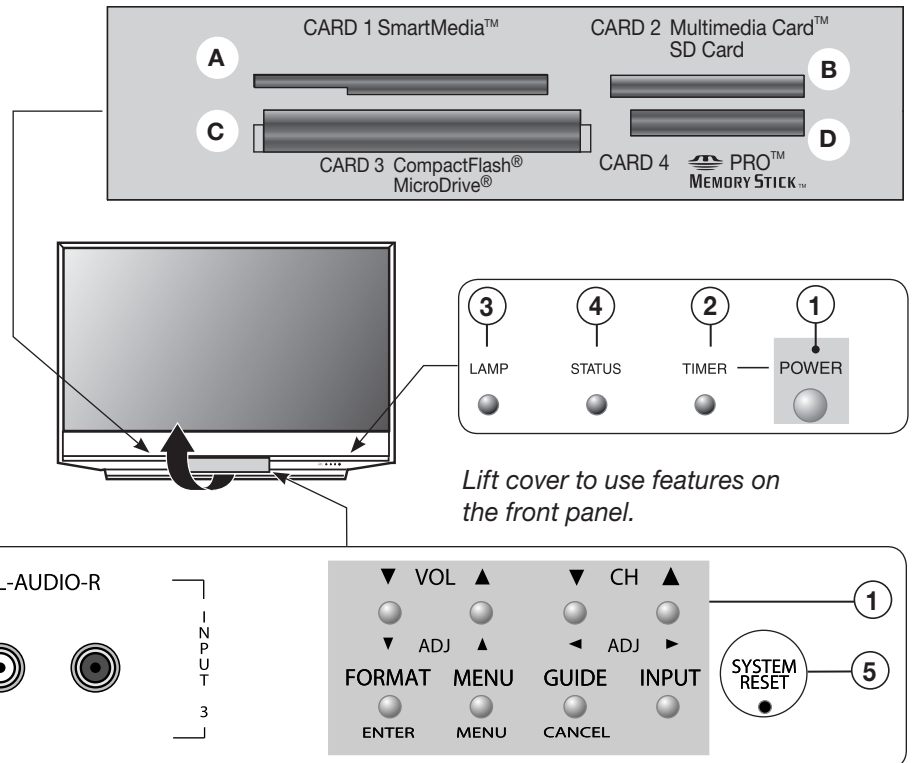

Right: **INPUT 3** and controls on front panel

Front-Panel Indicators

○ Off ● Steady On ◐ Slow Blinking ◎ Fast Blinking

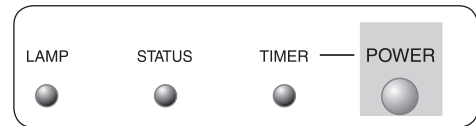

LAMP Indicator

LED Color	TV Condition	Additional Information
None ○	Normal TV on or standby condition.	Normal operation.
Green ◎	TV just powered off and lamp is cooling.	Starts to blink 30 seconds after turning off TV. TV can be turned on before blinking starts or after blinking stops, but not while the indicator is blinking. Normal operation.
Yellow ◐	1. Lamp access door is open or not secure.	TV will not operate until lamp access door is secure. See Appendix C for installation information.
	2. No lamp installed.	TV will not operate without a lamp. See Appendix C for installation information.
Red ●	Lamp no longer illuminates and has reached the end of the lamp life.	Replace the lamp. The TV will not operate when the lamp no longer illuminates. See Appendix C for installation information.

STATUS Indicator

LED Color	TV Condition	Additional Information
None ○	Normal TV on or standby condition.	Normal operation.
Yellow ●	Room temperature is too high.	TV will not operate when the ambient room temperature is too high. Turn off the TV and wait until the room temperature drops.
Red ● ◐	TV may require service.	Turn off the TV and unplug the set from the AC power source. Wait one minute and then plug the set back in. If the LED is still on, contact your dealer or a Mitsubishi Authorized Service Center. See www.mitsubishi-tv.com or call 1-800-332-2119 to receive Authorized Service Center information.

POWER/TIMER Indicator

LED Color	TV Condition	Additional Information
None ○	TV is powered off.	Normal operation.
Green ●	TV is powered on.	Normal operation.
Green ◎	1. TV just plugged into AC outlet.	Wait until blinking stops before turning on (approximately 1 minute). Normal operation.
	2. AC just restored after power failure.	
	3. TV Rebooting after System Reset used.	
	4. TV Rebooting after power fluctuation or receiving abnormal digital signals from digital channel, CableCARD™, or digital device.	
	5. You have begun the procedure to update software from an authorized flash memory device.	For detailed information, see the instructions that accompany the authorized software update. Important: Do not use unauthorized software at any time.
Green ◐	TV powered off and auto-on timer is set.	Normal operation. TV can be turned on at any time.

TV Back Panel

COMPONENT inputs 1 and 2 offered on models WD-Y57 and WD-Y65.

COMPONENT inputs 1, 2, and 3 offered on models WD-57732, WD-65732, and WD-73732.

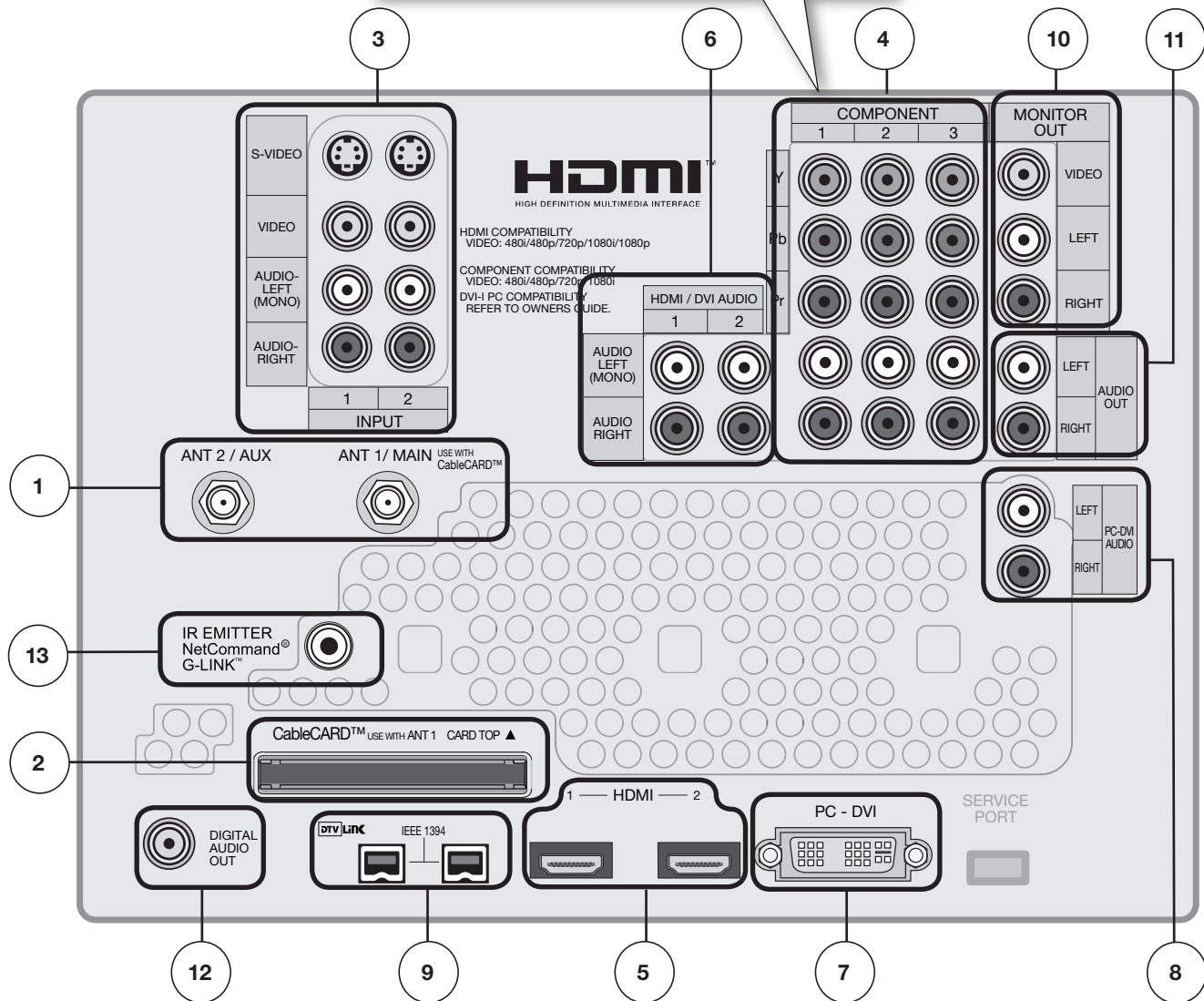

1. ANT 1/MAIN, ANT 2/AUX (Antenna)

If you are connecting an antenna, direct cable without a cable box, or are using cable with a CableCARD™, connect the main antenna or cable source to **ANT 1/MAIN**.

ANT 1/MAIN and **ANT 2/AUX** can each receive both digital and analog over-the-air channels from a VHF/UHF antenna or non-scrambled digital/analog cable source.

ANT 1/MAIN and CableCARD™

Use **ANT 1/MAIN** to receive premium subscription cable TV service authorized by the CableCARD™ access card. The CableCARD access card is provided by your local cable company. **ANT 2/AUX** can continue to receive over-the-air or non-scrambled cable signals when **ANT 1** is used for CableCARD™ service.

2. CableCARD™ Slot

The CableCARD access card from your cable TV service provider is inserted into this slot. When inserting, ensure that the top of the card faces in the direction indicated by **CARD TOP ▲**.

If your cable company is not currently offering CableCARD access cards, use the cable box provided and authorized by your local cable company to view scrambled channels.

3. INPUT 1 and 2 Inputs

(Audio and Video)

INPUT 1 and **2** can be used to connect a VCR, Super VHS (S-VHS) VCR, DVD player, standard satellite receiver, or other A/V device to the TV. **INPUT 3** is a third set of jacks located on or near the front of the TV for convenience. Please note that if **S-VIDEO** and **VIDEO** are both available, you must choose to connect only one.

TV Back Panel, continued

4. COMPONENT Inputs

(COMPONENT 1 and 2 on WD-Y57, WD-Y65; COMPONENT 1–3 on WD-57732, WD-65732, WD-73732)

(Audio and Video)

Y Pb Pr (480i/480p/720p/1080i)

Use these jacks to connect devices with component video outputs, such as DVD players, external HDTV receivers, or compatible video game systems. Please see Appendix B for signal compatibility.

5. HDMI™ 1 and 2

The HDMI (High Definition Multimedia Interface) supports uncompressed standard and high-definition digital video formats and PCM digital audio format. For PC video, use the **PC-DVI** input instead.

Do not connect a computer to either TV HDMI jack.

Use these inputs to connect to EIA/CEA-861 compliant devices such as a high-definition receiver or DVD player. These inputs support 480i, 480p, 720p, 1080i, and 1080p video formats.

These inputs can also accept DVI video inputs. To connect a DVI input, use an HDMI-to-DVI adapter or cable plus analog audio cables. Connect the analog audio cables to the **HDMI/DVI AUDIO** inputs on the TV to receive left and right stereo audio from your DVI device.

These inputs are HDCP (High-Bandwidth Digital Copy Protection) compliant.

These inputs are  certified for proper interoperability with other products certified by Simplay™.

6. HDMI/DVI AUDIO

Use these analog audio inputs when connecting DVI video devices to the TV's **HDMI** jacks. Unlike HDMI, DVI does not carry audio information on the same cable. **For analog audio from a personal computer, use the PC-DVI AUDIO jacks instead.**

7. PC-DVI

PC-DVI is a DVI-I input compatible with both DVI-A (analog) and DVI-D (digital) inputs. Connect your personal computer's HDMI, DVI, or VGA video output to this jack. An adapter or converter cable may be required. Please see Appendix B for signal compatibility. To hear audio from the computer, connect analog audio cables from the computer to the **PC-DVI AUDIO** jacks.

8. PC-DVI AUDIO

Use the **PC-DVI AUDIO** jacks in conjunction with the **PC-DVI** video input from a personal computer. These jacks allow you to send left and right analog audio from your computer to the TV.

9. IEEE 1394/DTV LINK™

These jacks allow the TV to connect to external IEEE 1394 digital products by means of a single cable. See chapter 6, "NetCommand Operations" for detailed information regarding IEEE 1394 connections and recording.

10. MONITOR OUT

Use these composite video and left/right audio jacks to send analog video and audio signals to an external recording device such as a VCR. **To make recordings from this output, the TV must be in normal full-screen mode rather than in Split Screen mode.**

- You can watch another device while recording, but not another channel.
- From this output you can record audio and video signals from **ANT 1, ANT 2, INPUT 1-3**, and IEEE 1394 devices.
- Digital signals from **ANT 1, ANT 2**, and IEEE 1394 devices are converted to analog video and audio signals.
- Some signals cannot be recorded because of copy-protection flags in the content.

11. AUDIO OUT LEFT/RIGHT

AUDIO OUT LEFT/RIGHT jacks send analog audio of the program currently shown on the screen to an A/V surround sound receiver or stereo system. Digital audio from digital channels, FireWire® (IEEE 1394/DTVLink) devices and HDMI devices is converted to analog audio by the TV. If using an analog A/V receiver or stereo system, this is the only audio connection needed between it and the TV.

12. DIGITAL AUDIO OUT

This output sends Dolby Digital or PCM digital audio to your digital A/V surround sound receiver. Analog audio from analog channels and devices is converted by the TV to PCM digital audio. If you have a digital A/V receiver, in most cases this is the only audio connection needed between the TV and your A/V receiver.

13. IR Emitter NetCommand®

IR Emitters connected to this jack are used by the TV's NetCommand system to control external IR remote controlled analog devices such as cable boxes, VCRs, DVDs, satellite receivers and audio receivers. This system also coordinates with the TV Guide On Screen® system to control cable boxes and to activate the record feature of your VCR.

CableCARD™ Technology

CableCARD is a nationwide system standard that allows your local cable TV provider to supply you with an access card customized to your account. This card allows your TV to receive, decode, and unscramble the premium digital channels included in your cable TV subscription without the use of a cable box. When you move to a new cable provider's area, return the CableCARD to the original cable provider and get a new card from your new provider.

Please note that CableCARD is a relatively new technology and your local cable provider may not currently be offering this service. As time passes, this system will become broadly supported by most cable providers.

The CableCARD system is unidirectional, meaning your cable provider can send updates to the TV, but the TV cannot send signals back. As a result, certain advanced and interactive digital cable services, such as requests for video-on-demand and pay-per-view programs, a cable operator's enhanced program guide, and data-enhanced television services may require use of a set-top box instead. For more information, call your local cable operator.

Digital cable channels authorized by the CableCARD are available on the Firewire® IEEE 1394 network and can be shared by other products on the network. You may be unable to record or copy some digital programs, however, because of copy restrictions set by the content or copyright owners.

Using a CableCARD™

Power on the TV and insert the CableCARD into the CableCARD slot with the top of the card oriented as indicated by **CARD TOP ▲**. When the initial screen displays, write down the information that appears and have it ready when calling your cable provider.

In order to start cable service for this device, please contact your cable provider
1-800-xxx-xxxx
CableCARD(tm): xxx-xxx-xxx-xxx-xxx-x
Host: xxx-xxx-xxx-xxx-x
Data: xxx-xxx-xxx-xx
UnitAddress: xx-xxxxx-xxxxx-xxx
Press EXIT to exit.

Sample CableCARD initial screen. Record the information before contacting your cable provider.

To review the information later, press **MENU** and when the Main menu appears, press **9 9 9** to re-display the screen.

Note: CableCARD™ requires the TV's **Fast Power On** setting. If you insert a CableCARD™, the TV will automatically override a **Low Power** setting and change to the **Fast Power On** setting.

CableCARD™ Menu

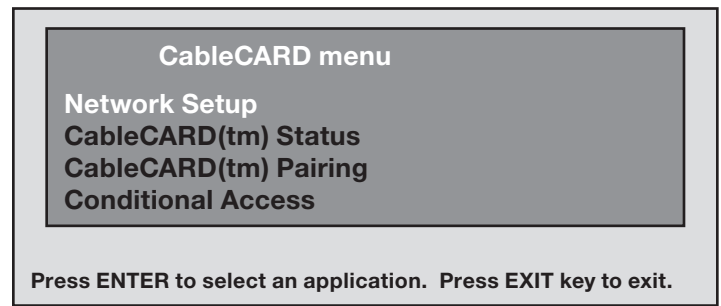

Sample CableCARD menu

To display the CableCARD menu with links to applications from your cable provider:

1. While watching CableCARD, press **INPUT** to open the Input Selection menu.
2. With the CableCARD icon highlighted, press **MENU** to open the CableCARD menu.
3. Press **▲ ▼** to highlight a link (blue text), then press **ENTER** to access the linked page.
4. To redisplay the CableCARD menu, repeat steps 1 and 2.
5. Press **EXIT** to return to TV viewing.

If there are technical problems with the CableCARD, an error screen automatically displays with information that may be needed by your cable provider when you call them for assistance.

Moving Through Other CableCARD Screens

In addition to CableCARD menus, other CableCARD application screens may display and require you to make additional selections. When using these screens on your Mitsubishi television:

- Blue text denotes a link to another screen. Press **ENTER** to move to the next application. Screens without blue text contain no links.
- You cannot move backward through the links. To exit the CableCARD system, press **EXIT**. The **CANCEL** key may not work with some CableCARD screens.

All information on these application screens is provided by your local cable company. Contact your cable provider if you have any problems with the application screen displays.

IMPORTANT

Most CableCARD screens show only status or diagnostic information and do not allow you to make changes. These screens are meaningful only to your local cable provider.

IMPORTANT

To use a CableCARD, connect the primary incoming cable to ANT 1/MAIN on the TV.







TV Connections

Connection Types	20
Digital Video and Home Recording	21
HDTV Cable Box or Satellite Receiver with Component Video	21
Standard Cable Box, Satellite Receiver, or Other Device with S-Video	22
Wall Outlet Cable (no cable box).	22
Antenna with a Single Lead	23
Antennas with Separate UHF and VHF Leads.	23
VCR to an Antenna or Wall Outlet Cable	24
VCR to a Cable Box (Audio & Video)	25
HDMI Device (Cable Box, Satellite Receiver, DVD Player, or Other Device)	26
DVI Video Device (Cable Box, Satellite Receiver, DVD Player, or Other Device)	26
DVD Player with Component Video	27
A/V Receiver (Sound System)	27
Older Cable Box	28
Camcorder.	28
IEEE 1394 Devices	29
IR Emitter NetCommand® and TV Guide On Screen.	31
Helpful Hints for NetCommand Connections	32

Connection Types

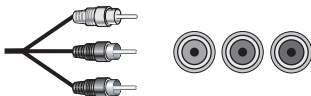
Video and Combined Audio/Video Connections



These descriptions apply to TV video only and do not cover signals from personal computers.

Picture Quality (most sources)	Name	Signal Type	Figures (not to scale)	Additional Information
Best (carry high-definition video when available)	HDMI	Digital audio and video		Carries digital audio and uncompressed digital video on a single one-way cable.
	DVI	Digital video		Carries uncompressed digital video alone on a single one-way cable; requires separate audio connections.
	Component Video	Analog video		Y Pb Pr RCA-style connectors are colored green, blue, and red. Carries analog high-definition and standard-definition signals.
Good	S-Video	Analog video		Carries analog standard-definition signals. Provides better quality video than composite or RF coaxial video.
Fair	Composite Video	Analog video		RCA-style connector, usually colored yellow. Carries analog standard-definition signals.
Fair to Best (depending on source; carry all qualities of signals)	IEEE 1394 (FireWire®)	Digital audio and video		Carries compressed digital video and audio as well as device control signals on a single two-way cable.
	RF Coaxial Video	Analog and digital audio and video		Carries audio and video on a single cable.

Note: Only some TV signals are high-definition signals. To view high-definition programming from your cable or satellite provider, you must subscribe to the provider's high-definition service. Some over-the-air broadcasts are in high-definition and can be received with a high-quality antenna suited to your location.

Audio Connections

There are two types of audio connections used on this TV. Refer to the table below.

Audio Connection	Figures (not to scale)	Additional Information
Left/Right Analog Stereo Audio		RCA-style connectors usually colored white for left and red for right stereo audio. For monaural sound (all speakers playing the same sound), use only the white connector.
Digital Audio (Coaxial)		RCA-style connector usually colored orange. Use to send digital audio from the TV to your digital A/V receiver for surround-sound effects. Usually the only audio connection required between the TV and the A/V receiver.

Digital Video and Home Recording

The table below will help you decide which type of connection to use for digital video. Digital video comes to your home in a compressed state, whether received on recorded media (e.g., disc) or broadcast over the air, over cable, or via satellite. Some compressed digital video is available for recording as noted in the table.

Connection Type into the TV	Effect on Home Recording
HDMI or DVI Compressed video is converted to uncompressed form by an external device such as a cable box, satellite receiver, or DVD player before it is sent to the TV on an HDMI or DVI cable.	You cannot record the resultant uncompressed video sent to the TV via HDMI or DVI.
IEEE 1394 (FireWire®) Connections Your TV can receive and decode digital channels, MPEG2 compressed digital video, and Dolby Digital audio.	You can record compressed digital video either <ul style="list-style-type: none"> on compatible digital recorders as digital signals using IEEE 1394 connections converted to analog signals and recorded as standard-definition composite video from the MONITOR OUT jack You may be unable to record some programming because of copy restrictions added by the content owners.

HDTV Cable Box or Satellite Receiver with Component Video

If your cable box or satellite receiver has HDMI or DVI outputs, use the connections for HDMI or DVI video devices described later in this chapter.

Required: RCA component video cables, left/right analog audio cables.

A coaxial splitter, available at most electronic supply stores, may be required to complete this installation.

1. Connect the cable from the outside cable or satellite service to **CABLE IN** or **SATELLITE IN** on the cable box or satellite receiver. See your device's owner's guide for instructions and cable compatibility.
2. Connect RCA-type cables from the Y Pb Pr outputs on the HDTV cable box or satellite receiver to **COMPONENT** on the TV back panel, matching the colored connections.
3. Connect left (white) and right (red) audio cables from the HDTV cable box or satellite receiver to **COMPONENT /AUDIO LEFT** and **AUDIO RIGHT** on the TV back panel.
4. Optional: To allow use of the Split Screen feature with channels from **ANT 1** and the cable box or satellite receiver, connect the incoming terrestrial antenna or cable service (not satellite) to **ANT 1/MAIN** on the TV back panel. A coaxial splitter, available at most electronics supply stores, may be required to complete this installation.

Note: To receive the benefits of digital surround sound, connect the digital audio output from your cable box or satellite receiver directly to your digital A/V receiver.

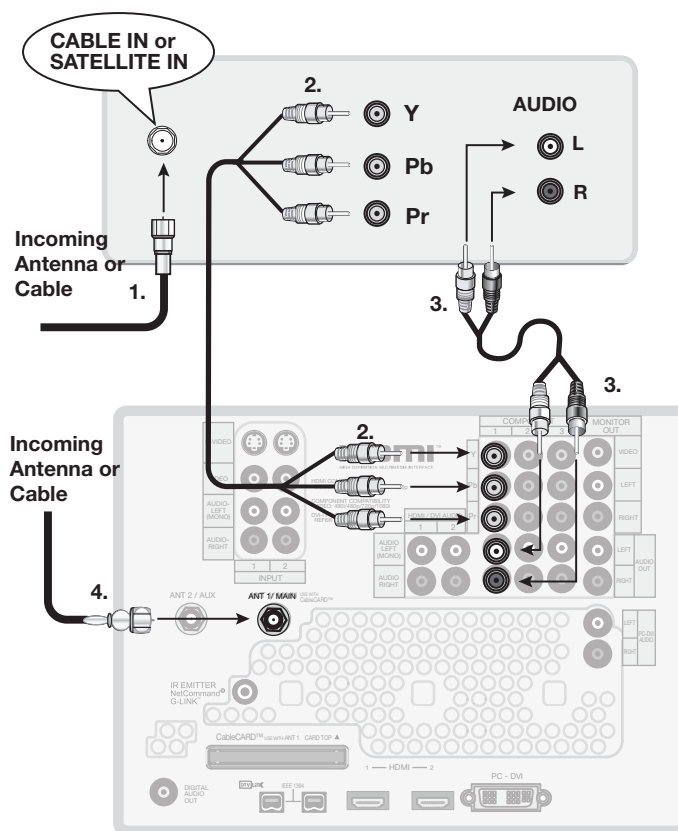

Figure 1. Connecting an external HDTV receiver with component video connections

Standard Cable Box, Satellite Receiver, or Other Device with S-Video

Required: S-Video cable and left/right analog stereo audio cables.

1. Connect the cable from the outside cable or satellite service to **CABLE IN** or **SATELLITE IN** on the cable box or satellite receiver.
2. Connect an S-Video cable from **VIDEO OUT** on the cable box or satellite receiver back panel to **INPUT S-VIDEO** on the TV back panel.
3. Connect left (white) and right (red) audio cables from **AUDIO OUT** on the cable box or satellite receiver to **INPUT/AUDIO LEFT** and **AUDIO RIGHT** on the TV back panel.

Note: Refer to the cable box or satellite receiver Owner's Guide for cable or dish antenna connections to the receiver.

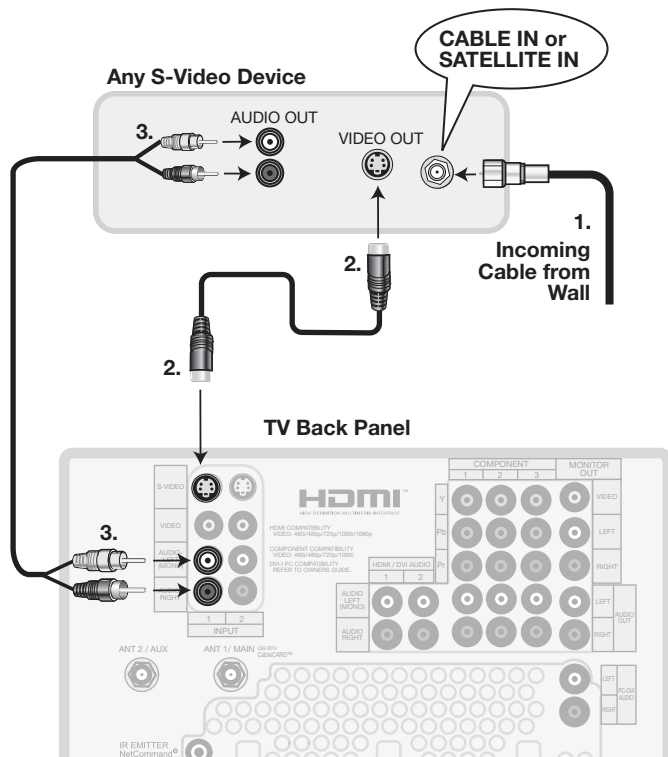

Figure 2. Connecting a device with S-Video

Wall Outlet Cable (no cable box)

(can be used with a CableCARD™)

It is very important to connect the incoming cable for your primary viewing source to **ANT 1/MAIN**, especially for CableCARD™ use.

1. Connect the primary incoming coaxial lead cable to **ANT 1/MAIN** on the TV back panel.
2. For an optional secondary antenna source, connect an antenna (or cable) to **ANT 2/AUX**.
3. If you have subscribed to a CableCARD™ service, Insert the CableCARD into the CableCARD slot. The top of the card must face in the direction indicated by the **CARD TOP** arrow.

See chapter 1, "Television Overview," for additional CableCARD information. Detailed TV Guide On Screen information is in the separate User's Manual.

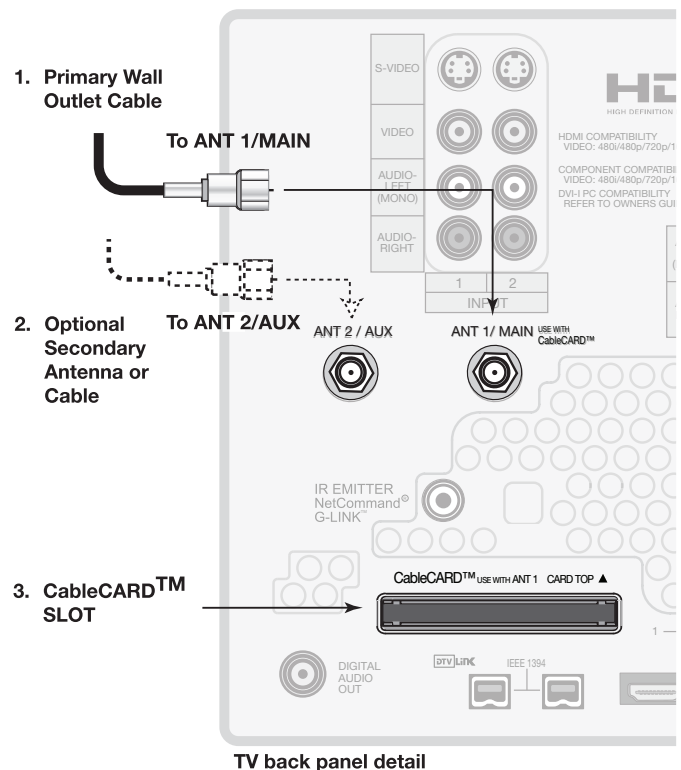

Figure 3. Wall Outlet Cable

Antenna with a Single Lead

A. For an antenna with flat twin leads

A 300-ohm-to-75-ohm transformer is required. This is not included with the TV, but is available at most electronics stores.

- A1. For an antenna with flat twin leads, connect the 300-ohm twin leads to the 300-ohm-to-75-ohm transformer.
- A2. Push the 75-ohm side of the transformer onto **ANT 1** on the TV back panel.

B. For cable or antenna with coaxial lead

Connect the coaxial lead directly to **ANT 1** on the TV back panel.

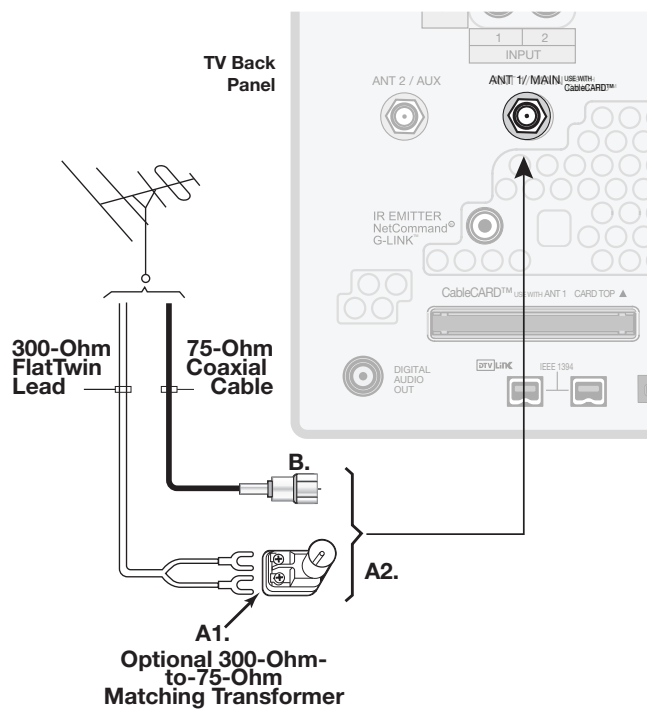

Figure 4. Connecting a Single Antenna

Antennas with Separate UHF and VHF Leads

Required: UHF/VHF combiner

This is not included with the TV, but is available at most electronics stores.

1. Connect the UHF and VHF antenna leads to the UHF/VHF combiner.
2. Push the combiner onto **ANT 1/MAIN** on the TV back panel.

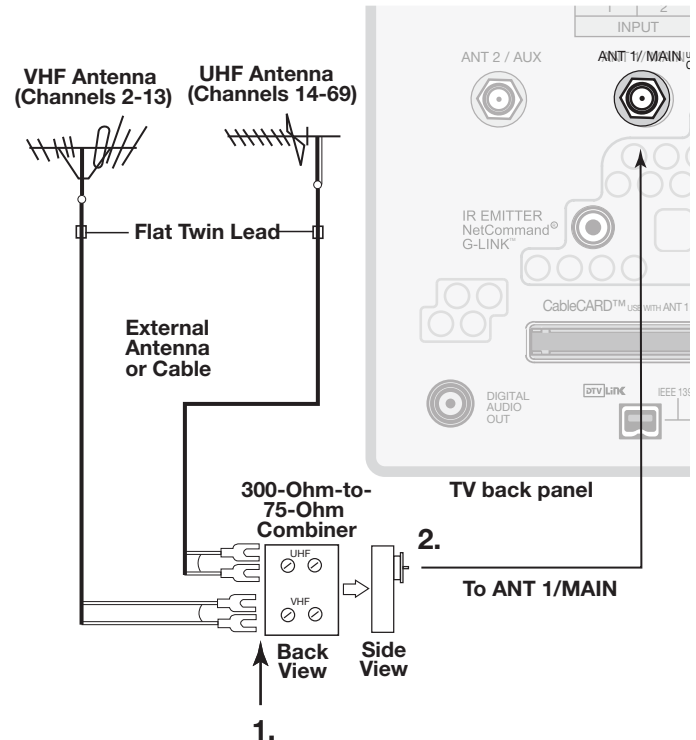

Figure 5. Connecting separate UHF and VHF Antennas

Mitsubishi strongly recommends you avoid using antennas with flat twin leads. Flat twin lead antenna wires are subject to interference which may adversely affect the performance of the TV. We recommend using coaxial antenna cable.

VCR to an Antenna or Wall Outlet Cable

Required: Two-way RF splitter, 3 coaxial cables, right and left analog audio cables, either S-video or video cable. These are not included with the TV but are available at most electronics stores.

1. Connect the incoming cable or antenna to **IN** on the RF splitter.
2. Connect one coaxial cable from **OUT** on the RF splitter to **ANTENNA IN** on the VCR back panel.
3. Connect one coaxial cable from **OUT** on the RF splitter to **ANT 1/MAIN** on the TV back panel. This connection also allows you to use the TV Guide On Screen® and Split Screen features.
4. To use the TV speakers with the VCR, connect left (white) and right (red) audio cables from **AUDIO OUT** on the VCR to **INPUT/AUDIO LEFT** and **AUDIO RIGHT** on the TV back panel. If your VCR is mono (non-stereo), connect only the white (left) cable.

5. Connect either an S-Video or composite video cable from **VIDEO OUT** on the VCR back panel to **INPUT/VIDEO** or **S-VIDEO** on the TV back panel. Connect only one type of video cable; S-Video is recommended, if available.

Optional

To use the TV Guide On Screen recording feature and to record high-definition digital channels converted to analog standard-definition video and analog stereo audio, perform these two additional steps.

6. Connect left (white) and right (red) audio cables from **AUDIO IN** on the VCR to **MONITOR OUT LEFT/RIGHT** on the TV back panel. If your VCR is mono (non-stereo), connect only the white (left) cable.
7. Connect a composite video cable from **VIDEO IN** on the VCR back panel to **MONITOR OUT/VIDEO** on the TV back panel.

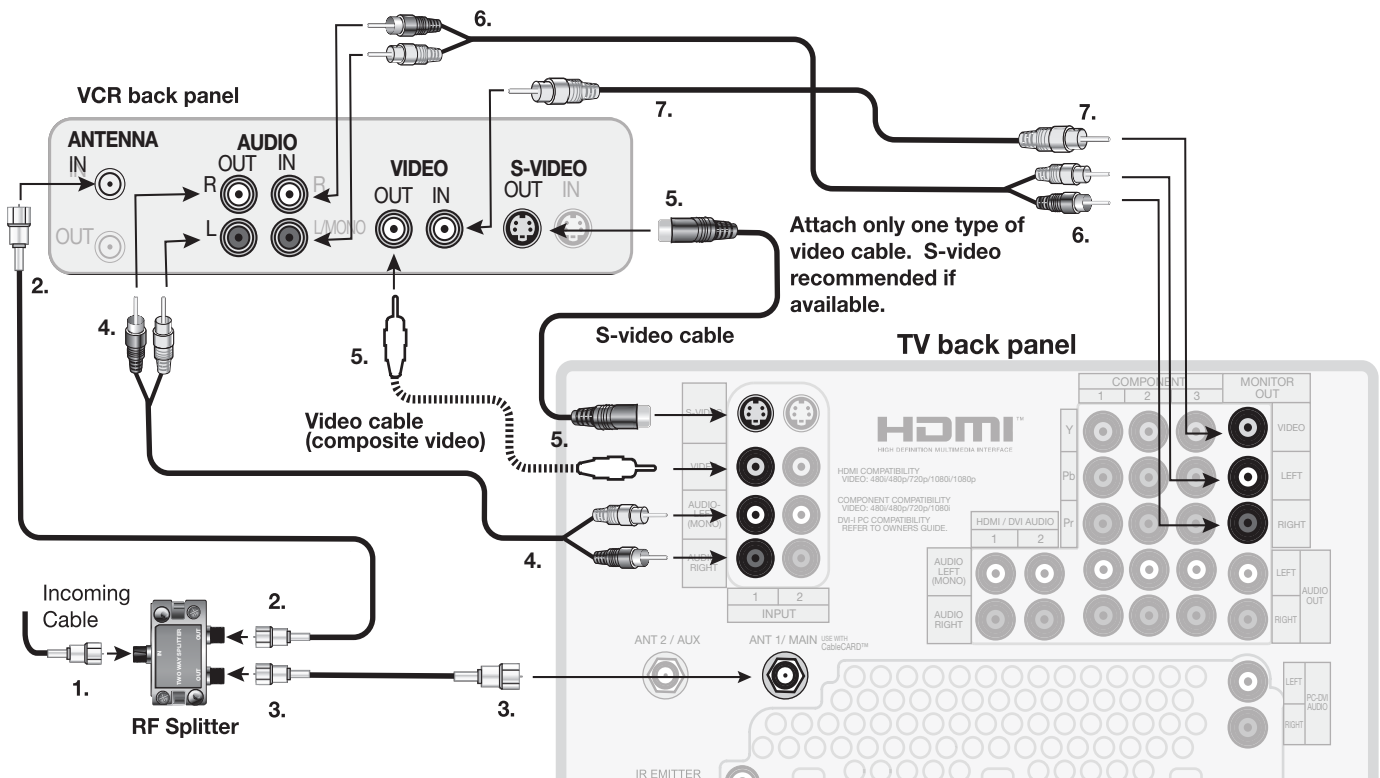

Figure 6. Connecting a VCR to an Antenna or Wall Outlet Cable

VCR to a Cable Box (Audio & Video)

Required: Two-way RF splitter, 4 coaxial cables, right and left audio cables, S-Video or composite video cable, plus component or S-Video cables and audio cables required to connect the TV to the cable box.

1. Connect the incoming cable to **IN** on the RF splitter.
2. Connect one coaxial cable from **OUT** on the RF splitter to **CABLE IN** on the cable box.
3. Connect one coaxial cable from **OUT** on the RF splitter to **ANT 1/MAIN** on the TV back panel. This connection also allows you to use the TV Guide On Screen® and Split Screen features.
4. Connect one coaxial cable from **OUT** on the cable box to **ANTENNA IN** on the VCR back panel.
5. Connect the cable box outputs to the TV as shown in one of the options listed below. This connection allows the TV to receive the best available signal directly from the cable box.

Figure 1: Component video output to the TV's **COMPONENT Y Pb Pr** jacks; analog stereo audio to the associated **AUDIO** jacks.

OR

Figure 2: S-Video output to the TV's **INPUT/S-VIDEO** jack; analog stereo audio to the associated **AUDIO** jacks.

6. To use the TV speakers with the VCR, connect left (white) and right (red) audio cables from **AUDIO OUT** on the VCR back panel to **INPUT/AUDIO LEFT** and **AUDIO RIGHT** on the TV back panel. If your VCR is mono (non-stereo), connect only the white (left) cable.
7. Connect either an S-Video or composite video cable from **VIDEO OUT** on the VCR back panel to **INPUT/VIDEO** or **INPUT/S-VIDEO** on the TV back panel. Connect only one type of video cable. S-Video is recommended, if available.

Optional

8. To allow recording from the TV to the VCR:
 - a. Connect left (white) and right (red) audio cables from **AUDIO IN** on the VCR back panel to **MONITOR OUT/LEFT** and **RIGHT** on the TV back panel.
 - b. Connect a video cable from **VIDEO IN** on the VCR back panel to **MONITOR OUT/VIDEO** on the TV back panel.

Note: When using this connection configuration with the connections used in step 5, it is possible to view live cable programs through the VCR Device. For best picture quality always view live cable programs directly from the cable box device.

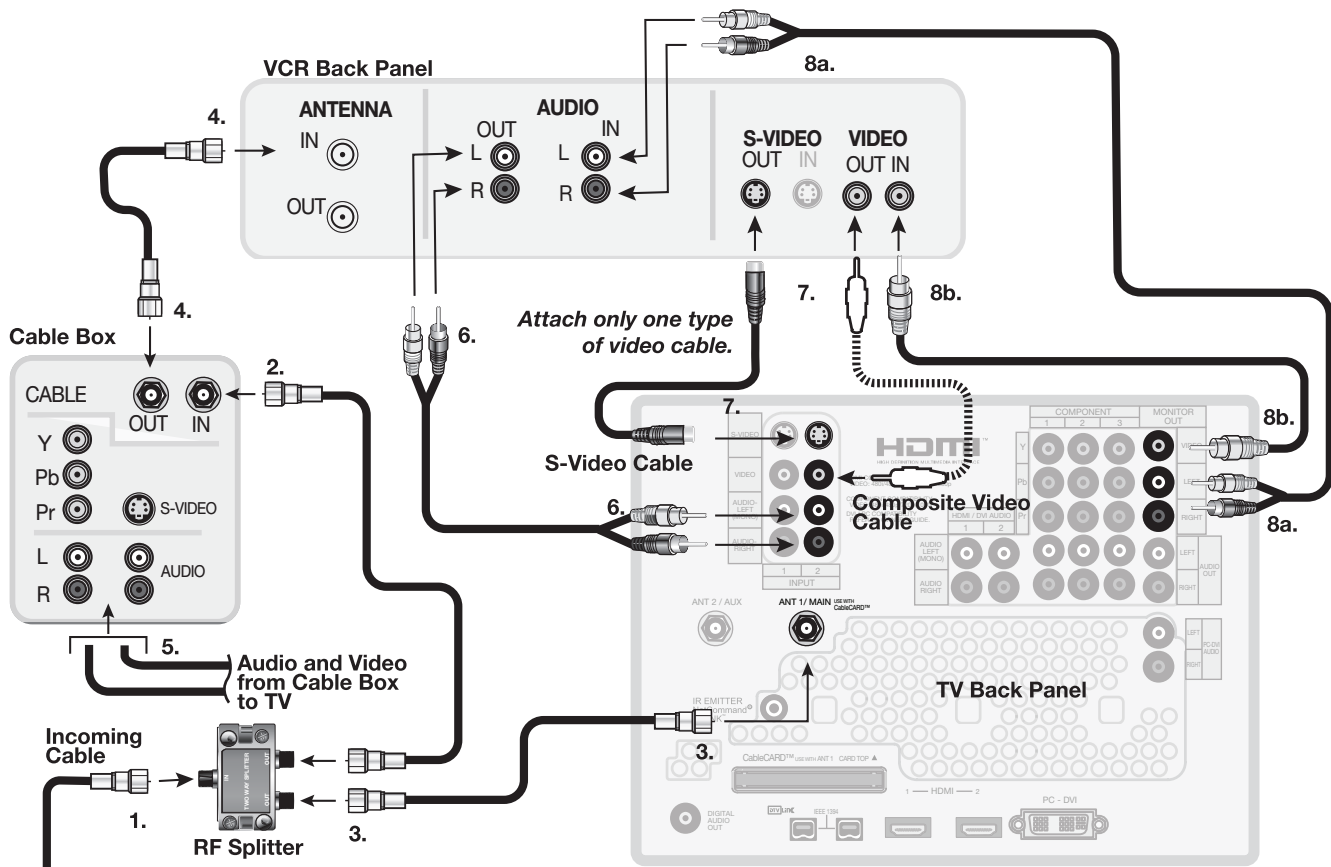

Figure 7. Connecting a VCR to a cable box

HDMI Device (Cable Box, Satellite Receiver, DVD Player, or Other Device)

Required: HDMI-to-HDMI cable. This is not included with the TV.

Connect an HDMI cable from the TV back panel to the HDMI device output. HDMI devices provide video and audio through this cable, so no other connection is required. There are two HDMI inputs on the TV back panel.

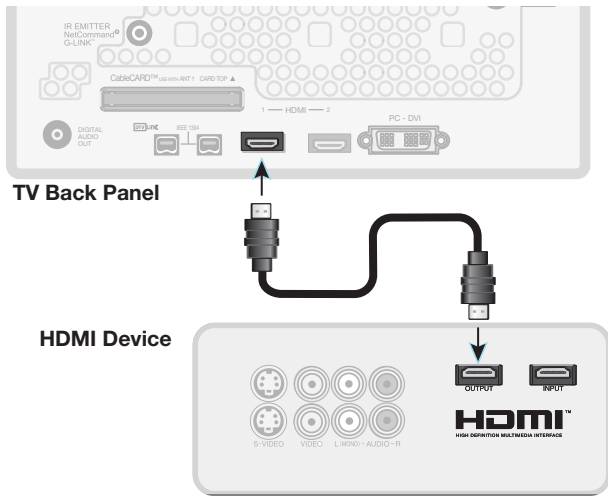

Figure 8. Connecting an HDMI device.

DVI Video Device (Cable Box, Satellite Receiver, DVD Player, or Other Device)

Analog stereo audio cables and a DVI-to-HDMI cable or DVI/HDMI adapter and HDMI cable are required. These are not included with the TV. They may be available at your local electronics retailer.

1. Connect the DVI-to-HDMI cable (recommended) or HDMI cable with DVI/HDMI adapter from the DVI device's back panel to the TV back panel.

NOTE: If you are using a DVI/HDMI adapter, it is important to connect the adapter to the DVI device for best performance.

2. Connect a set of audio cables from **AUDIO OUT** on the DVI device back panel to the **HDMI/DVI AUDIO** on the TV back panel. Connect the red cable to the **RIGHT** jack and the white cable to the **LEFT** jack.

NOTE: The HDMI connection supports copy protection (HDCP).

Some devices require connecting to an analog input first, in order to view on-screen menus and to select DVI as the output. Please review your equipment instructions for DVI connectivity and compatibility.

Note: HDMI inputs are *SimplayHD* certified for proper interoperability with other products certified by Simplay™.

IMPORTANT

For sound from your devices, note that the HDMI inputs can receive digital stereo audio signals only. To use digital surround sound for an HDMI or DVI device, connect that device's digital audio output directly to your A/V receiver. See the Owner's Guides for those devices for instructions.

IMPORTANT

To connect a personal computer to the TV, see chapter 7, "Using the TV with a Personal Computer."

The HDMI input processes signals as standard motion video and is not designed to process computer resolutions.

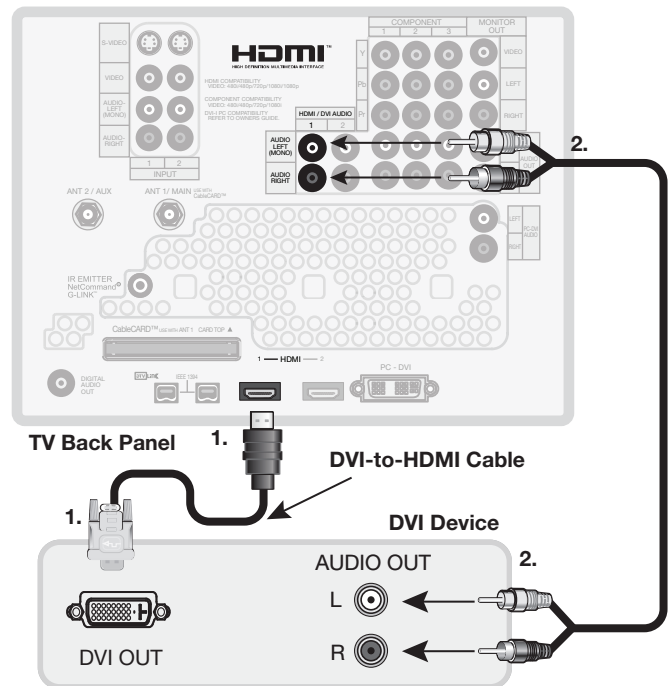

Figure 9. Connecting a DVI device

DVD Player with Component Video

Component video cables and analog audio cables are required. These are not included with the TV.

1. Connect the component video cables from **Y PB PR VIDEO OUT** on the back of the DVD player to the **COMPONENT** jacks on the TV back panel, matching the red, green, and blue colored connections.
2. Connect left (white) and right (red) stereo audio cables from **AUDIO OUT** on the back of the DVD player to **COMPONENT/AUDIO LEFT** and **RIGHT** on the TV back panel.

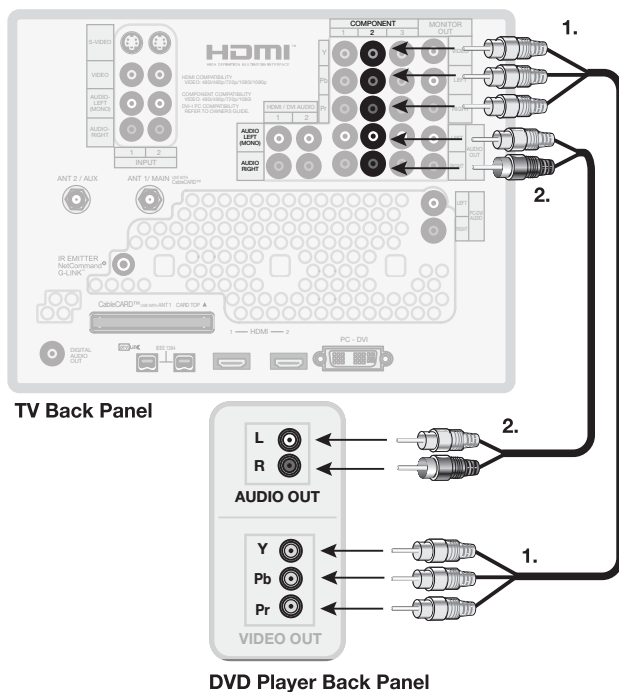

Figure 10. Connecting a DVD player with component video

A/V Receiver (Sound System)

Most setups require either a digital audio cable or analog stereo audio cables.

The TV makes all audio available in digital and analog formats. Analog audio coming into the TV is available in digital format on the **DIGITAL AUDIO OUT** jack. Digital incoming audio is available in analog format on the **AUDIO OUT LEFT/RIGHT** jacks. Usually, only one of the following connections is required:

- **To connect an analog A/V receiver**
Connect left (white) and right (red) audio cables from **AUDIO OUT/LEFT** and **RIGHT** on the TV back panel to the **TV AUDIO INPUT** on the A/V receiver.
- **To connect a digital A/V receiver with Dolby Digital surround sound and PCM audio support**
Connect one end of the digital audio cable to **DIGITAL AUDIO OUT** on the back of the TV. Connect the other end to the **COAXIAL DIGITAL INPUT** on the back of the A/V receiver.

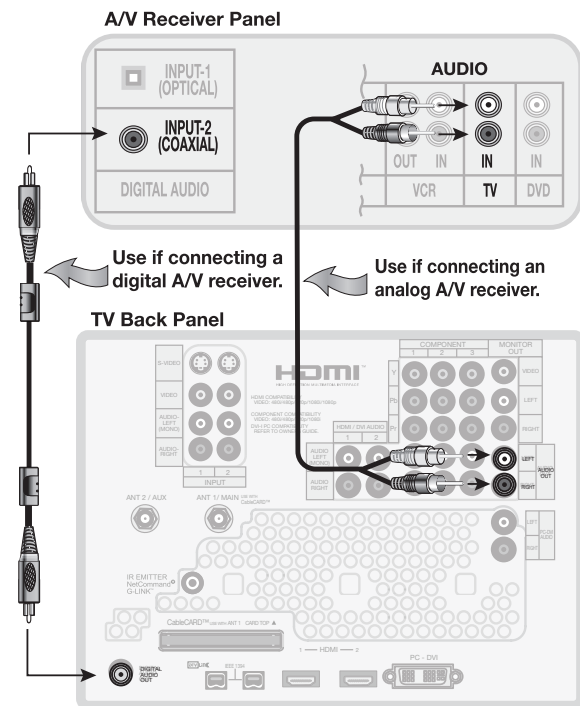

Figure 11. Connecting audio from the TV to an A/V receiver

Note:

- On rare occasions, an HDMI signal may be copy-restricted and cannot be output from the TV as a digital signal. To hear these copy-protected signals through the A/V receiver, use connections for analog A/V receivers.
- Check the A/V receiver's Owner's Guide for information concerning use of the digital input and switching between digital sound and analog stereo sound from the TV.

IMPORTANT

See Appendix B for component video signal compatibility information.

For digital audio connections to your A/V receiver, see your DVD player and A/V receiver Owner's Guides.

Older Cable Box

Required: 3 coaxial cables, one two-way RF splitter. These are not included with the TV.

When this setup is complete, you can use the TV remote control, when programmed, to change channels on the cable box.

Note: This connection is not recommended. The other connections described in this chapter provide better quality audio and video to the TV.

1. Connect the incoming cable to **IN** on the RF splitter.
2. Connect one coaxial cable from **OUT** on the RF splitter to **ANT 1/MAIN** on the TV back panel.
3. Connect one coaxial cable from **OUT** on the RF splitter to **IN** on the standard cable box.
4. Connect one coaxial cable from **OUT** on the cable box to **ANT 2/AUX** on the TV back panel.

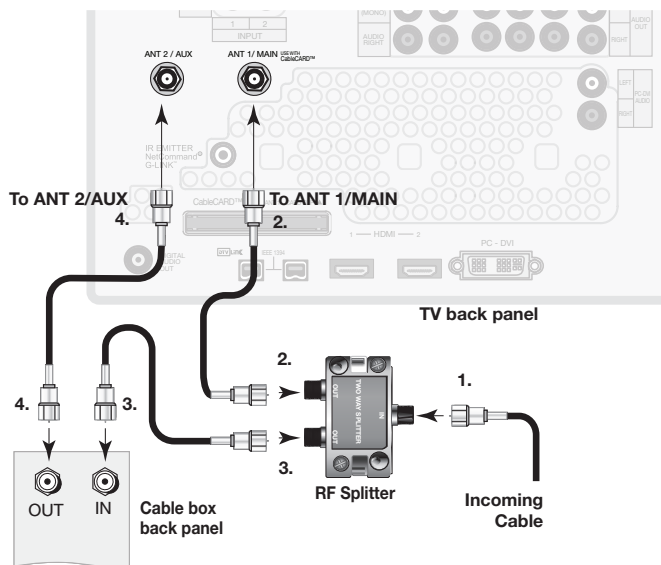

Figure 12. Connecting an older cable box

Camcorder

Required: Analog stereo audio cables and either an S-Video or composite video cable.

NOTE: For IEEE 1394 camcorders, see also later in this chapter under “IEEE 1394 Devices.”

1. Connect either an S-Video or composite video cable from **VIDEO OUT** on the camcorder to **INPUT 3/VIDEO** or **S-VIDEO** on the TV. Connect only one type of video cable; S-Video is recommended, if available.
2. Connect left (white) and right (red) audio cables from **AUDIO OUT** on the camcorder to **INPUT 3/AUDIO L** and **AUDIO R** on the TV.

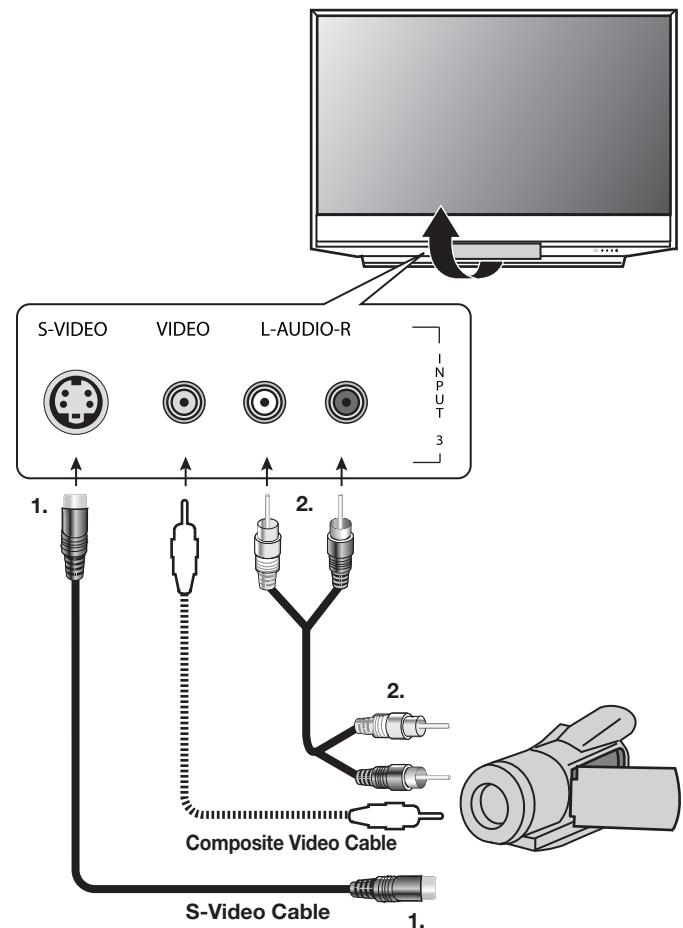

Figure 13. Analog connections for a camcorder

IEEE 1394 Devices

Compatible IEEE 1394 Devices

Compatible A/V devices include some, but not all, cable boxes, D-VHS VCRs, A/V discs, and future products. Some devices may have IEEE 1394 connectors but are not compatible with the TV. Areas of compatibility to consider are:

1. Digital Video Signals

The TV can decode MPEG2 video as provided by cable boxes and some camcorders. Many camcorders provide DV video, which the TV cannot decode. Connect a DV camcorder to the TV using analog audio plus composite video, S-video, or component video, or use HDMI audio/video. Other types of digital video, such as PC video provided by some computers, must be decoded by the source device and sent to the TV as analog video, S-video, or DVI/HDMI video.

2. Digital Audio Signals

When received with video signals, the TV can decode Dolby Digital signals and MPEG audio signals. Other types of digital audio as provided by some digital recording devices, such as MP3 audio and DTS audio, cannot be decoded by the TV when received over IEEE 1394 connections.

The TV may not be able to pass incompatible digital audio signals on the coaxial digital audio output. These signals may pass to other devices, however, on the IEEE 1394 cable.

3. Digital Control Signal

The TV can serve as the control center for IEEE 1394 audio/video devices, such as VCRs, A/V Discs, tuners, cable boxes, and amplifiers that are compatible with the following IEEE 1394 control standards.

- **EIA-775.** Designed for tuning devices such as cable boxes, allowing the device to send simple graphics. This standard does not, however, allow the TV to control the cable box by IEEE 1394.
- **AV/C (Audio Video Control).** Designed to provide basic controls such as play, stop, channel selection, and volume, as appropriate for the device.

Four-Pin and 6-Pin Connections

There are two different types of connectors used for IEEE 1394 terminals and cables: a 4-pin and a 6-pin type. Both types send the same digital audio, video, and control signals, but the 6-pin connectors can also supply low-voltage electrical power to connected devices. This TV uses only 4-pin type connectors.

A 6-pin connector cannot be connected directly to a 4-pin jack, and vice versa. To connect a 6-pin device to a 4-pin device, use a 6-pin-to-4-pin adapter or adapter cable. These cables are available from electronics and computer stores.



4-pin connector 6-pin connector 6-pin-to-4-pin adapter

If you wish to connect a 6-pin device to the TV (such as a camcorder), and the device is designed to receive electrical power from another 6-pin device, there are several ways to provide electrical power to the device:

- Connect the camcorder directly to the household AC.
- Use the camcorder's battery for power.
- Connect the camcorder directly to another 6-pin device in the network that can provide power.

Connection Methods

There are two connection methods for IEEE 1394 devices. Use the method that fits your network of audio/video products.

Direct Device-To-Device Method

The IEEE 1394 interface allows you to chain devices, unlike audio and video connections that require you to connect each individual device directly to the TV. For example, you can connect your D-VHS to your 1394 A/V disc and then connect the 1394 A/V disc to the TV. The resulting IEEE 1394 chain allows you to add more devices to the chain. You will see an icon for each device in the TV's Input Selection menu and can also send information from any IEEE 1394 device to other compatible devices.

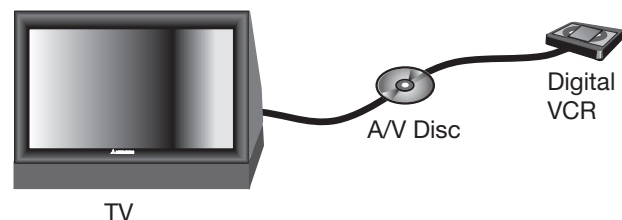

Hub Connection Method

The IEEE 1394 standard allows you to use the TV as a hub within the audio/video network. Each device can send information, which may include audio and video, to any other device in the network.

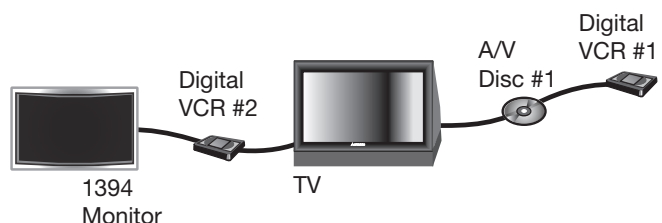

IEEE 1394 Devices, continued

Tips for Connecting IEEE 1394 Devices

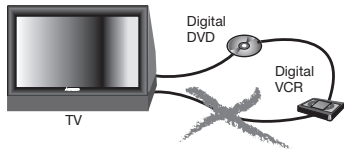
- Do not loop the last device in the chain back to the TV. When the device chain is looped, the TV may not be able to work with the other devices. 
- Place devices that have only a mechanical (two-position) power switch at the end of the chain or leave the power switch in the on position. When turned off, IEEE 1394 signals may not be able to pass through the device to other devices.
- Place devices with the slowest communication speed at the end of the chain. Sometimes the communication speed is marked near the IEEE 1394 connector with an “S” number. The higher the number, the faster the communication speed. This TV has a communication speed of s400. Devices with slow communication speeds can interfere with IEEE 1394 signals from faster devices. When setting up a digital recording between a faster device and a slower device, make the slower device the source and make the faster device the recorder.
- Use IEEE 1394 cables 15 feet or less in length between devices.
- This TV is an IEEE 1394a device. It can be used with an IEEE 1394b system when an IEEE-1394a-to-1394b convertor is used. 1394b systems are capable of greater distances and multi-room applications.
- The TV can recognize a maximum of seven IEEE 1394 devices at any one time.

IEEE 1394 Camcorders

- **Control Functions.** Connect the camcorder to the TV’s IEEE 1394 jack on the rear of the TV and test using the TV’s remote control to operate the camcorder. If your model does not operate properly, use the camcorder’s control buttons instead.
- **MPEG Camcorder.** If you are unable to play back over the IEEE 1394 interface, use the analog audio/video connections described in chapter 2, “TV Connections.”
- **DV Camcorder.** Connect the camcorder using the analog audio and video connections described in chapter 2, “TV Connections.”

TV Back Panel

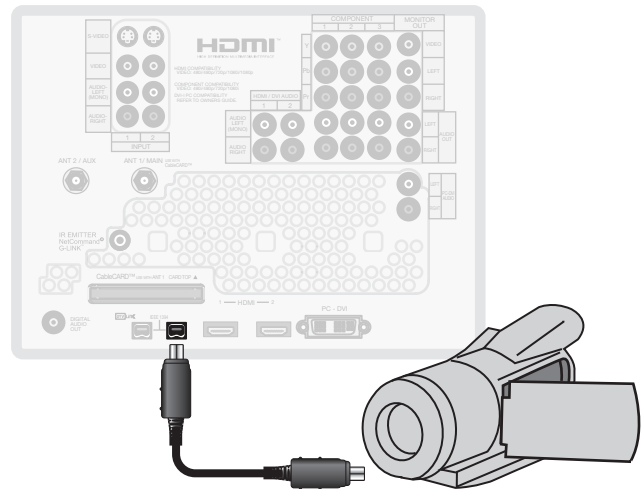

You can connect an IEEE 1394 camcorder with an IEEE 1394 cable or with analog audio/video cables. In either case, test using the TV’s remote control to operate the camcorder over the IEEE 1394 cable.

IR Emitter NetCommand® and TV Guide On Screen

An IR emitter cable is included with the TV.

The NetCommand system uses emitters connected to the **IR EMITTER** jack to control other devices such as VCRs, DVD players, cable boxes, and satellite receivers. This control system is shared with the TV Guide On Screen system.

1. Connect the plug end of the supplied IR emitter cable to the **IR EMITTER NetCommand®** jack on the TV back panel.
2. Run the cable for each of the emitter ends under, alongside, or over each device to be controlled so that the emitter end is in front of the area where the remote control sensor is located.
3. Position the emitter end with the emitter bulb facing the remote control sensor. The bulb emits infrared light in a cone-shaped pattern. Place the bulb far enough from the sensor to allow the cone pattern to reach the sensor.

The IR sensor is usually behind the plastic window of the front display panel. It is sometimes visible with the aid of a flashlight and is normally a round or square cutout behind the plastic. If you cannot see the sensor and the device's Owner's Guide does not specify the location, you can find it by following these steps using the device's remote control:

- a. Hold the remote about one-half inch from the front of the device. Starting from one end of the display window plastic, press the **POWER** button.
- b. If the device does not respond, move the remote control one inch toward the center and try again.
- c. Repeat this until the device responds.
- d. Note this location and then start over from the other end of the display window plastic, repeating until the device responds again.

The remote control sensor is somewhere between these two positions. This is usually enough accuracy for placement of the IR emitters.

With some devices, the emitter works better facing downward from the top of the device. Experiment if needed.

4. Secure the emitter ends in place using double-sided tape.

5. Place any unused ends behind the devices to prevent stray signals from reaching the IR sensors.

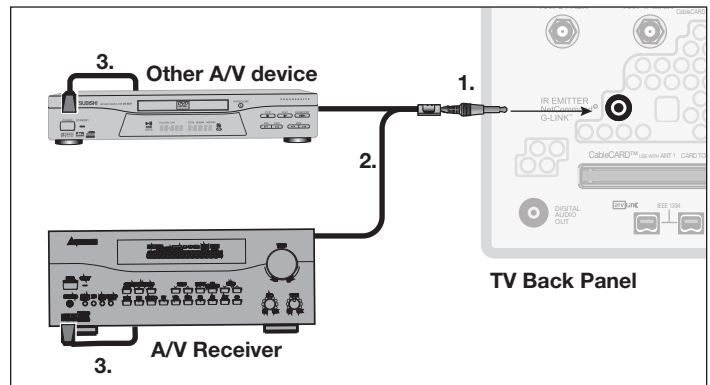

Figure 14. Connecting IR Emitter NetCommand

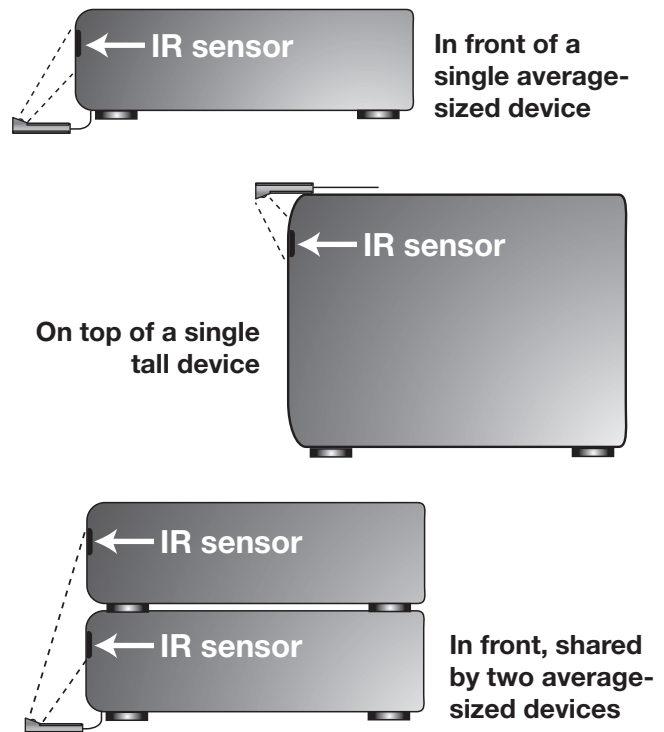

Figure 15. IR emitters so the signal can be "seen" by the IR sensor on each device.

IMPORTANT

Position IR emitters so that each device's sensor "sees" the signal from only one emitter. Otherwise, a device receiving signals from multiple sources (remote controls, IR emitters) may not respond at all.

Helpful Hints for NetCommand Connections

Q. My VCR (or other device) does not have two sets of stereo audio outputs. How can I connect this device's audio to both the TV and the A/V Receiver?

- A.** You need to connect the device to the TV and then make changes to the A/V receiver setup.
1. Connect the VCR's audio and video to the TV; connect the single set of stereo audio outputs to the TV only.
 2. Perform the procedure for setting up a device connection. See chapter 3, "TV Setup," and the section entitled "When You First Connect a Device." NetCommand IR Learning is optional.
 2. Press **INPUT** to display the Input Selection menu, highlight the VCR's icon, and press **ENTER** to select the VCR.
 3. Press **MENU** to open the Main menu, highlight the NetCommand icon, and press **ENTER**.
 4. Under **AV RECEIVER SETUP**, confirm that the text box displays **None**.
 5. Press **EXIT**.

After performing these steps, the TV will automatically pass the audio signal to the A/V receiver.

Q. I have both the TV stereo audio output and TV digital audio output connected to the same input designations on my A/V Receiver. How do I switch between analog audio and digital audio?

- A.** In most setups, analog audio is also output as digital audio, so no switching is required, and there is no need to connect the analog output. In some circumstances, however, you may also need analog audio from the TV. For example, MP3 audio is only output in analog format, so you must connect the TV's analog AUDIO OUTPUT to the A/V Receiver if you want to hear MP3 audio through the A/V receiver. Refer to your A/V Receiver user's guide to find out how analog/digital audio switching works.

Q. The front panel of my A/V Receiver is too tall or too convex for the IR emitter signal to reach the remote control sensor of the A/V Receiver. What can I do?

- A.** There are several possible solutions.
- Mount the IR Emitter on the top, front edge of the A/V Receiver over the remote control sensor. Use tape to secure it in place.
 - Mount the IR Emitter on the underside of the shelf above the A/V Receiver (if the A/V Receiver is in a cabinet). Use double sided tape to secure it in place.
 - Some small stick-on emitters from other manufacturers may be compatible with this TV's IR Emitter jacks. These may be used instead of the supplied IR Emitters.

Q. I occasionally need to see the menu from my A/V Receiver. How can I connect it to the TV for this purpose?

- A.** Connect the A/V Receiver's video output to an unused input on the TV and then use the A/V receiver's remote control to display the menu.
1. Connect the video output of the A/V Receiver to an unused input on the TV; Input 3 on the front panel is the most convenient. The Auto Input Sensing screen will displays when the TV detects the new connection,
 2. Press **EXIT** to close the screen without naming the input.
 3. Select **INPUT 3** (or other input you used) from the Input Selection menu: press **INPUT**, highlight the Input 3 icon, and press **ENTER**.
 4. Press the **MENU** key on the A/V receiver's remote control to open the A/V receiver's menu.
 5. When finished, disconnect the A/V receiver's video input from the TV.

Q. I have a high definition receiver I would like to connect and it also has an S-video output I would like to be able use as well. Is there any way to connect this receiver both ways?

- A.** Yes, this item will appear twice in the Input Selection Menu. Just add this unit once using the **COMPONENT** or **HDMI** input and once using one of the **S-VIDEO** inputs. Mitsubishi suggests that you connect stereo audio outputs with the S-video input only.

TV Setup

Guidelines for Setting Up and Using Your New Widescreen TV . . .	34
When You First Power On the TV	36
Using the TV's Setup Menu	36
When You First Connect a Device.	39
Initial NetCommand® Setup	42
Additional Setup Using the NetCommand Menu.	43

Guidelines for Setting Up and Using Your New Widescreen TV

Getting Started

1. Read the section entitled “**Important Information About Your TV**” starting on page 6.
2. Choose a location for your TV.
 - Allow at least four inches of space on all sides of the TV to help prevent overheating.
 - Avoid locations where light may reflect off the screen.
 - See the stand requirements under “**Important Information About Your TV.**”
3. Install the batteries in the remote control. See **chapter 4, “TV Operation and Features,”** for information on use of the remote control.
4. Plug your TV into a power outlet. The **POWER** indicator on the front of the TV will start blinking rapidly. After the **POWER** indicator stops blinking, press the **POWER** key to power on the TV.
5. When the Welcome screen appears the first time you power on the TV, select a language for TV menus. You can later change the language through the **Setup menu.**
6. Some TVs are shipped from the factory with demo mode active for use in retail stores. If demo mode is active when you first turn on the TV:
 - a. Press **MENU**.
 - b. When the Main menu appears with **Setup** highlighted, press **ENTER**.
 - c. When the Setup menu opens, press **▶** to highlight the on-screen **Demo Mode Off** button.
 - d. Press **ENTER**.
7. Connect your A/V devices to the TV (see **chapter 2, “TV Connections”**) and perform initial setup as described in **chapter 3, “TV Setup.”** Chapter 3 also provides instructions for setting up NetCommand control of your home theater and for enabling the TV Guide On Screen® system.
8. You can now start watching TV or you can perform additional setup and customization through the TV menus.

TV Operation

1. Review **chapter 4, “TV Operation and Features,”** for TV features including:
 - **Input Selection (viewing source).** Select a connected program source to watch, such as a VCR, DVD player, or antenna. Press **INPUT** on the remote control to select from icons for the TV inputs. See “**Input Selection Menu.**”
 - **Picture Formats.** Press **FORMAT** to cycle through picture sizes and shapes to find the one best suited to the program you’re watching. See “**TV Signals and Display Formats.**”
2. To use the TV to control recordings through NetCommand, see **chapter 6, “NetCommand Operations.”** To use the TV Guide On Screen system

to control recording, see the separate *TV Guide On Screen® Interactive Program Guide User’s Manual.*

3. To understand use of the Input Selection menu with NetCommand-controlled devices, see **chapter 6, “NetCommand Operations.”**
4. If you have IEEE 1394 A/V devices, see **chapter 6, “NetCommand Operations,”** for details on operating such devices.

Additional TV Setup

1. Review **chapter 5, “TV Menu Settings,”** to customize TV operation. Press the **MENU** key to enter the menu system. Some examples of settings you may wish to change include:
 - **Input Name.** Change the device names that appear in the Input Selection menu. See “**Input Name Menu.**”
 - **Icon Order.** Rearrange the device icons in the Input Selection menu to put frequently used icons near the front. See “**Icon Order Menu.**”
 - **FAV.** Create lists of your favorite channels so you can find them quickly. See “**Channel Menu.**”
 - **Parental Lock.** You can restrict TV viewing by program rating or by time of day. You can also disable the front-panel buttons—useful if you have small children. See “**Parental Lock Menu.**”
 - **Video Settings.** Change the video adjustments to get the best picture for your viewing conditions. See “**Audio/Video Menu.**”

You may wish to change the Picture Mode from the default **Brilliant** to either **Bright** or **Natural**, which are suitable for most home viewing environments.
2. To program the remote control to operate A/V devices not under NetCommand control, see **Appendix D, “Programming the Remote Control.”**

TV Care

- **Lamp Cartridge.** When the lamp cartridge needs replacement, **replace the lamp yourself and save the cost of a service call.** See **Appendix C** for instructions.
- **General Cleaning.** To keep your TV looking its best, see the cleaning recommendations under “**Important Information About Your TV.**”

Assistance

- For troubleshooting, service, and product support, see **Appendix E.**
- For warranty information, see the TV warranty in the back of this book.

Installing the Remote Control Batteries

1. Remove the remote control's back cover by gently pressing in the tab and lifting off the cover.
2. Load the batteries, making sure the polarities (+) and (-) are correct. For best results, insert the negative (-) end first.
3. Snap the cover back in place.

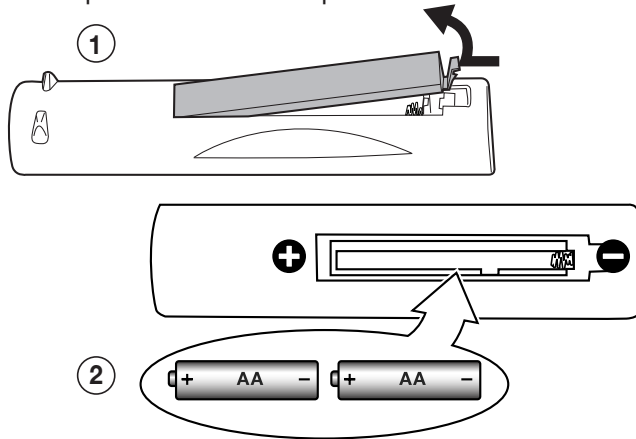

The remote control requires two AA alkaline batteries.

Care of the Remote Control

- Use only alkaline batteries.
- Be within 20 feet of the equipment.
- Do not press two or more buttons at the same time unless instructed to do so.
- Do not allow unit to get wet or become heated.
- Avoid dropping on hard surfaces.
- Do not use harsh chemicals to clean. Use only a soft, lightly moistened cloth.
- Do not mix old and new batteries.
- Do not heat, take apart, or throw batteries into fire.

TV Tips

Turning the TV On or Off

To turn the TV on or off, point the remote control at the front of the TV and press the **POWER** button. Alternatively, press the **POWER** button on the front panel of the TV.

If You Turn Off the TV by Mistake

1. Press **POWER** again within about 30 seconds, while the lamp is still hot, to have the TV come back on immediately.
2. If the **LAMP** indicator starts blinking (about 30 seconds after you shut off power), **wait about one minute for the LAMP indicator to stop blinking and press POWER to turn the TV on again.**

Controlling Sound Volume

Press **VOL** \wedge/\vee to adjust the sound level.

Changing Channels

To change channels:

- Enter the channel number using the number keys on the remote control and press **ENTER**. For a two-part digital channel, such as 3-1, press 3 **CANCEL** 1 to enter a dash (separator).
- Press **CH** \wedge/\vee to change channels one channel at a time.
- Press and hold **CH** \wedge/\vee to move quickly through channels.
- Press **QV** (QuickView) to switch back to the previously tuned channel.
- Use the **FAV** (Favorites) feature to set up lists of favorite channels and tune to them with the **FAV** key. See "Channel Menu" in chapter 5.

NOTE: Memorize channels to make finding channels easier.

When You First Power On the TV

Choosing a Language for Menus

When you power on the TV for the first time, you can select either English or Spanish for all menus. You can later change the language through the Setup menu.

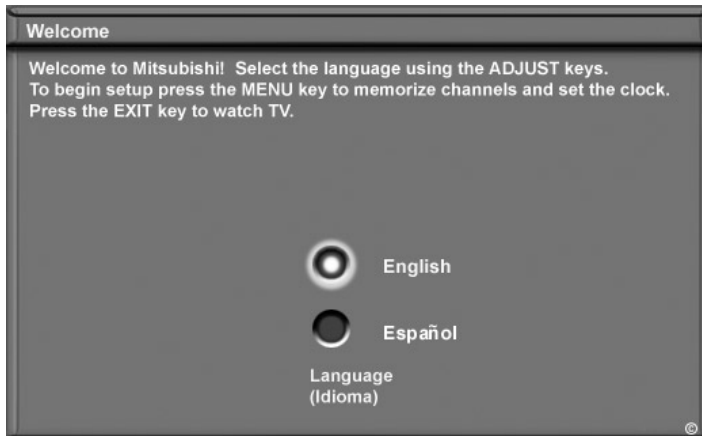

Figure 1. The Welcome screen lets you change the menu language when you first power on the TV.

TV Guide On Screen Setup Reminder

If you do not set up the TV Guide On Screen system when you first turn on the TV, a reminder screen will appear the next six times you turn on the TV (see figure 2). To set up the TV Guide On Screen system, see “Additional Setup with the NetCommand Menu” later in this chapter.

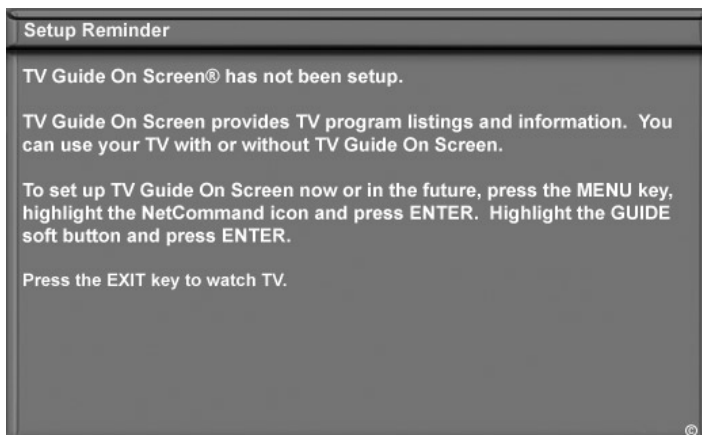

Figure 2. TV Guide On Screen setup reminder

Using the TV's Setup Menu

Use the Setup menu for basic TV setup options. To display the Setup menu, press **MENU** to open the Main menu. With the **Setup** icon highlighted, press **ENTER**.



Figure 3. Open the Setup menu from the Main menu.

Language (Setup Menu)

Choose to display on-screen menus in either English or Spanish (Español).

To listen to audio in other languages (when available), see chapter 5, “TV Menu Settings, and the “Audio Settings” section. Then refer to either “SAP” (analog signal) or “Language” (digital signal).

Memorize Channels (Setup Menu)

For ANT 1/MAIN and ANT 2/AUX

The memorization process performs two scans of all possible channels on the selected **ANT** input. Analog channels are scanned first, then the process is repeated for digital channels. Channel memorization may take up to 15 minutes to complete.

To start channel memorization

1. Highlight an input selection based on your connections:

Input	Condition
Ant 1 Air, Ant 2 Air	When connected to an indoor/outdoor antenna
Ant 1 Cable, Ant 2 Cable	When connected to direct cable (no cable box)

2. Press **ENTER** to start automatic channel memorization.

To stop channel memorization before completion

Press **CANCEL**.

Channels memorized before you pressed **CANCEL** are retained in memory. If you restart memorization, all previously memorized channels for the selected antenna input are erased and the process restarts.

After channel memorization, press **CH** \wedge/\vee to tune to memorized channels. Select the Channel menu for further channel editing, such as adding and deleting channels from memory, naming channels, and saving favorite channels in custom memory banks.

Setup Menu, continued

Note:

- If using a CableCARD™, the complete list of available channels is provided through the CableCARD and the **ANT 1** option is grayed out.
- In the TV Guide On Screen® system, the channels displayed and the order in which they are displayed are independent of the TV's channel memorization. Refer to the *TV Guide On Screen Interactive Program Guide User's Manual* for detailed instructions on editing channels shown in this guide.

Clock (Setup Menu)

Set the clock if you wish to use the TV's Timer function or schedule NetCommand-controlled recordings. You can use either the manual or auto method to set the clock.



Figure 4. Clock submenu

Setting the Clock Manually

Time

With the hour highlighted in yellow characters, press **▲▼** repeatedly to slowly increment the hour and associated **AM/PM** indicator or press and hold to quickly increment the hour. Press **ENTER** to highlight the minutes in yellow. Press **▲▼** to set the minutes. Press **▶** to move to the **Date** box.

Date

With the month highlighted in yellow characters, press **▲▼** to select the correct month. Press **ENTER** to highlight the day. Press **▲▼** to select the correct day. Press **ENTER** to highlight the year. Press **▲▼** to select the current year. Press **▶** to move to the **Time Zone** box.

Time Zone

Select your correct time zone. Press **▲** or **▼** to select the time zone for your area (**Atlantic, Eastern, Central, Mountain, Pacific, Alaska** or **Hawaii**). Press **▶** to move to the **Daylight Savings** box.

Daylight Savings

Press **▲** or **▼** to select either **Applies** or **Ignore**, depending on whether or not daylight savings time is used in your area.

Note: If **Clock Setting** is set to **Manual**, each time the time change occurs, you must open this menu and set the TV's clock ahead or back.

If you have selected **Auto** for **Clock Setting**, the TV's clock adjusts automatically to daylight savings time.

Setting the Clock Automatically

Select the **Time Zone** and the **Daylight Savings (DST)** options for your state. Press **▲▼** to select **Applies** or **Ignore**. You may then tune to a channel on **ANT 1** or **ANT 2** that uses Extended Data Service (XDS) time data, typically a PBS channel. With **Auto** selected, the TV automatically retrieves the correct time and date information from this channel.

Be aware that if a channel displays incorrect time information, it is because of information sent from the broadcaster and is not a defect of the TV.

Note: You may find that some channels send the incorrect time and the TV clock is reset every time you tune to those channels. To prevent unwanted clock resets, first use the **Auto** method to set the clock from a channel sending the correct time, then change the method to **Manual**.

Timer (Setup Menu)



Figure 5. Timer submenu

The Timer feature allows you to set a day and time for the TV to turn on automatically and the device and channel to display when it switches on. If the TV is already on at the requested time, the TV automatically tunes to the channel you designated in the Timer menu.

When the Timer turns on the TV, the screen displays the message "Press a button for the TV to stay on." Press any button on the remote control within five minutes if you wish the TV to remain on.

Note: The TV clock must be set before you can use the Timer feature.

On/Off

Press **▲▼** to enable or disable the Timer. Press **▶** to move to the **Day** box.

Setup Menu, continued

Set Day

Select the day or days that the TV will turn on automatically. Press ▲ or ▼ to select **Daily, Mon-Fri** (Monday through Friday), or individual days of the week. Press ► to move to the **Time** box.

Set Time

With the hour highlighted in yellow characters, press ▲ ▼ repeatedly to slowly increment the hour and associated **AM/PM** indicator or press and hold to quickly increment the hour. Press ENTER to highlight the minutes. Press ▲ ▼ to set the minutes. Press ► to move to the **Device** box.

Device

Press ▲ or ▼ to select the device to use when the Timer turns on the TV. If the TV is already on at the selected time, the Timer will switch the TV to this device. Press ► to move to the **Channel** box.

Channel

When the selected device is an antenna, you can select a channel for the TV to tune to when it comes on. Highlight the **Channel** box and

- press CH ^/▼ or ▲ ▼ to choose from memorized channels.
- Enter a channel number from the remote control. You can also enter sub-channel numbers for digital channels by using the **-/CANCEL** key.

Note: The **POWER/TIMER** indicator flashes green when the TV is off to indicate the TV Timer has been set.

Energy Mode (Setup Menu)

The Energy Mode option lets you select the TV's level of power consumption while the TV is turned off. Choose

either **Low Power** or **Fast Power On**. The **Low Power** setting uses less energy, but TV power-on takes longer. The default is **Fast Power On**. Keep this setting at **Fast Power On** if you:

- Expect to use the TV Timer function to turn on the TV at a preselected time.
- Need the TV Clock to remain accurate for the TV Timer and for scheduling NetCommand-controlled recordings. With the **Low Power** setting, you must reset the TV Clock if the TV is left turned off for over 48 hours.
- Wish to receive updates to the TV Guide On Screen program listings.
- Need faster power on.
- Wish to turn off the TV while making a NetCommand-controlled recording.
- Wish to schedule future NetCommand-controlled recordings for a time when the TV will be off.

Note: CableCARD™ and TV Guide On Screen® require the **Fast Power On** setting. If you insert a CableCARD™ or activate TV Guide On Screen, the TV will automatically override a **Low Power** setting and change to the **Fast Power On** setting.

Demo Mode Off (Setup Menu)

If Demo Mode is active, highlight the **Demo Mode Off** button and press ENTER.

Software Version (Setup Menu)

For servicing purposes, the TV's software version is displayed at the upper right side of the Setup menu.

When You First Connect a Device

During the initial set-up process for a device, the TV will:

- detect the connected device
- prompt you to identify the device by name
- prompt you to perform NetCommand set-up for the device, if applicable
- repeat the above steps for any additional newly connected devices

ClearThought® Easy Connect Auto Input Sensing

This TV's ClearThought® auto input sensing feature detects most connections automatically. The first time you connect to a ClearThought input, you are prompted to select a name for the connected device. The table below defines connections the TV can detect.

Auto Detection Active	No Auto Detection
INPUT 1, 2, 3 video jacks	ANT 1/ANT 2
COMPONENT video jacks	MONITOR OUT (all jacks)
HDMI*	All AUDIO jacks
PC-DVI*	
IEEE 1394	

* If the device is powered off when connected, detection occurs when the device is next powered on.

- Connect your devices to the TV, making note of which TV input you have used for each device.

The TV and the devices can be either on or off when connecting. If the TV is powered off, the detection process will occur the next time you turn on the TV.

- For most devices, the Auto Input Sensing screen opens (see figure 6). With the text box highlighted, press **▲▼** to select a name for the device from the following list of names:

- ✓ **Cablebox**
- ✓ **Camcorder**
- ✓ **DVD**
- ✓ **DVD2**
- ✓ **DVR** (digital video recorder, recordable DVD)
- ✓ **Game**
- ✓ **HD Disc** (high-definition disc)
- ✓ **Satellite**
- ✓ **VCR**

The name you assign here will appear in the Input Selection menu and can be changed later through the Input Name menu.

If you select one of the device names checked in the table above, the on-screen **Learn** button will change from grayed out to full color, indicating that NetCommand “learning” is available for the device.

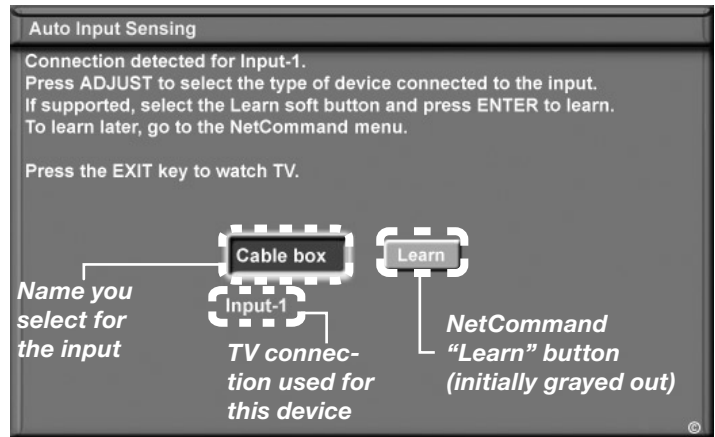

Figure 6. The Auto Input Sensing screen appears when a device is first detected. Select a name for the connected device in this screen.

- Now you can either:

- Highlight **Learn** and press **ENTER** to perform NetCommand “learning” for the device, if applicable (recommended). NetCommand “learning” can be used to control the device types checked in the preceding list. See “Initial NetCommand Setup” later in this chapter. You can perform NetCommand setup at a later time, if preferred, by using the **Learn** option in the NetCommand menu.
- Press **EXIT** to close the screen. The TV will display the Auto Input Sensing screen for the next connection it finds.

Note: To continue with NetCommand setup for the current device:

- You must have connected and properly placed NetCommand IR emitters (see chapter 2, “TV Connections”).
- You must have at hand the remote controls for the TV and the current device.

More About Auto Input Sensing

- Be careful to choose a different name for each input.
- You can change the input name at a later time using the Input Name menu.
- If you disconnect a device and then later connect a different device to the vacated jack, use the Input Name menu to update the device name. If you want the device under NetCommand control, you must perform NetCommand “learning” for the new device.
- Antenna inputs (**ANT 1/ANT 2**), audio connections, and TV outputs are never detected.

When You First Connect a Device, continued

IEEE 1394 Connections

The New 1394 Device screen appears if you connected an IEEE 1394 device. See figure 7. IEEE 1394 devices are automatically under NetCommand control. The TV can recognize up to seven IEEE 1394 devices at one time. If you connect more than one device of the same type, a unique identifier is added to the name for each one. For example, if you connect three A/V discs, you may see **AV Disc**, **AV Disc1**, **AV Disc2**.

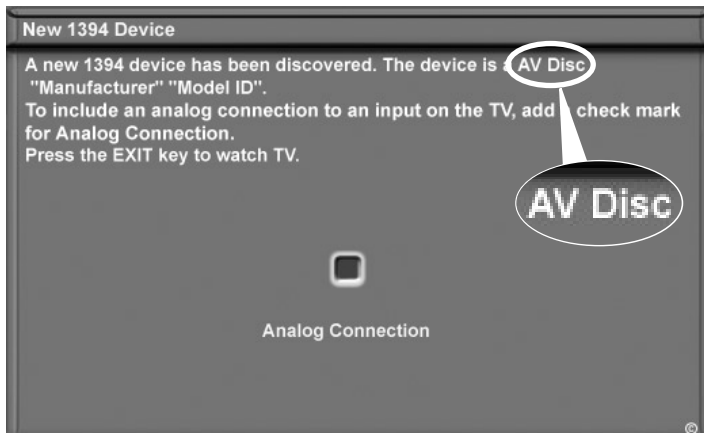

Figure 7. The New 1394 Device screen shows the device name and includes a check box for an associated analog connection.

IEEE 1394 Device with an Analog Connection

Some IEEE 1394 devices have both digital and analog outputs to the TV. If you have such a device, place a check mark in the **Analog Connection** check box to allow you to use the TV's Input Selection menu to select either the analog or digital output.

For instructions on switching between analog and digital outputs, see chapter 6, "NetCommand Operations."

If your IEEE 1394 device can be connected to the TV with an analog connection, follow the instructions below.

1. Connect the device to the TV **with an IEEE 1394 cable first**.
2. When the New 1394 Device screen appears with the **Analog Connection** check box highlighted, press **ENTER** to enter a check mark.
3. In the New 1394 Device screen, note the name assigned to the device, as you will need to use the same name in a later step. See figure 7, New 1394 Device screen.
4. Connect the device to the TV with the supplemental analog cable.
5. The next screen is the auto Input Sensing screen (see figure 6) in which you can select a name for the device. If you select the wrong name for the device, you will be unable to switch between the analog and digital inputs to the TV.

If the device is a cable box, select the name **CABLE** as the name for the analog input.

Note: If you connected the cables in reverse sequence (analog first), you will later need to change the input name in the Input Name menu.

- a. Switch to any viewing device other than the one you wish to change (press **INPUT** to open the Input Selection menu).
- b. Open the NetCommand menu and then open the Input Name menu.
- c. Highlight the text box for the analog input used for the IEEE 1394 device.
- d. Press **▲▼** to scroll through the available names to display the name you earlier noted for the IEEE 1394 device.
- e. Press **EXIT**.

NetCommand Specialized Device Keys

Refer to this chart when “learning” device keys. Write in functions you assign to the F1–F4 keys.

A/V Receiver	Cable, Sat, DVD ‡‡	VCR	Learning Screen Check Box Name	Function	Name on TV Remote
X	X	X	Power*	Power On or Power On/Off	POWER**
X	X	X	Power (Off)*	Power Off	POWER**
X			Volume Up	Volume Up	VOL ^
X			Volume Down	Volume Down	VOL v
X			Mute	Mute	MUTE
X			Input (1-4)	AVR Input Select	Automatic (when device is selected)
	X	X	Channel Up	Channel Scan Up	CH ^
	X	X	Channel Down	Channel Scan Down	CH v
	X	X	Recall	Last Channel Recall	QV
	X		Guide	Disc menu or top menu	GUIDE ‡‡‡
	X	X	Adjust Up, Down, Left, Right	Arrow move Up, Down, Left, Right	▲ ▼ ◀ ▶
	X	X	Enter	Enter/Select	ENTER
	X	X	Menu	Device Menu or Setup Menu	MENU **
	X	X	Cancel	Cancel or Exit	CANCEL
	X	X	Info	Status Information Display	INFO (press twice)
	X		Page Up	Guide Page Up	CH ^ ***
	X		Page Down	Guide Page Down	CH v ***
	X	X	Play	Play	▶ (PLAY)
	X	X	Stop	Stop	■ (STOP)
	X	X	Forward	Fast Forward/Fwd Search	▶▶ (FAST FORWARD)
	X	X	Rewind	Rewind/Reverse Search	◀◀ (REVERSE)
	X	X	Pause	Pause	⏸ (PAUSE)
	X	X	Record	Record	● (RECORD)
	X	X	Enter (digits)†	Enter for channel numbers	ENTER
	X	X	1,2,3,4,5,6,7,8,9,0	1,2,3,4,5,6,7,8,9,0	1, 2, 3, 4, 5, 6, 7, 8, 9, 0
		X	Input	Input Change	GUIDE**
		X	Sub-channel separator‡	Digital Sub channel	Ⓞ (-/CANCEL)
	X	X	F1	ASSIGN YOUR CHOICE OF SPECIALIZED FUNCTIONS	F1
	X	X	F2		F2
	X	X	F3		F3
	X	X	F4		F4

* These are paired functions (e.g. Power and Power Off). When the original remote control uses a single button for both functions, learn only the first of the paired functions.

** This function is performed only when the Input Selection Menu is displayed and the device icon is highlighted.

*** Channel Up/Down as Guide Page Up/Down in effect only after pressing GUIDE; returns to channel functions after pressing ENTER or CANCEL.

† If there are two ENTER keys, learn the ENTER key used for channel selection here. The ENTER button on the remote sends the correct IR code when digits are entered.

‡ Learn the sub-channel separator if a special key is used to add a separator (dash or dot) in a digital channel. Press the CANCEL button on the remote to add the separator

‡‡ DVD includes functions for DVD, DVD2, DVR, and HD disc.

‡‡‡ The GUIDE key is unavailable for a cable box guide when TV Guide On Screen is enabled.

Initial NetCommand® Setup

What You Need to Know About NetCommand

- NetCommand setup is optional.
- NetCommand operates by sending signals from the TV to your other devices via the IR emitters, telling the devices to play, record, change inputs, adjust volume, change channels and many more functions. All this is accomplished with the TV's remote control and the slide switch left in the TV position.
- The IR "Learning" feature of NetCommand allows the TV to learn the remote control signals for your A/V devices.
- NetCommand® can control IEEE 1394 devices by sending control signals over a FireWire® cable.
- You can choose the level of NetCommand control for your home theater.
 - **Limited Setup.** Perform a limited setup if you:
 - ◆ Want NetCommand to control only a few devices, such as the TV, a playback device (like a DVD player), and a cable box. With this setup, you can use the TV's remote control to operate these devices.
 - ◆ Want to use TV Guide On Screen® to control your cable box and VCR and/or A/V disc. After performing this setup, you can use the TV's remote control to operate these devices.
 - ◆ Want the ease and flexibility of NetCommand-controlled recording, with seamless setup of time-delayed or immediate recordings among networked devices.
 - **Full Setup.** Perform a full setup if you want to give NetCommand the following additional control:
 - ◆ Control a surround sound A/V receiver.
 - ◆ Automatically change input selections for the A/V receiver.

Initial NetCommand Setup for Most Device Types

- To set up an A/V receiver, see "Additional Setup Using the NetCommand Menu" later in this chapter.
 - For setup later, or to make changes to the setup, see "Additional Setup Using the NetCommand Menu" later in this chapter.
1. Connect and position the IR emitters as described in chapter 2, "TV Connections."
 2. Have the remote controls for the TV and the other device ready before beginning. Set the TV remote control's slide switch to the TV position.

3. In the Auto Input sensing screen (see figure 8), highlight the **Learn** button and press **ENTER** to open the Learn screen for the device (see figure 9).

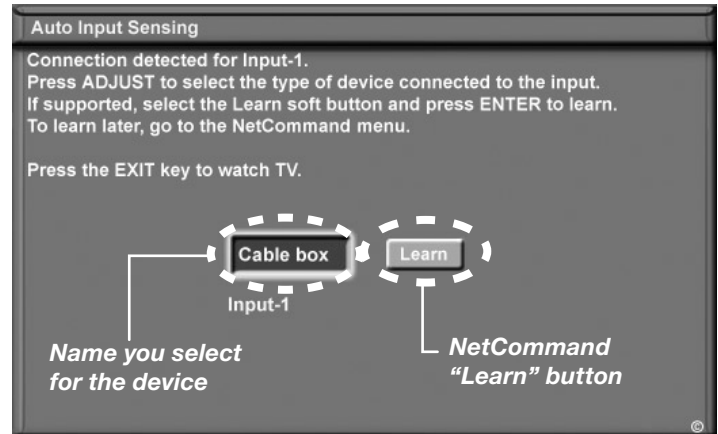

Figure 8. Highlight the Auto Input Sensing screen's Learn button and press ENTER to open the NetCommand Learn screen.

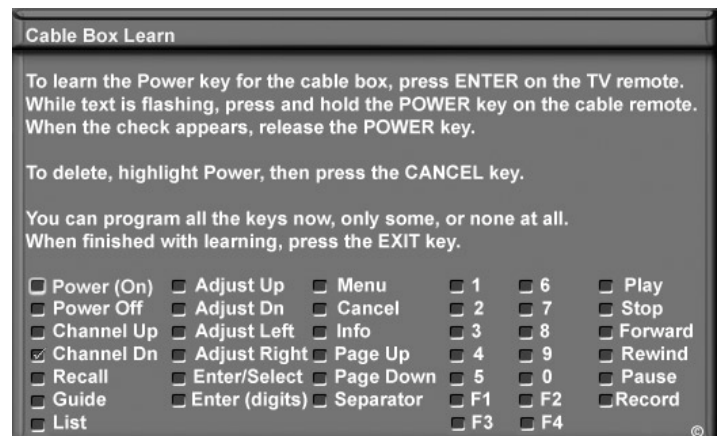

Figure 9. In the NetCommand Learn screen, you tell the TV to remember key commands to send to another device via an IR emitter.

4. The first function highlighted in the Learn screen is always **Power (On)**. Aim the TV's remote control at the TV and press **ENTER** to begin learning for that function.
 5. When the **Power (On)** text starts flashing, aim the device's remote control at the TV and press and hold the **POWER** key until a check mark appears in the box. If the text stops flashing before the check mark appears, repeat this step.
 6. If the device has a separate **POWER OFF** key, press ▼ to highlight the check box for **Power Off**. Repeat the preceding step to "learn" the **POWER OFF** key.
- If device has no POWER OFF key, skip this step.**

By completing "learning" for the power keys, the TV's remote control now operates the power function for the device when you set it as the current viewing device in the Input Selection menu. Point the remote control at the TV to control the device.

Initial NetCommand® Setup, continued

- Press the ▲▼◀▶ keys on the TV's remote control to highlight other keys on the list. Repeat steps 4 and 5 for each additional function you wish to control through NetCommand.
- If the device's remote control has keys that do not appear in the list, you can associate up to four keys with the F1 through F4 keys. For example, for a DVD player, assign the F1 and F2 keys to the DVD player's CHAPTER SKIP FORWARD and CHAPTER SKIP BACK keys. Perform NetCommand setup for the F keys the same as you did for the named keys.
- Press EXIT to continue with setup for additional devices.

Additional Setup Using the NetCommand Menu

Use the NetCommand menu at any time to:

- See a list of all connections to the TV.
- Set up TV Guide On Screen® or make changes to the setup.
- Add NetCommand control to a device. Use the **Learn** button to open the NetCommand Learn screen for the currently selected device.
- Add or remove specific device keys from NetCommand control.
- Add NetCommand control to an A/V receiver. When the A/V receiver is the audio source, audio from a device can be automatically switched to the A/V receiver when the device is selected in the TV's Input Selection menu.
- Assign meaningful names to the input icons in the Input Selection menu (see chapter 5, "TV Menu Settings").
- Change the order of icons in the Input Selection menu (see chapter 5, "TV Menu Settings").

To open the NetCommand menu, press **MENU** to first open the Main menu, highlight the **NetCommand** icon, and press **ENTER**. See figure 10.

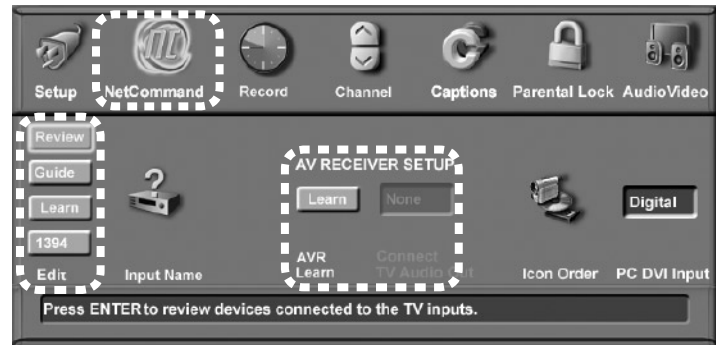

Figure 10. Additional NetCommand setup options are accessible through the NetCommand menu.

Review TV Connections

You can verify TV connections during TV setup or at any time afterward using the Review screen. In the NetCommand menu, press ▲▼◀▶ to highlight **Review** and press **ENTER** to display the Review screen (see figure 11).

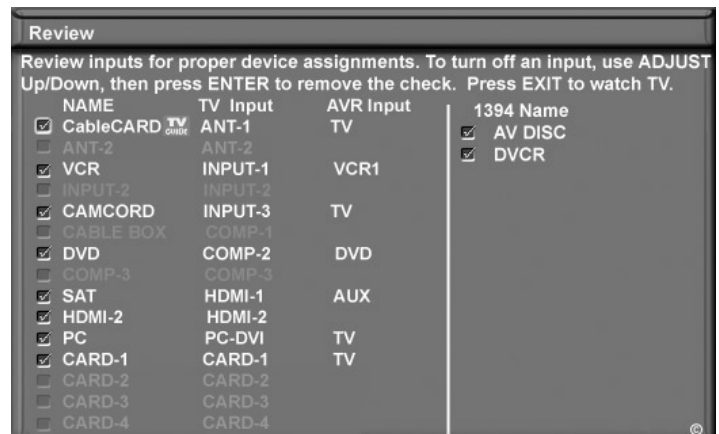

Figure 11. The Review screen lists all TV connections. IEEE 1394 devices are listed separately on the right.

Set Up TV Guide On Screen®

Setup of the TV Guide On Screen system is optional.

- Many features of TV Guide On Screen are available without NetCommand control. For example, program listings, program searches, and program reminders function without NetCommand.
 - For full functionality, you must set up NetCommand control of any device associated with TV Guide On Screen, e.g., a recording device if you wish to set up recordings through TV Guide On Screen.
- Highlight the **Guide** button in the NetCommand menu and press **ENTER** to display TV Guide On Screen setup options.
 - To enable the TV Guide On Screen system, highlight the **On** button. If you wish to disable the system, highlight the **Off** button.

Additional Setup Using the NetCommand Menu, continued

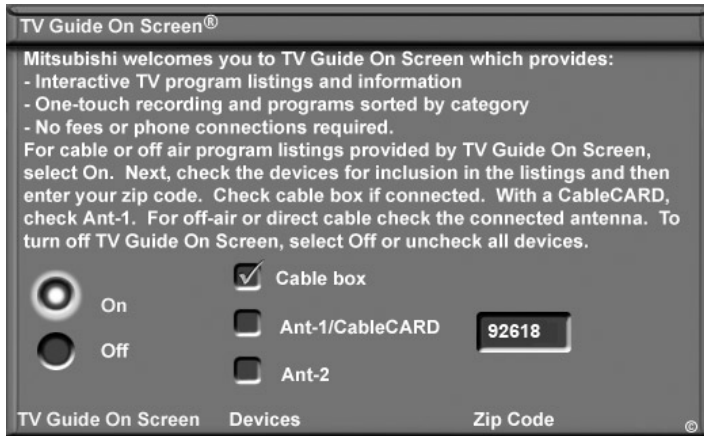

Figure 12. TV Guide On Screen setup

3. Select program sources for the listings. You can select one over-the-air source and one cable source for TV Guide On Screen. If, however, you have multiple cable sources, the channel-number assignments may not match up correctly. See the following table and notes for the preferred connection combinations.

If One Source Is:	The Other Source Can Be:	
	Ant-1 Air	Ant-2 Air
Cable Box	✓	✓
Cable Card	N/A	✓
Ant-1 Channels via Cable	N/A	✓
Ant-2 Channels via Cable	✓	N/A

Note:

- Inputs to TV Guide On Screen can include:
 - ◆ Only one over-the-air source
 - ◆ Only one cable source
 - An antenna input is required for downloading TV Guide On Screen schedules. If your cable box is connected using HDMI or IEEE-1394, you must also connect an antenna input.
 - If your cable box is connected to a **COMPONENT** input, be sure the box is set to send analog channels as 480i. If this is not possible, add an antenna input.
4. Move to the **ZIP Code** box and enter the five-digit ZIP code for your location. To receive the correct program listings for your area, you must enter the ZIP code.

For detailed information on using the TV Guide On Screen system, please see the separate *TV Guide On Screen Interactive Program Guide User's Manual*.

Add or Remove Device Keys from NetCommand Control

1. To “Learn” device keys, you must be watching the device. Press **INPUT**, highlight the icon for the affected device, and press **ENTER**.
2. Open the NetCommand menu, highlight the **Learn** button, and press **ENTER**.
3. When the Learn screen displays, continue as described earlier under “Initial NetCommand Setup for Most Device Types.”

To Replace One Device with Another on an Input Jack

1. Disconnect the device you wish to remove from the TV.
2. Connect the new device to the vacated jack.
3. Before selecting the input from the Input Selection menu, open the Input Name menu from the NetCommand menu.
4. Highlight the input text box and press **▲▼** to select a device name from the list associated with the input.
5. Press **INPUT** to open the Input Selection menu. Highlight the input icon and press **ENTER**.
6. Press **MENU** and return to the NetCommand menu.
7. Highlight the **Learn** button and press **ENTER**.
8. When the Learn screen displays, continue as described earlier under “Initial NetCommand Setup for Most Device Types.”
9. Press **EXIT** when finished.

Other Options on the NetCommand Menu

- For **Input Name** and **Icon Order** options, see chapter 5, “TV Menu Settings.”
- Use the **PC DVI Input** option to specify the type of video signal coming from your computer. For more about this option, see chapter 7, “Using the TV with a Personal Computer.”

Set Up NetCommand Control of an A/V Receiver

Perform this setup to enable the A/V receiver to switch automatically to the correct audio input when you select a device in the TV’s Input Selection menu. You must have at hand the remote controls for both the TV and A/V receiver to perform this procedure.

This is a sample setup for a DVD player, direct antenna or direct cable (to **ANT 1** or **ANT 2**), and an analog VCR. This example illustrates three scenarios for sending audio to an A/V receiver:

- **Digital Surround Sound.** A device (e.g., DVD player, cable box, satellite receiver) can send digital surround

Additional Setup Using the NetCommand Menu, continued

sound such as Dolby Digital or DTS directly to the A/V receiver, bypassing the TV entirely. A DVD player is used in this example.

It is also possible for your setup to include two (or more) devices with digital surround sound connected directly to the A/V receiver. These devices could be your DVD player plus a cable box or satellite receiver.

- **Audio Directly from TV.** Audio from **ANT 1** and **ANT 2**, memory cards, and IEEE 1394 devices is sent to the A/V receiver from the TV's analog **AUDIO OUT LEFT/RIGHT** or **DIGITAL AUDIO OUT**. In this setup, you tell NetCommand to switch to the A/V receiver's designated TV audio input.
- **Analog Stereo Output Only.** Audio from sources with only analog stereo output (such as a VCR) can be sent directly to the A/V receiver or directly to the TV first and then on to the A/V receiver.

Mitsubishi recommends you send audio directly to the TV, which can convert the signal to digital audio and send it to a digital A/V receiver as digital audio.

Part 1: Learn IR Codes for A/V Receiver Inputs

1. Connect your A/V receiver to the TV and DVD player. See chapter 2, "TV Connections," for suggestions.
 2. Open the NetCommand menu.
 3. Highlight the **Learn** button under **AV RECEIVER SETUP** and press **ENTER** to display the AV Receiver (AVR) Learn screen. See figure 13.
- When the AV Receiver Learn screen opens, the highlight is on the check box for **Input 1**. The terms **Input 1–Input 4** are generic references to the A/V receiver inputs for which the TV can learn IR codes.
4. In this example, the IR code for the A/V receiver's **TV Audio** input will be "learned" as **Input 1**. Press **ENTER** on the TV's remote control and while the text **Input 1** is flashing, press and hold the **TV INPUT** key on the A/V receiver's remote control.
 5. When a check appears in the check box, release the **TV INPUT** key.

IMPORTANT

All audio from what you are watching on the TV is always available as an output on both the TV's **AUDIO OUT LEFT/RIGHT** and **DIGITAL AUDIO OUT** jacks.

To use the surround sound capabilities of your A/V receiver however, you must connect your DVD player, satellite receiver, or cable box directly to the A/V receiver, as surround sound may not be available from the TV's audio output.

A/V Receiver Audio Inputs
(numbers 1–4 refer to the IR learning sequence in this screen)

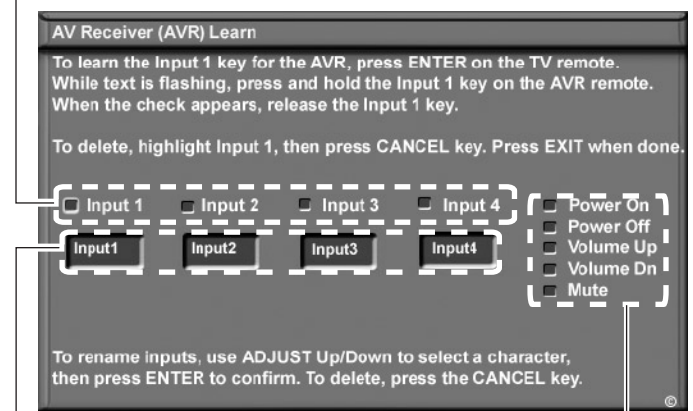

Text Boxes for You to Enter the Name of the Destination A/V Receiver Audio Input

A/V Receiver Key Commands the TV Can Send to the A/V Receiver When "Learned"

Figure 13. The AV Receiver (AVR) Learn screen lets you set up NetCommand control of your A/V receiver.

6. Press **▶** to highlight the text box for **Input 1**. To enter a name:
 - Use **▲▼** on the TV's remote control to select a character.
 - Press **ENTER** to set the letter and move the highlight to the next letter.
 - To delete a letter, highlight it and press **CANCEL** or press **▲▼** to insert a blank space (underscore character).
 - To return the highlight to the first character, repeatedly press **CANCEL**.
 - To return to the default name, highlight the first character and press **CANCEL**.
7. Press **▶** to highlight the check box for **Input 2**. In this example, the IR code for the A/V receiver's **DVD Audio** input will be "learned" as **Input 2**.
8. Press **ENTER** on the TV's remote control and while the text **Input 2** is flashing, press and hold the **DVD INPUT** key on the A/V receiver's remote control.
9. When a check appears in the check box, release the **DVD** key.
10. Press **▶** to highlight the text box for **Input 2**. Enter the name **DVD**. Use **▲▼** to enter the name **TV**. Press **ENTER** to set each letter.
11. Repeat steps 7 through 10 for any additional A/V receiver inputs connected to other devices.



Figure 14. Assign names to identify "learned" A/V receiver audio inputs

Additional Setup Using the NetCommand Menu, continued

Part 2: Learn A/V Receiver Power and Volume Keys

1. Press **▶** to highlight the check box for **Power On**.
2. Press **ENTER** on the TV's remote control and while the text **Power On** is flashing, press and hold the **POWER** or **POWER ON** key on the A/V receiver's remote control.
3. If your A/V receiver has a separate **POWER OFF** key, press **▼** to highlight the check box for **Power Off**. Repeat the preceding step to "learn" the **POWER OFF** key.

If your A/V receiver has no **POWER OFF** key, skip this step.

4. Press **▼** to highlight additional check boxes and repeat step 2 for the other A/V receiver keys.
5. When all keys have been learned, press **EXIT**.

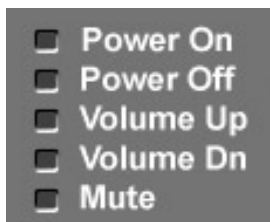

Figure 15. Perform NetCommand "learning" for these A/V receiver functions.

Part 3: Tell the TV Where Connected Devices Send Audio

Digital Surround Sound

1. Press **INPUT** to display the Input Selection menu.
2. Highlight the icon for the DVD player and press **ENTER** to switch to the DVD input.
3. Press **MENU** and open the NetCommand menu.
4. Highlight the text box under **AV RECEIVER SETUP**.
5. Press **▼** to move through the list to **DVD**. This setting tells the TV that digital surround sound from the DVD player is connected directly to the A/V receiver's **DVD AUDIO** input.

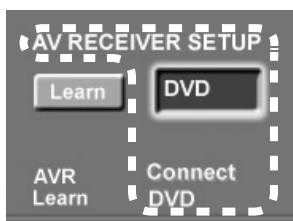

Figure 16. A/V receiver setup indicating the DVD player's audio output is connected directly to the A/V receiver's DVD Audio input.

6. Press **EXIT** to close the screen.

Audio Directly from TV

1. Press **INPUT** to display the Input Selection menu.
2. Highlight the icon for an antenna input (**ANT 1** or **ANT 2**) and press **ENTER** to switch to the input.
3. Press **MENU** and open the NetCommand menu.
4. Highlight the text box under **AV RECEIVER SETUP**.

5. Press **▼** to move through the list to **TV**. This is the list of A/V receiver inputs you named in the AV Receiver (AVR) Learn screen (see figure 13).

The **TV** setting here indicates that audio out from the TV (**DIGITAL AUDIO OUT** or **AUDIO OUT LEFT/RIGHT**) is sent to the A/V receiver's **TV AUDIO** input. Audio from **ANT 1** and **ANT 2**, memory cards, and IEEE 1394 devices must go to the A/V receiver from the TV's audio outputs as there is no way to send the audio directly to the A/V receiver.

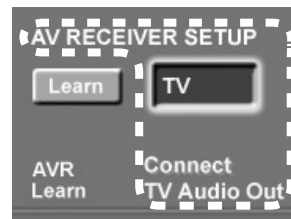

Figure 17. A/V receiver setup indicating that the TV's audio output (**DIGITAL AUDIO OUT** or **AUDIO OUT LEFT/RIGHT**) is connected to the A/V receiver input named **TV AUDIO**.

6. Press **EXIT** to close the screen.

Analog Audio (e.g., analog VCR)

1. Press **INPUT** to display the Input Selection menu.
2. Highlight the icon for the VCR and press **ENTER** to switch to the VCR input.
3. Press **MENU** and open the NetCommand menu.
4. Highlight the text box under **AV RECEIVER SETUP**.
5. Confirm that the setting is at **None**, the default. This setting tells the TV to automatically transfer VCR audio to the A/V receiver. The TV converts analog audio to digital for output to a digital A/V receiver.

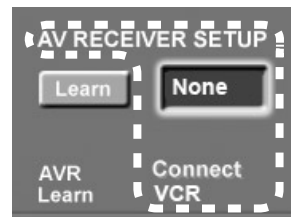

Figure 18. A/V receiver setup indicating the analog VCR's audio output is automatically sent to the A/V receiver via the TV's audio output.

6. Press **EXIT** to close the screen.

IMPORTANT

To hear audio that is sent from the TV to the A/V receiver, you must have:

- physically connected the TV to the A/V receiver
- learned the IR codes for the A/V receiver inputs
- chosen the correct input under NetCommand **AV RECEIVER SETUP**
- selected the A/V receiver in the Input Selection menu

If you hear no audio from the A/V receiver, open the NetCommand menu and perform the procedure in Part 3, "Audio Directly from TV" or "Analog Audio (e.g. analog VCR)."

Note that all audio should be sent through the TV's audio outputs unless you have surround sound audio going from the device directly to the A/V receiver.

TV Operation and Features

Remote Control	48
Choosing a Program Source	50
ChannelView™ Channel Listings	50
Status Display	51
Split Screen	52
TV Signals and Display Formats	54
Memory Card Playback	56

Remote Control

Overview

Figure 1, next page

1. **Slide Switch:** Selects the A/V device to be controlled by the remote control. Set the slide switch to TV for operation of the TV, NetCommand-controlled devices, and IEEE 1394 devices. Control of additional devices requires programing (see Appendix D, “Programming the Remote Control.”).
2. **SLEEP:** Sets the TV to turn off within 2 hours. See the next page for instructions.
3. **Digits/Letters:** Allow you to tune to a channel by entering channel numbers; press **ENTER** for faster tuning. Use numbers and the **CANCEL** key to enter digital sub-channels. Also use for entering information into menus.
To select letters when naming channels, repeatedly press the associated number key. The following special characters are available with the 1 and 0 keys:

1	!	&	blank space
0	/	*	-

4. **-/CANCEL (SUB-CHANNEL/CANCEL):** When entering digital channel numbers, adds a separator between main and sub-channel numbers. Clears FAV and some menu entries.
5. **POWER:** Turns TV power on and off.
6. **QV (QuickView™):** Switches between the current channel and the last channel viewed.
7. **MUTE:** Turns TV sound off or on.
8. **SPLIT:** Turns Split Screen mode on and off.
9. **VOL ^/∨ (Volume Up/Down):** Changes sound level.
10. **CH/PAGE ^/∨ (Channel or Page Up/Down):** Scans up or down through memorized channels. Pages up and down through screens when used with the TV Guide On Screen system or ChannelView™.
11. **FAV (Favorites):** Scans through memorized lists of favorite channels. See “Channel Menu” in chapter 5, “TV Menu Settings,” for more information.
12. **FORMAT:** Changes the shape and size of the main TV picture. When in Split Screen mode, changes the size of the split images while maintaining their aspect ratios.

Note: The TV’s remote control can operate other audio/video devices.

- See chapter 3, “TV Setup,” for NetCommand “Learning” of device keys.
- See Appendix D, “Programming the Remote Control” for instructions on programming.
- For control of IEEE 1394 devices, see chapter 6.

13. **INPUT:** Displays the **Input Selection** menu from which you can select an input source to view, such as an antenna input (**ANT 1/2**) or a connected device.
14. **▲ ▼ ◀ ▶ (Adjust Up/down/Left/Right):** Navigate menus and change settings.
15. **ENTER:** Selects a channel number or menu item.
16. **GUIDE:** Displays or removes ChannelView™ channel listing for **ANT 1** and **ANT 2**. With the TV Guide On Screen system enabled, launches TV Guide On Screen. Displays DVD disc or top menu for a NetCommand-controlled DVD player.
17. **INFO:** Displays an on-screen summary of the current device in use and any broadcast information available, including current V-Chip information. See chapter 4, “TV Operation and Features,” for details.
18. **AUDIO:** Selects individual audio settings for adjustment.
19. **VIDEO:** Selects individual video settings for adjustment.
20. **MENU:** Displays the main TV menu using the **▶ViewPoint** on-screen menu system. When a sub-menu is open, backs up one level.
21. **EXIT:** Closes all TV on-screen menus and displays and returns to normal TV viewing.
22. **F1-F4**
For devices under NetCommand control: Perform NetCommand “Learning” to assign functions to the F1–F4 keys.
For devices operating independently of NetCommand: The F1–F4 keys work like the A, B, C, D buttons on some cable boxes, satellite receivers, and DVD players. Program the remote control for your equipment and test the keys. See Appendix D, “Programming the Remote Control.”
24. **⏸ (PAUSE):** Freezes a broadcast TV picture when no Split Screen image is displayed. When Split Screen is displayed, freezes the sub-picture. See below for use with recordable media.

Record/Playback Keys

To enable the recording and playback functions:

- program the remote for your VCR or DVD player/recorder and set the slide switch to **VCR** or **DVD**.
 - Perform NetCommand “Learning” for the device.
 - See chapter 6, “NetCommand Operations,” for control of IEEE 1394 devices.
23. **⏻ (RECORD):** Records with a VCR or DVD recorder.
 24. **⏸ (PAUSE):** Pauses a VCR or DVD. See above for use during TV viewing.
 25. **⏹ (STOP):** Stops play of a VCR or DVD.
 26. **⏮ (REVERSE):** Rewinds a VCR. Reverse scans a DVD.
 27. **▶ (PLAY):** Plays a VCR or DVD.
 28. **⏭ (FAST FORWARD):** Fast forwards a VCR. Forward scans a DVD.

Remote Control, continued

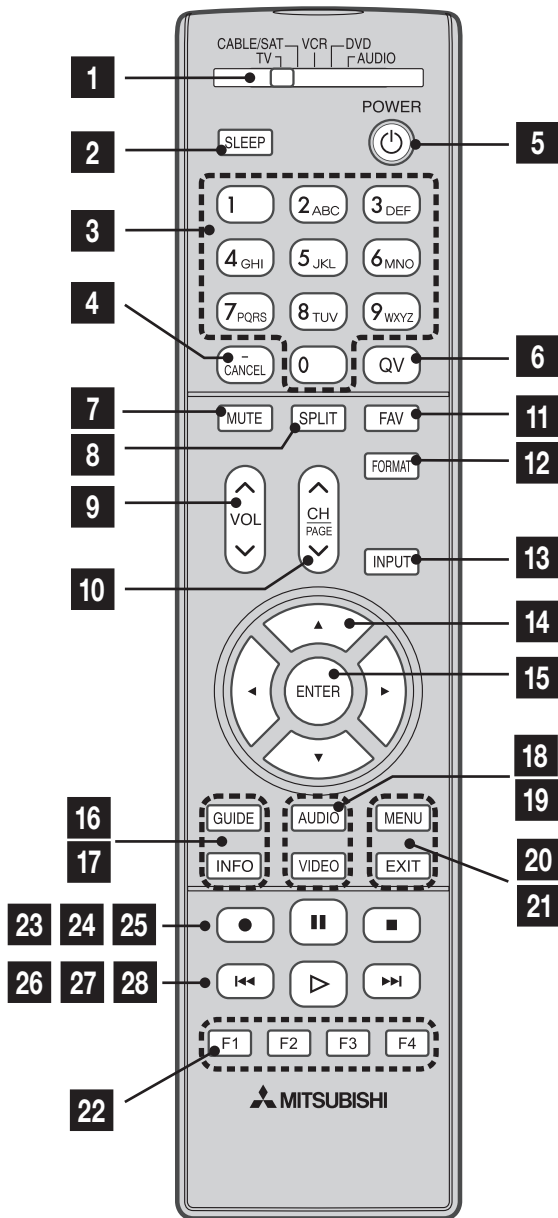

Figure 1. Remote Control Overview

Sleep Timer

Setting the Sleep Timer

1. Press **SLEEP** on the remote control.
2. Press **SLEEP** additional times to increase the time in 30-minute increments up to the maximum of 120 minutes.
3. Press **EXIT** or wait five seconds without pressing any buttons for the message to disappear.
4. Press **SLEEP** to view the time remaining before the sleep timer turns off the TV.

Cancelling the Sleep Timer

1. Press **SLEEP** to display the on-screen message.
2. Press **SLEEP** repeatedly until **OFF** is displayed.

Note: After five seconds of inactivity, the message box will disappear.

Resetting the Remote Control

If the slide switch is set to TV and the TV does not respond properly, do the following to reset the remote control.

1. Press and hold **POWER** for several seconds until the button blinks twice and goes off.
2. Release the **POWER** button.
3. Press keys **0 0 9 3 5** and the **POWER** button will blink twice when you finish entering the code. While entering the code, pause for a moment between each key press to ensure it is recognized.

FAV (Favorite Channels)

For use of the FAV feature with the remote control, see chapter 5, “TV Menu Settings,” and the explanation of the Channel menu.

Choosing a Program Source

NOTE: If your only viewing sources are connected to the **ANT 1** and **ANT 2** antenna jacks, you can switch inputs without the Input Selection menu. Press **INPUT** to switch between **ANT 1** and **ANT 2**. To verify which is the current source while watching TV, press **INFO** to see the on-screen status display.

Selecting from Multiple Sources: The Input Selection Menu

The Input Selection menu allows you to select an input to watch on the TV. The current input appears as a gold-colored icon.

1. Press **INPUT** on the TV's remote control to display the Input Selection menu (Figure 2).
2. To select a different input, press **▲▼◀▶** on the TV's remote control to move the highlight through icons in the input section.
3. Press **ENTER** to switch to the device and close the menu.

More About the Input Selection Menu

- To assign meaningful labels to the icons, such as "VCR" or "DVD," see the "Input Name" section of chapter 5, "TV Menu Settings."
- To rearrange the icons, see the "Icon Order" section of chapter 5, "TV Menu Settings."
- To use with NetCommand-controlled devices, including IEEE 1394/DTVLink devices, see additional information in chapter 6, "NetCommand Operations."

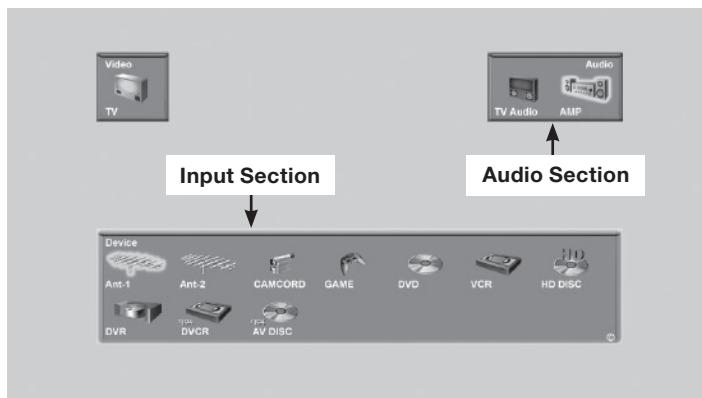

Figure 2. Input Selection menu. See chapter 6, "NetCommand Functions," for use of the Audio section.

ChannelView™ Channel Listings

ChannelView provides listings, as sent by broadcasters, for memorized channels on **ANT 1** or **ANT 2**.

ChannelView is available

- for an antenna input not assigned to the TV Guide On Screen system.
- When the TV Guide On Screen system is disabled.

Channels are marked with either a **D** for digital channels or an **A** for analog channels. Digital channels are shown

with the major channel and sub-channels (or bitstreams). Analog channel information is displayed as sent.

Note: If limited data is shown or no program data appears, it is because the broadcaster is not sending the information. *This is not a defect of your TV.*

Using ChannelView

Feature	Instructions
View listings while viewing ANT 1 or ANT 2 .	Press GUIDE .
Scan through memorized channels one by one.	Press ▲ or ▼ .
Scan quickly through memorized channels.	Press PAGE ^ / v .
View detailed information for digital channels.	Press ▲ or ▼ to highlight a channel and press ▶ .
Return to viewing basic listings information	Press ◀ .

Channel	Channel	Antenna	Program
2	CBS	A Ant-1	
2-1	KCBS-DT	D Ant-1	CBS Local News
4	ABC	A Ant-1	
4-1	KNBC-DT	D Ant-1	NBC Evening News
7	ABC	A Ant-1	
7-1	KABC-DT	D Ant-1	ABC World News
28	PBS	A Ant-1	
28-1	KCET-DT	D Ant-1	The 2005 Rose Parade
28-2	KCET-DT	D Ant-1	Nightly Business Report
30		A Ant-1	
62-101		D Ant-1	
62-102		D Ant-1	
128	CNN	A Ant-1	
1104	KNBC-DT	D Ant-1	NBC Evening News

Figure 3. ChannelView screen, current programs. Use **◀▶** to exchange displays for current and future programs.

Channel	Channel	Antenna	Time	Program
2	CBS	A Ant-1	5:30 PM	Nightly Business Report
2-1	KCBS-DT	D Ant-1	6:00 PM	NewsHour with Jim Leh...
4	ABC	A Ant-1	7:00 PM	Life and Times
4-1	KNBC-DT	D Ant-1	7:30 PM	California's Gold
7	ABC	A Ant-1	8:00 PM	Washington Week
7-1	KABC-DT	D Ant-1	8:30 PM	Wall Street Week with F...
28	PBS	A Ant-1	9:00 PM	Now with Bill Moyers
28-1	KCET-DT	D Ant-1	10:00 PM	Culture of Hate: Who ar...
28-2	KCET-DT	D Ant-1	11:00 PM	Life and Times
30		A Ant-1	11:30 PM	Charlie Rose
62-101		D Ant-1	12:20 PM	Classic Arts Show
62-102		D Ant-1		
128	CNN	A Ant-1		
1104	KNBC-DT	D Ant-1		

Figure 4. ChannelView screen, future programs on the selected channel (digital channels only)

IMPORTANT

To receive ChannelView updates: Set the Energy Mode to Fast Power On and leave the TV powered off for a while each day. If the TV loses power, program listings will be lost until the next update.

Status Display

The on-screen status display appears when you turn on the TV, change inputs, change channels, or press the **INFO** button on the remote control. The most common displays

are shown below. Seldom or never do all the status indicators appear at the same time.

Analog Program

1. Source Antenna or Input
2. Analog Channel being received (If an antenna source)
3. Channel Name (if or named in the Channel menu)
4. Signal Type Being Received. Possible:
From **ANT-1**, **ANT-2**, or **INPUT** jacks: 480i
From **COMPONENT** jacks: 480i, 480p, 720p, 1080i
5. Screen Format in use
Possible:
Analog 480i /480p signals: Standard, Expand, Zoom, Stretch, Stretch Plus, Narrow
720p/1080i signals: Standard, Wide Expand
6. Stereo and/or SAP being broadcast. In Split Screen mode, the speaker icon is on either the left or right to indicate the sound source.
7. V-Chip Ratings
8. Channel is in current FAV bank (FAV bank 2)
9. Day and Time

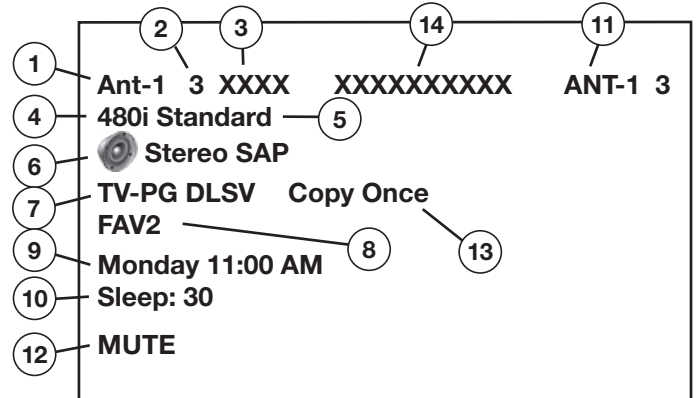

10. Sleep Timer remaining time
11. Split Screen picture source and channel
12. Audio Mute on
13. Copy-Protection Status. Possible:
Copy Once
Copy Never
14. Program name (if provided by TV Guide On Screen)

Digital Program

1. Digital Major and Sub-Channel Number
2. Digital Channel Name (only if broadcast)
3. Signal Type Being Received
Possible: SD 4:3, SD 16:9, HD
4. Screen Format in Use
Possible:
SD 4:3: Standard, Expand, Zoom, Stretch, Stretch Plus, Narrow
SD 16:9 or HD 16:9: Standard, Wide Expand
5. Language(s) being broadcast
6. Program Name (if broadcast) or provided by TV Guide On Screen
7. Copy-Protection Status. Possible:
Copy Once: Program can be recorded
Copy Never [Retention Period]: Program can never be recorded; may display program retention period

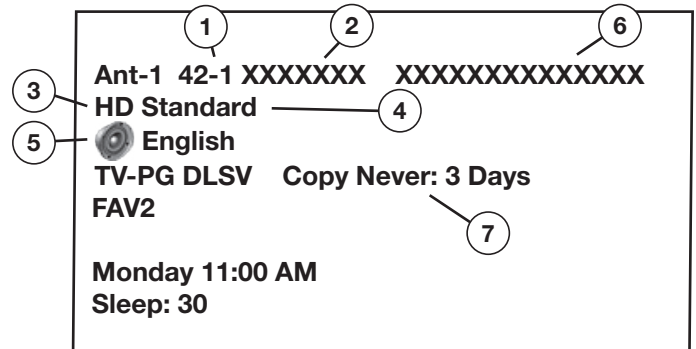

Digital IEEE 1394 Device

1. Status of D-VHS VCR or IEEE 1394 device
2. Counter of D-VHS VCR
3. Special message line (shows only when a special message is needed; may be seen with analog signals)
4. Copy-Protection Status. Possible:
Copy Once: Program can be recorded
Copy No More: Program can never be recorded; program may be movable.
Copy Never [Retention Period]: Program can never be recorded; may display program retention period

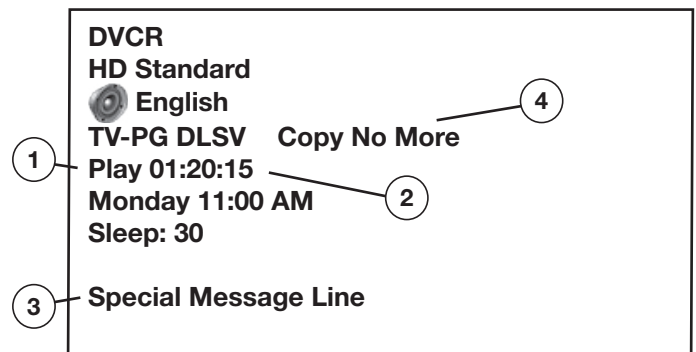

Split Screen

Split Screen allows you to view pictures from two different sources at the same time. Split Screen is available when you have video sources connected to the TV in addition to connections on **ANT 1** or **ANT 2**.

Operation

Split Screen Operations	Instructions
Turn Split Screen on or off	Press SPLIT .
Switch the sound source between main and sub-pictures.	Press ◀ or ▶. The speaker icon appears briefly to indicate the sound source as either the main picture (left) or sub-picture (right). The sound source is the side you can control with the remote control. 
Check which picture is the sound source.	Press INFO . The speaker icon appears in the information display to indicate the sound source.
Change the source of the sub-picture.	<ol style="list-style-type: none"> Press ▶ to make the sub-picture the sound source. Press INPUT and move the highlight to the icon for the input you wish to view as the sub-picture (see figure 6). Press ENTER to make the change. <p>Grayed-out input icons are unavailable as Split Screen sources or with the current source.</p>
Change sub-picture channel (when the input source is ANT 1 , ANT 2 , or a NetCommand-controlled cable box or satellite receiver).	Press ▶ to make the sub-picture the sound source then press CH ^/∨.
Freeze or unfreeze the sub-picture.	Press PAUSE (⏸). Press PAUSE again to return to normal moving video.
Change the size of the main and sub-pictures.	Repeatedly press FORMAT to cycle through picture sizes. See the following page for sample displays.
Make the sub picture fill the screen.	<ol style="list-style-type: none"> Press ▶ to make the sub-picture the sound source. Press SPLIT to close Split Screen mode.

“**SPLIT**” appears under the **Video** icon to distinguish this menu from the Input Selection menu.

Choice of Split Screen sub-Picture Sources

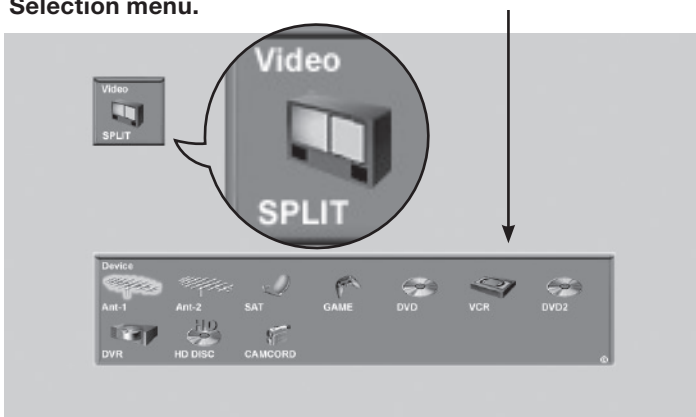

IMPORTANT

- Split Screen is unavailable if your only inputs are **ANT 1** and **ANT 2**.
- A 1080p signal from an HDMI jack or a personal computer can be viewed only as the main picture.

Figure 5. Change the source of the sub-picture with the Split Screen Input Selection menu.

Split Screen Displays

**16:9 Main Picture/
4:3 Sub-Picture**

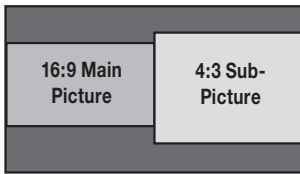

Press **FORMAT**

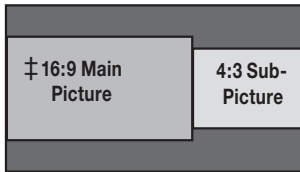

Press **FORMAT**

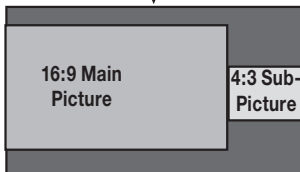

**16:9 Main Picture/
16:9 Sub-Picture**

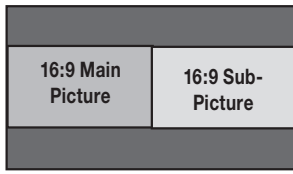

Press **FORMAT**

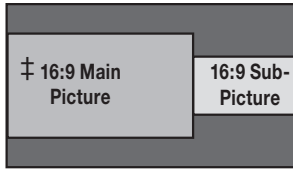

Press **FORMAT**

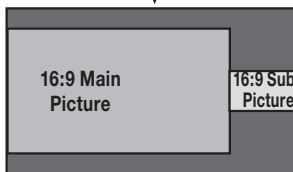

**4:3 Main Picture/
4:3 Sub-Picture**

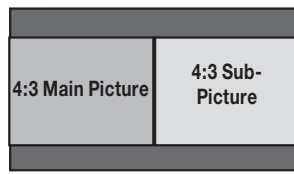

Press **FORMAT**

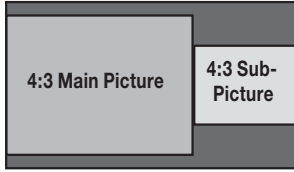

Press **FORMAT**

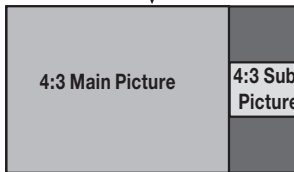

**4:3 Main Picture/
16:9 Sub-Picture**

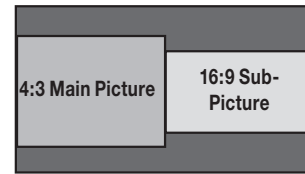

Press **FORMAT**

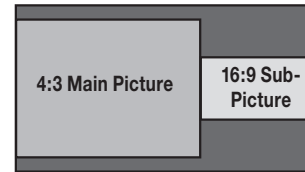

Press **FORMAT**



Display choices. Press the **FORMAT** key repeatedly while in Split Screen mode to view different displays.

TV Inputs for Split Screen

The available Split Screen picture sources are listed below.

Main Picture \ Sub-Picture	ANT 1	ANT 2	INPUT	COMPONENT	HDMI (no 1080p)	HDMI (1080p)	IEEE 1394
ANT 1			✓	✓	✓		✓
ANT 2			✓	✓	✓		✓
INPUT	✓	✓	✓*	✓	✓		✓
COMPONENT	✓	✓	✓	✓**	✓		✓
HDMI (no 1080p)	✓	✓	✓	✓			✓
HDMI (1080p) ‡	✓	✓	✓	✓			✓
PC-DVI ‡	✓	✓	✓	✓			✓
IEEE 1394	✓	✓	✓	✓	✓		

* Only when main picture and sub-picture are from different **INPUT** jacks.

** Only when main picture and sub-picture are from different **COMPONENT** jacks.

‡ **HDMI 1080p** and **PC-DVI** appear as main picture in the Split Screen combinations marked in the second row of screens above under “Split Screen Displays.”

Check marks indicate combinations of picture sources you can view in Split Screen mode.

TV Signals and Display Formats

This is a widescreen TV, also known as a 16:9 TV. This shape reflects the new types of images available from HDTV and many DVDs. There are still many older style narrow-screen images (called 4:3 aspect ratio) you will encounter. While there is no perfect solution for displaying a squarish, narrower image on a wide screen, Mitsubishi offers several display formats from which you can choose.

Press **FORMAT** on the TV remote control to cycle through the available display formats. The last-used format for each device is used when you return to that device.

Note:

- Only standard format is available for Split Screen.
- PC formats vary depending on the PC signal.
- For 1080p signals from an HDMI input, see “Computer Display Formats” in chapter 7, “Using the TV with a Personal Computer.”

DVD Definitions

Anamorphic (or Enhanced for WideScreen TV)

These DVDs are recorded in a special way to properly show widescreen images on 16:9 TV sets using the Standard format mode. This is the recommended viewing choice.

Non-Anamorphic (or 4:3, 1:33:1, Letter Box, or Full Screen)

These DVDs are recorded for use with traditionally shaped, squarish TVs. They may be full screen (4:3 or 1:33:1) which crops movies to fit the narrow TV, or letter box, which adds black top and bottom bars.

This information may be listed on the DVD case. Some DVDs support both types of recordings.

Signal Definitions

480i Signals: Traditional analog interlaced signals from or through **ANT-1** and **2**, **INPUT 1–3**, **COMPONENT** and **HDMI** jacks.

480p Signals: Progressive-scan DVD signals on **COMPONENT** and **HDMI** jacks.

720p and 1080i Signals: High-definition signals received through **COMPONENT** and **HDMI** jacks. These signals are always 16:9 (widescreen).

SD 4:3: Standard-definition narrow-screen format signals from digital channels and IEEE 1394 devices.

SD 16:9: Standard-definition widescreen format signals from digital channels and IEEE 1394 devices.

HD: High-definition wide-screen format signals from digital channels and IEEE-1394 devices. These signals are always 16:9 (widescreen).

TV Display Format Definitions

Standard: This is the full-screen format. HDTV signals use this format. This format is useful for displaying Anamorphic DVDs that have 1.78:1 or 1.85:1 aspect ratios. Anamorphic DVDs that have a 2.35:1 aspect ratio are displayed with black bars at the top and bottom, but show the entire image correctly. Narrow (4:3) images are stretched evenly from side to side. Available for all signals.

Expand: This enlarges the picture to fill the screen, cropping off some of the image at the top and bottom. This is useful for reducing the letter box top and bottom bars of non-anamorphic DVD images. Available for 480i, 480p, and digital SD 4:3 signals only.

Zoom: This enlarges the picture, cropping off some of the image at each side and top and bottom. This is useful for removing or reducing the black top and bottom bars on anamorphic DVDs with a 2.35:1 aspect ratio. Available for 480i, 480p, and SD 4:3 signals only.

Stretch: This format stretches a narrow (4:3) image across the screen; there is less stretch in the center than at the sides, however. This allows the entire narrow image to be displayed across the screen with less distortion than is seen in the Standard format. Available for 480i, 480p, and SD 4:3 signals only.

Stretch Plus: Similar to stretch mode, but to minimize distortions on the side, the picture is expanded to crop off portions of the top and bottom. Except when displaying menus or Split Screen, press **▲▼** to adjust the position of the picture vertically. Available for 480i, 480p, and SD 4:3 signals only.

Narrow: This format displays narrow (4:3) images in their original shape, and adds stationary black side bars to fill the screen. Available for 480i, 480p, and SD 4:3 signals only.

Wide Expand: Enlarges the picture, cropping some of the image on both sides. This Expand format is useful to remove or reduce black side bars added to narrow images that are converted to 16:9 signals for digital broadcast. Available for 1080i, 720p, digital SD 16:9 and digital HD signals.

Note: All high-definition channels send widescreen (16:9) signals, but not all programming sent on these channels was created for this format. As a result, the broadcaster must convert such programming for broadcast, and may stretch the image or add side bars to fill the widescreen area.

TV Display Formats

See descriptions on the preceding page.

ORIGINAL SIGNAL Non-anamorphic or SD 4:3

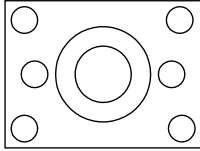

ORIGINAL SIGNAL Anamorphic DVD

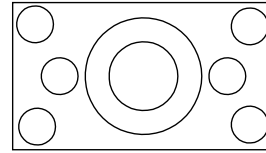

TV Display

Standard

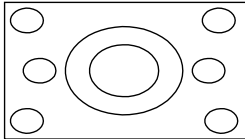

(not recommended, distorted)

Standard

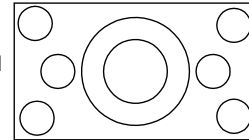

(recommended)

Expand

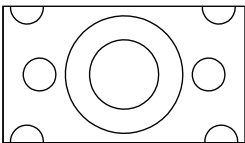

(recommended for letterboxed)

not available for
HD, SD 16:9 or
analog 720p, 1080i

Expand

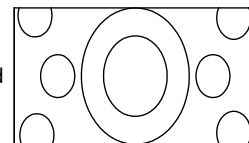

(not recommended, distorted)

not available for
HD, SD 16:9 or
analog 720p, 1080i

Zoom

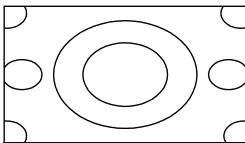

(not recommended, distorted)

not available for
HD, SD 16:9 or
analog 720p, 1080i

Zoom

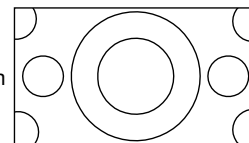

(recommended for anamorphic 2.35:1)

not available for
HD, SD 16:9 or
analog 720p, 1080i

Stretch

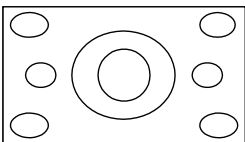

(recommended for standard broadcast)

not available for
HD, SD 16:9 or
analog 720p, 1080i

Stretch

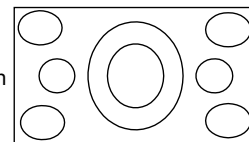

(not recommended, distorted)

not available for
HD, SD 16:9 or
analog 720p, 1080i

Stretch Plus

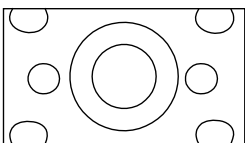

(recommended for standard broadcast)

not available for
HD, SD 16:9 or
analog 720p, 1080i

Stretch Plus

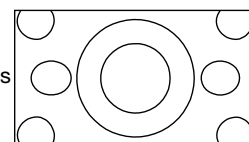

(not recommended, distorted)

not available for
HD, SD 16:9 or
analog 720p, 1080i

Narrow

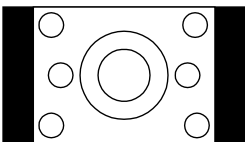

Narrow

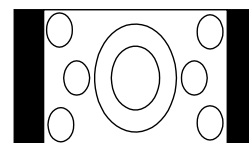

(not recommended, distorted)

not available for
HD, SD 16:9 or
analog 720p, 1080i

**SD 16:9 or
HD Digital**

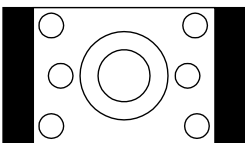

(with side bars in broadcast)

Standard
Original HD or SD
16:9, 720p or 1080i

Wide Expand

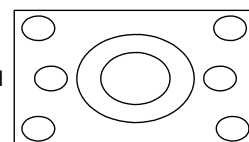

(recommended to remove side bars)

available only for
digital SD 16:9, HD,
analog 1080i or 720p

Memory Card Playback

Memory Card Reader

(models WD-57732, WD-65732, WD-73732)

Inserting a memory card

1. Insert a card into a matching card slot on the front of the TV. Be sure to use the correct card slot. See the table below. Normally the label side should be up, but if the card does not fit, try turning the card over and insert again. When properly inserted, the light next to the slot will light up and the TV will automatically switch to the card display. Cards up to 1 GB, with a file format of FAT 16 (block size = 1024 or 2048) are supported.

CARD 1 SmartMedia™	CARD 2 MultiMediaCard™ Secure Digital (SD)
CARD 3 CompactFlash® (Types I and II) Microdrive®	CARD 4 Memory Stick PRO™ Memory Stick™

2. Next, the Media Dialog box (figure 6) automatically displays. Use the **AUDIO** key to switch to MP3 or WMA audio playlist setup or use the **VIDEO** key to switch to JPEG slide show setup.

Do not pull the memory card out while it is playing.

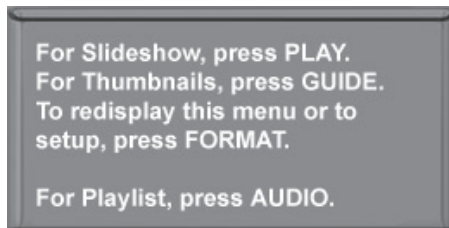

Figure 6. Media dialog box, slide show mode. A similar dialog box appears when in audio mode.

3. On the remote control, press:

	Start the slide show or play audio.
GUIDE	Display the JPEG Thumbnail menu (see figure 7) or Audio track playlist (see figure 8)
FORMAT	When Media Dialog Box is open, display the Media Setup menu (see figure 9). When screen is blank, display the Media Dialog Box (see figure 6).
VIDEO	Switch from audio mode to slide show mode.
AUDIO	Switch from slide show mode to audio mode.
INFO	Display on-screen status for the memory card.
INPUT	Open the Input Selection menu to select a different device to watch.

Viewing Pictures

Using the Picture Thumbnail Menu

1. Press **GUIDE** on the remote control to display the JPEG picture Thumbnail menu. See figure 7.
2. Press **▲▼◀▶** to move the highlight to different images; **CH ^/∨** changes pages of the Thumbnail menu. Use **◀◀** to go to the previous slide and **▶▶** to go to the next slide.
3. Press **FORMAT** to rotate the selected image 90° (pressing **FORMAT** four times rotates the image completely around to the original position).
4. Press **▶** to begin playback of the slide show starting with the selected image.



Figure 7. JPEG Thumbnails

Keys for JPEG Picture Slide Show	
	Begin or resume slide show playback
	Pause or resume playback while in the automatic advance mode.
	Advance to the next slide.
	Go to the previous slide.
FORMAT	Single press rotates the slide 90° clockwise. Multiple presses continue to rotate the slide.
	Stop slide show, display media dialog box.

Compatible Picture Files (JPEG Pictures up to 1 GB)

- Still images recorded on digital cameras using the Exchangeable Image File Format, version 2.1 (EXIF 2.1) standard for digital still cameras and Design Rules for Camera File Systems version 1.0 (DCF 1.0)
Some images opened and resaved on a computer may not play back or may not be able to display a picture in the thumbnail list because the computer program that opened and resaved the images changed the file to an incompatible format.
- Standard digital images with a maximum size 5 megapixels for each image, or 2560 x 1920 pixels. Pictures

Warning: Some memory cards available on the market are not properly certified to the card specifications noted and cannot be used by the card reader. If you experience problems reading your file, please transfer your files to a properly certified card.

Memory Card Playback, continued

will be scaled to the TV display. Some pictures may be cropped to fit.

- Full path file names can be no longer than 50 characters and must end in a .jpg extension. Not all 50 characters will display.

Images stored on cards larger than 256MB can take a longer initial time to display.

Playing Audio

Using the Audio Playlist Menu

1. Press **GUIDE** to display the Playlist menu.
2. Press **▲ ▼** to select different tracks; **CH ▲/▼** changes pages of the Playlist. Use **(◀◀)** to go to the first track on the page and **(▶▶)** to go to the last track on the page.
3. Press **(▶)** to begin playback. The song currently playing is highlighted.

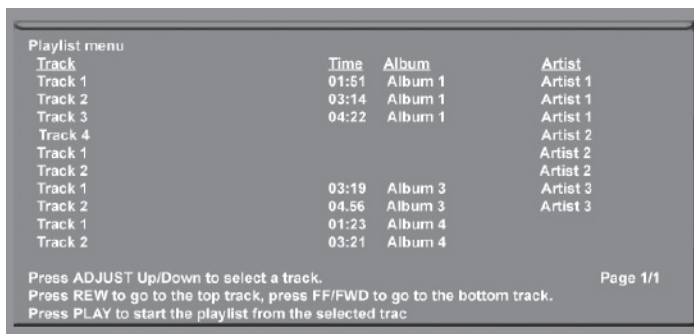

Figure 8. Audio Playlist

Keys for MP3 or WMA Audio Playback	
(▶)	Begin or resume playlist playback.
()	Pause or resume playback.
(▶▶)	Advance to the next track/song.
(◀◀)	Go to the previous track/song.
(■)	Stop playback and display media dialog box..

IMPORTANT

- **JPEG images cannot be edited through the TV. When editing on a personal computer, make name changes only to avoid file incompatibility.**
- **MP3 files must have at least a 32-kHz sampling rate.**

Compatible Audio Files (MP3 or WMA)

- Files recorded with sampling rates of 32 kHz, 44.1 kHz or 48 kHz.
- Files recorded with fixed bit rates
- File names with .mp3 or .wma extensions

NOTE:

- During MP3 audio playback, audio from the card is sent to the A/V receiver as analog audio. Digital out is not available.
- Repetitive noise may be present when playing WMA digital audio files from memory cards.

Media Setup Menu

In the Media setup menu you can adjust the slide show display, frequency, or interval, or the playlist frequency. To display the Media Setup menu, press **MENU** twice from a blank screen to first display the Media Dialog box. Next press **FORMAT**. Press **FORMAT** again to close the Media Setup menu. Press **MENU** on the remote control to redisplay the Media Dialog Box.

JPEG Picture Slide Show Setup

- For JPEG picture slide show playback, select Auto-automatic or Manual advance. For manual operation, press **(▶)** or **ENTER** to advance to the next slide.
- For automatic advance, select the frequency or number of times to show the complete slide show, Once, Twice or Continuously.
- For automatic advance, select the interval time each slide is shown, for example, five seconds, or 30 seconds

MP3 or WMA Audio Playlist Setup

Select the frequency or number of times to play the complete playlist. Once, Twice or Continuously.

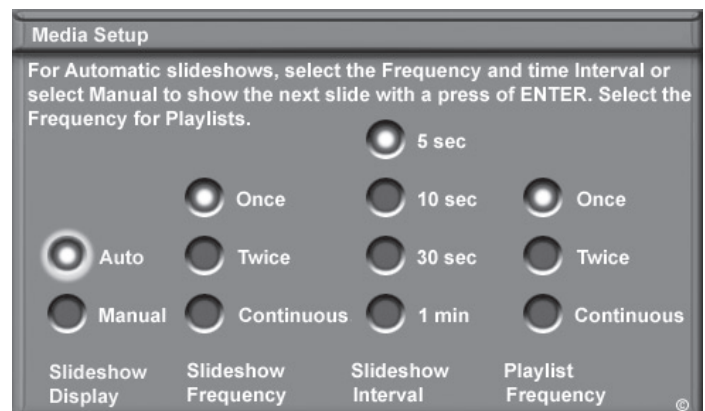

Figure 9. Media Setup menu

TV Menu Settings

3D Graphical ▶ViewPoint® Menu System	60
Main Menu	61
Setup Menu	62
NetCommand Menu	62
Channel Menu	64
Captions Menu	66
Parental Lock Menu	68
Setting a Pass Code	68
Lock TV by Time and Front-Panel Lock	68
Rating Menus	68
Bypassing the Ratings Lock and Lock by Time	70
V-Chip Signal Information	
TV Ratings	71
Movie Ratings	71
Audio/Video Menu	72
Audio Settings	72
Video Settings	74

3D Graphical ▶ViewPoint® Menu System

Your TV has Mitsubishi's exclusive 3D Graphical ▶ViewPoint® on-screen operating system, which provides on-screen information for menu choices and changes using the TV's remote control.

▶ViewPoint® Menu Screens



A picture (icon) is highlighted on the menu screen when selected with the directional arrows ▲▼◀▶. You may then make changes within the menu or access sub-menus, if available.



You can also open sub-menus from a button. Sometimes when you select a button, an automatic function begins.

The ▶ViewPoint® system includes the following special features:

- The currently selected icon or button is highlighted with a yellow outline; the text color is yellow.
- On-screen instructions, shown in the message line at the bottom of the menu, provide feature selection and adjustment information.
- Some on-screen menu options must be set before other options are available.

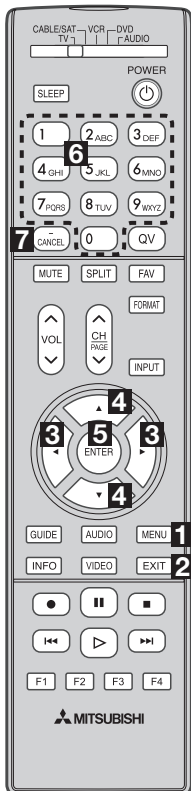

▶ViewPoint® Remote Control Buttons

The following buttons on the remote control help you navigate within the ▶ViewPoint® system:

Key	Function
1 MENU	Display or close the Main menu or move back one menu screen at a time.
2 EXIT	Close all menus and return to TV viewing.
3 ◀▶ (Adjust Left/Right Keys)	◀▶ to select a menu item to change.
4 ▲▼ (Adjust Up/Down Keys)	<ul style="list-style-type: none"> • to change the settings. • to scroll through pre-set text-box entries.
5 ENTER	Open a menu, start an automatic function, or select a check box.
6 Numbers, Letters	Enter custom names in some text boxes.
7 CANCEL	Clear a setting or stop an automatic function.

Main Menu

Press **MENU** on the remote control to open the Main menu, figure 1. See below for an overview of the options available through the Main menu.



Figure 1. Main menu.



Setup

See chapter 3, “TV Setup,” for use of the Setup menu.

- ◆ Select English or Spanish for menus and on-screen displays.
- ◆ Memorize the available channels for the antenna or cable service connected to the **ANT 1** and **ANT 2** jacks.
- ◆ Set the TV’s internal clock either manually or have the TV set the clock automatically.
- ◆ Set the TV Timer to turn on the TV automatically at a designated time.
- ◆ Set the energy mode for power consumption when the TV is powered off.
- ◆ Turn off Demo Mode.
- ◆ View the TV’s software version.



NetCommand

See chapter 3, “TV Setup,” for more on use of the NetCommand menu.

- ◆ See a review list of all connections to the TV.
- ◆ Set up TV Guide On Screen® or make changes to the setup.
- ◆ Assign meaningful names to the input icons in the Input Selection menu.
- ◆ Change the order of icons in the Input Selection menu.
- ◆ Perform NetCommand “Learning” setup.
- ◆ Associate A/V receiver inputs with devices to enable automatic audio switching.



Record

- ◆ Set up a NetCommand-controlled recording.
- ◆ View a list of scheduled recordings.
- ◆ Set the default digital recording device.
- ◆ Select anamorphic or cropped format for analog recordings.



Channel

- ◆ Edit channels for the **ANT 1** and **ANT 2** inputs.
- ◆ Manually add or delete channels from memory, name analog channels, or add your favorite channels to a **FAV** (Favorites) list.
- ◆ View signal strength of a currently tuned digital channel.



Captions

- ◆ Display closed captions (if sent by the broadcaster).
- ◆ Select settings for analog or digital captions.



Parental Lock

- ◆ Block or allow programming based on rating signals sent by the broadcast station.
- ◆ Lock the TV by time.
- ◆ Lock the front-panel buttons.



Audio/Video

- ◆ Reset a selected input’s A/V memory to the original factory settings.
- ◆ Customize individual audio and video settings.
- ◆ Display a blue screen when viewing a device with no video signal or a poor video signal.
- ◆ Enable/disable Film Mode.
- ◆ Turn the TV speakers on or off.

Setup Menu

See chapter 3, “TV Setup,” for use of the Setup menu.

NetCommand Menu

The features described in this section are available even if you have not performed NetCommand setup. See chapter 3, “TV Setup,” for options available for NetCommand-controlled devices.

Review TV Connections

(no NetCommand setup required)

Press ▲▼◀▶ to highlight **Review** and press **ENTER** to display the Review screen (see figure 2).

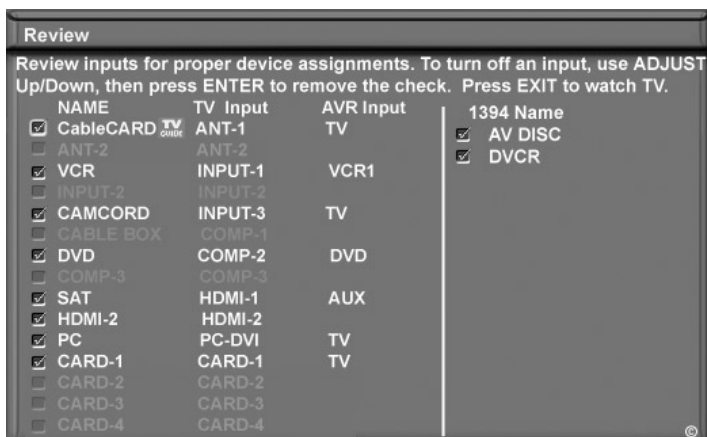

Figure 2. The Review screen lists all TV connections. IEEE 1394 inputs are listed separately on the right.

Input Name Menu

(no NetCommand setup required)

Use the Input Name menu to assign useful labels to the TV inputs that appear in the Input Selection menu. See figures 3 and 4. The current viewing device and any unused inputs appear grayed out and unselectable in the Input Name menu.



Icon for the Input Name menu

Icon for the Icon Order menu

Figure 3. The Input Name menu and Icon Order menu are accessible through the NetCommand menu.



Figure 4. Input Name menu

To rename an input

1. If you are currently watching the input you wish to rename, first change to another input. To do so, press **INPUT** to open the Input Selection menu, highlight a different input, and press **ENTER**.
2. With the Input Name menu displayed, press ◀▶ to move the highlight to the box for the input you wish to rename.
3. Press ▲▼ to select from the following list.

Cable Box
Camcorder
DVD
DVD2

Game
HD Disc
Satellite
VCR

DVR (digital video recorder, recordable DVD)

Only one VCR label is available, so if you have a second VCR connected, leave the name as the default name.

IMPORTANT

It is possible to use the same name for more than one input. To avoid confusion, be sure to use different names for each input.

NetCommand Menu, continued

To Replace One Device with Another on an Input Jack

1. Disconnect the device you wish to remove from the TV.
2. Connect the new device to the vacated jack.
3. Open the Input Name menu from the NetCommand menu.
4. Select a device name from the list for the input.
5. Open the Review screen and confirm the change.

To Remove the Icon for an HDMI Device

When you disconnect an HDMI device, the icon remains in the Input Selection menu until you choose to remove it.

1. In the Input Name menu (see figure 4), highlight the box for the disconnected HDMI input.
2. Press **▲▼** to select **Off**.
3. Press **MENU** to return to the NetCommand menu or press **EXIT** to close all menus.

Icon Order Menu

(no NetCommand setup required)

The Icon Order menu allows you to rearrange the device icons that appear in the Input Selection menu. Change the sequence to put frequently used icons at the start of the list. See figures 3 and 5.

To change the icon order

1. Press **▲▼◀▶** to highlight the icon to be moved and then press **ENTER**.
2. Press **▲▼◀▶** to drag the icon to the desired position. Press **ENTER** to set the new position.

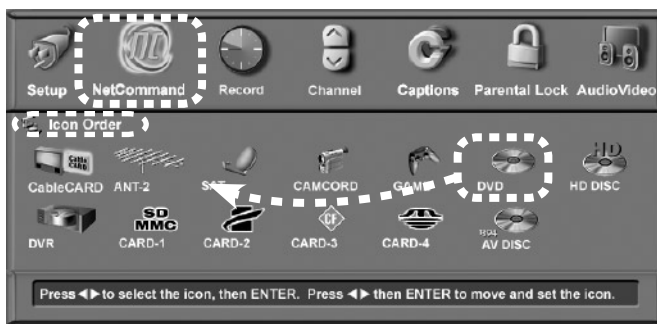

Figure 5. Icon Order menu

Channel Menu

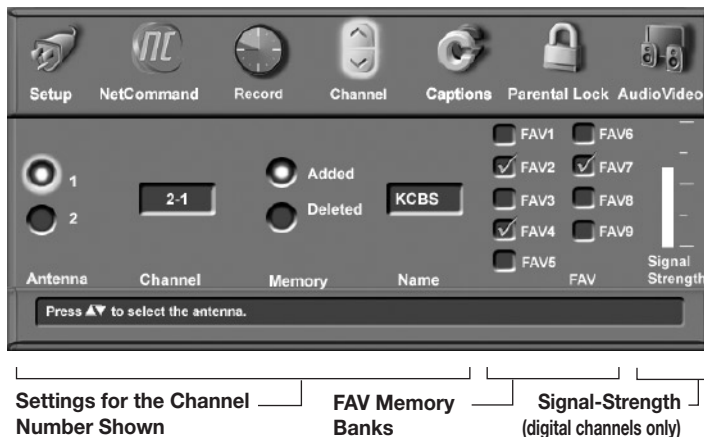

Figure 6. Channel menu

Antenna (Channel Menu)

Select either **1 (ANT 1 MAIN)** or **2 (ANT 2 AUX)** as the antenna source for the channels you wish to edit.

Channel (Channel Menu)

Select the affected channel number (shown in the **Channel** box) in any of three ways:

- Press **CH** \wedge/\vee to select from channels already in memory. If you also wish to tune to the channel, press **ENTER**.
- Highlight the channel box and press $\blacktriangle/\blacktriangledown$ to move through all channel numbers, one at a time. If you also wish to tune to the channel, press **ENTER**.
- Highlight the channel box, enter the number directly, and press **ENTER**. Note that with this method, you must press **ENTER** for the screen to display settings for the selected channel.

Channel numbers can be one part, analog or digital (up to five digits long), or two part for digital channels. For a two-part digital channel, press **CANCEL** on the remote to enter a separator after the first, second, or third number, depending on the broadcaster's channel information.

For digital channels, when the broadcaster has sent a virtual channel number, the virtual channel number is shown in the text box and the original physical digital channel is shown below on screen as a reference. One original channel number can be associated with several different virtual channels.

Memory (Channel Menu)

After the available channels have been memorized with **Memorize Channels** on the Setup menu, you can add weaker channels or delete unwanted channels using this option. For example, if you wish to see only digital chan-

nels listed, use this menu to delete analog channels from memory.

Press **CH** \wedge/\vee to review the channels in memory. Press $\blacktriangle/\blacktriangledown$ to select **Added** or **Deleted** for the channel shown in the **Channel** box.

To Add a New Digital Channel

1. In the channel menu, enter the physical channel number in the **Channel** box, including the sub-channel number; press **CANCEL** ($-/CANCEL$) and then enter the sub-channel number. If no sub-channel is specified, press **CANCEL** and 1.
2. Press **ENTER** to tune to the channel.
3. Highlight the **Added** radio button.

Name

Analog channels from **ANT 1** and **ANT 2** can be named with up to four characters. The name you enter here will appear on the TV screen as part of the on-screen status display. Digital channels may already be named if the broadcaster sends the information.

1. Press a number key repeatedly to cycle through the characters associated with the key. You can also use $\blacktriangle/\blacktriangledown$ to change a highlighted character.
2. Press **ENTER** to set the letter and move to the next letter position. Press **CANCEL** to move back one position.

Note: When the TV Guide On Screen system is enabled, the name displayed is the name sent by the broadcaster instead of the name you assign.

Signal Strength (Channel Menu)

Displays the approximate signal strength of the currently tuned digital channel. Use this indicator to help you adjust the antenna direction for best signal reception. The taller the bar, the stronger the signal. This indicator applies only to digital channels.

To view the effects of antenna adjustments on digital channels, tune to the digital channel you wish to measure while remaining in this menu. To tune to a channel, either:

- Highlight the channel box, press **CH** \wedge/\vee or $\blacktriangle/\blacktriangledown$ to display the desired channel number, and press **ENTER**.
- Enter the channel number on the remote control and press **ENTER**.

Terminology

Virtual Channel Number

A channel number used by a local broadcaster to help you identify their digital channel. Usually this is associated with their traditional analog channel number.

Physical Digital Channel Number

The channel number officially assigned to the actual broadcast frequency.

Channel Menu, continued

FAV (Channel Menu)

The FAV feature lets you store groups of favorite channels in up to nine different FAV memory banks. For example, each household member can store favorite channels in their own bank or you can store groups of channels by content, e.g., news, sports, children's programming, etc. You can store the same channel in multiple FAV banks.

Once you have added a channel to FAV memory, **FAV** and the memory bank number appear under the tuned channel number on the TV screen. You can access the FAV feature through the Channel menu or you can bypass the menu and use only the remote control.

FAV Setup Using the Channel Menu	
Initial Setup of a FAV Bank and Adding FAV Channels Using the Menu	<ol style="list-style-type: none"> 1. With the Channel menu displayed, select a channel using one of the methods described on the preceding page, for example, press CH \wedge/\vee for a memorized channel. 2. Highlight the desired bank (FAV1–FAV9) and press ENTER to check mark the selected FAV memory bank. The channel number displayed has now been added to the checked FAV bank. 3. With the FAV bank still highlighted, press CH \wedge/\vee to display the next channel you wish to add to the FAV bank. 4. Press ENTER to add a check mark next to the highlighted FAV bank. 5. Repeat steps 2–4 for additional channels and FAV banks.
Removing FAV Channels Using the Menu	<ol style="list-style-type: none"> 1. With the Channel menu displayed, press CH \wedge/\vee to display the memorized channel you wish to remove. 2. Highlight the desired FAV memory bank (FAV1–FAV9). 3. Press ENTER to remove the check mark.
Using FAV Channels	
Viewing FAV Banks	<ol style="list-style-type: none"> 1. Press the FAV key. Wait for the TV to tune to a channel in the current FAV bank. 2. Press the FAV key repeatedly to cycle through the channels available in the current FAV bank.
Changing FAV Banks	<ol style="list-style-type: none"> 1. Press the FAV key. Wait for the TV to tune to a channel in the current FAV bank. 2. When tuning is complete and while the TV status display is still visible on screen, press the number key for the desired bank. <p>Note: Wait for the channel change to finish before pressing the number key. Otherwise, the TV may ignore the FAV number.</p>
If No FAV Banks Are Set Up	The FAV key switches to the previously tuned channel; works like the QV key.
FAV Setup Using Only the Remote Control	
Adding FAV Channels	<ol style="list-style-type: none"> 1. While watching TV, tune to the channel you want to add to the current FAV memory bank. See the instructions above if you need to first change to a different FAV bank. 2. Press and hold the FAV button for about 2 seconds. When FAV and the memory bank number appear under the channel number, the channel has been successfully added.
Removing FAV Channels This procedure removes the channel only from the selected bank and leaves the other banks unchanged.	<ol style="list-style-type: none"> 1. While watching TV, press the FAV button 2. While the TV status display is still visible on screen, press the number key for the memory bank. 2. Press the FAV button repeatedly until you see the desired channel. 3. While the channel number and FAV indicator (with correct bank number) are still displayed on the screen, press CANCEL. You must press CANCEL before the indicator disappears. When the FAV indicator disappears, the channel has been successfully removed.

Captions Menu

For analog channels, broadcasters can send either standard closed captions or text service. Standard closed captions follow the dialogue of the characters on screen and display in a small section of the screen. Text-service closed captions often contain information such as weather or news and cover a large portion of the screen.

For digital channels, broadcasters can send up to six different captioning selections or can send analog captions that are the same as those sent by the analog station. Each TV station may broadcast only one or two types of captions or none at all. The TV cannot decode closed captions received on component or HDMI inputs.



Figure 7. Captions menu

Analog Captions

The TV can display one of the following captions for analog sources:

- **CC1, CC2, CC3, or CC4:** standard closed-caption signals
- **Text1, Text2, Text3, or Text4:** Text-service signals
- **On if mute:** Closed captions appear when audio is muted. When selected, press MUTE on the TV remote control to turn on/off the standard closed-caption signal CC1.
- **Off:** No closed captions.

Background

To make the analog closed captions easier to read, you can choose to display the background color as either black or gray behind the text.

IMPORTANT

When analog text closed captioning is selected, a large black or gray box appears on your TV screen if no signal is broadcast.

Digital Captions

The following display options are available for digital sources:

- **Captions 1–6:** Sent by broadcaster.
- **On if Mute:** Closed captions are displayed when audio is muted. When selected, press MUTE on the TV remote control to turn captioning on/off (Caption 1).

- **Off:** No closed captions.

Note: For digital programs, if the broadcaster is sending only analog captions converted to digital format, then the analog caption settings apply.

Appearance

The closed-captions provider selects the default options when sending digital closed captions. Select **Custom** to override defaults and customize the appearance of closed captions. These settings do not apply to analog closed captioning converted to digital.

Digital Settings

The Digital Settings menu allows you to customize the appearance of the closed captions sent by the broadcaster. Digital settings do not apply to analog closed captions converted to digital.

To open the Digital Settings menu, select **Custom** for the **Appearance** option. Move the highlight to the **Digital Settings** icon and press ENTER.

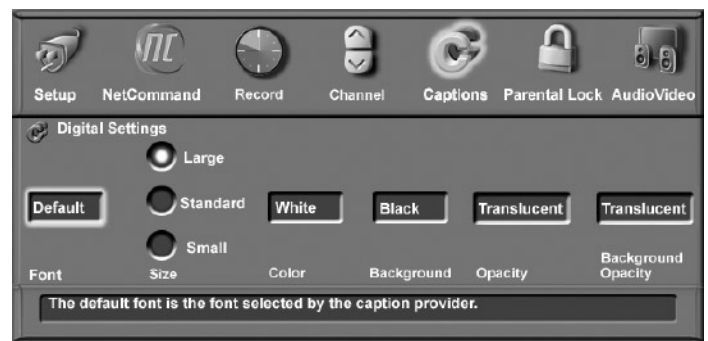

Figure 8. Closed Captions, Digital Settings sub-menu

Font

The available font options are as follows:

- **Default:** Selected by the closed-captions provider
- **Font 1:** Monospaced font with serifs
- **Font 2:** Proportionally spaced font with serifs
- **Font 3:** Monospaced font without serifs
- **Font 4:** Proportionally spaced without serifs
- **Font 5:** Casual font
- **Font 6:** Curative font
- **Font 7:** Small capitals

Captions Menu, continued

Size

Select the desired font size. Large is the recommended font size.

Color

The available font colors are listed below. Text and background cannot be set to the same color.

White	Yellow
Black	Green
Magenta	Cyan
Red	Blue

Background

You can change the background color to make the digital closed captions easier to read. The available background colors are listed below. Text and background cannot be set to the same color.

White	Yellow
Black	Green
Magenta	Cyan
Red	Blue

Opacity (Font)

You can customize the visibility of your fonts using the following settings:

- **Translucent:** TV program is dimmed behind the text
- **Transparent:** Invisible text reveals the TV program behind.
- **Opaque:** Solid text blocks view of the TV program
- **Flashing:** Text flashes at intervals

Background Opacity

You can customize the background for digital captions using the following settings:

- **Translucent:** TV program is dimmed behind the background
- **Transparent:** No visible background
- **Opaque:** Solid background covers TV program
- **Flashing:** Background flashes at intervals

IMPORTANT

Mitsubishi recommends you use contrasting colors for captions and background. Black translucent background combined with a white font makes an easy-to-read combination.

Use care when selecting custom colors. Your choice may affect the readability of captions.

IMPORTANT

The content of captions is determined by the broadcaster. If your captions show strange characters, misspellings, or odd grammar, it is not a malfunction of the TV.

Parental Lock Menu

The Parental Lock menu gives you control over three different types of parental controls. You must use a pass code to open this menu to enable/disable the lock options. The three parental controls available are:

- **Ratings (U.S. Ratings/Other Ratings)**
V-Chip technology lets you restrict access to programming based on program-rating signals sent by the broadcaster. For U.S. ratings, you can also set the time of day for these restrictions to be in effect.
- **Lock by Time**
Lets you restrict TV use by time of day.
- **Front Panel Lock**
Lets you disable the controls on the front of the TV. Use this option if there are small children near the TV who may be tempted to press the buttons.

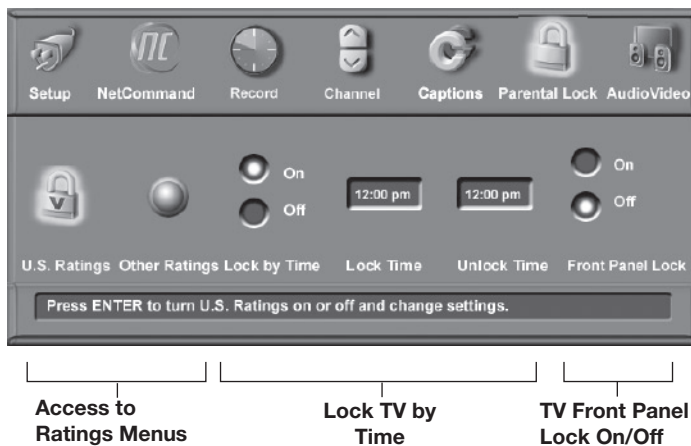

Figure 9. Parental Lock menu

Setting a Pass Code

You are prompted to enter a pass code whenever you select Parental Lock on the Main menu. To set a pass code for the first time:

1. Press **MENU**, highlight **Parental Lock**, then press **ENTER**. A screen prompting you for a pass code will display.
2. Input a four-digit pass code using the number keys on the remote control.
 - Press **CANCEL** to delete a number and move back one space.
 - Press **MENU** or **EXIT** to close the menu without setting a pass code.
3. Press **ENTER** to set the pass code just input.

To reset the pass code, see the procedure in Appendix A.

IMPORTANT

If you forget your four-digit pass code, see Appendix A.

Lock TV by Time and Front-Panel Lock

Lock by Time (Parental Lock Menu)

Lock by Time allows you to block all use of the TV during specified hours. During the lock time, you must use your pass code to view the TV. To lock the TV by time:

1. Press **▲▼** to select **On** or **Off** for **Lock by Time**.
2. Press **▶** to move to the **Lock Time** box.
 - a. With the hour number highlighted in yellow, press **▲▼** repeatedly to change the hour and associated **AM/PM indicator**. You can also just press and hold to change the hour.
 - b. Press **ENTER** to move the highlight to the minutes.
 - c. With the minutes number highlighted in yellow, press **▲▼** repeatedly to change the minutes. Just press and hold to move quickly through the numbers.
 - d. Press **▶** to move to the **Unlock Time** and set the time as described above.

NOTE: To make **Lock by Time** active 24 hours a day, set **Lock** and **Unlock** to the same time.

Front Panel Lock (Parental Lock Menu)

Front Panel Lock lets you disable controls on the front panel to prevent inadvertent changes to TV settings. Select **On** to disable the buttons and select **Off** to restore their operation.

To release the front button lock without using the remote control:

- When Energy Mode is set to **Fast Power On**, press and hold the **MENU** button on the front panel for over eight seconds. If the TV is on, a message will display confirming release of the Front Panel Lock.
- When Energy Mode is set to **Low Power**, press **POWER** on the front panel to turn on the TV. Press and hold the **MENU** button on the front panel for over eight seconds.

Rating Menus

The rating menus allow you to:

- Turn rating restrictions on or off
- Change the permitted rating level
- Set the time of day to enforce rating restrictions (U.S. ratings only)

The TV comes from the factory with pre-set U.S. V-Chip ratings and with the rating locks turned off. The pre-set ratings are TV rating TV-PG and movie rating PG. If you turn on V-Chip blocking, these presets allow only programs rated TV-PG/PG or lower until you change the rating level.

After changing the channel or device, there may be a delay of up to five seconds before the rating restrictions take effect.

Parental Lock Menu, continued

U.S. Ratings Menu

Use this menu to turn U.S. rating restrictions on or off and to change the permitted rating levels.

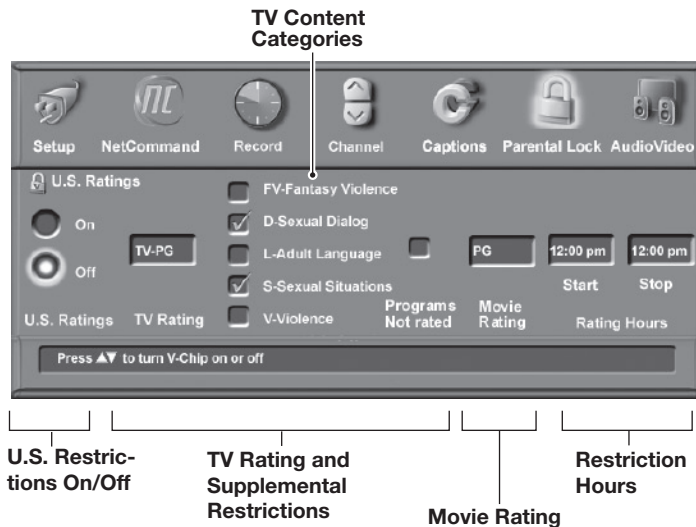



Figure 10. U.S. Ratings menu

1. Highlight the **U.S. Ratings** icon  on the Parental Lock menu (see figure 9) and press **ENTER** to open the U.S. Ratings menu (see figure 10).
2. Press **▲▼** to select **On** or **Off**.
3. If you selected **On**, press **▶** to move to the **TV Rating** box.
4. Press **▲▼** to select the TV rating level you want to allow.
5. Press **▶** to move to the TV content categories. This section allows you to specify content blocking in addition to that blocked by the TV rating. See the section on V-Chip ratings for an explanation of TV content categories.
 - Press **▲▼** to move the highlight among the categories.
 - Press **ENTER** to add or remove a check mark for each TV content category you want to block or unblock.
6. Press **▶** to move to the **Programs Not Rated** box. Press **ENTER** to add or remove a check mark for blocking or allowing programs that are not rated.

Note: Use care when choosing to block unrated programming. News programs and emergency bulletins carry the “None” or “NR” (Not Rated) V-Chip signal, and they are blocked with this option active.

7. Press **▶** to move to the **Movie Rating** box. Press **▲▼** to select the movie rating level you want to allow. Detailed information on rating guidelines follows this discussion of the Parental Lock menu.

8. To set the time of day for these restrictions to be in effect, press **▶** to move to the **Start** box. To make the rating restrictions active twenty-four hours a day, set **Start** and **Stop** to the same time. To set the time:
 - a. With the hour number highlighted in yellow, press **▲▼** repeatedly to change the hour. You can also just press and hold to change the hour.
 - b. Press **ENTER** to move the highlight to the minutes.
 - c. With the minutes number highlighted in yellow, press **▲▼** repeatedly to change the minutes. Just press and hold to move quickly through the numbers.
 - d. Repeat these steps for the **Stop** time.
9. Press **MENU** to return to the Parental Lock menu or press **EXIT** to close all menus.

Other Ratings Menu

This TV can recognize new rating systems that may come into effect in the future. The Other Ratings menu allows you to block digital programming based on such alternate rating systems. The alternate rating systems will apply to digital broadcast programming only.

Note: The **Other Ratings** button remains inaccessible until the TV receives signals for an alternate rating system.

The first time you tune to a channel broadcasting an alternate rating system, the TV defaults to the most restrictive setting. Use this menu to change the allowed rating if you are unable to watch a program broadcast with an alternate system.



Figure 11. The Other Ratings menu is available only if the TV receives broadcast signals carrying an alternate rating system.

IMPORTANT

New rating systems recognizable by the TV may be new U.S.-based systems not included in the original V-Chip rating system. The use of “Canadian” in the sample screen is just one possibility.

Parental Lock Menu, continued

1. Highlight the button labelled **Other Ratings** on the Parental Lock menu (see figure 9) and press **ENTER** to open the Other Ratings menu (see figure 11).
2. Press **▲ ▼** to select **On** or **Off**.
3. If you selected **On**, press **▶** to move to the **Rating Group** box.
Note that you can change settings only for the rating system available on the currently tuned channel. In the figure above, for example, the Canadian rating system is in effect. To change settings at a later time for the Canadian rating system, you must again tune to a channel broadcasting the Canadian system.
4. Press **▲ ▼** to select from the subgroups available for the rating system—**English** or **French** in this example.
5. Press **▶** to move to the **Rating** box.
6. Press **▲ ▼** to select the program rating level you want to block.
7. Press **ENTER** to add a check mark to indicate blocking is in effect for the rating. When a rating shows a check

mark, press **ENTER** to remove the check mark and allow programs with this rating.

8. Repeat steps 3 through 7 for each additional rating system you would like to set up.
9. Press **MENU** to return to the Parental Lock menu or press **EXIT** to close all menus.

Bypassing the Ratings Lock and Lock by Time

If you try to watch blocked programming, a notice appears prompting you for a pass code. To use the TV:

- Input your four-digit pass code and press **ENTER**.
- Change to a channel airing an allowed program or change to another device.

If you try to use the TV when it is locked by time, a similar screen appears, prompting you for your pass code.

To reactivate the rating lock or TV Lock by Time after using the pass code, power the TV off and then on.

V-Chip Signal Information

When provided by the broadcaster or program source, V-Chip ratings let you control the types of programming that can be viewed on the TV. When V-Chip ratings are supplied, they are displayed when you change the channel or press **INFO** on the remote control.

TV Ratings

TV ratings apply to TV programs and made-for-TV movies. You can apply supplemental blocking to TV ratings based on the TV content categories described below. TV ratings are:

- TV-Y** Youth. For children under the age of 7.
- TV-Y7** Youth 7 and older.
- TV-G** General Audience. For the entire family to view.
- TV-PG** Parental Guidance. Parental Guidance is recommended; may not be suitable for some children.
- TV-14** Adolescent 14 and older. Not recommended for children under the age of 14.
- TV-MA** Mature Audience. For adults only.

TV Content Categories

Used in association with the TV ratings above, TV content categories allow you to apply supplemental blocking. Apply supplemental blocking using the U.S. Ratings menu.

- FV Fantasy Violence.** Applies to TV-Y7 only.
- D Sexual Dialog.** Applies in different degrees to TV-PG and TV-14.
- L Adult Language.** Applies in differing degrees to TV-PG, TV-14, and TV-MA.
- S Sexual Situations.** Applies in differing degrees to TV-PG, TV-14, and TV-MA.
- V Violence** (graphic or realistic). Applies in differing degrees to TV-PG, TV-14, and TV-MA.

TV Rating	FV	D	L	S	V
TV-Y	<i>Not Applicable</i>				
TV-Y7	X	<i>Not Applicable</i>			
TV-PG	<i>Not Applicable</i>	X	X	X	X
TV-14	<i>Applicable</i>	X	X	X	X
TV-MA	<i>Applicable</i>	X		X	X

TV content categories. Boxes marked with an "X" indicate supplemental blocking you can apply to each rating level.

The TV rating you select is for the least-restrictive program level allowed. For example, if you select TV-PG, programs rated TV-Y, TV-Y7, and TV-PG can be viewed, but programs rated TV-14 and TV-MA are blocked.

When you select a TV content category to block, all TV programs with the same content category listing are blocked. For example, if you select to block V (Violence) at the TV-14 level, any programs with the V category listing rated TV-PG are also blocked.

V-CHIP EXCEPTIONS

- V-Chip blocking is ineffective for programs viewed on devices connected to component or HDMI inputs. Many of these devices, however, have their own parental-control systems.
- Videotapes, laser discs, and DVDs may not contain V-Chip rating signals. V-Chip cannot block playback of recordings without V-Chip rating signals.
- Broadcasters are not currently required to include V-Chip rating signals. V-Chip cannot block programming broadcast without the V-Chip rating signal.

Movie Ratings

Movie ratings are the MPAA ratings used for theater-released and direct-to-video movies. Movie ratings are:

- G General Audience.** Designed for the entire family to view.
- PG Parental Guidance.** Parental Guidance is recommended, may not be suitable for some children.
- PG-13 Parental Guidance, 13 and Older.** Not recommended for children under the age of 13.
- R Restricted.** Restricted in theaters to 17 years old and older unless accompanied by an adult.
- NC-17 No Children 17 or Under.** Restricted in theaters to 18 years old and older.
- X Adult.** Designed for and restricted in theaters to adult audiences only.

The movie rating you select is for the least-restrictive program level that can be viewed. For example, if you select the PG-13 rating, movies rated G, PG and PG-13 can be watched, but movies rated R, NC-17, and X are blocked.

Programs Not Rated: This refers to programs that carry no rating, such as news, sports, weather, emergency bulletins, or movies prior to or without MPAA ratings. This does not include programs without V-Chip signals.

IMPORTANT

If you enable blocking with the Programs Not Rated option, you may block news or emergency bulletins carrying the "None" or "NR" Not Rated V-Chip rating. Use care when blocking programming that is not rated.

Audio/Video Menu

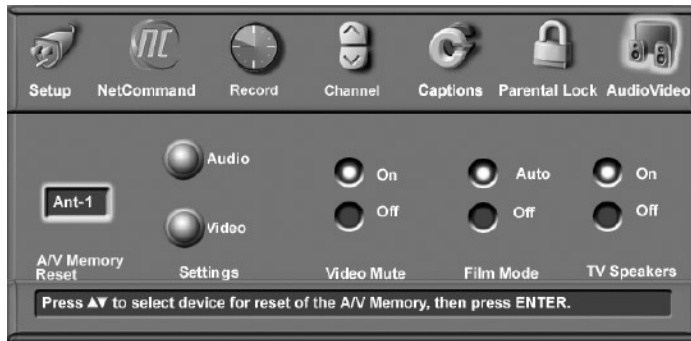

Figure 12. Audio/Video Menu

A/V Memory Reset

A/V Memory Reset allows you to reset a specific input's A/V settings to the original factory settings. Highlight the box and press ▲▼ to select the input name. Next press ENTER.

The audio settings of **Balance**, **Listen to**, and **Language** are general TV settings unaffected by A/V Memory Reset.

To reset all A/V settings at once, including the three general settings, perform an A/V Reset by pressing the front-panel buttons **GUIDE** and **FORMAT** simultaneously.

Settings (Audio and Video)

Each input or device has its own A/V memory. Press ▲▼ to select the input or device in the **A/V Memory Reset** box, then select **Audio** or **Video** to adjust individual settings. Press ENTER to close the menu and display the individual settings.

Use ▲▼ to cycle through the individual settings. Use ◀▶ to change the setting values. Press EXIT to return to normal TV viewing. For descriptions of the individual A/V settings, see the following pages.

Video Mute

The default is **On**, which displays a blue background when no signal is being received on the **INPUT**, **COMPONENT**, or **HDMI** jacks.

Film Mode (480i signals only)

Auto is the default setting. With **Auto** selected, the TV automatically detects and applies film-decoding correction for images that originated on 24-frame-per-second film cameras and were converted to 30-frame-per-second video for broadcast (3:2 pulldown conversion). Try the **Off** setting if the TV adds noticeable jagged edges to the images.

When the original video was filmed on 30-frame-per-second cameras, the **Auto** setting automatically applies video decoding, the same as used with the **Off** setting.

Film Mode is not effective for high-definition signals.

TV Speakers

This selection turns the TV's internal speakers on or off. Select **Off**:

- When sending the sound through a separate sound system or surround sound A/V receiver.
- If your A/V receiver is under NetCommand control

Note: To prevent damage from a sudden increase in volume, turn the TV volume down low before changing this option to **On**.

Audio/Video Settings and the Remote Control

To adjust individual audio or video settings directly with the remote control:

1. Press **AUDIO** or **VIDEO** repeatedly to cycle through the available settings.
2. Press ◀▶ to adjust the setting. The setting display will disappear after five seconds of inactivity.

Audio Settings

Analog and Digital Audio Settings

Enter the audio adjustment mode using either the Audio/Video menu or the **AUDIO** key. Use ◀▶ to change settings. Some adjustable settings display a slider and corresponding numeric value on screen. Values can be adjusted from 0 to 63, with 31 as the midpoint.

Note: The effects of the audio settings of **Bass**, **Treble**, **Balance**, and **Surround** affect only the sound heard through the TV speakers.

◇ Bass

Enhances or reduces low-pitched sound.

◇ Treble

Enhances or reduces high-pitched sound.

◇ Balance

Adjusts the level of sound between the left and right TV speakers.

◇ Surround

Creates simulated stereo and surround effects through the TV speakers. Your choices are:

- **Off:** No surround effects (default).
- **Simulated Stereo:** The TV creates a simulated stereo effect when watching a non-stereo program.
- **Surround Sound:** The TV creates a simulated surround effect when watching a stereo program.

◇ Level Sound

When on, automatically equalizes the volume level when there are significant sound-level differences between program segments, such as between regular programming and commercials.

Audio/Video Menu, continued

- To receive the best fidelity with music programs, change this setting to **Off**.
- When connecting to an A/V receiver, set **Level Sound** to **Off** and turn off the TV speakers to send full dynamics to the A/V receiver.

Analog-Only Audio Settings

You can set analog-only audio settings while viewing either analog or digital sources, but the settings affect only broadcast analog content.

◊ Listen To

Determines how your TV receives a broadcast audio signal and plays the sound you hear.

Your choices are:

- **Stereo**: Default setting. The TV plays stereo broadcasts in stereo and mono broadcasts in mono. The word **Stereo** is displayed when you tune to a channel broadcasting in stereo.
- **SAP** (Second Audio Program): Additional mono-aural sound track that you cannot hear during normal TV viewing. The SAP signal might be related to the program you are watching, (such as a sound track in a foreign language), or it might be unrelated (such as a weather report). If an SAP signal is broadcast, the letters **SAP** are displayed when you tune to the channel.
- **Mono**: Reduces background noise. Use when receiving a weak stereo audio signal. All audio is played mono with this setting.

Listen To is not available for 1394 devices or devices connected to the **INPUT**, **COMPONENT** and **HDMI** jacks.

Digital-Only Audio Settings

You can set digital-only audio settings while viewing either analog or digital sources, but the settings affect only broadcast digital content.

◊ Language

Determines what possible language you can hear. The **Language** option is available for IEEE 1394 devices but not for devices connected to the **INPUT**, **COMPONENT**, and **HDMI** jacks. Language choices are:

English	Portuguese
French	Spanish
German	Other
Italian	

IEEE 1394 Amplifier Settings

◊ Balance

Adjusts the level of sound between the left and right speakers. The slider range is 0–254, with 127 as the midpoint.

◊ Loudness

When on, makes the audio level more uniform.

◊ Preset

Select the mode that matches the audio source. Your choices are:

Off	Classical Music
Jazz	Movie
Rock	Speech

◊ Equalizer

Equalizes the sound.

Audio/Video Menu, continued

Video Settings

Enter the video adjustment mode using either the Audio/Video menu or the **VIDEO** key. Press the **VIDEO** key repeatedly to cycle through the video options to the one you want to change. Use ◀ ▶ to change settings.

Note: A slider displays on screen for some settings. When the slider is displayed, it represents numeric values, with 63 as the maximum, 31 as the mid-point, and 0 as the minimum.

◇ **Picture Mode:** Set the Picture Mode first before adjusting other settings, as each Picture Mode stores its own values for Contrast, Brightness, and Color Temperature. Picture Modes allow you to optimize the image for different lighting conditions. The Picture Modes are:

- **Bright:** Suited for most daytime viewing.
- **Natural:** Suited for most nighttime viewing.
- **Brilliant:** The default setting. For use under strong light.

◇ **Contrast** (Bright/Natural/Brilliant): Provides a slider to adjust the white-to-black level. Low contrast shows a variety of shades in darker images, while high contrast shows darker images more uniformly black and makes colors appear more vibrant. In most home lighting situations, a medium contrast looks best. High contrast is good for brightly lit environments.

◇ **Brightness** (Bright/Natural/Brilliant): Provides a slider to adjust the overall brightness of the picture.

◇ **Color:** Provides a slider to adjust color intensity.

◇ **Tint:** Provides a slider to adjust the red-to-green ratio.

◇ **Sharpness:** Provides a slider to adjust the detail and clarity.

◇ **Color Temperature** (Bright/Natural/Brilliant): Allows you to adjust how white is displayed.

- **Low:** White images have a warm cast. This adjustment is an average and can vary due to ambient room lighting, video scene brightness, and the TV's age. Natural/Color Temp at the low setting displays video at the 6500K industry standard for NTSC pictures.
- **High:** White images have a cool cast. This setting may provide the most realistic picture under bright lighting.

◇ **PerfectColor™:** Lets you adjust the intensity of any or all of six colors (Magenta, Red, Yellow, Green, Cyan and Blue) to create color balance for the current image source. PerfectColor settings are memorized for each TV input or device.

Select the **PerfectColor** option and press **ENTER** to open the adjustment screen.

Individual sliders for each color are displayed. Press ▲ ▼ to move from one color to the next. Highlighted text shows which slider you are adjusting. Press ◀ ▶ to change settings. Press **CANCEL** while in the PerfectColor screen to reset all colors to the default settings.

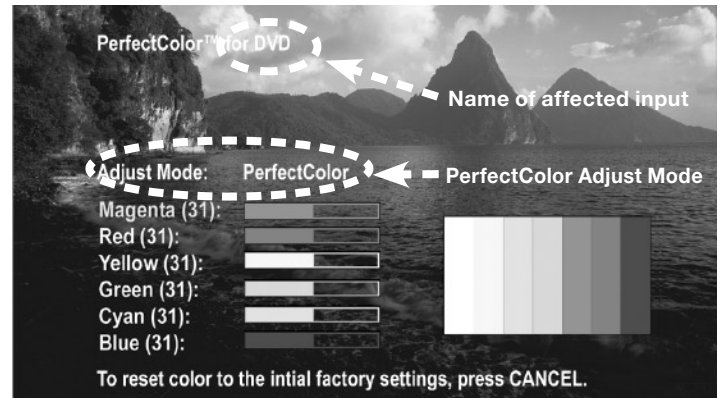

Figure 13. Set PerfectColor adjustments independently for each TV input.

◇ **PerfectTint™ (models WD-57732, WD-65732, WD-73732):** Provides further color refinement using six color sliders memorized for each input. To use PerfectTint:

1. With the PerfectColor screen displayed and with **Adjust Mode** highlighted in yellow characters, press ▶ to open the PerfectTint screen.
2. Press ▲ ▼ to move from one color to the next. Press ◀ ▶ to change settings. Press **CANCEL** to reset to the default settings.
3. To return to PerfectColor, highlight **Adjust Mode** in yellow characters and press ◀.

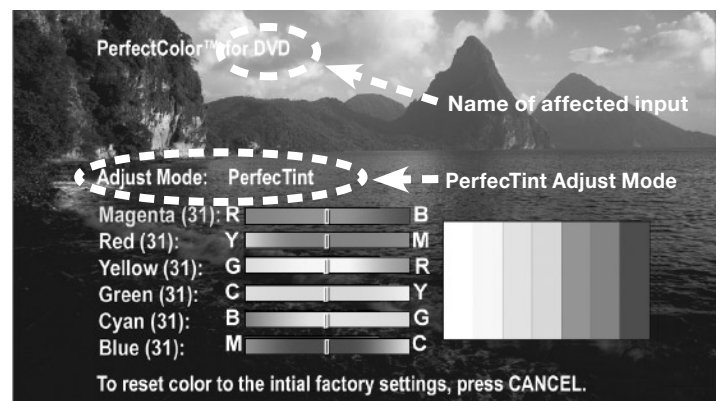

Figure 14. PerfectTint adjustments for each TV input let you further refine color adjustments..

◇ **Video Noise:** Reduces minor noise (graininess) in the picture. Use the **Low** setting with good-quality signals. Use **High** with poor-quality signals. Turn off to leave the picture unaltered.

Audio/Video Menu, continued

- ◇ **DeepField™ Imager (models WD-57732, WD-65732, WD-73732):** When **On** is selected, the black levels are dynamically enhanced in portions of the screen to provide strong contrast with detail over mixed screen content. When **Off** is selected, the entire screen adjusts the contrast the same. When **Demo** is selected, a split screen picture appears and you can see how the picture will look when DeepField Imager is on (right side) or when it is off (left side).
- ◇ **SharpEdge™ (models WD-57732, WD-65732, WD-73732):** When **On** is selected, special edge sharpness enhancements are applied to the vertical edges of images.
- ◇ **PerfectColor™.** The adjustment screen displays without the vertical color bars when used for a computer image.
- ◇ **PerfectTint™ (models WD-57732, WD-65732, WD-73732)**
- ◇ **Auto Position:** Press **ENTER** to automatically center the position of the PC video.
- ◇ **HorizPosition (Horizontal Position):** Manually adjust the horizontal position of PC video. This selection overrides the Auto Position selection.
- ◇ **VertPosition (Vertical Position):** Manually adjust the vertical position of PC video. This selection overrides the Auto Position selection.
- ◇ **Fine Detail:** Manually adjust the picture quality of PC video, analog signals only. This selection overrides the Auto Position selection.

Personal Computer Video Settings

Video settings available for images from a personal computer are:

- ◇ **Contrast**
- ◇ **Brightness**

NetCommand Functions

NetCommand-Controlled Devices and the Input Selection Menu . .	78
NetCommand-Controlled Recording.	79
Using IEEE 1394 Devices	83

NetCommand-Controlled Devices and the Input Selection Menu

For devices under NetCommand control, the Input Selection menu allows you to:

- Select the device for viewing
- Switch audio between the TV speakers and A/V receiver
- Power compatible devices on or off
- Verify the destination of signals.

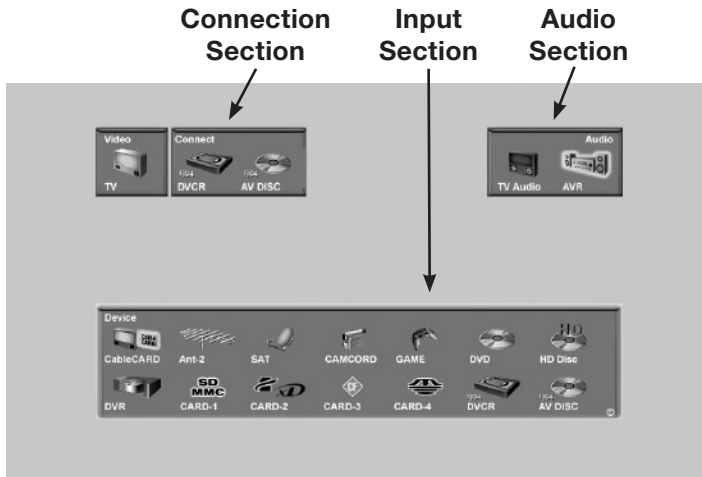

Figure 1. The Input selection menu for a NetCommand-controlled device.

Input Section

Press ▲▼◀▶ to highlight an input icon and press ENTER to select the input to view and hear. “Learned” inputs on a compatible A/V receiver are automatically changed at the same time.

Connection Section

The Connection section shows if there is a recording in progress and the device that is recording from the source. For example, if the Digital VCR (D-VCR) is currently recording from **ANT 1**, when you move the highlight to the Ant-1 icon, the D-VCR icon appears in the Connection Section. This icon disappears when you move the highlight to another icon or press CANCEL to stop recording.

Audio Section

A NetCommand-controlled A/V receiver connected to the TV appears as an **AVR** icon in the Audio section. Press AUDIO to change navigation to the Audio section. Then press ◀▶ to select either the TV speakers icon or the A/V receiver icon. Press ENTER to change the audio selection. Press INPUT to return navigation to the Input section.

The Remote Control and NetCommand

Point the TV’s remote control at the TV when operating NetCommand-controlled devices. See the chart in chapter 3, “TV Setup,” to review device functions you can “learn” for the device. Further information on some functions is included here.

The Input Selection Menu and NetCommand

Power Devices On/Off

First “learn” the power key(s) for the device. Press INPUT to display the Input Selection menu. If you press POWER without first displaying the Input Selection menu, the TV will turn off.

- **Devices with separate ON and OFF remote control keys.** These devices power on automatically when you select the device in the Input Selection menu and will power off when you turn off the TV.
- **Devices that do not power on or off automatically.** To power on: Highlight the device icon in the Input Selection menu and press POWER. Press ENTER to select the device. To power off: Press INPUT to open the Input Selection menu and highlight the device icon. Press POWER on the TV’s remote control.
- **A/V receiver.** Open the Input Selection menu and press AUDIO to move navigation to the Audio section. Highlight the A/V receiver icon and press POWER on the TV’s remote control.

Additional Functions

Highlight the device icon in the Input Selection menu and press ENTER to select the device. Re-open the Input Selection menu and press the “learned” key indicated in the table below.

“Learned” Key for the Device	Action
MENU	Close Split Screen beforehand, if active. Press MENU to open the device’s menu. Use ▲▼◀▶ to navigate the menu.
GUIDE (“Learned” to change VCR inputs)	Press GUIDE repeatedly to cycle through the VCR’s inputs.

IMPORTANT

If a device does not respond to separate ON or OFF signals from the remote control, the manufacturer has not provided that capability for the device.

NetCommand-Controlled Recording

This section describes making recordings independently of the TV Guide On Screen system. For instructions on setting up recordings using TV Guide On Screen, see the separate *TV Guide On Screen® Interactive Program Guide User's Manual*.

Recording from the Recording Setup Menu

You can schedule the recording to take place at a later time and program the recording duration for a minimum of 30 minutes and a maximum of six hours (in 30-minute increments). The default is one hour. During the recording, you can view a different device or power off the TV.

Immediate Recording from the Menu

1. Press **RECORD** to open the Recording Setup menu.

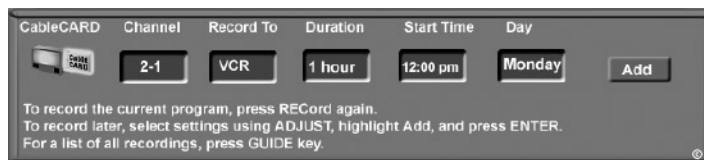

Figure 2. The Recording Setup menu

2. Review the recording setup information. Move the highlight to each box you need to change.
 - With the leftmost icon highlighted (the source), press **▲▼** to change the source input if needed.
 - **Channel.** If the source is an antenna, select a memorized channel using **▲▼**, **CH ▲/▼**, or enter the channel number from the remote control and press **ENTER**.
 - **Record To.** If you have more than one recordable device connected, use **▲▼** to select it from the list in the **Record To** box.
 - **Duration.** Use **▲▼** to select a recording duration of from 30 minutes to six hours in 30-minute increments. The default is one hour.
3. Press **RECORD** a second time to start recording.

Time-Delayed Recording from the Menu

1. Ensure that TV Energy Mode is set to **Fast Power On** and the TV clock is set to the correct time and day. Use the Setup menu to make changes.
2. Press **RECORD** to open the Recording Setup menu.
3. Review the recording setup information. To change the source, recording device, or duration, follow the steps described above under "Recording Now."
4. Specify when to start the recording.
 - **Start Time**
 - a. With the hour highlighted in gold characters, press **▲▼** to select the hour, including **AM** or **PM**. Press **ENTER** to move the highlight to the minutes.

- b. With the minutes highlighted, press **▲▼** to select the minutes.
- **Day.** Use **▲▼** to select a day of the week.
5. Select **Add** and press **ENTER** to add the recording to the Record List. A confirmation message will be displayed if your selection is successful. If you pick overlapping times, day(s), or destination devices, you will see a message stating there is a conflict.
 6. While the Recording Setup menu is displayed, press **GUIDE** to display the Record List (see figure 3). In the Record List you can view a list of scheduled recordings and verify the addition of the recording to the schedule. A maximum of 32 recordings can be scheduled.
 7. From the Record List you can:
 - Press **CANCEL** to delete a recording from the schedule.
 - Press **GUIDE** to return to the Recording Setup menu.
 - Press **EXIT** to return to TV viewing.
 - Press **MENU** to return to the Main menu.

Record List				
The list of recordings for the next week. To cancel a recording, select the recording with the ADJUST keys, then press the CANCEL key. Press the GUIDE key to return to the Record Setup.				
Day	Start	Duration	Device	Record To
Monday	8:00 pm	1 hour	Ant-1 5-1	VCR
Tuesday	8:00 pm	1 hour	Ant-1 2	VCR
Every Wed	8:00 pm	30 min	Ant-1 2	VCR
Wed	9:00 pm	1 hour	Ant-1 4	VCR
Thursday	8:00 pm	1 hour	DSS	VCR
Thursday	9 :00pm	1 hour	Ant-1 7	DVCR
Friday	8:00 pm	30 min	Ant-2 2	AV Disc
Every Sat	11:30 pm	1 hour 30 min	Ant-1 4-1	VCR

Figure 3. Record List screen. From the Record menu, press **GUIDE** to open the Record List to review or cancel scheduled recordings.

TV Guide On Screen® and the Record List

Programs scheduled through TV Guide On Screen do not appear in the Record List. Refer to the separate *TV Guide On Screen® Interactive Program Guide User's Manual* for information regarding scheduling recordings with TV Guide On Screen.

If there is a conflict between a recording scheduled through TV Guide On Screen and the Record List, the TV Guide On Screen recording takes priority.

Recording from the ChannelView™ Channel Guide

ChannelView™ is available when TV Guide On Screen is disabled. ChannelView provides program listings, as sent by the broadcasters, for memorized channels on **ANT 1** and **ANT 2**. Press the **GUIDE** key while watching **ANT 1** or **ANT 2** to view ChannelView listings and to set up immediate or future recordings as described here.

NetCommand-Controlled Recording, continued

Immediate Recording from ChannelView

1. Press **INPUT** to open the Input Selection menu. Highlight an **ANT 1** or **ANT 2** program source and press **ENTER**.
2. Press **GUIDE** to open the ChannelView channel guide for the current antenna input.
3. Use **▲▼** to highlight the channel and program you wish to record from the list of channels.
4. Press **RECORD**. The TV will tune to the channel if needed.
A red “R” temporarily displays next to the program listing to indicate the program will be recorded.
5. Press **EXIT** to return to TV viewing.

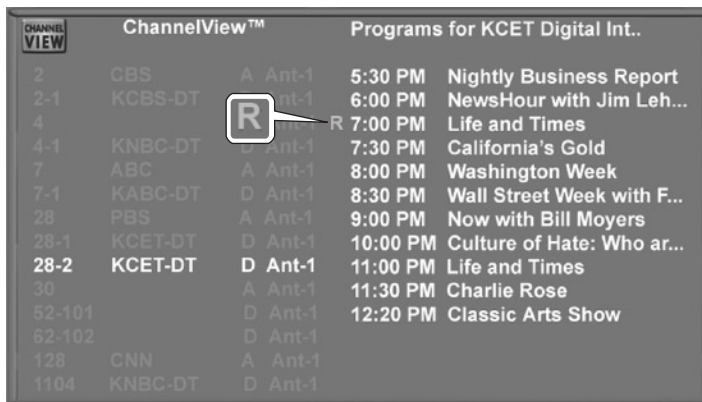

Figure 4. A red “R” appears briefly in the ChannelView screen to indicate a scheduled recording.

Time-Delayed Recording from ChannelView

Set Up the Recording

1. Ensure that TV Energy Mode is set to **Fast Power On** and the TV clock is set to the correct time and day. See “Setup Menu” in chapter 3, “TV Setup.”
2. Perform steps 1 and 2 described above.
3. Press **▲▼** to highlight the source channel from which you wish to record.
4. Press **▶** to view a list of future programs on that channel.
5. Press **▲▼** to highlight a future program.
6. Press **RECORD**.
A red “R” temporarily displays next to the program listing to indicate the program will be recorded. You can schedule a maximum of 32 recordings.
7. Press **EXIT** to close the menu.

Confirm the Recording Setup

1. Press **RECORD** to open the Record menu.

2. Press **GUIDE** to open the Record List (figure 2) and view all scheduled recordings. Press **CH ▲/▼** to page quickly through the list.
3. Verify that the program you wish to record appears in the list.
4. Press **EXIT** to close the menu.

Canceling Recordings

To Cancel a Recording in Progress

1. Press **INPUT** to open the Input Selection menu.
2. Move the highlight to the source input icon. There is no need to press **ENTER**.
The Input Selection menu displays an icon for an active recording connection. See the connection icon in figure 5.
3. Press **CANCEL**. The connection icon will disappear to indicate termination of the recording connection.
4. Press **EXIT** to return to TV viewing.

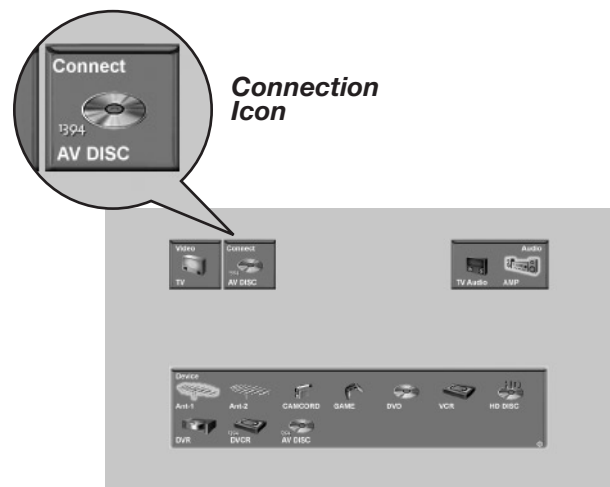

Figure 5. The Input Selection menu displays an icon for the destination device of a recording in progress.

To Cancel a Scheduled Recording

1. Press **RECORD** to open the Record menu.
2. Press **GUIDE** to open the Record List (figure 2) and view all scheduled recordings. Press **CH ▲/▼** to page quickly through the list.
3. Highlight the program you wish to remove from the Record List and press **CANCEL**.
4. Press **EXIT** to close the menu.

NetCommand-Controlled Recording, continued

Record Menu: Setting Recording Defaults

The Record menu allows you to set defaults for your recording devices, set up recordings, view the Record List, and cancel scheduled recordings. Highlight the Record icon on the Main menu to view the Record menu.



Figure 6. Record menu

Record Setup

Highlight **Record Setup** and press **ENTER** to display the Recording Setup menu, described earlier.

Record List

Highlight **Record List** and press **ENTER** to display the Record List, described earlier in this chapter.

Default Digital (Recording) Device

If you have more than one digital recording device connected, this option lets you specify which to use as the default. The device specified here is the digital recording device to use when initiating a recording with the  (**RECORD**) key from within ChannelView™.

This option remains grayed out (unavailable) until you connect a digital recording device. After the device is detected and named, highlight the box and press **▲▼** to select the recording device.

Note that digital programs can be recorded on either a digital or analog device. For best playback quality, however, record digital programs on a digital recording device.

Analog Recordings

When you record a 16:9 digital channel to an analog VCR or recording device, there is a mismatch between the 16:9 ratio of the picture shape from the source and the narrower 4:3 ratio of the analog recorder.

- For anamorphic playback on this widescreen TV, choose the anamorphic picture display and ensure

that the TV screen format is set to standard (see the section on TV formats in this Owner's Guide).

- For cropped playback on an older style 4:3 TV, choose the cropped display to remove the top and bottom sections. This setting does not affect recording from analog devices, analog channels, or 4:3 digital channels.

Copy-Protected Material

When attempting to record copy-protected material, the record functions of the NetCommand and IEEE 1394 systems may be prevented or stopped. If you have a program that was originally tagged **Record Once**, NetCommand will change the tag to **Record No More** on the new recording.

VCR Recording

Setting Up Analog VCR Recordings with TV Guide On Screen®

When setting up a recording using TV Guide On Screen, note that:

- You must select the desired recording device in the TV Guide On Screen Record Options menu. If you have both analog and digital recording devices, always verify that the analog device is the default device before starting an analog recording with the  (**RECORD**) key.
- The destination recording device for analog recordings must be the analog device connected to the TV's **MONITOR OUT** jacks.

Restrictions for Traditional VCRs with NetCommand- and TV Guide On Screen-Controlled Recording

- Your VCR must be connected directly to the **MONITOR OUT VIDEO** and **LEFT/RIGHT** outputs.

IMPORTANT

When setting up analog recordings in TV Guide On Screen, set the destination recording device as the analog device connected to the TV's **MONITOR OUT VIDEO/LEFT/RIGHT** jacks.

NetCommand-Controlled Recording, continued

- The VCR must be set manually to “Line Input.” Display the Input Selection menu, highlight the VCR and press **GUIDE** to change VCR inputs.
- The TV can select channels on compatible cable boxes for recordings when the cable box is under NetCommand control. Leave the cable box turned on.
- If the source device or recording device does not have separate power on and off features, then leave that device powered on.
- You cannot record from source devices connected to the TV **COMPONENT** inputs or HDMI 1 or 2 connections.

Direct VCR Recording from an Antenna or Cable Source

When your VCR is the current device,  (**RECORD**) on the TV's remote control functions the same as the record button on the VCR's remote control or front panel.

To record directly from antenna or cable:

1. Press **INPUT** on the TV's remote to display the Input Selection menu. Highlight the traditional VCR and press **POWER** to turn on the VCR. If necessary, press **GUIDE** to select the input the VCR is on, such as Antenna input (or line input).
2. Press **ENTER** to switch the TV to the VCR.
3. Select the correct channel for recording on the VCR and then press  (**RECORD**) to start recording. You will need to stop the recording manually at the end of the program

Using IEEE 1394 Devices

IEEE 1394 Devices and the Input Selection Menu

When you connect an IEEE 1394 device to the TV network and power it on, the new device is automatically detected. Some non-audio/video or incompatible IEEE 1394 devices, such as personal computers (PCs), may not be detected by the TV and do not appear in the Input Selection menu. Such devices can, however, coexist and are still available to work with other devices on the IEEE 1394 network that are compatible with these non-audio/video devices.

Some devices may be a combination of two or more types of devices, such as a recording device that is also a tuning device. Each portion of the device is called a sub-unit. When you select a device on the Input Selection menu that has sub-units, a pop-up menu will appear to allow you to select the sub-unit you wish to use.

Recording to IEEE 1394 Devices

You can use the TV to control recording to IEEE 1394 devices. The following table lets you see what signals can be recorded to an IEEE 1394 digital VCR or A/V disc.

Recording Availability	Signal Type	TV Input
Can be recorded	Digital channels, including high-definition channels	ANT 1, ANT 2
	Digital signals, including high-definition signals	IEEE 1394 devices
Cannot be recorded	Analog channels	ANT 1, ANT 2
	Analog signals	INPUT 1-3, COMPONENT inputs
	Digital signals	HDMI 1 and 2, PC-DVI

Summary of signal inputs and recording to an IEEE 1394 digital VCR or A/V disc.

Switching Between Analog and Digital IEEE 1394 Outputs

To enable switching between analog and digital outputs, you must have check marked the **Analog Connection** box when the New 1394 Device screen displayed when you first connected the device. See chapter 3, “TV Setup.”



Figure 7. The ClearThought Auto Input sensing screen for IEEE 1394 devices. Place a check in the Analog Connection box if your device has both analog and digital outputs.

1. Press **INPUT** to display the Input Selection menu.
2. Highlight the icon for the IEEE 1394 device and press **ENTER**.
3. Press **▲▼** to switch between icons representing the analog and digital outputs of the device. See figure 8.

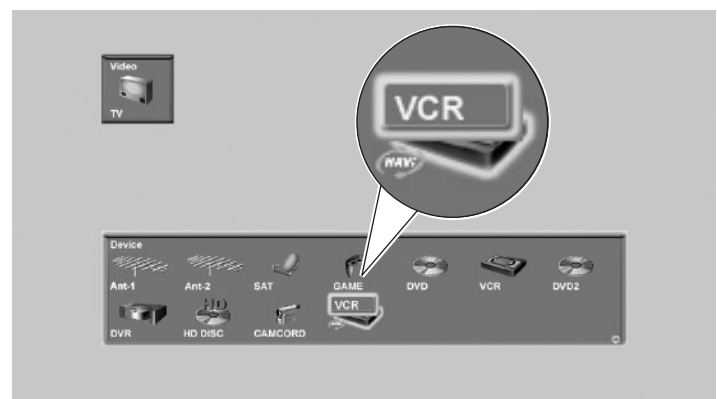

Figure 8. The Input Selection menu shows icons for the analog and digital outputs of the IEEE 1394 device.

4. Press **ENTER** again to select the device.

The TV Remote Control and IEEE 1394 Devices

- For compatible satellite receivers and some cable boxes, the TV remote control **GUIDE** key displays the on-screen programming guide for the receiver or cable box. Press **▲▼◀▶** and **ENTER** to navigate the displayed program guide.
- For satellite receivers, you may also be able to use the numbers or other additional buttons.
- For an IEEE 1394 cable box or satellite receiver, you can also try using the **CABLE/SAT** position of the TV remote control to see if it can operate the device. If not, use the remote control that came with the device.

To Power On or Off a Compatible IEEE 1394 Device

Usually, compatible IEEE 1394 devices power on when selected in the Input Selection menu and power off when you turn off the TV. If you need manual control over power on/off:

- Press **INPUT** to open the Input Selection menu.
- Move the highlight to the icon for the device. There is no need to press **ENTER**.
- Press **POWER**.
- Press **EXIT** to return to TV viewing.

Operation of IEEE 1394 Devices with the TV's Remote Control

(slide switch set to TV position)

Device → Remote Control Key	CABLE/SAT	A/V DISC	DVCR	AMPLIFIER
POWER	Power the device on/off when highlighted in the Input selection menu. See the instructions above.			
CH ▲/▼	Channel up/down	Page up/down (when track list is displayed)	Index search forward/reverse (if supported by DVCR)	
VOL ▲/▼				Volume Up/Down
MUTE				Mute On/Off
0-9 (DIGITS)	Number functions	Search by time (when followed by ENTER)		
QV	Last Channel Recall			
EXIT	Exit menus/displays	Exit menus/displays	Exit menus/displays	
ENTER	Enter or select	Enter or select	Enter or select	
CANCEL	Cancel function	Delete recording from Track List	Cancel function or counter reset	
GUIDE	Digital-channel guide (may need to press twice)	Display Track List.		
▲▼◀▶	Up/down/left/right	<ul style="list-style-type: none"> ▲ Skip to beginning of program ▼ Up/down in track list ◀ Skip Backwards 12 seconds during playback ▶ Skip Forward 30 seconds during playback 	Up/down/left/right	
▶ PLAY		Play	Play	
■ STOP		Stop	Stop	
● RECORD		Record	Record	
◀◀ REV		Reverse picture scan or Slow Play	Reverse or Rewind	
▶▶ FFWD		Fast picture scan or Fast Play	Fast Play or Fast Forward	
⏸ PAUSE		Pause	Pause	

A/V Discs

A/V Disc Track List Screen

When viewing an A/V Disc:

- Press **GUIDE** to display its Track List (see figure below).
- Press **▲** or **▼** to navigate through the Track List.
- To play a track, select it on the list, then press **ENTER**.
- Press **INFO** to view details for a highlighted track, if available.
- To move through listings quickly, press **PAGE** **^**/**v**.
- To delete a track, highlight it and press **CANCEL**.

Channel	Station	Date	Time	Program	Watched
62	KNBC-DT	Su 7/25	8:00 pm	West Wing	N
With the country at a heightened state of alert because suspected terrorists have disappeared, the President wrestles with what message to give his youngest daughter's graduating class at Georgetown.					
45 min	6G	COPY FREE			
02.01	KCBS-DT	Su 8/08	5:30 pm	Chicago Hope	N
04.01	KNBC-DT	M 8/09	5:30 pm	CBS Local News	N
7		M 8/09	8:00 pm	NBC Evening News	Y
1104	KNBC-DT	W 8/11	8:30 pm	NBC Evening News	N

Select a program with the ADJUST keys. Press **ENTER** to watch the program. Press **CANCEL** to delete.

Figure 9. A/V Disc Track List screen

A/V Disc Search by Time

While playing an IEEE 1394 A/V disc you can search to a specific time in the recording.

1. Start playing the desired track on the A/V disc.
2. Use the number buttons to enter the time code position of hours followed by minutes. For example, to enter one hour and twenty-two minutes (1:22) into the track, enter 1, 2, 2.
3. Press **ENTER** to skip to the time code position. To cancel the request or to start over, press **CANCEL** instead of **ENTER**.

Copying A/V Disc Recordings

Tracks you record to disc may have copy restrictions assigned to them. To learn a track's copy status, highlight the track in the Track List and press **INFO**. Tracks are assigned one of these ratings:

Copy Free (or no status shown)	No copy restrictions apply.
Copy Never	The track cannot be transferred to another recording device. Tracks of this type may have an assigned retention period. See below for more information.

The Track List may also display copy status for a track. You may see the following status displays:

Copy Once	The track can be copied once only.
Copy No More	If a retention value is shown, the track may be movable using your other A/V equipment. Mitsubishi TVs do not support this function.

Retention Period

Some **Copy Never** tracks have a retention period assigned by the content provider. The retention period is the length of time you can keep and view the recording. The initial retention period, if any, is shown next to the copy status in the Track List **INFO** display. To check how much time remains of the retention period, start viewing the recording and press **INFO**.

Note: The retention period for all tracks on the disc expires if there is any loss of power to the TV, even momentary. For example, expiration of the retention period will occur if you:

- Unplug the TV from the AC power source.
- Experience a power outage or power fluctuation.

Remember that you can safely turn off TV power using the **POWER** button without affecting the retention period.

To Copy a Track to Another IEEE 1394 Device

1. Press **INPUT** on the remote control and press **▲▼◀▶** to select the source A/V disc. Press **ENTER** to open the Track List.
2. Press **▲** or **▼** to select a track. Then press **ENTER** to start playback.
3. Press **⏸** (**PAUSE**) to pause playback.
4. Press **⏺** (**RECORD**) on the TV remote. The Record menu will display.
5. In the **Record To** section, review the destination device (A/V Disc, DVCR). Change if necessary. If moving, leave the other settings unchanged.
6. Press **⏺** a second time to start recording.



Using the TV with a Personal Computer

Setup	88
Video Adjustments	88
Connecting a Computer to the TV	89
Adjusting Image Resolution	91
Computer Display Formats	92

Setup

1. See the TV specifications in Appendix B to confirm that your computer video signal is compatible with the TV.
2. Note whether the computer supplies a digital or analog video signal. You will need this information during the setup procedure.
 - Digital video signal: Comes from the computer's DVI or HDMI output.
 - Analog video signal: Comes from the computer's VGA 15-pin output and requires a VGA-to-DVI cable or a VGA cable and VGA/DVI adapter.
3. Power on the TV.

IMPORTANT

In the next step, select the correct video signal type (analog or digital) in the NetCommand menu. Otherwise, the TV will be unable to display a picture from the computer.

4. Press **MENU** to open the Main menu, highlight the NetCommand icon, and press **ENTER**.
5. Highlight the **PC-DVI** text box and press **▼** to change the setting to match your computer's video signal type, either **Digital** or **Analog**.

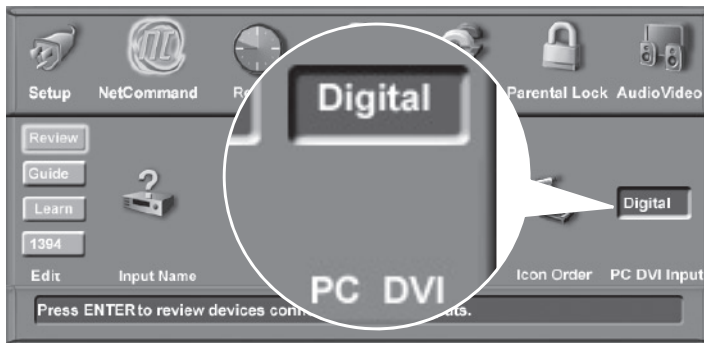

Figure 1. Specify your computer's video signal type (analog or digital) in the NetCommand menu.

6. Press **EXIT** to close all menus.
7. Connect the computer's video output to the TV's **PC-DVI** jack. See the connection diagrams in this chapter to find the method best suited to your equipment.
8. Connect the computer's audio output using one of these options:
 - Connect analog left/right audio to the TV's **PC-DVI AUDIO** jack.
 - If your computer offers digital audio output, connect it to a digital A/V receiver instead.

IMPORTANT

See Appendix B for signal compatibility.

Video Adjustments

1. Power on the computer if it is not already on.
2. Select **PC** from the Input Selection menu. To do this, press **INPUT** to open the Input Selection menu, move the highlight to the PC icon, and press **ENTER**.
3. Change the resolution of the computer image. The goal is to maximize the computer resolution while maintaining a suitable aspect ratio for the image. See the explanation later in this chapter.
4. Perform TV video adjustments. Press **VIDEO** repeatedly to cycle through the video-adjustment options. The following additional adjustments are available for computer video:

Auto Position. Press **ENTER** to automatically center the position of the PC video.

HorizPosition (Horizontal Position). Manually adjust the horizontal position of the PC. This selection overrides the **Auto Position** selection.

VertPosition (Vertical Position). Manually adjust the vertical position of the PC. This selection overrides the **Auto Position** selection.

Fine Detail (analog DVI-A signals only). Manually adjust the picture quality of the PC. This selection overrides the **Auto Position** selection.

5. Change the TV picture format to suit the image. Press **FORMAT** to cycle through the available picture formats. See the chart later in this chapter showing how various computer resolutions are displayed on the TV.

To Remove the Computer Icon from the Input Selection Menu

When you disconnect an analog video connection from a personal computer, the computer icon remains in the Input Selection menu until you remove it.

1. In the NetCommand menu, highlight the **PC DVI Input** box.
2. Highlight the **PC DVI Input** box and press **▼** to select **Digital**.
3. Press **EXIT** to close all menus.

The next time you open the Input Selection menu, the computer icon will no longer appear.

Note

- The **PC-DVI** input on the TV can accept either analog (DVI-A) or digital (DVI-D) signals.
- You must specify the **PC DVI Input** setting in the NetCommand menu as either **Analog** or **Digital**, depending on the signal type sent by your computer.
- If your computer offers digital audio output, you can connect your computer's digital audio out to a digital input on a digital A/V receiver.

Connecting a Computer to the TV

Computer with DVI Digital Monitor Output

Required: DVI-to-DVI cable, stereo audio cables

If the computer's audio output is a single mini jack, a mini audio-to-RCA-male "Y" adapter cable is also required.

1. Connect the DVI-to-DVI cable from the computer **DVI** output to the **PC-DVI** jack on the TV back panel.
2. Connect the left (white) and right (red) audio cables from **AUDIO OUT** on the PC back panel to **PC-DVI AUDIO** on the TV back panel.

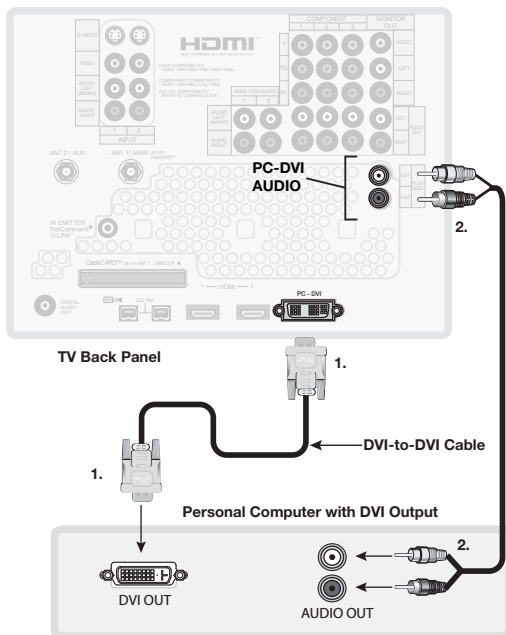

Figure 2. Connecting a personal computer with DVI Monitor Output

Computer with HDMI Digital Monitor Output

Required: HDMI-to-DVI cable or an HDMI cable with an HDMI/DVI adapter, stereo audio cables

If the computer's audio output is a single mini jack, a mini audio-to-RCA-male "Y" adapter cable is also required.

1. Connect the computer's **HDMI** output to the TV's **PC-DVI** jack. Use either an HDMI-to-DVI cable or an HDMI cable with an HDMI/DVI adapter.
2. Connect the left (white) and right (red) audio cables from the computer's **AUDIO OUT** to **PC-DVI AUDIO** on the TV back panel.

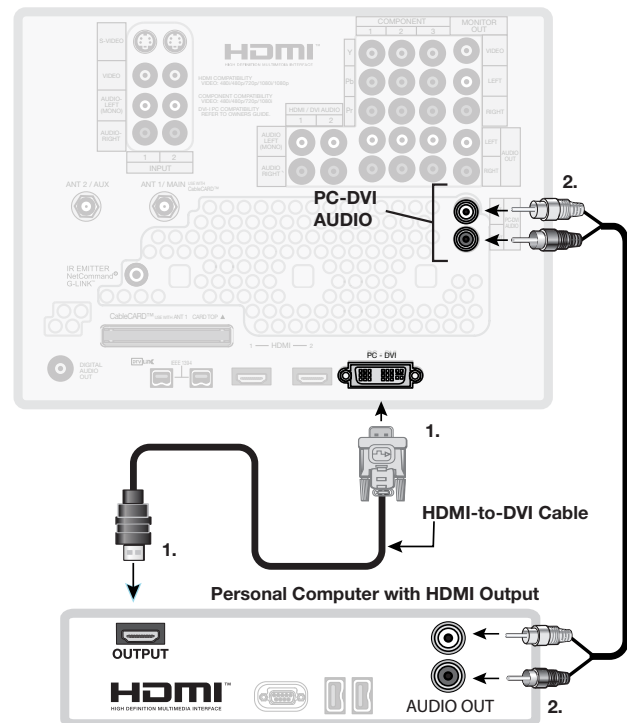

Figure 3. Connecting a personal computer with an HDMI monitor output

Connecting a Computer to the TV, continued

Computer with VGA 15-Pin Monitor Output (Analog Video)

Required: 15-pin computer VGA-to-DVI cable or a VGA computer cable and a DVI/VGA adapter, stereo audio cable.

If the computer's audio output is a single mini jack, a mini audio-to-RCA-male "Y" adapter cable is also required.

IMPORTANT

To use this connection, you must first select the **Analog** setting in the **PC DVI** box of the **NetCommand** menu. See the "Setup" section for more.

1. Connect the computer's **PC MONITOR OUT** to **PC-DVI** on the TV back panel. Use either a VGA-to-DVI monitor cable or a VGA computer cable with a VGA/DVI adapter.
2. Connect the left (white) and right (red) audio cables from the computer's analog audio output to **PC-DVI AUDIO** on the TV back panel.

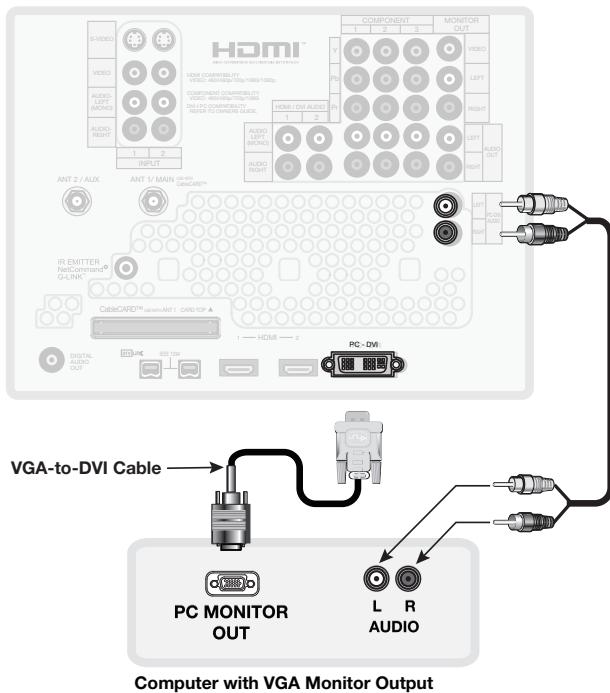

Figure 4. Connecting a computer with a VGA 15-pin monitor output.

Adjusting Image Resolution

Your Mitsubishi TV can display resolutions from standard VGA (640 x 480) through 1920 x 1080 signals at a refresh rate of 60 Hz. Note that 1280 x 1024 and 1920 x 1080 signals are supported only for digital computer signals. The resolution of 1920 x 1080 is supported at refresh rates of 24, 30, and 60 Hz. See Appendix B in this book for more on compatible screen resolutions.

In most cases, the computer will select the best resolution match to display on the TV. You can override this setting if you wish. The instructions below are for setting the resolution on most personal computers.

1. In the PC's Start menu, select **Settings**.
2. Select **Control Panel**.
3. Select **Display**.
4. Choose the **Settings** tab.
5. Change the resolution to the highest resolution with the aspect ratio best suited for the image. See the table on the next page showing possible PC formats. Depending on your computer's operating system, adjust the resolution with either:
 - the Screen area slider.
 - the Screen Resolution slider

6. To change the refresh rate, click on the **Advanced** button.
7. On the **Monitor** tab, select a setting from the **Screen refresh rate** drop-down list. The resolution of 1920 x 1080 is supported at 24, 30, and 60 Hz; other resolutions are supported at 60 Hz.

You may need to restart the computer for this change to take effect.

NOTE: Whenever the TV is powered on, the lamp is in use, even if the TV screen appears dark. As a reminder that the TV is powered on and that time is being added to the lamp's elapsed hours, set the computer's screen saver to a pattern that will display after several minutes of inactivity.

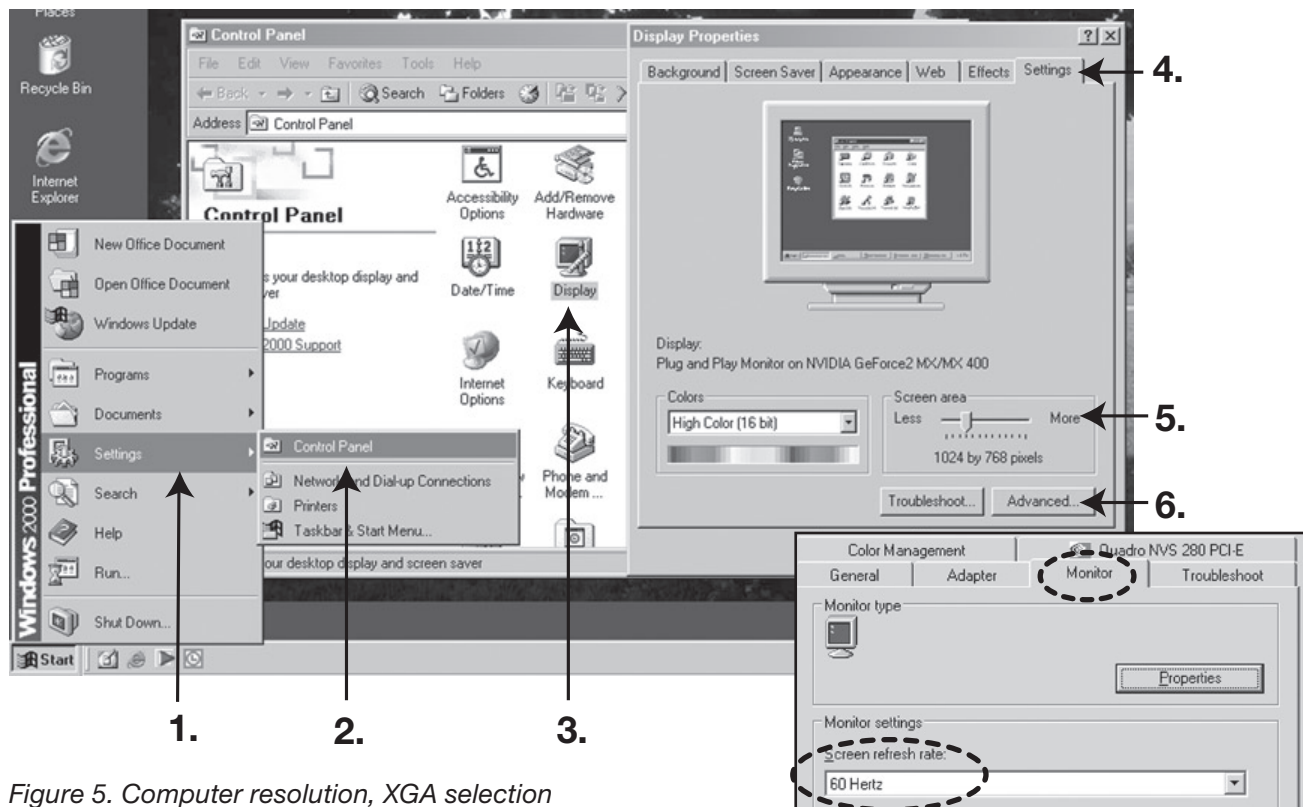
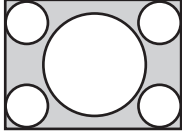
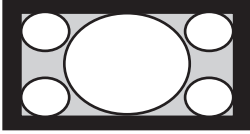
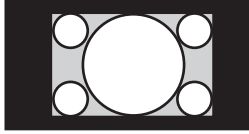
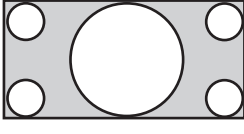

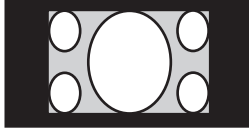
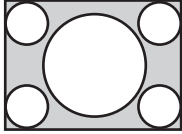
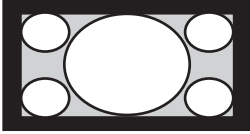
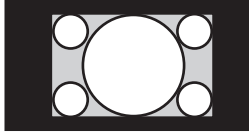
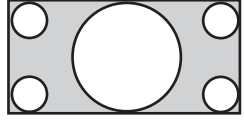

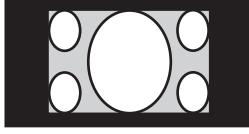
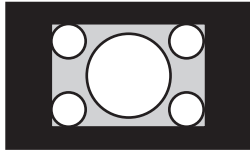
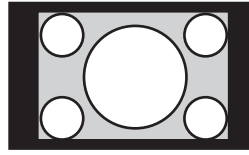
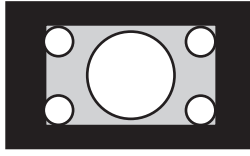
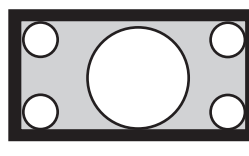
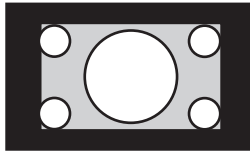
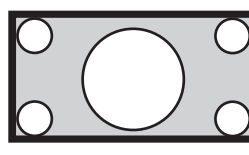

Figure 5. Computer resolution, XGA selection

Computer Display Formats

Repeatedly press the **FORMAT** key to cycle through the TV displays available for your computer's video signal.

Computer Signal		As Displayed on TV Screen	
Format		16 X 9 Standard	4 X 3 Standard
VGA 640 X 480			
WVGA 848 X 480			
SVGA 800 X 600			
WSVGA 1064 X 600			

Format	Standard	Zoom
XGA 1024 X 768		
PC 720p 1280 X 720		
WXGA 1365 X 768 (DVI-D signals only)		

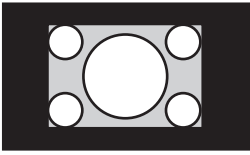
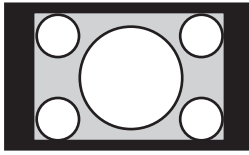
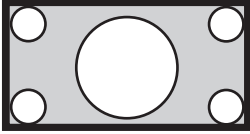
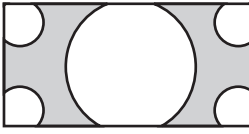
Format	Reduced	Standard
SXGA 1280 X 1024 (DVI-D signals only)		
PC 1080p 1920 X 1080 (DVI-D signals only)		

Appendices

Appendix A: Bypassing the Parental Lock	95
Appendix B: Specifications	97
Appendix C: Lamp Cartridge Replacement.	99
Appendix D: Programming the Remote Control.	101
Appendix E: Troubleshooting	111

Appendix A: Bypassing the Parental Lock

Lock Bypass Instructions Have Been Filed for Future Reference

Bypassing the Parental Lock

After you set the lock, you must use your pass code to view a locked program, view the locked TV, cancel the lock, or enter the Parental Lock menus.

If you forget your pass code, you can view the locked TV without entering your pass code. When you are prompted for your pass code, press the number 9 and QV buttons on the TV remote control at the same time. This process temporarily unlocks the TV.

When entering the Parental Lock menu, this process deletes your old pass code and prompts you to enter a new pass code. Press EXIT to exit the menu.

Deactivating the Front Button Lock

Press and hold the MENU button on the TV front panel for over eight seconds. If the TV is off, this action turns it on.

IMPORTANT

Cut along the dotted line and file bypass instructions in a safe place for future reference.

IMPORTANT

When changing or deleting your pass code, you must use the remote control included with this TV. You cannot use a Mitsubishi remote control from another component or a "universal" remote.

This page intentionally left blank

Appendix B: Specifications

Model	Projection System	Lamp
WD-Y57, WD-Y65 WD-57732, WD-65732	DLP, 0.65" chip, 1920 x 1080 pixels with Smooth Picture™	150-watt VIP type
WD-73732	DLP, 0.843" chip, 1920 x 1080 pixels with Smooth Picture™	180-watt VIP type

Reception	
Channel Frequency Reception	Over-the-Air: VHF 2–13, UHF 14–69 Analog Cable: 1–125 Digital Cable: 1–135
Channel Type*	Over the Air: Analog NTSC, Digital ATSC with sub-channels (all 18 video formats)
	Cable: Analog NTSC (non-scrambled) Digital QAM 64 and 256 with sub-channels (non-scrambled)
	CableCARD™: Authorized scrambled and non-scrambled digital channels
<p>* Note for Digital Channels: The channel numbers displayed on screen are determined by the broadcaster or cable company and can vary from the standard frequency number. If there is no channel-number information provided by the broadcaster or cable company, the TV creates a channel number. The created channel number uses the frequency number as the main channel number and the program number as the sub-channel number. When using an authorized CableCARD, the channel numbers are determined by the cable company.</p>	

Inputs			
Description	Qty.	Signal Type	Input Specifications
Antenna/Cable input	2	RF	F connector, 75-ohm
HDMI (digital video/audio)	2	HDMI EIA-861B standard for digital audio and video	HDMI standard connector Video: 60 Hz: 480i, 480p, 720p, 1080i 24 Hz, 30 Hz, 60 Hz: 1080p Audio: PCM stereo Note: Not for use with personal computers.
Video/S-Video (one front, two rear)	3	NTSC 480i only	Video: RCA Pin Plug, 1.0 V p-p, 75 ohm S-Video: Four-Pin DIN Plug Y: 1.0 Vp-p 75-ohm C: 0.286 Vp-p (burst signal), 75-ohm
Component Video (Y/Pr/Pb)	WD-Y57 WD-Y65	2	EIA-770.1 & EIA 770.2 480i, 480p, EIA 770.3 720p and 1080i (video standards)
	WD-57732 WD-65732 WD-73732	3	
Audio Inputs	WD-Y57, WD-Y65	8 pairs	analog left and right audio
	WD-57732, WD-65732, WD-73732	9 pairs	
PC DVI-I Input	1	analog and digital video	VGA (640 x 480, 60 Hz) W-VGA (848 x 480, 60 Hz) SVGA (800 x 600, 60 Hz) W-SVGA (1064 x 600, 60 Hz) XGA (1024 x 768, 60 Hz) 1280 x 720, 60 Hz
		digital video only	SXGA (1280 x 1024, 60 Hz) 1920 x 1080 (24 Hz, 30 Hz, 60 Hz) WXGA (1360 x 768, 60 Hz)

Appendix B: Specifications, continued

Outputs		
Description	Qty.	Output Specifications
Video	1	Video: RCA Pin Plug 1.0 Vp-p, 75-ohm Signal Type: NTSC 480i only
Audio (Signal)	2 pairs	RCA Pin Plug, 500 mV rms \pm 200 mV (full scale) for analog sources, 1.5 Vrms \pm 0.5 Vrms (full scale) for digital sources.
Audio (Speakers)	2	5.5" x 2.2"

Digital Interfaces		
Digital Audio Output	1	RCA Pin Plug, Signal Type, Dolby Digital, PCM
IEEE 1394 (input/output) (2 rear)	2	IEEE 1394 Four-Pin-Type Terminal, S400

Physical Characteristics and Power Consumption					
Model	Dimensions (inches)			Weight	Power Consumption
	Height	Width	Depth		
WD-Y57	36 3/16	51 1/2	17 15/16	85.8 lbs.	250 w
WD-Y65	40 3/4	58 1/2	19 13/16	99.0 lbs.	250 w
WD-57732	36 3/16	51 1/2	17 15/16	85.8 lbs.	255 w
WD-65732	40 3/4	58 1/2	19 13/16	99.0 lbs.	255 w
WD-73732	44 3/4	69 7/8	21 5/16	190.0 lbs.	290 w

IEEE 1394 System Compatibility

- This television is designed to conform to IEEE 1394 AV/C Software standards in effect at the time of development. This networking and control technology is designed to provide high-performance digital connections and product control, making the product easier to use.
- Mitsubishi D-VHS VCRs are fully compatible with this TV in audio, video, and control.
- As other manufacturers distribute products that use the IEEE 1394 AV/C standards, they will be responsible for developing products that meet the standards of the technology, as well as compatibility testing with other products. Mitsubishi cannot be responsible for their efforts, and therefore cannot promise compatibility with these other products. Any compatibility problems with other manufacturers' products should be brought to the attention of those manufacturers.

HDMI

The HDMI input is compliant with EIA-861B standards for standard, extended, and high-definition video; digital audio, and HDCP copy protection. The HDMI inputs on this TV are not intended for use with personal computers or devices outputting video signals with computer resolutions.

Appendix C: Lamp Cartridge Replacement

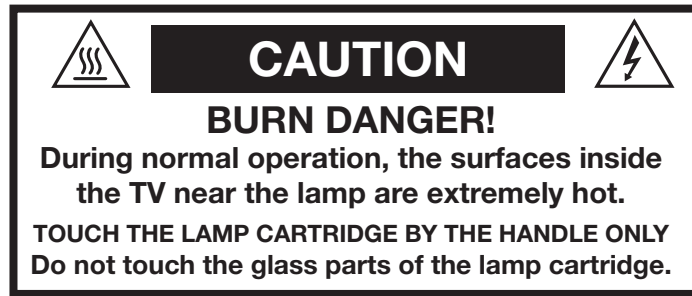

CAUTION: If the television is on, press **POWER** to turn it off. Unplug the television and allow it to cool for at least one hour before attempting to replace the lamp cartridge.

Lamp Life

The light source for this television is a lamp, which is part of a lamp cartridge assembly. The life of the lamp can vary, based on the lamp itself, the air temperature around the TV while it is operating, and your viewing patterns. Warmer air or poor ventilation shorten the lamp life, as does turning the television on and off frequently. Mitsubishi warrants the lamp for one (1) year from the date of original purchase at retail. It is likely that the lamp will last much longer than this.

To Order a New Lamp

To Receive a Replacement Lamp Under Warranty

Call (800) 553-7278. Please have model number, serial number, and TV purchase date available.

Important: All lamps replaced under warranty must be returned to Mitsubishi where they will be inspected for defect verification.

To Purchase a Replacement Lamp After Warranty

Visit our website at www.mitsuparts.com or call (800) 553-7278. Order a new lamp by part number as shown below.

TV Model Number	Lamp Part Number
WD-Y57, WD-Y65, WD-57732, WD-65732	915P049010
WD-73732	915P049020

WARNING

- Do not remove the lamp cartridge immediately after turning off the television. You may get burned because the lamp is very hot. Allow the television to cool for at least one hour before replacing the lamp cartridge.
- Do not remove the lamp cartridge except when replacing it. Careless treatment can result in injury or fire.
- Do not touch the lamp glass element. It may be very hot and break, causing injuries or burns.
- Be sure not to insert any metal or flammable object into the lamp cartridge opening, as it may cause fire or electrical shock. If a foreign object is inserted into the opening, unplug the AC cord of the TV and contact your dealer for service.
- Install the lamp cartridge securely. Failure to do so may cause a fire.
- Do not touch the lamp glass elements. Oils from your fingers may cause premature lamp failure.

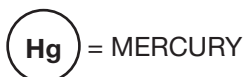

THE LAMP INSIDE THIS PRODUCT CONTAINS MERCURY AND MUST BE RECYCLED OR DISPOSED OF ACCORDING TO LOCAL, STATE OR FEDERAL LAWS. For disposal or recycling information, please contact your local authorities or the Electronic Industries Alliance at www.eiae.org

Appendix C: Lamp Cartridge Replacement, continued

WARNING

THE COVER IS PROVIDED WITH AN INTERLOCK TO REDUCE THE RISK OF EXCESSIVE ULTRAVIOLET RADIATION. DO NOT DEFEAT ITS PURPOSE OR ATTEMPT TO SERVICE THE TV WITHOUT REMOVING THE COVER COMPLETELY.

Removing the Old Lamp Cartridge

1. Turn off TV power and allow the lamp to cool for at least one hour before proceeding.
2. After the lamp has cooled, remove the cover. Refer to figure 1. Use a #2 (large) Phillips screwdriver to remove the two screws securing the cover. Keep the screws and cover for re-installation.
3. With a large flat-blade screwdriver, loosen the two shiny screws securing the lamp cartridge until they disengage from the mating threads. These are captive screws and cannot be separated from the lamp cartridge.
4. Fully open up the bag supplied with the replacement lamp and set the opened bag aside.
5. Gently grasp the handle of the lamp cartridge and pull the old cartridge straight out. See figures 1 and 2.

CAUTION: Do not tilt or rotate the cartridge, as small glass fragments may fall out.

6. Without tilting or putting down the lamp cartridge, insert it into the opened bag. Close the bag while being careful not to let any glass particles fall out.

Installing the New Lamp Cartridge

1. Do not touch the glass parts of the new lamp cartridge. Insert the new cartridge into the TV using the following guidelines:
 - a. Refer to figures 3 and 4 and note the location of the top and bottom guides inside the lamp compartment and the corresponding grooves on the top and underside of the lamp.
 - b. Hold the lamp cartridge level with the lamp compartment, oriented as shown in figure 5.
 - c. Align the grooves on the cartridge with the top and bottom guides in the lamp compartment. See figure 5.

Guides inside the lamp compartment

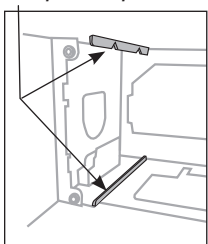
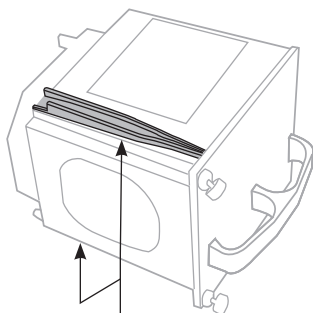

Figure 3



Grooves are on the top and underside of the lamp cartridge

Figure 4

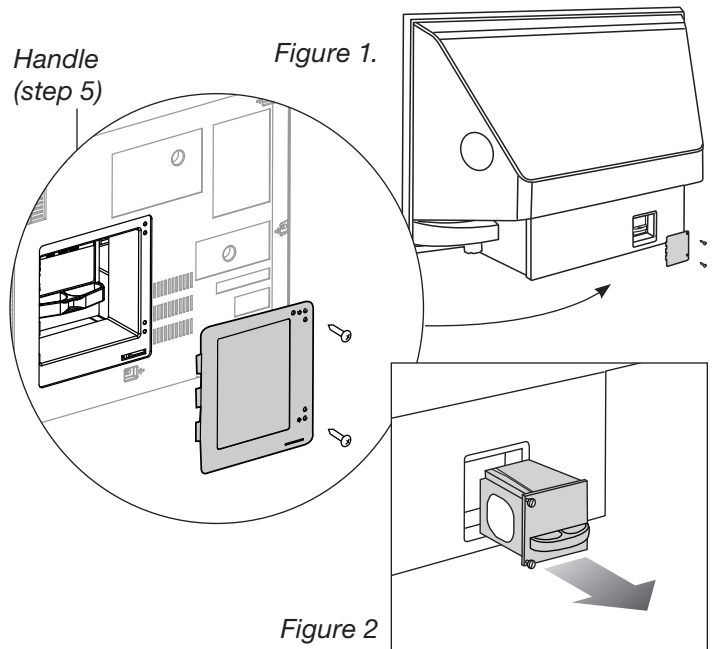

Figure 2

- d. Carefully push in the cartridge until it is fully seated. If the cartridge does not slide in smoothly, gently wiggle the handle from side to side while pushing in.

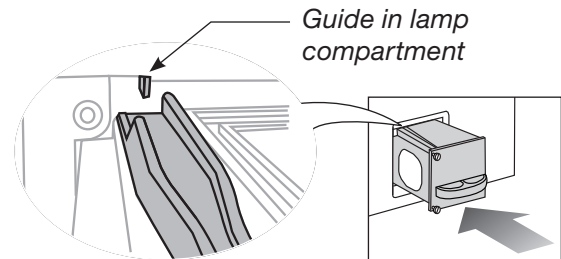

Figure 5

2. With either your fingers or the screwdriver, gently tighten the two shiny screws. If using a screwdriver, use only two fingers for final tightening. **AVOID OVERTIGHTENING!**
3. Replace the plastic cover and retaining screws.
4. **WASH YOUR HANDS THOROUGHLY, AS THIS LAMP CONTAINS MERCURY.**

Disposal of the Old Lamp Cartridge

Lamp under warranty: All lamps replaced under warranty must be returned to Mitsubishi. Use the return shipping label provided and send to Mitsubishi Digital Electronics, America, 1001 Cherry Drive, Suite 2, Braselton, GA 30517.

IMPORTANT: Lamps found to be without defect will be returned and charged back to the sender.

Lamp no longer under warranty: Contact your local authorities or the Electronic Industries Alliance at www.eiae.com for lamp-disposal or recycling instructions. Do not dispose of the old lamp with common trash.

Appendix D: Programming the Remote Control

This appendix explains how to program the TV's remote control to operate other A/V devices. This is distinct from NetCommand "Learning." To summarize: the TV's remote control can be made to operate other devices by two different methods:

- Remote Control Programming: you must move the slide switch to the position specific to the type of device.
- NetCommand® "Learning": you can operate other devices with the slide switch in the TV position. Position IR emitters in front of the other devices and "teach" the devices' IR signals to the TV.

Functions Available for Other A/V Devices

The TV's remote control can be programmed to operate other types and brands of A/V products. To use the remote when programmed, **set the slide switch to the position labelled for the product type.** The functions performed in each switch position can vary depending on the product. Not all functions work for all models. The most common functions available are listed on this page.

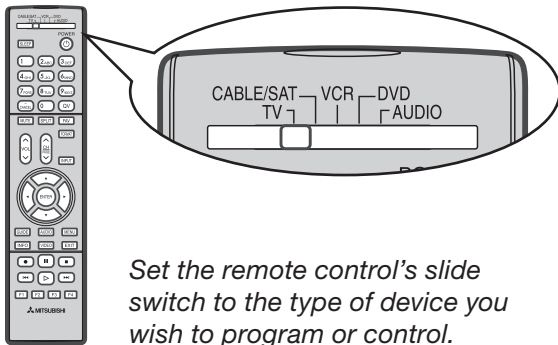

Set the remote control's slide switch to the type of device you wish to program or control.

IMPORTANT

Some manufacturers may change their products or they may use more than one remote control system. The TV's remote control may be unable to operate your A/V equipment in these cases.

VCRs and DVRs

- | | |
|---|---|
| <ul style="list-style-type: none"> • CH \wedge/\vee • POWER • SLEEP • $\blacktriangleright\blacktriangleright$ (FAST FORWARD) • \parallel (PAUSE) | <ul style="list-style-type: none"> • \blacktriangleright (PLAY) • \bullet (RECORD) • $\blacktriangleleft\blacktriangleleft$ (REVERSE) • \blacksquare (STOP) • 0-9 Number Buttons |
|---|---|

Mitsubishi VCRs are compatible with some additional buttons.

Cable Boxes and Satellite Receivers

- | | |
|---|---|
| <ul style="list-style-type: none"> • AUDIO • CANCEL (on some models) • CH \wedge/\vee • ENTER (on some models) • GUIDE (on some models) • PG \wedge/\vee • POWER • $\blacktriangle\blacktriangledown\blacktriangleleft\blacktriangleright$ (on some models) • VIDEO | <ul style="list-style-type: none"> • 0-9 Number Buttons (on some models) • F1-F4 (A, B, C, D keys on some models) <p>The record/playback keys (on some models):</p> <ul style="list-style-type: none"> • $\blacktriangleright\blacktriangleright$ (FAST FORWARD) • \parallel (PAUSE) • \blacktriangleright (PLAY) • \bullet (RECORD) • $\blacktriangleleft\blacktriangleleft$ (REVERSE) • \blacksquare (STOP) |
|---|---|

A/V Receivers

- | | |
|--|---|
| <ul style="list-style-type: none"> • MUTE • POWER • SLEEP • VOLUME • 0-9 Number Buttons | <ul style="list-style-type: none"> • Direct Input Selection buttons: numbers, FAV and QV (on some Mitsubishi models) |
|--|---|

CD Players

(not all functions for all models)

- | | |
|--|---|
| <ul style="list-style-type: none"> • SLEEP • $\blacktriangleright\blacktriangleright$ (FAST FORWARD) • \parallel (PAUSE) • \blacktriangleright (PLAY) | <ul style="list-style-type: none"> • $\blacktriangleleft\blacktriangleleft$ (REVERSE) • \blacksquare (STOP) • 0-9 Number Buttons |
|--|---|

DVD and Laser Disc Players

(not all functions for all models)

- | | |
|--|--|
| <ul style="list-style-type: none"> • CANCEL (on some models) • CH \wedge/\vee (for track skip on some models) • ENTER • MENU • POWER • SLEEP • $\blacktriangle\blacktriangledown\blacktriangleleft\blacktriangleright$ (on some models) | <ul style="list-style-type: none"> • $\blacktriangleright\blacktriangleright$ (FAST FORWARD) • \parallel (PAUSE) • \blacktriangleright (PLAY) • \bullet (RECORD) • $\blacktriangleleft\blacktriangleleft$ (REVERSE) • \blacksquare (STOP) • 0-9 Number Buttons (on some models) |
|--|--|

Appendix D: Programming the Remote Control

Programming the Remote Control

Method 1: Code Entry

1. Move the slide switch at the top of the remote to the position for the product you want to control. Refer to the table below. Only one of each device type can be controlled in each slide-switch position.

Switch Position	Affected Device
CABLE/SAT	Cable Box DTV Receiver Satellite Receiver
VCR	VCR DVR Laser Disc Player DVD Player/Recorder
DVD	DVD Player/Recorder DVR Laser Disc Player VCR
AUDIO	A/V Receiver Audio Amplifier CD Player*

2. Press and hold **POWER** on the remote control for several seconds until the button blinks twice and goes off.
3. Release the **POWER** button.
4. Enter the first five-digit code listed for your equipment.
 - The **POWER** button blinks twice when you start to enter the code and then once for each additional keypress.
 - The **POWER** button blinks twice when you finish entering a valid code.
 - Move the slide switch to another position if you need to start over or wish to exit programming mode.
5. Point the remote control at the equipment and press **POWER**. If the product has no power on/off function, press a different key, such as **▶ (PLAY)**, **■ (STOP)**, **VOL ▲**, or **MUTE**.
 - If the equipment responds, the remote control is properly programmed to operate the equipment.
 - If the equipment does not respond, repeat steps 2–4 with the next five-digit code listed for your equipment.

6. Once you have found the correct code, write it in the space below for future reference.

Switch Position	Device Type	Code
CABLE/SAT		
VCR		
DVD		
AUDIO		

Method 2: Code Search

In this method of programming, you step through the remote control's internal code library to find the correct code for your A/V product.

1. Move the slide switch at the top of the remote control to the correct position for the product. See the table under "Method 1."
2. Press and hold **POWER** on the remote control for several seconds until the button blinks twice and goes off.
3. Press keys **9 9 1**
4. Press the number 1, 2, or 3 depending on the slide-switch position and the table below.

Switch Position	Number
CABLE/SAT	1
DVD, VCR	2
AUDIO	3

5. Press **CH ▲** and **POWER** repeatedly until the product responds by powering on or off. You can press **CH ▼** to move backward through the code library if needed.

NOTE: If the product has no power on/off function, check for a response using a different function. Press **▶ (PLAY)**, **■ (STOP)**, **VOL ▲**, or **MUTE** and then repeatedly press **CH ▲/▼** to check for a response.

6. When the product responds, press **ENTER** to set the code.

Code Verification

To determine the code programmed for any position of the slide switch:

1. Move the slide switch to the position you wish to verify.
2. Press and hold **POWER** on the remote control for several seconds until the button blinks twice and goes off.
3. Press keys **9 9 0**
4. Press 1 and count the blinks of the power button. Write down the number of blinks as the first digit of the code.
5. Repeat step 4 for the second, third, fourth, and fifth digits of the code.

IMPORTANT

You may need to reprogram the remote control after changing the batteries.

Appendix D: Programming the Remote Control

Audio Lock: Universal A/V Receiver Control

With Audio Lock active, the remote control operates the volume and mute functions of the A/V receiver in all positions of the slide switch. Activate Audio Lock if you normally use an A/V receiver with your TV and other A/V equipment.

1. Program the **AUDIO** position for your A/V receiver as described earlier in this section.
2. Move the slide switch to the **AUDIO** position.
3. Press and hold **POWER** on the remote control for several seconds until the button blinks twice and goes off.
4. Press keys **9 9 3 ENTER**
The **POWER** button will blink twice to indicate Audio Lock is active.

To Reset the Remote Control to Operate Volume and Mute for the TV Speakers

1. Press and hold **POWER** for several seconds until the button blinks twice and goes off.
2. Press keys **9 9 3 VOL ^**.
The **POWER** button will blink four times to indicate Audio Lock has cleared.

Programming Codes

Audio Amplifiers	
Brand	Code
Acurus	30765
Adcom	31100, 30577
Altec Lansing	31742
Aragon	30765
Bel Canto Design	31583
Bose	30674
Carver	30892
Classe	31462, 31461
Curtis Mathes	30300
Durabrand	31561
Elan	30647
GE	30078
Harman/Kardon	30892
JVC	30331
Klipsch	30765
Left Coast	30892
Lenoxx	31561
Lexicon	31802
Logitech	31408
Marantz	30892
Mark Levinson	31483
McIntosh	30251
Mondial	30765
Optimus	30823, 30395, 30300
Philips	30892
Pioneer	30823, 30300, 30257, 30013
Polk Audio	30892
RCA	30823, 30300
Realistic	30395
Sharp	30226
Sony	30815
Soundesign	30078
Technics	30374, 30372
Toshiba	30353
Victor	30331
Wards	30078, 30013
Yamaha	30354

A/V Receivers	
Brand	Code
ADC	30531
Adcom	31617, 31616
Aiwa	31641, 31405, 31388, 31347, 31321, 31243, 30189, 30121
Akai	31255
Alco	31390
AMC	31077
Amplifier Technologies	31584
Anam	31609, 31074
Apex Digital	31774, 31430, 31257
Arcam	31189
Atlantic Technology	31487
Audiophase	31387

Appendix D: Programming the Remote Control

Programming Codes, continued

A/V Receivers	
Brand	Code
Audiotronic	31189
Audiovox	31627, 31390
B & K	30840, 30820, 30701
Bel Canto Design	31584
BK	30702
Bose	31253, 31229, 30639
Brix	31602
Cambridge Soundworks	31477
Capetronic	30531
Carver	31289, 31189, 30189, 30121
Coby	31263
Curtis	30797
Delphi	31414
Denon	31360, 31311, 31142, 30121,
Fisher	31801, 31409
Fosgate	31487
Glory Horse	31263
GPX	31299
Harman/Kardon	31306, 31304, 31289, 30891, 30189, 30110
Hitachi	31801, 31273
Integra	31320, 31298, 30135
JBL	31306, 30110
JVC	31811, 31643, 31495, 31374, 31282, 31263, 31058
Kenwood	31570, 31569, 31313
KLH	31428, 31390
Koss	31497, 31366
Linn	30189
Liquid Video	31497
Magnavox	31514, 31269, 31189, 30531, 30189
Marantz	31289, 31269, 31189, 30200, 30189,
McIntosh	31289
Micromega	31189
Mitsubishi	31957, 31922, 31921, 31920, 31393, 30176
Myryad	31189
Nakamichi	31555, 31313, 30097
Onkyo	31320, 31298, 30842, 30135
Optimus	31074, 31023, 30849, 30797, 30670, 30531
Oritron	31497, 31366
Outlaw	31487
Panasonic	31764, 31763, 31633, 31548, 31518, 31509, 31363, 31350, 31316, 31308, 31288, 30309
Philips	31368, 31365, 31283, 31269, 31268, 31266, 31189, 30189
Pioneer	31384, 31343, 31023, 30630, 30531, 30150, 30014
Polk Audio	31414, 31289, 30189
Proscan	31254
RadioShack	31263

A/V Receivers	
Brand	Code
RCA	31609, 31511, 31390, 31254, 31074, 31023, 30531
Rio	31869
Samsung	31500, 31295
Sansui	31189, 30189
Sanyo	31801
Sharp	31386, 31361
Sharper Image	31416, 31411, 31410, 31409, 31385, 31263, 30797
Sherwood	31077
Sirius	31811, 31627, 31602
Sonic Blue	31869
Sony	31858, 31759, 31758, 31658, 31622, 31558, 31529, 31503, 31458, 31441, 31406, 31382, 31371, 31367, 31258, 31131, 31058
Soundesign	30670
Stereophonics	31023
Sunfire	31313
Sylvania	30797
Teac	31528, 31390, 31267, 31074
Technics	31633, 31518, 31308, 30309
Thorens	31189
Toshiba	30135
Venturer	31390, 30849
Wards	30189, 30014
XM	31414, 31406
Yamaha	31375, 31331, 31276, 31176, 30176

CD Players	
Brand	Code
Aiwa	30157
Akai	30156
Arcam	30157
Audio-Technica	30170
Burmester	30420
California Audio Labs	30303, 30029
Carver	30437, 30299, 30179, 30157
Classic	31297
Denon	30873, 30034, 30003
DKK	30000
DMX Electronics	30157
Emerson	30305
Fisher	31325, 30179, 30174
Garrard	30420, 30393
Gemini	30625
Genexxa	30305, 30032
GPX	31296
Harman/Kardon	31202, 30173, 30157, 30083
Hitachi	30032
Integra	30101

Appendix D: Programming the Remote Control

Programming Codes, continued

CD Players	
Brand	Code
JVC	31294, 30072
Kenwood	30826, 30681, 30626, 30190, 30037, 30028,
KLH	31711, 31373, 31372, 31318
Koss	31317
Krell	30157
LG	31208
Linn	30157
LXI	30305
Magnavox	30305, 30157, 30038
Marantz	30626, 30435, 30180, 30157, 30038, 30029
Mark Levinson	31484
McIntosh	30660, 30290, 30256
MCS	30029
MGA	30083
Miro	30000
Mission	30157
Mitsubishi	30098, 30083
MTC	30625, 30420
NAD	30299, 30019
Nikko	30625, 30174, 30170
NSM	30157
Onkyo	31327, 30868, 30102, 30101
Optimus	31075, 31063, 30468, 30437, 30420, 30305, 30179, 30145, 30087, 30037, 30032, 30000
Panasonic	30752, 30388, 30303, 30029
Parasound	30420
Philips	30626, 30274, 30157
Pioneer	31087, 31063, 31062, 30551, 30468, 30305, 30032
Polk Audio	30157
Proceed	30420
Proton	30157
QED	30157
Quad	30157
Quasar	30029
RadioShack	31075
RCA	31062, 30764, 30468, 30420, 30305, 30179, 30053, 30032
Realistic	30420, 30180, 30179
Rotel	30420, 30157
SAE	30157
Sansui	30305, 30157
Sanyo	30179, 30087
Scott	30305
Sears	30305
Sharp	30861, 30265, 30180, 30037
Sherwood	31067, 30180
Sonic Frontiers	30157
Sony	31364, 30673, 30605, 30604, 30490, 30185, 30100, 30000
Soundesign	30145
Sugden	30157
Symphonic	30305

CD Players	
Brand	Code
TAG McLaren	30157
Tascam	30420
TDK	31208
Teac	30420, 30393, 30378, 30180, 30174
Technics	30303, 30029
Tivoli Audio	31553
Toshiba	30299, 30019
Victor	30072
Wards	30157, 30053
Yamaha	31292, 30888, 30490, 30261, 30187, 30170, 30036,
YBA	30625
Yorx	30461

Cable Boxes	
Brand	Code
ABC	10017, 10014, 10013, 10011, 10008, 10007, 10003, 10001
Allegro	10315, 10153
Americast	10899
Antronix	10207, 10022
Archer	10797, 10207, 10153, 10022
BBT	10267
Belcor	10056
Bell & Howell	10014
Bell South	10899
Cable Star	10056
Cabletenna	10022
Cableview	10022
Century	10153
Citizen	10315, 10153
Clearmaster	10883
ClearMax	10883
Colour Voice	10031, 10025
Comtronics	10040
Contec	10019
Coolmax	10883
Digeo	11187
Digi	10637
Director	10476
Dumont	10637
Eastern	10002
Emerson	10797
Everquest	10040, 10015
Focus	10400
Garrard	10153
GC Electronics	10207, 10056
Gemini	10797, 10015
General Instrument	10810, 10476, 10276, 10011, 10003
GoldStar	10144, 10040
Goodmind	10797

Appendix D: Programming the Remote Control

Programming Codes, continued

Cable Boxes	
Brand	Code
Hamlin	10273, 10259, 10034, 10020, 10009
Hitachi	10011
Hytex	10007
i3 Micro	11602
Jasco	10315, 10153, 10015
Jerrold	10810, 10476, 10276, 10024, 10015, 10014, 10012, 10011, 10003
Linsay	10440
Magnavox	10027
Memorex	10000
Motorola	11376, 11254, 11187, 11106, 10810, 10476, 10276, 10014
Movie Time	10156, 10063
Multitech	10883
Myrio	11602
Novaplex	10618
NSC	10156, 10063
Oak	10019, 10007
Optimus	10021
Pace	11877, 10237, 10008
Panasonic	10107, 10021, 10000
Panther	10637
Paragon	10000
Philips	11305, 10317, 10153, 10031, 10027, 10025
Pioneer	11877, 10877, 10533, 10144, 10023
Popular Mechanics	10400
Pulsar	10000
Quasar	10000
RadioShack	10883, 10797, 10315, 10015
RCA	11256, 10021
Realistic	10207
Recoton	10400
Regal	10279, 10273, 10259, 10020
Regency	10002
Rembrandt	10011
Runco	10000
Samsung	10144, 10040
Scientific Atlanta	11877, 10877, 10477, 10017, 10008,
Seam	10510
Sejin	11602
Signal	10040, 10015
Signature	10011
SL Marx	10040
Sony	11006
Sprucer	10021
Starcom	10015, 10003
Stargate	10797, 10040, 10015
Starquest	10015
StarSight	10422
Supercable	10276
Supermax	10883
Sylvania	10001

Cable Boxes	
Brand	Code
Tandy	10258
TeleCaption	10221
Television	10040
Texscan	10001
TFC	10310
Thomson	11256
Timeless	10418, 10040
Tocom	10013, 10012
Torx	10003
Toshiba	10000
Tristar	10883
Tusa	10015
TV86	10063
Unika	10207, 10153, 10022
United Artists	10007
Universal	10207, 10191, 10153, 10056, 10022,
V2	10883
Viewmaster	10883
Viewstar	10258, 10063, 10027
Vision	10883
Vortex View	10883
Zenith	10899, 10525, 10054, 10000
Zentek	10400

DVD Players/Recorders	
Brand	Code
Adcom	21094
Aiwa	20641
Akai	21089, 20770
Alco	20790
Allegro	20869
Amphion Media Works	20872
AMW	20872
Apex Digital	21100, 21061, 21056, 21020, 21004, 20797, 20796, 20794, 20755, 20717, 20672
Aspire Digital	21407, 21168
Audiologic	20736
Audiovox	21072, 21041, 20790
Axion	21072
B & K	20662, 20655
Bel Canto Design	21571
Blaupunkt	20717
Blue Parade	20571
Broksonic	20695
California Audio Labs	20490
CAVS	21057
Cinea	20831
CineVision	20876, 20869, 20833
Citizen	21277
Coby	21351, 21177, 21165, 21107, 21086, 20852, 20778
Craig	20831

Appendix D: Programming the Remote Control

Programming Codes, continued

DVD Players/Recorders	
Brand	Code
Curtis Mathes	21087
CyberHome	21129, 21117, 21024, 21023, 20874, 20816
Daewoo	21242, 21234, 21172, 21169, 20869, 20833, 20784, 20705
Daytek	20872
Denon	20634, 20490
Desay	21407
Disney	21270, 20675
Dual	21085, 21068
Durabrand	21127
DVD2000	20521
Emerson	21268, 20675, 20591
Enterprise	20591
Fisher	20670
Funai	21334, 21268, 20675
Gateway	21158, 21077, 21073
GE	20815, 20717, 20522
Go Video	21730, 21304, 21158, 21144, 21099, 21075, 21044, 20869, 20833, 20783, 20744, 20741, 20715
Go Vision	21072
GoldStar	20741
GPX	20769, 20699
Gradiente	20490
Greenhill	20717
Grundig	20539
Harman/Kardon	20702, 20582
Hitachi	20664, 20573
Hiteker	20672
iLo	21348
Initial	20717
Integra	20627, 20571
Jaton	21078
JBL	20702
JSI	21423
JVC	21275, 21164, 20867, 20623, 20558
jWin	21051, 21049
Kawasaki	20790
Kenwood	20737, 20682, 20534, 20490
KLH	21149, 21020, 20790, 20717
Konka	20721, 20711
Koss	21423, 20896, 20651
Landel	20826
Lasonic	21173, 20798
Lecson	21533
Lenoxx	21127
LG	20869, 20801, 20741, 20591
LiteOn	21440, 21416, 21158, 21058
Loewe	20511
Magnavox	20675, 20646, 20539, 20503
Malata	21159, 20782
Marantz	20539
McIntosh	21533, 21273

DVD Players/Recorders	
Brand	Code
Memorex	21270, 20831, 20695
Microsoft	20522
Mintek	20839, 20717
Mitsubishi	21521, 20521
Momitsu	21082
Myryad	20894
NAD	20741, 20692, 20591
Nakamichi	21222
NEC	20785
Nesa	20717
Next Base	20826
NexxTech	21402
Norcent	21265, 21107, 21003, 20872
Onkyo	20792, 20627, 20503
OptoMedia Electronics	20896
Oritron	20651
Panasonic	21762, 20703, 20632, 20503, 20490
Philips	21354, 21267, 20675, 20646, 20539, 20503,
PianoDisc	21024
Pioneer	21571, 20632, 20631, 20571, 20525
Polaroid	21086, 21061, 21020
Polk Audio	20539
Portland	20770
Princeton	20674
Proceed	20672
Proscan	20522
ProVision	20778
Qwestar	20651
RCA	20822, 20790, 20717, 20571, 20522
Rio	20869
RJTech	21360
Rotel	21178, 20623
Rowa	20823
Sampo	20752, 20698
Samsung	21075, 21044, 20820, 20744, 20573, 20490
Sansui	20695
Sanyo	20873, 20695, 20670
Sensory Science	21158
Sharp	21256, 20752, 20675, 20630
Sharper Image	21117
Sherwood	21077, 21043, 20770, 20633
Shinsonic	20839, 20533
Sigma Designs	20674
Sonic Blue	21099, 20869
Sony	21533, 21431, 21033, 20864, 20533
Sungale	21074
SVA	21105, 20860
Sylvania	21268, 20675
Symphonic	21268, 20675
TAG McLaren	20894
Teac	20809, 20790
Technics	20703, 20490
Technosonic	20730

Appendix D: Programming the Remote Control

Programming Codes, continued

DVD Players/Recorders	
Brand	Code
Techwood	20692
Terapin	21031
Theta Digital	20571
Toshiba	21154, 20695, 20503
Tredex	20804, 20803, 20800, 20799
Urban Concepts	20503
US Logic	20839
Venturer	20790
Vizio	21226, 21064
Vocopro	21027
Xbox	20522
Xwave	21001
Yamaha	20545, 20539, 20490
Yamakawa	20872
Zenith	20869, 20741, 20591, 20503
Zoece	21265

Laser Disc Players	
Brand	Code
Aiwa	20203
Carver	20323, 20194, 20064
Denon	20243, 20241, 20172, 20059
Disco Vision	20023
Funai	20203
Harman/Kardon	20194
Hitachi	20023
Kenwood	20258
Magnavox	20243, 20241, 20217, 20194
Marantz	20194, 20064
Mitsubishi	20059
NAD	20059
Optimus	20059
Panasonic	20204
Philips	20194, 20064
Pioneer	20059, 20023
Polk Audio	20194
Quasar	20204
Realistic	20203
Samsung	20323
Sega	20023
Sony	20270, 20201, 20193
Technics	20204
Theta Digital	20194
Yamaha	20451, 20217

Satellite Receivers	
Brand	Code
AlphaStar	10772
Chaparral	10216
Crossdigital	11109

Satellite Receivers	
Brand	Code
DirecTV	11856, 11749, 11640, 11639, 11609, 11444, 11443, 11442, 11414, 11392, 11377, 11142, 11109, 11108, 11076, 10819, 10749, 10724, 10639, 10566, 10392, 10247, 10099
Dish Network System	11775, 11505, 11170, 11005, 10775,
Dishpro	11775, 11505, 11005, 10775
Echostar	11775, 11505, 11170, 11005, 10775
Expressvu	11775, 10775
GE	10566, 10392
General Instrument	10869
GOI	11775, 10775
Goodmans	11246
Hisense	11535
Hitachi	11250, 10819
HTS	11775, 10775
Hughes Network Systems	11749, 11444, 11443, 11442, 11142, 10749
iLo	11535
Jerrold	10869
JVC	11775, 11170, 10775
LG	11414, 11226
Magnavox	10724, 10722
Memorex	10724
Mitsubishi	10749
Motorola	10869, 10856
NEC	11270
Next Level	10869
Panasonic	10701, 10247
Paysat	10724
Philips	11749, 11442, 11142, 11076, 10819, 10749, 10724, 10722, 10099
Pioneer	11442
Proscan	10566, 10392
Proton	11535
RadioShack	10869
RCA	11392, 10855, 10566, 10392, 10143,
Samsung	11609, 11442, 11377, 11276, 11142, 11109, 11108
Sanyo	11219
Sony	11640, 11639, 10639
Star Choice	10869
Tivo	11444, 11443, 11442, 11142
Toshiba	11749, 11285, 10819, 10790, 10749
UltimateTV	11640, 11392
Uniden	10724, 10722
US Digital	11535
USDTV	11535
Voom	10869
Zenith	11856

Appendix D: Programming the Remote Control

Programming Codes, continued

VCRs and DVRs	
Brand	Code
ABS	21972
Admiral	20479, 20209, 20048
Adventura	20000
Aiko	20278
Aiwa	20307, 20124, 20037, 20000
Akai	20242, 20175, 20106, 20061, 20041
Alienware	21972
America Action	20278
American High	20035
Asha	20240
Audiovox	20278, 20037
Beaumarck	20240
Bell & Howell	20104
Broksonic	20479, 20295, 20209, 20184, 20121, 20002
Calix	20037
Canon	20035
Capehart	20020
Carver	20081
CCE	20278, 20072
Citizen	20278, 20037
Colt	20072
Craig	20271, 20240, 20072, 20047, 20037
Curtis Mathes	20760, 20162, 20060, 20041, 20035
Cybernex	20240
CyberPower	21972
Daewoo	20637, 20561, 20278, 20045, 20020
Daytron	20020
Dell	21972
Denon	20042
DirecTV	20739
Durabrand	20039, 20038
Dynatech	20000
Electrohome	20043, 20037
Electroponic	20037
Emerex	20032
Emerson	21593, 20637, 20593, 20561, 20479, 20295, 20278, 20212, 20209, 20208, 20184, 20121, 20068, 20061, 20043, 20037, 20036, 20002, 20000
Fisher	20104, 20066, 20054, 20047
Fuji	20035, 20033
Funai	21593, 20593, 20000
Garrard	20000
Gateway	21972
GE	20761, 20760, 20240, 20202, 20060, 20035
Go Video	20643, 20526, 20432, 20240
GoldStar	20038, 20037
Gradiente	20000
Harley Davidson	20000

VCRs and DVRs	
Brand	Code
Harman/Kardon	20081, 20075, 20038
Harwood	20072, 20068
Headquarter	20046
Hewlett Packard	21972
HI-Q	20047
Hitachi	20105, 20089, 20042, 20041, 20000
Howard Computers	21972
HP	21972
Hughes Network Systems	20739, 20042
Humax	20739
Hush	21972
iBUYPOWER	21972
Jensen	20041
JVC	21162, 20067, 20041, 20008
KEC	20278, 20037
Kenwood	20067, 20041, 20038
KLH	20072
Kodak	20037, 20035
LG	21037
Linksys	21972
Lloyd's	20208, 20000
Logik	20072
LXI	20037
Magnasonic	20593
Magnavox	20593, 20563, 20149, 20110, 20081, 20039, 20035, 20000
Magnin	20240
Marantz	20081, 20035
Marta	20037
Matsushita	21162, 20162, 20035
Media Center PC	21972
MEI	20035
Memorex	21262, 21162, 21037, 20479, 20307, 20240, 20209, 20162, 20104, 20048, 20047, 20046, 20039, 20037, 20035, 20000
MGA	20240, 20061, 20043
MGN Technology	20240
Microsoft	21972
Mind	21972
Minolta	20105, 20042
Mitsubishi	20443, 20242, 20214, 20173, 20075, 20067, 20061, 20043
Motorola	20048, 20035
MTC	20240, 20000
Multitech	20072, 20000
NEC	20104, 20067, 20041, 20040, 20038
Nikko	20037
Nikon	20034
Niveus Media	21972
Noblex	20240
Northgate	21972
Olympus	20035
Onkyo	20222
Optimus	21262, 21162, 21062, 21048, 20593, 20432, 20162, 20104, 20048, 20037

Appendix D: Programming the Remote Control

Programming Codes, continued

VCRs and DVRs	
Brand	Code
Optonica	20062
Orion	20479, 20295, 20209, 20184, 20002
Panasonic	21262, 21162, 21062, 20616, 20225, 20162, 20077, 20035
Penney	20240, 20054, 20042, 20040, 20038, 20037, 20035
Pentax	20105, 20042
Philco	20035
Philips	21181, 21081, 20739, 20618, 20110, 20081, 20062, 20035
Pilot	20037
Pioneer	20067
Polk Audio	20081
Portland	20020
Profitronic	20240
Proscan	20761, 20760, 20202, 20060
Protec	20072
Pulsar	20039
Quarter	20046
Quartz	20046
Quasar	21162, 20162, 20077, 20035
RadioShack	21037, 20000
Radix	20037
Randex	20037
RCA	20880, 20761, 20760, 20240, 20202, 20149, 20106, 20105, 20077, 20060, 20042
Realistic	20104, 20066, 20062, 20048, 20047, 20046, 20037, 20035, 20000
ReplayTV	20616, 20614
Ricavision	21972
Ricoh	20034
Runco	20039
Salora	20075
Samsung	20739, 20240, 20045
Samtron	20643
Sanky	20048, 20039
Sansui	20479, 20271, 20209, 20067, 20041, 20000
Sanyo	20240, 20159, 20104, 20047, 20046
Scott	20212, 20210, 20184, 20121, 20045, 20043
Sears	20105, 20104, 20066, 20054, 20047, 20046, 20042, 20037, 20035, 20000
Sharp	20848, 20062, 20048
Shintom	20072
Shogun	20240
Singer	20072
Sonic Blue	20616, 20614
Sony	21972, 21032, 20636, 20035, 20034, 20033, 20032, 20000
Stack 9	21972

VCRs and DVRs	
Brand	Code
STS	20042
Sylvania	21593, 20593, 20110, 20081, 20043, 20035, 20000
Symphonic	21593, 20593, 20000
Systemax	21972
Tagar Systems	21972
Tatung	20041
Teac	20041, 20000
Technics	20162, 20035
Teknika	20037, 20035, 20000
Thomas	20000
Tivo	21503, 20739, 20636, 20618
TMK	20240, 20208, 20036
Toshiba	21972, 21503, 21008, 20212, 20210, 20209, 20066, 20045, 20043
Totevision	20240, 20037
Touch	21972
Unitech	20240
Vector	20045
Vector Research	20040, 20038
Video Concepts	20061, 20045, 20040
Videomagic	20037
Videosonic	20240
Viewsonic	21972
Villain	20000
Voodoo	21972
Wards	20760, 20240, 20212, 20149, 20081, 20072, 20062, 20060, 20048, 20047, 20042, 20035, 20000
White Westinghouse	20637, 20209, 20072
XR-1000	20072, 20035, 20000
Yamaha	20038
Zenith	21139, 20637, 20479, 20209, 20039, 20034, 20033, 20000
ZT Group	21972

Appendix E: Troubleshooting

System Reset Button

If the TV does not respond to the remote control, front panel controls, or will not power on/off, press the **SYSTEM RESET** button on the front panel with a pointed object, such as the point of a pencil or end tip of a paperclip.

The green LED will flash quickly for about one minute. When the green LED stops flashing, you may turn on the TV. The changes you made most recently, before using **SYSTEM RESET**, may be lost. Changes you made previously, however, are not lost.

TV Reset Menu

1. Select any device from the Input Selection menu.
2. Press **MENU** followed by **1 2 3** to open the Reset Service Menu. **CAUTION:** All settings except V-Chip will be reset to the original factory defaults

Read on-screen warnings before proceeding, as some user data or settings may be erased.

3. Press **ENTER** to reset TV defaults.

Demo Mode

This TV has a demo mode for use in retail stores. To turn off demo mode:

1. Press **MENU**.
2. When the Main menu appears with **Setup** highlighted, press **ENTER**.
3. When the Setup menu opens, press **▶** to highlight the on-screen **Demo Mode Off** button.
4. Press **ENTER**.

Service and Support

Service

If you are unable to correct a problem with your TV, consult your Mitsubishi dealer or a Mitsubishi Consumer Relations at (800) 332-2119.

- DO NOT adjust any controls other than those described in this Owner's Guide.
- DO NOT remove the protective back cover of your TV.

Support

- To order replacement or additional remote controls, lamp cartridges, or Owner's Guides, visit our website at www.mitsuparts.com or call (800) 553-7278.
- For questions:
 - ◆ Call Consumer Relations at 800-332-2119.
 - ◆ E-mail: MDEAservice@mdea.com
 - ◆ Website: www.mitsubishi-tv.com

Important

All lamps replaced under warranty must be returned to Mitsubishi where they will be inspected for defect verification.

Appendix E: Troubleshooting, continued

General TV Operation		
	Symptom	Remarks
1.	A fan is running even while the TV is powered off.	Normal TV operation. When the TV is off, internal components continue to draw power and must be cooled by the fan.
2.	The TV remote control does not work.	<ul style="list-style-type: none"> • Check that the batteries are installed correctly. • Check that the slide switch is set to TV. • Be no more than 20 feet from the TV when using the remote control. • Program the remote control to operate the TV or other device.
3.	TV does not respond to the remote control or to front panel control and TV will not power on or off.	Use the System Reset button.
4.	When a device is selected from the Input Selection menu, the screen is blue (no signal source).	<ul style="list-style-type: none"> • Make sure the selected device is turned on. • Begin play of the VCR.
5.	Devices are grayed out in the Input Selection menu or the Split Screen Input Selection menu.	<ul style="list-style-type: none"> • A recording is in progress. Cancel the recording to select the device. • PCs and 1080p sources cannot display in the Split Screen sub-picture.
6.	You have forgotten your Parental Lock pass code.	See Appendix A, Bypassing the Parental Lock.
7.	Rating restrictions are not working.	<p>Open the Parental Lock menu and:</p> <ul style="list-style-type: none"> • Verify that the U.S. Ratings or Other Ratings setting is On. • Check the Lock Time/Unlock Time to check if rating restrictions are disabled. • Rating restrictions apply only to content on ANT 1 and ANT 2, INPUT 1–3, and IEEE 1394 inputs.
8.	On-screen displays appear each time you change a function.	Normal TV operation.
9.	Cable provider needs information to start CableCARD™ service.	On the remote control, press MENU and then enter the numbers 999 to display the Host ID and CableCARD™ ID information.

TV Channels		
	Symptom	Remarks
1.	The TV takes several seconds to respond to channel changes.	<ul style="list-style-type: none"> • It is normal for digital channels to take longer to tune in. • Press ENTER after a channel number to avoid delays. • Use a 4-digit number for an over-the-air digital channel. • Use a 6-digit number for digital cable channels if your cable service is able to recognize 6-digit channel numbers.
2.	You cannot access a channel.	<ul style="list-style-type: none"> • Use number keys instead of CH \wedge/\vee. • Be sure the channel you want to view is in memory. See “Channel Menu” in chapter 5, “TV Menu Settings.” • Check that the TV is turned to the correct device or antenna for that channel by pressing the INPUT button. • Make sure the Parental Lock is off. • If you cannot tune to a virtual digital channel even though the TV has already memorized digital channels, tune to the actual channel number used by the broadcaster. The virtual channel will then be automatically added to memory.
3.	Name options are not available for some channels.	Only memorized analog channels can be named.
4.	When ChannelView™ list is displayed, information appears incomplete	Available information is sent from the broadcaster or cable provider. No other data is available.

Appendix E: Troubleshooting, continued

TV Power On/Off		
Symptom		Remarks
1.	TV takes an excessively long time to power on.	<ul style="list-style-type: none"> When switched on, the TV needs time to boot up, just as a computer does. Also, the TV's lamp requires a few moments to heat up to full brightness. TV Energy Mode is set to Low Power. To change TV Energy Mode to Fast Power On: Press MENU, open the Setup menu, highlight the Fast Power On radio button, press ENTER.
2.	You cannot program the TV to turn on automatically (Timer function)	<ul style="list-style-type: none"> The TV may be locked. The clock may not be set. A time-delayed recording may have started. TV Energy Mode is set to Low Power. Change to Fast Power On in Setup menu.
3.	The TV will not turn on after being plugged in.	If green light on front panel is blinking, wait for at least one minute for the light to turn off, then press POWER again.
4.	TV turned itself off and the light on the front panel started to blink.	<ul style="list-style-type: none"> Momentary power fluctuation caused the TV to turn off to prevent damage. Wait for the green light to stop flashing and turn the TV on again. If the TV does not stay on, use the System Reset button on the front panel. If this happens frequently, obtain an AC line power conditioner/surge protector. An unusual digital signal may have been received, triggering a protection circuit. Wait for the light to stop flashing and turn TV on.
5.	TV will not power off.	Use the System Reset button.

Picture		
Symptom		Remarks
1.	Picture does not look like a high-definition picture.	Not all signals are high-definition signals. To receive high-definition programming from your cable or satellite provider, you must subscribe to the provider's high-definition service. Some over-the-air broadcasts are in high-definition and can be received with a high-quality antenna suited to your location.
2.	Picture is getting dimmer over time.	The lamp is nearing the end of its life. Order a new lamp. See Appendix C for ordering information and replacement instructions.
3.	Split Screen does not display a sub-picture.	<ul style="list-style-type: none"> Make sure the Parental Lock is off. Not all inputs can be displayed as a sub-picture.
4.	CableCARD channel is not shown as Split Screen sub-picture when CableCARD channel is the main image.	CableCARD allows only one channel at a time to be used.
5.	There is a large black or gray rectangle on the screen.	The TV's analog closed captioning has been set to "text" mode in the Captions menu. Turn off because there is no text information being broadcast.
6.	You cannot view a picture when playing a VHS tape.	Check your VCR's owner's guide for further troubleshooting.
7.	VCR or DVD player's on-screen menus jitter up and down.	Possible cause: Many VCRs and DVD players provide on-screen menus at only half-resolution. These lower-resolution graphics may appear to jitter up and down when the TV converts them to high-definition graphics.
8.	When viewing a stopped VCR, white lines are rolling on the screen.	<ul style="list-style-type: none"> Turn off video mute for the VCR. Begin playing the tape. Change the VCR input to the antenna input.

Appendix E: Troubleshooting, continued

Picture		
	Symptom	Remarks
9.	Screen is black when trying to view digital channels or IEEE 1394 device.	The PerfectColor™ color balance has been incorrectly set. Press VIDEO repeatedly until you see the PerfectColor option and press ENTER to open the PerfectColor™ menu.
10.	DVCR analog/digital problems.	If the tape is currently playing but no picture displays, there may be a mismatch of the media with the display. Press INPUT to display the Input Selection menu. Press ENTER for the DVCR device. If digital is selected, try analog, or if analog is selected, try digital.
11.	Cannot see a picture from a DV Camcorder.	The TV cannot process DV signals. Use analog audio and video connections.

Indicators		
	Symptom	Remarks
1.	Lamp indicator light is a constant red.	Turn the TV off for at least 2 minutes. Turn it back on. If light is still red, the lamp has failed. Replace it. See Appendix C for lamp replacement information. For questions, please call Mitsubishi Consumer relations at (800) 332-2119.
2.	Lamp indicator light is a flashing yellow.	Lamp cover door is open or lamp cartridge is not secure. See Appendix C for lamp replacement information.
3.	Status indicator light is a steady yellow.	Room temperature has exceeded proper levels. Cool the room.
4.	Status indicator light is a steady/flashing red.	Service is required. Contact your dealer or a Mitsubishi Authorized Service Center to arrange for a service evaluation. Listings of Mitsubishi Authorized Service locations can be obtained from our web site, www.mitsubishi-tv.com or by calling 1-800-332-2119.

Sound		
	Symptom	Remarks
1.	There is no sound even when the volume is turned up.	<ul style="list-style-type: none"> • Check if the MUTE button is on. • The TV's "Listen to:" setting may be set to SAP. • Check that the TV Speakers setting is On in the Audio/Video menu. • If using an A/V receiver, check audio source in Input Selection menu. • Perform a System Reset.
2.	The sound does not match the screen picture.	<ul style="list-style-type: none"> • The TV's Listen to: setting may be set to SAP. • If using stereo or A/V receiver speakers, check their input selection. • If using stereo or A/V receiver, check that DIGITAL AUDIO OUT and/or AUDIO OUT LEFT/RIGHT on TV's back panel is connected to the A/V receiver. • NetCommand® is set up incorrectly.

Memory Card Reader		
	Symptom	Remarks
1.	TV is not responding after pulling out a memory card during playback.	<ul style="list-style-type: none"> • Press STOP or wait until playback is complete before removing memory card. • Turn the TV off for 5 to 10 seconds and then turn it back on. • Reset the TV using the SYSTEM RESET button.
2.	Can't see a thumbnail picture in the JPEG menu, or can't see a track/song name in the Playlist menu.	File does not meet file standards for playback.
3.	TV can't play or stop a memory card.	<ul style="list-style-type: none"> • Turn the TV off and then back on. • Some cards take longer to read than others. If card reader LED is blinking, wait until blinking stops and try again.

Appendix E: Troubleshooting, continued

IEEE 1394 Recording		
Symptom		Remarks
1.	Program to be recorded was correctly selected from ChannelView, however, incorrect program was recorded.	The broadcaster supplied program information that was incorrect and/or was changed after a recording was added to the Record List.
2.	Incomplete ChannelView program recorded.	Recording device may lack sufficient blank space to make a full recording.
3.	ChannelView program recording failed.	<ul style="list-style-type: none"> • Connection and compatibility issues with IEEE 1394 (FireWire®) digital devices. This may include too many Firewire devices in use at one time, or the recording device not understanding the record command. • Television lost power long enough to lose current clock time. • Analog VCR power was left off. • TV energy Mode was set to Low Power. Change TV Energy mode to Fast Power On. Press MENU, open the Setup menu, highlight the Fast Power On radio button, press ENTER.
4.	Cannot record to or from the IEEE 1394 device, including dubbed recordings.	<ul style="list-style-type: none"> • To initiate a recording to IEEE 1394 device, press the  (RECORD) key. The Record menu displays allowing setup of the recording. • The source device for the recording is not powered on. • When dubbing, the destination device for the recording is not powered on. • The wrong medium (analog tape for digital recording, or digital tape for the analog recording) is in the device. • The program is copy protected. • The program has already been recorded once and the copy protection only allows one recording. • Unapproved source device for copy protected material. • The recording device can not decode the copyright signal included in the signal source (try another device if available). • The playing device (for dubbing) does not support copyrighted material. • Source for recording is copyrighted • Too many IEEE 1394 devices in network. Insufficient bandwidth available. Disconnect unused devices. • Source Device has higher communication speed (S 400) than record device. If possible, reverse devices, play in the slower device and record in the faster device.

IEEE 1394 Devices		
Symptom		Remarks
1.	Excessive digital artifacts appear when viewing an IEEE 1394 device.	<ul style="list-style-type: none"> • The IEEE 1394 cable is too long; 15 feet between devices is the maximum. • There may be a slow device in the middle of the IEEE 1394 network. Move the slow devices to the end so that connections for faster devices do not pass through them.
2.	D-VHS recordings for digital cable have drop-outs (loss of picture or sound), or no playback.	Digital cable signals on IEEE 1394 can exceed the data rate standards supported by DVCR.

Appendix E: Troubleshooting, continued

IEEE 1394 Devices	
Symptom	Remarks
3. There is no audio and video from the IEEE 1394 device.	<ul style="list-style-type: none"> The device is not turned on. Turn the device power on. No media (tape or disc) is inserted into the device. The media is blank (has no recording). The play command failed - Try pressing play again on the device's remote control or front panel. The device is already in use (for example, the device is currently recording). The source is copy-protected or violates copy protection. The device's digital video signal is not supported by the TV, as may be the case with an IEEE 1394 signal from a computer. Use analog connections instead, if available. The device is not an audio/video device. Too many other devices are already communicating over IEEE 1394. Remove or stop some devices and try again.
4. The IEEE 1394 Device is no longer listed in the Input Selection menu.	<ul style="list-style-type: none"> The IEEE 1394 plug is disconnected or loose. The IEEE 1394 device has not been powered on. Turn on. The device has not been discovered. The device is not an audio/video device
5. The IEEE 1394 device cannot be selected (is grayed out).	<ul style="list-style-type: none"> The device may be busy with a recording. Cancel the recording. You have connected more than seven IEEE 1394 devices. Unplug the eighth device and one other device. Plug the new device back in.
6. MENU button does not display a menu.	<ul style="list-style-type: none"> The IEEE 1394 device does not provide a menu. The TV cannot support IEEE 1394 menus.
7. All IEEE 1394 devices disappear.	<ul style="list-style-type: none"> The connected devices must not be in a loop that returns to the TV. Make sure a device is connected at the end. Disconnect all the cables and devices from the TV. Replace them one by one to locate the problem device or cable. Use System Reset (front control panel).
8. An IEEE 1394 device has been plugged in but does not appear in the Input Selection menu (not discovered).	<ul style="list-style-type: none"> The IEEE 1394 connection to the TV or another device is not secure or is loose. The IEEE 1394 device is not powered on. A device in the IEEE 1394 chain is not powered on. Turn on all the devices. The device discovery can take as long as a minute to initiate. IEEE 1394 cable is too long (maximum of 15 feet between devices). The IEEE 1394 device uses an incompatible protocol and will not be discovered
9. Cannot view video from an IEEE 1394 DV camcorder.	Use analog connections for video and audio. You can still use the IEEE 1394 connection for control functions, however.
10. An IEEE 1394 device is not responding properly.	<ul style="list-style-type: none"> Unplug the device's power cord. Wait at least ten seconds and plug it in again. Some IEEE 1394 devices are not supported by the TV because of incompatible standards.

Appendix E: Troubleshooting, continued

NetCommand		
Symptom		Remarks
1.	Cannot see the A/V Receiver menu.	The A/V Receiver is not connected to any video input of the TV. To check the A/V Receiver menu, temporarily plug into an unused input of the TV, such as Input 3. Exit the Auto Input Sensing screen and select Input 3 from the Input Selection menu. Press MENU.
2.	NetCommand unable to learn specific device keys.	<ul style="list-style-type: none"> • Device does not use IR format for remote control signal. ITT and RF formats cannot be learned. • Room lighting may affect the signal. Have the remotes very close (6 inches or less) to the TV during Learning. • If learning a Mitsubishi remote control, make sure slide switch is not set to TV position. • Some, but not all, device key functions can be learned by NetCommand. For example, POWER and PLAY may be learned, but other functions may not. • The signal from the remote control may not be strong enough. Insert fresh batteries and try Learning again.
3.	The A/V Receiver is the selected audio source but there is no sound.	Check to see if the A/V Receiver power is turned on. After the power is turned on, redisplay the Input Selection menu and press ENTER to allow NetCommand to correctly select the A/V Receiver input.

TV Guide On Screen		
<i>(see the separate TV Guide On Screen® Interactive Program Guide User's Manual for detailed information)</i>		
Symptom		Remarks
1.	TV Guide On Screen® system shows no program listings.	<ul style="list-style-type: none"> • Program listings are downloaded while the TV is off and the cable box is left on. It may take up to 24 hours to begin to receive TV program listings. It may take up to one week to receive all eight days of TV program listings. • Invalid ZIP code was entered at the initial TV Guide On Screen system setup. Select NetCommand from the main TV menu, then Guide and enter the correct ZIP code. • Check the connections between the TV and the TV Guide On Screen input (cable, antenna or cable box and IR cable). At least one antenna connection must be associated with the TV Guide On Screen system to receive program listings. • When using CableCARD™, the cable company may have converted the TV Guide On Screen host channel to a digital format and lost the information. Connect an antenna to ANT 2 and memorize the antenna channels in the TV Setup menu. Add ANT 2 to the TV Guide On Screen setup in the NetCommand menu. You may be able to download from the antenna information for both cable and antenna.
2.	TV Guide On Screen system program listings don't match actual programs	<ul style="list-style-type: none"> • Incorrect ZIP code was entered at initial TV Guide system setup. Select NetCommand menu, then Guide to enter the correct ZIP code. • For cable programs, there may be more than one cable company in your ZIP code. Refer to the TV Guide On Screen system manual for instructions on the Setup Service.
3.	TV Guide On Screen system does not change channels on the cable box.	<ul style="list-style-type: none"> • Cable box is not set up in NetCommand. The TV Guide On Screen system uses NetCommand to control the cable box and VCR. To correct, select the cable box in the Input Selection menu, open the NetCommand menu, and select Learn. See chapter 3, "TV Setup." • NetCommand IR emitter is not in place or properly positioned in front of the cable box remote sensor.

Trademark and License Information

LICENSOR'S SUPPLIERS DO NOT MAKE OR PASS ON TO END USER OR ANY OTHER THIRD PARTY, ANY EXPRESS, IMPLIED OR STATUTORY WARRANTY OR REPRESENTATION ON BEHALF OF SUCH SUPPLIERS, INCLUDING, BUT NOT LIMITED TO THE IMPLIED WARRANTIES OF NON-INFRINGEMENT, TITLE, MERCHANTABILITY OR FITNESS FOR A PARTICULAR PURPOSE.

CableCARD™ is a trademark of Cable Television Laboratories, Inc.

CompactFlash® and CF are trademarks of the CompactFlash Association.

DCR™ Certification Logo is a trademark of the Consumer Electronics Association.

Digital Light Processing™ and DLP™ are trademarks of Texas Instruments.

Manufactured under license from Dolby Laboratories. Dolby is a trademark of Dolby Laboratories.

DTVLink™ Certification Logo is a trademark of the Consumer Electronics Association.

Firewire® is a trademark of Apple Computer, Inc. registered in the U.S. and other countries.

HDMI™ the HDMI logo and High-Definition Multimedia Interface are trademarks or registered trademarks of HDMI Licensing LLC.

This product incorporates copyright protection technology that is protected by U.S. patents and other intellectual property rights. Use of this copyright protection technology must be authorized by Macrovision, and is intended for home and other limited pay-per-view uses only unless otherwise authorized by Macrovision. Reverse engineering or disassembly prohibited.



Memory Stick™ and Memory Stick PRO™ are trademarks of Sony Corp.

Microdrive™ is a trademark of IBM and Hitachi.

This product includes technology owned by Microsoft Corporation and cannot be used or distributed without a license from Microsoft Licensing, Inc.

MultiMediaCard™ is trademark of Infineon Technologies and licensed to the MultiMediaCard Association.

The  logo and the words "Simplify™" and "Simplify HD™" are the trademarks of Silicon Image, Inc.

SmartMedia™ is a trademark of Toshiba Corp.

In the United States, TV GUIDE and other related marks are registered marks of Gemstar-TV Guide International, Inc. and/or one of its affiliates.

The TV Guide On Screen® system is manufactured under license from Gemstar-TV Guide International, Inc. and/or one of its affiliates.

The TV Guide On Screen system is protected by one or more of the following United States patents 4,908,713; 6,498,895; 6,850,693; 6,396,546; 5,940,073; 6,239,794 to Gemstar-TV Guide International, Inc. and/or its subsidiaries.

Gemstar-TV Guide International, Inc. and/or its related affiliates are not in any way liable for the accuracy or availability of the program schedule information or other data in the TV Guide On Screen system and cannot guarantee service availability in your area. In no event shall Gemstar-TV Guide International, Inc. and/or its related affiliates be liable for any damages in connection with the accuracy or availability of the program schedule information or other data in the TV Guide On Screen system.

ChannelView™, ClearThought®, NetCommand®, PerfectColor™, QuickView™, ViewPoint® are trademarks of Mitsubishi Digital Electronics America, Inc.

Mitsubishi TV Software

END-USER LICENSE AGREEMENT FOR EMBEDDED SOFTWARE

IMPORTANT – READ CAREFULLY: This License Agreement is a legal agreement between you (either an individual or an entity) and Mitsubishi Digital Electronics America, Inc. (MDEA) for all software pre installed and/or provided along with this television (“Software”). By utilizing this television and Software, you agree to be bound by the terms of this License Agreement.

The Software is protected by United States copyright laws and international treaty provisions, as well as other intellectual property laws and treaties. The Software is licensed, not sold.

1. **LICENSE GRANT.** MDEA grants you a non-exclusive, non-transferable, limited right and license to use one copy of the Software only with the Mitsubishi television model that included this owner’s guide and owned by you.

2. **RIGHTS AND LIMITATIONS.**

Software Not for Resale. You may not resell or otherwise transfer for value the Software, except in conjunction with a sale of the TV that Software has been pre installed.

Prohibition on Reverse Engineering, Decompilation and Disassembly. The Software contains trade secrets or other proprietary material in its human perceivable form and to protect them, you may not reverse engineer, decompile, or disassemble, or otherwise reduce the Software to any human perceivable form, except to the extent that the foregoing restriction is expressly prohibited by applicable law.

Separation of Components. The Software is licensed as a single product. Its component parts may not be separated for use on more than one TV.

No Rental. You may not rent, lease, lend, or sublicense the Software.

Trademarks. This License Agreement does not grant you any rights to any trademarks of MDEA.

3. **VIOLATIONS.** You understand that any use, copying or transfer of the Software, except as permitted pursuant to this License, may subject you to serious criminal and civil penalties including damages and an award to MDEA of attorneys’ fees in connection with any violation of this License. You further understand that you may be held legally responsible for any copyright infringement or other violation of intellectual property rights that is caused, encouraged, or induced by your failure to abide by the terms of the License. This license is effective until terminated, and will terminate immediately without notice from MDEA or judicial resolution if you fail to comply with any provision of this License.

4. **COPYRIGHT.** All title and intellectual property rights in and to the Software (including but not limited to any images, photographs, animations, video, audio, music, text, and “applets” incorporated into the Software), and any accompanying printed materials are owned by or licensed to MDEA. All title and intellectual property rights in and to the content which may be accessed through use of the Software is the property of the respective content owner and may be protected by applicable copyright or other intellectual property laws and treaties. This License Agreement grants you no rights to use such content, except that you own the media on which the Software is recorded, but MDEA and its licensors retain ownership of the Software itself. All rights not expressly granted are reserved by MDEA.

5. **EXPORT RESTRICTIONS.** MDEA is licensing the Software for use within the United States. You agree that you will not export or re-export the Software. You specifically agree not to export or re-export the Software: (i) to any country to which the U.S. has embargoed or restricted the export of goods or services, which currently include, but are not necessarily limited to Cuba, Iran, Iraq, Libya, North Korea, Sudan, and Syria, or to any national of any such country, wherever located, who intends to transmit or transport the Software back to such country; (ii) to any person or entity who you know or have reason to know will utilize the Software in the design, development, or production of nuclear, chemical, or biological weapons; or (iii) to any person or entity who has been prohibited from participating in U.S. export transactions by any federal agency of the U.S. government. You warrant and represent that neither the BXA nor any other U.S. federal agency has suspended, revoked, or denied your export privileges.

6. **DISCLAIMER OF WARRANTY. EXCEPT AS OTHERWISE PROVIDED IN THIS LICENSE OR IN THE LIMITED WARRANTY APPLICABLE TO THE TV, MDEA MAKES NO OTHER WARRANTIES OF ANY KIND WHATSOEVER REGARDING THE SOFTWARE AND HEREBY EXPRESSLY DISCLAIMS ALL WARRANTIES OF ANY KIND WHATSOEVER, EXPRESS OR IMPLIED, WITH RESPECT TO THE SOFTWARE. ALL IMPLIED WARRANTIES, INCLUDING, WITHOUT LIMITATION, THE IMPLIED WARRANTIES OF MERCHANTABILITY AND FITNESS FOR A PARTICULAR PURPOSE ARE HEREBY EXPRESSLY DISCLAIMED BY MDEA. IN NO EVENT SHALL MDEA BE LIABLE TO YOU OR ANY THIRD PARTIES, IN CONTRACT, IN TORT OR OTHERWISE, FOR ANY DIRECT, INDIRECT, SPECIAL, INCIDENTAL OR CONSEQUENTIAL DAMAGES OF ANY KIND OR NATURE. BECAUSE SOME JURISDICTIONS DO NOT ALLOW THE EXCLUSION OR LIMITATION OF IMPLIED WARRANTIES, THE ABOVE LIMITATION MAY NOT APPLY TO YOU.**

7. **LIMITATION OF LIABILITY. MDEA SHALL NOT, UNDER ANY CIRCUMSTANCES BE LIABLE TO YOU OR ANY THIRD PARTIES FOR ANY DAMAGES OF ANY NATURE, WHETHER INDIRECT, SPECIAL, INCIDENTAL, CONSEQUENTIAL OR OTHERWISE, INCLUDING, BUT NOT LIMITED TO, ANY CLAIMS FOR LOST PROFITS, LOSS OF GOOD WILL OR EXPENDITURES MADE OR COMMITTED FOR IN RELIANCE ON THE CONTINUATION OF THIS LICENSE. YOU AGREE THAT NEITHER MDEA’S BREACH OF THIS LICENSE NOR ITS FAILURE TO REPAIR A DEFECT, ERROR OR BUG SHALL CONSTITUTE A FAILURE OF THE ESSENTIAL PURPOSE OF THIS LICENSE. BECAUSE SOME JURISDICTIONS DO NOT ALLOW THE EXCLUSION OR LIMITATION OF LIABILITY FOR CONSEQUENTIAL OR INCIDENTAL DAMAGES, THE ABOVE LIMITATIONS MAY NOT APPLY TO YOU. MDEA’S liability to you for direct damages for any cause whatsoever and regardless of the form of the action, will be limited to the money paid by you for the TV (based on fair market value of the TV) that caused the damages.**

8. **GENERAL.** This License Agreement will be governed by the laws of the State of California.

WARNING: This product contains chemicals known to the State of California to cause cancer and/or birth defects or other reproductive harm.

Mitsubishi DLP™ Projection Television Limited Warranty

MITSUBISHI DIGITAL ELECTRONICS AMERICA, INC. (“MDEA”) warrants as follows to the original purchaser of this television from an authorized MITSUBISHI Audio/Video Dealer, should it prove defective by reason of against defects arising from improper workmanship and/or material:

a. Parts. The lenticular (i.e. front picture) screen is warranted against defects in materials and workmanship for a period of thirty (30) days from the date of the original purchase at retail. The lamp and all other parts (except any software incorporated into this television) are warranted for a period of one (1) year from the date of the original purchase at retail. We will repair or replace, at our option, any defective part without charge for the part. Parts used for replacement may be replaced with those of like kind and quality and may be new or remanufactured. Parts used for replacement are warranted for the remainder of the original warranty period.

b. Embedded Software. MDEA warrants that all software incorporated into this television set (the “Embedded Software”) will perform in accordance with the functional description of Embedded Software in all material respects, but MDEA does not warrant that the Embedded Software is error-free. MDEA also does not warrant that the Embedded Software will be compatible under IEEE 1394 AV/C and HAVi software standards with products produced by any other manufacturer. The limited warranty contained in this section shall continue for a period of one (1) year from the date of the original purchase at retail. If, after prompt notice within the warranty period, MDEA determines that the Embedded Software has failed to perform in accordance with such functional description in all material respects and if such failure is not due to accident, misuse, modification or misapplication of the Embedded Software, then MDEA shall modify or replace the nonconforming Embedded Software at no charge to you, which at MDEA’s sole discretion may be fulfilled by means of modification or replacement software contained on a replacement memory card for Customer installation. The foregoing shall be MDEA’s sole obligation to you under this limited warranty. All rights under this limited warranty on the Embedded Software also subject to your acceptance of and compliance with the terms of the Software License Agreement applicable to this television, and this limited warranty on the Embedded Software shall be null and void if the Embedded Software is modified or changed in any manner except as specifically authorized by MDEA.

c. Labor. For thirty (30) days after the original purchase at retail, we will repair or replace, at our option, the lenticular screen if it proves defective. For certain items that are designed to be replaced by the consumer, including (but not limited to) some Embedded Software, the consumer is solely responsible for any replacement labor. For all other parts, we will provide the labor for a warranty repair by an authorized MITSUBISHI service center without charge for one (1) year from the original date of purchase at retail.

d. Notice. To obtain warranty service, you must notify an authorized MITSUBISHI service center of any defect within the applicable warranty time period.

e. This DLP Projection Television uses a single DLP chip to create the screen image. This technology creates the image using small dots, or picture elements (pixels). Your DLP Projection TV is manufactured to a high level of performance and quality, in fact, 99.99% perfect in the number of properly functioning pixels. As in other display technology, sometimes a pixel is continuously active, inactive or the incorrect color. Our standard is clear; MDEA warrants only that the percentage of properly functioning pixels will be not less than 99.99% of all pixels.

BEFORE REQUESTING SERVICE, please review the instruction booklet to insure proper installation and correct customer control adjustment. If the problem persists please arrange for warranty service.

1. TO OBTAIN WARRANTY SERVICE:

a. Contact your nearest authorized MITSUBISHI service center, whose name and address can be obtained from your MITSUBISHI dealer, by writing at the address provided below, calling MDEA at the 800-332-2119, or by using the support feature of our website at www.Mitsubishi-tv.com.

b. Warranty service will be provided in your home or, if required, at an authorized service shop, provided that your television is located within the geographic territory customarily covered by an authorized MITSUBISHI service center. If not, you must either deliver your television to an authorized service location at your own expense, or pay for any travel and/or transportation costs the service center may charge to and from your home. Actual service labor will be provided without charge.

c. Proof of purchase date from an authorized MITSUBISHI dealer is required when requesting warranty service. Present your sales receipt or other document which establishes proof and date of purchase. THE RETURN OF THE OWNER REGISTRATION CARD IS NOT A CONDITION OF COVERAGE UNDER THIS LIMITED WARRANTY. However, please return the Owner Registration Card so that we can contact you should a question of safety arise which could affect you.

d. To obtain a replacement lamp during the warranty period, please contact the MDEA Consumer Relations Department at (800) 332-2119. After the warranty period you may order the lamp directly from the MDEA Parts Department at (800) 553-7278.

2. THIS LIMITED WARRANTY DOES NOT COVER:

a. Up to .01% pixel outages (small dot picture elements that are dark or incorrectly illuminated).

b. Damage to the lenticular screen or Fresnel lens, screen frame, cosmetic damage or to any other damage where such damage is caused by unauthorized modification, alteration, repairs to or service of the product by anyone other than an authorized MITSUBISHI service center; physical abuse to or misuse of the product (including any failure to carry out any maintenance as described in the Owner's Guide including air filter cleaning or any product damaged by excessive physical or electrical stress); any products that have had a serial number or any part thereof altered, defaced or removed; product use in any manner contrary to the Owner's Guide; freight damage; or any damage caused by acts of God or other factors beyond the reasonable control of MDEA, such as power surge damage caused by electrical system or lightning. This limited warranty also excludes service calls where no defect in the product covered under this warranty is found, service calls related to unsatisfactory audio or visual reception or signal unless caused by a defect in the product that is covered under this limited warranty, all costs, expenses or any other damages arising from product installation, or set-ups, any adjustments of user controls (including contrast, brightness, color, tint, fine tuning, sharpness), other adjustment necessary to prepare the unit for display or use, connection with any external audio receiver, antenna, cable or satellite systems, or service of products purchased or serviced outside the U.S.A. Please consult the operating instructions contained in the Owner's Guide furnished with the product for information regarding user controls.

3. ANY EXPRESS WARRANTY NOT PROVIDED HEREIN, AND ANY REMEDY WHICH, BUT FOR THIS PROVISION, MIGHT ARISE BY IMPLICATION OR OPERATION OF LAW, IS HEREBY EXCLUDED AND DISCLAIMED. THE IMPLIED WARRANTIES OF MERCHANTABILITY AND OF FITNESS FOR ANY PARTICULAR PURPOSE ARE EXPRESSLY LIMITED TO A TERM OF ONE YEAR.

4. UNDER NO CIRCUMSTANCES SHALL MDEA BE LIABLE TO PURCHASER OR ANY OTHER PERSON FOR ANY INCIDENTAL, SPECIAL OR CONSEQUENTIAL DAMAGES, WHETHER ARISING OUT OF BREACH OF WARRANTY, BREACH OF CONTRACT, OR OTHERWISE.

5. Some states do not allow limitations on how long an implied warranty lasts, or the exclusion or limitation of incidental, special, or consequential damages, so the above limitations or exclusions may not apply to you.

6. This limited warranty gives you specific legal rights, and you may also have other rights which vary from state to state.



MITSUBISHI DIGITAL ELECTRONICS AMERICA, INC.
9351 Jeronimo Road
Irvine, CA 92618-1904

Index

A

A/V Discs 85
 A/V Memory Reset. *See* Reset
 A/V Receiver
 Adding NetCommand Control 44
 Connecting 27
 A/V Reset. *See* Reset
 Adjust Keys (Up/Down/Left/Right)
 48, 60
 Anamorphic Picture Format 81
 DVD Definitions 54
 Playback 81
 Antenna
 Adjusting and the Signal Strength
 Meter 64
 Connecting 23
 Antenna Inputs (ANT 1/MAIN, ANT
 2/AUX) 16
 Audio/Video Menu 61, 72
 Audio Settings 72
 Auto Input Sensing 39

B

Back Panel (illustrated) 16, 17
 Batteries 35

C

CableCARD™ 12, 16, 18, 37
 and TV Energy Mode 38
 Cable Box
 and the Remote Control 48, 84,
 101
 Connecting 22, 25, 28
 IEEE 1394 29
 Camcorder 114
 Connecting (Analog) 28
 DV (Digital Video) 30, 116
 IEEE 1394 Camcorders 30
 Power 29
 Captions Menu 61, 66
 Channels. *See also* FAV
 and TV Timer 38
 Changing 35
 Digital Channel Numbers 97
 Memorizing 36
 Naming 64
 Status Display 51
 ChannelView™ Channel Listings 50
 and Recording 79
 Channel Menu 61, 64
 Cleaning 7
 ClearThought® Auto Input Sensing
 39
 Clock, Set Date and Time 37
 Closed Captions. *See* Captions Menu
 Color Adjustments 74, 75
 Component Inputs (Y Pb Pr) 17, 73
 Computer. *See* Personal Computer

Connecting: Helpful Hints 32
 Connection Types 21
 Copy Restrictions 85
 and NetCommand 81
 and Status Display 51
 Cropped Playback 81

D

Date. *See* Clock
 Daylight Savings Time 37
 Demo Mode 111
 Digital Audio Out 17
 Display Format Definitions 54
 Dolby Digital 17, 27, 98
 and IEEE 1394 29
 DVDs
 and the Remote Control 48, 101
 and V-Chip Ratings 71
 DVD Player with Component Video,
 Connecting 27
 DVI Device, Connecting 26
 DVI Jack (for Personal Computer) 17
 DV (Digital Video) 30

E

Energy Mode 38

F

F1–F4 Keys 43, 48
 Fan Noise 6
 Fast Power On (Energy Mode) 38
 FAV 65
 Film Mode 72
 FireWire®. *See* IEEE 1394
 Freeze Picture. *See* Pause
 Front Panel Lock 68

G

GUIDE Key (button) 48

H

HDMI
 Connecting an HDMI Device 26
 Description of HDMI Inputs 12
 HDMI Jack 17, 73
 Personal Computer with HDMI
 Output 89
 Remove the Icon for an HDMI
 Device 63
 HDTV Receiver with Component
 Video, Connecting 21
 HD (High-Definition Signal) 54

I

Icon Order Menu 63
 IEEE 1394 Devices
 Amplifier Settings 73
 and Analog Outputs 40, 83

and Recording 83
 and Status Display 51
 Compatible IEEE 1394 Devices
 29
 Connecting IEEE 1394 Devices
 17, 30
 TV Connection Speed 30
 Important Information About Your TV
 6
 INFO Key Status Display 51
 and NetCommand-Controlled
 Devices 41
 Input Jacks on TV (Standard Audio/
 Video) 16, 73
 Input Name Menu 62
 Input Selection Menu 50
 and NetCommand-Controlled
 Devices 78
 Remove the Computer Icon from
 the Input Selection Menu 88
 Remove the Icon for an HDMI
 Device 63
 IR (Infrared)
 IR Emitter NetCommand® 31

J

JPEG Picture Files 56

L

Lamp Cartridge Replacement 99
 LAMP Indicator. *See* LED Indicator
 Lights
 Language
 Audio Setting (Digital Channels)
 73
 for TV Menus 36
 “Learn” Feature (NetCommand)
 Description 42
 Device Functions 42
 Learn A/V Receiver Input IR
 Codes 45
 Troubleshooting 117
 LED Indicator Lights
 LAMP Indicator 15
 POWER/TIMER Indicator 15
 STATUS Indicator 15
 Troubleshooting 114
 Lock TV. *See* Parental Lock
 Low Power (Energy Mode) 38

M

Memorizing Channels 36
 Memory Cards 13
 Media Setup Menu 57
 Memory Card Reader 14, 56
 MONITOR OUT Jacks 17

- MP3 Audio 13, 14, 29, 32
 - and Memory Cards 57
 - Playback 56
- Mute
 - Audio
 - and Closed Captions 66
 - and status Display 51
 - MUTE key 48
 - Video Mute 72
- N**
- NetCommand®
 - A/V Receiver Control 43
 - and the Input Selection Menu 78
 - Compared to Programming the Remote Control 101
 - Description 13, 42
 - Initial Setup 42
 - IR Emitters 31
 - Menu 43, 62
 - Specialized Device Keys 41
- Noise Reduction (Video) 74
- P**
- Parental Lock
 - Bypassing 95
 - Front Panel Lock 68
 - V-Chip Ratings 71
- Pass Code
 - Resetting 95
 - Setting 68
- PAUSE Key 48
 - and Memory Cards 56
- PerfectColor 74, 75
- PerfectTint™ 74, 75
- Personal Computer 83
 - and Display Formats 54
 - Connecting 89
 - Remove the Computer Icon 88
 - Setup 88
- Picture Quality
 - and Connection Types 20
 - and Film Mode 72
 - Troubleshooting 113
- Power Consumption 38, 98
- Power On/Off 35, 113
- Q**
- QV (QuickView™) 48
- R**
- Recording
 - and MONITOR OUT Jacks 17
 - and Split Screen 17
 - Cancelling Recordings 80
 - NetCommand-Controlled Recording 79
 - RECORD Button 115
 - RECORD Key and VCRs 82
 - Record List 79
 - Record Menu (Set Recording Defaults) 81
 - Signals Available for Recording 21
- Recording and TV Energy Mode 38
- Record List Screen 79
- Remote Control
 - Keys and Functions 48
 - Programming Codes (reference chart) 103
 - Programming Instructions 102
 - Programming vs. NetCommand “Learning” 101
 - Reset 49
- Reset
 - A/V (all settings) 14
 - A/V Memory (for individual devices) 72
 - DVCR Counter 84
 - Pass Code 95
 - PerfectColor 74
 - Remote Control 49
 - System Reset Button 111
- Review Screen, TV Connections 43, 46
- S**
- S-Video
 - Connecting 22
 - Connector Illustration 20
- Safeguards 8
- SAP (Second Audio Program) 73
- Satellite Receiver
 - and the Remote Control 101
 - Connecting 21, 22
 - IEEE 1394 84
- SD (Standard-Definition Signal) 54
- Service and Support 111
- Setup Menu 36, 61
- Set Up TV 39
- Signal Definitions 54
- Sleep Timer 49
- Software Version 38
- Speakers, Turning TV Speakers On or Off 72
- Specifications, TV 97
- Split Screen
 - and Recording from MONITOR OUT 17
 - Description 52
- Stand, TV 6
- Standard-Definition Signal 54
- Status Display 51
- STATUS Indicator. *See* LED Indicator Lights
- Stereo System. *See* A/V Receiver
- System Reset 14, 111
- T**
- 3:2 pulldown 72
- Time. *See* Clock
- Timer (TV Timer Feature) 37
- Time Zone. *See* Clock
- Troubleshooting 111
- TV Guide On Screen®
 - Access Requirements 6
 - and ChannelView 79
 - and GUIDE Key 48
 - and Recording 81
 - and the Record List 79
 - and TV Energy Mode 38
 - Connection Requirements 24, 44
 - Description 13
 - Setup 43
 - Setup Requirements 42
- TV Reset Menu 111
- V**
- VCR
 - Connecting 16, 24, 25
 - IEEE 1394 29
 - and NetCommand Control 78
 - Troubleshooting 113
- Video Noise Reduction 74
- Video Settings 74
- Viewing Device. *See* Input Selection Menu
- W**
- Wall Outlet Cable 22
- WMA Audio 13, 14, 56, 57
- Z**
- ZIP code 44



Website:
www.mitsubishi-tv.com

E-mail:
MDEAservice@mdea.com

**For questions, call Consumer Relations at
800-332-2119**

**To order replacement or additional
remote controls, lamp cartridges, or Owner's Guides**

Visit our website at www.mitsuparts.com

or call

800-553-7278

Demo Mode

This TV has a demo mode for use in retail stores. Demo mode causes the TV to display a series of screens outlining the TV's features.

To turn off demo mode:

1. Press **MENU**.
2. When the Main menu appears with **Setup** high-lighted, press **ENTER**.
3. When the Setup menu opens, press **▶** to high-light the on-screen **Demo Mode Off** button.
4. Press **ENTER**.

System Reset

If the TV does not respond to the remote control, front panel controls, or will not power on/off, press the **SYSTEM RESET** button on the front panel with a pointed object, such as the point of a pencil or end tip of a paperclip.

The green LED will flash quickly for about one minute. When the green LED stops flashing, you may turn on the TV.