

myprojectorlamps.com

**The most trusted, dependable name
in projector lamp sales.**



<http://www.myprojectorlamps.com>



<http://www.myprojectorlamps.ca>



<http://www.myprojectorlamps.eu>

The following projector manual has not been modified or altered in any way.



DLP® HIGH-DEFINITION TELEVISION MODELS

C Series

WD-60C8, WD-65C8, WD-73C8

735 Series

WD-60735, WD-65735, WD-73735

736 Series

WD-65736, WD-73736

835 Series

WD-65835, WD-73835

OWNER'S GUIDE

- For questions:
 - Visit our website at www.mitsubishi-tv.com.
 - E-mail us at MDEAservice@mdea.com.
 - Call Consumer Relations at 800-332-2119.
- For information on **System Reset**, please see the back cover.
- To order replacement or additional remote controls, lamp cartridges, or Owner's Guides, visit our website at www.mitsuparts.com or call 800-553-7278.
- Guidelines for setting up and using your new widescreen TV start on page 11.



x.v.Color



For Your Records

Record the model number, serial number, and purchase date of your TV. The model and serial numbers are on the back of the TV. Refer to this page when requesting assistance with the TV.

MODEL NUMBER _____

SERIAL NUMBER _____

PURCHASE DATE _____

RETAILER NAME _____

LOCATION _____



CAUTION

RISK OF ELECTRIC SHOCK
DO NOT OPEN



CAUTION: TO REDUCE THE RISK OF ELECTRIC SHOCK, DO NOT REMOVE COVER (OR BACK). NO USER SERVICEABLE PARTS INSIDE. REFER SERVICING TO QUALIFIED SERVICE PERSONNEL.



The lightning flash with arrowhead symbol within an equilateral triangle is intended to alert the user of the presence of uninsulated "dangerous voltage" within the product's enclosure that may be of sufficient magnitude to constitute a risk of electric shock to persons.



The exclamation point within an equilateral triangle is intended to alert the user to the presence of important operating and maintenance (servicing) instructions in the literature accompanying the product.

MAINS DISCONNECTION: The mains plug is used as the disconnect device. The disconnect device shall remain readily operable.

TV WEIGHT: This TV is heavy! Exercise extreme care when lifting or moving it. Lift or move the TV with a minimum of two adults. To prevent damage to the TV, avoid jarring or moving it while it is turned on. Always power off your TV, unplug the power cord, and disconnect all cables before moving it.

WARNING: To reduce the risk of fire or electric shock, do not expose this apparatus to rain or moisture.

WARNING: This product contains chemicals known to the State of California to cause cancer and/or birth defects or other reproductive harm.

FCC Declaration of Conformity

Product: Projection Television Receiver
Models: WD-60C8, WD-65C8, WD-73C8
WD-60735, WD-65735, WD-73735
WD-65736, WD-73736
WD-65835, WD-73835

Responsible Party: Mitsubishi Digital Electronics
America, Inc.
9351 Jeronimo Road
Irvine, CA 92618-1904

Telephone: (800) 332-2119

This device complies with Part 15 of the FCC Rules. Operation is subject to the following two conditions:

- (1) This device may not cause harmful interference, and
- (2) this device must accept any interference received, including interference that may cause undesired operation.

Note: This equipment has been tested and found to comply with the limits for a Class B digital device, pursuant to part 15 of the FCC Rules. These limits are designed to provide reasonable protection against harmful interference in a residential installation. This equipment generates, uses and can radiate radio frequency energy and, if not installed and used in accordance with the instructions, may cause harmful interference to radio communications. However, there is no guarantee that interference will not occur in a particular installation. If this equipment does cause harmful interference to radio or television reception, which can be determined by turning the equipment off and on, the user is encouraged to try to correct the interference by one or more of the following measures:

- Reorient or relocate the receiving antenna.
- Increase the separation between the equipment and the receiver.
- Connect the equipment into an outlet on a circuit different from that to which the receiver is connected.
- Consult the dealer or an experienced radio/TV technician for help.

Changes or modifications not expressly approved by Mitsubishi could cause harmful interference and would void the user's authority to operate this equipment.

Features and specifications described in this owner's guide are subject to change without notice.

Contents

Important Information About Your TV

Installation Notes, Operating Notes, Cleaning Recommendations	4
Important Safety Instructions	5

1 Television Overview

Package Contents	6
Special Features of Your TV	6
TV Front Panel	7
TV Back Panel	9

2 TV Setup

Guidelines for Setting Up and Using Your New Widescreen TV	11
Initial TV Setup	13
Setting Up TV Inputs	13
Controlling A/V Receiver Sound Volume	15
Using the TV with a Personal Computer	17

3 TV Connections

Before You Begin	19
HDTV Cable Box or Satellite Receiver, DVD Player, or Other Device with Component Video	19
HDMI Device (Cable Box, Satellite Receiver, DVD Player, or Other Device)	20
DVI Video Device (Cable Box, Satellite Receiver, DVD Player, or Other Device)	20
Wall Outlet Cable (no cable box)	21
Antenna with a Single Lead	21
Antennas with Separate UHF and VHF Leads	21
Standard Cable Box, Satellite Receiver, or Other Device with S-Video	22
VCR to an Antenna or Wall Outlet Cable	22
VCR to a Cable Box (Audio & Video)	23
Older Cable Box	23
A/V Receiver (Sound System) Using the TV's Audio Output	24
A/V Receiver with HDMI Output	24
Camcorder	25
Audio-Only Device	25

4 TV Operation and Features

Choosing a Viewing Source	26
Sleep Timer	26
Remote Control	27
ChannelView Channel Listings	29

Status Display	30
Fav (Favorite Channels)	31
TV Signals and Display Formats	32
Viewing Camera Files	33
JPEG Photos and the USB Photo Port	33
Photos and Moving Video as Composite Video	34
3D Video	35

5 TV Menus

Main Menu	36
Remote Control Keys for the TV Menu System	36
AV Menu	37
Video Menu	39
Audio Menu	41
Captions Menu	42
Setup Menu	43
Inputs Menu	48
Lock Menu	49
Pass Codes	49
Parent Menu	49
Other Menu (Alternate Rating System)	49
Bypassing TV Locks	49

6 NetCommand IR Control

About NetCommand IR Control	52
IR Emitter Placement	53
Initial NetCommand Setup for Most Devices	54
Adding or Removing Device Keys from NetCommand Control	54
NetCommand Specialized Device Keys	55
Operating NetCommand-Controlled Devices	56
Setting Up NetCommand Control of an A/V Receiver	58

Appendices

Appendix A: Specifications	64
Appendix B: Bypassing the Parental Lock	65
Appendix C: Programming the Remote Control	67
Appendix D: Lamp-Cartridge Replacement and Cleaning	75
Appendix E: NetCommand HDMI Control of CEC Devices	77
Appendix F: Troubleshooting	80

Trademark and License Information

Mitsubishi TV Software

Warranty

Index

Important Information About Your TV

Installation Notes

Stand Requirement

CAUTION: Use these Mitsubishi TV models only with the Mitsubishi stand models shown here. Other stands can result in instability and possibly cause injury.

TV Model	Stand Model
WD-60C8, WD-60735, WD-65C8, WD-65735, WD-65736	MB-S60/65
WD-73C8, WD-73735 WD-73736	MB-S73

835 Series Stands: Mitsubishi does not design, manufacture or sell matching bases for 835 series model televisions (WD-65835, WD-73835). When selecting a stand, base or other furniture to support the TV, please make sure it is designed with the appropriate dimensions for stability and to support the TV's total weight as well as the weight of any additional equipment you plan to store.

Custom cabinet installation must allow for proper air circulation around the television.

NOTE TO CATV SYSTEM INSTALLER: THIS REMINDER IS PROVIDED TO CALL THE CATV SYSTEM INSTALLER'S ATTENTION TO ARTICLE 820-40 OF THE NEC THAT PROVIDES GUIDELINES FOR THE PROPER GROUNDING AND, IN PARTICULAR, SPECIFIES THAT THE CABLE GROUND SHALL BE CONNECTED TO THE GROUNDING SYSTEM OF THE BUILDING, AS CLOSE TO THE POINT OF CABLE ENTRY AS PRACTICAL.

Internal Fans

Internal cooling fans maintain proper operating temperatures inside the TV. It is normal to hear the fans when you first turn on the TV, during quiet scenes while viewing the TV, and for a short time after shutting off the TV. You may notice louder fan noise about 30 seconds after shutting off the TV and while using the **Bright Lamp Mode**.

Lamp Replacement

For lamp-replacement instructions, see Appendix D.

To Order a Replacement Lamp Under Warranty

Call (800) 553-7278. Please have model number, serial number, and TV purchase date available.

Important: All lamps replaced under warranty must be returned to Mitsubishi where they will be inspected for defect verification.

To Purchase a Replacement Lamp After Warranty

Visit our website at www.mitsuparts.com or call (800) 553-7278. Order new lamp part number **915B403001**.

TV Software

Do not attempt to update the software of this TV with software or USB drives not provided by or authorized by Mitsubishi Digital Electronics America, Inc. Non-authorized software may damage the TV and will not be covered by the warranty.

Cleaning Recommendations

Normally, light dusting with a dry, non-scratching duster will keep your TV clean. If cleaning beyond this is needed, please use the following guidelines:

First, turn off the TV and unplug the power cord from the power outlet.

Occasionally clean dust build-up from the air-intake grilles on the back and sides of the TV. Clean using a vacuum cleaner with a brush attachment.

Top and Sides of the TV

- Gently wipe down your TV with a soft, non-abrasive cloth such as cotton flannel or a clean cloth diaper, lightly moistened with water. Dry with a second dry, soft, non-abrasive cloth.
- For oily dirt, add a few drops of mild liquid detergent, such as dishwashing detergent, to the water used to moisten the cloth. Rinse with a second cloth moistened only with water. Dry with a third dry, soft, non-abrasive cloth.

Glossy Surfaces (835 series models)

Use the soft cleaning cloth supplied with the TV.

- Clean the cloth before each use by shaking or brushing to remove any residual dirt particles.
- Gently wipe down the glossy surfaces of your TV with the soft cloth. Do not apply pressure while wiping.
- If necessary, lightly dampen the soft cloth with water. Do not use chemical or abrasive cleaners.
- Wash the soft cloth by hand or machine. Use only mild soap.

Screen

- Follow the instructions for the top and sides, wiping gently in an up and down motion.
- Clean the entire screen evenly, not just sections of the screen.
- Do not allow liquid to drip down the screen, as some liquid may enter the TV through the gap between the screen and screen frame.
- You may purchase Mitsubishi Screen Cleaner, part number CLEANER-VSS, by calling (800) 553-7278.

General Cleaning Precautions

- DO NOT allow liquid to enter the TV through the ventilation slots or any crevice.
- DO NOT use any strong or abrasive cleaners, as these can scratch the surfaces.
- DO NOT use any cleaners containing ammonia, bleach, alcohol, benzene, or thinners, as these can dull the surfaces.
- DO NOT spray liquids or cleaners directly on the TV's surfaces.
- DO NOT scrub or rub the TV harshly. Wipe it gently.

Important Safety Instructions

Please read the following safeguards for your TV and retain for future reference. Always follow all warnings and instructions marked on the television.

- 1) Read these instructions.
- 2) Keep these instructions.
- 3) Heed all warnings.
- 4) Follow all instructions.
- 5) Do not use this apparatus near water.
- 6) Clean only with dry cloth.
- 7) Do not block any ventilation openings. Install in accordance with the manufacturer's instructions.
- 8) Do not install near any heat sources such as radiators, heat registers, stoves, or other apparatus (including amplifiers) that produce heat.
- 9) Do not defeat the safety purpose of the polarized or grounding-type plug. A polarized plug has two blades with one wider than the other. A grounding type plug has two blades and a third grounding prong. The wide blade or the third prong are provided for your safety. If the provided plug does not fit into your outlet, consult an electrician for replacement of the obsolete outlet.
- 10) Protect the power cord from being walked on or pinched particularly at plugs, convenience receptacles, and the point where they exit from the apparatus.
- 11) Only use attachments/accessories specified by the manufacturer.
- 12) Use only with the cart, stand, tripod, bracket, or table specified by the manufacturer, or sold with the apparatus. When a cart is used, use caution when moving the cart/apparatus combination to avoid injury from tip-over.
- 13) Unplug this apparatus during lightning storms or when unused for long periods of time.
- 14) Refer all servicing to qualified service personnel. Servicing is required when the apparatus has been damaged in any way, such as power-supply cord or plug is damaged, liquid has been spilled or objects have fallen into the apparatus, the apparatus has been exposed to rain or moisture, does not operate normally, or has been dropped.



Outdoor Antenna Grounding

If an outside antenna or cable system is connected to the TV, be sure the antenna or cable system is grounded so as to provide some protection against voltage surges and built-up static charges.

Replacement Parts

When replacement parts are required, be sure the service technician has used replacement parts specified by the manufacturer or have the same characteristics as the original part. Unauthorized substitutions may result in fire, electric shock or other hazards.

EXAMPLE OF ANTENNA GROUNDING

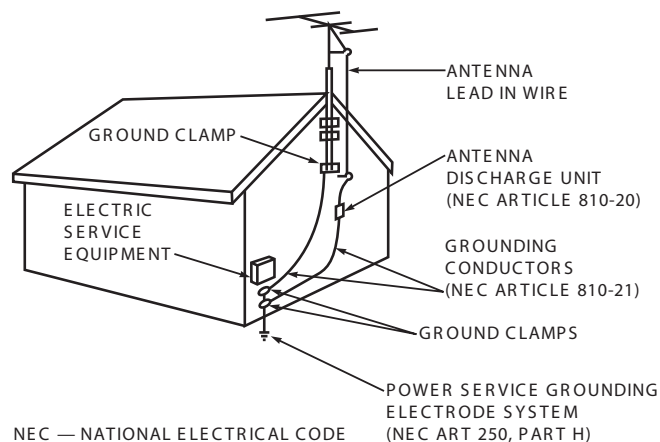

1 Television Overview

Package Contents

Please take a moment to review the following list of items to ensure that you have received everything.

1. Remote Control
2. Two AA Batteries
3. Owner's Guide
4. Quick Reference Guide
5. Quick Connect Guide
6. Product Registration Card
7. 736 or 835 Series: Two-Ended IR Emitter
8. 835 Series: Cleaning Cloth for Glossy Surfaces. See instructions under "Cleaning Recommendations," page 4.

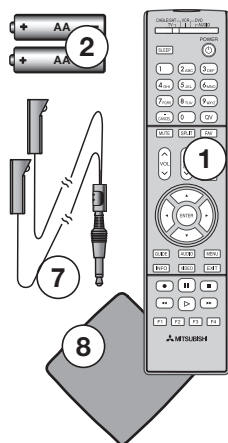

Integrated HDTV Tuner

Your widescreen Mitsubishi HDTV has an internal HDTV tuner able to receive both over-the-air HDTV broadcasts (received via an antenna) and non-scrambled digital cable broadcasts, including non-scrambled HDTV cable programming.

High-Definition Video Inputs

- **Component Video Inputs.** Also called Y/Pb/Pr inputs, these inputs receive standard analog video formats of 480i, 480p, 720p, and 1080i high-definition signals. This provides a high level of flexibility when connecting DVD players/recorders, cable boxes, and satellite receivers.
- **HDMI Inputs.** These inputs accept digital 480i, 480p, 720p, 1080i, and 1080p video signals plus PCM digital stereo signals. The HDMI™ inputs can also accept a variety of PC signals and resolutions. These inputs support HDMI 1.3 Deep Color (up to 36 bits) and the **x.v.Color** extended color gamut. Used with an adapter, these inputs also accept compatible digital DVI video signals. HDMI inputs provide additional high-performance, high-definition connections for maximum flexibility in your choice of home theater products. The HDMI inputs are HDCP copy-protection compatible.

Special Features of Your TV

Your new high-definition widescreen television has many special features that make it the perfect center of your home entertainment system, including:

1080p High-Definition DLP Display System

Your Mitsubishi HDTV uses Texas Instruments Digital Light Processing™ technology for rear-projection TVs to create the picture you see on screen. All images are displayed at 1080p. The TV uses Plush 1080p® to convert lower-resolution signals to 1080p for display. The TV can also accept 1080p original signals and maintain them at 1080p through all processing until displayed.

3D Ready

All Mitsubishi 1080p DLP HDTV's are 3D Ready. This feature lets you experience the new 3D technologies applied to many recent movies and video games. Immerse yourself in your favorite video game, movie, or sporting event displayed in 3D.

16:9 Widescreen Picture Format

Enjoy a full theatrical experience in the comfort of your home. View pictures as film directors intended them. Digital TV broadcasts, DVDs and newer video game consoles support this widescreen format.

Easy Connect Auto Input Sensing

Easy Connect™ Auto Input Sensing automatically recognizes when you plug in an input and prompts you to assign a name to it. The TV ignores any unused inputs, so the result is an uncluttered **Input Selection** menu where you can easily find and select connected devices by name.

Home Theater Control

NetCommand for HDMI

Available for all models. HDMI devices with Consumer Electronics Control (CEC) capabilities may be compatible with the TV's NetCommand for HDMI feature. Compatible devices can receive control signals through the HDMI connection. The TV's remote control may be able to operate some functions of these devices without any further setup.

NetCommand with IR Learning

736 or 835 Series TV. Your Mitsubishi HDTV offers a new level of networking that seamlessly integrates selected older A/V products with new and future digital products. NetCommand® supports IR (infrared) control of products such as VCRs, DVD players, cable boxes, and satellite receivers. NetCommand can “learn” remote control signals directly from many devices, allowing you to create a customized NetCommand-controlled home-theater system.

TV Front Panel

Control Panel

Buttons on the front control panel duplicate commonly used keys on the remote control. The upper labels show control functions when no TV menus are displayed; the lower labels indicate functions when TV menus are displayed or when a special function has been activated. See “Remote Control,” page 27, for a full description of the functions of these buttons.

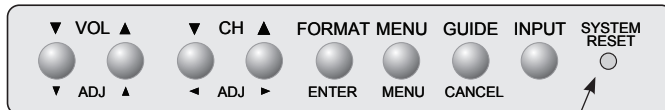
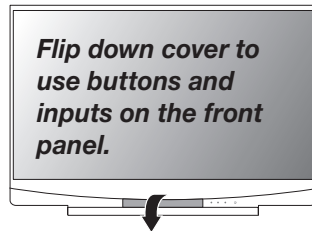

Control Panel. Buttons on the control panel duplicate some keys on the remote control.

System Reset Button

If the TV fails to respond to the remote control, control panel buttons, or will not power on/off, press the **SYSTEM RESET** button on the control panel.

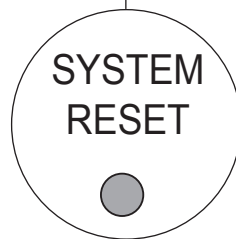

The green LED on the front panel will flash quickly for up to one and a half minutes. When the green LED stops flashing, you may turn on the TV. Recent setting changes you made before using **SYSTEM RESET** may be lost.

A/V Reset

If you wish to reset the A/V (Audio/Video) settings back to the factory defaults:

- To reset all settings at once, press **GUIDE** and **FORMAT** on the control panel at the same time.
- To reset the defaults for individual inputs, use the **Reset** selection on the **AV** menu. See “AV Menu,” page 37.

Front Inputs

INPUT 4 is a readily accessible set of input jacks for a camcorder, game, or other audio/video device.

- To view NTSC/480i composite video signals, plug the single composite video cable (usually yellow) into the **VIDEO/Y** jack.
- To view Y Pb Pr component video in 480i, 480p 720p, or 1080i format, connect cables to the **VIDEO/Y**, **Pb** and **Pr** jacks.
- A convenient fourth HDMI input is provided on 736 and 835 series models.
- A USB photo port lets you view JPEG images.
- Plug stereo audio cables into the **AUDIO L** and **R** jacks for sound from connected devices. You can use the audio jacks for sound from a DVI device connected to the HDMI jack or from an audio device playing while viewing photos from the USB input.

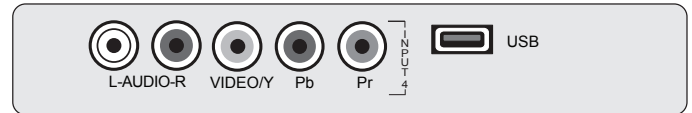

Front inputs on C and 735 series models.

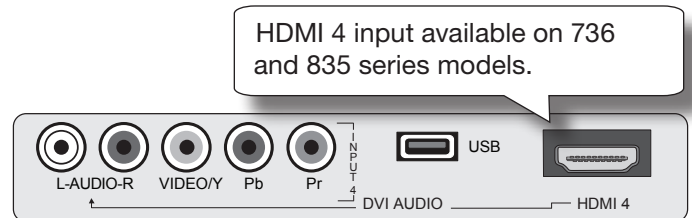

Front inputs on 736 and 835 series models.

Front Panel Indicators and Power Button

1. **LAMP** indicator shows lamp condition (usually off during normal TV operation).
2. **STATUS** indicator. Off during normal TV operation.
3. **POWER/TIMER** indicator. Lit when TV is powered on; flashes when TV is powered off and the auto-on TV Timer is set.
4. **POWER** button. Turns TV on and off; works the same as the **POWER** key on the remote control.

See the next page for more on front-panel indicators.

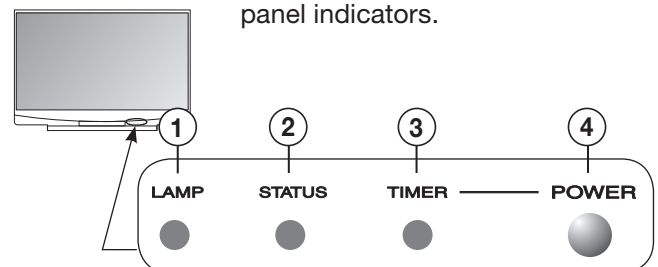

Indicator LED lights and **POWER** button

Front-Panel Indicators

○ Off ● Steady On ◐ Slow Blinking ⊙ Fast Blinking

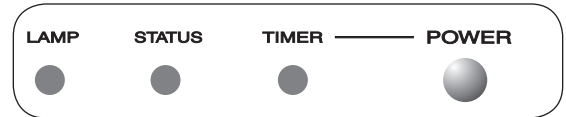

POWER/TIMER Indicator

LED Color	TV Condition	Additional Information
None ○	TV is powered off.	Normal operation.
Green ●	TV is powered on.	Normal operation.
Green ◐	TV powered off, auto-on timer is set.	Normal operation. TV can be turned on at any time.
Green ⊙	<ul style="list-style-type: none"> TV just plugged into AC outlet. AC just restored after power failure. TV is rebooting after System Reset used. TV is rebooting after power fluctuation or receiving abnormal digital signals from a digital channel or digital device. You have begun the procedure to update software from an authorized flash memory device. 	Wait approximately two minutes for blinking to stop before turning on. Normal operation.

STATUS Indicator

LED Color	TV Condition	Additional Information
None ○	Normal TV on or standby condition.	Normal operation.
Yellow ◐	TV is too hot.	<p>The TV will display a warning message and shut off if it overheats.</p> <ul style="list-style-type: none"> Ambient room temperature may be too high. Turn off the TV and let the room temperature to drop. Clear blocked air vents. Ensure at least a four-inch clearance on all sides of the TV. Clean the lamp-cartridge air filter. See Appendix D.
Red ●	TV may require service.	<p>Turn off the TV and unplug the set from the AC power source. Wait one minute and then plug the set back in. See Appendix F.</p> <p>If the LED is still on, contact your dealer or a Mitsubishi Authorized Service Center. Go to www.mitsubishi-tv.com or call 1-800-332-2119 to receive Authorized Service Center information.</p>

LAMP Indicator

LED Color	TV Condition	Additional Information
None ○	Normal TV on or standby condition.	Normal operation.
Green ⊙	TV just powered off and lamp is cooling.	Starts to blink 60 seconds after turning off TV. TV can be turned back on before blinking starts or after blinking stops, but not while the indicator is blinking. Normal operation.
Yellow ◐	<ol style="list-style-type: none"> Lamp access door is open or not secure. No lamp installed. 	<p>TV will not operate until lamp access door is secure. See Appendix D for installation information.</p> <p>TV will not operate without a lamp. See Appendix D for installation information.</p>
Red ●	Lamp no longer illuminates and has reached the end of the lamp life.	Replace the lamp. The TV will not operate when the lamp no longer illuminates. See Appendix D for installation information.

TV Back Panel

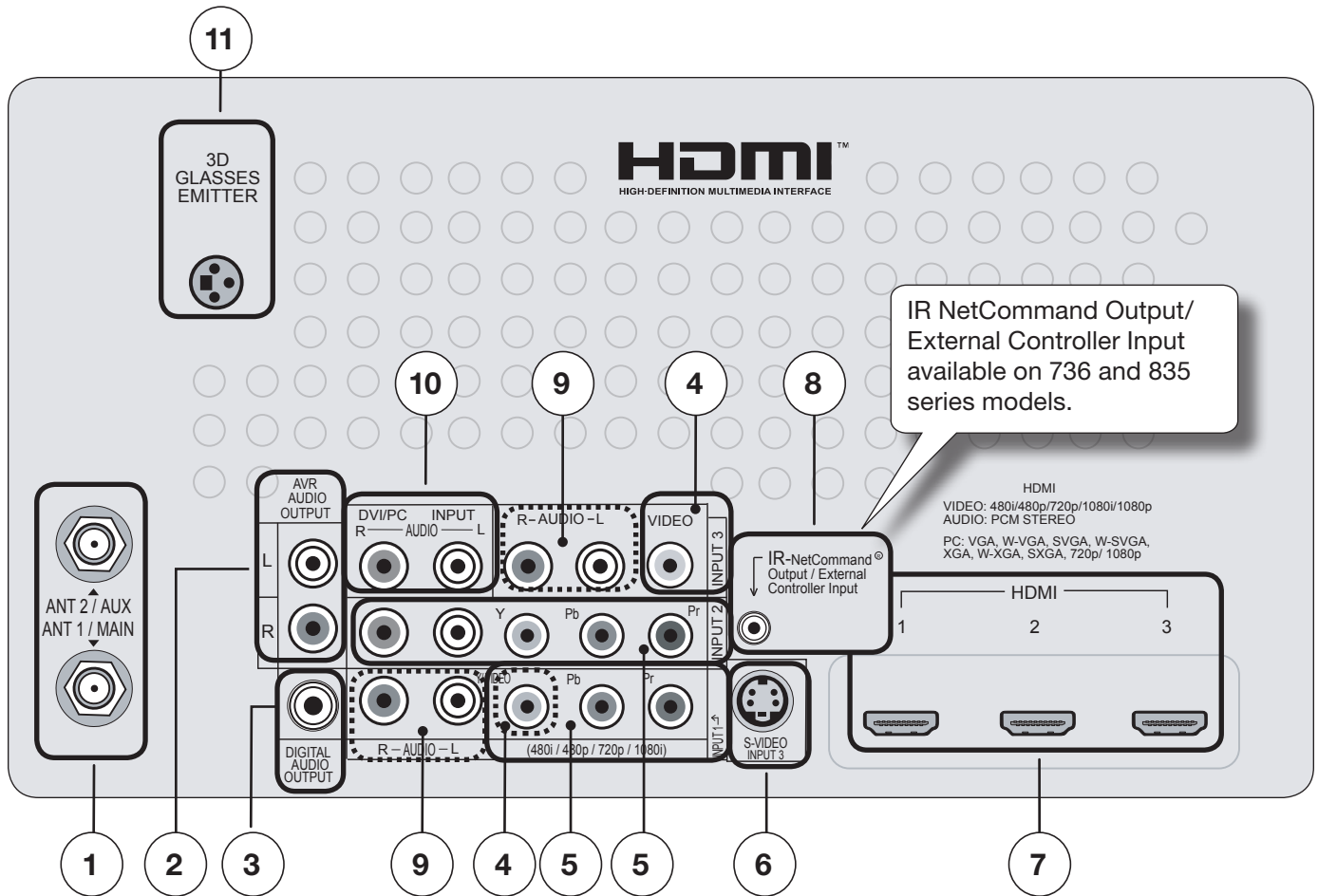

1. ANT 1/ANT 2 (Antenna)

If you are connecting an antenna or direct cable service without a cable box, connect the main antenna or cable source to **ANT 1**. Use **ANT 2** for a second source.

ANT 1 and **ANT 2** can each receive digital and analog over-the-air channels from a VHF/UHF antenna or non-scrambled digital/analog cable source.

2. AVR AUDIO OUTPUT

Use **AVR AUDIO OUTPUT** to send analog audio of the program currently shown on the screen to an analog A/V surround sound receiver or stereo system. Digital audio from digital channels and HDMI devices is converted to analog audio by the TV. This is the only audio connection needed between it and the TV if using an analog A/V receiver or stereo system.

3. DIGITAL AUDIO OUTPUT

This output sends Dolby Digital or PCM digital audio to your digital A/V surround sound receiver. Analog audio from analog channels and devices and HDMI devices is converted by the TV to PCM digital audio. If you have a digital A/V receiver, in most cases this is the only audio connection needed between the TV and your A/V receiver.

4. Composite Video (INPUT 1, INPUT 3)

Use the **VIDEO** jacks to connect a VCR, DVD player, standard satellite receiver, or other A/V device to the TV. Use the adjacent **AUDIO R** and **L** inputs for **INPUT 1** or **INPUT 3** if you wish to send audio to the TV. Note that the **INPUT 3** composite video jack is automatically disabled when you connect to **S-VIDEO** (item 6).

5. Component Video (INPUT 1, INPUT 2)

Y Pb Pr Component Video (480i/480p/720p/1080i)
Use these jacks to connect devices with component video outputs, such as DVD players, external HDTV receivers, or compatible video game systems. Use the adjacent **AUDIO R** and **L** jacks for **INPUT 1** or **INPUT 2** if you wish to send audio to the TV. See Appendix A specifications for signal compatibility.

6. S-VIDEO (INPUT 3)

Connect an S-Video device to this input. Use the **AUDIO R** and **L** jacks for **INPUT 3** (item 9) if you wish to send audio to the TV.

TV Back Panel, continued

7. HDMI™ Inputs (High-Definition Multimedia Interface)

The HDMI inputs support uncompressed standard and high-definition digital video formats and PCM digital stereo audio.

Use the HDMI inputs to connect to CEA-861 HDMI compliant devices such as a high-definition receiver or DVD player. These inputs support 480i, 480p, 720p, 1080i, and 1080p video formats.

Mitsubishi recommends you use category 2 HDMI cables, also called high-speed HDMI cables, to connect HDMI 1.3 source devices. High-speed category 2 cables bring you the full benefits of Deep Color and **x.v.Color**.

These HDMI inputs can also accept digital DVI video signals. To connect a device's DVI output to the TV's HDMI input, use an HDMI-to-DVI adapter or cable plus analog audio cables. Connect the analog audio cables to the **DVI/PC INPUT AUDIO** jacks (item **10**) on the TV to receive left and right stereo audio from your DVI device.

The TV's HDMI inputs are compatible with many DVI-D and HDMI computer video signals. For additional information on PC compatibility, see "Using the TV with a Personal Computer," page 17, and Appendix A, "Specifications," page 64.

These inputs are HDCP (High-Bandwidth Digital Copy Protection) compliant.

These inputs are  **SimplifyHD** certified for proper interoperability with other products certified by Simplify™.

8. IR NetCommand Output/External Controller Input

736 or 835 series TV. IR emitters connected to this jack are used by the TV's NetCommand system to send control signals to external IR remote-controlled devices such as cable boxes, VCRs, DVD players, satellite receivers and audio receivers.

When NetCommand is not being used, this jack can be switched to receive wired IR control signals from external system controllers. To switch this jack for use as an input, connect the external controller's IR output to this jack, then:

1. Press **MENU** to display the TV menu.
2. Enter the number sequence 2, 4, 7, 0 to display the **Installer** menu.
3. Highlight the **WIRED IR** selection and press **ENTER** to change the setting from **OFF** to **ON**.

To revert to NetCommand control:

1. Disconnect the IR device.
2. Press **MENU** to display the TV menu.

HDMI Cable Categories

HDMI cables are available as Category 1 and Category 2 types.

- **Category 2 Cables** (also called high-speed HDMI cables). Newer, HDMI 1.3-compliant DVD players, video games, and set-top boxes require Category 2 cables, suitable for clock frequencies up to 340 MHz or data rates of up to 10.2 gigabits per second. Use category 2 cables for high-speed 1080p HD signals carrying extended color encodings (i.e., 30 or more bits, also called Deep Color). Category 2 cables are also suitable for standard HDTV signals.
- **Category 1 Cables** (also called standard HDMI cables). Category 1 cables may be unmarked. They are suitable for standard HDTV 720p, 1080i, and 1080p signals with 8-bit color depth. Use category 1 cables for clock frequencies up to 74.25 MHz or data rates of up to 2.23 gigabits per second.

3. Enter the number sequence 2, 4, 7, 0 to display the **Installer** menu.
4. Highlight the **WIRED IR** selection and press **ENTER** to change the setting from **ON** to **OFF**.

Note: When the **WIRED IR** option is set to **ON** (control by an external device), the **Low Power** setting for Energy Mode is unavailable.

9. AUDIO L and R (INPUT 1, INPUT 3)

These are analog stereo inputs shared by more than one video input.

- **INPUT 1** stereo audio jacks are for use with **INPUT 1** composite video (single yellow cable) or component video (Y Pb Pr cables).
- **INPUT 3** stereo audio jacks are for use with **INPUT 3** composite video or S-Video.

10. DVI/PC INPUT AUDIO

Use the **DVI/PC INPUT AUDIO** jack when connecting a DVI device to one of the TV's HDMI inputs using a DVI-to-HDMI cable. These jacks allow you to send left and right analog audio from your computer or other DVI device to the TV.

11. 3D GLASSES EMITTER

Use this jack to connect the special IR emitter supplied with 3D glasses. The emitter will send a signal that synchronizes your 3D glasses with the screen display.

2 TV Set-Up

Guidelines for Setting Up and Using Your New Widescreen TV

Getting Started

1. Review the important safety, installation, and operating information at the beginning of this book.
2. Choose a location for your TV.
 - Allow at least four inches of space on all sides of the TV to help prevent overheating. Overheating may cause premature failure of the TV as well as shortened lamp life.
 - Avoid locations where light may reflect off the screen.
 - See the stand requirements under “Important Information About Your TV.”
3. Install the batteries in the remote control. See this page for instructions. See page 27 for more on use of the remote control.
4. Plug your TV into a power outlet. The green LED on the front of the TV will start blinking rapidly. After the green LED stops blinking, press the **POWER** key to power on the TV.
5. When the **Welcome** screen appears the first time you power on the TV, select a language for TV menus. You can later change the language through the **Setup** menu.
6. Connect your audio/video (A/V) devices to the TV and perform initial setup.
 - See chapter 3, “TV Connections,” for connection diagrams.
 - See the following pages for initial TV setup and use of the Auto Input Sensing feature.
 - To connect the TV to a personal computer, see “Using the TV with a Personal Computer,” page 17.

When You First Power On the TV Choosing a Language for Menus

1. Power on the TV for the first time.
2. Press **▲▼** to select either **English** or **Spanish** for all menus. You can later change the language selection through the **Setup > Language** menu. See page 43.

Installing the Remote Control Batteries

1. Remove the remote control’s back cover by gently pressing in the tab and lifting off the cover.
2. Load the batteries, making sure the polarities (+) and (-) are correct. For best results, insert the negative (-) end first.
3. Snap the cover back in place.

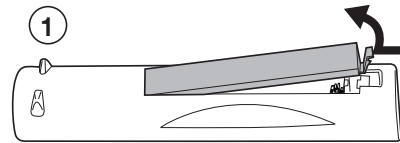

The remote control requires two AA alkaline batteries.

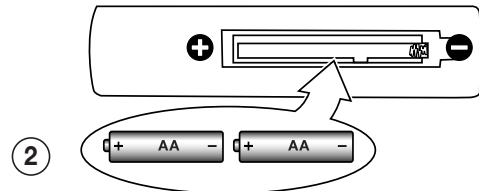

Turning the TV On or Off

To turn the TV on or off, point the remote control at the front of the TV and press the **POWER** button. Alternatively, press the **POWER** button on the TV’s control panel.

If You Turn Off the TV by Mistake

1. Press **POWER** again within about 60 seconds, while the lamp is still hot, to have the TV come back on immediately.
2. If the **LAMP** indicator starts blinking (about 60 seconds after you shut off power), wait a few moments for the **LAMP** indicator to stop blinking and press **POWER** to turn the TV on again.

Guidelines for Setting Up and Using Your New Widescreen TV, continued

- **736 or 835 Series TV:** See chapter 6, “Net-Command IR Control,” to perform NetCommand IR “learning” to set up control of your home theater.
7. Mitsubishi recommends you perform a channel scan for channels received on **ANT 1** and **ANT 2**. See “Initial TV Setup” page 13.
 8. You can now start watching TV or you can perform additional setup and customization through the TV menus.

Additional TV Setup

1. Review chapter 5, “TV Menus,” to customize TV operation. Press the **MENU** key to enter the menu system. Some examples of settings you may wish to change include:
 - **Fav.** Use an on-screen menu to create custom lists of your favorite channels from **ANT 1** and **ANT 2**. See **Setup > Edit**, page 44.
 - **Order.** Rearrange the device icons in the **Input Selection** menu to put frequently used icons near the front. See **Inputs > Order**, page 48.
 - **Name.** Change the device types that appear in the **Input Selection** menu. See **Inputs > Name** options, page 48.
 - **Parental Locks.** Restrict TV viewing by program rating, by channel, or by time of day. You can also disable the control-panel buttons if you have small children.
 - To restrict TV use by program rating, see the **Lock > Parent** menu, page 50.
 - To lock the control-panel buttons, use the **Lock > Control Panel** menu, page 51.
 - To restrict TV use by channel, see **Setup > Edit > Lock**, page 44.
 - **Video Settings.** Change video adjustments to get the best picture for your viewing conditions. See “AV Menu,” page 37.

Note: You may wish to change the Picture Mode from the default **Brilliant** to either **Bright** or **Natural**, which are suitable for most home viewing.

2. To program the remote control to operate A/V devices, see Appendix C, “Programming the Remote Control.”

TV Operation

1. Review chapter 4, “TV Operation and Features,” for TV features including:
 - **Input Selection (viewing source).** Select a connected program source to watch, such as a VCR, DVD player, or antenna. Press **INPUT** on the

remote control to select from icons for the TV inputs. See “Choosing a Viewing Source,” page 26.

- **Program Listings.** Press **GUIDE** to see ChannelView™ listings for programs on **ANT 1** and **ANT 2**. See “ChannelView Channel Listings,” page 29
 - **Picture Formats.** Press **FORMAT** to cycle through picture sizes and shapes to find the one best suited to the current program. See “TV Signals and Display Formats,” page 32.
2. To view still and moving digital camera images on the TV, see page 33, “Viewing Camera Files.”
 3. **736 or 835 Series TV:** To control A/V devices with NetCommand IR control, see page 56, “Operating NetCommand-Controlled Devices.”

TV Care

- **Lamp Cartridge.** When the lamp cartridge needs replacement, **replace the lamp yourself and save the cost of a service call.** See Appendix D for instructions.
- **General Cleaning.** See “Cleaning Recommendations,” page 4.

Assistance

- For troubleshooting, service, and product support, see Appendix F.
- For warranty information, see the TV warranty on page 90.

Initial TV Setup

Use the **Setup** menu for basic TV setup options.

1. Press **MENU** to open the **Main** menu.
2. Press **▼** to highlight the **Setup** icon and display the **Setup** menu.

Memorizing Channels

For ANT 1 and ANT 2

To start channel memorization

1. With the **Setup** menu displayed, press **▶** to highlight the **Scan** icon.



Start channel memorization from the **Setup** menu.

2. Press **▲▼** to highlight an input selection based on your connections:

Input	Condition
Ant 1 Air Ant 2 Air	When connected to an indoor or outdoor antenna
Ant 1 Cable Ant 2 Cable	When connected to direct cable (no cable box)

3. Press **▶** to highlight the on-screen **START** button.
4. Press **ENTER** to start automatic channel memorization.

To stop channel memorization before completion, press CANCEL.

5. When memorization is complete you can:
 - Press **MENU** once to return to the top row of icons.
 - Press **MENU** again to return to the **Main** menu.
 - Press **EXIT** to watch TV.

After channels have been memorized:

- To tune to memorized channels, press **CH ▲/▼** while watching TV on the **ANT 1** or **ANT 2** inputs.
- Use the **Setup > Edit** menu (page 44) for additional channel options, such as adding or deleting channels from memory, naming channels, and saving favorite channels in custom memory banks.

See chapter 5, "TV Menu Settings," to:

- Set the TV clock (page 45)
- Set the TV Timer (page 46)
- Select an Energy Mode to manage power use while the TV is off (page 47)

- Select a lamp brightness mode (page 47)
- Enable 3D video (pages 35 and 47)

Setting Up TV Inputs

When You First Connect a Device

The TV's Easy Connect™ Auto Input Sensing feature detects most connections automatically.

Note: For connection and setup of a personal computer, see the information on page 17.

Auto Input/Auto Output Sensing for Most Devices

When you first connect a device, the TV will:

- a. Detect the connected device and automatically switch to it
- b. Prompt you to identify the device type
- c. **736 or 835 series TV.** Prompt you to perform NetCommand set-up for the device, if available.
- d. Repeat these steps for any additional newly detected devices

See below for connections which trigger Auto Sensing.

Auto Input Sensing Available

Y/VIDEO (detected as composite video)

Y plus Pb (detected as component video)

S-VIDEO

HDMI *

USB (USB photo port on front)

INPUT 4 AUDIO (for an audio-only device; see page 25.)

Auto Output Sensing Available

DIGITAL AUDIO OUTPUT (orange jack)

AVR AUDIO OUTPUT (red jack)

No Auto Sensing

ANT 1 and ANT 2

- * If the device is powered off when connected, detection occurs when the device is next powered on.

Auto Input/Auto Output Sensing for CEC Devices

When the TV's NetCommand for HDMI feature is active, most CEC-enabled devices are recognized and identified automatically by the TV. NetCommand for HDMI may allow you to control functions of a CEC-enabled device. See Appendix E, "NetCommand HDMI Control of CEC Devices," page 77.

Setting Up TV Inputs, continued

Setup Procedure

Setup Procedure for TV Inputs

1. Power on the TV.
2. Connect your devices to the TV, making note of which TV input is used for each device. See chapter 3, “TV Connections.”

Note: If you wish to use an HDMI device’s CEC capabilities, follow the steps in Appendix E.

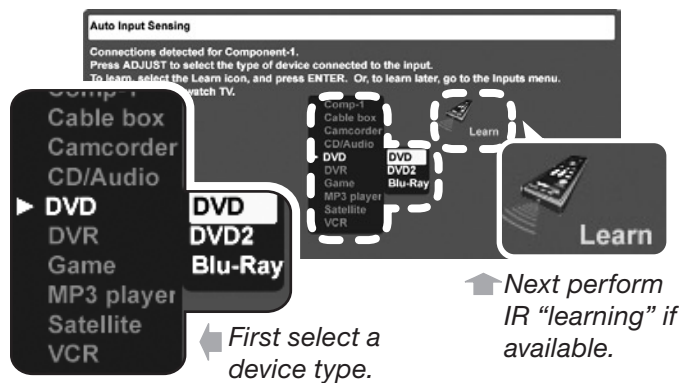

Sample Auto Input Sensing screen.

3. When the TV detects a new connection, the **Auto Sensing** screen for the connection type will display. Select the device type if required. See box at right.

Important Note for NetCommand IR Users (736 or 835 Series TV)

Be sure to select the correct device type here. Although you can change the device type later in the **Inputs > Name** menu, any “learned” NetCommand IR codes will be erased when you make the change.

4. **736 or 835 Series TV.** You can perform NetCommand IR “learning” after selecting the device type or at a later time when convenient. To perform now, highlight the Learn icon and press **ENTER**. See “Initial NetCommand Setup for Most Devices,” page 54 or “Setting Up NetCommand Control of an A/V Receiver,” page 58.
5. Press **EXIT** to close the **Auto Sensing** screen. The TV will then display the **Auto Sensing** screen for the next connection it finds.
6. After completing Auto Input/Auto Output Sensing, you may wish to set up or change control of your equipment using one of the home-theater control methods described in this Owner’s Guide. See “About Home-Theater Control Systems” on page 16.

Auto Input/Auto Output Sensing Screens

See below for how different connections are handled by Auto Input/Auto Output Sensing.

- **Most Device Types.** Select the device type from the on-screen list. The device type you select here will appear as an icon in the **Input Selection** menu. Press **▲ ▼** to move through the device list to highlight the device type connected to the input. Some device types also display a sub-menu of names—useful if using more than one of the same device. See the sample **Auto Input Sensing** screen shown.
- **A/V Receiver**
 - The TV detects audio connections on the **DIGITAL AUDIO OUTPUT** jack and the right (red) **AVR AUDIO OUTPUT** jack.
 - For an HDMI connection, select **AVR** from the list of device types if the A/V receiver is not recognized automatically.
- **HDMI Devices Compatible with the TV’s NetCommand for HDMI Feature.** Compatible CEC-enabled HDMI devices are often recognized automatically by the TV. After connecting the device, you may briefly see the standard **Auto Input Sensing** screen before the TV recognizes the device type. See Appendix E.

Tips on Auto Sensing and Changing Connected Devices

- Choose a different name for each input.
- Antenna inputs (**ANT 1/ANT 2**) are never detected, although you can turn off unused antenna inputs in the **Inputs > Name** menu.
- You can change the device type displayed in the **Input Selection** menu by using the **Inputs > Name** menu (page 48). Any “learned” NetCommand IR codes will be erased, however.

Changing Devices on an HDMI Input

1. Disconnect the HDMI device.
2. Delete the HDMI input in the **Inputs > Name** menu. See page 48.
3. Connect the new device and the **Auto Input Sensing** screen will display. **736 or 835 Series TV:** If you want the device under NetCommand IR control, perform NetCommand IR “learning” for the new device.

Disconnecting an Analog A/V Receiver

When you disconnect an analog A/V receiver, change the **Speakers** setting to **TV** to hear sound from the TV speakers. Change the setting using the remote control’s **AUDIO** key or the **AV > Audio > Speakers** menu.

Controlling A/V Receiver Sound Volume

Use one of the methods below to control sound volume from an A/V receiver.

With a Standard TV Setup

- **Recommended Method:** Program the TV's remote control for your A/V receiver and enable the Audio Lock feature. See page 68.
- Program the TV's remote control for your A/V receiver and set the TV remote's slide switch to the **AUDIO** position to control A/V receiver volume. Set the switch back to the **TV** position to control the TV.
- Use the remote control that came with the A/V receiver.

With NetCommand IR Control

736 or 835 Series TV. Set up NetCommand control of the A/V receiver's volume functions in the **Inputs > AVR** menu. The TV's remote will then control A/V receiver volume. See page 58.

With NetCommand for HDMI (CEC-Enabled HDMI A/V Receiver)

The TV's remote control may control some functions of the A/V receiver. See Appendix E, "NetCommand HDMI Control of CEC Devices," page 77.

About Home-Theater Control Systems

This summary offers some examples of the control methods available using the **TV's remote control**. You may wish to use one or more of these methods in your home theater after completing Auto Input Sensing.

Source device connected directly to the TV

Remote Control Programming with Any Connection Type

Program the remote control to operate the A/V device. To control the device, set the slide switch to the correct position for the device type. See Appendix C, "Programming the Remote Control." In the case of an A/V receiver, use the Audio Lock feature, page 68.

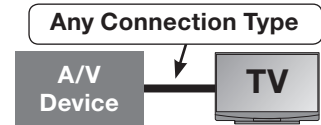

736 or 835 Series TV: NetCommand IR Control with Any Connection Type

Set up NetCommand IR control of the device's keys as desired. See "IR Emitter Placement," page 53, and "Initial NetCommand Setup for Most Devices," page 54.

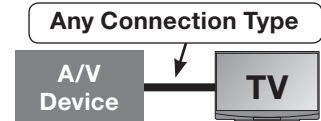

CEC-Enabled HDMI Device with HDMI Connection Only

1. Turn on the TV's NetCommand for HDMI feature. See the instructions in Appendix E, "NetCommand HDMI Control of CEC Devices," page 77.
2. Experiment with the TV's remote control (slide switch set to TV) to determine which device functions it can operate.

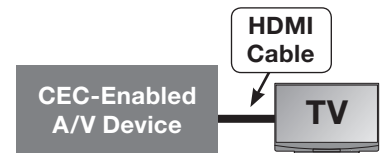

Source device connected to an A/V receiver connected to the TV

736 or 835 Series TV: A/V Receiver with HDMI Output (no CEC)

1. Assign the device to an A/V receiver input to allow you to set up NetCommand IR control of the **A/V receiver's** keys as desired. See "IR Emitter Placement," page 53, and "Setting Up NetCommand Control of an A/V Receiver," page 58.
2. Set up NetCommand IR control of the **source device's** keys as desired. See "Initial NetCommand Setup for Most Devices," page 54.

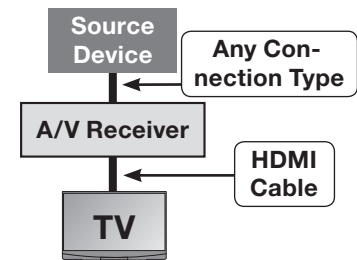

CEC-Enabled HDMI A/V Receiver

1. Turn on the TV's NetCommand for HDMI feature. See the instructions in Appendix E, "NetCommand HDMI Control of CEC Devices," page 77.
2. Try using the TV's remote control to operate the A/V receiver's volume and mute functions.
3. If the source device you want to connect also has CEC capability, see Appendix E for setup.
4. Try using the TV's remote control to determine which device functions it can operate. For example, on a CEC-enabled DVD player, check for a response to the **▶ (PLAY)**, **⏸ (PAUSE)**, and **■ (STOP)** keys. For a cable box, check for a response to **CH/PAGE** **^/∨**.

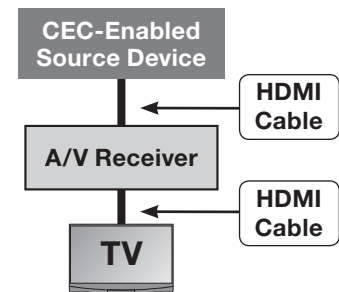

Using the TV with a Personal Computer

Connecting a Computer to the TV

Use one of the connection methods listed below based on your computer's video output.

Computer Video Output	Video Connection	Audio Connection
Digital DVI	DVI-to-HDMI cable or an HDMI cable with an HDMI-to-DVI adapter	Stereo audio cables
	Note: If the computer's audio output is a single mini jack, a mini audio-to-RCA-male "Y" adapter cable is also required.	
HDMI	HDMI-to-HDMI cable	No additional audio connection is required.

IMPORTANT

This TV accepts digital computer signals only.

1. See the TV specifications in Appendix A to confirm that your computer signal is compatible with the TV.
2. Connect the computer's digital signal output to one of the TV's **HDMI** jacks. See the connection diagrams for the method suited to your equipment.
3. Connect the computer's audio output using one of these options:
 - For digital DVI signals, connect analog left/right audio to the TV's **DVI/PC INPUT AUDIO** jacks.
 - For HDMI signals, no additional audio connection is required.
4. Power on the TV and computer. The TV will detect the connection and display the **Auto Input Sensing** screen.
5. In the **Auto Input Sensing** screen, press **▲ ▼** to highlight **PC** in the list of device types. It is important to use the name **PC** so that the TV can process the video signal correctly.
6. Press **EXIT** to close the **Auto Input Sensing** screen.

Note: If your computer provides digital audio output (coaxial or digital), you can connect it directly to a digital A/V receiver and bypass the TV.

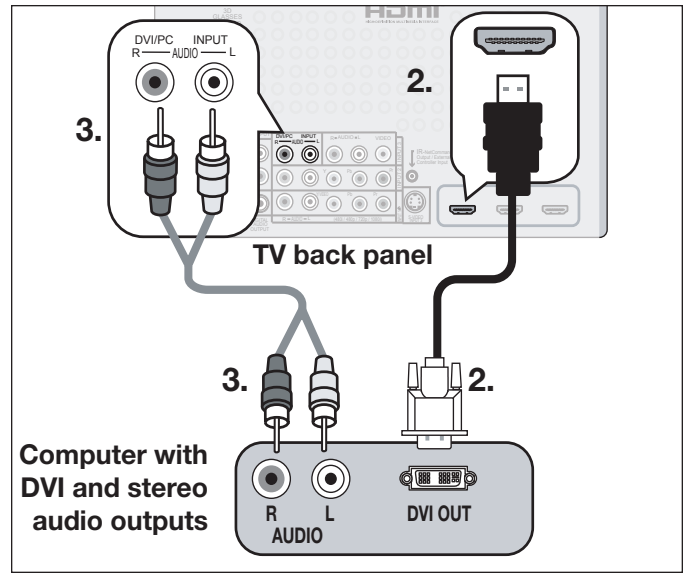

A DVI connection from a personal computer requires a separate audio connection. A computer connected to the TV back panel is shown above.

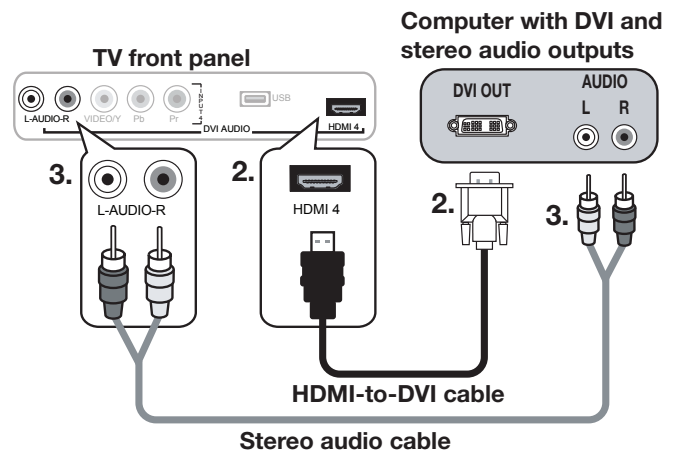

736 or 835 Series TV: Computer with DVI output connected to the TV front panel.

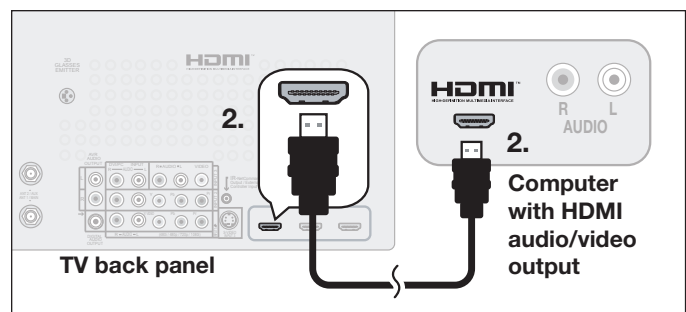

An HDMI-to-HDMI connection carries all video and audio on a single cable.

Using the TV with a Personal Computer

Computer Video Adjustments

1. Power on the computer if it is not already on.
2. Select **PC** from the **Input Selection** menu. To do this, press **INPUT** to open the **Input Selection** menu, move the highlight to the PC icon, and press **ENTER**.
3. Working from the computer, change the resolution of the computer image. View the computer image on the TV and maximize the computer resolution while maintaining a suitable aspect ratio for the image.
4. Perform TV video adjustments. Press **VIDEO** repeatedly to access video-adjustment options. The following additional adjustments are available for computer video:

Horiz Position (Horizontal Position). Manually adjust the horizontal position.

Vert Position (Vertical Position). Manually adjust the vertical position.
5. Press **FORMAT** repeatedly to find the picture format best suited to the image. See the chart on this page showing how different computer resolutions can be displayed on the TV.

Distortion in Computer Images

Computer images may show distortion when viewed on the TV, e.g., lines that should be straight may appear slightly curved.

Image Resolution

Your Mitsubishi TV can display resolutions from standard VGA (640 x 480) through 1920 x 1080 signals at a refresh rate of 60 Hz. The resolution of 1920 x 1080 is supported at refresh rates of 24, 30, and 60 Hz. See Appendix A, "Specifications" (page 64) for more on compatible screen resolutions.

In most cases, the computer will select the best resolution match to display on the TV. You can override this setting if you wish. Refer to your computer operating system's instructions for information on changing the screen resolution.

You may need to restart the computer for changes to take effect.

Tip:

Set the computer's screen saver to display a pattern after several minutes of inactivity. This acts as a reminder that the TV is powered on and the lamp is in use. The lamp is in use whenever the TV is powered on, even if the screen appears dark.

Computer Display Formats

Press the **FORMAT** key repeatedly to cycle through the TV displays available for your computer's video signal.

Computer Signal	As Displayed on TV Screen			
	Original Format	4 X 3 Standard	16 X 9 Standard	Zoom
VGA 640 X 480				
WVGA 848 X 480				
SVGA 800 X 600				
WSVGA 1064 X 600				

Original Format	Standard	Zoom
XGA 1024 X 768		
PC 720p 1280 X 720		
WXGA 1360 X 768		
SXGA 1280 X 1024		

Original Format	Standard	Reduce
PC 1080p 1920 X 1080		

3 TV Connections

Before You Begin

Auto Input Sensing

The TV's Auto Input Sensing feature automatically recognizes most connections and prompts you to identify the type of device connected. See chapter 2, "TV Setup," for more on Auto Input Sensing.

Connection Types

Review the connection types available on your input devices and use connections that will give the best video quality. For example, choose HDMI over component video, and choose component video over S-video or composite video.

Picture Quality

For best picture quality, route signals directly from the input device to the TV; avoid routing video signals through an A/V receiver, for example.

Surround Sound

For best surround sound audio quality, route audio-signal cables or HDMI cables from the source device directly to your A/V receiver or sound system.

IMPORTANT

Accessory items such as cables, adapters, splitters, or combiners required for TV connections are not supplied with the TV. These items are available at many electronics stores.

HDTV Cable Box or Satellite Receiver, DVD Player, or Other Device with Component Video

If your cable box or satellite receiver has an HDMI output, use the connections for HDMI devices described later in this chapter.

Required: RCA component video cables, left/right analog stereo audio cables.

1. Connect RCA-type cables from the **Y Pb Pr** outputs on the device to the **Y Pb Pr** inputs on the TV back panel, matching the colored green, blue, and red connections.
2. Connect left (white) and right (red) audio cables from the device to **AUDIO L** and **R** on the TV back panel.
3. **Cable Box or Satellite Receiver Only:** Connect the cable from the outside cable or satellite service to **CABLE IN** or **SATELLITE IN** on the cable box or satellite receiver. See your device's owner's guide for instructions and cable compatibility.

Note: To hear digital surround sound, connect the digital audio output from the device directly to your digital A/V receiver.

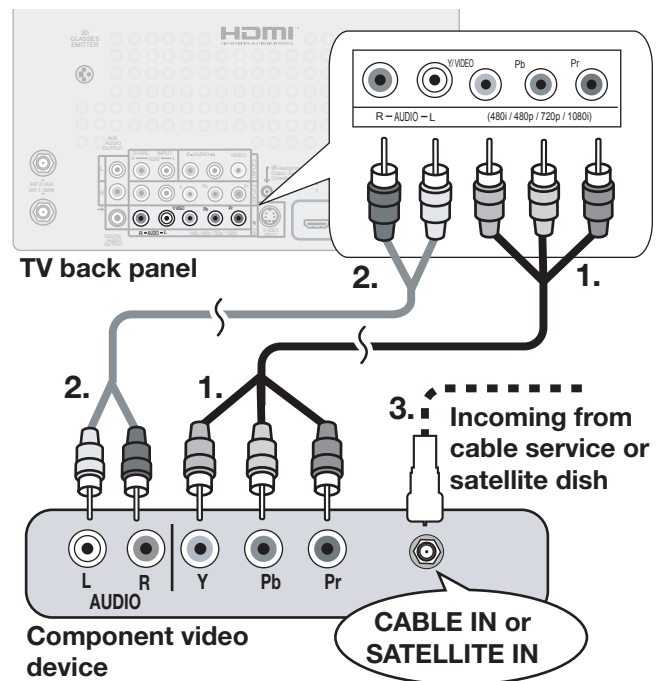

Figure 1. Connecting a device with component video outputs

HDMI Device (Cable Box, Satellite Receiver, DVD Player, or Other Device)

Required: HDMI-to-HDMI cable.

Connect an HDMI cable from the TV back panel to the HDMI device output. HDMI devices provide video and audio through the single cable.

Mitsubishi recommends you use category 2 (high-speed) HDMI cables to connect HDMI 1.3 source devices. High-speed category 2 cables bring you the full benefits of Deep Color and **x.v.Color**. See “HDMI Cable Categories,” page 10, for more on HDMI cable types.

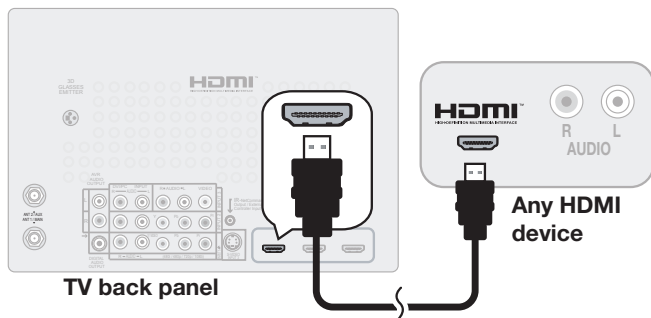

Figure 2. Connecting an HDMI device.

Note: HDMI inputs are *SimplyHD* certified for proper interoperability with other products certified by *Simply*™.

IMPORTANT

HDMI and Audio Signals

Digital Surround Sound: The TV's HDMI inputs can receive digital stereo audio signals only. To hear digital surround sound from an HDMI device, connect the device's HDMI or digital audio output directly to your A/V receiver. See the Owner's Guides for those devices for instructions.

DVI Video Device (Cable Box, Satellite Receiver, DVD Player, or Other Device)

Connect DVI devices (digital only) to the TV's HDMI input jacks.

Analog stereo audio cables and a DVI-to-HDMI cable or DVI/HDMI adapter and HDMI cable are required.

1. Connect the DVI-to-HDMI cable (recommended) or HDMI cable with DVI/HDMI adapter from the DVI device's back panel to the TV's HDMI jack.

Note: If you are using a DVI/HDMI adapter, it is important to connect the adapter to the DVI device for best performance.

2. Connect a set of audio cables from **AUDIO OUT** on the DVI device back panel to the **DVI/PC INPUT AUDIO** on the TV back panel. Connect the red cable to the **R** jack and the white cable to the **L** jack.

Note: The HDMI connection supports copy protection (HDCP).

Some devices require connection to an analog input first in order to view on-screen menus and to select DVI as the output. Please review your equipment instructions for DVI connectivity and compatibility.

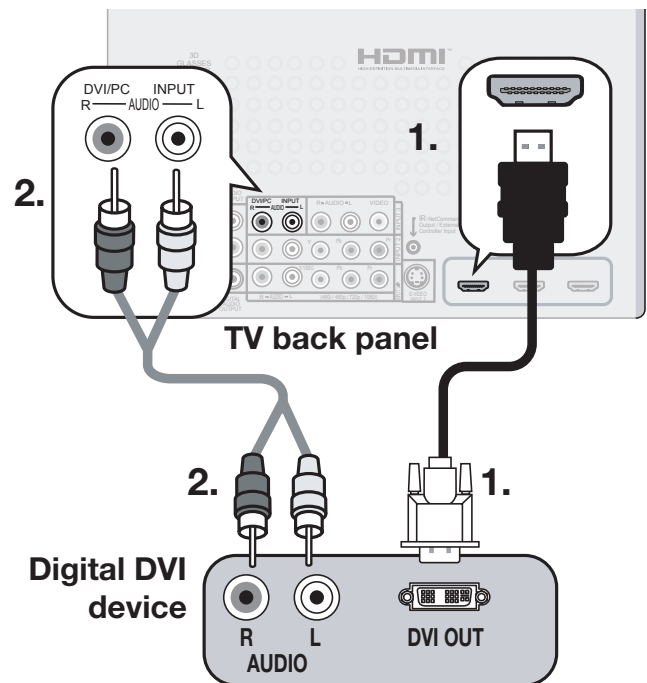

Figure 3. Connecting a digital DVI device

Wall Outlet Cable (no cable box)

It is very important to connect the incoming cable for your primary viewing source to **ANT 1**.

1. Connect the primary incoming coaxial lead cable to **ANT 1** on the TV back panel.
2. For an optional secondary antenna source, connect an antenna (or cable) to **ANT 2**.

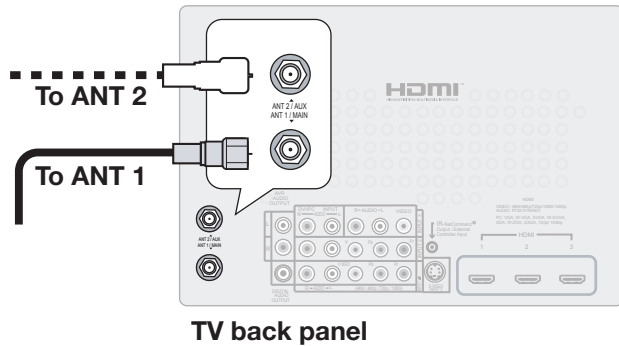

Figure 4. Wall Outlet Cable

Antenna with a Single Lead

A. For an antenna with flat twin leads

Required: 300-ohm-to-75-ohm transformer.

- A1. For an antenna with flat twin leads, connect the 300-ohm twin leads to the 300-ohm-to-75-ohm transformer.
- A2. Push the 75-ohm side of the transformer onto **ANT 1** on the TV back panel.

B. For cable or antenna with coaxial lead

Connect the coaxial lead directly to **ANT 1** on the TV back panel.

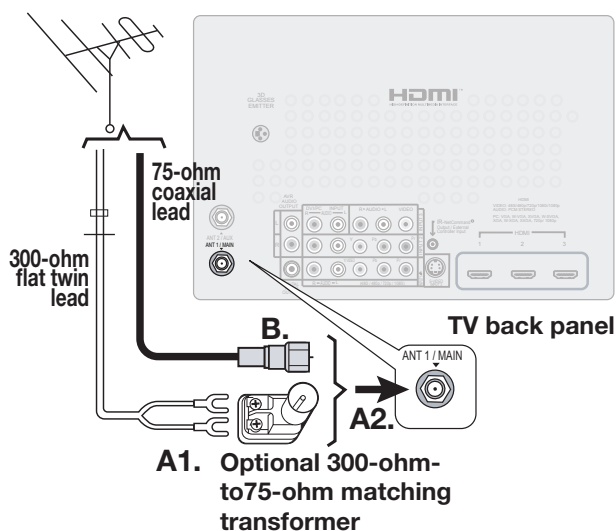

Figure 5. Connecting a Single Antenna Lead

Antennas with Separate UHF and VHF Leads

Required: UHF/VHF combiner

1. Connect the UHF and VHF antenna leads to the UHF/VHF combiner.
2. Push the combiner onto **ANT 1** on the TV back panel.

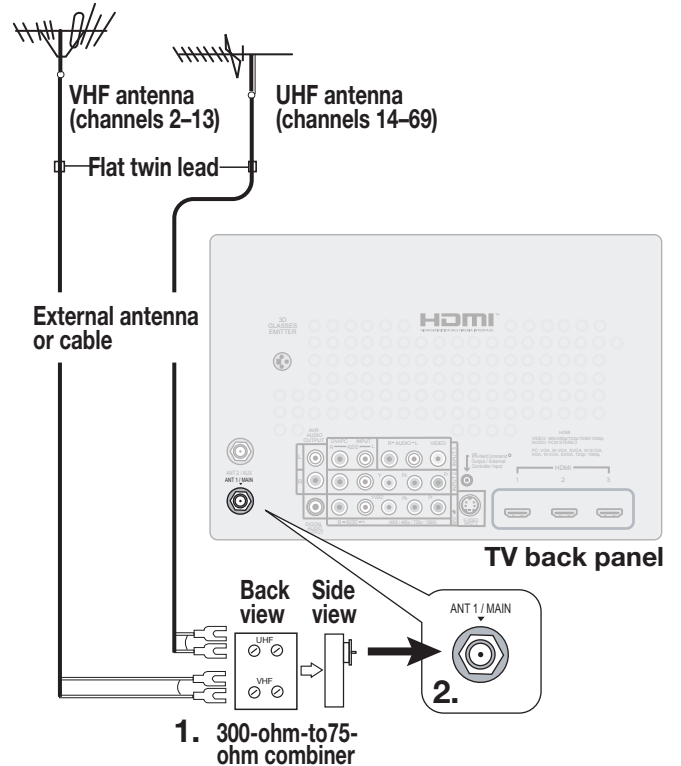

Figure 6. Connecting separate UHF and VHF Antennas

Mitsubishi strongly recommends you avoid using antennas with flat twin leads. Flat twin lead antenna wires are subject to interference which may adversely affect the performance of the TV. We recommend using coaxial antenna cable.

Standard Cable Box, Satellite Receiver, or Other Device with S-Video

Required: S-Video cable and left/right analog stereo audio cables.

1. Connect the cable from the outside cable or satellite service to **CABLE IN** or **SATELLITE IN** on the cable box or satellite receiver.
2. Connect an S-Video cable from **S-VIDEO OUT** on the cable box or satellite receiver back panel to **INPUT 3 S-VIDEO** on the TV back panel.
3. Connect left (white) and right (red) audio cables from **AUDIO OUT** on the cable box or satellite receiver to **INPUT 3 AUDIO L** and **R** on the TV back panel.

Note: Refer to the cable box or satellite receiver Owner's Guide for cable or dish antenna connections to the receiver.

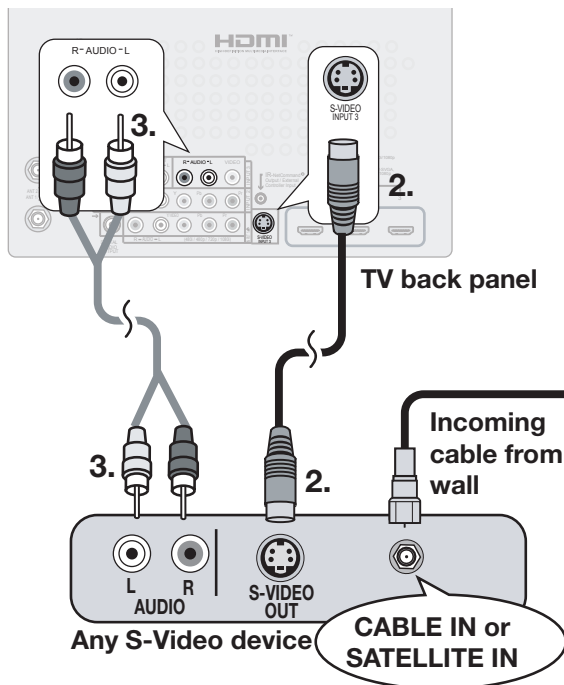

Figure 7. Connecting a device with S-Video

VCR to an Antenna or Wall Outlet Cable

Required: Two-way RF splitter, two coaxial cables, right and left analog audio cables, either S-video or composite video cable.

1. Connect the incoming cable or antenna to **IN** on the RF splitter.
2. Connect one coaxial cable from **OUT** on the RF splitter to **ANTENNA IN** on the VCR back panel.
3. Connect one coaxial cable from **OUT** on the RF splitter to **ANT 1** on the TV back panel.
4. Connect either an S-Video or composite video cable from **VIDEO OUT** on the VCR back panel to a **VIDEO** composite or **S-VIDEO** jack on the TV back panel. **Connect only one type of video cable;** S-Video is recommended, if available.
5. To use the TV speakers with the VCR, connect left (white) and right (red) audio cables from **AUDIO OUT** on the VCR to the associated **AUDIO L** and **R** jacks on the TV back panel. If your VCR is mono (non-stereo), connect only the white (left) cable.

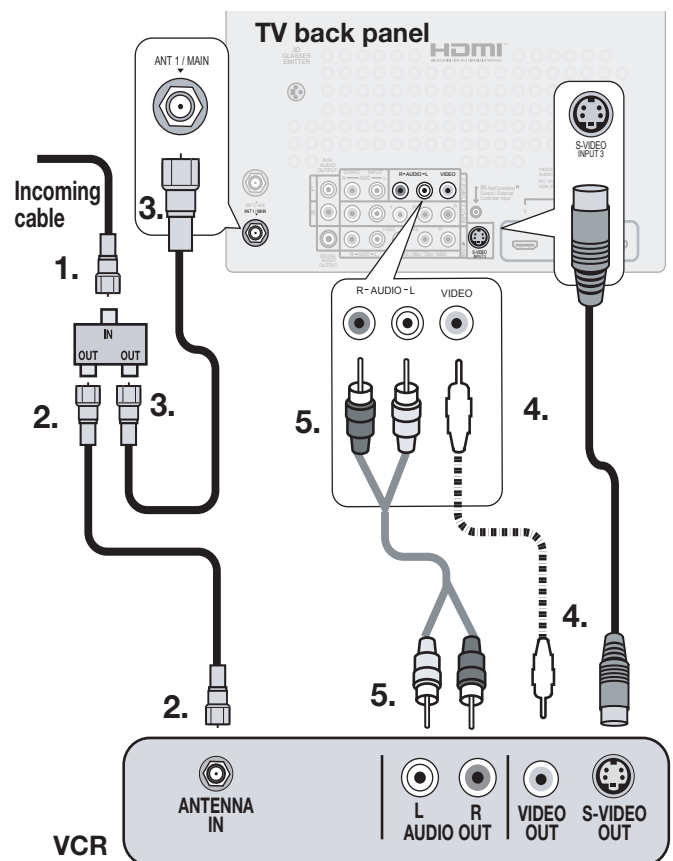

Figure 8. Connecting a VCR to an Antenna or Wall Outlet Cable

VCR to a Cable Box (Audio & Video)

Required: Two-way RF splitter, three coaxial cables, right and left audio cables, S-Video or composite video cable, plus video and audio cables required to connect the TV to the cable box.

1. Connect the incoming cable to **IN** on the RF splitter.
2. Connect one coaxial cable from **OUT** on the RF splitter to **CABLE IN** on the cable box.
3. Connect one coaxial cable from **OUT** on the RF splitter to **ANT 1** on the TV back panel.
4. Connect one coaxial cable from **OUT** on the cable box to **ANTENNA IN** on the VCR back panel.

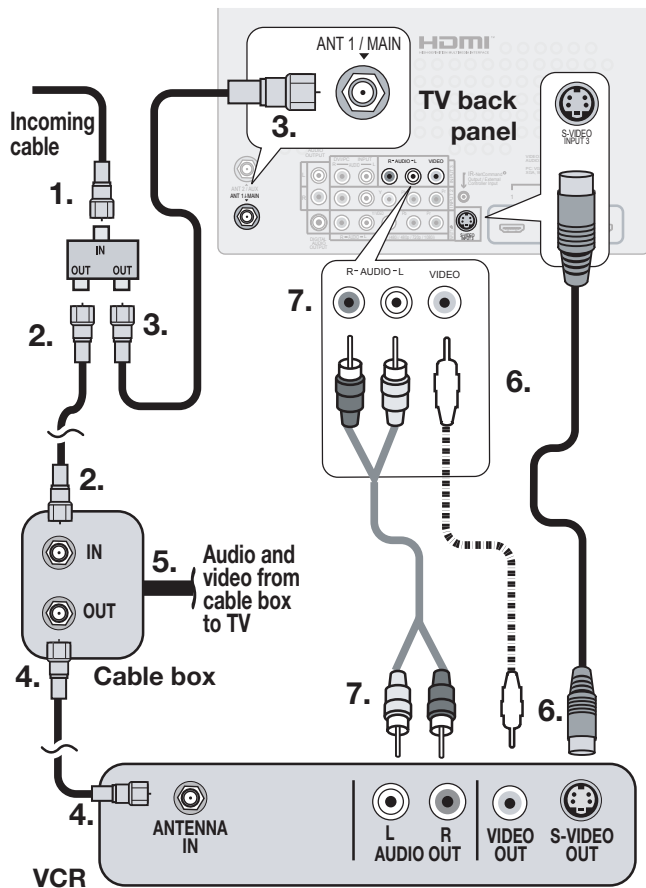

Figure 9. Connecting a VCR to a cable box

5. Connect the cable box outputs to the TV as shown in one of the options listed below. This connection allows the TV to receive the best available signal directly from the cable box.
 - **Figure 1, page 19:** Component video output to the TV's **Y Pb Pr** jacks; analog stereo audio to the associated **AUDIO** jacks.
 - **Figure 2, page 20:** HDMI output to the TV's **HDMI** jack.
 - **Figure 7, page 22:** S-Video output to the TV's **INPUT 3 S-VIDEO** jack; analog stereo audio to the **INPUT 3 AUDIO** jacks.

6. Connect either an S-Video or composite video cable from **VIDEO OUT** on the VCR back panel to a **VIDEO** composite or **S-VIDEO** jack on the TV back panel. Connect only one type of video cable. S-Video is preferable to composite video, if available.
7. To use the TV speakers with the VCR, connect left (white) and right (red) audio cables from **AUDIO OUT** on the VCR back panel to the associated **INPUT AUDIO L** and **R** on the TV back panel. If your VCR is mono (non-stereo), connect only the white (left) cable.

Note: When using this connection configuration with the connections used in step 5, it is possible to view live cable programs through the VCR Device. For best picture quality always view live cable programs directly from the TV input connected to the cable box device.

Older Cable Box

Required: One coaxial cable.

Note: This connection is not recommended. The other connections described in this chapter provide better quality audio and video to the TV and allow NetCommand to work with the cable box.

1. Connect the incoming cable to **IN** on cable box.
2. Connect one coaxial cable from **OUT** on the cable box to **ANT 1** on the TV back panel.

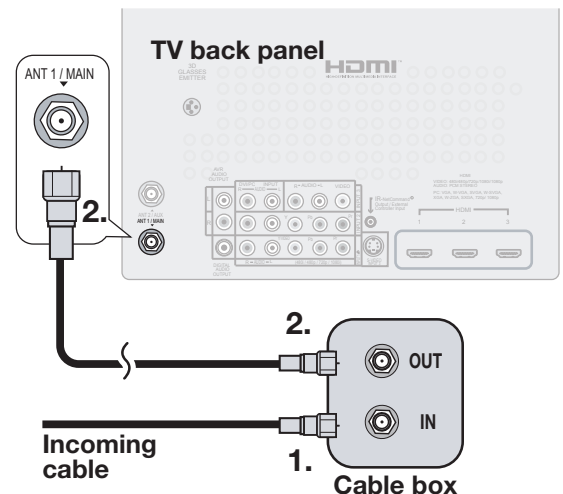

Figure 10. Connecting an older cable box

A/V Receiver (Sound System) Using the TV's Audio Output

Most setups require either a digital audio cable or analog stereo audio cables. To send audio from TV channels received on **ANT 1**, **ANT 2**, or devices connected directly to the TV, you must use one of the connections shown below.

The TV makes all audio available in digital and analog formats:

- Analog audio coming into the TV is available as output in digital stereo format on the **DIGITAL AUDIO OUTPUT** jack.
- Digital incoming audio is available as analog output on the **AVR AUDIO OUTPUT L** and **R** jacks.

Usually, only one of the following audio connections is required:

- **To connect an analog A/V receiver**
Connect left (white) and right (red) audio cables from **AVR AUDIO OUTPUT L** and **R** on the TV back panel to the **TV AUDIO INPUT** on the A/V receiver.
- **To connect a digital A/V receiver with Dolby Digital surround sound and PCM audio support:**
Connect one end of the digital audio cable to **DIGITAL AUDIO OUTPUT** on the back of the TV. Connect the other end to the **COAXIAL DIGITAL INPUT** on the back of the A/V receiver.

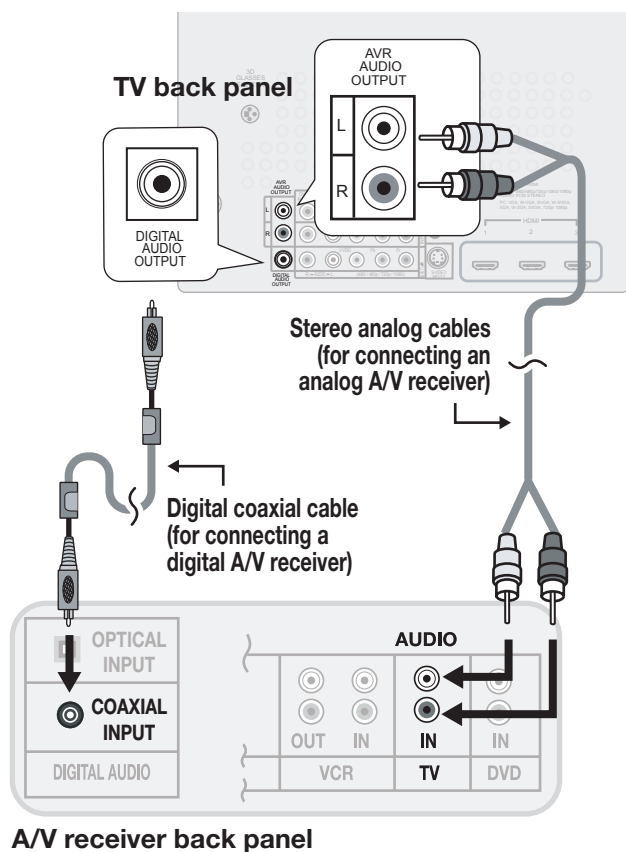

Figure 11. Connecting the TV to an A/V receiver

Note:

- On rare occasions, an HDMI signal may be copy-protected and cannot be output from the TV as a digital signal. To hear these copy-protected signals through the A/V receiver, use the connection for an analog A/V receiver.
- Check the A/V receiver's Owner's Guide for information concerning use of the digital input and switching between digital sound and analog stereo sound from the TV.

A/V Receiver with HDMI Output

Required: One HDMI-to-HDMI cable

This option allows you to view content from devices connected to an A/V receiver. The A/V receiver can send audio and video to the TV over a single HDMI cable. You can use an HDMI connection as described here in addition to an audio connection from the TV's audio output.

You may be able to use the TV's remote control (with slide switch set to TV) to operate connected CEC-enabled HDMI devices. Experiment with your equipment to determine which functions are available to the TV's remote control. See Appendix E, "NetCommand HDMI Control of CEC Devices" on page 77.

736 or 835 Series TV: This setup allows you to use NetCommand-controlled audio and video switching over the HDMI cable. See "A/V Receiver Control: Automatic Audio and Video Switching via HDMI" on page 61.

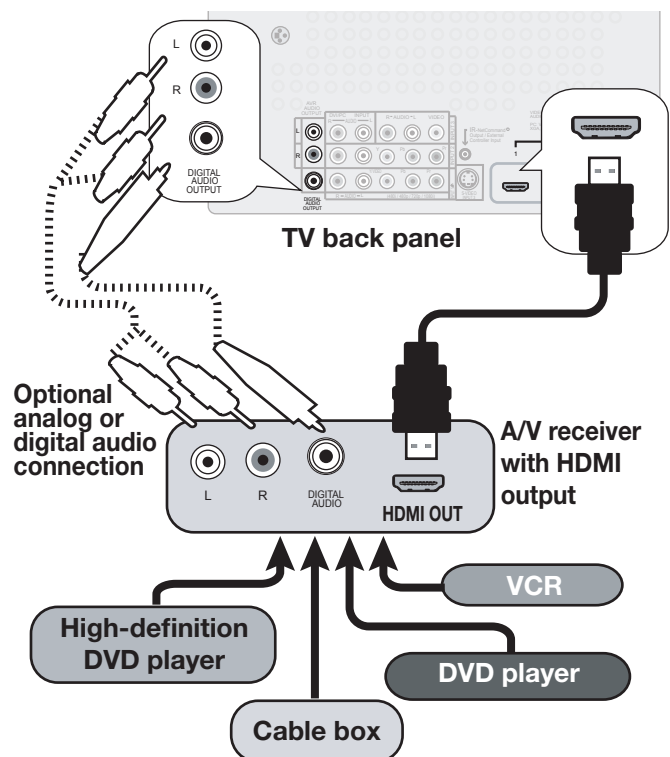
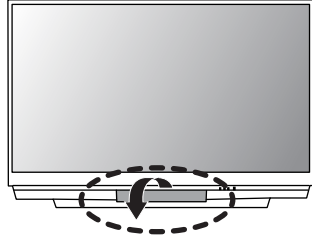

Figure 12. A/V receiver connected to the TV with an HDMI cable may offer special control capabilities.

Camcorder

Inputs on the front of the TV (**INPUT 4**) offer the most convenient way to connect a camcorder, although you can use jacks located on the back panel instead. Three different connection options are described on this page.

Use jacks on the TV front panel to connect a camcorder



A: Y Pb Pr Component Video Connection

Required: Component video and analog stereo audio cables supplied with the camcorder.

1. Connect component video cables from **VIDEO OUT** on the camcorder to the TV's **Y Pb Pr** component jacks on the front panel.
2. Connect left (white) and right (red) audio cables from **AUDIO OUT** on the camcorder to **AUDIO L** and **R** on the TV.

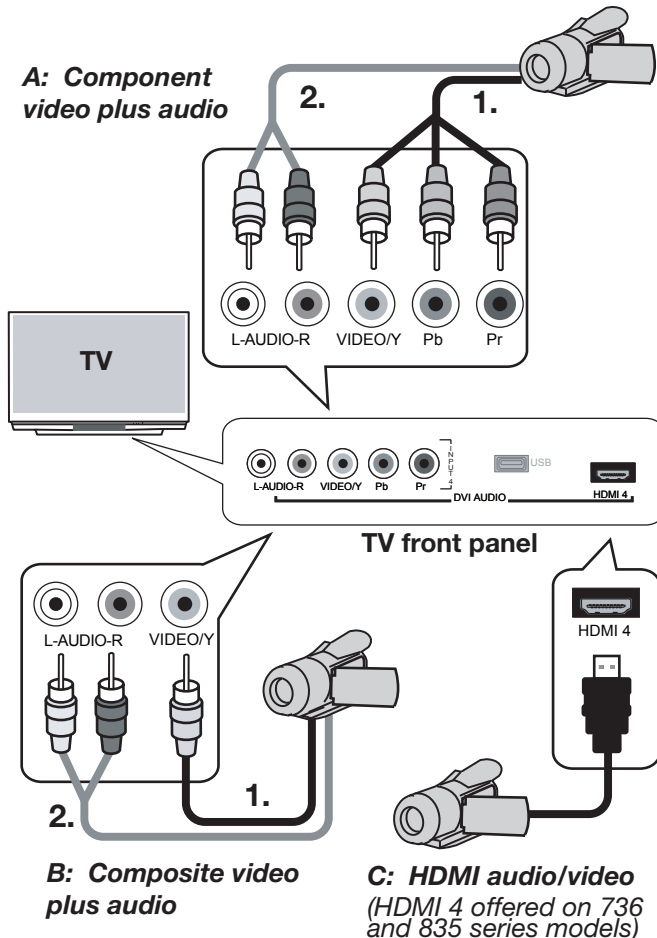

Figure 13. **INPUT 4** on the front of the TV offers up to 3 connection options for a camcorder.

B: Composite Video Connection

Required: Composite video and analog stereo audio cables supplied with the camcorder.

1. Connect the composite video cable from **VIDEO OUT** on the camcorder to **VIDEO/Y** on the front of the TV.
2. Connect left (white) and right (red) audio cables from **AUDIO OUT** on the camcorder to **AUDIO L** and **R** on the front of the TV.

C: HDMI Connection

Required: HDMI cable supplied with the camcorder.

736 or 835 Series TV. Connect the camcorder to the TV's **HDMI** jack on the front panel.

Audio-Only Device

If you wish to connect an audio-only device to the TV, such as an audio CD player or an MP3 player, follow these instructions. The front panel offers the most convenient jacks for this purpose, but you can use the rear-panel jacks as well.

1. Insert an unused RCA-style connector into the **VIDEO/Y** jack. The presence of this connector activates the TV's auto input sensing feature.
2. Connect left (white) and right (red) audio cables from **AUDIO OUT** on the device to **AUDIO L** and **R** on the TV.
3. Keep the connector in the **VIDEO/Y** jack while using the audio-only device.

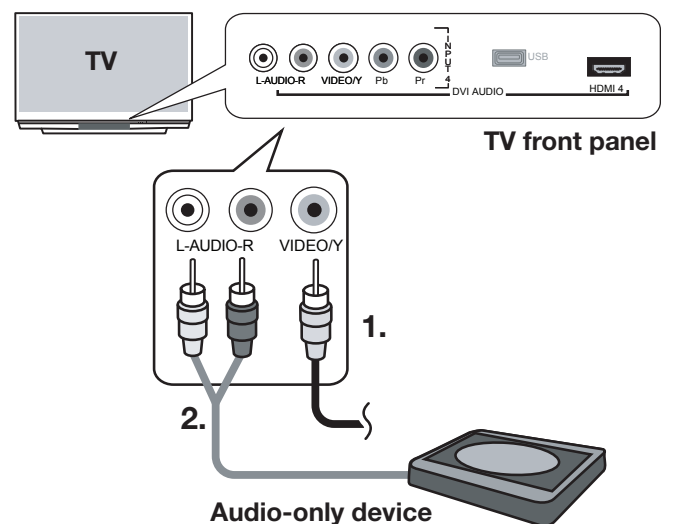

Figure 14. First insert an unused RCA-type connector into the **VIDEO/Y** jack on the TV front or back panel before connecting audio cables.

4

TV Operation and Features

Choosing a Viewing Source



Input Selection menu

Choose a viewing source from the **Input Selection** menu. The current TV input appears as a full-color icon in this menu.

1. Press **INPUT** to display the **Input Selection** menu. If there are only two inputs to the TV, **INPUT** switches between them without displaying the menu.
2. Highlight an input icon using **▲ ▼ ◀ ▶**.
3. Press **ENTER** to switch to the input and close the menu.

More About the Input Selection Menu

- To assign meaningful names to the icons, see the **Inputs > Name** menu, page 48.
- To rearrange the icons, see the **Inputs > Order** menu, page 48.

Sleep Timer

The Sleep Timer turns the TV off after the length of time you set. To set the TV to turn on at a certain time, see the **Setup > Timer** menu on page 46.

Setting the Sleep Timer

1. Press **SLEEP** on the remote control.
2. Press **SLEEP** additional times to increase the time in 30-minute increments up to the maximum of 120 minutes.
3. Press **EXIT** or wait five seconds without pressing any keys for the message to disappear.
4. Press **SLEEP** to view the time remaining before the sleep timer turns off the TV.

Cancelling the Sleep Timer

1. Press **SLEEP** to display the on-screen message.
2. Press **SLEEP** repeatedly until **OFF** is displayed.

Note: After five seconds of inactivity, the message box will disappear.

TV Tips

Turning the TV On or Off

To turn the TV on or off, point the remote control at the front of the TV and press the **POWER** button. Alternatively, press the **POWER** button on the control panel of the TV.

If You Turn Off the TV by Mistake

1. Press **POWER** again within about 60 seconds (while the lamp is still hot) to have the TV come back on immediately.
2. If the **LAMP** indicator starts blinking (about 60 seconds after you shut off power), **wait a few moments for the LAMP indicator to stop blinking and press POWER to turn the TV on again.**

Controlling Sound Volume

- Press **VOL ▲/▼** to adjust the sound level.
- See also “Controlling A/V Receiver Sound Volume” on page 15.

Changing Channels (antenna sources)

To change channels:

- Enter the channel number using the number keys on the remote control and press **ENTER**. For a two-part digital channel, such as 3-1, press 3 **CANCEL** 1 to enter a dash (separator).
- Press **CH/PAGE ▲/▼** to change channels one channel at a time.
- Press and hold **CH/PAGE ▲/▼** to move quickly through channels.
- Press **QV** (QuickView) to switch back to the previously tuned channel.
- Press **GUIDE** to display ChannelView channel listings, highlight a channel, and press **ENTER** to select.
- Use the Fav (Favorites) feature to set up lists of favorite channels and tune to them with the **FAV** key. See **Setup > Edit > Fav 1–Fav 6** on page 44.

NOTE: Perform channel memorization to make finding channels easier. See **Setup > Scan, page 43.**

Remote Control

1. **POWER:** Turns TV power on and off.
2. **Slide Switch:** Selects the A/V device to be operated by the remote control. Set the slide switch to TV for operation of the TV, and NetCommand-controlled devices. Control of additional devices requires programming (see Appendix C, "Programming the Remote Control.")
3. **SLEEP:** Sets the TV to turn off within 2 hours in increments of 30 minutes.
4. **Digits/Letters:** Press digits for channel numbers, then press **ENTER** for faster tuning. Use numbers and the **CANCEL** key to enter digital sub-channel numbers. Use also for entering letters or names in menus.

To select letters when naming channels, repeatedly press the associated number key. Press **ENTER** to set the letter. Special characters are available with the **1** key (!, &, blank space) and **0** key (/ , * , -).

5. **-/CANCEL (SUB-CHANNEL/CANCEL):** When entering digital channel numbers, adds a separator between main and sub-channel numbers. Clears Fav and some menu entries.
6. **QV (QuickView™):** Switches between the current channel and the last channel viewed.
7. **MUTE:** Turns TV sound on and off.
8. **SPLIT:** Not used in this model.
9. **FAV (Favorites):** Scans through memorized lists of favorite channels. See **Setup > Edit > Fav1-Fav6** on page 44.
10. **VOL ^/∨ (Volume Up/Down):** Changes sound level.
11. **CH/PAGE ^/∨ (Channel or Page Up/Down):** Scans up or down through memorized channels. Pages up and down through screens when used with ChannelView™.
12. **FORMAT:** Changes the shape and size of the TV picture.
13. **LIST (835 Series):** Works like the LIST key for a cable box or satellite receiver when "learned" for NetCommand or when the remote has been programmed for the device.
14. **INPUT:** Displays the **Input Selection** menu from which you can select an input source to view, such as an antenna input (**ANT 1/2**) or a connected device.
15. **▲ ▼ ◀ ▶ (Adjust Up/Down/Left/Right):** Navigate menus and change settings.
16. **ENTER:** Selects a channel number or menu item.

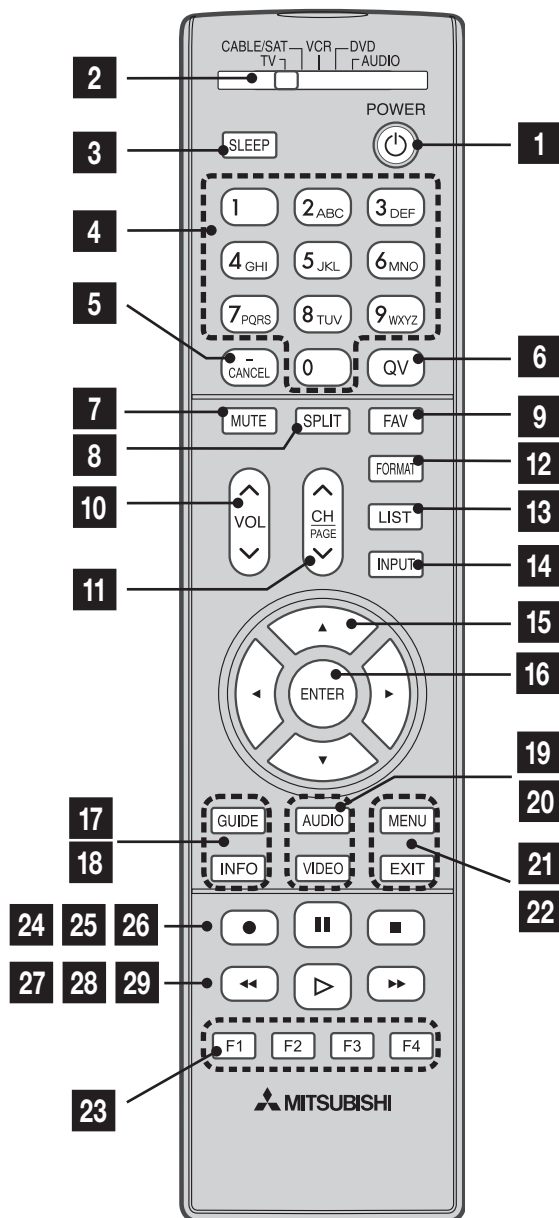







17. **GUIDE:** Displays or removes ChannelView™ channel listing for **ANT 1** and **ANT 2**. Displays DVD disc or top menu for a NetCommand-controlled DVD player. Displays the guide for a NetCommand-controlled cable box or satellite receiver.
18. **INFO:** Displays an on-screen summary of the current device in use and any broadcast information available, including current V-Chip ratings information. See "Status Display," page 30, for details.
19. **AUDIO:** Selects individual audio settings to adjust.
20. **VIDEO:** Selects individual video settings to adjust.

Remote Control, continued

- 21. MENU:** Displays the main TV menu. When a sub-menu is open, backs up one menu level.
- 22. EXIT:** Closes TV on-screen menus/displays.
- 23. F1-F4**
For devices under NetCommand control:
 Perform NetCommand “Learning” to assign your choice of functions to the F1–F4 keys.
For devices operating independently of NetCommand: The F1–F4 keys work like the A, B, C, D buttons on some cable boxes, satellite receivers, and DVD players. Program the remote control for your equipment and test the keys. See Appendix C, “Programming the Remote Control.”
- 25.  (PAUSE):** Freezes a broadcast TV picture from an antenna source, cable box, or satellite receiver (if key has not been reassigned for NetCommand use).

Record/Playback Keys

Use any of these methods to enable the recording and playback commands of the TV’s remote control:

- Program the remote control for your DVR, VCR, or DVD player/recorder and set the slide switch to **VCR**, **DVD**, **CABLE/SAT**, or **AUDIO** as appropriate.
 - Check HDMI devices for compatibility with the TV’s NetCommand for HDMI feature (see Appendix E).
 - **736 or 835 Series TV:** Perform NetCommand IR “learning” for the device.
- 24.  (RECORD):** Records with a VCR or DVR.
- 25.  (PAUSE):** Pauses a VCR, DVR, or DVD. See above for use during TV viewing.
- 26.  (STOP):** Stops play of a VCR, DVR, or DVD.
- 27.  (REVERSE):** Rewinds a VCR. Reverse scans a DVR or DVD.
- 28.  (PLAY):** Plays a VCR, DVR, or DVD.
- 29.  (FORWARD):** Fast forwards a VCR. Forward scans a DVR or DVD.

Note: To operate other audio/video devices using the TV’s remote control:

- See Appendix C, “Programming the Remote Control.”
- For HDMI devices compatible with the TV’s NetCommand for HDMI feature, see Appendix E.
- **736 or 835 Series TV:** See chapter 6, “NetCommand IR Control,” for NetCommand IR “Learning” of device keys.
- For use of specific keys with NetCommand-controlled devices, see “Special Operation Methods,” page 56.

Resetting the Remote Control

If the slide switch is set to **TV** and the TV does not respond properly, reset the remote control.

- 1.** Press and hold **POWER** for several seconds until the button blinks twice and goes off.
- 2.** Release the **POWER** button.
- 3.** Press keys **0 0 9 3 5** and the **POWER** button will blink twice when you finish entering the code. While entering the code, pause for a moment between each key press to ensure it is recognized.

Low-Battery Indicator

If you press a key and the **POWER** key blinks five times, replace the remote control’s batteries.

Care of the Remote Control

- Use only alkaline batteries.
- Be within 20 feet of the equipment.
- Do not press two or more buttons at the same time unless instructed to do so.
- Do not allow unit to get wet or become heated.
- Avoid dropping on hard surfaces.
- Do not use harsh chemicals to clean. Use only a soft, lightly moistened cloth.
- Do not mix old and new batteries.

ChannelView Channel Listings

CHANNEL VIEW	ChannelView™ Ant-1	5:47 pm, Fri., July 25
2	CBS	Programs for KCET-DT
2-1	KCBS-DT CBS Local News	5:30 PM Nightly Business Re...
4		6:00 PM NewsHour with Jim ...
4-1	KNBC-DT NBC World News	7:00 PM Life and Times
7	ABC	7:30 PM California's Gold
7-1	KABC-DT ABC World News	8:00 PM Washington Week
28	PBS	8:30 PM Wall Street Week wit...
28-1	KCET-DT The Rose Parade	9:00 PM Now with Bill Moyers
28-2	KCET-DT Nightly Business Re...	10:00 PM Culture of Hate: Wh...
32		11:00 PM Tavis Smiley

In addition to reporting on the day's breaking business, economic and market news, Nightly Business Report features commentators, special ...

ChannelView screen

ChannelView™ shows memorized channels on **ANT 1** or **ANT 2**. It displays channel names and program information as sent by broadcasters or your local cable service provider and may be incomplete. No program information is displayed for analog channels. An analog channel name is displayed only if you assigned a name in the **Setup > Edit** menu (page 44).

To receive ChannelView updates:

- Keep the Energy Mode set to **Fast Power On**
- Set the TV clock
- Leave the TV powered off for a while each day to receive updates.

Note: Whenever you watch a digital channel, listings are updated for the channel you are watching.

Using ChannelView

Feature	Press Key
See ChannelView listings from ANT 1 or ANT 2 .	Press GUIDE .
Close ChannelView	Press GUIDE or EXIT .
Scan channels one by one.	Press and hold ▲ or ▼ .
Scan channels quickly.	Press and hold PAGE ▲/▼ .
Jump to listings for a specific channel.	<ol style="list-style-type: none"> 1. Enter the channel number (see numbers in upper left of screen). 2. Press ENTER.
See more of the program description (if available).	Press INFO .
Move navigation to the program listings.	Press ▶ .
Move navigation to the channel listings.	Press ◀ .
Tune to the highlighted channel.	Press ENTER .



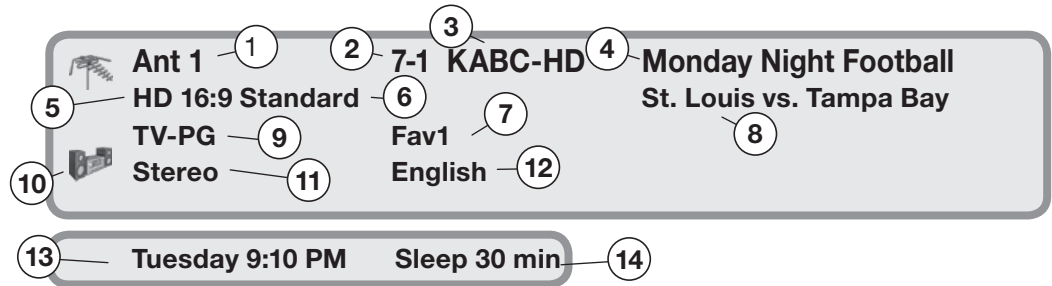

Status Display

Press the **INFO** key to see the on-screen status display. The most common displays are shown here. You will rarely, if ever, see all status indicators at the same time.



On-screen status display sample information



Analog Sources	Digital Sources
1. Source antenna or input	Source antenna or input
2. Analog channel being received (antenna sources only)	Digital major and sub-channel numbers (antenna sources only)
3. Analog channel name (if named in the Setup > Edit menu); antenna sources only.	Digital Channel Name (if broadcast or if named in the Setup menu > Edit options; antenna sources only)
4. (Does not apply)	Program name (if broadcast)
5. Signal Type Being Received. Possible: On antenna sources or VIDEO composite or S-VIDEO jacks: 480i On component jacks: 480i, 480p, 720p, 1080i	Signal Type Being Received. Possible: On antenna sources: SD 4:3, SD 16:9, HD On HDMI: 480i, 480p, 720p, 1080i, 1080p, all supported PC resolutions
6. Screen Format in use. Possible: Analog 480i /480p signals: Standard, Expand, Zoom, Stretch, Stretch Plus, Narrow 720p/1080i signals: Standard, Wide Expand, Zoom	Screen Format in Use. Possible: SD 4:3, 480i, or 480p: Standard, Expand, Zoom, Stretch, Stretch Plus, Narrow SD 16:9 or HD 16:9, 720p, or 1080i: Standard, Wide Expand, Zoom 1080p: Standard, Wide Expand, Zoom
7. Current Fav bank number of channel (antenna sources only)	Current Fav bank number of channel (antenna sources only)
8. (Does not apply)	Program description (if broadcast); antenna sources only)
9. V-Chip rating (antenna sources or VIDEO composite and S-VIDEO jacks only)	V-Chip rating (antenna sources only)
10. Audio Source. Possible:  TV speakers,  external sound system	Audio Source. Possible:  TV speakers,  external sound system
11. Listen To indicator. Possible: Stereo, Stereo SAP, SAP (antenna sources only)	Listen To indicator. Possible: Stereo, Surround 3.1, Surround 5.1, Surround 7.1, Dual Mono
12. (Does not apply)	Current language (antenna sources only)
13. Day and time	Day and time
14. Sleep Timer remaining time	Sleep Timer remaining time
15. Mute indicator	Mute indicator
16. (Does not apply)	Signal strength indicator (antenna sources only)

Fav (Favorite Channels)

Use the six Fav channel banks to store groups of your favorite channels from **ANT 1** and **ANT 2**. You can set up a Fav channel bank for each of your favorite program types or set up a bank for each TV user.

You may prefer to perform Fav channel setup from a menu. See the **Setup > Edit** options, page 44.

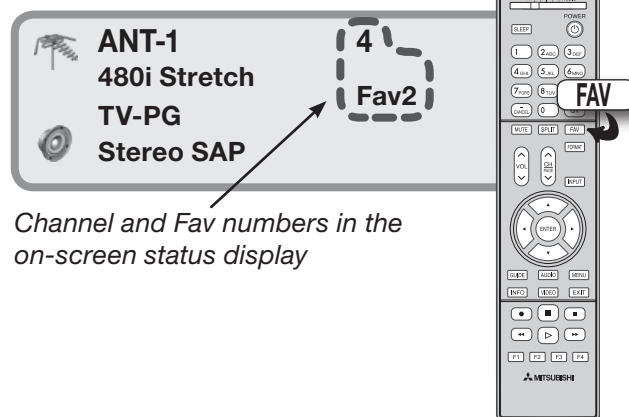

Channel and Fav numbers in the on-screen status display

Using Fav Channels

See the current Fav bank number	Press INFO.
View channels in current Fav bank	<ol style="list-style-type: none"> 1. Press the FAV key. Wait for the TV to tune to a channel in the current Fav bank. 2. Press the FAV key repeatedly to cycle through the channels available in the current Fav bank.
Change Fav banks	<ol style="list-style-type: none"> 1. Press the FAV key. Wait for the TV to tune to a channel in the current Fav bank. 2. When tuning is complete and while the TV status display is still visible on screen, press the number key for the desired bank (1–6). <p>Note: Wait for the channel change to finish before pressing the number key. Otherwise, the TV may ignore the Fav number.</p>
If no Fav banks are set up	The FAV key switches to the previously tuned channel; works like the QV key.

Fav Setup Using Only the Remote Control

Add Fav channels	<ol style="list-style-type: none"> 1. While watching TV, tune to the channel you want to add to the current Fav memory bank. The default bank is Fav1. See the instructions above if you need to change to a different Fav bank. 2. Press and hold the FAV key for about 2 seconds. When Fav and the memory bank number appear under the channel number, the channel has been successfully added.
Remove Fav channels	<ol style="list-style-type: none"> 1. While watching TV, press the FAV key. 2. While the TV status display is still visible on screen, press the number key for the memory bank. 3. Press the FAV key repeatedly until you see the desired channel in the on-screen status display. 4. While the channel number and Fav indicator (with correct bank number) are still displayed on the screen, press CANCEL. You must press CANCEL while the indicator is displayed. When the Fav indicator disappears after pressing CANCEL, the channel has been successfully removed.

This procedure removes the channel only from the selected bank and leaves the other banks unchanged.

TV Signals and Display Formats

This is a 16:9 widescreen TV suitable for images available from HDTV and many DVDs. You can view older-style squarish images (4:3 aspect ratio) using one of the display formats described on this page. Press the **FORMAT** key to cycle through the available display formats. The TV remembers the format you last used for each input.

DVD Image Definitions

Image information may be stated on the DVD case. Some DVDs support both of the formats described below.

Anamorphic (or Enhanced for WideScreen TV)

Indicates DVDs recorded to show widescreen images properly on 16:9 TV sets using the TV's Standard format mode (recommended).

Non-Anamorphic (or 4:3, 1:33:1, Letter Box, or Full Screen)

Indicates DVDs recorded for viewing on squarish TV screens. They may be full screen (4:3 or 1:33:1) which crops movies to fit the narrow TV, or letter box, which adds black top and bottom bars.

Signal Definitions

480i: Traditional interlaced signals from **ANT-1** and **ANT 2**, composite **VIDEO**, component **Y Pb Pr**, and **HDMI** jacks.

480p: Progressive-scan DVD signals on component **Y Pb Pr** and **HDMI** jacks.

720p and 1080i: High-definition signals received through component **Y Pb Pr** and **HDMI** jacks. These signals are always 16:9 (widescreen).

SD 4:3: Standard-definition squarish-screen-format signals from digital channels on **ANT 1** and **ANT 2**.

SD 16:9: Standard-definition widescreen-format signals from digital channels on **ANT 1** and **ANT 2**.













HD 16:9: High-definition 16:9 widescreen signals from digital channels on **ANT 1** and **ANT 2**.



TV Display Format Definitions

Standard: This is the full-screen format used by HDTV signals. Use this format to display anamorphic DVDs with a 1.78:1 or 1.85:1 aspect ratio. Anamorphic DVDs with a 2.35:1 aspect ratio are displayed correctly but with top and bottom black bars. Narrow (4:3) images are stretched evenly from side to side. Available for all signals.

Expand: Enlarges the picture to fill the screen by cropping the top and bottom; useful for reducing the letter box top and bottom bars of non-anamorphic DVD images.

Zoom: Enlarges the picture to fill the screen by cropping the sides, top, and bottom to eliminate black bars. 480i/480p and SD 4:3 signals: Eliminates top and bottom bars on anamorphic DVDs with a 2.35:1 aspect ratio. 720p, 1080i, SD 16:9, and HD signals: Eliminates bars added to 4:3 images.

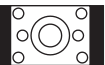
Original Signal	Non-anamorphic or SD 4:3	Anamorphic DVD
Standard	 Distorted. Not recommended.	 Recommended
Expand	 Recommended for letterbox. See Note 1.	 Distorted; not recommended. See Note 1.
Zoom	 Distorted. Not recommended. See Note 1.	 Recommended for anamorphic 2.35:1 images. See Note 1.
Stretch	 Recommended for standard broadcasts. See Note 1.	 Distorted; not recommended. See Note 1.
Stretch Plus	 Recommended for standard broadcasts. See Note 1.	 Distorted; not recommended. See Note 1.
Narrow	 See Note 1	 Distorted; not recommended. See Note 1.

Original Signal	Display Formats
SD 16:9 or HD Digital 720p, 1080i, 1080p Signal	 Wide Expand Recommended to remove side bars.  Zoom Recommended to remove bars from the top, bottom, and sides.

TV Display Formats. Press the **FORMAT** key repeatedly to see the displays available for the current program. Press the **INFO** key to see the name of the display format in use.

Note 1: Available for 480i, 480p, and digital SD 4:3 signals only.

Stretch: Stretches a narrow 4:3 image across the screen to display the entire image with less distortion than the Standard format.

Stretch Plus: Similar to Stretch, but minimizes distortion on the sides by expanding the picture to crop off portions of the top and bottom. You can adjust the vertical position of the picture. Press **VIDEO** repeatedly to show the **Vert Adjustment** option, then press **ENTER**. Use **▲ ▼** to move the picture.

Narrow: Displays narrow 4:3 images in their original shape. Adds black side bars to fill the screen.

Wide Expand: Enlarges the picture, cropping the image on both sides. Removes or reduces black side bars added to narrow images converted to 16:9 signals for digital broadcast.

Note: All high-definition channels send widescreen (16:9) signals, but not all such programming was created for this format. The broadcaster may stretch the image or add side bars to fill the widescreen area.

Viewing Camera Files

JPEG Photos and the USB Photo Port

1. Connect your USB card reader or USB drive to the TV's USB Photo port.

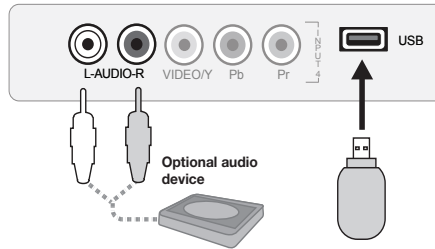

The **USB Photo** menu displays

while files are being read. Wait until you see the completion message on screen before continuing.

Note: Some manufacturers' devices may be incompatible with the TV. If the TV is unable to display your photos, you can:

- Transfer files to a different USB device.
- Use the camera's composite video output as described later in this chapter.

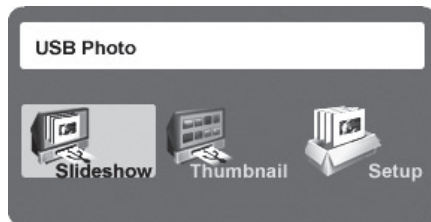

USB Photo menu

2. Refer to the table below for use of the **USB Photo** menu after files have been read.
3. **Optional:** Connect an audio device to the **AUDIO L** and **R** stereo jacks to play sound while viewing pictures

USB Photo Menu Options









Start slide show.	With the Slideshow icon highlighted, press  or ENTER .
Activate menu options.	Highlight an icon and press ENTER to: <ul style="list-style-type: none"> • start the slide show • display picture thumbnails • open the Media Setup submenu.
Display or close the Main menu.	Press MENU .
Display status for the file source.	Press INFO .
Select a different connected device	<ol style="list-style-type: none"> 1. Press INPUT. 2. Highlight the icon for a different device. 3. Press ENTER.
Clear status display or menu to show the USB Photo menu	Press EXIT .



JPEG Thumbnail Menu

Use these keys while viewing JPEG thumbnail images:

Keys for the JPEG Thumbnail Menu

   	Move the highlight from image to image.
FORMAT	Rotate the thumbnail clockwise in 90° increments
 or ENTER	Play the slide show starting with the highlighted thumbnail.
	Highlight the last thumbnail on the current page.
	Highlight the first thumbnail on the current page.
CH/PAGE  / 	Display the next or previous page of thumbnails.
EXIT	Close the Thumbnail menu and display the USB Photo menu.
MENU	Close the Thumbnail menu and display the Main menu.
INPUT	Close the Thumbnail menu and display the Input Selection menu.

Notes on Viewing JPEG Files

- The TV ignores all commands while reading files. Wait for the completion message before continuing.
- Large files or high-capacity storage devices may take a long time to display. The screen will be blank while files are read.
- Use only one source device at a time.
- Back up the data on your USB drive before connecting it to the TV. Mitsubishi is not responsible for any file damage or data loss.





IMPORTANT

Stop playback or change to a different TV input before disconnecting from the USB photo port.

Slide Show

Use these keys during the slide show:

Keys for JPEG Picture Slide Show

	Begin or resume slide show playback
	Pause or resume playback while in automatic advance mode.
 or ENTER	Advance to the next slide.
	Go to the previous slide.
FORMAT	Rotate the slide clockwise in 90° increments.
	Stop slide show and display the USB Photo menu.
INFO	Display status for the viewing device and current image.
INPUT	Display the Input Selection menu.
MENU	Display or remove the TV Main menu.

Note: Always press  (STOP) to stop slide show playback before disconnecting from the USB Photo port.

Media Setup Menu

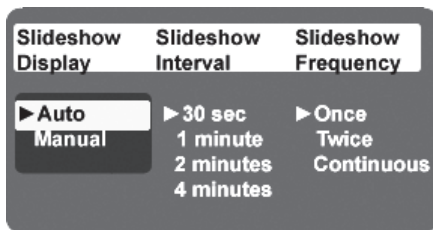

Media Setup menu

In the **Media Setup** menu you can adjust the slide show display, number of repetitions, or display interval.

- Select either **Auto** or **Manual** advance. During manual operation, press  or ENTER to advance to the next slide.
- For automatic advance, select the time interval for display of each slide. The interval you select here is the minimum time between slides; actual time may be longer for larger files.
- For automatic advance, select the number of times (frequency) to play the complete slide show: **Once**, **Twice**, or **Continuous**.
- Press EXIT to close the **Media Setup** menu and return to the **USB Photo** menu.

IMPORTANT

The TV can read JPEG files as created by the camera. If you edit a picture file on a computer and resave the image, the TV may be unable to read the resaved file.

USB Photo Menu Compatible Picture Files

- Still images recorded on digital cameras using the Exchangeable Image File Format, version 2.1 (EXIF 2.1) standard for digital still cameras and Design Rules for Camera File Systems version 1.0 (DCF 1.0)
- Some images opened and resaved on a computer may not play back or may not display in the thumbnail list. This happens if the files were resaved in an incompatible format.
- Full path file names can be no longer than 50 characters and must end in a .jpg extension. Only the first 20 of the 50 characters will display.
- Images on storage devices with a capacity of over 256 MB can take a longer initial time to display.

Photos and Moving Video as Composite Video

Connect the camera to the TV using a composite video cable if:

- You are unable to see images using the USB photo port.
- You wish to view moving video from the camera.

The TV's **USB Photo** menu will be unavailable and you must control the slide show through the camera. Display resolution is standard-definition (480i).

1. Refer to the owner's manual supplied with the camera for instructions needed for this setup.
2. Set the camera's output signal type to **NTSC** and put the camera into playback mode.
3. With the camera still turned on, connect your digital camera's composite video cable (usually yellow) to the **VIDEO/Y** jack on the front of the TV. To hear audio, connect the camera's audio output cable to the **AUDIO L** jack.
4. When the **Auto Input Sensing** screen displays, press EXIT or assign the name **Camcorder**.
5. Press INPUT to display the **Input Selection** menu.
6. Highlight the icon for the camera input and press ENTER.
7. If viewing photos, advance through the images manually or set the camera to advance automatically.

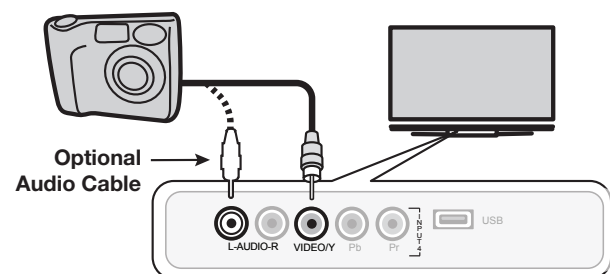

Camera connection using a composite video cable

3D Video

This section provides Instructions for viewing 3D video using the TV's **3D** feature. The **3D** options are found in the **Setup > 3D** menu described on page 47 .

Initial Set-Up

1. Check if your HDMI 3D video source device outputs a 1080p 60 Hz signal. This information will be needed when you assign an input name in the **Auto Input Sensing** screen.
2. If your 3D glasses came with an emitter box, connect the emitter box to the **3D GLASSES EMITTER** jack on the back of the TV. See page 9 for the location of the jack.

3. Power on the TV and the source device.
4. Connect the source device to the TV's HDMI input.
5. When the **Auto Input Sensing** screen displays, name the input according to the table below.

The signal type and choice of name are important because the TV will process the video signal differently depending on the name you assign. If your source device is a high-definition disc system, such as Blu-Ray or HD DVD, or is a game console, the signal must be 1080p at 60 Hz.

6. Press EXIT to close the **Auto Input Sensing** screen.

Source of 3D Video	Type of 3D Video Signal	Name to Assign to Video Input
Computer	Recommended: 1080p 60 Hz (1920 X 1080). The image will fill the TV screen. Other 60-Hz computer video signals compatible with the TV will display with black bars. See "Computer Display Formats" on page 18.	PC
Any other 3D video source	To see 3D video, signal must be 1080p 60 Hz	Any name other than PC

To Watch 3D Video

1. Press INPUT to display the **Input Selection** menu.
2. Highlight the icon for the 3D video input and press ENTER.
3. Press MENU and select the **Setup > 3D Mode** menu.
4. Set **3D Mode** to **On**. The **On** setting will be memorized for the current input when you exit this menu.
5. Press EXIT to close the menu.

To Watch Regular (non-3D) Video

The **3D Mode** setting is memorized for each input. When you want to watch non-3D video on the input selected above:

1. Select the input in the **Input Selection** menu.
2. Open the **Setup > 3D** menu and set **3D Mode** to **Off**.

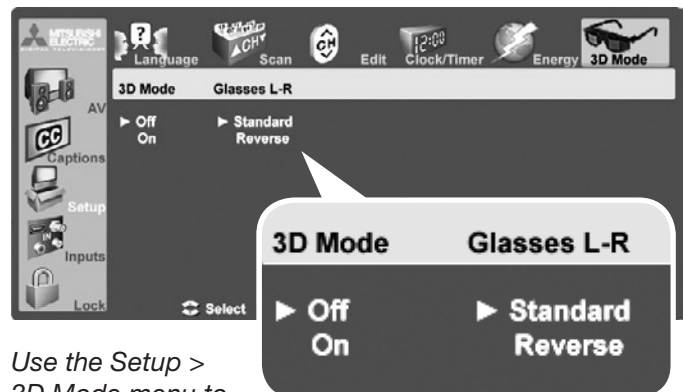





Use the Setup > 3D Mode menu to enable 3D video viewing.

5

TV Menus

Main Menu

Press **MENU** on the remote control to open the **Main** menu.

Icon	Menu Name and Description	Page
	AV Menu Customize picture and sound settings.	37
	Captions Menu Turn closed captions on and off; customize caption displays.	42
	Setup Menu Perform basic TV setup. Set language, scan (memorize) channels, set the TV clock, edit channel options, lock TV use by channel, set Energy Mode, Lamp Mode, auto-on TV Timer.	43
	Inputs Menu Assign names to TV inputs, change icon order in the Input Selection menu, perform NetCommand IR "learning."	48
	Lock Menu Restrict TV use by program ratings and by time of day. Disable the control-panel buttons. Set a pass code.	49

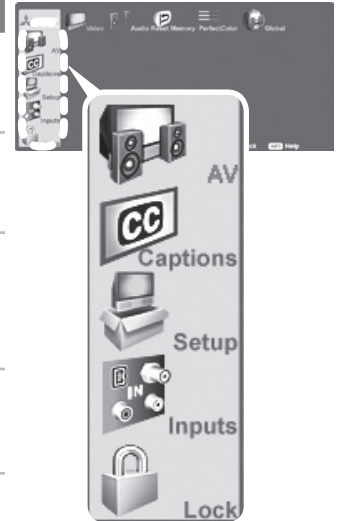

Main menu

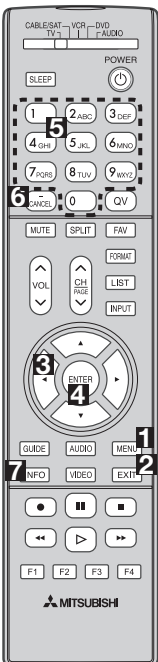
Remote Control Keys for the TV Menu System

Key	Function
1 MENU	Display or close the Main menu or move back one menu level.
2 EXIT	Close all menus and return to TV viewing.
3 (Adjust Left/Right Keys) (Adjust Up/Down Keys)	<ul style="list-style-type: none"> • Move through screens to select menu options. • Change settings. • Scroll through lists.
4 ENTER	Start an automatic function or check/uncheck a check box. When setting time, move from hour digits to minutes digits and from month to day to year digits.
5 Numbers Letters	Enter channel numbers. Enter custom names in some text boxes.
6 CANCEL	<ul style="list-style-type: none"> • Clear a setting or stop an automatic function. • Add a separator in a digital channel number.
7 INFO	Get context-sensitive help.





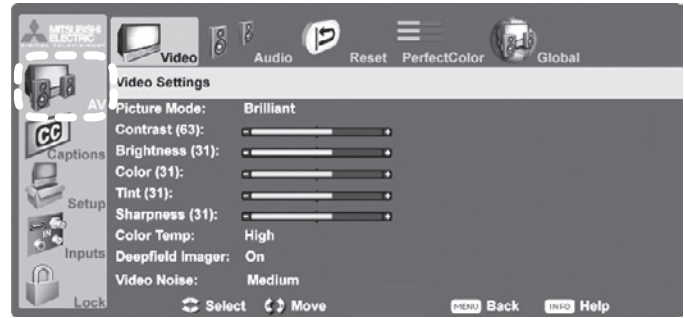

AV Menu

An on-screen slider displays when making some audio and video adjustments. Numeric values represented on the slider range from 0 (minimum) to 63 (maximum), with 31 as the mid-point.



The AV menu contains sub-menus for audio and video adjustments

AV Menu Options

 Video	See the description of video adjustments on page 39.	
 Audio	See the description of audio adjustments on page 41.	
 Reset	<ul style="list-style-type: none"> To reset audio and video adjustments for the current input, highlight the Reset icon and press ENTER. Reset has no effect on settings for Balance, Listen To, Language, and Film Mode. 	
 PerfectColor	PerfectColor Sliders	Adjust the saturation (intensity) of six colors for the current image source.
	PerfectTint Sliders (835 series TVs)	Adjust six hues for the current image source
	<p>To use PerfectColor and PerfectTint: Highlight the PerfectColor™ icon and press ENTER to display the PerfectColor menu. Settings are retained in memory independently for each TV input.</p> <ul style="list-style-type: none"> To switch between PerfectColor™ and PerfectTint™ adjustments, highlight Adjust Mode and press ◀ ▶. Press ▲ ▼ to move from one color bar to the next. Press ◀ ▶ to change settings. Press CANCEL to restore default settings. Press MENU to return to the Main menu. 	



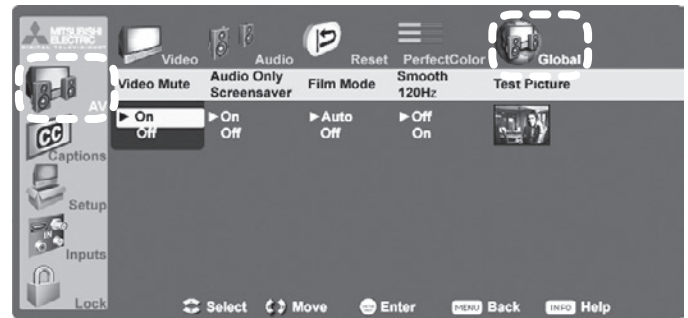

AV Menu, continued



AV > Global menu

AV Menu Options

 Global	Video Mute	On, Off	<ul style="list-style-type: none"> On: Displays a solid blue background when there is no video signal from the current input. Use the On setting to let the colored screen remind you that the TV is powered on at times when there is no picture. The TV will power off after five minutes if it detects no video signal. Off. The screen appears black if there is no video signal from the current non-antenna input.
	Audio Only Screensaver	On, Off	<ul style="list-style-type: none"> On: Select On to display a random screensaver pattern while playing an audio-only device. The device must be named CD/Audio or MP3 Player to use this feature. Off: No screensaver pattern displays during play of an audio-only device. <p>Note: When playing an audio-only device, the TV will power off after 12 hours of inactivity.</p>
	Film Mode (480i and 1080i signals only)	Auto, Off	In Auto , the TV automatically detects and applies film-decoding correction to movies filmed at 24 frames per second. Try the Off setting if images show many jagged edges.
	Smooth 120 Hz (835 series TVs)	Off, On	When On , Smooth 120Hz™ reduces motion blur in action scenes but may show pixel structure during slower motion or in still images. When Off , standard picture smoothing processing is employed.
	Blue Glow (835 series TVs)	On if TV off, On if TV on, Off	Select one of the On settings to see decorative blue lighting on the TV.
	 Test Picture		Displays a test picture. For use during troubleshooting under the direction of TV servicing personnel.

Video Menu

Mitsubishi recommends you assign names to TV inputs before making video adjustments (use the **Inputs > Name** menu). Otherwise, adjustments will be reset to the defaults if you name inputs afterwards.

To make video adjustments:

- **From the Video menu:**
 1. Press ▲ ▼ to highlight an option.
 2. Press ◀ ▶ to display the submenu and adjust.
 3. Press MENU to return to the **AV** menu.
- **While watching TV:** Press the VIDEO key repeatedly to display the video option you want to change. Press ◀ ▶ to change settings.

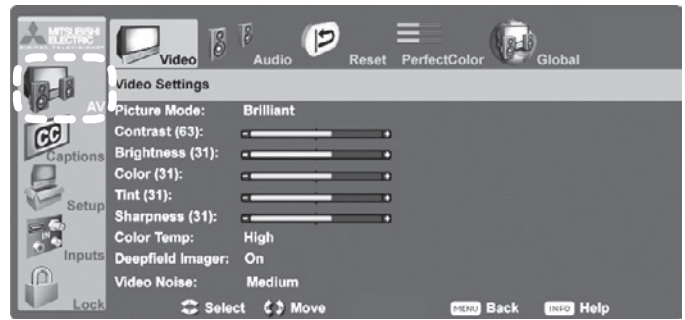

AV menu, Video options

Note: See “Computer Video Adjustments” on page 18 for additional adjustments for computer images.

Video Menu Options

Picture Mode	Brilliant	For use under bright light; unavailable when the current input is named Game or PC .	Set the Picture Mode first before changing other video settings, as some settings are stored independently for each Picture Mode. Use Picture Modes to get the best image under different viewing conditions.
	Game	Optimizes picture and video processing for gaming consoles. Available only when the name of the input is Game or PC .	
	Bright	For most daytime viewing and x.v.Color sources	
	Natural	For most nighttime viewing and x.v.Color sources	
Contrast	<ul style="list-style-type: none"> • Adjusts the white-to-black level • Settings are stored independently for each Picture Mode. • Low contrast shows a variety of shades in darker images • In most home lighting situations, medium contrast looks best. • High contrast shows darker images more uniformly black and makes colors appear more vibrant. High contrast is good for brightly lit environments. 		
Brightness	<ul style="list-style-type: none"> • Adjusts overall picture brightness • Settings are stored independently for each Picture Mode. 		
Color	Adjusts overall color intensity from no color to fully saturated.		
Tint	Adjusts the red-to-green ratio.		
Sharpness	Adjusts picture detail and clarity.		
Color Temp	Adjusts the white balance. Settings are stored independently for each Picture Mode.		
	High	Gives white images a cool cast. May provide the most realistic picture under bright lighting.	
	Low	Gives white images a warm cast. Natural/Color Temp at the low setting displays video at approximately the 6500K industry standard for NTSC pictures.	
Video Noise	High, Medium, Low, Off	Reduces minor noise (graininess) in the picture. Use Low with good-quality signals. Use High with poor-quality signals. Use Off to leave the picture unaltered. Saved by input.	



Video Menu, continued

SharpEdge (835 Series TVs)	On, Off	SharpEdge™ adds special edge enhancements to make the image appear sharper. Saved by input.
Deep Field Imager (736 or 835 Series TVs)	On	DeepField™ Imager dynamically enhances black levels in portions of the screen to provide strong contrast with detail over mixed screen content.
	Off	Contrast is adjusted uniformly across the entire screen.
	Demo	For comparison, displays a split picture to show On (right side) and Off (left side).
Vert Adjustment (Stretch Plus mode only)	<ul style="list-style-type: none"> • Press the ENTER key to enter adjustment mode (in Stretch Plus only). • Press ▲ ▼ to move the picture up or down. 	
Horiz position (Computer image only)		Press ◀ ▶ to display the adjustment slider. Press ◀ or ▶ to shift the image horizontally.
Vert position (Computer image only)		Press ◀ ▶ to display the adjustment slider. Press ◀ or ▶ to shift the image vertically.

Audio Menu

To make audio adjustments:

- **From the Audio menu:**
 1. Press ▲▼ to highlight an option
 2. Press ◀▶ to display the submenu and adjust.
 3. Press MENU to return to the **AV** menu.
- **While watching TV:** Press the **AUDIO** key repeatedly to display the audio option you want to change. Press ◀▶ to change settings.



AV menu, Audio options

Audio Menu Options

Speakers	The Speakers option displays only if an A/V receiver connection has been detected.	
	TV	Turns on the internal TV speakers.
	AV Receiver	Turns off the TV speakers so you hear sound only from a connected A/V receiver. Note: When you disconnect an analog A/V receiver, be sure to manually change the Speakers setting to TV to hear sound from the TV speakers.
Bass	Controls volume of low-pitched sound from the TV speakers.	
Treble	Controls volume of high-pitched sound from the TV speakers.	
Balance	Controls audio balance between the right and left TV speakers	
Sound Mode	Normal	No special audio effects from the TV speakers (default)
	Expand	Modifies audio from the TV speakers. <ul style="list-style-type: none"> • For monaural (non-stereo) programs, creates a simulated stereo effect. • For stereo programs, creates a simulated surround sound effect.
Listen To Available for analog channels from ANT1/ANT2 only	Stereo	Default setting. The TV plays stereo broadcasts in stereo and mono broadcasts in mono. The word Stereo is displayed when you tune to a channel broadcasting in stereo.
	Mono	Reduces background noise. Use when receiving a weak stereo audio signal. All audio is played as mono with this setting.
	SAP (Second Audio Program)	Selects an additional monaural sound track not audible during normal TV viewing. The SAP signal might be related to the program (such as a sound track in a foreign language), or it might be unrelated (such as a weather report). If an SAP signal is broadcast, the letters SAP are displayed when you tune to the channel
Language	English French German Italian Portuguese Spanish Other	Selects the current language for a digital program from ANT1 or ANT2 . Each digital program may include zero to seven language choices. Available for digital channels from ANT1/ANT2 only
	Level Sound	On, Off



Captions Menu

Captions on Analog Channels

The TV can decode captions from **ANT 1/ANT 2** and the **VIDEO** composite and **S-VIDEO** jacks. Broadcasters can send either standard closed captions or text service. Standard closed captions follow the dialogue of the program and display in a small section of the screen. Text-service closed captions often contain information such as weather or news and cover a large portion of the screen.

IMPORTANT

- Analog text-service options display a large black or gray box on the screen when no signal is being broadcast.
- The content of captions is determined by the broadcaster. If captions show strange characters, misspellings, or odd grammar, it is not a malfunction of the TV.
- Closed caption signals are not available through HDMI or component jacks. See the menus for these devices for closed-caption decoding.

Captions on Digital Channels

The TV can decode captions from **ANT 1/ANT 2** only. Broadcasters can send up to six different captioning selections or can send analog captions that match those sent by the analog station. A TV station may broadcast only one or two types of captions or none at all.

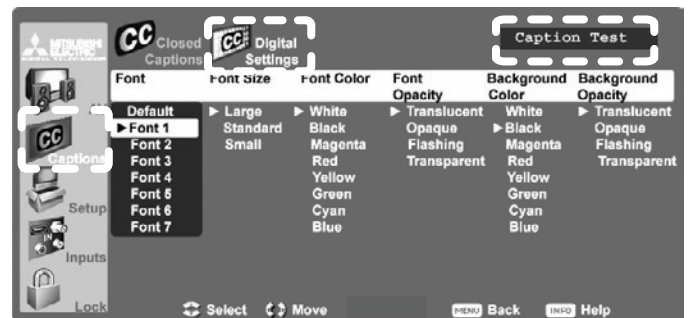

Digital Settings menu. Check the caption test area (upper right) to see how custom settings look.

Captions Menu Options

 Closed Captions	Analog Captions	On if Mute CC 1–CC 4 Text 1–Text 4 Off	<ul style="list-style-type: none"> • On if Mute: Displays analog closed captions signal CC 1 when audio from the TV speakers is muted. When watching TV, press MUTE to turn captions on/off. • CC 1–CC 4: Standard closed-caption signals • Text 1–Text 4: Text-service signals
	Analog Background	Gray, Black	Selects either a gray or black text background to make analog closed captions easier to read.
	Digital Captions	On if Mute Caption 1–Caption 6 Off	<ul style="list-style-type: none"> • On if Mute: Displays digital closed caption signal Caption 1 when audio from the TV speakers is muted. When watching TV, press MUTE to turn closed captions on/off. • Caption 1–Caption 6: Caption signals sent by the broadcaster
 Digital Settings	Font	Default Font 1–Font 7	Default changes settings to those selected by the captions provider, or, if none, to the TV's own captions defaults. Use Fonts 1 through 7 to give captions a custom appearance.
	Font Size	Large Standard Small	Large is the recommended size.
	Font Color	White, Black, Magenta, etc.	Guidelines for setting digital captions: <ul style="list-style-type: none"> • A white font on a black translucent background makes an easy-to-read combination. • Use contrasting colors for captions and background. • Check readability of captions using the sample text in the upper right corner of the menu.
	Font Opacity	Translucent, Opaque, Flashing, Transparent	
	Background Color	White, Black, Magenta, etc.	
Background Opacity	Translucent, Opaque, Flashing, Transparent		



Setup Menu

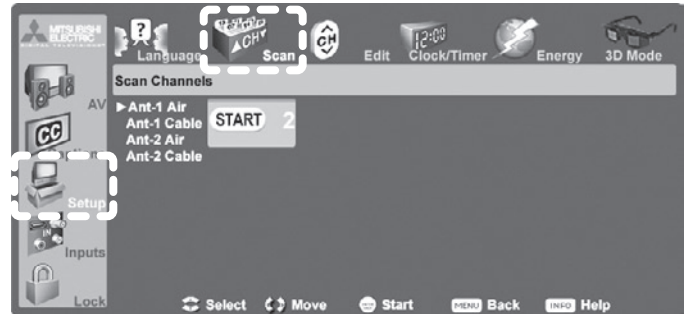

Use the **Setup** menu to:

- Select English or Spanish for menus and on-screen text.
- Scan the channels available for the antenna or cable service connected to the **ANT 1** or **ANT 2** jacks.
- Edit channel options, including channel locking.
- Set the TV's internal clock.
- Set the TV Timer to turn on the TV automatically at a designated time.
- Set the energy mode for power consumption when the TV is powered off.
- Set the TV Lamp Mode.
- Turn 3D mode on and off.



Setup menu, Scan option

Setup Menu Options

 Language	English Spanish	Display on-screen menus in either English or Spanish. Note: To listen to audio in other languages (when available), see the section on the AV menu, Audio submenu, and refer to either Listen To > SAP (analog signal) or Language (digital signal).
 Scan	Ant-1 Air Ant-1 Cable Ant-2 Air Ant-2 Cable	Scan memorizes broadcast channels to make them easier to find. To start channel memorization: <ol style="list-style-type: none"> 1. Highlight one of the input selections based on your connection to ANT 1 or ANT 2: <ul style="list-style-type: none"> • Air when connected to an indoor or outdoor antenna. • Cable when connected to direct cable (no cable box) 2. Press ▶ to highlight START. 3. Press ENTER to start channel memorization for the selected input.

Notes on Scan and channel memorization:

- Channel memorization may take up to 15 minutes to complete.
- To stop channel memorization before completion, press **CANCEL**.
- When watching TV, press **CH ▲ ▼** to move through memorized channels.
- To add a digital channel that does not appear in the **Edit** menu without repeating channel memorization:
 1. Look up the physical channel number for the new digital channel. The website www.antennaweb.org can help you find the physical channel number.
 2. Tune to any channel on the **ANT 1** or **ANT 2** input your antenna is connected to.
 3. Use the number keys and **CANCEL** key to enter the physical channel number followed by “-1” and **ENTER**. For example, for physical channel 36, press **3 6 CANCEL 1 ENTER**.

The TV will search for a digital channel on the channel 36 frequency. When it finds the channel, it will:

 - a. Add the channel to memory.
 - b. Change the channel number to the virtual channel number sent by the broadcaster.
 - c. Add to memory any associated sub-channels.
- Rememorize channels if you move the TV to a different geographic area with a different channel line-up.



Setup Menu, continued

Edit

Virtual Channel Number (digital channels only). A channel number sent by a local broadcaster. Usually the virtual number is associated with the corresponding analog channel number. For example, a broadcaster may associate digital channel 2-1 with their analog channel 2.

Physical Digital Channel Number. The channel number officially assigned to the actual broadcast frequency; shown on screen in parentheses.



Setup menu, Edit channel options

Setup Menu Options



Edit

Use the **Edit** menu to edit channel options when **ANT 1** or **ANT 2** is the current source. To highlight a channel number to edit:

- Press **CH** \wedge/\vee to jump to the next page of channel numbers. Press and hold **CH** \wedge/\vee to speed through pages.
- Press $\blacktriangle/\blacktriangledown$ to move through all channel numbers, one at a time. Press and hold $\blacktriangle/\blacktriangledown$ to speed through channel numbers.

The TV tunes to the highlighted channel on release of **CH** \wedge/\vee or $\blacktriangle/\blacktriangledown$.

Channel	Channels marked with a check are in memory. To add or delete a channel from memory, highlight the channel number and press ENTER . To add a single digital channel not in the list, see the notes under Scan on the previous page. Digital channels are listed by virtual channel number with the physical channel number shown in parentheses.
Name	Assign a custom name up to six characters long to memorized channels. You can name analog channels and digital channels if broadcast without pre-assigned names. 1. With the cursor in the Name field, press a number key repeatedly to cycle through the characters associated with the key, including !, &, blank (1 key) and /, *, - (0 key). 2. Press ENTER to set the letter and move to the next letter position. To delete the current character and move back one position, press CANCEL .
Fav1-Fav6	Use the six Fav channel banks to store groups of your favorite channels. For example, you can set up a Fav channel bank for each of your favorite program types (e.g., sports, news, children's programs) or set up a bank for each TV user. <ul style="list-style-type: none"> • Use $\blacktriangle/\blacktriangledown/\blacktriangleleft/\blacktriangleright$ to move the highlight through the Fav area of the screen. • Press ENTER to insert a check mark to add the highlighted channel to one of the Fav banks. • The same channel can be added to multiple Fav banks • To remove a channel from a Fav bank, highlight the check mark and press ENTER. <p>Note: To set up Fav channel banks without using this menu, see "Fav (Favorite Channels)" on page 31.</p>
Lock	Lock channels so that a pass code is required to view them. When you rememorize channels, all lock settings are cleared. Highlight the Lock column and enter a pass code when prompted. If you previously set a pass code to open the main Lock menu, use the same pass code. See "Lock Menu," page 49 for more on pass codes. To lock or unlock a channel, highlight the lock icon for the channel and press ENTER to switch between the locked and unlocked versions of the icon.



Setup Menu, continued

Clock

Use either the manual or auto method to set the clock.
Set the clock if you wish to:

- Use the TV's Timer function.
- Maintain accurate ChannelView listings.

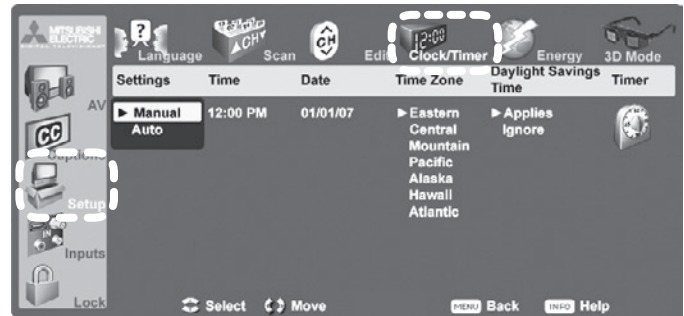

Setup menu, Clock options

Setup Menu Options



Clock

Settings

Manual. To set the clock manually:

1. Select **Manual**.
2. Set the time of day.
3. Set the date.
4. Select your time zone.
5. Select either **Applies** or **Ignore** for **Daylight Savings Time**.

Note: If using **Manual**, each time the time change occurs, you must open this menu and set the TV's clock ahead or back.

Auto. To set the clock automatically:

1. Select **Auto**.
2. Select your time zone.
3. Select either **Applies** or **Ignore** for Daylight Savings Time.
4. After exiting the menus, tune the TV to an analog station on **ANT 1** or **ANT 2** carrying XDS data, typically a PBS station.

Note:

- With the **Auto** setting, the TV's clock adjusts automatically to daylight savings time.
- The TV's clock will be reset if you tune to a channel sending incorrect time data. To prevent unwanted clock resets, first use the **Auto** method to set the clock from a channel sending the correct time, then change the method to **Manual**.

Time (Manual option only)

1. With the hour highlighted, press ▲ ▼ repeatedly to change the hour and the **AM/PM** indicator. Press and hold to change the hour display quickly.
2. Press **ENTER** to set the hour.
3. With the minutes highlighted, press ▲ ▼ to change the minutes. Press and hold to change the minutes display quickly.

Date (Manual option only)

1. With the month highlighted, press ▲ ▼ to select. Press **ENTER** to set.
2. With the day highlighted, press ▲ ▼ to select. Press **ENTER** to set.
3. With the year highlighted, press ▲ ▼ to select the current year.

Time Zone

Eastern, Central, Mountain, Pacific, etc.

Required for both the **Manual** and **Auto** methods.

Daylight Savings Time

**Applies
Ignore**

Required for both the **Manual** and **Auto** methods. Select the option for your area.



Setup Menu, continued

Timer

Use the Timer to set a time for the TV to turn on automatically. Use this menu to set a day, time, input, and channel for the Timer. If the TV is already on at the requested time, the TV will automatically tune to the designated channel.

- The TV clock must be set before you can use the Timer feature.
- To open the **Timer** menu, highlight the Timer icon  in the **Setup** menu and press **ENTER**.
- The **TIMER** indicator on the front of the TV flashes slowly when the TV is off to indicate the TV Timer has been set to turn on the TV automatically.
- When the Timer turns on the TV, press any key on the remote control to keep it on. Otherwise, the TV will turn off after five minutes.

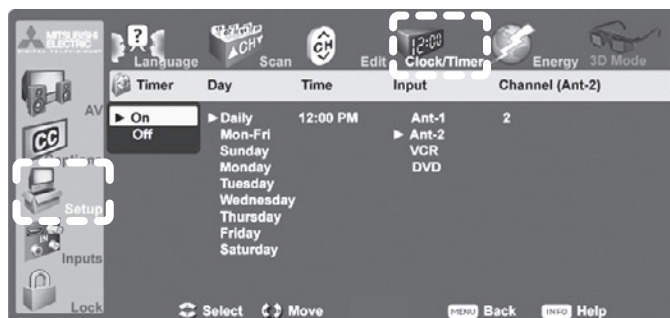

Setup menu, Timer options

Setup Menu Options

 Timer	Timer	On, Off
	Day	Daily, Mon-Fri, (every) Sunday, (every) Monday, (every) Tuesday, etc. Select the day or days of the week for the Timer to turn on the TV.
	Time	To set the time for the TV to come on: <ol style="list-style-type: none"> 1. With the hour highlighted, press ▲ ▼ repeatedly to change the hour and the AM/PM indicator. Press and hold to change the hour display quickly. 2. Press ENTER to highlight the minutes. 3. Press ▲ ▼ to change the minutes. Press and hold to change the minutes display quickly.
	Input	Ant-1, Ant-2, DVD, VCR, etc. Select the input you want displayed when the TV comes on. Choose from the defined and enabled inputs that appear in the Input Selection menu.
	Channel	If the input is an antenna (ANT 1, ANT 2), enter a channel number in any of three ways: <ul style="list-style-type: none"> • Enter the number using the remote control's number keys. • Press ▲ ▼ repeatedly • Press and hold ▲ ▼ to scroll quickly through the available channel numbers.



Setup Menu, continued



Setup menu, Energy options

Setup Menu Options



Energy Mode

Fast Power On

Use the Energy Mode option to select the level of power consumption while the TV is turned off.

The default setting is **Fast Power On**.

Low Power

Low Power uses less energy, but TV power-on takes longer and some TV features may be unavailable.

Keep Energy Mode set to **Fast Power On** if you need to:

- Have faster power on.
- Receive updates to ChannelView channel listings.
- Keep the TV Clock accurate for the TV Timer. With the **Low Power** setting, you must reset the TV Clock if the TV is left turned off for over 48 hours.

Lamp Mode

Standard

Standard is for most viewing conditions and may extend lamp life by using lower wattage. Use **Bright** in brightly lit rooms. You may notice increased fan noise when using the **Bright** setting.

Bright



3D Mode

On, Off

Use the **On** setting for video games and movies that require 3-D glasses.

Glasses L-R

Standard, Reverse

Synchronizes the 3D glasses with the image on screen to provide the best 3D effect. **Standard** is the default; try **Reverse** if this seems incorrect.

Note: 3D options are available only for 1080p 60 Hz video sources connected to an HDMI input.



Inputs Menu

Inputs Menu Options

	Name	<p>Cable Box, Camcorder, CD/Audio, DVD (DVD, DVD2, Blu-Ray), DVR, Game (Game, PS, Xbox, Wii), MP3 Player, PC, Satellite, VCR, AVR</p> <p>On/Off (ANT 1 and ANT 2 only)</p> <p>Delete (deactivated HDMI only)</p> <p>Control On, Control Off (CEC-enabled HDMI devices; operates only when Inputs > NetCommand HDMI Control is set to On)</p>	<ul style="list-style-type: none"> Lets you assign or change names of inputs appearing in the Input Selection menu. <ul style="list-style-type: none"> Press ◀ ▶ to move between inputs. Press ▲ ▼ to select a name. Lets you turn Ant-1 and Ant-2 On/Off (to display/hide in Input Selection menu). Lets you delete unused HDMI inputs from the Input Selection menu. If you change the name of an input after performing NetCommand “learning,” the IR codes you “learned” are erased.
--	-------------	---	--

General Notes

When you change an input name in the **Name** menu and then exit the **Name** menu:

- The name is changed
- The icon in the **Input Selection** menu is changed
- Audio and video settings are changed to the defaults for the new device type.
- 736 or 835 Series TV:** All previous NetCommand IR “learning” for the input is erased.

Notes for HDMI devices

- Disconnecting an HDMI device:** When you disconnect an HDMI device, the icon remains in the **Input Selection** menu until you remove it. Select **Delete** in the **Inputs > Name** menu to remove an unwanted icon for an HDMI input.
- NetCommand for HDMI and CEC-Enabled Devices:** If CEC conflicts occur, turn off CEC signals in one of these ways: a) Turn off all NetCommand for HDMI signals from the TV (**Inputs > NetCommand HDMI Control** menu), b) Turn off NetCommand HDMI signals for specific devices (**Inputs > Name** menu), or c) Turn off each device’s internal CEC capability. See Appendix E for the TV’s NetCommand for HDMI Control or, to turn on/off a specific device’s response to CEC signals, see the device’s owner’s manual.
- Names of CEC-enabled devices:** CEC-enabled devices send their own predefined name to the TV. You cannot change the name of a CEC-enabled device; applies only when **Inputs > NetCommand HDMI Control** is set to **On**.

	Order	<p>Lets you put frequently used icons at the start of the Input Selection menu.</p> <ol style="list-style-type: none"> Press ▲ ▼ ◀ ▶ to highlight the icon to move. Press ENTER to confirm the selection. Press ▲ ▼ ◀ ▶ to drag the icon to the desired position. Press ENTER to set the new position.
	Learn	<p>736 or 835 Series TV</p> <p>Sets up or changes NetCommand IR control of the current viewing device.</p> <p>See detailed instructions in chapter 6, “NetCommand IR Control.”</p>
	AV Receiver	<p>736 or 835 Series TV</p> <p>Sets up or changes NetCommand IR control of an A/V receiver.</p> <p>See detailed instructions in chapter 6, “NetCommand IR Control,” starting on page 58.</p>
	On, Off	<p>Select On or Off to enable or disable the TV’s control of CEC-enabled devices. See Appendix E for details.</p>
NetCommand HDMI Control		



Lock Menu

TV locks available from the **Lock** menu are:

	Parent	Lock by Ratings Restricts access to programming based on V-Chip rating signals sent by the broadcaster.
	Other	
	Time	Lock by Time Restricts TV use by time of day.
	Control Panel	Lock Control Panel Disables the buttons on the TV's control panel. Use this option if small children in the home try to press control-panel buttons.

Note: **Channel Lock** is an additional lock that blocks access to specific channels. Channel Lock is available under the **Setup** menu (**Setup** > **Edit** > **Lock**, page 44).

Pass Codes

Setting a Pass Code

You are prompted to enter a pass code whenever you select **Lock** on the **Main** menu. To set a pass code for the first time:

- Press **MENU**, highlight **Lock**, then press **▶**. A screen prompting you for a pass code will display.
- Input a four-digit pass code using the number keys on the remote control.
 - Press **CANCEL** to delete a number and move back one space.
 - Press **MENU** or **EXIT** to close the menu without setting a pass code.
- Press **ENTER** to set the pass code.

Resetting a Pass Code

See the procedure in Appendix C.

Important Notes on Rating Locks

- Parent** menu rating locks apply only to channels and signals received on **ANT 1**, **ANT 2**, and the **VIDEO** composite and **S-VIDEO** jacks.
- Other** menu rating locks apply only to digital channels received on **ANT 1** or **ANT 2**.
- When viewing a cable box, satellite receiver, or other device connected to the component **Y Pb Pr** or **HDMI** inputs, check the device's owner's guide for use of parental locks.

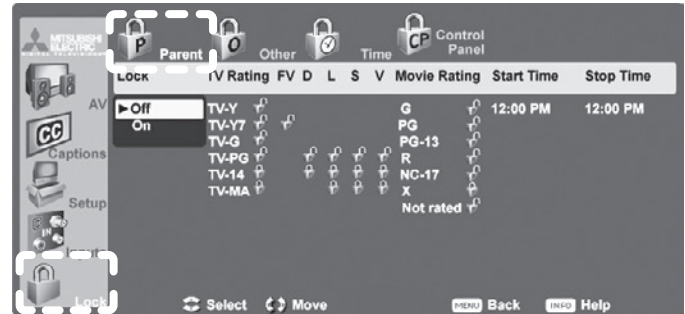

The **Lock** > **Parent** menu lets you set parental controls using V-Chip technology.

Parent Menu

The TV comes from the factory with the rating locks turned off and with pre-set U.S. ratings TV-PG and movie rating PG. Turn on blocking for U.S. ratings to activate these rating restrictions. Use the **Lock** > **Parent** menu to change the level of blocking with U.S. ratings.

Any time you change the channel or device, it may take up to five seconds for the rating restrictions to take effect.

Other Menu (Alternate Rating System)

This TV can recognize new rating systems that may come into effect in the future. The **Other** menu allows you to block digital programming when such systems come into effect.

The first time you tune to a channel broadcasting an alternate rating system, the TV defaults to the most restrictive setting if the **Lock** menu > **Other Lock** option is set to **On**. Use this menu to change the allowed rating if you are unable to watch a program broadcast with an alternate system.

Bypassing TV Locks

- If you try to watch a blocked program or channel, or the TV is locked by time, a notice will appear prompting you for a pass code. To use the TV, input your four-digit pass code and press **ENTER**.
 - To reactivate the locks after using a pass code, power the TV off and then on.
 - To reactivate only the parent ratings lock, change to a different channel or device.
- If a program or channel is blocked, you can still use the TV without entering a pass code. The lock allows you to change to a channel airing an allowed program or change to another device.

**Lock Menu, continued****Parent Menu Options (U.S.-based rating system)**

Option Name and Description		
Lock	Off, On	Disables or enables program blocking based on V-Chip signals and the U.S. rating system.
TV Rating	TV-Y	Youth. For children under 7.
	TV-Y7	Youth 7 and older.
	TV-G	General Audience. For the entire family.
	TV-PG	Parental Guidance. Parental Guidance recommended; may not be suitable for some children.
	TV-14	Adolescent 14 and older. Not recommended for children under 14.
	TV-MA	Mature Audience. For adults only.
FV	Fantasy Violence. Applies to TV-Y7 only.	
D	Sexual Dialog. Applies in differing degrees to TV-PG and TV-14.	
L	Adult Language. Applies in differing degrees to TV-PG, TV-14, and TV-MA.	
S	Sexual Situations. Applies in differing degrees to TV-PG, TV-14, and TV-MA.	
V	Violence (graphic or realistic). Applies in differing degrees to TV-PG, TV-14, and TV-MA.	
Movie Rating	G	General Audience. Designed for the entire family to view.
	PG	Parental Guidance. Parental Guidance is recommended, may not be suitable for some children.
	PG-13	Parental Guidance, 13 and Older. Not recommended for children under the age of 13.
	R	Restricted. Restricted in theaters to 17 years old and older unless accompanied by an adult.
	NC-17	No Children 17 or Under. Restricted in theaters to 18 years old and older.
	X	Adult. Designed for and restricted in theaters to adult audiences only.
	Not Rated	The program has not been assigned an MPAA rating.
Start Time	Allows you to set the time of day for enforcement of rating restrictions set in the Parent menu.	
Stop Time	1. Highlight the hour digits for Start Time .	
	2. Press ▲▼ repeatedly to change the hour and associated AM/PM indicator. You can also just press and hold to move quickly through the numbers.	
	3. Press ENTER to highlight the minutes.	
	4. With the minutes digits highlighted, press ▲▼ repeatedly to change the minutes. You can also just press and hold to move quickly through the numbers.	
	5. Highlight the Stop Time digits and set the time as described above.	
Note: To make rating restrictions active 24 hours a day, make Start Time and Stop Time the same.		

TV Content Categories



Lock Menu, continued



Other Menu Options (alternate rating system)

This TV can recognize new rating systems that may come into effect in the future. The **Other** option remains grayed out until the TV receives a signal using an alternate rating system. Such alternate rating systems will apply only to digital programming received on the **ANT 1** and **ANT 2** inputs.

Option Name and Description	
Lock	On, Off Enable or disable program blocking.
System Name	The rating system available for the channel
Group	Rating groups available in the rating system shown on the screen. Rating groups are defined by the rating system in effect.
Rating	Rating restrictions available in the selected rating system and group. Highlight the rating and press ENTER to check (block) or uncheck (allow) rated content.



Time

Blocks all use of the TV during the time period you specify. You must enter a pass code to use the TV when the time lock is in effect.

Lock by Time	On, Off Enable or disable Lock by Time.
Lock Time, Unlock Time	<p>To set the lock and unlock times:</p> <ol style="list-style-type: none"> 1. Highlight the hour digits for the Lock Time. 2. Press ▲▼ repeatedly to change the hour and associated AM/PM indicator. To move quickly through the numbers, just press and hold. 3. Press ENTER to set the hour and highlight the minutes. 4. With the minutes highlighted, press ▲▼ repeatedly to change the minutes. To move quickly through the numbers, just press and hold. 5. Highlight the Unlock Time digits and set the time as described above. <p>Note: To make Lock by Time active 24 hours a day, make Start Time and Stop Time the same.</p>



Control Panel

On, Off	<p>On locks and Off unlocks the buttons on the TV's control panel. Use this option if small children may try to press TV buttons.</p> <ul style="list-style-type: none"> • If the remote control is unavailable, use the TV's control panel to release the Control Panel Lock. Press and hold the MENU button for over eight seconds. • If the TV is powered off, release the lock as described above. The TV will power on. • To reactivate the lock, you must return to this menu and change the setting to On.
----------------	--

6

NetCommand IR Control

About NetCommand IR Control

Note: To learn about NetCommand for HDMI devices, available on all TV models, see Appendix E, “NetCommand HDMI Control of CEC Devices,” page 77.

- **NetCommand IR home-theater control is available on the following models:**
 - **WD-65736, WD-73736**
 - **WD-65835, WD-73835**
- NetCommand setup is optional.
- You may wish to use NetCommand IR control to supplement CEC control.
- You can perform NetCommand setup when the TV first recognizes a device during Auto Input Sensing or at any convenient time afterward.
- NetCommand operates by sending remote control signals from the TV to your other devices via the IR emitters, telling the devices to play, record, change

inputs, adjust volume, change channels, or perform other functions. All this is accomplished with the TV’s remote control and the slide switch left in the TV position.

- The IR “Learning” feature of NetCommand allows the TV to learn the IR control signals for your A/V devices.
- You can choose the level of NetCommand control for your home theater.
 - **Standard Setup.** Perform a standard setup if you want NetCommand to control only a few devices, such as the TV, a playback device (like a DVD player), and a cable box. With this setup, you can use the TV’s remote control to operate these devices.
 - **A/V Receiver Setup.** Perform A/V receiver setup if you want NetCommand to:
 - ◆ Control a surround sound A/V receiver.
 - ◆ Automatically change audio input selections on an A/V receiver when you change inputs on the TV.
 - ◆ Automatically change audio and video input selections on an A/V receiver with an HDMI output to the TV.

Important Note on NetCommand

Be sure to connect the IR emitter cable to the TV and properly place the emitters so that NetCommand can control your devices. See the explanation on the opposite page.

IR Emitter Placement

An IR emitter cable is included with the TV.

The NetCommand system uses emitters connected to the **IR—NetCommand Output** jack to control other devices such as DVD players, cable boxes, satellite receivers, and VCRs.

1. Connect the plug end of the supplied IR emitter cable to the **IR—NetCommand Output** jack on the TV back panel.
2. Run the cable for each of the emitter ends under, alongside, or over each device to be controlled so that the emitter end is in front of the area where the remote control sensor is located.
3. Position the emitter end with the emitter bulb facing the remote control sensor. The bulb emits infrared light in a cone-shaped pattern. Place the bulb far enough from the sensor to allow the cone pattern to reach the sensor.

The IR sensor is usually behind the plastic window of the front display panel. It is sometimes visible with the aid of a flashlight and is normally a round or square cutout behind the plastic.

If you cannot see the sensor and the device's Owner's Guide does not specify the location, you can find it by following these steps using the device's remote control:

- a. Hold the device's remote about one-half inch from the front of the device. Starting from one end of the display window plastic, press the **POWER** button.
- b. If the device does not respond, move the remote control one inch toward the center and try again.
- c. Repeat this until the device responds.
- d. Note this location and then start over from the other end of the display window plastic, repeating until the device responds again.

The remote control sensor is somewhere between these two positions. This is usually enough accuracy for placement of the IR emitters.

In some cases, the emitter works better facing downward from the top of the device. Experiment to find what works best.

5. Secure the emitter ends in place using double-sided tape.
6. Place any unused ends behind the devices to prevent stray signals from reaching the IR sensors.

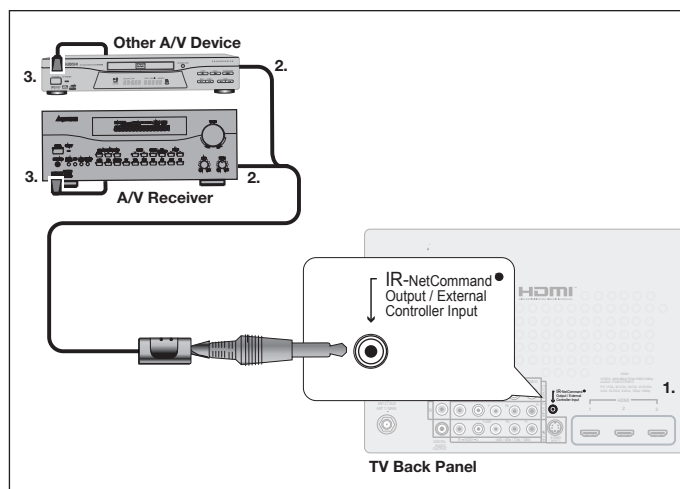

Connecting IR—NetCommand Output

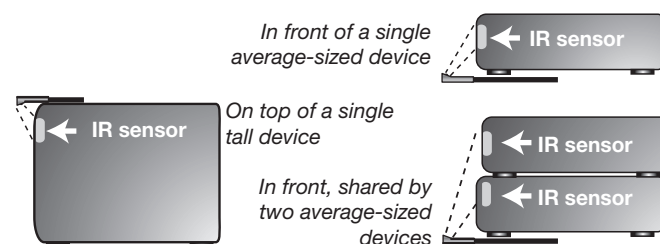

Place IR emitters so the signal can be “seen” by the IR sensor on each device.

IMPORTANT

Position IR emitters so that each device's sensor “sees” the signal from only one emitter. Otherwise, a device receiving signals from multiple sources (remote controls, IR emitters) may not respond at all.

Initial NetCommand Setup for Most Devices

To perform this procedure, you need:

- The remote controls for both the TV and the device you want to control.
- The IR emitter cable supplied with the TV.

Note: To set up an A/V receiver, see “Set Up NetCommand Control of an A/V Receiver” later in this chapter.

1. Connect and position the IR emitters for the devices you wish to control. See “IR Emitter Placement” on the previous page.
2. Set the **TV’s** remote control slide switch to the **TV** position and power on the TV if needed.
3. Open the NetCommand **Learn** screen in one of two ways:

- If working from the **Auto Input Sensing** screen for the device, highlight the **Learn** icon and press **ENTER** to open the **Learn** screen for the device.
- If performing NetCommand setup at any time after the device has been recognized through Auto Input Sensing:
 - a. Press **INPUT** to open the **Input Selection** menu.
 - b. Highlight the desired input icon and press **ENTER** to switch to that input.
 - c. Press **MENU**, highlight **Inputs**, and highlight **Learn** to open the **Inputs > Learn** screen for the device.

4. The first function highlighted in the **Learn** screen is always **Power On**. Aim the **TV’s** remote control at the TV and press **ENTER** to begin learning for that function.
5. When the **Power On** text starts flashing, aim the **device’s** remote control at the TV and press and hold the **POWER** key until a check mark appears next to **Power On**.
 - If the text stops flashing before the check mark appears, repeat the previous step.
 - To remove the key from NetCommand control, press the **CANCEL** key while the key name is highlighted.
6. Press the **▲▼◀▶** keys on the **TV’s** remote control to highlight other keys on the list. Repeat steps 4 and 5 for each additional function you wish to control through NetCommand.
7. If the device’s remote control has keys that are not in the list, you can associate up to any four keys with the **F1** through **F4** keys. Perform NetCommand setup for the **F** keys the same way you did for the named keys. For example, you can:
 - Assign your DVD player’s **CHAPTER SKIP FORWARD** and **CHAPTER SKIP BACK** keys to **F1** and **F2**.

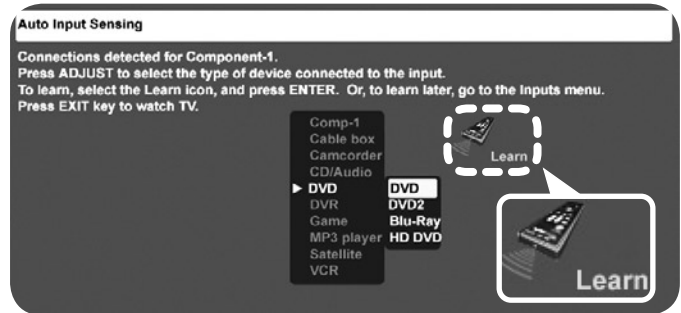

From the **Auto Input Sensing** screen, highlight the **Learn** icon and press **ENTER** to open the **NetCommand Learn** screen.

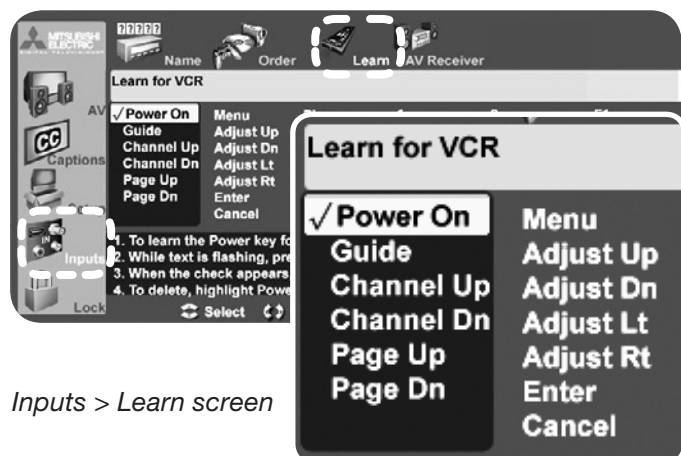

Inputs > Learn screen

- “Learn” your A/V receiver’s DSP options for the current device.
8. If the device has a separate **POWER OFF** key, press **▲▼◀▶** on the **TV’s** remote to highlight **Power Off**. Repeat the earlier steps to “learn” the **POWER OFF** key. **If the device has no POWER OFF key, skip this step.**
 9. Press **EXIT** to finish NetCommand “learning” for the current device.















Adding or Removing Device Keys from NetCommand Control

1. Press **INPUT** to open the **Input Selection** menu, highlight the device’s icon and press **ENTER**.
2. Open the **Inputs** menu and highlight the **Learn** icon.
3. When the **Learn** screen displays:
 - To add keys: Continue as described earlier under “Initial NetCommand Setup for Most Devices” on this page.
 - To delete keys: Highlight the name of the key you wish to delete and press **CANCEL** on the **TV’s** remote control to clear the check mark.

NetCommand Specialized Device Keys

Refer to this chart when “learning” device keys. “Learn” some, all, or none of the keys used for each device type. The chart has space for you to write in functions you assign to the F1–F4 keys.

See the following page for more on keys marked in the “Special Operation Method” column.

Key Name in Learning Screen	Function	Name on TV Remote Control	See Special Operation Method Table
Power On	Power On or Power ON/OFF (toggle)	POWER	*
Guide	On Screen Program Guide or DVD Disc Menus	GUIDE	*
Channel Up	Next Channel Higher	CH/PAGE 	
Channel Dn	Next Channel Lower	CH/PAGE 	
Page Up	Page Up in Guides	CH/PAGE 	*
Page Dn	Page Down in Guides	CH/PAGE 	*
Menu	Setup menu for device	MENU	*
Adjust Up	Adjust or arrow up		
Adjust Dn	Adjust or arrow down		
Adjust Lt	Adjust or arrow left		
Adjust Rt	Adjust or arrow right		
Enter	Enter or Select (menus)	ENTER	*
Cancel	Cancel or erase (menus)	–/CANCEL	*
Play	Start playback		
Stop	Stop playback		
Forward	Fast Forward		
Rewind	Rewind/Fast Reverse		
Pause	Pause playback		
Record	Start Recording		
1, 2, 3, 4, 5, 6, 7, 8, 9, 0	Digit functions	1, 2, 3, 4, 5, 6, 7, 8, 9, 0	
Enter (digits)	Use after digits to directly access channels by number	ENTER	*
- (separator)	Add digital channel separator between main channel number and sub-channel number	–/CANCEL	*
Recall (QV)	Last Channel Recall	QV	
Info	On-screen status display or information display	INFO	May require two keypresses
F1	ASSIGN YOUR CHOICE OF SPECIALIZED FUNCTIONS	F1	
F2		F2	
F3		F3	
F4		F4	
Power Off	Power Off	POWER	

Operating NetCommand-Controlled Devices

Controlling Most Device Types

As an example of NetCommand control, if you are watching your cable box and you wish to tune to the next channel higher, press **CH/PAGE** \wedge . NetCommand then sends the “learned” channel-up control signal to the cable box.

1. With an IR emitter properly positioned in front of the device, use the **Inputs > Learn** screen to perform NetCommand setup for the device.
2. When you wish to use the device, press **INPUT** to display the **Input Selection** menu.
3. Press $\blacktriangle \blacktriangledown \blacktriangleleft \blacktriangleright$ to highlight the icon for the device.
4. Press **ENTER** to switch the TV to the device.

Note: if you have set up automatic input switching for the A/V receiver, the A/V receiver will automatically switch to the correct input for the device.

5. To operate the device using the **TV's** remote control, set the slide switch to the **TV** position.
6. Point the remote control at the **TV** (not the device) and press the key for the desired function.

Special Operation Methods

Key Name in Learning Screen	Special Operation Description and Setup	How to Use
Power On	Manual Power On/Off Use for devices that have only one POWER key.	<ol style="list-style-type: none"> 1. Press INPUT to display the Input Selection menu. 2. Press $\blacktriangle \blacktriangledown \blacktriangleleft \blacktriangleright$ to highlight the icon for the device to be powered on or off. 3. With the Input Selection menu still displayed, press POWER to send the power signal; you may need to press POWER twice. <p>Note: If you press POWER without the Input Selection menu displayed, the TV will turn off.</p> <ol style="list-style-type: none"> 4. Press ENTER to switch the TV to the device.
Power On Power Off	Automatic Power On/Off This feature is only for devices that have separate POWER ON and POWER OFF keys on their original remote controls. If your device does not have a separate POWER OFF key, do not use the Power Off learning position; use only the Manual Power ON/OFF method described above. In the NetCommand Learn screen: <ol style="list-style-type: none"> a. “Learn” the Power On command in the Power On learning position. b. “Learn” the Power Off command in the Power Off learning position. 	<ul style="list-style-type: none"> • To Power On the Device <ol style="list-style-type: none"> 1. Press INPUT to display the Input Selection menu. 2. Press $\blacktriangle \blacktriangledown \blacktriangleleft \blacktriangleright$ to highlight the icon for the device to be powered on or off. 3. Press ENTER to switch the TV to the device and NetCommand will send the Power On command to the device. • To Power Off the Device When you turn the TV off, the TV sends all learned Power Off commands to all devices.
Menu	Displaying the Menu for a Device	<ol style="list-style-type: none"> 1. While watching a device, press INPUT to display the Input Selection menu with the device icon highlighted. 2. Press MENU to send the menu signal to the device. The Input Selection menu will automatically clear from the screen.

Controlling an A/V Receiver

See page 58 to set up control of an A/V receiver.

Switching Audio to and from the A/V Receiver

1. Press **AUDIO**.
2. Press \blacktriangle to show the Speakers option.
3. Press \blacktriangleright to select either **AV Receiver** or **TV**.

Controlling A/V Receiver Power

1. Press **AUDIO**.
2. Press $\blacktriangle \blacktriangledown$ to show the Speakers option.
3. Press \blacktriangleright to select **AV Receiver**.
4. Point the remote control at the **TV** (not the A/V receiver) and press **POWER** to power the A/V receiver on or off.

Controlling Other A/V Receiver Functions

With the A/V receiver powered on and selected, the TV's remote operates the volume and mute functions. Also, when you switch to a device in the **Input Selection** menu, the A/V receiver automatically switches to the correct audio input for the device.

Operating NetCommand-Controlled Devices, continued

Key Name in Learning Screen	Special Operation Description and Setup	How to Use
Guide	<p>Displaying the Disc Menu (DVD or high-definition disc format)</p> <p>“Learn” the DISC MENU, TOP MENU, or other key as named on the original remote in the Guide learning position.</p>	While watching the device, press GUIDE to display the disc menu.
	<p>Displaying the On-Screen Program Guide (cable box or satellite receiver)</p> <ol style="list-style-type: none"> “Learn” the GUIDE key on the original remote in the Guide learning position. Learn the PAGE \wedge and PAGE \vee keys of the original remote in the Page Up and Page Dn learning positions. 	<ol style="list-style-type: none"> While watching the device, press GUIDE to display the guide. Press CH/PAGE \wedge/\vee to send the Page Up/Dn commands for the guide.
Page Up Page Dn	<p>Using Page Up/Down</p> <p>If the device’s original remote control has separate keys for Channel Up/Dn and Page Up/Dn, the TV remote control’s CH/PAGE \wedge/\vee key can work like the two separate keys.</p> <ol style="list-style-type: none"> “Learn” CHANNEL \wedge/\vee in the Channel Up/Dn positions. “Learn” PAGE \wedge/\vee in the Page Up/Dn positions. 	<ul style="list-style-type: none"> Inside the Guide Press CH/PAGE \wedge/\vee to send the Page Up/Dn commands. Outside the Guide Press CH/PAGE \wedge/\vee to send the Channel Up/Dn signal.
Enter	<p>Enter Functions (cable boxes, satellite receivers, etc.)</p> <p>Some devices have two keys that have “enter” functions. One key is for menus and is often labelled SELECT or OK. A second key is for use with number keys for direct channel selection. NetCommand uses the same ENTER key for both operations.</p>	
	<p>When ENTER has a menu or guide function or when the original remote control uses the same key for menus and channel selection:</p> <p>Learn the ENTER, SELECT, or OK key in the NetCommand Enter learning position.</p>	<ol style="list-style-type: none"> Press MENU or GUIDE to display the device’s menu or guide. Press ENTER within the menu and NetCommand will send the Enter signal for menus.
Enter (digits)	<p>When ENTER is for channel changes, i.e., the original remote control has a separate ENTER key for this function):</p> <p>Learn the ENTER key for channel selection in the NetCommand Enter (digits) learning position. Use this learning position only if the original remote control has separate keys for Enter in menus and Enter for channel selection.</p>	Press digit key(s) and then press ENTER . NetCommand will send the Enter signal for channel selection.
Cancel	<p>CANCEL as the Cancel or Exit Function</p> <p>“Learn” the Cancel or Exit function in the NetCommand Cancel learning position</p>	<ol style="list-style-type: none"> Press MENU or GUIDE to display the menu or guide. Press CANCEL and NetCommand will send the Cancel or Exit signal.
– (separator)	<p>The symbol “–” can serve as the separator between a digital channel’s main and sub-channel digits, e.g., digital channel 12-1 (main channel is 12, sub-channel is 1).</p> <p>“Learn” the channel separator function in the NetCommand – (separator) learning position.</p>	Press digit key(s) and press CANCEL . NetCommand will send the channel-separator signal.

Setting Up NetCommand Control of an A/V Receiver

Several types of A/V receiver control are described here using the **Inputs > AV Receiver** menu.

- Controlling power and volume is described on this page.
- For most equipment setups, see “A/V Receiver Control: Automatic Audio Switching” on the opposite page.
- If your A/V receiver has an HDMI output, you have the option of sending both audio and video through the A/V receiver over a single HDMI cable to the TV. See “A/V Receiver Control: Automatic Audio and Video Switching via HDMI,” page 61.

Note: To set up control of other device types, see “Initial NetCommand Setup for Most Devices,” page 54.

A/V Receiver Control: Power and Volume

Perform this setup to operate the A/V receiver’s power and volume functions with the TV’s remote control.

To perform this setup you need:

- The remote controls for both the TV and the A/V receiver.
- The IR emitter cable supplied with the TV.

Before You Begin

1. Connect your A/V receiver to the TV and any additional devices. See chapter 3, “TV Connections,” for suggestions.
2. Connect the IR emitter cable to the TV and position the IR emitter where it can send signals to the A/V receiver. See “IR Emitter Placement,” page 53.
3. Set the **TV’s** remote control slide switch to the TV position and power on the TV if not already on.

Setup to Control A/V Receiver Power and Volume

1. Open the **AV Receiver** screen in one of two ways:
 - If using the **Auto Output** or **Auto Input Sensing** screen for the A/V receiver, highlight the **Learn** icon and press **ENTER** to open the **AV Receiver** screen.
 - If performing NetCommand setup at any time after the A/V receiver has been recognized through Auto Output/Auto Input Sensing: Press **MENU**, highlight **Inputs**, and highlight **AV Receiver** to open the **AV Receiver** screen.
2. The first function highlighted in the **AV Receiver** screen is always **Power On**. Aim the **TV’s** remote control at the TV and press **ENTER** to begin learning for **Power On**.

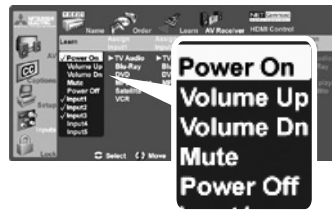

AV Receiver screen. Perform NetCommand IR “learning” for A/V receiver power and volume keys.

3. When the **Power On** text starts flashing, aim the **A/V receiver’s** remote control at the TV and press and hold the **POWER** or **POWER ON** key until a check mark appears next to **Power On**.
 - If the text stops flashing before the check mark appears, repeat this step.
 - To remove the key from NetCommand control, press the **CANCEL** key while the key name is highlighted.
4. Press the **▼** key on the **TV’s** remote control to highlight other keys in the list. Repeat steps 2 and 3 for each additional function you wish to control through NetCommand.
5. If the A/V receiver has a separate **POWER OFF** key, press **▼** on the **TV’s** remote to highlight **Power Off**. Repeat steps 2 and 3 to “learn” the **POWER OFF** key.
6. When finished “learning” the power and volume keys, either press **EXIT** to watch TV or leave the **AV Receiver** screen open to continue with NetCommand setup to control switching of A/V receiver inputs.

IMPORTANT

To hear audio sent from the TV to the A/V receiver, you must have:

- Physically connected the TV to the A/V receiver via the analog or digital audio output.
- Assigned, if needed, the name **AVR** if using an HDMI A/V receiver.
- Selected the A/V receiver as the audio source. Press **AUDIO**, then **▲▼** to show the **Speakers** option, then **►** to select the **A/V Receiver**.
- “Learned” the IR codes for the A/V receiver inputs.
- Assigned the TV’s audio output to the correct input in the NetCommand A/V Receiver Learn screen.

Setting Up NetCommand Control of an A/V Receiver, continued

A/V Receiver Control: Automatic Audio Switching

Perform one of these setups to enable the A/V receiver to switch automatically to the correct audio input when you select a device in the TV's **Input Selection** menu.

To set up control of an A/V receiver you need:

- The remote controls for both the TV and the A/V receiver.
- The IR emitter cable supplied with the TV.
- Connecting cables

Two different setups are described here. Review the descriptions to find the setup needed for your equipment.

Audio Switching Setup 1: Audio from TV's Audio Output

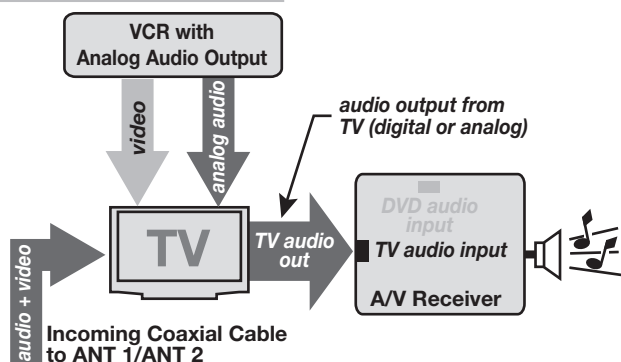

Audio Switching Setup 1: Audio to the A/V receiver from the TV's digital or analog audio output

- **Audio Available from TV only**
Audio from **ANT 1** and **ANT 2** must be sent to the A/V receiver from the TV's **DIGITAL AUDIO OUTPUT** or analog **AVR AUDIO OUTPUT**.
Use Setup 1 to make the A/V receiver switch to its designated TV audio input when viewing these sources.
- **Analog Stereo Audio**
Audio from sources with only analog stereo output (such as a VCR) can be sent either directly to the A/V receiver or through to the TV and then on to the A/V receiver.
Mitsubishi recommends you send audio through the TV as shown in the example. Setup 1 causes the A/V receiver to switch to its input designated for TV audio.
If you have a digital A/V receiver, the TV makes the audio available by converting analog audio to a digital output.
- **HDMI Digital Stereo Audio**
Digital stereo audio from an HDMI connection is available both in digital format (from the TV's **DIGITAL AUDIO OUTPUT** jack) and in analog format (from the TV's **AVR AUDIO OUTPUT** jack).

Audio Switching Setup 1: Automatic A/V Receiver Switching to TV Audio Input

Audio Switching Setup 2: Automatic A/V Receiver Switching to a device sending audio directly to the A/V receiver. **You must use setup 2 to hear digital surround sound from the source device.**

Note: Automatic audio and video switching over an HDMI cable is covered on page 61.

Audio Switching Setup 2: Audio from Source Device

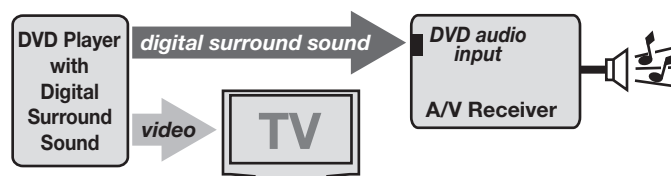

Audio Switching Setup 2: Audio from a device providing surround sound is sent directly to the A/V receiver.

Note: This setup is required to hear digital surround sound

A device can send digital surround sound such as Dolby Digital or DTS directly to the A/V receiver, bypassing the TV entirely. The device might be a DVD player, cable box, or satellite receiver, and could have HDMI output. A DVD player is used in this example. Your setup may include additional devices with digital surround sound connected directly to the A/V receiver. These devices might be a DVD player plus a cable box or satellite receiver.

Setting Up NetCommand Control of an A/V Receiver, continued

Before You Begin

1. Connect your A/V devices to the TV and connect your A/V receiver to the audio outputs on the TV and the DVD player. See chapter 3, “TV Connections,” for suggestions. **Important:** To use Setup 1, you must connect the A/V receiver to the TV’s audio output; i.e., the TV’s **AVR AUDIO OUTPUT** or **DIGITAL AUDIO OUTPUT** jack.
2. Position NetCommand IR emitters as described in “IR Emitter Placement,” page 53.
3. Open the **Inputs > AV Receiver** menu.

Note: The terms **Input1–Input5** used in the **AV Receiver** menu are arbitrary names used by the TV to uniquely identify A/V receiver inputs.

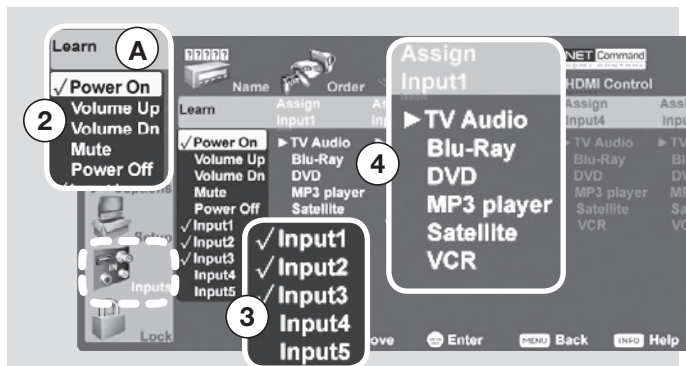

AV Receiver menu to set up audio switching

- A The **Learn** column lists “learnable” input keys on the A/V receiver’s remote control.
- B A check mark next to a key name indicates it has been “learned” by NetCommand.
- C **Input1** through **Input5** are arbitrary names the TV uses to uniquely identify A/V receiver inputs.
- D After “learning” IR codes for A/V receiver inputs, use the **Assign Input** column to identify the device connected to the TV and the associated A/V receiver input.

For the given example:

1. Connect the TV’s audio output to the A/V receiver’s TV audio input.
2. Using this screen, “learn” the IR code for the A/V receiver’s TV audio input as **Input1** (item 3 above).
3. In the **Assign Input1** column (item 4 above), assign the name **TV Audio** (the default) to the A/V receiver IR code previously learned as **Input1**.
4. Connect the DVD player’s audio output to the A/V receiver’s DVD input.
5. Using this screen, “learn” the IR code for the A/V receiver’s DVD audio input as **Input2**.
6. In the **Assign Input2** column, assign the name **DVD** to the A/V receiver IR code previously learned as **Input2** in this screen.

Audio Switching Setup 1: Automatic A/V Receiver Switching to the TV Audio Input

Most devices are set up to use the TV’s audio output like the VCR in this example; analog audio from the device is sent through the TV to the A/V receiver’s TV audio input.

Use this setup for:

- Sources providing only analog stereo output, such as a VCR.
- Audio from **ANT 1** and **ANT 2**

1. Under **Learn**, highlight **Input1**.

In this example, the IR code for the A/V receiver’s **TV Audio** input will be “learned” as **Input 1**.

2. Press **ENTER** on the **TV’s** remote control.
3. While the text **Input1** is flashing, press and hold the **TVINPUT** key on the **A/V receiver’s** remote control.
4. When a check appears next to **Input 1**, release the **TVINPUT** key.
 - If the text stops flashing before the check mark appears, repeat this step.
 - To erase the IR code just “learned,” press **CANCEL** while the name is highlighted.

5. Press **▶** once to highlight **TV Audio** (TV audio output) in the **Assign Input1** column. The triangular marker is always next to the assigned sound source.
6. Press **EXIT** if finished or continue with setup for another TV audio source.



Completed NetCommand setup described for controlling A/V receiver switching to the A/V receiver’s audio input from the TV’s **AUDIO OUTPUT**.

IMPORTANT

All audio from what you are watching on the TV is always available from both the TV’s **AVR AUDIO OUTPUT** and **DIGITAL AUDIO OUTPUT** jacks.

To use the digital surround sound capabilities of your A/V receiver however, you must connect your DVD player, satellite receiver, or cable box directly to the A/V receiver, as surround sound may not be available from the TV’s audio output.

Setting Up NetCommand Control of an A/V Receiver, continued

Audio Switching Setup 2: Automatic A/V Receiver Switching to a Surround Sound Device

Use this setup to send digital surround sound directly from a device to an A/V receiver.

- Under **Learn**, highlight **Input2**.
In this example, the IR code for the A/V receiver's **DVD Audio** input will be "learned" as **Input2**.
- Press **ENTER** on the **TV's** remote control.

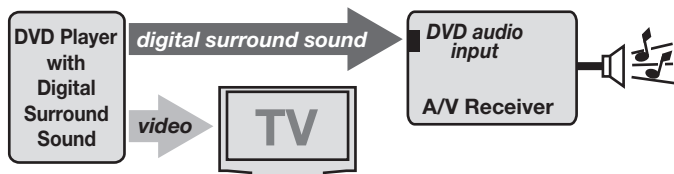

Setup 2: A/V receiver audio from a device providing surround sound directly to the A/V receiver



Completed NetCommand setup described for controlling A/V receiver switching to an A/V receiver input "learned" as **Input2**.

- While the text **Input2** is flashing, press and hold the **DVD INPUT** key on the **A/V receiver's** remote control.
- When a check appears next to **Input2**, release the **DVD INPUT** key.
 - If the text stops flashing before the check mark appears, repeat this step.
 - To erase the IR code just "learned," press **CANCEL** while the name is highlighted.
- Press **▶** once to move the highlight to the **Assign Input2** column.
- Use **▲ ▼** to highlight **DVD** in the list of devices recognized by the TV. The triangular marker always shows the assigned sound source.
- Press **EXIT** if finished or continue for additional TV sources.

A/V Receiver Control: Automatic Audio and Video Switching via HDMI

If your A/V receiver has an HDMI output, you can use this procedure to set up control of the A/V receiver's audio and video switching. The HDMI connection allows you to route video signals from multiple devices over a single cable to the TV. See the diagram on the next page. The connected devices can be analog, digital, or a mixture of the two.

More About Using an HDMI Connection

- Audio from devices connected directly to the TV can be heard from the TV speakers only. This is because audio signals are sent on the HDMI cable in one direction only—through the A/V receiver to the TV speakers. To send audio to the A/V receiver from a device connected directly to the TV, use one of the optional audio connections shown in the diagram. For example, use an optional audio connection if you wish to use the A/V receiver speakers to hear audio from:
 - The **ANT 1** or **ANT 2** inputs
 - A device connected to the convenience input (**INPUT 4**), such as a game or camcorder.
- In some circumstances, audio from a device connected to the A/V receiver may not be passed over the HDMI cable to the TV speakers. You must use the A/V receiver speakers to hear audio in these cases.

Before You Begin

To complete these steps you will need:

- The remote controls for both the TV and the A/V receiver.
 - The IR emitter cable supplied with the TV.
 - An HDMI-to-HDMI cable to connect the A/V receiver to the TV and cables necessary to connect devices to the A/V receiver.
- Connect your audio/video devices to the A/V receiver. Note the name of the device connected to each A/V receiver input. This information will be needed later to set up NetCommand's automatic input switching.
 - Connect the A/V receiver to the TV with an HDMI-to-HDMI cable.
 - Connect the IR emitter cable to the TV and position the IR emitter where it can send signals to the A/V receiver. See "IR Emitter Placement," page 53.

Setting Up NetCommand Control of an A/V Receiver, continued

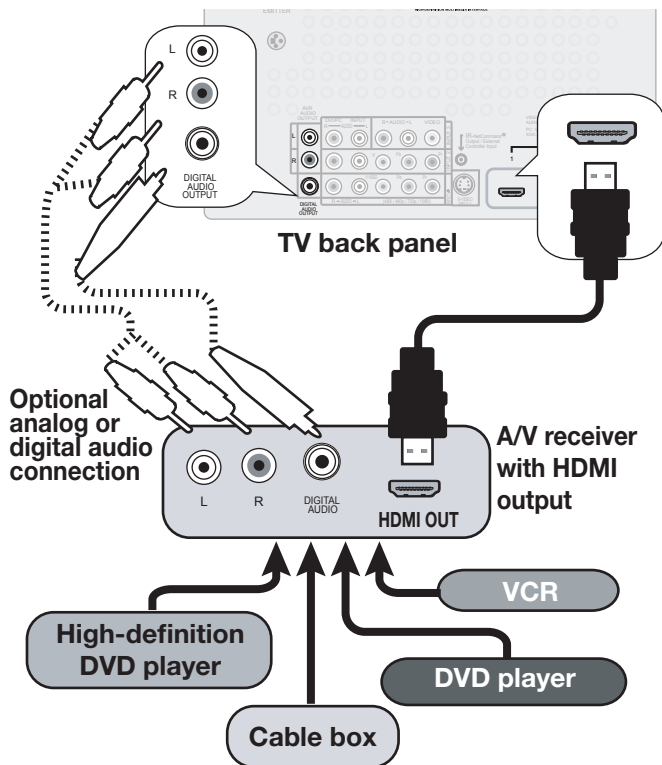

Multiple video inputs on a single HDMI cable. You can connect multiple video devices to an A/V receiver that has an HDMI output. The optional audio connection allows you to hear, through the A/V receiver, devices connected to the TV only.

- Power on the A/V receiver.
- Set the TV's remote control slide switch to the TV position and power on the TV if needed.
- When the **Auto Input Sensing** screen displays, select device name **AVR**.

Setup to Control A/V Receiver Power and Volume

Perform the steps under "A/V Receiver Control: Power and Volume," page 58.

Setup to Control Switching to the TV's Audio Output

If you have used one of the optional audio connections to the TV's **AVR AUDIO OUTPUT** or **DIGITAL AUDIO OUTPUT** jacks, set up NetCommand to control switching to the TV audio input. Perform the steps under "Audio Switching Setup 1: Automatic A/V Receiver Switching to the TV Audio Input," page 60.

Setup to Control Automatic Audio and Video Switching via HDMI

Follow these steps if you wish NetCommand to control switching of A/V receiver video as well as audio inputs over an HDMI cable. When this setup is complete, you can use the TV's **Input Selection** menu to select a video device connected to the A/V receiver. You can also perform additional NetCommand setup to control devices connected to the A/V receiver.

- Display the **Inputs > AV Receiver** menu.

Note: The labels **Input1** through **Input5** in the **Learn** column are names used by the TV to uniquely identify A/V receiver inputs.

- With the highlight in the **Learn** column, highlight one of the **Input** labels **Input2** through **Input5**; it is recommended you leave **Input1** reserved for **TV Audio**.

AV Receiver menu for audio and video switching with HDMI output

- The **Learn** column lists "learnable" keys from the A/V receiver's remote control.
- Input1** through **Input5** are arbitrary names used by the TV to uniquely identify "learnable" A/V receiver inputs.
- A check mark next to a key name indicates it has been "learned" by NetCommand.
- The **Assign Input** column provides a list of possible device types. Use this list to select the device type connected to the associated A/V receiver input. The assigned device name will appear in the **Input Selection** menu.

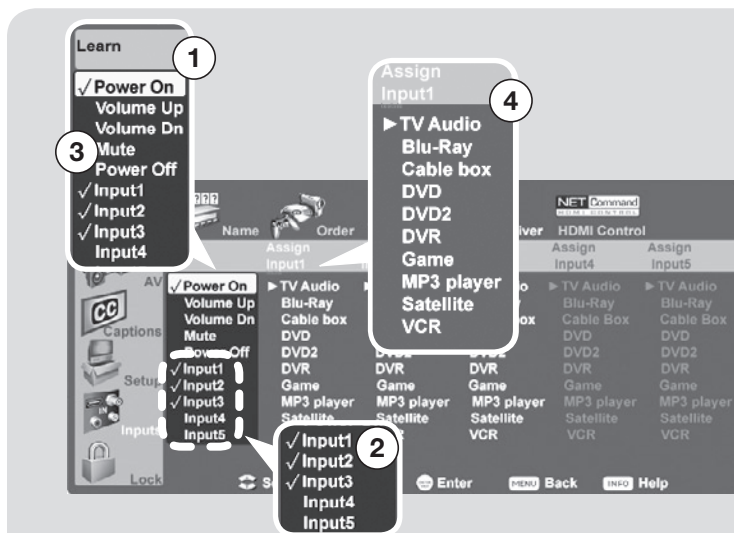

Setting Up NetCommand Control of an A/V Receiver, continued

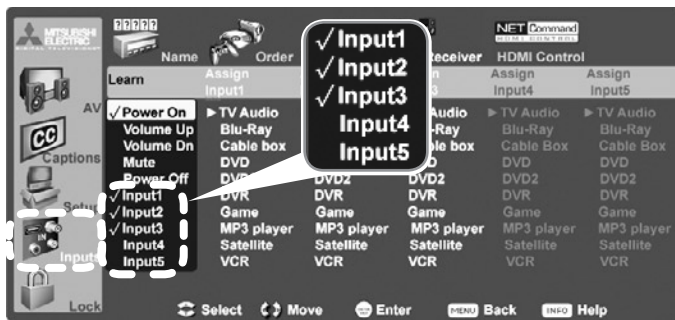

- Press ENTER and the highlighted **Input** label will start flashing to indicate readiness for “learning.”
- While the **Input** text is flashing, press and hold the key on the **A/V receiver's** remote control for the input you wish to associate with the selected **Input** label.
- When a check appears next to the **Input** label, release the remote control key.
 - If the text stops flashing before the check mark appears, repeat this step.
 - To erase the IR code just “learned,” press CANCEL while the name is highlighted.

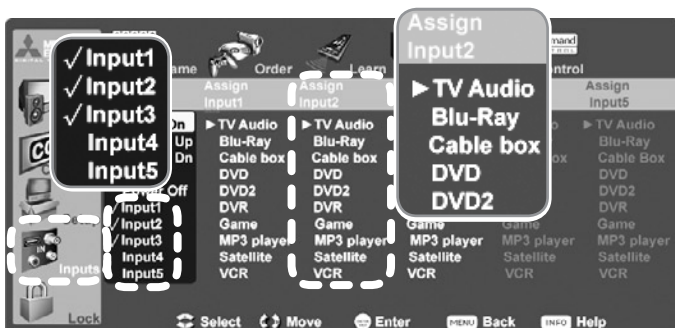

- On the **TV's** remote control, press ► once. The highlight will move automatically to the associated **Assign Input** column (**Assign Input1** through **Assign Input5**).
- Use ▲ ▼ to highlight the device type connected to the A/V receiver input just “learned.” The **Assign Input** column contains a list of possible device types.

In the example above, a DVD player is connected to the A/V receiver input the TV knows as **Input2**.

The device type you select here will appear as an icon in the TV's **Input Selection** menu. You can assign each device type in the list only once.

- Press EXIT if finished or repeat these steps for additional video sources connected to the A/V receiver.

NetCommand IR Control: Device Connected to an A/V Receiver

Use this setup to have NetCommand control a device sending audio and video through the A/V receiver to the TV via HDMI.

- Set up NetCommand control of A/V receiver audio/video switching via HDMI as described on the opposite page.

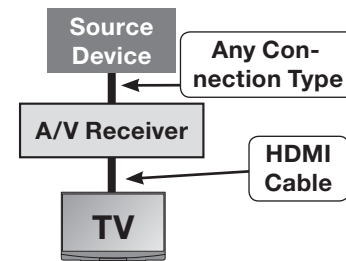

- Press EXIT to close any open menus and return to normal TV viewing.
- Press INPUT to open the **Input Selection** menu.
- Highlight the icon for the A/V receiver input you wish to control.

The A/V receiver's remote control key for the input must have been “learned” previously using “Setup to Control Automatic Audio and Video Switching via HDMI” on the opposite page.

- Press ENTER to switch the TV to the A/V receiver and the A/V receiver to the device.
- Open the **Inputs > Learn** menu.
- Perform NetCommand “learning” for the device by following the steps in “Initial NetCommand Setup for Most Devices,” page 54.

Appendix A: Specifications

Size, Weight, and Power Consumption					
Model	Dimensions (inches)			Weight (lbs.)	Power (watts)
	Height	Width	Depth		
WD-60C8, WD-60735	36.7	53.8	14.4	68.3	265
WD-65C8 WD-65735	39.5	58.2	15.4	75.4	265
WD-73C8, WD-73735	43.6	65.2	17.5	95	265
WD-65736	39.5	58.2	15.4	75.4	270
WD-73736	43.6	65.2	17.5	95	270
WD-65835	39.5	58.2	15.4	78	270
WD-73835	43.6	65.2	17.5	98	270

Inputs		
Type	Qty.	Input Specifications
Antenna/Cable input	2	RF F connector, 75-ohm
HDMI (digital video/audio)		CEA-861D standard for digital audio and video via HDMI HDMI standard connector
WD-60C8 WD-65C8 WD-73C8 WD-60735 WD-65735 WD-73735	3	Video: 60 Hz: 480i, 480p, 720p, 1080i 24 Hz, 30 Hz, 60 Hz: 1080p Audio: PCM stereo HDMI inputs are compliant with CEA-861D standards for standard, extended, and high-definition video; digital audio, and HDCP copy protection.
WD-65736 WD-73736 WD-65835 WD-73835	4	PC (digital signals only): VGA (640 x 480, 60 Hz) W-VGA (848 x 480, 60 Hz) SVGA (800 x 600, 60 Hz) W-SVGA (1064 x 600, 60 Hz) XGA (1024 x 768, 60 Hz) 1280 x 720, 60 Hz SXGA (1280 x 1024, 60 Hz) 1920 x 1080 (24 Hz, 30 Hz, 60 Hz) WXGA (1360 x 768, 60 Hz)
Composite Video	up to 3	NTSC 480i only Video: RCA Pin Plug, 1.0 V p-p, 75 ohm 1 dedicated composite video jack; 2 shared with component video Y
S-Video	1	Four-Pin DIN Plug Y: 1.0 Vp-p 75-ohm C: 0.286 Vp-p (burst signal), 75-ohm

Component Video (Y/Pr/Pb)	up to 3 sets	CEA-770.1 & CEA 770.2 480i, 480p, CEA 770.3 720p and 1080i (TV analog component video standards) RCA Pin Plug Y: 1.0 Vp-p (includes sync), 75-ohm Pr: 700 mV p-p, 75-ohm Pb: 700 mV p-p, 75-ohm 1 dedicated set of component video jacks; 2 sets share a jack with composite video
USB Photo Port	1	For transfer of JPEG files only.
Audio Inputs	5 pairs	Analog left and right audio RCA Pin Plug 500 mV (full scale), 43-k ohm

Outputs		
Description	Qty.	Output Specifications
Audio Speakers	2	5.75" x 2.4"
Analog Audio (Signal)	1 pair	RCA Pin Plug, 500 mV rms \pm 200 mV (full scale) for analog sources, 1.5 Vrms \pm 0.5 Vrms (full scale) for digital sources.
Digital Audio Output	1	RCA Pin Plug, Signal Type Dolby Digital, PCM stereo
3-D Glasses Emitter	1	VESA 1997-11 Connector and Signal Standards for Stereoscopic Display Hardware

Image Technology	Lamp
DLP, 0.65" chip, 1920 x 1080 pixels with Smooth Picture™	180-watt VIP type

Channel Frequency Reception	Over-the-Air: VHF 2–13, UHF 14–69 Analog Cable: 1–125 Digital Cable: 1–135	
Channel Type*	Over the Air:	Analog NTSC, Digital ATSC with sub-channels (all 18 video formats)
	Cable:	Analog NTSC (non-scrambled) Digital QAM 64 and 256 with sub-channels (non-scrambled)

* Note for Digital Channels: The channel numbers displayed on screen are determined by the broadcaster or cable company and can vary from the standard frequency number. If there is no channel-number information provided by the broadcaster or cable company, the TV creates a channel number. The created channel number uses the frequency number as the main channel number and the program number as the sub-channel number.

Appendix B: Bypassing the Parental Lock

Lock Bypass Instructions Have Been Filed for Future Reference

IMPORTANT

Cut along the dotted line and file bypass instructions in a safe place for future reference.

Bypassing the Parental Lock

After you set the lock, you must use your pass code to view a locked program, view the locked TV, view a locked channel, cancel the lock, or enter the **Lock** menus.

If you forget your pass code, you can view the locked TV without entering your pass code. When you are prompted for your pass code, press the number **9** and **QV** keys on the TV remote control at the same time. This process temporarily unlocks the TV.

When entering the **Lock** menu, this process deletes your old pass code and prompts you to enter a new pass code.

- You can either enter a new pass code to open the **Lock** menu and make changes or press **EXIT** to close the menu.
- If any of the locks are turned on and you exit the menus when prompted for a new code, the old code and all lock settings are retained.
- If all locks are turned off and you exit the menus when prompted for a new code, then the previous code is erased.

IMPORTANT

When changing or deleting your pass code, you must use the remote control included with this TV. You cannot use a Mitsubishi remote control from another component or a “universal” remote.

This page intentionally left blank

Appendix C: Programming the Remote Control

This appendix explains programming the TV's remote control to operate other A/V devices. This is distinct from NetCommand control. The TV's remote control can operate other devices by three different methods:

- Remote Control Programming: You must move the slide switch to the position specific to the type of device.
- **736 or 835 Series TV.** NetCommand® IR "learning": You can operate other devices with the slide switch in the TV position.
- NetCommand for CEC devices (all TV models): You may be able to operate compatible HDMI devices with the slide switch in the TV position. See the device's Owner's Guide and Appendix "E," page 77.

Functions Available for Other A/V Devices

The TV's remote control can be programmed to operate other types and brands of A/V products. To use the remote when programmed, **set the slide switch to the position labelled for the product type.** The functions performed in each switch position can vary depending on the product. Not all functions work for all models. The most common functions available are listed on this page.

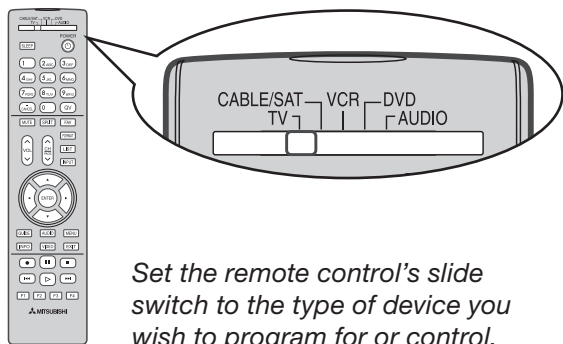

Set the remote control's slide switch to the type of device you wish to program for or control.

IMPORTANT

Some manufacturers may change their products or they may use more than one remote control system. The TV's remote control may be unable to operate your A/V equipment in these cases.

VCRs and DVRs

- | | |
|---|---|
| <ul style="list-style-type: none"> • CH \wedge/\vee • POWER • SLEEP • \blacktriangleright (FAST FORWARD) • \parallel (PAUSE) • \blacktriangleright (PLAY) | <ul style="list-style-type: none"> • \bullet (RECORD) • \blacktriangleleft (REVERSE) • \blacksquare (STOP) • GUIDE (DVR only) • MENU (DVR only) • 0-9 Number Buttons |
|---|---|

Mitsubishi VCRs are compatible with some additional buttons.

Cable Boxes and Satellite Receivers

- | | |
|--|--|
| <ul style="list-style-type: none"> • AUDIO (PAGE UP) • CANCEL (on some models) • CH \wedge/\vee • ENTER (on some models) • GUIDE (on some models) • LIST • POWER • $\blacktriangle \blacktriangledown \blacktriangleleft \blacktriangleright$ (on some models) • VIDEO (PAGE DOWN) • QV (ENTER; for channels on some models) | <ul style="list-style-type: none"> • 0-9 Number Buttons (on some models) • F1-F4 (A, B, C, D keys on some models) <p>The record/playback keys (on some models):</p> <ul style="list-style-type: none"> • \blacktriangleright (FAST FORWARD) • \parallel (PAUSE) • \blacktriangleright (PLAY) • \bullet (RECORD) • \blacktriangleleft (REVERSE) • \blacksquare (STOP) |
|--|--|

A/V Receivers

- | | |
|--|---|
| <ul style="list-style-type: none"> • MUTE • POWER • SLEEP • VOLUME • 0-9 Number Buttons | <ul style="list-style-type: none"> • Direct Input Selection buttons: numbers, FAV and QV (on some Mitsubishi models) |
|--|---|

CD Players

(not all functions for all models)

- | | |
|---|---|
| <ul style="list-style-type: none"> • SLEEP • \blacktriangleright (FAST FORWARD) • \parallel (PAUSE) • \blacktriangleright (PLAY) | <ul style="list-style-type: none"> • \blacktriangleleft (REVERSE) • \blacksquare (STOP) • 0-9 Number Buttons |
|---|---|

DVD and Laser Disc Players

(not all functions for all models)



- | | |
|---|---|
| <ul style="list-style-type: none"> • CANCEL (on some models) • CH \wedge/\vee (for track skip on some models) • ENTER • MENU • POWER • SLEEP • $\blacktriangle \blacktriangledown \blacktriangleleft \blacktriangleright$ (on some models) | <ul style="list-style-type: none"> • \blacktriangleright (FAST FORWARD) • \parallel (PAUSE) • \blacktriangleright (PLAY) • \bullet (RECORD) • \blacktriangleleft (REVERSE) • \blacksquare (STOP) • 0-9 Number Buttons (on some models) |
|---|---|

Appendix C: Programming the Remote Control, continued

Programming the Remote Control

1. Move the slide switch at the top of the remote to the position for the product you want to control. Refer to the table below. Only one of each device type can be controlled in each slide-switch position.

Switch Position	Affected Device
CABLE/SAT	Cable Box DTV Receiver Satellite Receiver
VCR	VCR DVR Laser Disc Player DVD Player/Recorder
DVD	DVD Player/Recorder DVR Laser Disc Player VCR
AUDIO	A/V Receiver Audio Amplifier CD Player

2. Press and hold **POWER** on the remote control for several seconds until the button blinks twice and goes off.
3. Release the **POWER** button.
4. Enter the first five-digit code listed for your equipment.
 - The **POWER** button blinks twice when you start to enter the code and then once for each additional keypress.
 - The **POWER** button blinks twice when you finish entering a valid code.
 - Move the slide switch to another position if you need to start over or wish to exit programming mode.
5. Point the remote control at the equipment and press **POWER**. If the product has no power on/off function, press a different key, such as  (**PLAY**),  (**STOP**), **VOL** , or **MUTE**.
 - If the equipment responds, the remote control is properly programmed to operate the equipment.
 - If the equipment does not respond, repeat steps 2–4 with the next five-digit code listed for your equipment.

6. Once you have found the correct code, write it in the space below for future reference.

Switch Position	Device Type	Code
CABLE/SAT		
VCR		
DVD		
AUDIO		

Code Verification

To determine the code programmed for any position of the slide switch:

1. Move the slide switch to the position you wish to verify.
2. Press and hold **POWER** on the remote control for several seconds until the button blinks twice and goes off.
3. Press keys **9 9 0**
4. Press **1** and count the blinks of the power button. Write down the number of blinks as the first digit of the code.
5. Repeat step 4 for the second, third, fourth, and fifth digits of the code.

Audio Lock: Universal A/V Receiver Control

With Audio Lock active, the remote control operates the volume and mute functions of the A/V receiver in all positions of the slide switch. Activate Audio Lock if you normally use an A/V receiver with your TV and other A/V equipment.

1. Program the **AUDIO** position for your A/V receiver as described earlier in this section.
2. With the slide switch in the **AUDIO** position, press and hold **POWER** on the remote control for several seconds until the button blinks twice and goes off.
3. Press keys **9 9 3 ENTER**
The **POWER** button will blink twice to indicate Audio Lock is active.

To Reset the Remote Control to Operate Volume and Mute for the TV Speakers

1. Press and hold **POWER** for several seconds until the key blinks twice and goes off.
2. Press keys **9 9 3 VOL** .
The **POWER** key will blink four times to indicate Audio Lock has cleared.

IMPORTANT

You may need to reprogram the remote control after changing the batteries.

Appendix C: Programming the Remote Control, continued

Programming Codes

Audio Amplifiers	
Make	Code
Acurus	30765
Adcom	31100, 30577
Altec Lansing	31742
Aragon	30765
Bel Canto Design	31583
Bose	30674
Carver	30892
Cary Audio Design	31879
Classe	31461
Curtis Mathes	30300
Durabrand	31561
Flextronics	31879
GE	30078
Halcro	31934
Harman/Kardon	30892
JVC	30331
Klipsch	30765
Krell	31837
Left Coast	30892
Lenoxx	31561
Lexicon	31802, 31145
Marantz	30892
Mark Levinson	31483
McIntosh	30251
Modulaire	30395
Mondial	30765
Optimus	30823, 30395, 30300, 30013
Parasound	31934
Philips	30892
Pioneer	30823, 30300, 30013
Polk Audio	30892
Primare	31395
RadioShack	30395
RCA	30823, 30300, 30013
Realistic	30013, 30395
Soundesign	30078
Technics	30372
Victor	30331
Wards	30078, 30013
Yamaha	30354

Cable Boxes	
Make	Code
A-Mark	10144, 10008
ABC	10237, 10014, 10011, 10008, 10007, 10003
Accuphase	10014, 10011, 10007, 10003
Acorn	10237
Action	10237
Active	10237
Americast	10899
Archer	10237
BCC	10276
Bell & Howell	10014
Bell South	10899
British Telecom	10003
Century	10008
Clearmaster	10883

Cable Boxes	
Make	Code
ClearMax	10883
Comtronics	10040
Cool Box	10883
Coolmax	10883
Digeo	11187
Digi	10637
Director	10476
Dumont	10637
Emerson	10014
Everquest	10040
Fosgate	10276
GC Electronics	10040
GE	10144
General Instrument	10810, 10476, 10276, 10020, 10014, 10012, 10011, 10003
Gibraltar	10003
GMI	10883
GoldStar	10144, 10040
Hamlin	10273, 10259, 10020
Hitachi	10011, 10008, 10003
Houston	10011
Hytex	10007
Hytex	10007
Insight	10476, 10810
Jebsee	10014
Jerrold	10810, 10476, 10276, 10020, 10014, 10012, 10011, 10003
Memorex	10000
Mitsubishi	10003
Motorola	11376, 11254, 11187, 11106, 10810, 10476, 10276, 10014
Multitech	10883
Nova Vision	10008
Novaplex	10008
NSC	10637, 10012
Oak	10007
Pace	11877, 10877, 10237, 10008
Panasonic	10144, 10107, 10008, 10000
Panther	10637
Paragon	10525, 10008, 10000
Penney	10637, 10000
Philips	11305, 10317, 10259
Pioneer	11877, 10877, 10533, 10144
Prism	10012
Pulsar	10040, 10000
Pulser	10040
Quasar	10000
R-Line	10040
RadioShack	10883
RCA	11256
Regal	10279, 10276, 10273, 10259, 10020
Regency	10020
Rembrandt	10040, 10011
Runco	10000

Cable Boxes	
Make	Code
Samsung	10144, 10040, 10003
Scientific Atlanta	11877, 10877, 10477, 10237, 10012, 10008, 10003, 10000
Signal	10040, 10011
Signature	10011
SL Marx	10040
Sony	11006
Sprucer	10144
Starcom	10014, 10003
Stargate	10040, 10014
Storm	10637
Supercable	10276
Supermax	10883
Teleavia	10040
Television	10040
Thomson	11256
Timeless	10040
Tocom	10012
Torx	10003
Toshiba	10000
Tristar	10883
TV86	10040
United Artists	10007
United Cable	10276, 10014, 10011, 10003
US Electronics	10276, 10008, 10003
V2	10883
Videoway	10000
Viewmaster	10883
Vision	10883
Vortex View	10883
Zenith	10899, 10525, 10000

CD Players	
Make	Code
Acoustic Research	30420
Aiwa	30157
Akai	30083
Arcam	30157
Audio Pro	30437
Audio Research	30157
Burmester	30420
Cairn	30157
California Audio Labs	30303, 30029
Cambridge Soundworks	30157
Carver	30437, 30179, 30157
Cary Audio Design	31876
Classic	31297
Curtis Mathes	30032
Denon	30766, 30034, 30003
DKK	30000
DMX Electronics	30157
Fisher	31325, 30179, 30000
Garrard	30420
Genexxa	30032
GPX	31296

Appendix C: Programming the Remote Control, continued

Programming Codes, continued

CD Players	
Make	Code
Grundig	30157
Hafner	30173
Harman/Kardon	31202, 30173, 30157, 30100, 30083
Hitachi	30032
Inkel	30180, 30157
Integra	30101
Jerrold	30003
JVC	31294, 30072, 30032
Kenwood	30626, 30190, 30037, 30029, 30028, 30000
KLH	31711, 31318
Koss	31317
Krell	30157
LG	31208
Linn	30157
LXI	30179
Magnavox	30274, 30157, 30038
Marantz	30626, 30435, 30180, 30157, 30038, 30029
Mark Levinson	31484
Matsui	30157
McIntosh	31703, 30660, 30290, 30256
MCS	30029
Memorex	30468, 30437, 30420, 30179, 30032, 30000
MGA	30083
Micromega	30157
Miro	30000
Mission	30157
Mitsubishi	30098, 30083
Modulaire	30468, 30437, 30420, 30180, 30179, 30145, 30087, 30032, 30000
MTC	30420
Myryad	30157
NAD	31208
NSM	30157
Onkyo	31327, 30101
Optimus	31075, 30468, 30437, 30420, 30179, 30145, 30087, 30037, 30032, 30000
Panasonic	30752, 30388, 30303, 30029
Parasound	30420
Penney	30029
Philips	30626, 30274, 30157
Pioneer	31087, 31062, 30468, 30032
Polk Audio	30157
Primare	31852
Proceed	30420
Proton	30157
QED	30157
Quad	30157
Quasar	30029
RadioShack	31075, 30468, 30437, 30420, 30180, 30179, 30032, 30000

CD Players	
Make	Code
RCA	30032, 30053, 30179, 30420, 30468, 31062
Realistic	30468, 30437, 30420, 30180, 30179, 30145, 30087, 30032, 30000
Revox	30157
Roksan	30435
Rotel	30420, 30157
SAE	30157
Sansui	30157, 30000
Sanyo	30179, 30087, 30000
Sears	30179
Sharp	30180, 30037
Sherwood	31950, 30180
Sonic Frontiers	30157
Sony	31364, 30490, 30185, 30100, 30000
Soundesign	30145
Sugden	30157
Sylvania	30157
Symphonic	30180
TAG McLaren	30157
Tandy	30032
Tascam	30420
TDK	31208
Teac	30490, 30420, 30180
Technics	30029, 30303
Techwood	30303
Thule Audio	30157
Tivoli Audio	31553
Universum	30437
Victor	30072
Wards	30179, 30157, 30087, 30053, 30032
Yamaha	31292, 30490, 30036
Yorx	30000

Laser Disc Players	
Make	Code
Carver	20194, 20064
Denon	20241, 20172, 20059
Harman/Kardon	20194
Magnavox	20241, 20217, 20194, 20064
Marantz	20194, 20064
Mitsubishi	20243, 20241, 20059
NAD	20059
Optimus	20059
Panasonic	20204
Philips	20194, 20064
Pioneer	20241, 20059
Polk Audio	20194
Quasar	20204
Sony	20201, 20193
Technics	20204
Theta Digital	20194
Toshiba	20059
Wards	20059
Yamaha	20217

A/V Receivers	
Make	Code
ADC	30531
Adcom	31617, 31616
Aiwa	31641, 31405, 31388, 31347, 31321, 31243, 30189, 30121
Akai	31255
Alco	31390
AMC	31077
Amplifier Technologies	31584
Anam	31609, 31074
Apex Digital	31774, 31430, 31257
Arcam	31189
Atlantic Technology	31487
Audiophase	31387
Audiotronic	31189
Audiovox	31627, 31390
B & K	30840, 30820, 30702, 30701
Bel Canto Design	31584
BK	30702
Bose	31933, 31253, 31229, 30639
Brix	31602
Cairn	30189
Cambridge Soundworks	31477
Capetronic	30531
Carver	31289, 31189, 30189, 30121
Classe	31920
Clatronic	30797
Coby	31263
Curtis	31263, 30797
Curtis Mathes	30014
Delphi	31414
Denon	31360, 31311, 31306, 31142, 30121
Electrohome	32026
Emerson	30531
Fisher	31801, 31409, 30797
Fosgate	31487
Glory Horse	31263
Goodmans	30797
GPX	31299
Grundig	31387, 30189
Harman/Kardon	31306, 31304, 31289, 30891, 30189, 30110
Hitachi	31801, 31273
Insignia	31077, 31030
Integra	31805, 31320, 31298, 30842, 30135
JBL	31306, 30110
JVC	31811, 31643, 31495, 31374, 31282, 31263, 31058
Kawasaki	31390
Kenwood	31570, 31569, 31363, 31313
KLH	31428, 31390

Appendix C: Programming the Remote Control, continued

Programming Codes, continued

A/V Receivers	
Make	Code
Koss	31497, 31366
Linn	30189
Liquid Video	31497
Magnavox	31514, 31269, 31266, 31189, 30531, 30189
Marantz	31289, 31269, 31189, 30891, 30200, 30189
McIntosh	31289
Micromega	31189, 30189
Mitsubishi	31957, 31922, 31921, 31920, 31393
Myryad	31189
Nakamichi	31555, 31313, 30097
Onkyo	31805, 31320, 31298, 30842, 30135
Optimus	31074, 31023, 30849, 30797, 30670, 30531, 30121, 30014
Oritron	31497, 31366
Outlaw	31487
Panasonic	32967, 31764, 31763, 31633, 31548, 31518, 31509, 31363, 31350, 31316, 31308, 31288, 30309
Philips	31368, 31365, 31283, 31269, 31268, 31266, 31189, 30891, 30189
Pioneer	31384, 31343, 31123, 31023, 30630, 30531, 30150, 30014
Polk Audio	31414, 31289, 30189
Proceed	31922
RadioShack	31609, 31263
RCA	31609, 31511, 31390, 31123, 31074, 31023, 30531
Realistic	31609, 30121
Revox	30189
Rio	31869
Samsung	31500, 31304, 31295
Sangean	32165
Sansui	31189, 30189
Sanyo	31801
Sharp	31386, 31361
Sharper Image	31416, 31411, 31410, 31409, 31385, 31263, 30797
Sherwood	31077
Sirius	31811, 31627, 31602
Sonic Blue	31869
Sony	31858, 31759, 31758, 31658, 31622, 31558, 31529, 31503, 31458, 31441, 31406, 31382, 31371, 31367, 31258, 31131, 31058
Soundesign	30670
Stereophonics	31023
Sunfire	31313
Sylvania	30797

A/V Receivers	
Make	Code
Teac	31528, 31390, 31267, 31074
Technics	31633, 31518, 31308, 30309
Thorens	31189
Toshiba	31788, 31123, 30842, 30135
Venturer	31390, 30849
Wards	30189, 30014
XM	31414, 31406
Yamaha	31815, 31476, 31375, 31331, 31276, 31176, 31023, 30176
YBA	31921

Satellite Receivers	
Make	Code
AlphaStar	10772
Bell ExpressVu	11170, 10775
Chaparral	10216
Crossdigital	11109
DirecTV	11856, 11749, 11640, 11639, 11609, 11444, 11443, 11442, 11414, 11392, 11377, 11142, 11109, 11108, 11076, 10819, 10749, 10724, 10639, 10566, 10392, 10247, 10099
Dish Network System	11775, 11505, 11170, 11005, 10775
Dishpro	11775, 11505, 11005, 10775
Echostar	11775, 11505, 11170, 11005, 10775
Expressvu	11775, 10775
Fortec Star	11821
Funai	11377
GE	10566, 10392
GOI	11775, 10775
Goodmans	11246
Hitachi	11250, 10819, 10749
Houston	10775
HTS	11775, 10775
Hughes Network Systems	11749, 11444, 11443, 11442, 11142, 10749
Humax	11790, 11781
Innova	10099
JVC	11775, 11170, 10775
LG	11414, 11226
Magnavox	10724, 10722
Memorex	10724
Mitsubishi	10749
Motorola	10856
NEC	11270
Netsat	10099
Optimus	10724
Panasonic	10701, 10247
Pansat	11807
Paysat	10724

Satellite Receivers	
Make	Code
Philips	11749, 11442, 11142, 11076, 10819, 10775, 10749, 10724, 10722, 10099
Pioneer	11442, 11142
Proscan	10566, 10392
RadioShack	10775, 10566
RCA	11442, 11392, 11142, 10855, 10775, 10566, 10392, 10143
Samsung	11609, 11442, 11377, 11276, 11142, 11109, 11108
Sanyo	11219
SKY	10856, 10099
Sony	11640, 11639, 10639
Star Trak	10772
Thomson	10566, 10392
Tivo	11444, 11443, 11442, 11142
Toshiba	11749, 10790, 10749
UltimateTV	11640, 11392
Uniden	10724, 10722
Zenith	11856, 11810, 10856

VCRs	
Make	Code
A-Mark	20278, 20240, 20046, 20037, 20000
ABS	21972
Accurian	20000
Admiral	20479, 20209, 20104, 20060, 20048, 20047, 20039
Adventura	20240, 20037, 20000
Adyson	20072
Aiko	20278
Aiwa	20124, 20037, 20000
Akai	20242, 20175, 20041
Alba	20278, 20209, 20072
Alienware	21972
Allegro	20039
America Action	20278
American High	20081, 20035
Amstrad	20000
Asha	20240
Astra	20240, 20035
Audiovox	20278, 20038, 20037
Avis	20072, 20000
Beaumark	20240
Bell & Howell	20479, 20104, 20048, 20046, 20039, 20035, 20000
Broksonic	20479, 20209, 20184, 20121, 20002
Calix	20037
Candle	20037, 20038
Canon	20035
Capehart	20002
Carrera	20240
Carver	20035, 20081

Appendix C: Programming the Remote Control, continued

Programming Codes, continued

VCRs Make	Code
CCE	20072, 20278
Cineral	20278
Citizen	20479, 20278, 20240, 20209, 20037, 20035, 20000
Classic	20037
Colortyme	20278, 20060, 20045, 20035
Colt	20072, 20000
Craig	20240, 20072, 20047, 20037
Criterion	20072, 20000
Crosley	20081, 20035, 20000
Crown	20278, 20072
Curtis Mathes	20432, 20278, 20240, 20162, 20060, 20041, 20035, 20000
Cybernex	20240
CyberPower	21972
Daewoo	20278, 20046, 20045, 20037
Daytron	20278, 20037
Dell	21972
Denon	20081, 20042
Derwent	20041
DirectTV	20739
Dual	20000
Durabrand	20039, 20038
Dynatech	20240, 20000
Electrohome	20240, 20209, 20060, 20043, 20037, 20000
Electroponic	20037
Emerald	20184, 20121
Emerex	20032
Emerson	21593, 20593, 20479, 20278, 20240, 20209, 20184, 20121, 20043, 20037, 20002, 20000
Fisher	20104, 20047, 20046, 20039, 20000
Fuji	20035, 20033
Fujitsu	20000
Funai	21593, 20593, 20278, 20072, 20037, 20000
Garrard	20000
Gateway	21972
GE	20240, 20060, 20048, 20035, 20000
Gemini	20060
Genexxa	20278, 20037, 20000
Go Video	20614, 20526, 20432, 20240
GoldStar	20278, 20039, 20038, 20037, 20035, 20000
Goodmans	20278, 20081, 20072, 20037, 20000
Gradiente	20000
Granada	20081, 20042
Grundig	20081
Harley Davidson	20000
Harman/Kardon	20081, 20075, 20038

VCRs Make	Code
Harvard	20072
Harwood	20072
Headquarter	20046
Hewlett Packard	21972
HI-Q	20047, 20035, 20000
Hitachi	20089, 20045, 20042, 20041, 20037, 20035, 20000
Howard Comput-ers	21972
HP	21972
Hughes Network Systems	20739, 20042
Humax	21988, 21979, 20739
Hush	21972
HYTEK	20072, 20047, 20000
iBUYPOWER	21972
ITT Nokia	20240, 20041
Janeil	20240
Jensen	20067, 20041
JVC	21162, 20067, 20041
KEC	20278, 20037
Kenwood	20067, 20046, 20041, 20038
KLH	20072
Kodak	20037, 20035
KTV	20000
LG	21037, 20240, 20038, 20037
Linksys	21972
Lloyd's	20240, 20072, 20038, 20000
Loewe	20081
Logik	20240, 20072, 20000
Lumatron	20278
Luxor	20046
LXI	20067, 20042, 20037, 20000
M Electronic	20240
Magnasonic	20593, 20278, 20240, 20072, 20037, 20000
Magnavox	21593, 20618, 20593, 20563, 20240, 20081, 20048, 20039, 20037, 20035, 20000
Magnin	20240
Marantz	20081, 20038, 20035
Marta	20037
Matsui	20209, 20037
Matsushita	21162, 20162, 20081, 20035
Media Center PC	21972
MEI	20035
Memorex	21262, 21162, 21037, 20479, 20278, 20240, 20209, 20162, 20104, 20072, 20048, 20047, 20046, 20039, 20037, 20035, 20000
Metz	20037
MGA	20240, 20060, 20043

VCRs Make	Code
MGN Technology	20240
Microsoft	21972
Midland	20240
Mind	21972
Minolta	20042
Mitsubishi	20443, 20242, 20214, 20173, 20075, 20067, 20060, 20048, 20047, 20043, 20042, 20041, 20000
Motorola	20048, 20035
Movie Walker	20072
MTC	20240, 20072, 20000
MTX	20000
Multitech	20072, 20039, 20000
NAD	20240, 20104
NEC	20104, 20067, 20041, 20038
New Tech	20072
Nikko	20278, 20037
Nikkodo	20278, 20037
Nishi	20240
Niveus Media	21972
Noblex	20240
Northgate	21972
Olympus	20162, 20104, 20035
Onkyo	20222
Optimus	21262, 21162, 21062, 21048, 20593, 20432, 20240, 20162, 20104, 20048, 20047, 20037, 20035, 20000
Orion	20479, 20278, 20240, 20209, 20184, 20121, 20104, 20002, 20000
Panama	20035
Panasonic	21262, 21162, 21062, 20616, 20614, 20225, 20162, 20035, 20000
Penney	20240, 20162, 20081, 20067, 20047, 20042, 20038, 20037, 20035, 20000
Pentax	20042
Philco	20479, 20209, 20081, 20035, 20000
Philips	21181, 21081, 20739, 20618, 20616, 20209, 20162, 20081, 20048, 20045, 20035, 20000
Pilot	20037
Pioneer	20162, 20081, 20067, 20042
Polk Audio	20081
Portland	20278
Presidian	21593
Profitronic	20240
Proscan	20060
Protec	20072, 20000
Protech	20072
Pulsar	20278, 20240, 20039

Appendix C: Programming the Remote Control, continued

Programming Codes, continued

VCRs Make	Code
Pulser	20240
Quarter	20046
Quartz	20047, 20046, 20035
Quasar	21162, 20162, 20035, 20002
RadioShack	21162, 21037, 20240, 20162, 20104, 20048, 20047, 20046, 20037, 20035, 20000
Radix	20037
Randex	20037
RCA	20880, 20240, 20060, 20048, 20045, 20042, 20035, 20000
Realistic	21162, 20278, 20240, 20162, 20121, 20104, 20048, 20047, 20046, 20037, 20035, 20000
ReplayTV	20616, 20614
Ricavision	21972
Runco	20039
Salora	20075
Samsung	20739, 20432, 20240, 20060, 20045, 20038, 20000
Samtron	20240
Sanky	20048, 20039
Sansui	20479, 20240, 20209, 20072, 20067, 20041, 20002, 20000
Sanyo	20479, 20240, 20159, 20104, 20047, 20046, 20000
Scott	20184, 20121, 20045, 20043
Sears	20209, 20162, 20104, 20072, 20067, 20060, 20048, 20047, 20046, 20045, 20043, 20042, 20041, 20039, 20037, 20035, 20033, 20000
Sharp	20848, 20048, 20047, 20032, 20000
Shintom	20240, 20072, 20039, 20000
Shogun	20240
Siemens	20037, 20104
Signature	20479, 20060, 20048, 20046, 20037, 20035, 20000
Singer	20240, 20072, 20037
Sonic Blue	20616, 20614
Sonographe	20046
Sony	21972, 21032, 20636, 20067, 20047, 20046, 20035, 20033, 20032, 20000
Soundmaster	20000
Stack 9	21972
STS	20042
SV2000	20072, 20000

VCRs Make	Code
SVA	20000
Sylvania	21593, 20593, 20081, 20043, 20035, 20000
Symphonic	21593, 20593, 20240, 20002, 20000
Systemax	21972
Tagar Systems	21972
Tandy	20104, 20000
Tatung	20081, 20067, 20048, 20041, 20000
Teac	20067, 20041, 20000
Technics	20162, 20037, 20035, 20000
Teknika	20037, 20035, 20000
Telecorder	20240
Telefunken	20041
Tevion	20479
Thomas	20002, 20000
Thomson	20060, 20041
Tisonic	20278
Tivo	20739, 20636, 20618
TMK	20240, 20000
TNIX	20037
Tocom	20240
Toshiba	21988, 21972, 21008, 20240, 20209, 20045, 20043, 20041, 20000
Tosonic	20278
Totevision	20240, 20037
Touch	21972
Trix	20037
Ultra	20278, 20045
Unitech	20240
Vector	20045
Vector Research	20184, 20038
Vextra	20072
Victor	20067, 20041
Video Concepts	20242, 20045
Videomagic	20037
Videosonic	20240, 20072, 20000
Viewsonic	21972
Villain	20000
Voodoo	21972
Wards	20479, 20240, 20081, 20072, 20060, 20048, 20047, 20046, 20045, 20043, 20042, 20041, 20038, 20037, 20035, 20033, 20000
Wharfedale	20593
White	20479, 20278, 20209, 20072, 20000
Westinghouse	20072, 20000
World	20479, 20209, 20002
XR-1000	20240, 20072, 20035, 20000
Yamaha	20041, 20038
Zenith	21139, 20479, 20278, 20209, 20041, 20039, 20037, 20033, 20000
ZT Group	21972

DVD Players Make	Code
3D LAB	20539, 20503
Acoustic Solutions	20730
Accurian	21416, 21072, 20675
Adcom	21094
Afreey	20698
Aiwa	20641
Akai	21089, 20770, 20705, 20695
Alba	20717, 20672
Alco	20790
Allegro	20869
Amphion Media Works	20872
AMW	20872
Apex Digital	21061, 21056, 21020, 20794, 20755, 20717, 20672, 20533
Arrgo	21023
Aspire Digital	21407, 21168
Audiovox	21072, 21041, 20790, 20717
Awa	20730
Axion	21072
B & K	20662, 20655
BBK	21224
Bel Canto Design	21571
Blaupunkt	20717
Blue Parade	20571
Blue Sky	20699, 20695
Brandt	20651
Broksonic	20695
California Audio Labs	20490
Celestial	21020
Centrex	20672
Cinea	20831
CineVision	20876, 20869, 20833
Citizen	22116, 21587, 21277, 21003, 20695
Clairtone	20571
Coby	21351, 21177, 21165, 21107, 21086, 21077, 20852, 20778
Craig	20831
Creative	20539, 20503
Curtis Mathes	21087
CyberHome	21537, 21502, 21129, 21117, 21024, 21023, 20874, 20816
Cytron	20705
Daewoo	21242, 21234, 21172, 21169, 20869, 20833, 20784, 20770, 20705
Dansai	20770
Daytek	20872
Decca	20770
Denon	20634, 20490
Denver	20778
Desay	21407
Digitrex	20672

Appendix C: Programming the Remote Control, continued

Programming Codes, continued

DVD Players	
Make	Code
Disney	21270, 20675
DiViDo	20705
Dual	21085, 21068, 20675
Durabrand	21127
DVD2000	20521
Electrohome	22116, 21003
Emerson	21268, 20675, 20591
Enterprise	20591
Entivo	20539, 20503
Enzer	20770
ESA	21268
Firstline	20651
Fisher	20670
Funai	21334, 21268, 20675
Gateway	21158, 21077, 21073
GE	20815, 20717, 20522
Go Video	21730, 21304, 21158, 21144, 21099, 21075, 21044, 20869, 20833, 20783, 20744, 20741, 20717, 20715, 20573
Go Vision	21072
GoldStar	20869, 20741
Goodmans	20790
GPX	20769, 20699
Gradiente	20651, 20490
Greenhill	20717
Grundig	20705, 20539
Harman/Kardon	20702, 20582
Hello Kitty	20831
Hitachi	20664, 20573
Hiteker	20672
iLo	21348
Initial	20717
Insignia	22095, 21268
Integra	20627, 20571
IRT	20783
Jaton	21078
JBL	20702
JMB	20695
JSI	21423
JVC	21164, 20867, 20623, 20558
jWin	21051, 21049
Kawasaki	20790
Kenwood	20534, 20490
KLH	21149, 21020, 20790, 20717
Kloss	20533
Konka	20721, 20711
Koss	21423, 21061, 20896, 20769, 20651
Lasonic	21173, 20798, 20627
Lecson	21533
Lenoxx	21127
LG	20869, 20741, 20591
LiteOn	21440, 21416, 21158, 21058
Loewe	20741, 20511
Logix	20783
Magnasonic	20675, 20651

DVD Players	
Make	Code
Magnavox	21506, 21268, 20675, 20646, 20539, 20503
Malata	21159, 20782
Marantz	20675, 20539, 20503
McIntosh	21533, 21273
Medion	20651
Memorex	21270, 20831, 20695
Microsoft	22083, 20522
Minato	20752
Mintek	20839, 20717
Mitsubishi	21521, 20521
Momitsu	21082
Mustek	20730
Myryad	20894
NAD	20741
Naiko	20770
Nakamichi	21222
NEC	20869, 20785
Nesa	20717
NexxTech	21402
Nintaus	21051
Norcent	21265, 21107, 21003, 20872
Onkyo	21769, 20627, 20503
Oppo	21525, 21224, 20575
Optimus	20571
OptoMedia Elec- tronics	20896
Oritron	20651
Palsonic	20852, 20672
Panasonic	21762, 21641, 20703, 20571, 20503, 20490
Philco	20675
Philips	22084, 22056, 21354, 21267, 20675, 20646, 20539, 20503
Phonotrend	20699
PianoDisc	21024
Pioneer	21571, 20631, 20571, 20525, 20142
Polaroid	21086, 21061, 21020
Polk Audio	20539
Portland	20770
Presidian	21072, 20675
Proceed	20672
Proscan	20522
Prosonic	20699
ProVision	20778
Qwestar	20651
Radionette	20741
RadioShack	20571
RCA	21769, 20822, 20790, 20717, 20571, 20522
Realistic	20571
Reoc	20752
Revoy	20699
Rio	20869
RJTech	21360
Rotel	21178, 20623
Rowa	20823
Saba	20651

DVD Players	
Make	Code
Sampo	20752, 20698
Samsung	21075, 21044, 20820, 20744, 20573, 20490, 20199
Sansui	20695
Sanyo	21334, 20873, 20695, 20675, 20670
Schneider	20783
Schwaiger	20752
Sensory Science	21158
Sharp	21256, 20752, 20675, 20630
Sharper Image	21117
Sherwood	21077, 21043, 20770, 20633
Shinsonic	20839, 20533
Slim Art	20784
SM Electronic	20730
Sonic Blue	21099, 20869, 20783, 20715, 20573
Sony	21536, 21533, 21516, 21431, 21070, 21033, 20864, 20533
Sungale	21074
SVA	21105, 20860, 20717
Sylvania	21268, 20675
Symphonic	21334, 21268, 20675
TAG McLaren	20894
Tatung	20770
Teac	20790, 20717, 20571
Technics	20703, 20490
Technika	20770
Technosonic	20730
Tevion	20651
Theta Digital	20571
Thomson	20522, 20511
Tivo	21503
Toshiba	21769, 21608, 21515, 21503, 21154, 20695, 20573, 20539, 20503
Tredex	20804, 20803, 20800
Unimax	20770
United	20730
Universum	20591
Urban Concepts	20539, 20503
US Logic	20839
V	21226, 21064
Venturer	20790
Vizio	21226, 21064
Vocopro	21360
Wesder	20699
Xbox	22083, 20522
Yamaha	20545, 20539, 20497, 20490
Yamakawa	20872
Zenith	20869, 20741, 20591, 20503
Zeus	20784
Zoece	21265

Appendix D: Lamp-Cartridge Replacement and Cleaning



CAUTION



BURN DANGER! HOT SURFACES INSIDE!

Touch lamp cartridge handle only. Do not touch lamp or lamp cartridge housing. Keep lamp cartridge horizontal during removal. Do not tilt as glass may come out and cause injury. Replace lamp cartridge only with the same part number 915B403001.

WARNING

THE ACCESS PANEL IS PROVIDED WITH AN INTERLOCK TO REDUCE THE RISK OF EXCESSIVE ULTRAVIOLET RADIATION. DO NOT DEFEAT ITS PURPOSE OR ATTEMPT TO SERVICE WITHOUT REMOVING PANEL COMPLETELY.

CAUTION: If the television is on, press **POWER** to turn it off. **Unplug the television and allow it to cool for at least one hour before attempting to replace the lamp cartridge.**

Lamp Life

The light source for this television is a lamp, which is part of a lamp cartridge assembly. The life of the lamp can vary, based on the lamp itself, the air temperature around the TV while it is operating, the selected lamp mode, and your viewing patterns. Warmer air or poor ventilation shorten the lamp life, as does use of the **Bright** lamp mode and turning the television on and off frequently. Mitsubishi warrants the lamp for one (1) year from the date of original purchase at retail.

To Order a New Lamp

To Receive a Replacement Lamp Under Warranty

Call (800) 553-7278. Please have model number, serial number, and TV purchase date available.

Important: All lamps replaced under warranty must be returned to Mitsubishi where they will be inspected for defect verification.

To Purchase a Replacement Lamp After Warranty

Visit our website at www.mitsuparts.com or call (800) 553-7278. Order the following:

Lamp Part Number 915B403001

Lamp-Substitution Alert

MDEA recommends that you use only genuine Replacement Lamp Assemblies purchased directly from Mitsubishi or a Mitsubishi Authorized Dealer or Mitsubishi Authorized Service Center. MDEA advises that replacement lamps obtained separately from the Lamp Cartridge and/or Lamp Assemblies obtained from unauthorized sellers may be incorrect for your television, may not fit or perform properly and may even damage your television. MDEA can not be responsible for the performance, reliability or safety of any replacement lamps that are obtained from unauthorized sources.

WARNING

- Do not remove the lamp cartridge immediately after turning off the television. You may get burned because the lamp is very hot. Allow the television to cool for at least one hour before replacing the lamp cartridge.
- Do not remove the lamp cartridge except when replacing it. Careless treatment can result in injury or fire.
- Do not touch the lamp glass element. It may be very hot and break, causing injuries or burns.
- Be sure not to insert any metal or flammable object into the lamp cartridge opening, as it may cause fire or electrical shock. If a foreign object is inserted into the opening, unplug the AC cord of the TV and contact your dealer for service.
- Install the lamp cartridge securely. Failure to do so may cause a fire.
- Do not touch the lamp glass elements. Oils from your fingers may cause premature lamp failure.

 = MERCURY

THE LAMP INSIDE THIS PRODUCT CONTAINS MERCURY AND MUST BE RECYCLED OR DISPOSED OF ACCORDING TO LOCAL, STATE OR FEDERAL LAWS. For disposal or recycling information, please contact your local authorities or the Electronic Industries Alliance at www.eiae.org

Appendix D: Lamp-Cartridge Replacement and Cleaning, continued

Lamp-Cartridge Replacement

Removing the Old Lamp Cartridge

1. Turn off TV power and allow the lamp to cool for at least one hour before proceeding.
2. After the lamp has cooled, remove the cover of the lamp compartment, located on the back of the TV. Refer to figures 1 and 2. Use a #2 (large) Phillips screwdriver to loosen the screw securing the cover. Keep the screw and cover for re-installation.
3. With a large Phillips screwdriver, loosen the two shiny screws securing the lamp cartridge until they disengage from the mating threads. These are captive screws and cannot be separated from the lamp cartridge.
4. Fully open the bag supplied with the replacement lamp and set the opened bag aside.
5. Gently grasp the handle of the lamp cartridge and pull the old cartridge straight out. See figure 3.

CAUTION: Do not tilt or rotate the cartridge, as small glass fragments may fall out.

6. Without tilting or putting down the lamp cartridge, insert it into the opened bag. Close the bag while being careful not to let any glass particles fall out.

Installing the New Lamp Cartridge

1. Do not touch the glass parts of the new lamp cartridge. Insert the new cartridge into the TV in the same orientation as the old cartridge. Push on the cartridge housing until it is fully seated.
2. With either your fingers or the screwdriver, gently tighten the two shiny screws. If using a screwdriver, **AVOID OVERTIGHTENING!**
3. Replace the plastic cover and retaining screws.
4. **WASH YOUR HANDS THOROUGHLY, AS THIS LAMP CONTAINS MERCURY.**

Disposal of the Old Lamp Cartridge

Lamp under warranty: All lamps replaced under warranty must be returned to Mitsubishi. Use the return shipping label provided and send to Mitsubishi Digital Electronics, America, 1001 Cherry Drive, Suite 2, Braselton, GA 30517.

IMPORTANT: Lamps found to be without defect will be returned and charged back to the sender.

Lamp no longer under warranty: Contact your local authorities or the Electronic Industries Alliance at www.eiae.org for lamp-disposal or recycling instructions. Do not dispose of the old lamp with common trash.

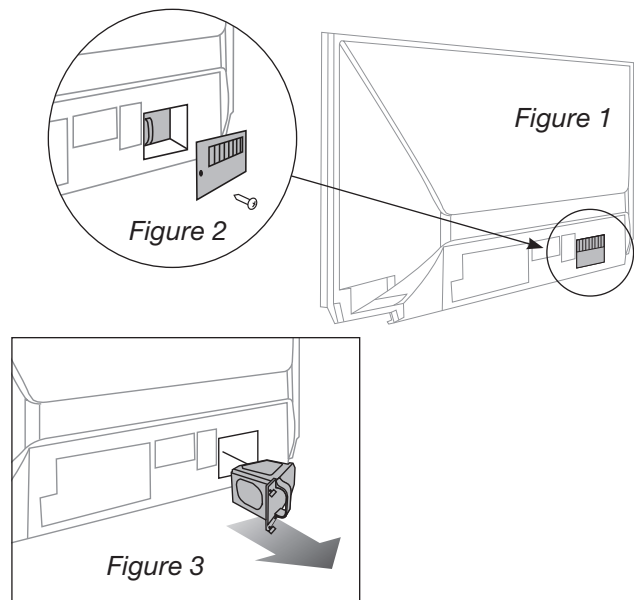

Use only replacement lamp part number 915B403001.

Lamp-Cartridge Filter Cleaning

If the TV shuts off after displaying the message “TV will shut down in a few seconds. Please check if the air flow is blocked ” and/or the **STATUS LED** is yellow, the air filter may need cleaning. The air filter is part of the lamp cartridge. Use the following procedure to clean the filter.

1. Remove the lamp cartridge from the TV as described under “Removing the Old Lamp Cartridge.” Do not tilt or rotate the cartridge. Do not touch the glass parts of the lamp cartridge.
2. Holding the lamp cartridge horizontal (do not tilt or rotate), use a soft dry brush or vacuum cleaner to remove any dust that may be present on the mesh filter. Do not use liquids. See figure 4.
3. Reinstall the lamp cartridge as described under “Installing the New Lamp Cartridge.”

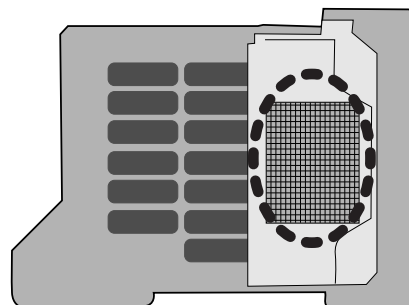

Figure 4
Keep lamp cartridge horizontal and remove dust from the mesh filter using a vacuum cleaner or soft dry brush.

Appendix E: NetCommand HDMI Control of CEC Devices

Many new HDMI devices have a feature called CEC (Consumer Electronics Control) or HDMI Control. Mitsubishi calls this feature NetCommand HDMI Control or NetCommand for HDMI. HDMI CEC allows one device, such as the TV, to control other devices, such as an A/V receiver or disc player. CEC use is optional.

Each manufacturer chooses which CEC functions to support so it is difficult to predict which devices and features are compatible with Mitsubishi's NetCommand for HDMI. You may find that CEC functions for a specific device are limited.

To use CEC, you must enable operation in all three of the following:

- **The TV's Inputs > NetCommand HDMI Control menu.** When off, the TV sends no control signals to CEC devices. NetCommand HDMI control is off by default.
- **The TV's Inputs > Name menu.** You can turn on or off the TV's control signals to individual CEC devices. This option operates only when NetCommand HDMI Control is enabled.
- **The device setup menus.** Most devices with HDMI CEC compatibility let you turn it on or off in the device menu, where it is typically listed as "HDMI Control."

Enabling or Disabling the TV's NetCommand HDMI Control

1. Press **MENU** to display the TV *Main* menu.
2. Highlight **Inputs** using **▲ ▼**.
3. Press **▶** and then **▼** to select **NetCommand HDMI Control** and open the menu shown in figure 1.
4. Use **▲ ▼** to turn NetCommand HDMI Control **On** or **Off**; **Off** shuts off all NetCommand for HDMI signals.

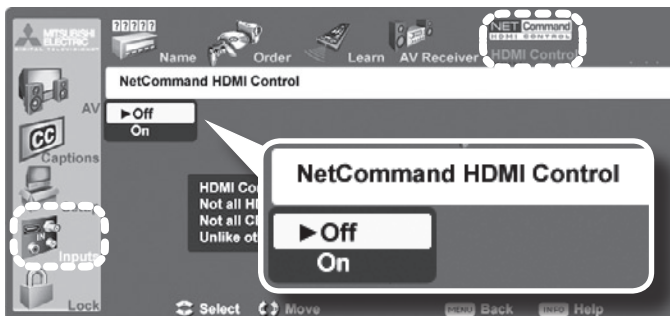

Figure 1. The TV menu *Inputs > NetCommand HDMI Control* lets you set HDMI control either on or off.

Connecting HDMI Devices to the TV

When setting up CEC control:

- Enable the TV's NetCommand HDMI control as described above. NetCommand for HDMI is off by default.
- Connect and set up HDMI devices one at a time.
- First turn on the device and allow the power-on sequence (boot up) to complete. Stop any playback, and then connect the HDMI cable as described next.

1. Turn on the device and allow it to complete the power-on sequence (boot up).
2. Connect the device to one of the TV's HDMI inputs. When the TV detects the connection, the **Auto Input Sensing** screen will appear and provide additional instructions. You will see one of the following screens, depending on your equipment.
 - **Figure 2 (TV recognizes the CEC device).** The TV's NetCommand HDMI Control is on and the device's CEC capability is on. This screen confirms the device is CEC compatible by showing the name provided by CEC. The screen shown in figure 3 may display first before figure 2 appears.

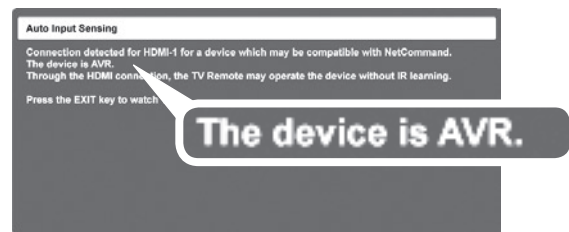

Figure 2. TV recognizes the CEC device. The TV's NetCommand for HDMI is on and the connected device's HDMI Control is also on.

- **Figure 3 ("power on the device").** One of these conditions applies:
 - The TV's NetCommand HDMI Control is turned on, but HDMI control is turned off in the menu of the new device. **Action:** Enable the device's CEC capabilities in the device's setup menus. Within a few minutes you may see the screen in figure 2.
 - The device has not yet been detected (e.g., no power). **Action:** Power on the device.
 - The device does not have CEC compatibility. **Action:** Check the device's setup menus. If there is no HDMI control listed, the device may not be compatible with CEC. Control the device with its own remote control or use the TV's NetCommand IR control.

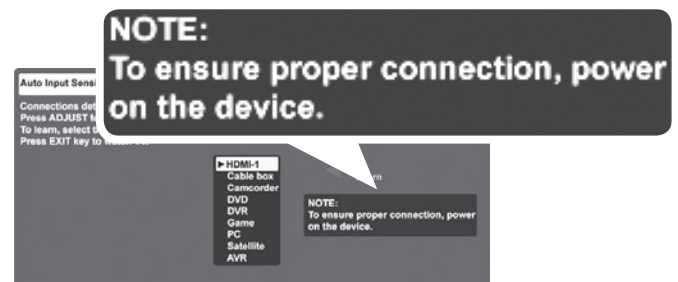

Figure 3. "Power on the device." The TV's NetCommand HDMI Control is on but either the connected device's HDMI Control is off or the device is not CEC compatible

- **Figure 4 (NetCommand HDMI Control is off).** The TV's NetCommand for HDMI Control is turned off.

Action: Follow the instructions in “Enabling or Disabling the TV's NetCommand HDMI Control” on the previous page.

Note: You may not see the screen in figure 2 if the HDMI device has previously been detected by the TV. To check if CEC is enabled for the device, open the **Inputs > Name** menu. If you are unable to change the device name, it indicates CEC is enabled.

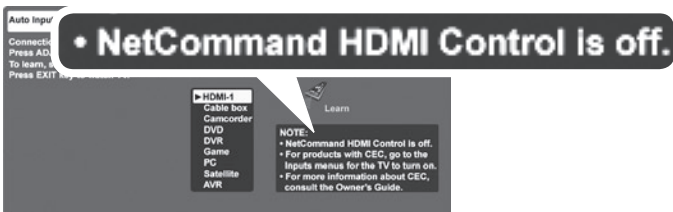
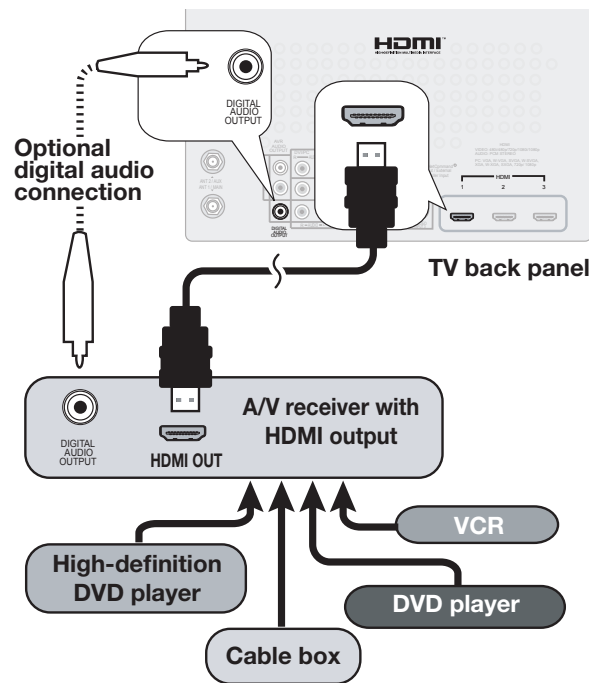

Figure 4. NetCommand HDMI Control is off.

3. With the HDMI CEC device powered on, switch the TV to the device (press the **INPUT** key, highlight the device icon, press **ENTER**). Within a few minutes CEC will be established. You may see the screen shown in figure 2. If the screen does not display, ensure HDMI control is turned on in the device's menus.
4. Once CEC has been established, CEC will automatically name the device. Any name you may have previously selected in figure 3 or figure 4 will be changed to the new name.

NetCommand HDMI Control for an HDMI A/V Receiver and Connected Devices

1. Turn on the TV's NetCommand for HDMI feature. See “Enabling or Disabling the TV's NetCommand HDMI Control” on the previous page.
2. Connect the A/V receiver to the TV before connecting any other device to the A/V receiver.
3. If you want to be able to switch between the A/V receiver speakers and the TV speakers, also connect the TV's **DIGITAL AUDIO OUTPUT** to an input on the A/V receiver.
4. Power on the TV and A/V receiver and allow both to complete the power-on sequence (boot up).
5. Connect the HDMI output of the A/V receiver to the TV's HDMI input. The TV will automatically switch to the input.
6. If the A/V receiver is HDMI CEC compatible, turn on HDMI control in the A/V receiver (see the A/V receiver menus). If the A/V receiver menu does not show HDMI control, the A/V receiver may not be compatible with CEC.



Connecting HDMI devices. The optional digital audio connection allows you to hear audio through the A/V receiver from devices connected to the TV only.

7. Plug in the AC power cord and power on the first HDMI device, such as a disc player, cable box or satellite receiver, and allow the device to complete the power-on sequence (boot up). Stop playback if the device starts playing.
8. Connect the device to the A/V receiver with an HDMI cable.
9. Select the device's HDMI input on the A/V receiver's front panel controls or remote control.
 - If the new device has the HDMI CEC Control feature turned on, the TV will show a display similar to Figure 2 and automatically name the device.
 - If the new device has the HDMI CEC Control feature turned off or if it is not CEC compatible, there will be no display. Check the new device's menu for the HDMI Control feature and turn it on. If there is no HDMI Control feature listed, this device may not be compatible with HDMI CEC and you will need to control the device manually.
10. After the present device has been connected and set up, repeat steps 7 through 9 for the next HDMI device.
11. **736 or 835 Series TV.** If desired, perform NetCommand IR Learning to supplement CEC functions.

Resolving CEC Conflicts, Changing HDMI Connections, Removing HDMI Devices

Because each manufacturer selects which CEC functions to support, some devices can conflict with other devices. If control conflicts arise, you can:

- Turn off CEC in the other device’s setup menu.
- Turn off TV control of an individual CEC device (see figure 5 below).
- Reset TV control of an individual CEC device (see figure 6 below).

Turning Off the TV’s HDMI Control of an Individual CEC Device (Figure 5)

1. Press **MENU** on the TV remote control to enter the TV **Main** menu.
2. Select the **Inputs** menu using the **▲ ▼** keys.
3. Select the **Inputs > Name** menu using the **▶** key.
4. Highlight the device to remove using the **▼** key and then the **▶** key.
5. With the device highlighted, select **Control Off** to turn off the TV’s ability to control the device.
6. Press **EXIT** to clear the menus.

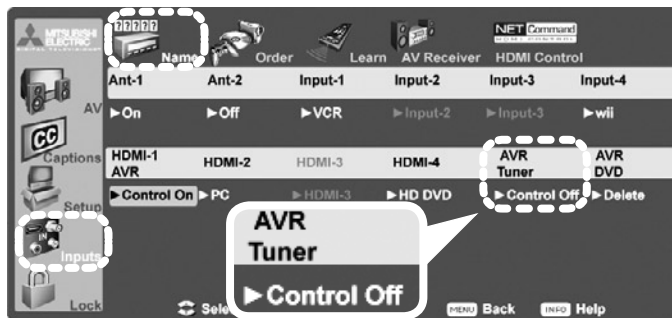

Figure 5. Inputs > Name menu with HDMI Control for AVR Tuner turned off

Resetting HDMI Control or Removing an HDMI Device (Figure 6)

1. Power off the device.
2. If removing the device, disconnect the HDMI cable.
3. Press **MENU** on the TV remote control to enter the TV **Main** menu.
4. Select the **Inputs** menu using the **▲ ▼** keys.
5. Select the **Inputs > Name** menu using the **▶** key.
6. Highlight the device to reset using the **▼** key and then the **▶** key.
7. With the device highlighted, select **Delete** to reset HDMI Control.
8. Press **EXIT** to clear the menus.
If the device is still connected, the **Auto Input Sensing** screen will display.



Figure 6. Inputs > Name menu with AVR DVD deleted.

Using NetCommand HDMI Control

As an example of using NetCommand for HDMI devices, you would press **PLAY** on the device itself to:

- Turn on the TV if not already on
- Switch to the device (no need to display the **Input Selection** menu)
- Begin play of the device

Test your equipment with the TV’s remote control to find out which commands are supported. See the table below for commands that may be available, depending on the individual device.

CEC-enabled VCR, DVD, and DVR functions that may be available:

Record/Playback	Menu Navigation	Channel Tuning	Other
▶	◀ ▶ ▲ ▼	CH ^/▼	GUIDE
● ■	ENTER	Digits 0-9, CANCEL	F1 (content)*
◀ ▶	CANCEL (to cancel)	ENTER	MENU

* The F1 key defaults to work like the device’s **LIST** key.

If you have a CEC-enabled A/V receiver, CEC-enabled devices connected to the A/V receiver with an HDMI cable may also be controllable. They can be selected from the TV’s **Input Selection** menu.

CEC-enabled A/V receiver functions that may be available:

- Try the **VOL**, **MUTE**, and menu-navigation keys.
- To open the A/V receiver menu, follow these steps:
 1. While watching TV, press **AUDIO**.
 2. Press **▲** repeatedly until the **Speakers** option displays.
 3. While **Speakers** is still displayed, press **MENU**.

736 or 835 Series TV. You can use NetCommand IR “learning” to add commands to those supported by CEC. You must first connect and place IR emitters for the devices.

Appendix F: Troubleshooting

TV Reset Comparison Guide

You can resolve many common TV problems using the reset functions described in the following table. See also the troubleshooting suggestions later in this appendix.

IMPORTANT

Before you change sound or picture settings: If picture or sound settings seem wrong for a broadcast

channel (a channel from **ANT 1**, **ANT 2**, a cable box, or satellite receiver), first check other channels from the same input before changing settings. If most other channels from the same input seem correct, there is likely a problem with the broadcast rather than with the TV. Use care in this case, as changes you make to fix problems on individual channels also affect all other channels on the same input.

Reset Name	When to Use	How to Use	Resulting Action
Format	When the picture shape seems incorrect, use FORMAT to change the shape of the picture.	Press the FORMAT key to cycle through the available formats to find the best format for the current picture.	The last-used format for a signal type is memorized for each input. The next time the same input and the same signal type is viewed, the last-used format will be recalled.
PerfectColor™ and PerfectTint™ Reset (for the single input currently being watched)	When the color intensities seem out of balance, use the PerfectColor/PerfectTint reset to reset the color balances to the original factory settings. Both PerfectColor and PerfectTint are reset at the same time.	<ol style="list-style-type: none"> 1. While viewing the input to be reset, press MENU to display the Main menu with the A/V icon highlighted. 2. Use ▶ to highlight PerfectColor and press ENTER to display the PerfectColor adjustment screen. 3. Press CANCEL to reset the colors. 	All PerfectColor/PerfectTint sliders are reset to the original center position. The PerfectColor/PerfectTint settings for other inputs remain unchanged.
A/V Memory Reset (for the single input currently being watched)	When audio and/or video settings for a single input seem incorrect, use A/V Memory Reset to return the input to the original factory settings.	<ol style="list-style-type: none"> 1. While viewing the input to be reset, press MENU to display the Main menu with the A/V icon highlighted. 2. Use ▶ to highlight the Reset icon and press ENTER to reset. 	All Audio and Video settings for the individual input are reset except for the Listen To, Language, audio Balance, and Closed Caption settings.
A/V Reset (for all inputs)	To reset audio and video adjustments for all inputs to the original factory settings.	While viewing the TV, press the control-panel buttons GUIDE and FORMAT at the same time.	All Audio and Video settings are returned to the original factory settings, including Listen To and Language, plus Closed Captions settings and Format settings.
Channel Memorization	To erase and re-memorize channels on ANT 1 or ANT 2 .	<ol style="list-style-type: none"> 1. While viewing the TV, press MENU to display the Main menu. 2. Press ▼ to highlight the Setup icon. 3. Press ▶ to highlight the Scan icon. 4. Press ▼ to highlight the antenna input and reception mode, e.g. Ant 1 Air. 5. Press ▶ to highlight the Start button icon and press ENTER to start the memorization. 	All previously memorized channels for the selected antenna input are erased and a new set of memorized channels is created. All custom settings for Fav, channel names, and channel locks are deleted. To add or delete individual channels, see Edit menu instructions on page 44.
Lock Menu Pass Code	To change your Lock menu pass code	See the cutout page in Appendix B, page 65.	Allows a new code to be established.
Control-Panel Lock Release	To re-enable the control-panel buttons after activation of the Control-Panel Lock	Press and hold the MENU button on the control panel for over eight seconds. This works even if the TV is powered off.	Allows the control panel to be unlocked if the remote control is misplaced.

Appendix F: Troubleshooting, continued

Reset Name	When to Use	How to Use	Resulting Action
System Reset	If the TV does not turn on or off, does not respond to the remote control or control-panel buttons, or has audio but no video.	Press the SYSTEM RESET button on the control panel.	The TV will turn off and the green LED will flash quickly for about one minute. When the green LED stops flashing, you may turn on the TV. The changes you made most recently, before using SYSTEM RESET , may be lost. Changes you made previously, however, are not lost.
TV Reset IMPORTANT: Use this reset only if all other resets have been unsuccessful.	To reset all consumer-accessible settings and all memories to the original factory defaults. CAUTION: All owner-performed setups and adjustments will be erased.	<ol style="list-style-type: none"> 1. While viewing the TV, press MENU to display the TV Main menu. 2. With the Main menu displayed, press number keys 1 2 3 to display the Reset menu. 3. READ THE ON-SCREEN WARNING AND INSTRUCTIONS. <ul style="list-style-type: none"> • If you do not wish to use this reset, press EXIT or MENU to back out. • If you do wish to use the reset, press ENTER to erase all memories and settings. 	The TV will start the initialization process. The TV will then turn off and the front green LED will start flashing. When the LED stops flashing, you can turn the TV on again. The Parental Lock Pass code will remain unaffected, but all other memories and settings outlined in this Owner's Guide will need to be set again.

Service and Customer Support

Service

If you are unable to correct a problem with your TV, consult your Mitsubishi dealer or Mitsubishi Consumer Relations at (800) 332-2119.

- DO NOT adjust any controls other than those described in this Owner's Guide.
- DO NOT remove the protective back cover of your TV.

Customer Support

- To order replacement or additional remote controls, lamp cartridges, or Owner's Guides,

visit our website at www.mitsuparts.com or call (800) 553-7278.

- For questions:
 - ◆ Call Consumer Relations at 800-332-2119.
 - ◆ E-mail: MDEAservice@mdea.com
 - ◆ Website: www.mitsubishi-tv.com

Important

All lamps replaced under warranty must be returned to Mitsubishi where they will be inspected for defect verification.

Appendix F: Troubleshooting, continued

General TV Operation		
	Symptom	Remarks
1.	A fan is running even while the TV is powered off.	The room is too warm. When the TV is off, internal components continue to draw power and must be cooled by the fan.
2.	The fan gets louder after the TV is shut off.	Normal operation. The fan speeds up to cool the lamp quickly after the TV has been shut off.
3.	The TV remote control does not work.	<ul style="list-style-type: none"> • Check that the batteries are fresh and installed correctly. • Check that the slide switch on the remote is set to TV. • Be no more than 20 feet from the TV when using the remote control. • Program the remote control to operate the TV or other device. • Reset the remote control. • If you have a custom home theater controller but prefer to use the TV's remote control, unplug the controller cable from the TV's IR—NetCommand® Output/External Controller Input.
4.	When I try to use the remote control, the POWER key blinks five times.	Replace the batteries.
5.	TV does not respond to the remote control or to control-panel buttons and TV will not power on or off.	<ul style="list-style-type: none"> • Unplug the AC power cord for 10 seconds. • Use the System Reset button.
6.	When a device is selected from the Input Selection menu, the screen is blue or black (no signal source).	<ul style="list-style-type: none"> • Make sure the selected device is turned on. • Begin play of the device.
7.	You have forgotten your Lock menu pass code.	See Appendix B, "Bypassing the Parental Lock," page 65.
8.	Rating restrictions are not working.	<p>Open the Parental Lock menu and:</p> <ul style="list-style-type: none"> • Verify that the U.S. Ratings or Other Ratings setting is On. • Check the Lock Time/Unlock Time to check if rating restrictions are disabled. • Rating restrictions apply only to content on ANT 1 and ANT 2, and VIDEO composite video jacks.
9.	On-screen displays appear each time you change a function.	Normal TV operation.
10.	A warning message appeared on screen stating, "TV will shut down in a few seconds. Please check if the air flow is blocked."	<ul style="list-style-type: none"> • Room temperature has exceeded proper levels. Cool the room. • The TV has overheated. Clear blocked air vents and ensure at least four inches of clearance on all sides of the TV. • Clean the air filter on the lamp cartridge See page 75.
11.	I have turned on CEC for my HDMI devices but control is erratic and I wish to disable it.	<ul style="list-style-type: none"> • Turn off all NetCommand HDMI control signals from the TV. Open the Inputs > NetCommand HDMI Control menu and set to Off (page 48). • Turn off the TV's NetCommand HDMI control for the specific device. Open the Inputs > Name menu, select the device, select Control Off (page 48). • Disable CEC on the device itself. See the device's instructions. • If the problem persists, do the following: <ol style="list-style-type: none"> 1. Disconnect the device from the TV. 2. Open the Inputs > Name menu. Highlight the device and select Delete to remove the device from the Input Selection menu. 3. Reconnect the device to the TV and Auto Input Sensing will recognize the device as a non-CEC device.

Appendix F: Troubleshooting, continued

TV Channels		
	Symptom	Remarks
1.	The TV takes several seconds to respond to channel changes.	<ul style="list-style-type: none"> It is normal for digital channels to take longer to tune in. Press ENTER after entering a channel number to avoid delays. Use a 4-digit number for an over-the-air digital channel. Use a 6-digit number for digital cable channels if your cable service is able to recognize 6-digit channel numbers.
2.	You cannot access a channel.	<ul style="list-style-type: none"> Use number keys instead of CH \wedge/\vee. Be sure the channel you want to view is in memory. See Setup > Scan on page 43. Check that the TV is switched to the correct device or antenna for that channel by pressing the INPUT key. Make sure Channel Lock is off. Make sure the Lock > Parent menu lock is set to off. If you cannot tune to a virtual digital channel even though the TV has already memorized digital channels, tune to the physical channel number used by the broadcaster. The virtual channel will then be automatically added to memory.
3.	Name options are not available for some channels.	You can name only memorized analog channels and memorized digital channels not named by the broadcaster.
4.	When ChannelView list is displayed, information appears incomplete	<ul style="list-style-type: none"> Available information is sent from the broadcaster or cable provider. No other data is available. Make sure the TV clock is set correctly.

TV Power On/Off		
	Symptom	Remarks
1.	TV takes an excessively long time to power on.	<ul style="list-style-type: none"> When switched on, the TV needs time to boot up, just as a computer does. Also, the TV's lamp requires a few moments to heat up to full brightness. TV Energy Mode is set to Low Power. Change TV Energy Mode to Fast Power On in the Setup menu.
2.	You cannot program the TV to turn on automatically (Timer function)	<ul style="list-style-type: none"> The TV may be locked. The clock may not be set. TV Energy Mode is set to Low Power. Change to Fast Power On in Setup menu.
3.	The TV will not turn on after being plugged in.	If light on front panel is blinking, wait at least one and a half minutes for the light to turn off, then press POWER again.
4.	TV turned itself off and the light on the front panel started to blink.	<ul style="list-style-type: none"> Momentary power fluctuation caused the TV to turn off to prevent damage. Wait for the green light to stop flashing and turn the TV on again. If the TV does not stay on, use the System Reset button on the control panel. If this happens frequently, obtain an AC line power conditioner/surge protector. An unusual digital signal may have been received, triggering a protection circuit. Wait for the light to stop flashing and turn TV on.
5.	TV turned itself off and the STATUS light is a steady yellow.	<ul style="list-style-type: none"> The TV has overheated. Clear blocked air vents and ensure at least four inches of clearance on all sides of the TV. Clean the lamp-cartridge air filter. See Appendix D.
6.	TV will not power off.	Use the System Reset button.

Appendix F: Troubleshooting, continued

Picture		
	Symptom	Remarks
1.	Picture does not look like a high-definition picture.	Not all signals are high-definition signals. To receive high-definition programming from your cable or satellite provider, you must subscribe to the provider's high-definition service. Some over-the-air broadcasts are in high-definition and can be received with a high-quality antenna suited to your location.
2.	Picture has become dimmer.	<ul style="list-style-type: none"> • The lamp is nearing the end of its life. Order a new lamp. See Appendix D for ordering information and replacement instructions. • Adjust picture brightness and contrast to maximum levels. • Change Lamp Mode from Standard to Bright.
3.	There is a large black or gray rectangle on the screen.	The TV's analog closed captioning has been set to "text" mode in the Captions menu. Turn off because there is no text information being broadcast.
4.	You cannot view a picture when playing a VHS tape.	Check your VCR's owner's guide for further troubleshooting.
5.	VCR or DVD player's on-screen menus jitter up and down.	Possible cause: Many VCRs and DVD players provide on-screen menus at only half-resolution. These lower-resolution graphics may appear to jitter up and down when the TV converts them to high-definition graphics.
6.	When viewing a stopped VCR, white lines are rolling on the screen.	<ul style="list-style-type: none"> • Turn off video mute for the VCR. • Begin playing the tape. • Change the VCR input to the antenna input.
7.	A color program appears as a black and white image, or the colors are dim, or the screen is black.	The PerfectColor color balance has been incorrectly set. Reset the PerfectColor balance.
8.	Picture from an HDMI input is noisy (poor quality).	Upgrade a Category 1 (unmarked) HDMI cable to a Category 2 high-speed HDMI cable.
9.	The image from a computer appears distorted when viewed on the TV.	Normal TV operation. The TV does not correct distortion in the picture from a computer because the correction process may cause the edges of the image to be cut off.

Appendix F: Troubleshooting, continued

Sound (see also NetCommand troubleshooting for additional help with A/V receiver concerns)		
	Symptom	Remarks
1.	There is no sound even when the volume is turned up.	<ul style="list-style-type: none"> • Check if the MUTE button is on. • The TV's "Listen to:" setting may be set to SAP. • Check that the Speakers option is set to TV to hear sound from the TV speakers. • If using an A/V receiver, check that the Speakers option is set to AV Receiver to hear sound from the A/V receiver speakers. • Perform a System Reset.
2.	The sound does not match the screen picture.	The TV's Listen to: setting may be set to SAP. See page 41.
3.	The sound from my A/V receiver does not match the screen picture (I should hear the correct audio from my A/V receiver).	<ul style="list-style-type: none"> • Check that DIGITAL AUDIO OUTPUT and/or AVR AUDIO OUTPUT on TV's back panel is connected to the A/V receiver. Without this connection, devices connected only to the TV (and not the A/V receiver) can be heard only from the TV speakers. Note that this includes the ANT 1/ANT 2 inputs, a device (such as a camcorder) connected to the front panel, and any other device sending audio to the TV only. • Check A/V receiver input selection in the Inputs > AV Receiver menu. If NetCommand is set up incorrectly for the A/V receiver, see "A/V Receiver Control: Automatic Audio Switching," page 59.
4.	The sound from my A/V receiver does not match the screen picture (my source device should be sending both audio and video through the A/V receiver).	<ul style="list-style-type: none"> • Check A/V receiver input selection in the Inputs > AV Receiver menu. If NetCommand is set up incorrectly for the A/V receiver, see "Setup to Control Automatic Audio and Video Switching via HDMI," page 62. • The TV's Listen to: setting may be set to SAP. See page 41.
5.	Cannot select an audio-only device; it does not appear in the Input Selection Menu.	Plug a video plug into any composite VIDEO jack for the Auto Input Sensing screen to appear. See "Audio-Only Device," page 25.

Indicators		
	Symptom	Remarks
1.	LAMP indicator light is a constant red.	Turn the TV off for at least 2 minutes. Turn it back on. If light is still red, the lamp has failed. Replace it. See Appendix D for lamp replacement information. For questions, please call Mitsubishi Consumer relations at (800) 332-2119.
2.	LAMP indicator light is a flashing yellow.	Lamp cover door is open or lamp cartridge is not secure. See Appendix D for lamp replacement information.
3.	STATUS indicator light is a steady yellow.	<ul style="list-style-type: none"> • Room temperature has exceeded proper levels. Cool the room. • The TV has overheated. Clear blocked air vents and ensure at least four inches of clearance on all sides of the TV. • Clean the air filter on the lamp cartridge. See Appendix D .
4.	STATUS indicator light is a steady/flashing red.	<ul style="list-style-type: none"> • Unplug set from AC power. Plug back in and wait one minute for blinking to stop. • Press SYSTEM RESET button and wait for blinking to stop. • If blinking continues, service is required. Contact your dealer or a Mitsubishi Authorized Service Center to arrange for a service evaluation. Listings of Mitsubishi Authorized Service locations can be obtained from our web site, www.mitsubishi-tv.com or by calling 1-800-332-2119.

Appendix F: Troubleshooting, continued

NetCommand IR Control	
Symptom	Remarks
1. Cannot see the menu from the A/V Receiver.	<ul style="list-style-type: none"> • A/V Receiver Set Up for Audio-Only Switching The A/V Receiver is not connected to any video input of the TV. To check the A/V Receiver menu, temporarily plug into an unused input of the TV, such as Input 3. Exit the Auto Input Sensing screen and select Input 3 from the Input Selection menu. Press MENU. • A/V Receiver Set Up for Audio and Video Switching over HDMI Use the MENU key on the A/V receiver's remote control. • A/V Receiver with NetCommand for HDMI. Press INPUT to open the Input Selection menu. Highlight the A/V receiver icon and press MENU.
2. NetCommand unable to learn specific device keys.	<ul style="list-style-type: none"> • A/V Device does not use IR format for remote control signal. ITT and RF formats cannot be learned. • Room lighting may affect the signal. Have the remotes very close (6 inches or less) to the TV during Learning. • If learning a Mitsubishi remote control, make sure slide switch is not set to TV position. • Some, but not all, device key functions can be learned by NetCommand. For example, POWER and PLAY may be learned, but other functions may not. • The signal from the remote control may not be strong enough. Insert fresh batteries and try Learning again.
3. The A/V receiver is the selected audio source but there is no sound.	<ul style="list-style-type: none"> • A/V Receiver Set Up for Audio-Only Switching <ul style="list-style-type: none"> - Check to see if the A/V Receiver power is turned on. - With A/V receiver power turned on, redisplay the Input Selection menu and press ENTER to allow NetCommand to correctly select the A/V Receiver input. - Incorrect setup in the Inputs > AV Receiver menu. Check the device connection assigned in the AV Receiver menu. • A/V Receiver Set Up for Audio and Video Switching over HDMI <ul style="list-style-type: none"> - Check to see if the A/V Receiver power is turned on. - If the device is connected only to the TV (e.g., on ANT1, ANT 2, or a front panel input), verify that the TV's AUDIO OUTPUT is connected to the A/V receiver. - The A/V receiver is not switching properly because you have not learned the inputs. See "Setting Up NetCommand Control of an A/V Receiver," page 58.
4. There is no sound from the A/V receiver for my DVD player or other surround sound device even though I learned the IR code for the A/V receiver's DVD input or other input. (A/V Receiver Set Up for Audio-Only Switching)	NetCommand A/V receiver setup for the DVD player or digital surround sound device or other device is not switching properly. See chapter 6, "NetCommand IR Control," and perform A/V receiver setup for a digital surround sound device as described under "A/V Receiver Control: Automatic Audio Switching," page 59.

Appendix F: Troubleshooting, continued

NetCommand IR Control		
Symptom	Remarks	
5.	There is no sound or picture from the A/V receiver for my DVD player or other device connected to the A/V receiver; the A/V receiver should be sending video to the TV over an HDMI cable. (A/V Receiver Set Up for Audio and Video Switching over HDMI)	NetCommand A/V receiver setup is not switching audio and video inputs properly. See "Setup to Control Automatic Audio and Video Switching via HDMI," page 62.
6.	I've selected my DVD player or other surround sound device in combination with the TV speakers but hear no sound from the TV speakers.	<ul style="list-style-type: none"> • A/V Receiver Set Up for Audio-Only Switching If you have only an audio connection from the device to the A/V receiver, a physical audio connection from the device to the TV is also required. <ul style="list-style-type: none"> - Connect the left and right audio output from the device to the appropriate TV audio input. Now you can hear audio from the device through either the TV speakers or the A/V receiver. - To switch audio sources, press AUDIO, press ▲ ▼ to show the Speakers option, then press ► to select AV Receiver or TV. • A/V Receiver Set Up for Audio and Video Switching over HDMI With your DVD player connected to the A/V receiver, only video is passed from the A/V receiver to the TV because of copy-protection restrictions on the HDMI signal
7.	I "learned" the RECORD key for my VCR/DVR but when I pressed the RECORD key, the VCR/DVR did not record anything.	Check that the VCR or DVR is receiving a signal directly from your cable box or satellite receiver.

Trademark and License Information

LICENSOR'S SUPPLIERS DO NOT MAKE OR PASS ON TO END USER OR ANY OTHER THIRD PARTY, ANY EXPRESS, IMPLIED OR STATUTORY WARRANTY OR REPRESENTATION ON BEHALF OF SUCH SUPPLIERS, INCLUDING, BUT NOT LIMITED TO THE IMPLIED WARRANTIES OF NON-INFRINGEMENT, TITLE, MERCHANTABILITY OR FITNESS FOR A PARTICULAR PURPOSE.

Digital Light Processing® and DLP® are registered trademarks of Texas Instruments.

FlashFX ProT is a trademark of Datalight, Inc. Datalight® is a registered trademark of Datalight, Inc. Copyright 1989-2008 Datalight, Inc., all rights reserved.

Manufactured under license from Dolby Laboratories. Dolby is a trademark of Dolby Laboratories.

HDMI™ the HDMI logo and High-Definition Multimedia Interface are trademarks or registered trademarks of HDMI Licensing LLC.

The software in this TV is based in part on the work of the Independent JPEG Group, copyright © 1991-1998, Thomas G. Lane, all rights reserved.

The  logo and the words "Simplay™" and "Simplay HD™" are the trademarks of Silicon Image, Inc.

x.v.Color and the **x.v.Color** logo are trademarks of Sony Corporation.

ChannelView™, DeepField™ Imager, Easy Connect™, NetCommand®, PerfectColor™, PerfectTint™, Plush 1080p®, QuickView™, SharpEdge™, Smooth120Hz™ are trademarks of Mitsubishi Digital Electronics America, Inc.

Mitsubishi TV Software

END-USER LICENSE AGREEMENT FOR EMBEDDED SOFTWARE

IMPORTANT – READ CAREFULLY: This License Agreement is a legal agreement between you (either an individual or an entity) and Mitsubishi Digital Electronics America, Inc. (MDEA) for all software pre installed and/or provided along with this television (“Software”). By utilizing this television and Software, you agree to be bound by the terms of this License Agreement.

The Software is protected by United States copyright laws and international treaty provisions, as well as other intellectual property laws and treaties. The Software is licensed, not sold.

1. **LICENSE GRANT.** MDEA grants you a non-exclusive, non-transferable, limited right and license to use one copy of the Software only with the Mitsubishi television model that included this owner’s guide and owned by you.

2. **RIGHTS AND LIMITATIONS.**

Software Not for Resale. You may not resell or otherwise transfer for value the Software, except in conjunction with a sale of the TV that Software has been pre installed.

Prohibition on Reverse Engineering, Decompilation and Disassembly. The Software contains trade secrets or other proprietary material in its human perceivable form and to protect them, you may not reverse engineer, decompile, or disassemble, or otherwise reduce the Software to any human perceivable form, except to the extent that the foregoing restriction is expressly prohibited by applicable law.

Separation of Components. The Software is licensed as a single product. Its component parts may not be separated for use on more than one TV.

No Rental. You may not rent, lease, lend, or sublicense the Software.

Trademarks. This License Agreement does not grant you any rights to any trademarks of MDEA.

3. **VIOLATIONS.** You understand that any use, copying or transfer of the Software, except as permitted pursuant to this License, may subject you to serious criminal and civil penalties including damages and an award to MDEA of attorneys’ fees in connection with any violation of this License. You further understand that you may be held legally responsible for any copyright infringement or other violation of intellectual property rights that is caused, encouraged, or induced by your failure to abide by the terms of the License. This license is effective until terminated, and will terminate immediately without notice from MDEA or judicial resolution if you fail to comply with any provision of this License.

4. **COPYRIGHT.** All title and intellectual property rights in and to the Software (including but not limited to any images, photographs, animations, video, audio, music, text, and “applets” incorporated into the Software), and any accompanying printed materials are owned by or licensed to MDEA. All title and intellectual property rights in and to the content which may be accessed through use of the Software is the property of the respective content owner and may be protected by applicable copyright or other intellectual property laws and treaties. This License Agreement grants you no rights to use such content, except that you own the media on which the Software is recorded, but MDEA and its licensors retain ownership of the Software itself. All rights not expressly granted are reserved by MDEA.

5. **EXPORT RESTRICTIONS.** MDEA is licensing the Software for use within the United States. You agree that you will not export or re-export the Software. You specifically agree not to export or re-export the Software: (i) to any country to which the U.S. has embargoed or restricted the export of goods or services, which currently include, but are not necessarily limited to Cuba, Iran, Iraq, Libya, North Korea, Sudan, and Syria, or to any national of any such country, wherever located, who intends to transmit or transport the Software back to such country; (ii) to any person or entity who you know or have reason to know will utilize the Software in the design, development, or production of nuclear, chemical, or biological weapons; or (iii) to any person or entity who has been prohibited from participating in U.S. export transactions by any federal agency of the U.S. government. You warrant and represent that neither the BXA nor any other U.S. federal agency has suspended, revoked, or denied your export privileges.

6. **DISCLAIMER OF WARRANTY. EXCEPT AS OTHERWISE PROVIDED IN THIS LICENSE OR IN THE LIMITED WARRANTY APPLICABLE TO THE TV, MDEA MAKES NO OTHER WARRANTIES OF ANY KIND WHATSOEVER REGARDING THE SOFTWARE AND HEREBY EXPRESSLY DISCLAIMS ALL WARRANTIES OF ANY KIND WHATSOEVER, EXPRESS OR IMPLIED, WITH RESPECT TO THE SOFTWARE. ALL IMPLIED WARRANTIES, INCLUDING, WITHOUT LIMITATION, THE IMPLIED WARRANTIES OF MERCHANTABILITY AND FITNESS FOR A PARTICULAR PURPOSE ARE HEREBY EXPRESSLY DISCLAIMED BY MDEA. IN NO EVENT SHALL MDEA BE LIABLE TO YOU OR ANY THIRD PARTIES, IN CONTRACT, IN TORT OR OTHERWISE, FOR ANY DIRECT, INDIRECT, SPECIAL, INCIDENTAL OR CONSEQUENTIAL DAMAGES OF ANY KIND OR NATURE. BECAUSE SOME JURISDICTIONS DO NOT ALLOW THE EXCLUSION OR LIMITATION OF IMPLIED WARRANTIES, THE ABOVE LIMITATION MAY NOT APPLY TO YOU.**

7. **LIMITATION OF LIABILITY. MDEA SHALL NOT, UNDER ANY CIRCUMSTANCES BE LIABLE TO YOU OR ANY THIRD PARTIES FOR ANY DAMAGES OF ANY NATURE, WHETHER INDIRECT, SPECIAL, INCIDENTAL, CONSEQUENTIAL OR OTHERWISE, INCLUDING, BUT NOT LIMITED TO, ANY CLAIMS FOR LOST PROFITS, LOSS OF GOOD WILL OR EXPENDITURES MADE OR COMMITTED FOR IN RELIANCE ON THE CONTINUATION OF THIS LICENSE. YOU AGREE THAT NEITHER MDEA’S BREACH OF THIS LICENSE NOR ITS FAILURE TO REPAIR A DEFECT, ERROR OR BUG SHALL CONSTITUTE A FAILURE OF THE ESSENTIAL PURPOSE OF THIS LICENSE. BECAUSE SOME JURISDICTIONS DO NOT ALLOW THE EXCLUSION OR LIMITATION OF LIABILITY FOR CONSEQUENTIAL OR INCIDENTAL DAMAGES, THE ABOVE LIMITATIONS MAY NOT APPLY TO YOU. MDEA’s liability to you for direct damages for any cause whatsoever and regardless of the form of the action, will be limited to the money paid by you for the TV (based on fair market value of the TV) that caused the damages.**

8. **GENERAL.** This License Agreement will be governed by the laws of the State of California.

WARNING: This product contains chemicals known to the State of California to cause cancer and/or birth defects or other reproductive harm.

Mitsubishi DLP Projection Television Limited Warranty

MITSUBISHI DIGITAL ELECTRONICS AMERICA, INC. (“MDEA”) warrants as follows to the original purchaser of this television from an authorized MITSUBISHI Audio/Video Dealer, should it prove defective by reason of against defects arising from improper workmanship and/or material:

a. Parts. The lenticular (i.e. front picture) screen is warranted against defects in materials and workmanship for a period of thirty (30) days from the date of the original purchase at retail. The lamp and all other parts (except any software incorporated into this television) are warranted for a period of one (1) year from the date of the original purchase at retail. We will repair or replace, at our option, any defective part without charge for the part. Parts used for replacement may be replaced with those of like kind and quality and may be new or remanufactured. Parts used for replacement are warranted for the remainder of the original warranty period.

b. Embedded Software. MDEA warrants that all software incorporated into this television set (the “Embedded Software”) will perform in accordance with the functional description of Embedded Software in all material respects, but MDEA does not warrant that the Embedded Software is error-free. MDEA also does not warrant that the Embedded Software will be compatible under IEEE 1394 AV/C and HAVi software standards with products produced by any other manufacturer. The limited warranty contained in this section shall continue for a period of one (1) year from the date of the original purchase at retail. If, after prompt notice within the warranty period, MDEA determines that the Embedded Software has failed to perform in accordance with such functional description in all material respects and if such failure is not due to accident, misuse, modification or misapplication of the Embedded Software, then MDEA shall modify or replace the nonconforming Embedded Software at no charge to you, which at MDEA’s sole discretion may be fulfilled by means of modification or replacement software contained on a replacement memory card for Customer installation. The foregoing shall be MDEA’s sole obligation to you under this limited warranty. All rights under this limited warranty on the Embedded Software also subject to your acceptance of and compliance with the terms of the Software License Agreement applicable to this television, and this limited warranty on the Embedded Software shall be null and void if the Embedded Software is modified or changed in any manner except as specifically authorized by MDEA.

c. Labor. For thirty (30) days after the original purchase at retail, we will repair or replace, at our option, the lenticular screen if it proves defective. For certain items that are designed to be replaced by the consumer, including (but not limited to) some Embedded Software, the consumer is solely responsible for any replacement labor. For all other parts, we will provide the labor for a warranty repair by an authorized MITSUBISHI service center without charge for one (1) year from the original date of purchase at retail.

d. Notice. To obtain warranty service, you must notify an authorized MITSUBISHI service center of any defect within the applicable warranty time period.

e. This DLP Projection Television uses a single DLP chip to create the screen image. This technology creates the image using small dots, or picture elements (pixels). Your DLP Projection TV is manufactured to a high level of performance and quality, in fact, 99.99% perfect in the number of properly functioning pixels. As in other display technology, sometimes a pixel is continuously active, inactive or the incorrect color. Our standard is clear; MDEA warrants only that the percentage of properly functioning pixels will be not less than 99.99% of all pixels.

BEFORE REQUESTING SERVICE, please review the instruction booklet to insure proper installation and correct customer control adjustment. If the problem persists please arrange for warranty service.

1. TO OBTAIN WARRANTY SERVICE:

a. Contact your nearest authorized MITSUBISHI service center, whose name and address can be obtained from your MITSUBISHI dealer, by writing at the address provided below, calling MDEA at the 800-332-2119, or by using the support feature of our website at www.Mitsubishi-tv.com.

b. Warranty service will be provided in your home or, if required, at an authorized service shop, provided that your television is located within the geographic territory customarily covered by an authorized MITSUBISHI service center. If not, you must either deliver your television to an authorized service location at your own expense, or pay for any travel and/or transportation costs the service center may charge to and from your home. Actual service labor will be provided without charge.

c. Proof of purchase date from an authorized MITSUBISHI dealer is required when requesting warranty service. Present your sales receipt or other document which establishes proof and date of purchase. THE RETURN OF THE OWNER REGISTRATION CARD IS NOT A CONDITION OF COVERAGE UNDER THIS LIMITED WARRANTY. However, please return the Owner Registration Card so that we can contact you should a question of safety arise which could affect you.

d. To obtain a replacement lamp, order the lamp directly from the MDEA Parts Department at (800) 553-7278.

2. THIS LIMITED WARRANTY DOES NOT COVER:

a. Up to .01% pixel outages (small dot picture elements that are dark or incorrectly illuminated).

b. Damage to the lenticular screen or Fresnel lens, screen frame, cosmetic damage or to any other damage where such damage is caused by unauthorized modification, alteration, repairs to or service of the product by anyone other than an authorized MITSUBISHI service center; physical abuse to or misuse of the product (including any failure to carry out any maintenance as described in the Owner's Guide including air vent cleaning or any product damaged by excessive physical or electrical stress); any products that have had a serial number or any part thereof altered, defaced or removed; product use in any manner contrary to the Owner's Guide; freight damage; or any damage caused by acts of God or other factors beyond the reasonable control of MDEA, such as power surge damage caused by electrical system or lightning. This limited warranty also excludes service calls where no defect in the product covered under this warranty is found, service calls related to unsatisfactory audio or visual reception or signal unless caused by a defect in the product that is covered under this limited warranty, all costs, expenses or any other damages arising from product installation, or set-ups, any adjustments of user controls (including contrast, brightness, color, tint, fine tuning, sharpness), other adjustment necessary to prepare the unit for display or use, connection with any external audio receiver, antenna, cable or satellite systems, or service of products purchased or serviced outside the U.S.A. Please consult the operating instructions contained in the Owner's Guide furnished with the product for information regarding user controls.

3. ANY EXPRESS WARRANTY NOT PROVIDED HEREIN, AND ANY REMEDY WHICH, BUT FOR THIS PROVISION, MIGHT ARISE BY IMPLICATION OR OPERATION OF LAW, IS HEREBY EXCLUDED AND DISCLAIMED. THE IMPLIED WARRANTIES OF MERCHANTABILITY AND OF FITNESS FOR ANY PARTICULAR PURPOSE ARE EXPRESSLY LIMITED TO A TERM OF ONE YEAR.

4. UNDER NO CIRCUMSTANCES SHALL MDEA BE LIABLE TO PURCHASER OR ANY OTHER PERSON FOR ANY INCIDENTAL, SPECIAL OR CONSEQUENTIAL DAMAGES, WHETHER ARISING OUT OF BREACH OF WARRANTY, BREACH OF CONTRACT, OR OTHERWISE.

5. Some states do not allow limitations on how long an implied warranty lasts, or the exclusion or limitation of incidental, special, or consequential damages, so the above limitations or exclusions may not apply to you.

6. This limited warranty gives you specific legal rights, and you may also have other rights which vary from state to state.

7. In the event of any dispute under this limited warranty, jurisdiction and venue for resolving that dispute will be in the state where the television was purchased and the laws of such state will govern.



MITSUBISHI DIGITAL ELECTRONICS AMERICA, INC.
9351 Jeronimo Road
Irvine, CA 92618-1904

Index

A

- Adjust Keys (Up/Down/Left/Right) 27, 36
- Anamorphic Picture Format 32
- Antenna
 - Connecting 21
 - Signal Strength for Digital Channels 30
- Antenna Inputs (ANT 1, ANT 2) 9
- Audio Lock (A/V receiver control) 68
- Audio Output Jacks 9
- Auto Input Sensing 13
- Auto-Off (Sleep Timer) 26
- Auto-On (Timer) 46
- A/V Memory Reset 80
- A/V Receiver
 - and TV Speakers 41
 - and TV's Remote Control 58, 62, 67
 - Audio Lock 68
 - Connecting 9, 24
 - Controlling Sound Volume 15
 - Disconnecting Analog 14
 - NetCommand IR Control 52, 56, 58
 - Controlling a Device Connected to the A/V Receiver 16, 63
 - Video and Audio Switching via HDMI 62
- A/V Reset 7, 80

B

- Back Panel (described) 9, 10
- Batteries 11
- Blue Glow 38
- Bright (Lamp Mode) 47
- Brightness (picture adjustment) 39

C

- Cable Box
 - and TV's Remote Control 28, 67
 - Connecting 19, 20, 22, 23
- Camcorder 25
- Captions Menu 42
- CEC (Consumer Electronics Control) 6, 16, 67
 - A/V Receiver 15, 78, 86
 - CEC-Enabled Devices and the Inputs Name menu 48
 - Disabling CEC for a Device 48
 - NetCommand for HDMI/CEC 77
 - Troubleshooting 82
- Channels
 - antennaweb.org 43
 - Changing Channels 26
 - Channel Lock 44

- Digital Channel Numbers 64
- Edit Channels (menu) 44
- Favorites (Fav) 31, 44
- Memorizing 13
- Naming 44
- Physical/Virtual Channel Numbers 43, 44
- Scan (memorize) 43
- Status Display 30
- Troubleshooting 83
- ChannelView™ Channel Listings 29
- Cleaning 4
- Clock, Set Date and Time 45
- Closed Captions 42
- Color Adjustments 37, 39
 - Reset Color 37, 80
- Computer
 - and Display Formats 18, 64
 - Connecting 17
- Contrast 39
- Control Panel 7
- Control Panel Lock 51
- Customer Service and Support 81

D

- Date. *See* Clock
- Defaults, Resetting 80
- DIGITAL AUDIO OUT 9
- Dolby Digital 9, 24, 59, 64
- DVD Player
 - and TV's Remote Control 28, 67
 - Connecting 20
- DVI Device, Connecting 20

E

- Edit Menu (channels) 44
- Energy Mode 47
- External Controller Input and Setup 10

F

- F1–F4 Keys 28, 54
- Fan Noise 4, 47
- Fast Power On 47
- FAV (Favorite Channels) 31, 44
- Film Mode 38
- Filter, Air (on lamp cartridge) 76
- Font (digital closed captions) 42
- FORMAT Key 32
- Freeze Picture 28
- Front Panel 7
 - Blue Glow 38
 - Controls 7
 - Front-Panel Indicators (lights) 8

G

- Game
 - 3D Video 35
 - Game as Input Name 48
 - Game Picture Mode 39
 - HDMI Cables for Games 10
- Global Menu 38
- GUIDE Key 27, 67
 - ChannelView 29

H

- HD (High-Definition) Signal) 32
- HDMI
 - Changing Out an HDMI Device and Auto Input Sensing 14
 - Connecting an HDMI Device 20
 - A/V Receiver 24
 - HDMI Cable Categories 10
 - HDMI Jack 10
 - NetCommand for HDMI Devices 6, 67, 79, 86
 - Removing an HDMI Device from the Input Selection Menu 48

I

- INFO Key
 - ChannelView 29
 - in TV Menus 36
 - USB Photo Menu 33
- Input Selection Menu
 - Choose Viewing Source 26
 - Disconnected HDMI Device 14, 48, 79
 - Icon Order 48
 - INPUT Key 27
- Inputs Menu 48
 - Inputs > Name Menu and CEC Devices 79
- IR (infrared) Emitter Placement 53
- IR NetCommand Output (jack) 10

J

- JPEG Photo Files 33

L

- Lamp Cartridge Replacement 75
- LAMP Indicator 8
- Lamp Mode 47
- Language
 - in Digital Programs 41
 - SAP (Second Audio Program) 41
- Language Menu 43
- Learn 48. *See also* NetCommand IR Control
- Learn Menu 48
- LED Indicator Lights 8
 - Troubleshooting 85
- Letter Box Image Display 32

- Level Sound 41
- Light, Decorative 38
- Listen To 41
- Listings 29
- Lock Menu. *See* Lock TV
- Lock TV
 - Bypassing the Lock 65
 - Lock by Channel 44
 - Lock by Ratings 50
 - Lock by Time 51
 - Lock Control Panel 51
 - Preset V-Chip Blocking 49
- Low Power (Energy Mode) 47
 - Wired IR option 10
- M**
- Media Setup Menu 34
- Memorizing Channels 13
 - Add Single Channel to Memory 43, 44
- Memory Reset, A/V 80
- Mute
 - Closed Captions 42
 - MUTE key 27
 - Video Mute 38
- N**
- Name (Inputs > Name menu) 48
- NetCommand for HDMI Devices 6, 67, 77, 79
- NetCommand IR Control
 - About 52
 - A/V Receiver Control 58
 - Compared to Programming the Remote Control 67
 - Initial Setup for Most Devices 54
 - Operating 56, 57
 - Specialized Device Keys 55
 - Troubleshooting 86
- Noise, Video 39
- O**
- 120 Hz Picture Processing 38
- Order Menu (Inputs > Order) 48
- P**
- Parent Menu 50
- Pass Code
 - Resetting 65
 - Setting 49
- PAUSE Key 28
- PerfectColor 37
- PerfectTint 37
- Photo Viewing 34
- Picture
 - AV Menu Controls 37
 - Picture Quality and Film Mode 38
 - Troubleshooting 84
- Picture Mode 39
- Power Consumption
 - Energy Mode 47
 - Specifications 64
- Power On/Off 11, 26
 - Troubleshooting 83
- POWER/TIMER Indicator 8
- Q**
- QV Key (QuickView™) 27
 - and FAV Key 31
- R**
- Ratings (TV and Movie) 50
- Remote Control
 - Keys and Functions 27, 28
 - Programming Codes (reference chart) 69
 - Programming, Compared to NetCommand “Learning” 67
 - Programming Instructions 68
 - Reset 28
- Reset
 - AV Menu Reset (by input) 37
 - A/V Reset (all settings) 7
 - Color 80
 - Pass Code 65
 - Remote Control 28
 - Remote Control Audio Lock 68
 - System Reset 7
 - TV Reset Comparison Guide 80
- S**
- Safety Instructions 5
- SAP (second audio program) 41
- Satellite Receiver
 - and the Remote Control 67
 - Connecting 19, 20, 22
- Scan (memorize channels) 43
- Screen Saver 38
- SD (Standard-Definition Signal) 32
- Signal Definitions 32
- Signal Strength Indicator 30
- Sleep Timer 26
- Smooth 120Hz 38
- Sound
 - Audio Menu 41
 - Controlling A/V Receiver Volume 58, 62
 - Level Sound 41
- Sound Mode (audio effects) 41
- Speakers Option
 - In Audio Menu 41
- Specifications, TV 64
- Standard-Definition Signal 32
- Standard (Lamp Mode) 47
- Stand Part Number 4
- Status Display 30
- STATUS Indicator 8
- Stereo System. *See* A/V Receiver
- Surround Sound 9, 24, 60, 61
 - Simulated Surround Sound 41
- System Reset 7, 81
- T**
- Test Picture 38
- 3D GLASSES EMITTER Jack 10
- 3D Video 35, 47
- Time. *See* Clock
- Timer (auto-on) 46
- TIMER Indicator (POWER/TIMER) 8
- Time Zone. *See* Clock
- Troubleshooting 80
- V**
- V-Chip Ratings
 - Applying Restrictions 49
 - Definitions 50
 - In Status Display 30
- VCR
 - Connecting 22, 23
 - Troubleshooting 84
- Vert Adjustment 40
- Video from a Digital Camera 34
- Video Game. *See* Game
- Video Menu 39
- Video Mute 38
- Video Noise 39
- Viewing Device. *See* Input Selection
 - Menu
- W**
- Wall Outlet Cable 21
- X**
- x.v.Color 10, 20, 39



Website:
www.mitsubishi-tv.com

E-mail:
MDEAservice@mdea.com

**For questions, call Consumer Relations at
800-332-2119**

**To order replacement or additional
remote controls, lamp cartridges, or Owner's Guides**

Visit our website www.mitsuparts.com

or call

800-553-7278

SYSTEM RESET

If the TV does not respond to the remote control, control-panel buttons, or will not power on/off, press the **SYSTEM RESET** button on the control panel.

The green LED will flash quickly for about one minute. When the green LED stops flashing, you may turn on the TV. Settings changes you made most recently, before using **SYSTEM RESET**, may be lost.