

myprojectorlamps.com

**The most trusted, dependable name
in projector lamp sales.**



<http://www.myprojectorlamps.com>



<http://www.myprojectorlamps.ca>



<http://www.myprojectorlamps.eu>

The following projector manual has not been modified or altered in any way.



PROJECTION TELEVISION

MODELS

WD-52526

WD-62526

OWNER'S GUIDE



For Your Records

Record the model number, serial number, and purchase date of your TV. The model and serial numbers are on the back of the TV. Refer to this page when requesting assistance with this product.

MODEL NUMBER (check one):

WD-52526

WD-62526

SERIAL NUMBER _____

PURCHASE DATE _____

Retailer Information

RETAILER NAME _____

LOCATION _____

Our Thanks...

Thank you for choosing Mitsubishi as your premier Home Entertainment provider

This Owner's Guide describes the features and functions of your Mitsubishi widescreen, high-definition TV. We urge you to examine this Owner's Guide to become familiar with the innovative features and operations this unique television offers.

Whether this is your first Mitsubishi electronic product, or an addition to your Mitsubishi collection, we believe you and your family will continue to enjoy your Mitsubishi home theater for many years.

Thank you,

Mitsubishi Digital Electronics America, Inc.

Contents

Important Information About Your TV

Guidelines for Setting Up and Using Your New Widescreen TV	6
General Warnings and Cautions, Notes on Installation and Operation	8
Important Safeguards	10
FCC Compliance	12

Chapter 1: Television Overview

Special Features of Your TV	14
Package Contents	14
TV Front Panel	15
Remote Control	18
TV Back Panel	20

Chapter 2: Connecting

HDTV Cable Box or Satellite Receiver with Component Video	24
Standard Cable Box, Satellite Receiver, or Other Device with S-Video	24
Wall Outlet Cable	25
Older Cable Box	25
Antenna with a Single Lead	26
Antennas with Separate UHF and VHF Leads	26
VCR and an Antenna or Wall Outlet Cable (Audio & Video)	27
VCR and a Cable Box (Audio and Video Direct Connections)	28
A/V Receiver (Stereo or Surround Sound Audio System)	29
DVD Player with Component Video	29
HDMI Device	30
DVI Device	30

Chapter 3: TV Operation

Choosing a Program Source (Device Selection Menu)	32
ChannelView™ Channel Listings	32
On-Screen Information	33
Operation of PIP and POP	34
TV Display Formats	36

Chapter 4: TV Menu Operations

3D Graphical ▶ViewPoint® Menu System	40
Main Menu	41
Setup Menu	42
Input Name Menu	44
Icon Order Menu	44
Channel Menu	45
Captions Menu	47
V-Chip Lock Menu	49
Audio/Video Menu	53
Audio Settings	54
Video Settings	55

Appendices

Appendix A: Bypassing the V-Chip Lock	59
Appendix B: Remote Control Programming	61
Appendix C: Specifications	64
Appendix D: General Cleaning	66
Appendix E: Filter Cleaning	67
Appendix F: Lamp Cartridge Replacement	68
Appendix G: Troubleshooting	70
System Reset Button	72
TV Reset Menu	72
Demo Mode	72
Service and Support	72

Trademark and License Information	73
--	-----------

Mitsubishi LCD Rear Projection Television Limited Warranty	75
---	-----------

Index	77
--------------------	-----------

Guidelines for Setting Up and Using Your New Widescreen TV

First Steps

- 1** Read the section entitled “Important Information About Your TV” on the following pages.
- 2** Choose a location for your TV.
 - Allow for air circulation around the TV to help prevent overheating.
 - Avoid locations where light may reflect off the screen.
 - If using a stand, see the stand requirements on pages 8 and 10.
- 3** Connect your other A/V devices to the TV. See **Chapter 2, “Connecting,”** for recommendations.
- 4** Install the batteries in the remote control. See **pages 18 and 19** for information on use and care of the remote control.
- 5** To program the remote control to operate your other A/V devices, see **Appendix B**.
- 6** Plug in your TV and connected devices to a power outlet. The POWER indicator on the front of the TV will start blinking rapidly.
- 7** After the indicator stops blinking, press the POWER key to power on the TV.
- 8** When the Welcome screen appears the first time you power on the TV, select a language for TV menus. You can later change the language through the **Setup menu**.
- 9** This TV has a demo mode for use in retail stores. To turn off the demo mode:
 1. Press TV MENU.
 2. When the menu appears, press the following buttons in sequence: **0, QV, 0**
- 10** You can now start watching TV or you can perform additional setup and customization through the TV menus.

TV Operation

- 11** Review **Chapter 3, “TV Operation,”** for TV features including:
 - **Device Selection (viewing source).** Select a connected device to watch, such as a VCR, DVD player, or antenna. Press DEVICE on the remote control to select from icons for the TV inputs or from the device names you assigned in the Input

Name screen described above. See “**Device Selection Menu.**”

- **Channel Listings.** Press GUIDE to view ChannelView™ channel listings. See “**ChannelView™ Channel Guide.**”
- **Picture Formats.** Press FORMAT to cycle through the available picture sizes and shapes to find the one best suited to the program you’re watching. See “**TV Display Formats.**”
- **PIP/POP.** Press PIP/POP, PIP DEVICE, and PIP CH to use the PIP/POP feature (Picture in Picture/Picture outside Picture). See “**Operation of PIP and POP.**”

Additional TV Setup

- 12** Review **Chapter 4, “TV Menu Operations,”** to become familiar with how you can customize TV operation. Press the TV MENU key to enter the menu system. Some examples of what is available are:
 - **Memorize Channels.** Mitsubishi recommends you memorize channels if you plan to watch over-the-air channels or programming over direct cable. Channel memorization may take up to 15 minutes to complete. See “**Setup Menu.**”
 - **Input Name.** Assign device names to the TV inputs. Doing this makes them easier to identify when you change program sources in the Device Selection menu. See “**Input Name Menu.**”
 - **Icon Order.** Rearrange the device icons in the Device Selection menu. See “**Icon Order Menu.**”
 - **SuperQuickview™.** Create lists of your favorite channels so you can find them quickly. See “**Channel Menu.**”
 - **Signal Strength.** View a graphical signal-strength indicator for digital channels to help you make antenna adjustments for best reception. See “**Channel Menu.**”
 - **Clock.** If you wish to use the Timer feature, you must first set the TV clock to the correct time. This can be done either manually or automatically. See “**Setup Menu.**”
 - **TV Locks.** You can restrict TV viewing by program rating or by time of day. You can also disable the front-panel buttons—useful if you have small children. See “**V-Chip Lock Menu.**”

- **Video Settings.** Change the video adjustments to get the best picture for your viewing conditions. See “**Audio/Video Menu.**”

TV Care

13 Know how to care for your TV:

- **Lamp Cartridge.** When the lamp cartridge needs replacement, **replace the lamp yourself and save the cost of a service call.** See **Appendix F** for instructions.

- **Dust Filter.** Clean the dust filter annually and whenever you replace the lamp cartridge. See **Appendix E.**
- **General Cleaning.** To keep your TV looking its best, see the cleaning recommendations in **Appendix D.**

Assistance

14 If you need assistance with this TV:

- For troubleshooting, service, and product support, see **Appendix G.**
- For warranty information, see the TV warranty in the back of this book.

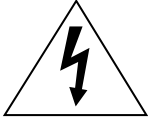

CAUTION

**RISK OF ELECTRIC SHOCK
DO NOT OPEN**



CAUTION: TO REDUCE THE RISK OF ELECTRIC SHOCK, DO NOT REMOVE COVER (OR BACK). NO USER SERVICEABLE PARTS INSIDE. REFER SERVICING TO QUALIFIED SERVICE PERSONNEL.

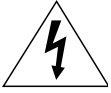

The lightning flash with arrowhead symbol within an equilateral triangle is intended to alert the user of the presence of uninsulated “dangerous voltage” within the product’s enclosure that may be sufficient magnitude to constitute a risk of electric shock.



The exclamation point within an equilateral triangle is intended to alert the user to the presence of important operating and maintenance (servicing) instructions in the literature accompanying the appliance.

WARNING: TO REDUCE THE RISK OF FIRE OR ELECTRIC SHOCK, DO NOT EXPOSE THIS APPLIANCE TO RAIN OR MOISTURE.

CAUTION: TO PREVENT ELECTRIC SHOCK, MATCH WIDE BLADE OF PLUG TO WIDE SLOT, FULLY INSERT.

TV WEIGHT: This TV is heavy! Exercise extreme care when lifting or moving it. Lift or move the TV with a minimum of two adults. To prevent damage to the TV, avoid jarring or moving it while it is turned on. Always power off your TV before moving it.

WARNING: This product contains chemicals known to the State of California to cause cancer and/or birth defects or other reproductive harm.

Installation Notes

Stand Requirement

CAUTION: Use these Mitsubishi TV models only with the Mitsubishi stand models shown here. Use with other stands can result in instability and possibly cause injury.

<i>TV Model Number</i>	<i>Stand Model Number</i>
WD-52526	MB-52527
WD-62526	MB-62527

Custom cabinet installation must allow for proper air circulation around the television.

NOTE TO CATV SYSTEM INSTALLER: THIS REMINDER IS PROVIDED TO CALL THE CATV SYSTEM INSTALLER’S ATTENTION TO ARTICLE 820-40 OF THE NEC THAT PROVIDES GUIDELINES FOR THE PROPER GROUNDING AND, IN PARTICULAR, SPECIFIES THAT THE CABLE GROUND SHALL BE CONNECTED TO THE GROUNDING SYSTEM OF THE BUILDING, AS CLOSE TO THE POINT OF CABLE ENTRY AS PRACTICAL.

Unauthorized Software

Do not attempt to update the software of this TV with software or cards that are not provided by or authorized by Mitsubishi Digital Electronics America, Inc. Non-authorized software may damage the TV and will not be covered by the warranty.

Operating Notes

Demo Mode

This TV has a demo mode for use in retail stores. To turn off demo mode:

1. Press TV MENU.
2. When the menu appears, press the following buttons in sequence:

0, QV, 0

Standby Fan

When the TV is off, you may hear a low-power standby fan. This is normal operation. The fan cools advanced circuitry in this TV that must continue to operate even when the TV is turned off.

Temporary Residual Images

Prolonged display of stationary images on your TV may cause faint residual “ghost” images to be visible when viewing other programs. **THIS EFFECT IS TEMPORARY.** The residual images will disappear within days or weeks. Most TV and DVD programming is of generally uniform brightness and will not produce this effect.

To prevent the appearance of residual images:

- Avoid display of stationary images for extended periods on this or any other LCD projection TV. Examples of such images include:
 - Stationary images that may be part of video games and web pages
 - Bright, stationary icons overlaid on moving video
 - Side bars displayed with narrow-format video (see definition on page 37)
 - Top and bottom bars displayed with letterbox video (see definition on page 37)

Lamp Replacement

The image on this TV is produced by a powerful lamp that will operate for many hours. Eventually, however, this lamp will need to be replaced. **Replace the lamp yourself and save the cost of a service call.** Front-panel indicators and/or on-screen messages will assist you in determining when the lamp needs to be replaced. **Please see Appendix F for details on lamp replacement.**

To obtain a new lamp:

To Receive a Replacement Lamp Under Warranty	To Purchase a Replacement Lamp After Warranty
Call (800) 332-2119. Please have model number, serial number, and TV purchase date available.	Call (800) 553-7278. Order lamp part number 915P028010.

Dust-Filter Cleaning

Clean the dust filter annually and whenever you replace the lamp cartridge. See Appendix E for cleaning instructions. A dirty filter may cause the TV to overheat (the STATUS indicator on the front panel will glow yellow). Never operate this TV without a clean dust filter in place.

IMPORTANT SAFEGUARDS

Please read the following safeguards for your TV and retain for future reference. Always follow all warnings and instructions marked on the television.

1. Read, Retain and Follow All Instructions

Read all safety and operating instructions before operating the TV. Retain the safety and operating instructions for future reference. Follow all operating and use instructions.

2. Heed Warnings

Adhere to all warnings on the appliance and in the operating instructions.

3. Cleaning

Unplug the TV from the wall outlet before cleaning. Do not use liquid, abrasive or aerosol cleaners. Cleaners can permanently damage the cabinet and screen. Use a lightly dampened cloth for cleaning.

4. Attachments and Equipment

Never add any attachments and/or equipment without approval of the manufacturer as such additions may result in the risk of fire, electric shock or other personal injury.

5. Water and Moisture

Do not use the TV where contact with or immersion in water is possible. Do not use near bath tubs, wash bowls, kitchen sinks, laundry tubs, swimming pools, etc.

6. Accessories



Do not place the TV on an unstable cart, stand, tripod, or table. The TV may fall, causing serious injury to a child or adult and serious damage to the TV. Use only with a cart, stand, tripod, bracket or table recommended by the manufacturer, or sold with the TV. Any mounting of the TV should follow the manufacturer's instructions, and should use mounting accessories recommended by the manufacturer.

An appliance and cart combination should be moved with care. Quick stops, excessive force, and uneven surfaces may cause the appliance and cart combination to overturn.

7. Ventilation

Slots and openings in the cabinet are provided for ventilation and to ensure reliable operation of the TV and to protect it from overheating. Do not block these openings or allow them to be obstructed by placing the TV on a bed, sofa, rug, or other similar surface. Nor should it be placed over a radiator or heat register. If the TV is to be placed in a rack or bookcase, ensure that there is adequate ventilation and that the manufacturer's instructions have been adhered to.

8. Power Source

This TV should be operated only from the type of power source indicated on the marking label. If you are not sure of the type of power supplied to your home, consult your appliance dealer or local power company.

9. Grounding or Polarization

This TV is equipped with a polarized alternating current line plug having one blade wider than the other. This plug will fit into the power outlet only one way. If you are unable to insert the plug fully into the outlet, try reversing the plug. If the plug should still fail to fit, contact your electrician to replace your obsolete outlet. Do not defeat the safety purpose of the polarized plug.

10. Power-Cord Protection

Power-supply cords should be routed so that they are not likely to be walked on or pinched by items placed upon or against them, paying particular attention to cords at plugs, convenience receptacles, and the point where they exit from the TV.

11. Lightning

For added protection for this TV during a lightning storm, or when it is left unattended and unused for long period of time, unplug it from the wall outlet and disconnect the antenna or cable system. This will prevent damage to the TV due to lightning and power-line surges.

IMPORTANT SAFEGUARDS, continued

12. Power Lines

An outside antenna system should not be located in the vicinity of overhead power lines or other electric light or power circuits, or where it can fall into such power lines or circuits. When installing an outside antenna system, extreme care should be taken to keep from touching such power lines or circuits as contact with them might be fatal.

13. Overloading

Do not overload wall outlets and extension cords as this can result in a risk of fire or electric shock.

14. Object and Liquid Entry

Never push objects of any kind into this TV through openings as they may touch dangerous voltage points or short-out parts that could result in fire or electric shock. Never spill liquid of any kind on or into the TV.

15. Outdoor Antenna Grounding

If an outside antenna or cable system is connected to the TV, be sure the antenna or cable system is grounded so as to provide some protection against voltage surges and built-up static charges.

Article 810 of the National Electric Code, ANSI/NFPA No. 70-2002, provides information with respect to proper grounding of the mast and supporting structure, grounding of the lead in wire to an antenna discharge unit, size of grounding conductors, location of antenna discharge unit, connection to grounding electrodes, and requirements for the grounding electrode.

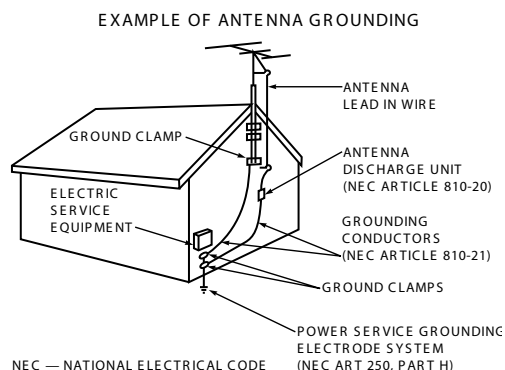

16. Servicing

Do not attempt to service this TV yourself as opening or removing covers may expose you to dangerous voltage or other hazards. Refer all servicing to qualified service personnel.

17. Damage Requiring Service

Unplug the TV from the wall outlet and refer servicing to qualified service personnel under the following conditions:

- (a) When the power-supply cord or plug is damaged.
- (b) If liquid has been spilled, or objects have fallen into the TV.
- (c) If the TV has been exposed to rain or water.
- (d) If the TV does not operate normally by following the operating instructions, adjust only those controls that are covered by the operating instructions as an improper adjustment of other controls may result in damage and will often require extensive work by a qualified technician to restore the TV to its normal operation.
- (e) If the TV has been dropped or the cabinet has been damaged.
- (f) When the TV exhibits a distinct change in performance - this indicates a need for service.

18. Replacement Parts

When replacement parts are required, be sure the service technician has used replacement parts specified by the manufacturer or have the same characteristics as the original part. Unauthorized substitutions may result in fire, electric shock or other hazards.

19. Safety Check

Upon completion of any service or repair to the TV, ask the service technician to perform safety checks to determine that the TV is in safe operating condition.

20. Heat

The product should be situated away from heat sources such as radiators, heat registers, stoves or other products (including amplifiers) that produce heat.

Note: This equipment has been tested and found to comply with the limits for a Class B digital device, pursuant to part 15 of the FCC Rules. These limits are designed to provide reasonable protection against harmful interference in a residential installation. This equipment generates, uses and can radiate radio frequency energy and, if not installed and used in accordance with the instructions, may cause harmful interference to radio communications. However, there is no guarantee that interference will not occur in a particular installation. If this equipment does cause harmful interference to radio or television reception, which can be determined by turning the equipment off and on, the user is encouraged to try to correct the interference by one or more of the following measures:

- Reorient or relocate the receiving antenna.
- Increase the separation between the equipment and the receiver.
- Connect the equipment into an outlet on a circuit different from that to which the receiver is connected.
- Consult the dealer or an experienced radio/TV technician for help.

CAUTION: To assure continued FCC compliance, the user must use a shielded video interface cable with bonded ferrite cores at both ends when using the HDMI connections.

Changes or modifications not expressly approved by Mitsubishi could cause harmful interference and would void the user's authority to operate this equipment.

WARNING: This product contains chemicals known to the State of California to cause cancer and/or birth defects or other reproductive harm.

Chapter



Television Overview

Special Features of Your TV	14
Package Contents	14
TV Front Panel	15
Remote Control	18
TV Back Panel	20

Special Features of Your TV

Your new high-definition widescreen television has many special features that make it the perfect center of your home entertainment system, including:

16:9 Widescreen Picture Format

Enjoy a full theatrical experience in the comfort of your home. View pictures as film directors intended them. Digital TV broadcasts, DVDs and newer video game consoles support this widescreen format.

Integrated HDTV Tuner

Your widescreen Mitsubishi HDTV has an internal HDTV tuner able to receive both over-the-air HDTV broadcasts (received via an antenna) and non-scrambled digital cable broadcasts, including non-scrambled HDTV cable programming.

High-Definition Video Inputs

◆ Two Component Video Inputs

This television has two component video inputs, also called Y/Pb/Pr inputs. These inputs receive standard analog video formats of 480i (standard analog TV), 480p (progressive-scan signals), and 720p and 1080i high-definition signals. This provides a high level of flexibility when connecting DVD players/recorders, cable boxes, and satellite receivers.

◆ Two HDMI Inputs

This television also has two HDMI™ inputs that accept digital 480i, 480p, 720p, and 1080i video signals plus PCM digital stereo signals. Used with an adapter, these inputs also accept compatible DVI signals. HDMI inputs provide additional high-performance, high-definition connections for maximum flexibility in your choice of home theater products. The HDMI inputs are HDCP copy-protection compatible.

LCD Light Engine

Mitsubishi's exclusive LCD Light engine features superior corner focus and SmartShutter™ dynamic aperture system.

SmartShutter™

SmartShutter™ technology displays deep blacks and improved dark scene detail. It does this by reducing light output during dark scenes without adversely affecting other picture characteristics.

QuickMotion™

High-speed LCD drive reduces response time and displays sharp detail even during fast-moving scenes.

Plush720p™

Upconverts lower-quality video signals to deliver maximum image clarity from every source.

Package Contents

Please take a moment to review the following list of items to ensure that you have received everything.

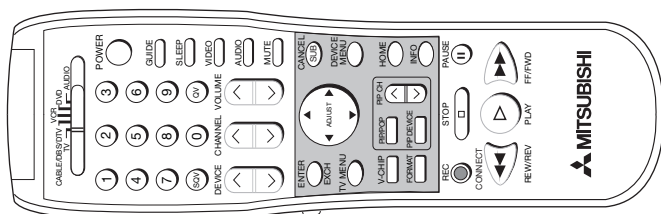

1. Remote Control

2. Two AAA Batteries



3. Product registration card (not pictured)

4. Owner's Guide (not pictured)

5. Quick Reference Guide (not pictured)

TV Front Panel

The shaded buttons on the front control panel are duplicated on the remote control. The top row of labels shows the control functions when there are no TV menus displayed on the screen. The bottom row of labels shows the control functions when the TV menus are displayed on the screen or when a special function has been activated. See “Remote Control Overview” in this chapter for further details on the functions of these buttons.

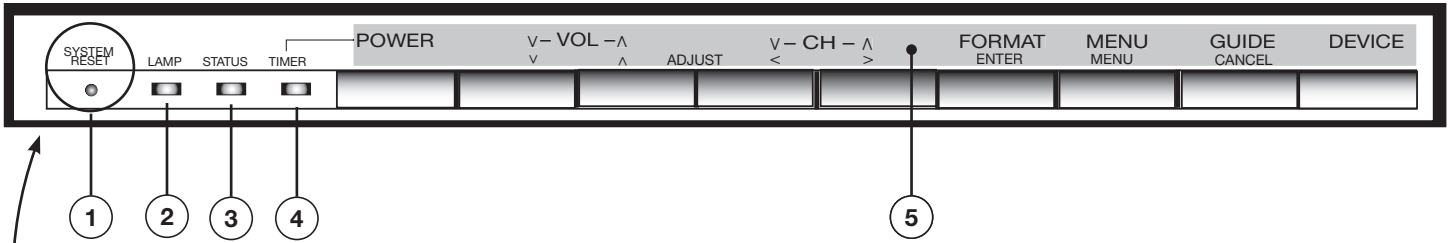

Front Control Panel

1. System Reset **2.** Lamp indicator shows lamp condition (off during normal TV operation) **3.** Status indicator (off during normal TV operation) **4.** Power/Timer indicator **5.** Shaded buttons are duplicates of keys on the remote control

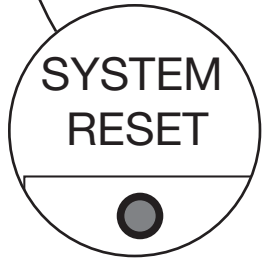

If the TV does not respond to either the remote control or the front panel controls and/or does not power off, press the SYSTEM RESET button with a pointed item, such as the end point of a paperclip. The TV will turn off and the TIMER light will flash quickly for about one minute. When the TIMER light stops flashing, you may again turn on the TV. The changes you made the last time the TV was on before you used the SYSTEM RESET button may be lost. Any changes that you previously saved are not lost.

A/V Reset

There may be times when you wish to reset the A/V (Audio and Video) settings back to the factory defaults. To return all settings at once, press GUIDE and FORMAT on the front panel at the same time. To reset the defaults for individual devices, use the A/V Memory Reset selection on the Audio/Video menu.

Input 3

This input can be used for convenient connection of a camcorder or other video device to the TV. Please note that if you connect to the S-VIDEO jack, the VIDEO jack is automatically deactivated. The VIDEO jack is active only when there is no S-Video connection.

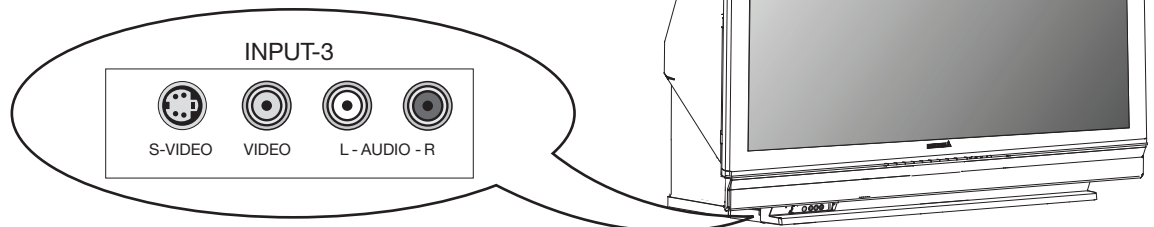

TV Front Panel, continued

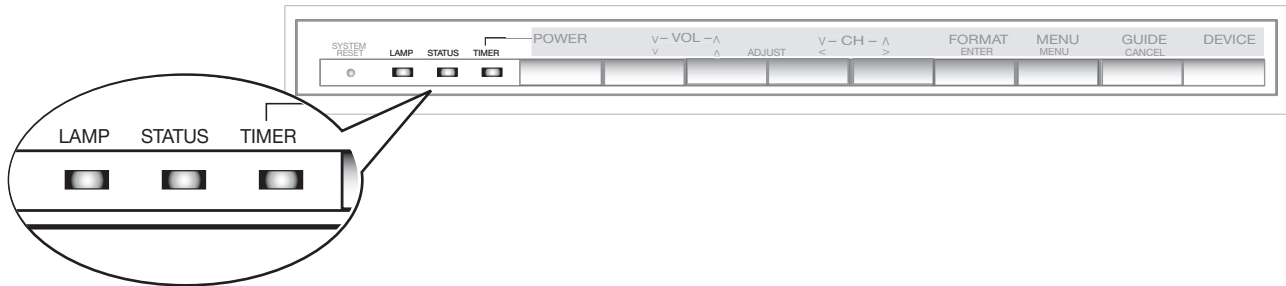

Front-Panel LED Indicators

LAMP Indicator		
Indicator Color	TV Condition	Additional Information
None (indicator off)	Normal TV on or standby condition.	Normal operation.
Green, rapid blinking	TV just powered off and lamp is cooling.	Begins to blink 30 seconds after turning off TV. TV can be turned on before it begins to blink or after the blinking stops, but not while the indicator is blinking. Normal operation.
Yellow, steady	Lamp nearing end of useful life.	This is a recommendation to have a new lamp ready before the current lamp stops illuminating. See Appendix F for ordering information.
Yellow, blinking	1. Lamp access door is open or not secure.	TV will not operate until lamp access door is secure. See Appendix F for installation information.
	2. No lamp installed.	TV will not operate without a lamp. See Appendix F for installation information.
Red, steady	Lamp no longer illuminates and has reached the end of the lamp life.	Replace the lamp. The TV will not operate when the lamp no longer illuminates. See Appendix F for lamp installation instructions.

TV Front Panel, continued

STATUS Indicator		
Indicator Color	TV Condition	Additional Information
None (indicator off)	Normal TV on or standby condition.	Normal operation.
Yellow , steady	1. Operating temperature is too high; dust filter may need cleaning.	See Appendix E concerning dust filter cleaning. TV will not operate when the dust filter is clogged and internal temperature rises too high.
	2. Room temperature is too high.	TV will not operate when the ambient room temperature is too high. Turn off the TV and wait until the room temperature drops.
Yellow , blinking	Dust filter cover is not in place or not secure.	TV will not operate until the dust filter cover is securely in place.
Red , either steady or blinking	TV may require service.	Turn off the TV and unplug the set from the AC power source. Wait one minute and then plug the set back in. If the LED is still on, contact your dealer or a Mitsubishi Authorized Service Center. See www.mitsubishi-tv.com or call 1-800-332-2119 to receive Authorized Service Center information.

POWER/TIMER Indicator		
Indicator Color	TV Condition	Additional Information
None (indicator off)	TV is powered OFF.	Normal operation.
Green , steady	TV is powered ON.	Normal operation.
Green , rapid blinking	1. TV just plugged into AC outlet.	Wait until blinking stops before turning on (approximately 1 minute). Normal operation.
	2. AC just restored after power failure.	
	3. TV Rebooting after System Reset used.	
	4. TV Rebooting after power fluctuation or receiving abnormal digital signals from digital channel.	
	5. You have begun the procedure to update software from an authorized flash memory device.	For detailed information, see the instructions that accompany the authorized software update. Important: Do not use non-authorized software at any time.
Green , slow blinking	TV powered off and automatic-on timer is set.	Normal operation. TV can be turned on at any time.

Remote Control

Overview

Figure 1, next page

1. **Slide Switch:** Selects the A/V device to be controlled by the remote control. Set the slide switch to TV for TV operation. Control of other devices requires programming (see Appendix B)
2. **Numbers:** Allow you to tune to a channel by entering channel numbers; press ENTER for faster tuning. Use numbers and the SUB key for digital sub-channels. Enter information into menus.
3. **SQV (SuperQuickView™):** Scans through memorized lists of favorite channels.
4. **DEVICE:** Displays the Device Selection menu in which you can select the device to view (ANT 1 or devices connected to the TV's inputs).
5. **CHANNEL:** Scans up or down through memorized channels. Pages up and down through screens when used with ChannelView™.
6. **POWER:** Turns TV power on and off.
7. **GUIDE:** Displays or removes ChannelView™ on-screen guide for ANT 1.
8. **QV (QuickView™):** Switches between the current channel and the last channel viewed.
9. **SLEEP:** Sets the TV to turn off within 2 hours. See the next page for instructions.
10. **VIDEO:** Selects individual video settings for adjustment.
11. **VOLUME:** Changes sound level.
12. **AUDIO:** Selects individual audio settings for adjustment.
13. **MUTE:** Turns sound off or back on.
14. **ADJUST:** Press ▲▼◀▶ to navigate menus, change settings, and move the PIP on-screen location.
15. **Light:** Illuminates the buttons. Located on the left side of the remote control.
16. **ENTER/EXCH:** Selects a channel number or menu item. Exchanges PIP or POP and main TV picture.
17. **TV MENU:** Displays the **ViewPoint** on-screen menu system.
18. **V-CHIP:** Turns the V-Chip Lock on or off.
19. **FORMAT:** Changes the shape and size of the main TV picture.
20. **PIP/POP:** Turns on PIP and cycles through PIP and POP display choices.
21. **PIP DEVICE:** Displays PIP Selection menu to select the source device for the PIP or POP image.
22. **PIP CH:** When the PIP source is ANT 1, scrolls up or down through analog channels memorized for ANT 1.
23. **SUB/CANCEL:** For digital channels, adds a separator between main and sub-channel numbers. Clears SQV and some menu entries.
24. **DEVICE MENU:** When programmed for the device and with the slide switch in the appropriate position, displays the menus for some VCRs, satellite receivers, and DVD players.
25. **HOME:** Exits TV on-screen menus and displays and returns to normal TV viewing.
26. **INFO:** Displays an on-screen summary of the current device in use and any broadcast information available, including current V-Chip information. See chapter 3 for details on the on-screen display.
29. **PAUSE:** Freezes a broadcast TV picture (when no PIP/POP image is displayed). When PIP/POP is displayed, freezes that image. See below for use with recordable media.

Record/Playback Keys

To enable the functions described here, program the remote for your VCR or DVD player and set the slide switch to VCR or DVD. See Appendix B for instructions on programming the remote.

27. **REC (Record):** Records with a VCR. Note that the CONNECT function is unavailable with this TV model.
28. **REW/REV:** Rewinds a VCR. Reverse scans a DVD.
29. **PAUSE:** Pauses a VCR or DVD. See above for use during TV viewing.
30. **STOP:** Stops play of a VCR or DVD.
31. **FF/FWD:** Fast forwards a VCR. Forward scans a DVD.
32. **PLAY:** Plays a VCR or DVD.

Note

The remote control can be programmed to operate other audio/video devices. See Appendix B for:

- instructions on programming the remote to operate other devices.
- a list of functions available for controlling other devices.

Remote Control, continued

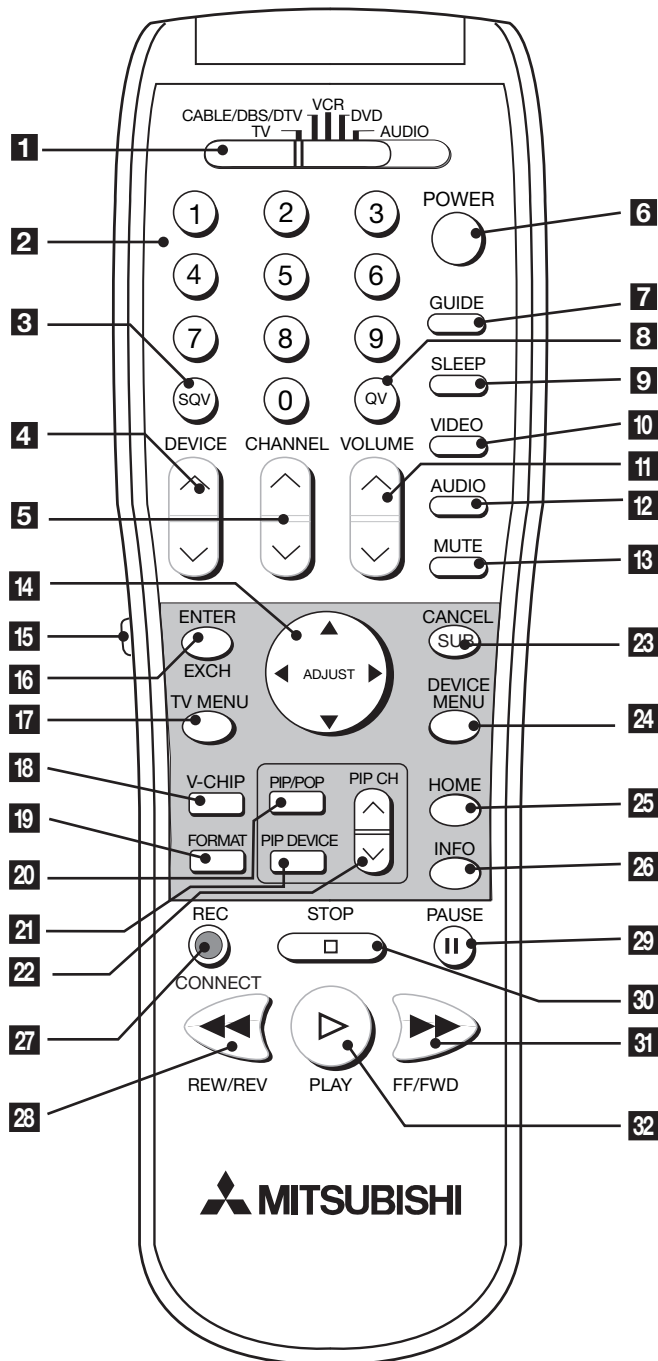

Figure 1. Remote Control Overview

Battery Installation

Figure 2

Installing the Batteries:

1. Remove the remote control's back cover by gently pressing the ribbed tab in the direction of the arrow and sliding off the cover.
2. Load the batteries, making sure the polarities (+) and (-) are correct. For best results, insert the negative (-) side first.

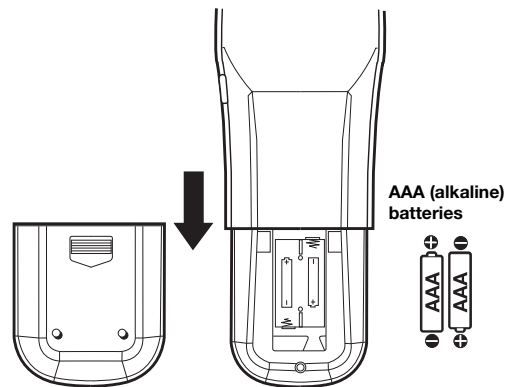

Figure 2. Installing batteries

Care

For Best Results from the Remote Control:

- Be within 20 feet of the equipment.
- Do not press two or more buttons at the same time unless instructed.
- Do not allow unit to get wet or become heated.
- Avoid dropping on hard surfaces.
- Do not use harsh chemicals to clean. Use only a soft, lightly moistened cloth.
- Do not mix new and old batteries.
- Do not heat, take apart, or throw batteries into fire.
- Use only AA alkaline batteries.

Hint: If the slide switch is set to TV and does not function, press POWER and 935 to reset the remote.

Sleep Timer

The Sleep Timer automatically shuts off the TV after the time delay you have set.

Setting the Sleep Timer:

1. Press SLEEP on the remote control.
2. Each additional press of SLEEP increases the time displayed by 30 minutes up until the maximum value of 120 minutes.
3. After five seconds of inactivity, the message will disappear.
4. Press SLEEP to view the time remaining before the timer turns the TV off.

Cancelling the Sleep Timer:

1. Press SLEEP to display the on-screen message.
2. Press SLEEP repeatedly until OFF is displayed.

Note: After five seconds of inactivity, the message box disappears.

TV Back Panel

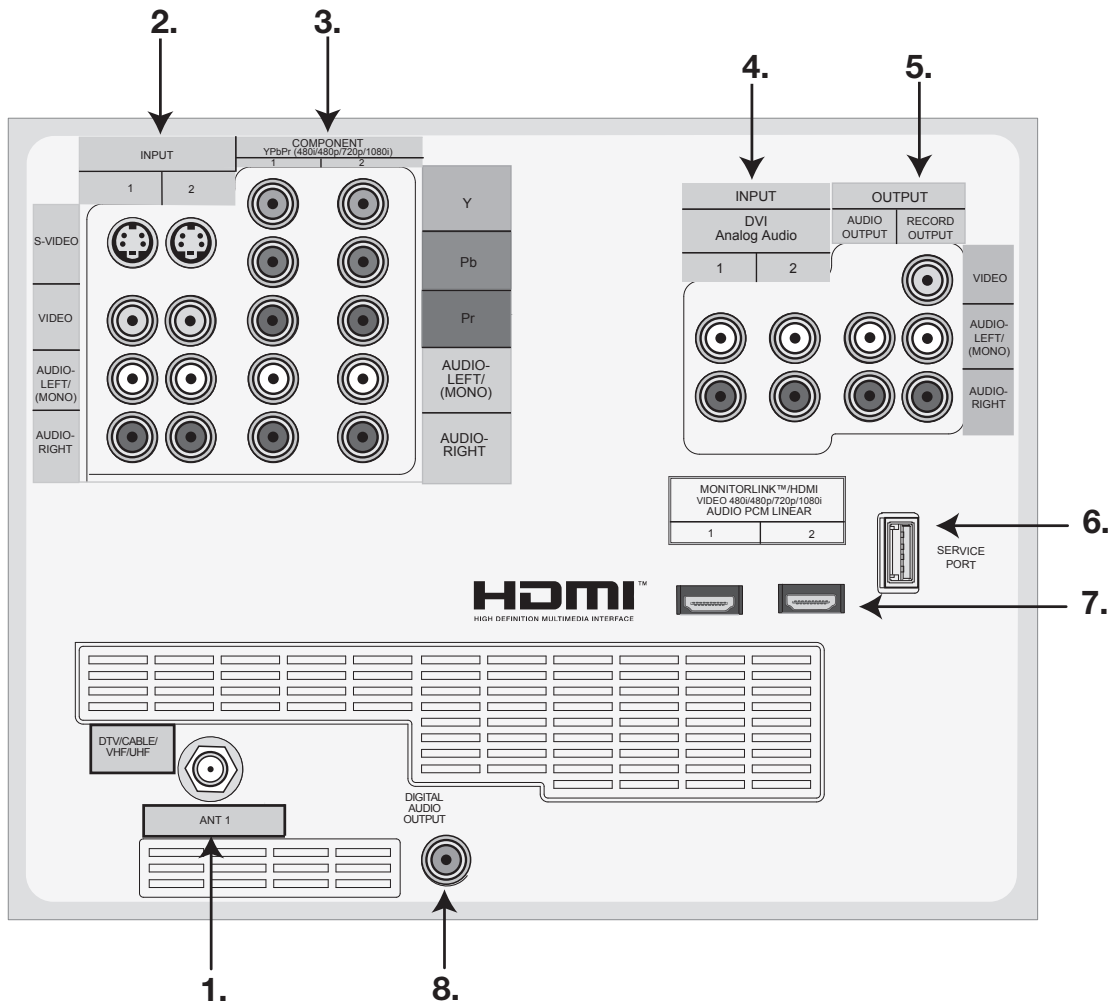

1. ANT 1 (Antenna)

ANT 1 can receive digital and analog over-the-air channels from a VHF/UHF antenna or non-scrambled digital/analog cable source.

2. INPUT 1 and 2 (Audio/Video 1 and 2)

Use INPUT 1 and 2 to connect a VCR, Super VHS (S-VHS) VCR, DVD player, standard satellite receiver, or other A/V device to the TV. INPUT 1 and 2 accept standard RCA-type left and right stereo audio plugs, S-Video, and composite video. Please note that if you connect to the S-VIDEO input, the VIDEO input is automatically deactivated.

3. COMPONENT 1 and 2 YPbPr (480i/480p/720p/1080i)

Use these inputs to connect devices with component video outputs, such as a DVD player, external HDTV receiver, or compatible video game system. Please see Appendix C for signal compatibility.

TV Back Panel, continued

4. DVI Analog Audio

Use these analog stereo audio inputs when using the HDMI input with a device that outputs DVI instead of HDMI, such as DVI output from a DVD player. Unlike HDMI, DVI does not carry audio information on the same cable, thus requiring a separate audio input.

5. AUDIO OUTPUT, RECORD OUTPUT

AUDIO OUTPUT sends analog audio of the program currently shown on the screen to an A/V surround sound receiver or stereo system. Digital audio from digital channels and HDMI devices is converted to analog audio by the TV. If you have an analog rather than digital A/V receiver, this should be the only audio connection between the TV and your analog A/V receiver or stereo system.

RECORD OUTPUT sends analog audio and video to a VCR for recording purposes. Digital video from digital channels is downconverted to analog video. Audio alone is output when a COMPONENT 1 or 2 or HDMI 1 or 2 input is selected for recording.

6. Service Port

This input is for use by Authorized Mitsubishi Servicicers only or for authorized software updates.

7. HDMI™ 1 and 2

The HDMI (High Definition Multimedia Interface) supports uncompressed standard and high-definition digital video formats and PCM digital stereo audio format.

Use these inputs to connect to EIA/CEA-861-compliant devices such as high-definition cable boxes, satellite receivers, or DVD players. These inputs support 480i, 480p, 720p and 1080i video formats.

These inputs can also be used as a DVI connection with separate analog audio inputs. An optional HDMI-to-DVI adaptor or cable is necessary to make this connection and may be available from your local electronics retailer. When using the HDMI input to connect a DVI device, use the DVI Analog Audio inputs on your TV to receive left and right stereo audio from the DVI device.

This input is HDCP (High-Bandwidth Digital Copy Protection) compliant.

8. Digital Audio Output

This output sends Dolby® Digital or PCM digital audio to your digital A/V surround sound receiver. Analog audio from analog channels and devices is converted by the TV to PCM digital audio. If you have a digital A/V receiver, in most cases this should be the only audio connection between the TV and the A/V receiver.

Connecting

HDTV Cable Box or Satellite Receiver with Component Video	24
Standard Cable Box, Satellite Receiver, or Other Device with S-Video.	24
Wall Outlet Cable	25
Older Cable Box	25
Antenna with a Single Lead	26
Antennas with Separate UHF and VHF Leads.	26
VCR and an Antenna or Wall Outlet Cable (Audio & Video).	27
VCR and a Cable Box (Audio and Video Direct Connections)	28
A/V Receiver (Stereo or Surround Sound Audio System).	29
DVD Player with Component Video	29
HDMI Device	30
DVI Device	30

HDTV Cable Box or Satellite Receiver with Component Video

Figure 1

A coaxial splitter, RCA component video cables, and stereo audio cables are required. These are not included with the TV.

1. Connect the outside cable or satellite to CABLE IN or SATELLITE IN on the cable box or satellite receiver. See your device's owner's guide for instructions and cable compatibility.

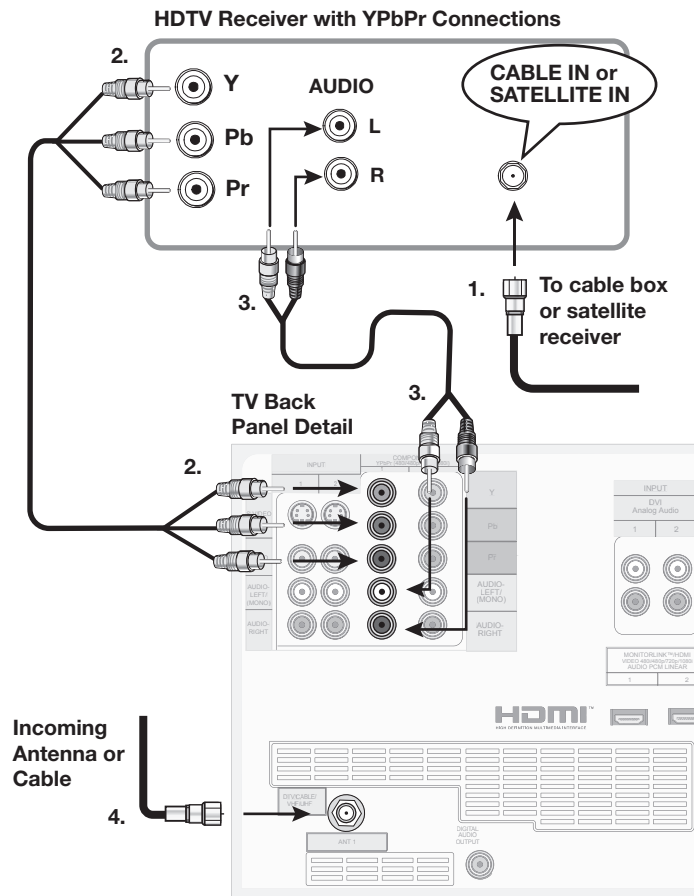

Figure 1. Connecting an external HDTV receiver with component video connections

2. Connect RCA-type cables from the YPrPb outputs on the cable box or satellite receiver to one of the COMPONENT inputs on the TV back panel, matching the color-coded connections.
3. Connect L (left) and R (right) audio cables from the cable box or satellite receiver to the corresponding COMPONENT AUDIO inputs on the TV back panel.

4. Optional: To allow use of the PIP feature with channels from ANT 1 and the cable box, connect the incoming terrestrial antenna or cable (not satellite) to ANT 1 on the TV back panel. A coaxial splitter, available at most electronic supply stores, may be required to complete this installation.

Note: To enjoy the benefits of a digital A/V receiver, connect your cable box or satellite receiver's digital audio out to a digital input on your digital A/V receiver.

Standard Cable Box, Satellite Receiver, or Other Device with S-Video

Figure 2

An S-Video cable and stereo audio cables are required. These are not included with the TV.

1. Connect an S-Video cable from VIDEO OUT on the cable box or satellite receiver back panel to INPUT S-VIDEO on the TV back panel.
2. Connect a set of audio cables from AUDIO OUT on the cable box or satellite receiver back panel to INPUT AUDIO on the TV back panel. Connect the red cable to the R (right) channel and the white cable to the L (left) channel.

Note: Refer to the cable box or satellite receiver Owner's Guide for cable or dish antenna connections to the receiver.

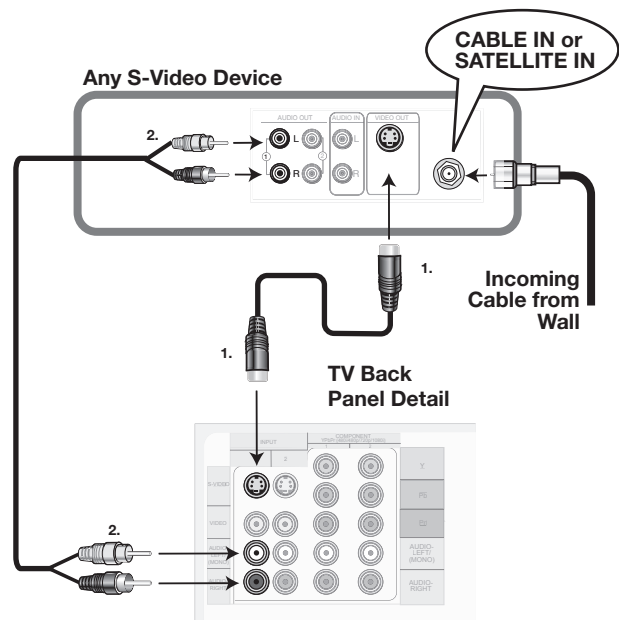

Figure 2. Connecting a device with S-Video

Wall Outlet Cable

Figure 3

Connect the primary incoming coaxial lead cable to ANT 1 on the TV back panel.

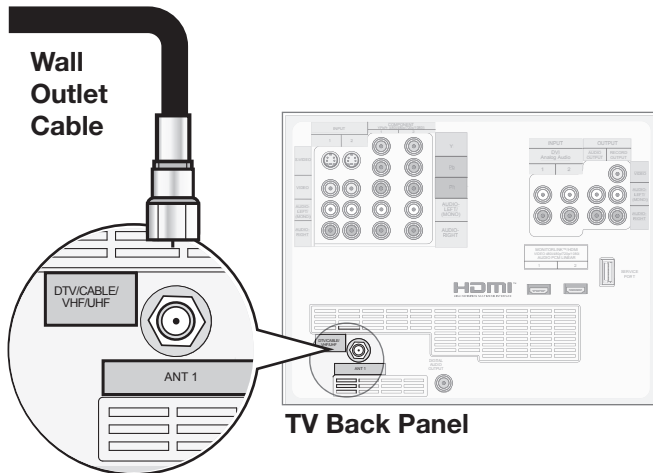

Figure 3. Wall Outlet Cable

Older Cable Box

This connection is not recommended. The other connections described in this chapter provide better quality audio and video to the TV.

Figure 4

Two coaxial cables are required. These cables are not included with the TV.

Note: See the preceding page to connect an HDTV cable box.

1. Connect the incoming cable to IN on the cable box.
2. Connect one coaxial cable from OUT on the cable box to ANT 1 on the TV back panel.

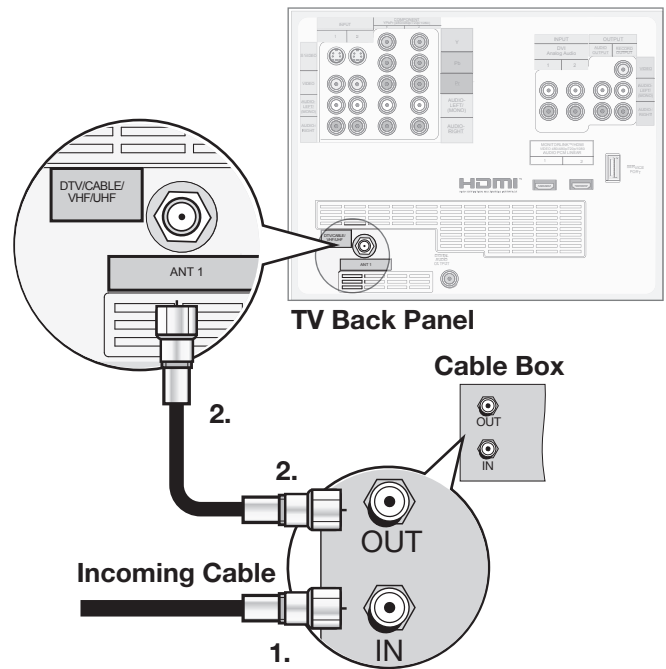

Figure 4. Connecting a Cable Box

Antenna with a Single Lead

Figure 5

A. For an antenna with flat twin leads

A 300-ohm-to-75-ohm transformer is required. This is not included with the TV, but is available at most electronics stores.

- A1. For an antenna with flat twin leads, connect the 300-ohm twin leads to the 300-ohm-to-75-ohm transformer.
- A2. Push the 75-ohm side of the transformer onto ANT 1 on the TV back panel.

B. For cable or antenna with coaxial lead

Connect the coaxial lead directly to ANT 1 on the TV back panel.

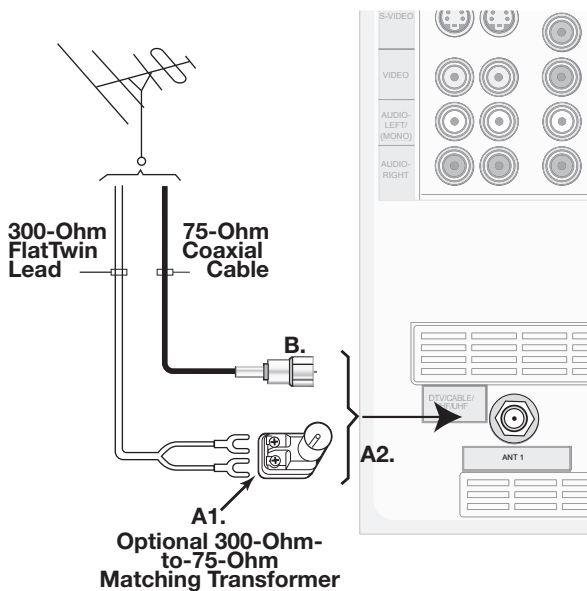

Figure 5. Connecting a Single Antenna

Antennas with Separate UHF and VHF Leads

Figure 6

A UHF/VHF combiner is required. This is not included with the TV, but is available at most electronics stores.

1. Connect the UHF and VHF antenna leads to the UHF/VHF combiner.
2. Push the combiner onto ANT 1 on the TV back panel.

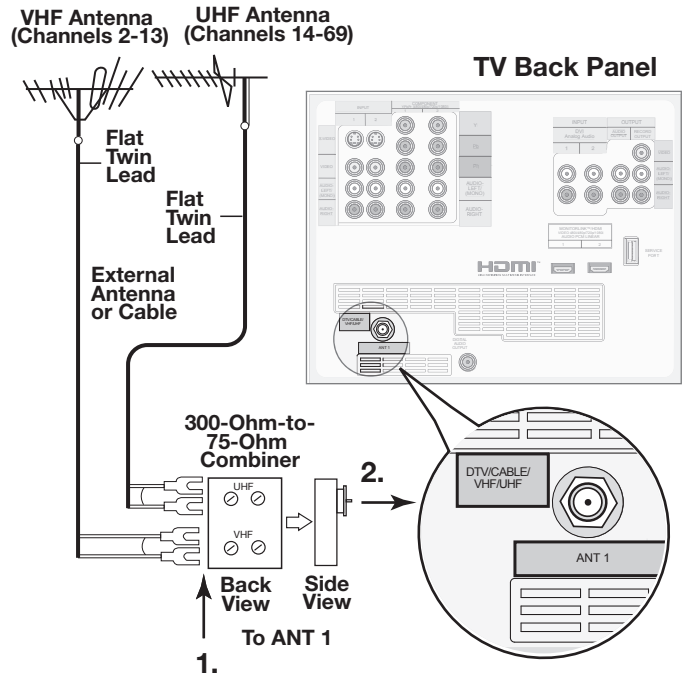

Figure 6. Connecting separate UHF and VHF Antennas

Mitsubishi strongly recommends you avoid using antennas with flat twin leads. Flat twin lead antenna wires are subject to interference which may adversely affect the performance of the TV. We recommend using coaxial antenna cable.

VCR and an Antenna or Wall Outlet Cable (Audio & Video)

Figure 7

A two-way RF splitter, 3 coaxial cables, right and left audio cables, and an S-Video or composite video cable are required. These are not included with the TV but are available at most electronics stores.

1. Connect the incoming cable or Antenna to IN on the RF splitter.
2. Connect one coaxial cable from OUT on the RF splitter to ANTENNA IN on the VCR back panel.
3. Connect one coaxial cable from OUT on the RF splitter to ANT 1 on the TV back panel.
4. To use the TV speakers with the VCR, connect a set of audio cables from AUDIO OUT on the VCR back panel to INPUT AUDIO-LEFT (MONO) and AUDIO-RIGHT on the TV back panel. Connect the red cable to the R (right) channel and the white cable to the L (left) channel. If your VCR is mono (non-stereo), connect only the white (left) cable.

5. Connect either an S-Video or Composite Video cable from VIDEO OUT on the VCR back panel to INPUT S-VIDEO/VIDEO on the TV back panel. Connect only one type of video cable. S-Video is recommended, if available.

Optional Additional Connections

6. To record from the TV tuner to the VCR, make the following additional connections. These connections allow you to record high-definition programming, downconverted to standard definition, on an analog VCR.
 - a. Connect a set of audio cables from AUDIO IN on the VCR back panel to RECORD OUTPUT/AUDIO-LEFT (MONO) and AUDIO-RIGHT on the TV back panel. Connect the red cable to the R (right) channel and the white cable to the L (left) channel.
 - b. Connect a video cable (composite video) from VIDEO IN on the VCR back panel to RECORD OUTPUT/VIDEO on the TV back panel.

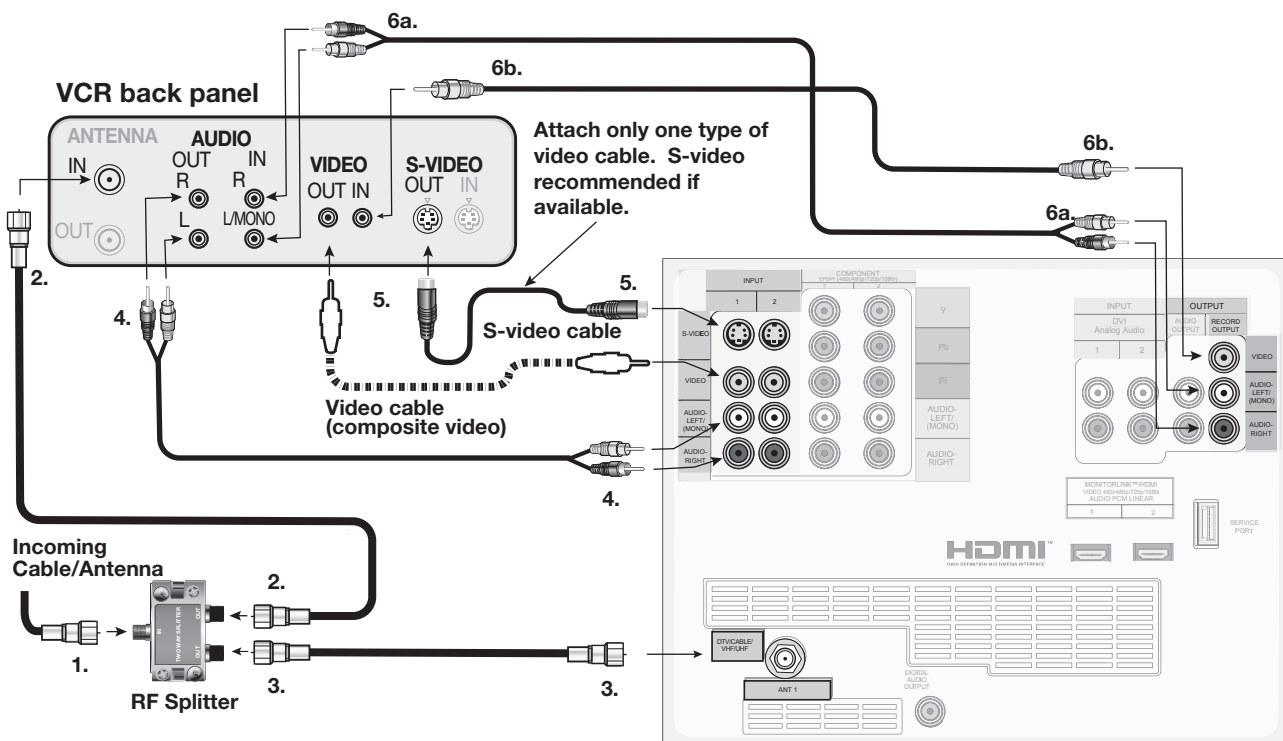

Figure 7. Connecting a VCR to an Antenna or Wall Outlet Cable

VCR and a Cable Box (Audio and Video Direct Connections)

Figure 8

Two coaxial cables, two right and left audio cables, and either two S-Video cables or two composite video cables are required. These are not included with the TV but are available at most electronics stores.

1. Connect the incoming cable to CABLE IN on the cable box back panel.
2. To allow recording from the cable box to the VCR, connect one coaxial cable from OUT on the cable box to ANTENNA IN on the VCR back panel.
3. Connect one set of left and right audio cables from AUDIO OUT on the cable box back panel to INPUT 1 AUDIO-LEFT (MONO) and AUDIO-RIGHT on the TV back panel. Connect the red cable to the R (right) channel and the white cable to the L (left) channel.

4. Connect either an S-Video or composite video cable from VIDEO OUT on the cable box to INPUT 1 S-Video or VIDEO on the TV. Connect only one type of video cable. S-Video is recommended, if available.
5. Connect one set of left and right audio cables from AUDIO OUT on the VCR back panel to INPUT 2 AUDIO-LEFT (MONO) and AUDIO-RIGHT on the TV back panel.
6. Connect either an S-Video or composite video cable from VIDEO OUT on the VCR to INPUT 2 S-Video or VIDEO on the TV. Connect only one type of video cable.

Note: To record TV programs, set the VCR to channel 3 or 4 and on the cable box select the channel to record .

Note: When using this connection configuration, it is possible to view live cable programs through the VCR Device. For best picture quality always view live cable programs directly from the Cable Box Device.

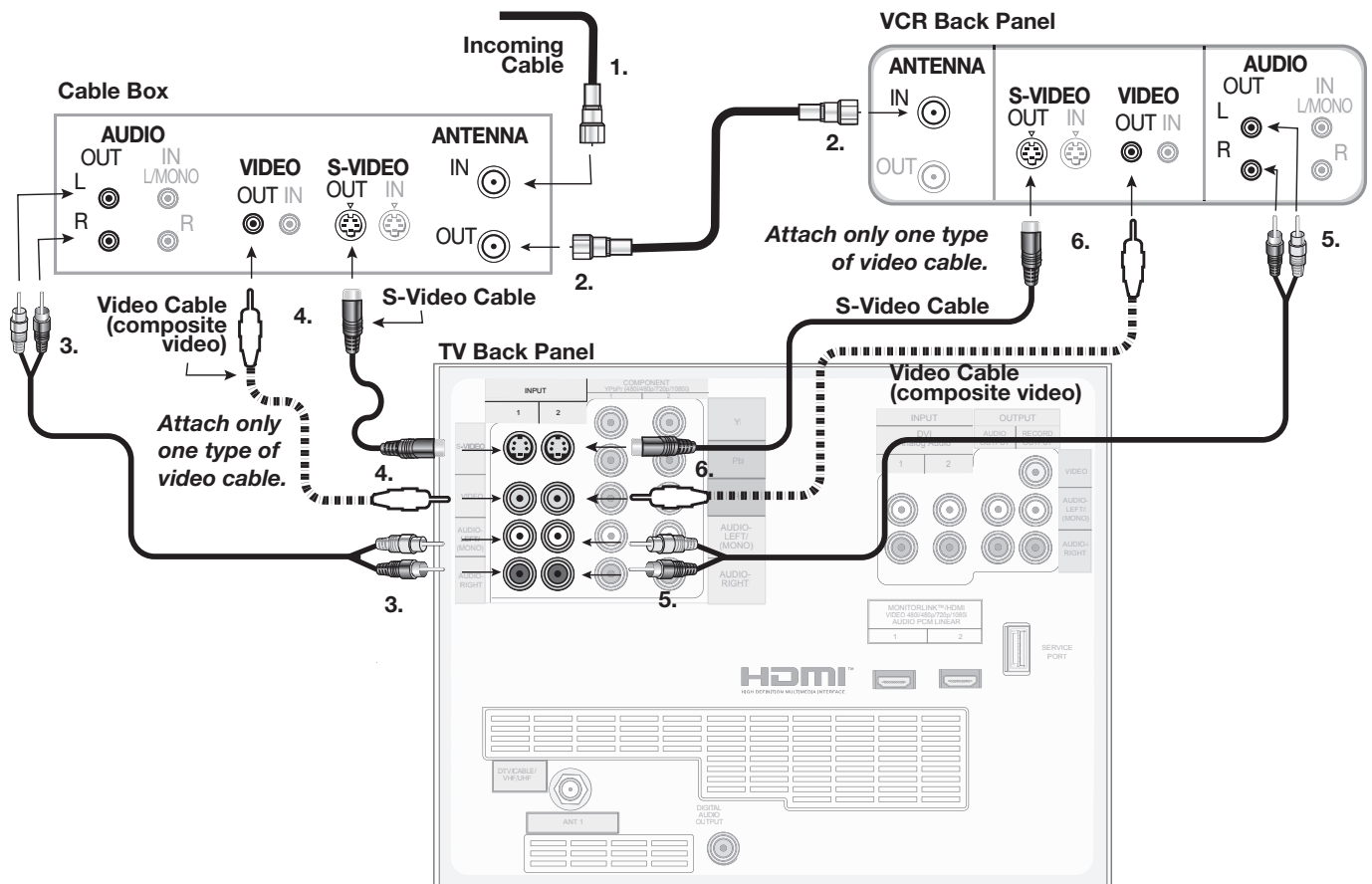

Figure 8. Connecting a VCR and Cable Box

A/V Receiver (Stereo or Surround Sound Audio System)

Figure 9

Most setups require either a coaxial digital audio cable or stereo audio cables. In some circumstances, you may need to connect both digital audio and stereo audio.

A. To connect an analog A/V receiver:

Connect a set of stereo audio cables from AUDIO OUTPUT on the TV back panel to the TV AUDIO INPUT on the back of the A/V receiver. Connect the red cable to the R (right) channel and the white cable to the L (left) channel.

The TV converts digital audio from digital channels to analog audio.

B. To connect a digital A/V receiver with Dolby® Digital surround sound:

Connect one end of a coaxial digital audio cable to DIGITAL AUDIO on the back of the TV. Connect the other end to the COAXIAL DIGITAL INPUT on the back of the A/V receiver.

The TV converts analog audio from analog channels or devices to PCM digital stereo audio.

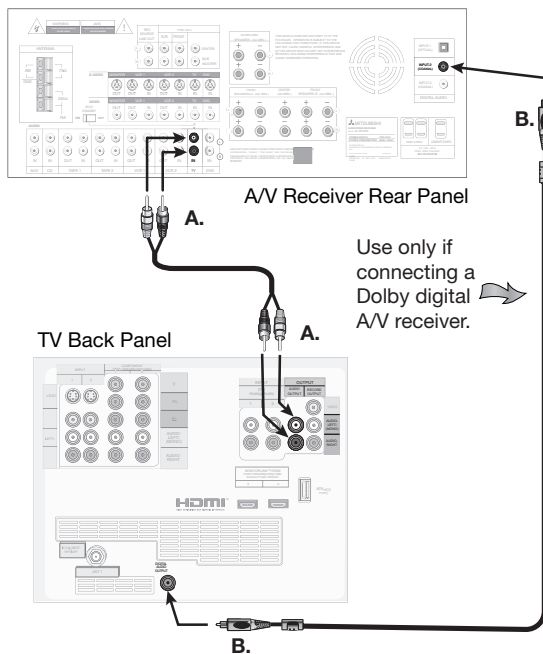

Figure 9. Connecting an A/V receiver

On rare occasions, an HDMI signal may be copy-restricted and cannot be output from the TV as a digital signal. To hear these copy-protected signals through the A/V receiver, use connections for an analog A/V receiver.

Check the A/V receiver's Owner's Guide for information concerning use of the digital input and switching between digital sound and analog stereo sound from the TV.

DVD Player with Component Video

Figure 10

Component video cables and audio cables are required. These are not included with the TV.

1. Connect the Component Video cables from Y/Pr/Pb VIDEO OUT on the back of the DVD player to a COMPONENT input on the TV back panel, matching the correct connections:
 - Y to Y (Green)
 - Pr to Pr (Red)
 - Pb to Pb (Blue)
2. Connect a set of audio cables from AUDIO OUT on the back of the DVD player to the COMPONENT AUDIO input on the TV back panel. Connect the red cable to the R (right) channel, and the white cable to the L (left) channel.

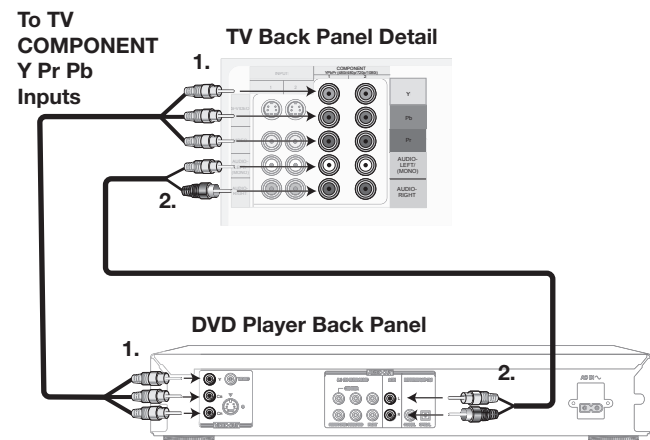

Figure 10. Connecting a DVD Player with Component Video

IMPORTANT

See Appendix C for component video signal compatibility information.

For digital audio connections to your A/V receiver, see your DVD player and A/V receiver Owner's Guides.

HDMI Device

Figure 11

An HDMI-to-HDMI cable is required. This is not included with the TV. It may be available at your local electronics retailer

Connect an HDMI cable from the TV back panel to the HDMI device output. HDMI devices provide video and audio through this cable, so no other connection is required. You can connect two HDMI devices to the TV back panel through the HDMI connections.

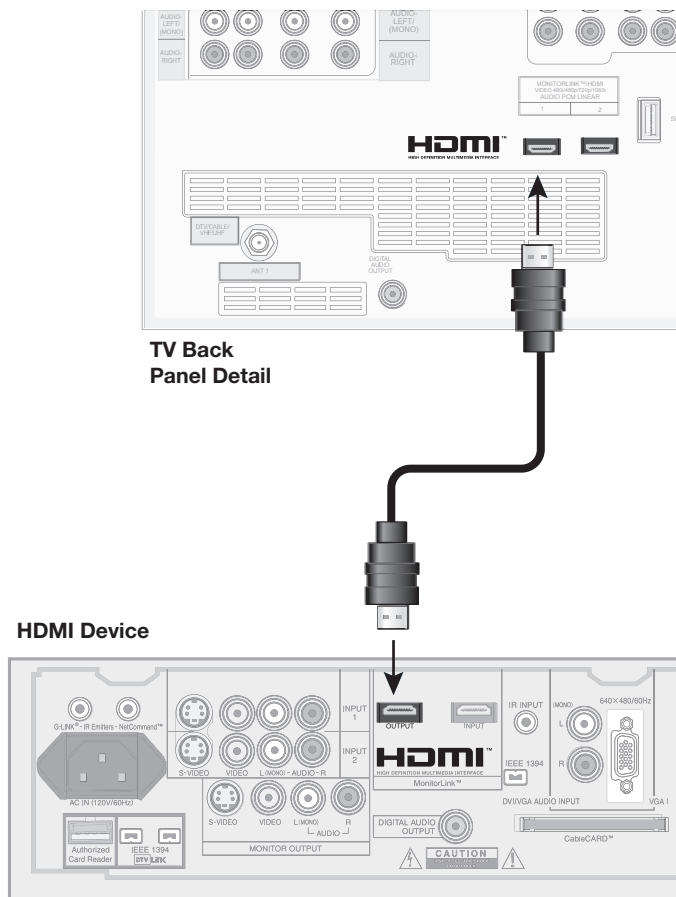

Figure 11. Connecting an HDMI Device

Note: To enjoy the benefits of digital surround sound from the HDMI device, connect the digital audio output of the HDMI device directly to the A/V receiver.

IMPORTANT

You can connect this TV to a personal computer via the HDMI jack only if the computer can output a standard video resolution of 480i, 480p, 720p, or 1080i.

DVI Device

Figure 12

A DVI-to-HDMI cable or DVI/HDMI adaptor and HDMI cable and audio cables are required. These are not included with the TV.

1. Connect the DVI-to-HDMI cable (recommended) or HDMI cable with DVI/HDMI adaptor from the DVI device's back panel to the TV back panel.
- NOTE:** If you are using a DVI/HDMI adaptor, it is important to connect the adaptor to the DVI device for best performance.
2. Connect a set of audio cables from AUDIO OUT on the DVI device back panel to the INPUT/DVI Analog Audio on the TV back panel. The red cable connects to the R (right) channel, and the white cable connects to the L (left) channel.

- NOTE:**
- The HDMI connection supports copy protection (HDCP).
 - Some devices require connection to an analog input first in order to view on-screen menus and select DVI as the output. Please review your equipment instructions for DVI connectivity and compatibility.

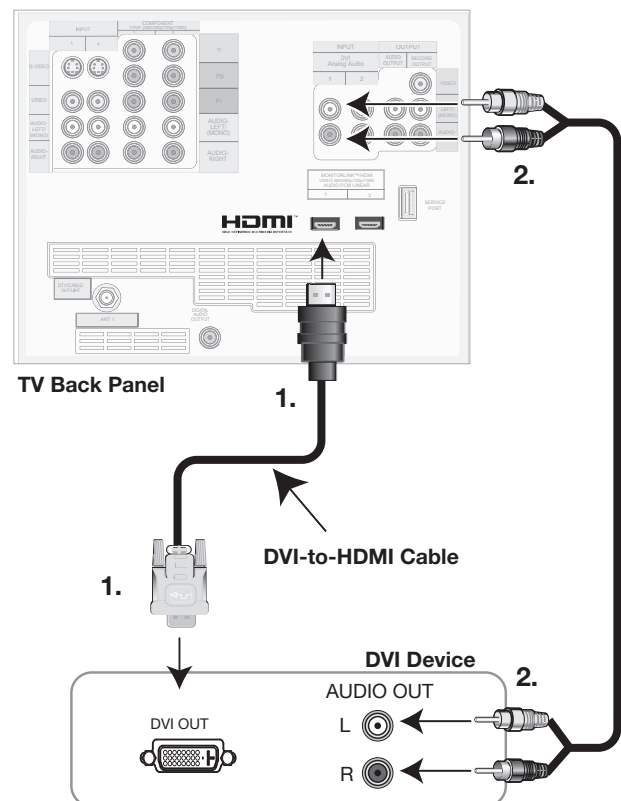

Figure 12. Connecting a DVI Device

Chapter

3

TV Operation

Choosing a Program Source (Device Selection Menu)	32
ChannelView™ Channel Listings	32
On-Screen Information	33
Operation of PIP and POP	34
TV Display Formats.	36

Choosing a Program Source (Device Selection Menu)

Figure 1

Press **DEVICE** on the TV's remote control to open the Device Selection menu (Figure 1). The Device Selection menu allows you to select an input for viewing. The device or input currently displayed on the TV appears as a gold-colored icon.

- To assign meaningful labels to the icons, such as "VCR" or "DVD," see the "Input Name" section of chapter 4, "TV Menu Operations."
- To rearrange the icons, see the "Icon Order" section of chapter 4, "TV Menu Operations."

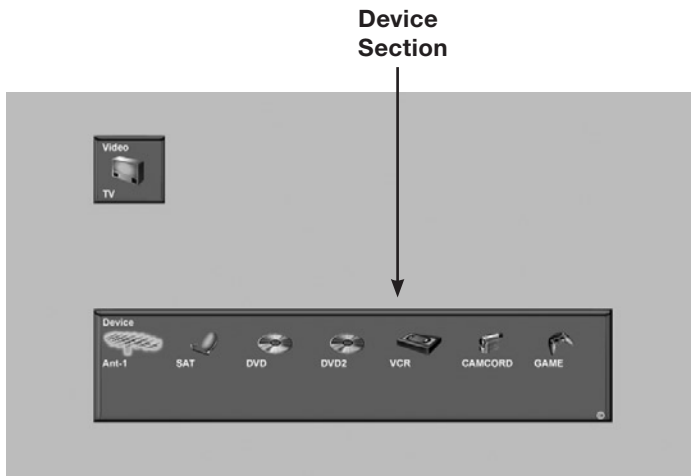

Figure 1. Device Selection Menu

Device Section

To select another device or input, press **ADJUST** ▲▼◀▶ on the TV's remote to move the highlight. Press **ENTER** to select the device to view and hear. The TV inputs are automatically changed.

Video Section

The destination of the device highlighted in the Device Section is displayed here as a TV icon.

ChannelView™ Channel Listings

Figures 2 and 3

Press **GUIDE** while viewing ANT 1 to display a list of available memorized digital (D) and analog (A) channel information (if available from the broadcaster).

ChannelView for digital channels shows the major channel and sub-channels (or bitstreams). Analog channel information is displayed as sent. Press **ADJUST** ▲ or ▼ to scan through all the channels in memory one by one. To cycle through the choices quickly, press **CH** ▲ or ▼.

For detailed program information for digital channels, press **ADJUST** ▶; to return to basic information, press **ADJUST** ◀. This information is sent by the broadcaster. If limited data is shown or no program data appears, it is because the broadcaster is not sending the information. *This is not a defect of your TV.*

Channel	Channel Name	Type	Antenna	Program
2	CBS	A	Ant-1	
2-1	KCBS-DT	D	Ant-1	CBS Local News
4		A	Ant-1	
4-1	KNBC-DT	D	Ant-1	NBC Evening News
7	ABC	A	Ant-1	
7-1	KABC-DT	D	Ant-1	ABC World News
28	PBS	A	Ant-1	
28-1	KCET-DT	D	Ant-1	The 2005 Rose Parade
28-2	KCET-DT	D	Ant-1	Nightly Business Report
30		A	Ant-1	
62-101		D	Ant-1	
62-102		D	Ant-1	
128	CNN	A	Ant-1	
1104	KNBC-DT	D	Ant-1	NBC Evening News

Figure 2. ChannelView screen, current programs. Use **ADJUST** ◀ ▶ to move between the displays for current and future programs.

Channel	Channel Name	Type	Antenna	Time	Program
2	CBS	A	Ant-1		
2-1	KCBS-DT	D	Ant-1		
4		A	Ant-1		
4-1	KNBC-DT	D	Ant-1		
7	ABC	A	Ant-1		
7-1	KABC-DT	D	Ant-1		
28	PBS	A	Ant-1		
28-1	KCET-DT	D	Ant-1		
28-2	KCET-DT	D	Ant-1		
30		A	Ant-1		
52-101		D	Ant-1		
62-102		D	Ant-1		
128	CNN	A	Ant-1		
1104	KNBC-DT	D	Ant-1		

Figure 3. ChannelView screen, future programs on the selected channel (digital channels only)

IMPORTANT

Leave the TV powered off for a while each day for the TV to receive ChannelView updates. The updates may take from five to 15 minutes to complete, depending on the number of channels in memory. Program listings will be temporarily lost if the TV loses power.

GUIDE and Devices

For satellite receivers and some cable boxes, when the remote has been programmed for the device, **GUIDE** displays the on-screen programming guide for the receiver or cable box. Press **ADJUST** ▲▼◀▶ and **ENTER** to navigate the displayed Guide.

On-Screen Information

When you turn on the TV, change devices, change channels, or when you press the INFO key on the remote control, the TV displays the current status. Below are the most common displays. Please note that seldom or never do all of the different status indicators appear at the same time.

Analog Program

Figure 4

1. Antenna or Device being viewed
2. Analog channel being received: If antenna being viewed
3. Channel name (if manually programmed)
4. Signal Type being received
Possible:
ANT 1 or Input 1,2 – 480i
Component 1, 2 – 480i, 480p, 720p or 1080i
5. Screen format being used
Possible:
Analog 480i /480p signals – Standard, Expand, Zoom, Stretch, Stretch Plus, Narrow
720p/1080i signals - Standard, Wide Expand
6. Stereo and/or SAP being broadcast
7. V-Chip Ratings
8. Channel in SuperQuickView bank 2
9. Day and Time
10. Sleep Timer remaining time
11. PIP source and channel
12. Audio Mute on

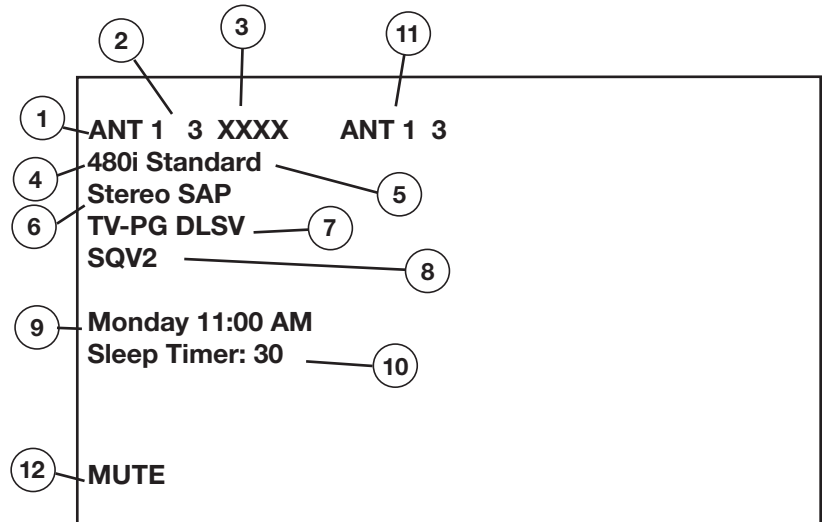

Figure 4. Analog program on-screen display

Digital Program

Figure 5

1. Digital Major and Sub channel number
2. Digital Channel Name (only if broadcast)
3. Signal Type being broadcast/received
Possible: SD 4:3, SD 16:9 or HD
4. Screen format being used
Possible:
SD 4:3 - Standard, Expand, Zoom, Stretch, Stretch Plus, Narrow
SD 16:9 or HD - Standard, Wide Expand
5. Language(s) being broadcast
6. Program Name (if broadcast)
7. Copy-Protection Status
Possible:
COPY ONCE: Program can be recorded
COPY NO MORE: Program can never be recorded.

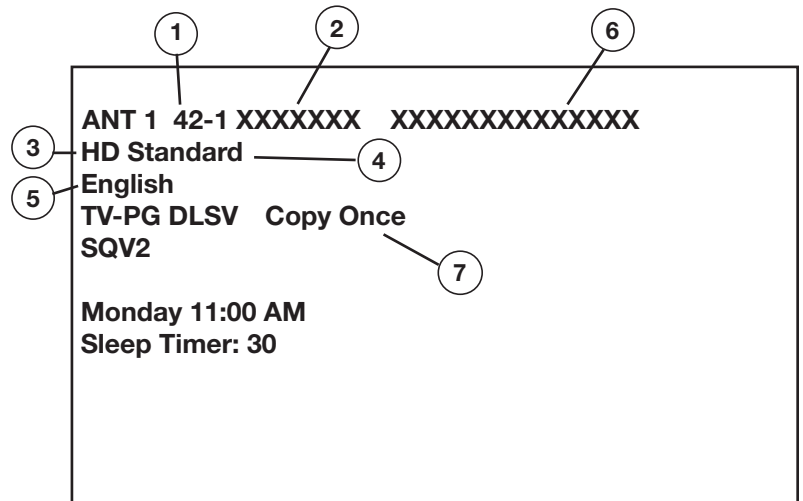

Figure 5. Digital program on-screen display

Operation of PIP and POP

The picture-in-picture (PIP) and picture-outside-picture (POP) features let you view pictures from two different sources at the same time. The available combinations are:

View as either main picture or sub-picture	<ul style="list-style-type: none"> ■ Analog channels ■ Devices on Video or S-Video inputs ■ Devices on component inputs ■ Devices on either HDMI input
View as main picture only	<ul style="list-style-type: none"> ■ Digital channels received from the ANT 1 input

To Use PIP/POP

- Press PIP/POP to activate the PIP/POP option.
- Repeatedly press the PIP/POP key on the TV remote control and within seconds of each press, the PIP/POP cycles through the displays shown here.

To Turn Off PIP/POP

- Press PIP/POP repeatedly until the TV returns to full-screen mode.
- Wait at least 10 seconds after PIP/POP is on screen, then press PIP/POP again. The next time you activate PIP/POP, the last-used PIP/POP option will be displayed.

Changing the PIP/POP Device

When PIP/POP is displayed, press PIP DEVICE to change the PIP/POP picture source device. Choose the picture source from a menu similar to the Device Selection menu (see figure 7).

Changing PIP/Side-by-Side Channels

When the sub-picture is from ANT 1, press PIP CH to scroll up and down through memorized channels.

Exchanging Program Images

Press EXCH to exchange the main picture and the PIP/POP picture. Pictures from digital channels can only be shown as the main picture.

Moving a PIP Image

If no menus are on screen, press ADJUST ▲▼◀▶ to move the PIP display anywhere on the main screen.

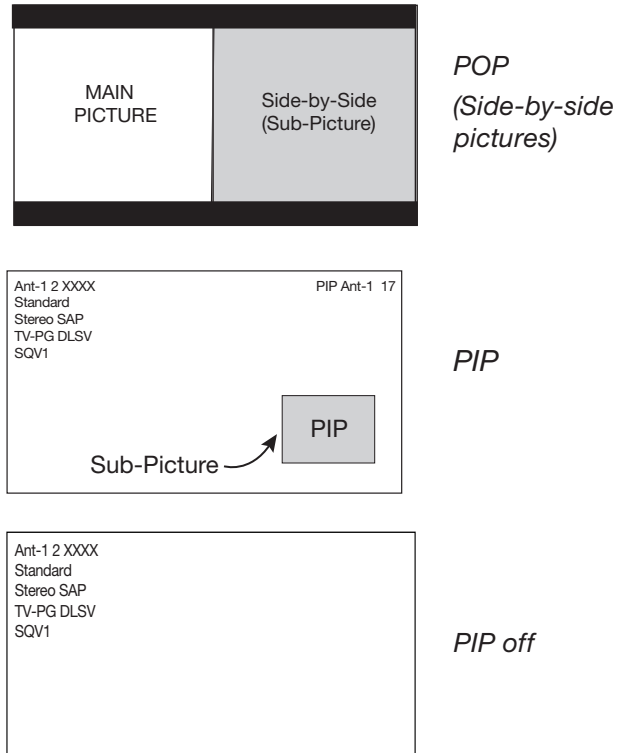

Figure 6. Press the PIP/POP key to cycle through the display options.

Freezing the PIP and Side-by-Side Pictures

Press PAUSE to freeze the PIP and side-by-side images. Press PAUSE again to return to a “live” image.

IMPORTANT

- **The Side-by-Side feature cannot show the picture from the same device on both sides.**
- **Pictures from HDMI-1 and HDMI-2 cannot be shown together as main and sub-pictures**

PIP Device Selection Menu

Figure 7

The PIP Device Selection menu has the same general layout as the Device Selection menu. Grayed-out device icons are unavailable as PIP/POP sources.

Selecting the PIP/POP Device

1. Press the PIP DEVICE button on the remote control to display the PIP Selection menu.
2. Press ADJUST ▲▼◀▶ to move the highlight to the icon for the device you wish to show in the sub-picture.
3. Press ENTER to make the change and close the menu.

This menu displays “PIP” under the Video icon to distinguish it from the Device Selection menu

PIP/POP Device Section

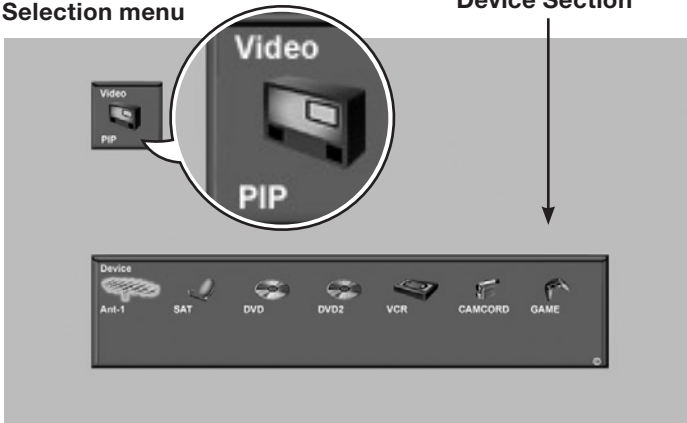

Figure 7. PIP Device Selection menu

TV Display Formats

This is a widescreen TV, also known as a 16:9 TV. This shape reflects the new types of images available from HDTV and many DVDs. There are still many older style narrow-screen images (called 4:3 aspect ratio) you will encounter. While there will never be a perfect solution for displaying a narrow image on a wide screen, Mitsubishi offers several display formats from which to choose.

Press **FORMAT** on the TV remote control to cycle through the available display formats. The last-used format for each device is used when you return to that device.

Note: Not all formats are available for PIP/POP. Side-by-Side is only available in Standard and Expand formats.

DVD Definitions

Anamorphic (or Enhanced for Wide-Screen TV's):

These DVDs are recorded in a special way to properly show widescreen images on 16:9 TV sets in the Standard format mode. This is the recommended choice.

Non-Anamorphic (or 4:3, 1:33:1, Letter Box or Full Screen):

These DVDs are recorded for use with traditional shaped TVs. They may be full screen (4:3 or 1:33:1) which crops movies to fit the narrow TV, or Letter boxed, which adds black top and bottom bars.

This information may or may not be listed on the DVD case. Some DVDs support both types of recordings.

Signal Definitions

480i Signals: Traditional analog interlaced signals from or through ANT 1, INPUT 1–3, COMPONENT inputs, and HDMI inputs.

480p Signals: Progressive-scan analog DVD signals on COMPONENT inputs and HDMI inputs.

720p & 1080i Signals: High-definition analog signals received through COMPONENT and HDMI inputs. These signals are always 16:9 (widescreen).

SD 4:3: Standard-definition narrow-screen format signals from digital channels.

SD 16:9: Standard-definition widescreen format signals from digital channels.

HD: High-definition wide-screen format signals from digital channels. These signals are always 16:9 (widescreen). Note that broadcasters often convert standard

programming not originally created in high definition. These standard-definition programs usually originated with a 4:3 aspect ratio. To fit the 16:9 format required for high-definition broadcast, the broadcaster may fill the space by either expanding the picture or by adding side bars.

Format Definitions

Standard: This is the full-screen format. HDTV signals use this format. This format is useful for displaying Anamorphic DVDs that have 1.78:1 or 1.85:1 aspect ratios. Anamorphic DVDs that have a 2.35:1 aspect ratio are displayed with black bars at the top and bottom, but show the entire image correctly. Narrow (4:3) images are stretched evenly from side to side. Available for all signals.

Expand: This enlarges the picture to fill the screen, cropping off some of the image at the top and bottom. This is useful for reducing the letter box top and bottom bars of non-anamorphic DVD images. Available for analog 480i, 480p and digital SD 4:3 signals only.

Zoom: This enlarges the picture, cropping off some of the image at each side and top and bottom. This is useful for removing or reducing the black top and bottom bars on anamorphic DVDs with a 2.35:1 aspect ratio. Available for analog 480i and 480p and SD 4:3 signals only.

Stretch: This format stretches a narrow (4:3) image across the screen; there is less stretch in the center than at the sides, however. This allows the entire narrow image to be displayed across the screen with less distortion than is seen in the Standard format. Available for analog 480i and 480p and SD 4:3 signals only.

Stretch Plus: Similar to stretch mode, but to minimize distortions on the side, the picture is expanded to crop off portions of the top and bottom. When no PIP is displayed, you can press **ADJUST** up or down to vertically adjust the position of the picture. Available for analog 480i and 480p and SD 4:3 signals only.

Narrow: This format displays narrow (4:3) images in their original shape, and adds stationary black side bars to fill the screen. Available for 480i, 480p and digital SD 4:3 signals only.

Wide Expand: Enlarges the picture, cropping some of the image on both sides. This Expand format is useful to remove or reduce black side bars added to narrow images that are converted to 16:9 signals for digital broadcast. Available for analog 1080i, 720p, digital SD 16:9 and digital HD signals.

TV Display Formats

ORIGINAL SIGNAL
Non-anamorphic or SD 4:3

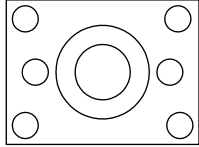

ORIGINAL SIGNAL
Anamorphic DVD

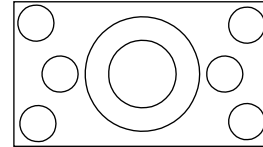

TV Display

Standard

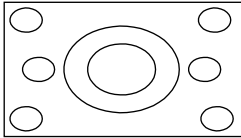

(not recommended, distorted)

Standard

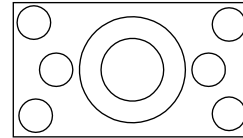

(recommended)

Expand

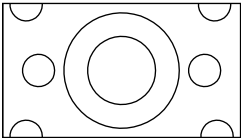

(recommended for letterboxed)

Expand

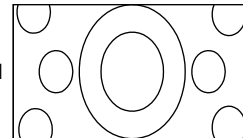

(not recommended, distorted)

Zoom

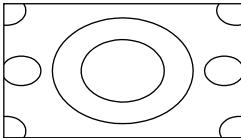

(not recommended, distorted)

Zoom

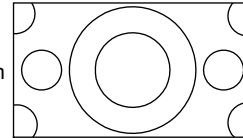

(recommended for anamorphic 2.35:1)

Stretch

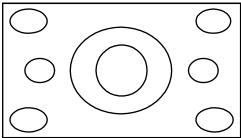

(recommended for standard broadcast)

Stretch

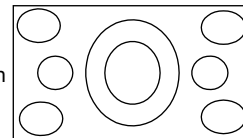

(not recommended, distorted)

Stretch Plus

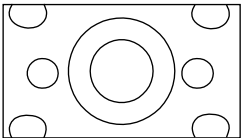

(recommended for standard broadcast)

Stretch Plus

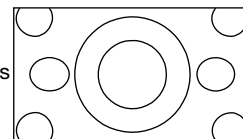

(not recommended, distorted)

Narrow

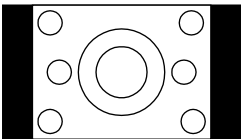

Narrow

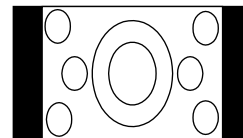

(not recommended, distorted)

**SD 16:9 or
HD Digital**

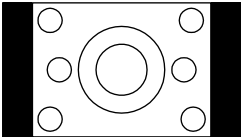

(with side bars in broadcast)

Standard
Original HD or SD
16:9, 720p or 1080i

Wide Expand

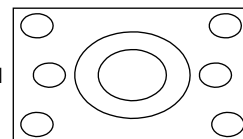

(recommended to remove side bars)

available only for
digital SD 16:9, HD,
analog 1080i or 720p

TV Menu Operations

3D Graphical ▶ViewPoint® Menu System	40
Main Menu	41
Setup Menu	42
Input Name Menu	44
Icon Order Menu	44
Channel Menu	45
Captions Menu	47
V-Chip Lock Menu	49
Audio/Video Menu	53
Audio Settings	54
Video Settings	55

3D Graphical ▶ViewPoint® Menu System

Your TV has Mitsubishi's exclusive 3D Graphical ▶ViewPoint® on-screen operating system, which provides on-screen information for menu choices and changes using the TV's remote control.

▶ViewPoint® Menu Screens



A picture (icon) is highlighted on the menu screen when selected with the ADJUST arrows. You may then make changes within the menu or access sub-menus, if available.



You can also access sub-menus from a button. Sometimes when you select a button, an automatic function begins.

The ▶ViewPoint® system includes the following special features:

- The currently selected icon or button is highlighted with a yellow outline; the text color is yellow.
- On-screen instructions, shown in the message line at the bottom of the menu, provide feature selection and adjustment information.
- Note that some on-screen menu options must be set before other options are available.

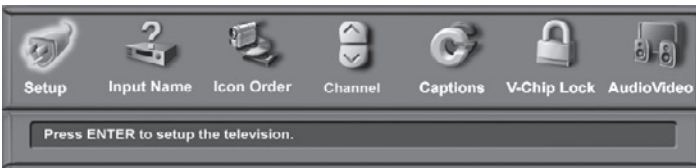

Main Menu: Press the TV MENU key to display the Main menu or move back one menu screen at a time. Instructions for menus always appear in the lower portion of the menu.

▶ViewPoint® Remote Control Buttons

The following buttons on your remote control help you navigate within the ▶ViewPoint® system:

- 1** ADJUST ◀ ▶ ▲ ▼
 - ADJUST ◀ ▶ to select the menu item you want to change.
 - ADJUST ▲ ▼ to change the settings.
- 2** ENTER to open a menu, start an automatic function, or select a check box.
- 3** TV MENU to display the main menu or move back one menu screen at a time.
- 4** CANCEL to clear a setting or stop an automatic function.
- 5** HOME to exit all menus and return to TV viewing.

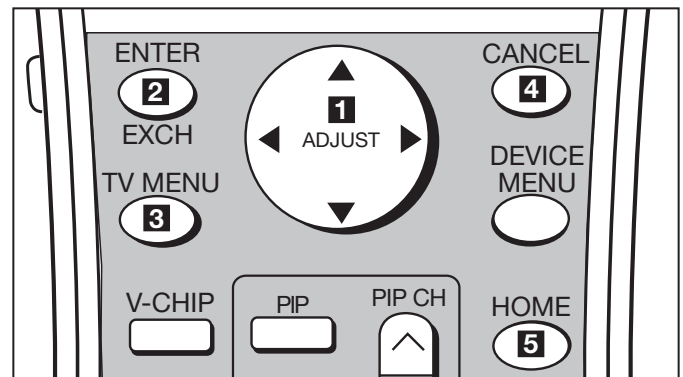

Press ADJUST ▲ or ▼ to change text boxes. Some text boxes have preset labels. Other boxes allow you to select letters, numbers or characters to customize names.

Main Menu

Press TV MENU on the remote control to open the Main menu, figure 1. See below for an overview of the settings available through the Main menu.



Figure 1. Main menu, Setup selected



Setup

- ◆ Select English or Spanish for menus and on-screen displays.
- ◆ Memorize the available channels for the antenna or cable service connected to the ANT 1 input.
- ◆ Set the time for the TV manually or select Auto for the TV to automatically set the time based upon Extended Data Service (XDS) time data (usually broadcast by your local PBS station).
- ◆ Set the TV timer.
- ◆ Reset the lamp reminder.
- ◆ View the TV's software version.



Input Name

Identify the devices connected to the TV so that you can select them from the Device Selection menu.



Icon Order

Rearrange the icons in the Device Selection menu.



Channel

- ◆ Edit channels for the ANT 1 input.
- ◆ For channels broadcast in both digital and analog formats, choose to watch only the digital version.
- ◆ Manually add or delete channels from memory, name channels, or add your favorite channels to a SQV (SuperQuickView™) list.
- ◆ View signal strength of the currently tuned digital channel.



Captions

- ◆ Display closed captions if sent by the broadcaster.
- ◆ Select settings for analog or digital captions.



V-Chip Lock

- ◆ Block or allow programing based on rating signals sent by the broadcast station.
- ◆ Lock the TV by time.
- ◆ Lock the front-panel buttons.



Audio/Video

- ◆ Reset the A/V Memory to the original factory settings for a selected device.
- ◆ Customize individual audio and video settings.
- ◆ Display a blue screen when viewing a device with no signal.
- ◆ Enable/disable Film Mode.
- ◆ Turn the TV speakers on or off.

Setup Menu

Setup Menu

Figure 2



Figure 2. Setup menu

Language

Display the on-screen menus in either English or Spanish (Español). The first time you powered on your TV, you were requested to select an on-screen-menu language. If you choose to change the selection, all menu text will immediately switch to the language of your choice.

To listen to audio in other languages (when available), see the section entitled “Audio Settings” in chapter 4.

Memorize Channels

For Antenna 1 (ANT 1)

To start channel memorization, first select an input according to the table below.

Input	Condition
ANT 1 Air	When connected to an indoor/outdoor antenna
ANT 1 Cable	When connected to direct cable

Press ENTER to start the automatic channel-memorization process.

During the memorization process, all possible channels on the selected antenna are scanned twice. Analog channels are scanned first and then the process is repeated for digital channels.

To stop the automatic channel-memorization process before it completes, press CANCEL. Channels memorized before you pressed CANCEL are retained in memory. If you start the memorization process again, all previously memorized channels are erased and the process starts over from the beginning.

After channel memorization, the channels in memory can be accessed in ascending or descending order by press-

ing CH ▲ or ▼. Select the Channel Menu to access further channel-editing features, such as channel add or delete, channel name, and SQV custom favorite channel memories.

Clock

Figure 3

You may choose to set the clock either manually or automatically. The TV uses the clock time for timer functions.

Manual

To set the clock manually, select the current time, current date, and time zone for your area.



Figure 3. Clock menu. Setting the clock manually.

Time

Press ADJUST ▲ or ▼ repeatedly to slowly select the hour or press and hold to quickly select the hour. Press ENTER to move to the minutes options. Press ADJUST ▲ or ▼ to select minutes.

Date

Press ADJUST ▲ or ▼ to select the correct date.

Time Zone

Select your correct time zone. Press ADJUST ▲ or ▼ to select the time zone (Atlantic, Eastern, Central, Mountain, Pacific, Alaska or Hawaii) for your area.

Auto

Select the Time Zone and the Daylight Savings time (DST) option that your state uses. Press ADJUST ▲ or ▼ to select Applies if your state or area uses DST, or Ignore if DST does not apply. You may then tune to a channel (on ANT 1) that uses Extended Data Service (XDS) time data, typically a PBS channel.

The Auto selection automatically retrieves the correct time and date information from this channel. Be aware that if a channel displays incorrect time information, it is because of information sent from the broadcaster and is not a defect of the TV.

Setup Menu, continued

When using the Auto option you may find that some channels send the incorrect time and the TV clock is reset every time you tune to those channels. To prevent unwanted clock resets, use the Auto setting to set the clock from a channel sending the correct time, then change the setting to Manual.

Timer

Figure 4

On/Off

The timer allows you to set a time when the TV will automatically change the channel and turn on. You select the time and day for the TV to turn on and the device and channel to display. At your preselected time, the timer will turn on the TV and this message will be displayed: “Press a button for the TV to stay on.” Press any button on the remote control within five minutes or the TV will turn itself off.



Figure 4. Timer menu

Set Day

Select the day or days that the TV will turn on automatically. Press ADJUST ▲ ▼ to select Daily, Mon-Fri (Monday through Friday), or the individual days of the week.

Set Time

Press ADJUST ▲ ▼ repeatedly to slowly select the hour or press and hold to quickly select the hour. Press ENTER to move to the minutes options. Press ADJUST ▲ ▼ to select minutes.

Device

Press ADJUST ▲ ▼ to select the device to use when the timer turns on the TV. If the TV is already on, the timer will switch the TV to this selected device.

Channel

When ANT 1 is the selected device, you may select any memorized channel. Press ADJUST ▲ ▼ to select the

channel and the TV will tune to this channel in memory when the timer turns it on. This includes sub-channels for digital choices.

Lamp Reminder

Select to reset the lamp reminder message after you have changed the lamp cartridge. Press ENTER, then press ENTER again to confirm reset of the lamp reminder. To have an accurate reminder that the lamp cartridge may soon need replacement, reset the lamp reminder only when you replace the lamp cartridge. **See Appendix F for detailed information about changing the lamp.**

Software Version

For servicing purposes it may be necessary to know the software version in your TV. This information is displayed on the Setup menu screen.

Input Name Menu Icon Order Menu

Input Name Menu

Figure 5

Use the Input Name menu to:

- assign useful labels to the TV inputs appearing in the Device Selection menu.
- remove unused inputs from the Device Selection menu by turning off the input.



Figure 5. Input Name menu

1. Press ADJUST ◀ ▶ to move the highlight to the box for the input you wish to rename.
2. Press ADJUST ▲ ▼ to select from the following list. To remove the input from the Device selection menu, select Off.

Cable Box	Game
Camcorder	Satellite
DVD	VCR
DVD2	Off
DVR	
(digital video recorder, recordable DVD)	

Icon Order Menu

Figure 6

The Icon Order menu allows you to rearrange the device icons that appear in the Device Selection menu. Change the sequence to best suit your viewing needs.

To change the icon order

1. Press ADJUST ▲ ▼ ◀ ▶ to highlight the icon to be moved and then press ENTER.
2. Press ADJUST ▲ ▼ ◀ ▶ to drag the icon to the desired position and then press ENTER to set the new position.

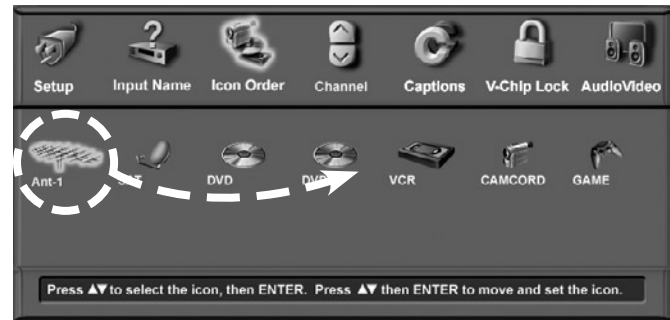

Figure 6. Icon Order menu

Channel Menu

Channel Menu

Figure 7

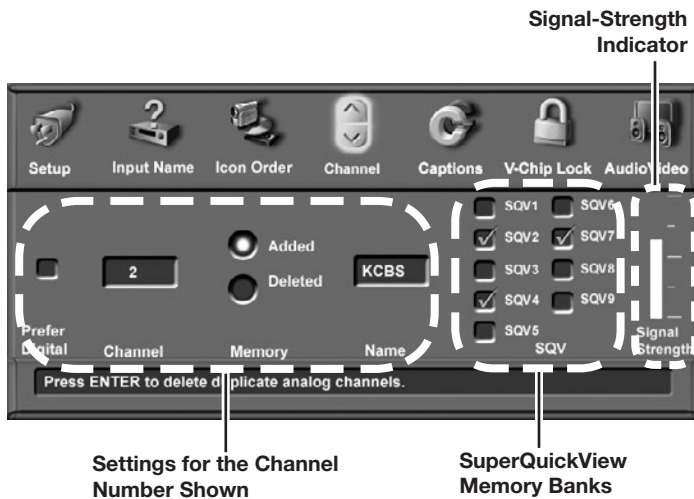

Figure 7. The Channel menu is divided into three sections.

Prefer Digital

When a memorized channel number is available in both analog and digital formats, check the Prefer Digital box to display digital channels and hide analog channels when using CH ▲▼. Remove the check mark to show both analog and digital choices.

Channel

You can select the channel number affected by this menu in any of three ways:

- Press ADJUST ▲▼ to move through channel numbers one at a time, including all memorized and non-memorized channels. If you also wish to tune to the channel, highlight the channel number and press ENTER.
- Press CH ▲▼ to select from channels already in memory. If you also wish to tune to the channel, highlight the channel number and press ENTER.
- Enter the number directly and press ENTER. Note that with this method, you must press ENTER for the screen to display settings for the selected channel.

Channel numbers can be one part, analog or digital (up to the number 16383), or two part for digital channels. For a two-part digital channel, press SUB/CANCEL on the remote to enter a separator after the first, second, or third number, depending on the broadcaster's channel information.

For digital channels, when the broadcaster has sent a virtual channel number, the virtual channel number is shown in the text box and the original digital channel is shown below on screen as a reference. One original channel number can be associated with several different virtual channels.

Memory

After the available channels have been memorized with Memorize Channels on the Setup menu, weaker channels can be added or unwanted channels can be deleted. Press CH ▲▼ on the remote control to see the channels in memory. Press ADJUST ▲▼ to select Added or Deleted for the channel shown in the Channel number box.

Name

Analog channels shown on ANT 1 can be named (up to four characters). After you enter a name, it will appear on the TV screen, next to the channel number.

1. Press ADJUST ▲▼ to select each letter.
2. Press ENTER to set the letter and move to the next letter position.
3. Press CANCEL to move back one position.

Digital channels are named automatically if the broadcaster sends the information.

SQV (SuperQuickView™)

Figure 17

SQV (SuperQuickView™) allows you to put together lists of your favorite channels available on the antenna input. You can store channels in any of the nine different SQV memory banks. You can also store the same channel in multiple memory banks. Once you have added a channel to an SQV memory, "SQV" and the memory bank number appear under the tuned channel number on the TV screen.

Managing SQV Memory Banks through the Menu

Adding SQV Channels Using the Menu

1. Select the channel using the "Channel" option box or press CH ▲▼.
2. Highlight the desired bank (SQV1-SQV9).
3. Press ENTER to check mark the selected SQV memory bank.
4. Repeat for additional channels or banks.

Channel Menu, continued

Removing SQV Channels Using the Menu

1. Highlight the box for the SQV bank number.
2. Press ENTER to remove the check mark.

Managing SQV Memory Banks Using the Remote Control

Viewing and Changing SQV Banks

1. Press the SQV button.
2. To change memory banks, press a number button within five seconds of pressing the SQV button.
3. Press the SQV button repeatedly to cycle through the channels available in that bank.

Adding SQV Channels

1. Press CH ▲ ▼ or number buttons to select the channel you want to add to the current SQV memory bank.
2. Press and hold the SQV button for about 2 seconds. When “SQV” and the memory bank number appear under the channel number, the channel has been added successfully.

Removing SQV Channels

1. Press the SQV button and then the memory bank number.
2. Press the SQV button repeatedly until you see the desired channel.

3. While the channel number and SQV indicator (with correct bank number) are still displayed on the screen, press the CANCEL button. If the CANCEL button is not pressed before the SQV indicator disappears automatically, the channel will not be removed.
4. When the SQV indicator disappears, the channel has successfully been removed only from that bank. “Other” banks remain unchanged.

Signal Strength

Displays the approximate signal strength of the currently tuned digital channel. Use this indicator to help you adjust the antenna direction for optimal signal strength. The higher the bar, the stronger the signal. Does not apply to analog channels.

To view the effects of antenna adjustments, tune to the channel you wish to measure while remaining in this menu. To tune to a channel, either:

- Highlight the channel box, press CH ▲ ▼ or ADJUST ▲ ▼ to display the desired channel number, and press ENTER.
- Enter the channel number on the remote control and press ENTER.

Captions Menu

Captions Menu

Figure 8

For analog channels, broadcasters can send either standard closed captions or text service. Standard closed captions follow the dialogue of the characters on screen and display in a small section of the screen. Text service closed captions often contain information such as weather or news and cover a large portion of the screen.

For digital channels, broadcasters can send up to six different captioning selections or can send analog captions that are the same as those sent by the analog station. Each TV station may broadcast only one or two types of captions or none at all. The TV cannot decode closed captions received on COMPONENT or HDMI inputs.



Figure 8. Captions menu

Analog Captions

The TV can display one of the following captions for analog sources:

- **CC1, CC2, CC3, or CC4:** standard closed-caption signals
- **Text1, Text2, Text3, or Text4:** Text-service signals
- **On if mute:** Closed captions appear when audio is muted. When selected, press MUTE on the TV remote control to turn on/off the standard closed-caption signal CC1.
- **Off:** No closed captions.

IMPORTANT

When analog text closed captioning is selected, a large black or gray box appears on your TV screen if no text signal is broadcast.

Background

To make the analog closed captions easier to read, you can choose to display the background color as either black or gray behind the text.

Digital Captions

The following display options are available for digital sources:

- **Captions 1–6:** Sent by broadcaster.
- **On if Mute:** Closed captions are displayed when audio is muted. When selected, press MUTE on the TV remote control to turn captioning on/off (Caption 1).
- **Off:** No closed captions.

Note: For digital programs, if the broadcaster is sending only analog captions converted to digital, then the analog caption settings apply.

Appearance

The closed-captions provider selects the default options when sending digital closed captions. Select Custom to override defaults and customize the appearance of closed captions. These settings do not apply to analog closed captioning converted to digital.

Digital Settings

Figure 9

The Digital Settings menu allows you to customize the appearance of the closed captions sent by the broadcaster. Digital settings do not apply to analog closed captions converted to digital.

To open the Digital Settings menu, select Custom for the Appearance option. Move the highlight to the Digital Settings icon and press ENTER.

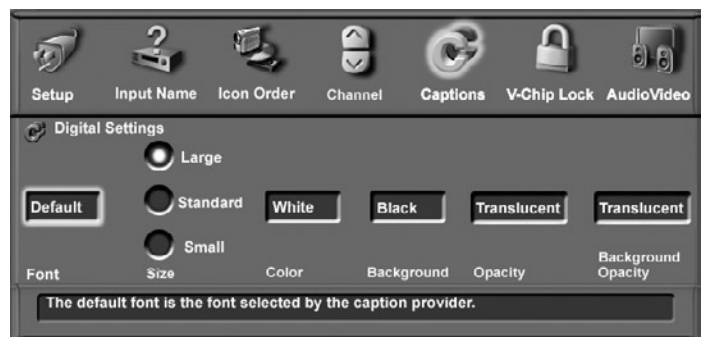

Figure 9. Closed Captions, Digital Settings menu

Captions Menu, continued

Fonts

The available font options are as follows:

- **Default:** Selected by the closed-captions provider
- **Font 1:** Monospaced font with serifs
- **Font 2:** Proportionally spaced font with serifs
- **Font 3:** Monospaced font without serifs
- **Font 4:** Proportionally spaced without serifs
- **Font 5:** Casual font
- **Font 6:** Cursive font
- **Font 7:** Small capitals font

Size

Select your desired font size. Large is the recommended font size.

Color

The available font colors are listed below. Text and background cannot be set to the same color.

White	Yellow
Black	Green
Magenta	Cyan
Red	Blue

Background

To make the digital closed captions easier to read, you can change the background color. The available background colors are listed below. Text and background cannot be set to the same color.

White	Yellow
Black	Green
Magenta	Cyan
Red	Blue

Opacity (Font)

You can customize the visibility of your fonts using the following categories:

- **Translucent:** TV program is faintly visible behind the text
- **Transparent:** Invisible text reveals the TV program behind.
- **Opaque:** Solid text blocks view of the TV program
- **Flashing:** Text flashes at intervals

Background Opacity

You can customize the background for digital captions using the following settings:

- **Translucent:** TV program is dimly visible behind the background
- **Transparent:** No visible background
- **Opaque:** Solid background; covers TV program
- **Flashing:** Background flashes at intervals

IMPORTANT

Mitsubishi recommends you use contrasting colors for captions and background. Black translucent background combined with a white font makes an easy-to-read combination.

Use care when selecting custom colors. Your choice may change the readability of captions.

IMPORTANT

The content of captions is determined by the broadcaster. If your captions show strange characters, misspellings, or odd grammar, it is not a malfunction of the TV.

V-Chip Lock Menu

V-Chip Lock Menu Overview

Figure 10

The V-Chip Lock menu gives you access to three different types of TV locks. You must use a pass code to open this menu to enable/disable the lock options. The three different types of locks available are:

- Ratings (U.S. V-Chip/Other)**
 Lets you restrict access to programming based on rating signals sent by the broadcaster. For U.S. V-Chip signals, you can also set the time of day for restrictions to be in effect.
- Lock by Time**
 Lets you restrict TV use by time of day.
- Front Button Lock**
 Lets you disable the controls on the front of the TV. Use this option if there are small children near the TV who may be tempted to press the front-panel buttons.

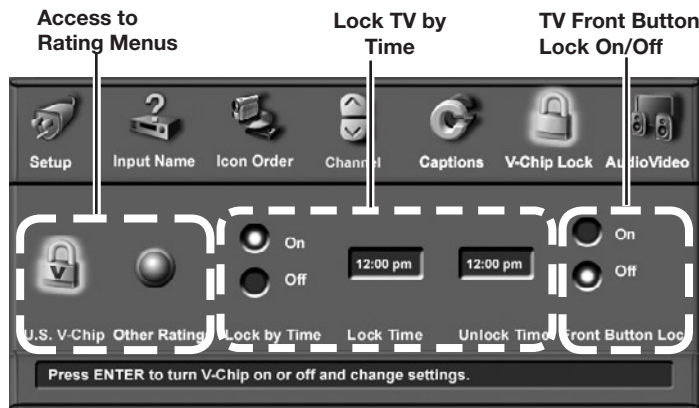

Figure 10. V-Chip Lock menu

Setting a Pass Code

You are prompted to enter a pass code whenever you select V-Chip Lock on the menu or press the V-CHIP key on the remote control. To set a pass code for the first time:

- Do one of the following:
 - Press V-CHIP on the remote control.
 - Press TV MENU, highlight V-Chip Lock, then press ENTER.

A screen prompting you for a pass code will display.

- Input a four-digit pass code using the number keys on the remote control.
 - Press CANCEL to delete a number and move back one space.
 - Press MENU or HOME to exit without setting a pass code.
- Press ENTER to confirm the pass code just input.

To reset the pass code, see the procedure in Appendix A.

IMPORTANT

If you forget your four-digit pass code, see Appendix A.

Rating Menus

The rating menus allow you to:

- Turn rating restrictions on or off
- Change the permitted rating level
- Set the time of day to enforce rating restrictions (U.S. V-Chip ratings only)

The TV comes from the factory with pre-set U.S. V-Chip ratings and with the V-Chip lock turned off. The pre-set ratings are TV-PG (TV rating) and PG (movie rating). If you turn on V-Chip blocking, these presets allow only programs rated TV-PG/PG or lower.

After changing channels or devices, there may be a delay of up to five seconds before the rating restrictions take effect.

U.S. V-Chip Menu

Figure 11



Figure 11. U.S. V-Chip menu

You can turn on U.S. V-Chip restrictions from this menu or by using the V-CHIP key on the remote control. Use the U.S. V-Chip menu to change the permitted rating levels.

V-Chip Lock Menu, continued

1. Highlight the U.S. V-Chip icon  on the V-Chip Lock menu (figure 10) and press ENTER to open the U.S. V-Chip menu (figure 11).
2. Press ADJUST ▲ or ▼ to select On or Off.
3. If you selected On, press ADJUST ► to move to the TV Rating box.
4. Press ADJUST ▲ or ▼ to select the TV rating level you want to allow.
5. Press ADJUST ► to move to the TV content categories.
 - Press ADJUST ▲ or ▼ to move between categories.
 - Press ENTER to add check marks to the TV content categories you want to block.
6. Press ADJUST ► to move to the Programs Not Rated box. Press ENTER to add or delete a check mark to allow or block programs that are not rated.

NOTE: Use care when choosing to block unrated programming. News programs and emergency bulletins carry the “None” or “NR” (Not Rated) V-Chip signal, and these are blocked with this option active.

7. Press ADJUST ► to move to the Movie Rating box. Press ADJUST ▲ or ▼ to select the movie rating level you want to allow. Detailed information on rating guidelines follows this discussion of the V-Chip Lock menu.
8. To set the time of day when these restrictions will be in effect, press ADJUST ► to move to the Start box. To set the time:
 - a. With the highlight on the hour number, press ADJUST ▲ or ▼ repeatedly to change the hour. You can also just press and hold to change the hour.
 - b. Press ENTER to move the highlight to the minutes.
 - c. With the highlight on the minutes number, press ADJUST ▲ or ▼ repeatedly to change the minutes. Just press and hold to move quickly through the numbers.
 - d. Press ENTER to move the highlight to the am/pm option. Press ADJUST ▲ or ▼ to make a selection.
 - e. Repeat these steps for the Stop time.
9. Press TV MENU to return to the V-Chip Lock menu or press HOME to exit all menus.

NOTE: To make the V-Chip restrictions active twenty-four hours a day, set V-Chip Start and Stop to the same time.

Other Ratings Menu

Figure 12

This TV is able to recognize alternative rating systems that may come into effect in the future. The Other Ratings menu will allow you to block digital programming based on such alternative rating systems. The alternative rating systems will apply to digital programming only.



Figure 12. The Other Ratings menu is available only if the TV receives broadcast signals carrying an alternative rating system.

Note: The Other Ratings button will remain inaccessible until the TV receives signals for an alternative rating system.

1. Highlight the button labelled Other Ratings on the V-Chip Lock menu (figure 10) and press ENTER to open the Other Ratings menu (figure 12).
2. Press ADJUST ▲ ▼ to select On or Off.
3. If you selected On, press ADJUST ► to move to the Rating Group box.

Note that you can change settings only for the rating system available on the currently tuned channel. In the figure above, for example, the Canadian rating system is in effect. To change settings at a later time for the Canadian rating system, you must again tune to a channel broadcasting the Canadian system.
4. Press ADJUST ▲ ▼ to select from the subgroups available for the rating system, e.g., English or French.
5. Press ADJUST ► to move to the Rating box.
6. Press ADJUST ▲ ▼ to select the program rating level you want to block.
7. Press ENTER to add a check mark to indicate blocking is in effect for the rating. When a rating shows a check mark, press ENTER to remove the check mark and allow programs with this rating.

V-Chip Lock Menu, continued

8. Repeat steps 3 through 7 for each additional rating system you would like to set up.
9. Press TV MENU to return to the V-Chip Lock menu or press HOME to exit all menus.

The V-CHIP Key

Press the V-CHIP key on the remote control to turn the U.S. V-Chip lock on and off without going through the menu. A screen will appear prompting you for your pass code. Note that to change V-Chip settings, you must open the V-Chip Lock Menu and then open the U.S. V-Chip menu.

Lock by Time

Lock by Time allows you to entirely block use of the TV during specified hours. During the lock time, you must use your pass code to view the TV. To lock the TV by time:

1. Press ADJUST ▲ or ▼ to select On or Off for Lock by Time.
2. Press ADJUST ► to move to the Lock Time box.
 - a. With the highlight on the hour number, press ADJUST ▲ or ▼ repeatedly to change the hour. You can also just press and hold to change the hour.
 - b. Press ENTER to move the highlight to the minutes.
 - c. With the highlight on the minutes number, press ADJUST ▲ or ▼ repeatedly to change the minutes. Just press and hold to move quickly through the numbers.
 - d. Press ENTER to move the highlight to the am/pm option. Press ADJUST ▲ or ▼ to make a selection.
 - e. Press ADJUST ► to move to the Unlock Time and set the time as described above.

To make Lock by Time active 24 hours a day, set the Lock and Unlock Times to the same time.

Front Button Lock

Figure 10

Front Button Lock lets you disable controls on the front panel to prevent inadvertent changes to TV settings. Select On to disable the buttons and select Off to restore their operation.

To disable the front button lock without using the remote control, press and hold the MENU button on the front panel for more than eight seconds. If the TV is on, a message will display confirming release of the Front Button Lock.

Bypassing V-Chip Lock and Lock by Time

If you try to watch blocked programming, a notice appears prompting you for a pass code. To use the TV, do one of the following:

- Input your four-digit pass code and press ENTER.
- Change to a channel airing an allowed program or change to another device.

If you try to use the TV when it is locked by time, a similar screen appears, prompting you for your pass code.

To reactivate the V-Chip lock or TV lock by time after using the pass code, power the TV off and then on.

U.S. V-Chip Ratings

V-Chip Signal Information

When provided by the broadcaster, V-Chip ratings can be used to control which programs can be viewed or will be blocked. When V-Chip ratings are sent, you will see the ratings when you change the channel or when you press the INFO button on the remote control. Both TV and Movie ratings will display. TV ratings apply to programs and movies developed for TV and may have supplemental blocking by content categories. Movie ratings use MPAA ratings for movies released in theaters.

V-CHIP EXCEPTIONS:

1. V-Chip is not effective for programs viewed on devices connected to component inputs or HDMI. Many of these devices, however, have their own parental control systems.
2. Videotapes, laser discs and DVDs may not contain V-Chip rating signals. If they don't contain the V-Chip signal, V-Chip cannot block the program or movie.
3. Broadcasters are not currently required to include V-Chip rating signals at this time. If the broadcaster does not include the V-Chip rating signal, V-Chip cannot block the program.

TV Ratings:

Used with TV programs and Made-for-TV movies.

TV-Y Youth, for children under the age of 7.

TV-Y7 Youth, 7 years old and older.

TV-G General Audience. For the entire family to view.

TV-PG Parental Guidance. Parental Guidance is recommended, may not be suitable for some children.

TV-14 Adolescent 14 years old and older. Not recommended for children under the age of 14.

TV-MA Mature Audience. For adults only.

TV Rating	FV	D	L	S	V
TV-Y					
TV-Y7	X				
TV-PG		X	X	X	X
TV-14		X	X	X	X
TV-MA			X	X	X

Content Categories:

Used in association with the TV ratings above.

FV Fantasy Violence—applies to TV-Y7 only.

D Sexual Dialog—applies in different degrees to TV-PG and TV-14.

L Adult Language—applies in different degrees to TV-PG, TV-14, and TV-MA.

S Sexual Situations—applies in different degrees to TV-PG, TV-14, and TV-MA.

V Violence (graphic or realistic)—applies in different degrees to TV-PG, TV-14, and TV-MA.

When you select a TV rating, you are selecting the least-restrictive program level that can be viewed. For example, if you select TV-PG, you are allowing programs rated TV-Y, TV-Y7, TV-G and TV-PG to be seen and blocking programs rated TV-14 and TV-MA. When you select a TV Content category, you will block all TV programs that have the same content category listing. For example, if you select to block V (Violence) at the TV-14 level, you will also block any program that has the V category listing at the TV-PG rating level as well.

Movie Ratings:

Used with theater released movies and direct-to-video movies.

G General Audience—Designed for the entire family to view.

PG Parental Guidance—Parental Guidance is recommended, may not be suitable for some children.

PG-13 Parental Guidance 13 years old and older—Not recommended for children under the age of 13.

R Restricted—Restricted in the theater to 17 years old and older unless accompanied by an adult.

NC-17 No Children 17 or under—Restricted in theater to 18 years old and older.

X Adult—Designed for and restricted in the theater to adult audiences only.

When you select a movie rating, you are selecting the least-restrictive program level that can be viewed. For example, if you select a movie rating of PG-13, you are allowing movies rated G, PG and PG-13 to be seen and blocking movies rated R, NC-17, and X.

Programs Not Rated: Used for programs that are not rated, such as news, sports, weather, emergency bulletins, or movies prior to or without MPAA Ratings. This does not include programs without V-Chip signals.

IMPORTANT

If you elect to block programs that carry the V-Chip rating "Programs Not Rated," you may block news or emergency bulletins, when "None" or "NR" Not Rated V-Chip rating is included. Use care when blocking programming that is not rated.

Audio/Video Menu

Audio/Video Menu

Figure 13

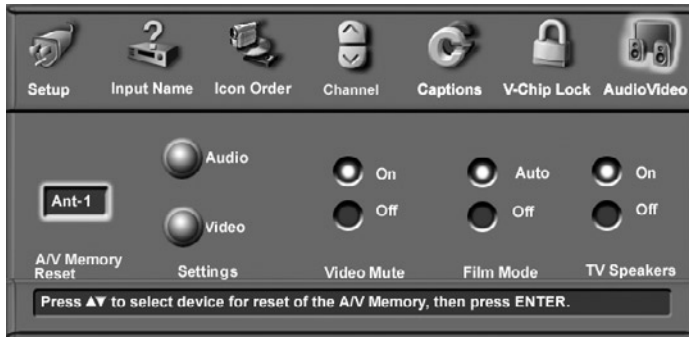

Figure 13. Audio/Video Menu

A/V Memory Reset

A/V Memory Reset allows you to reset the A/V settings for a specific input or device to the original factory settings. Use ADJUST ▲ or ▼ to select the input or device in the box and press ENTER. Note that the audio settings of Balance, Listen to, and Language are general TV settings unaffected by A/V Memory Reset.

To reset all A/V settings at once, including the three general settings, perform an A/V Reset by pressing the front-panel buttons GUIDE and FORMAT simultaneously.

Settings

Each input or device has its own A/V memory. Select the input or device in the A/V Memory Reset box, then select Audio or Video to adjust individual settings. Press ENTER to close the menu and display the individual settings.

Use ADJUST ▲ or ▼ to select the individual settings to adjust. Use ADJUST ◀ or ▶ to make changes. For descriptions of the individual A/V settings, see the section entitled “Audio/Video Menu” in chapter 4.

Video Mute

Video Mute lets you display a blue background when no signal is being received on INPUT 1–3, COMPONENT 1 and 2, or HDMI 1 and 2.

Film Mode (480i signals only)

Auto is the default setting. With Auto selected, the TV automatically detects and applies film-decoding correction for images that originated on 24-frame-per-second film cameras and were then converted to 30-frame-per-second video for broadcast. Try the Off setting if the TV adds too many jagged edges to the images.

When the original video was filmed on 30-frame-per-second cameras, the Auto setting automatically applies video decoding, the same as is used with the Off setting.

Film Mode is not effective for high-definition signals.

TV Speakers

This selection turns the TV’s internal speakers on or off. You may select Off when sending the sound through a separate stereo system or surround sound A/V receiver.

Note: To prevent damage from a sudden increase in volume, make sure the TV volume is set to low before setting speakers to On.

Using the AUDIO or VIDEO Button on the Remote Control

To adjust individual Audio or Video settings directly with the remote control:

1. Press AUDIO or VIDEO.
2. Press ADJUST ▲ or ▼ repeatedly to cycle through the available options.
3. Press ADJUST ◀ or ▶ to change the setting. After five seconds of inactivity, the setting display will disappear.

NOTE: The effects of the audio settings of Bass, Treble, Balance and Surround only affect the sound heard through the TV speakers.

Audio Settings

Analog and Digital Audio Settings

A slider displays on screen for most settings. When the slider is displayed, it has a numeric value, so that 63 is the maximum, 31 is the mid-point, and 0 is the minimum.

◇ Bass

Enhances or reduces low-pitched sound.

◇ Treble

Enhances or reduces high-pitched sound.

◇ Balance

Adjusts the level of sound between the left and right speakers.

◇ Surround

Creates simulated stereo and surround effects through the TV speakers. Your choices are:

- Off: No surround effects.
- Simulated Stereo: Your TV will create a simulated stereo effect when watching a non-stereo program.
- Surround Sound: Your TV will create a simulated surround effect when watching a stereo program.

◇ Level Sound

Turn On or Off to automatically equalize the volume level when there are significant sound-level differences between program segments, e.g., between regular programming and commercials. To receive the best fidelity with music programs, turn this setting to Off. When connecting to an A/V receiver, set level sound to OFF and turn the TV speakers off to send full dynamics to the A/V receiver.

- SAP (Second Audio Program): Additional monaural sound track that you cannot hear during normal TV viewing. The SAP signal might be related to the program you are watching, (such as a sound track in a foreign language), or it might be unrelated (such as a weather report). If an SAP signal is broadcast, the letters “SAP” are displayed when you tune to the channel.
- Mono: Reduces background noise. Use when receiving a weak stereo audio signal. All audio is played mono with this setting.

Listen to is not available for devices connected to the TV Inputs, component inputs.

Digital-Only Audio Settings

You can set digital-only audio settings while viewing either analog or digital channels, but the settings affect only broadcast digital content.

◇ Language

Determines what possible language you can hear. Your choices are:

English	Portuguese
French	Spanish
German	Other
Italian	

Analog-Only Audio Settings

You can set analog-only audio settings while viewing either analog or digital sources, but the settings affect only broadcast analog content.

◇ Listen to

Determines how your TV receives a broadcast audio signal and plays the sound you hear.

Your choices are:

- Stereo: Default setting. The TV plays stereo broadcasts in stereo and mono broadcasts in mono. The word “Stereo” is displayed when you tune to a channel broadcasting in stereo.

Video Settings

Press the VIDEO key repeatedly to cycle through the Video options to the one you want to change. Use ADJUST ◀ ▶ to change settings.

A slider displays on screen for most settings. When the slider is displayed, it represents a numeric value, with 63 as the maximum, 31 as the mid-point, and 0 as the minimum.

Bright/Natural Modes

Before adjusting the other video settings, cycle through the video settings and set the mode to either Bright or Natural. Bright and Natural modes are available for some settings and allow you to optimize the image for a brighter (daytime) or dimmer (nighttime) viewing environment.

Your TV remembers two independent Contrast, Brightness, and Color Temperature settings, one for each of the two modes. Whenever you change settings for Contrast, Brightness, or Color Temperature, first check which of the two modes (Bright/Natural) is active.

◊ Contrast (Bright/Natural)

Provides a slider to adjust the white-to-black level. Low contrast shows a variety of shades in darker images, while high contrast shows darker images more uniformly black and makes colors appear more vibrant. In most home lighting situations, a medium contrast looks best. High contrast is good for brightly lit environments.

◊ Brightness (Bright/Natural)

Provides a slider to adjust the overall brightness of the picture.

◊ Color

Provides a slider to adjust the color intensity.

◊ Tint

Provides a slider to adjust the ratio of red to green.

◊ Sharpness

Provides a slider to adjust the detail and clarity.

◊ Color Temp (Bright/Natural)

Allows you to adjust how white images are displayed. Your choices are:

- Low: White images have a warm cast to them. This adjustment is an average and can vary due to ambient room lighting, video scene brightness, and the TV's age. Natural/Color Temp at the low setting displays video at the 6500K industry standard for NTSC pictures.

- High: White images have a cool cast to them. This setting may provide the most realistic picture under bright lighting.

◊ PerfectColor™

Allows adjustment of any or all of six colors (Magenta, Red, Yellow, Green, Cyan and Blue) to create color balance. When you select PerfectColor and press ENTER, you can select either automatic or manual (individual) adjustment.

With manual adjustment, individual sliders for each color are displayed. Highlighted text shows which slider you are adjusting. Each TV input or device has a memory for PerfectColor. Press CANCEL to reset the colors to the default settings.

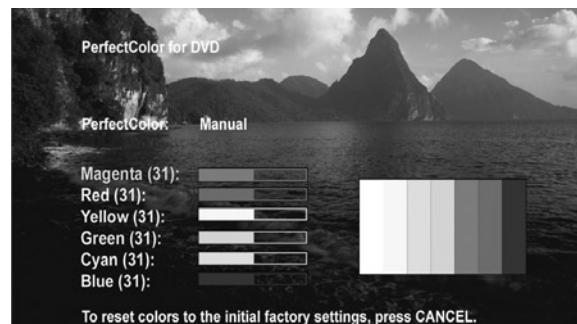

Figure 14. PerfectColor™ adjustment sliders

◊ Video Noise

Use to reduce minor noise (graininess) in the broadcast received on ANT 1, INPUT 1–3, COMPONENT 1 and 2, and HDMI 1 and 2. Use the Standard setting with good-quality signals.

Appendices

Appendix A: Bypassing the V-Chip Lock	59
Appendix B: Remote Control Programming	61
Appendix C: Specifications	64
Appendix D: General Cleaning	66
Appendix E: Filter Cleaning	67
Appendix F: Lamp Cartridge Replacement	68
Appendix G: Troubleshooting	70
System Reset Button	72
TV Reset Menu	72
Demo Mode	72
Service and Support	72

Appendix A: Bypassing the V-Chip Lock

**Lock Bypass Instructions Have Been Filed for
Future Reference**

Bypassing the V-Chip Lock

After you set the lock, you need your pass code to view a V-Chip-locked program, view the locked TV, cancel the lock, or enter the V-Chip Lock menus.

If you forget your pass code, you can view the locked TV without entering your pass code. When prompted for your pass code, press the number 9 and QV buttons on the TV remote control at the same time. This process temporarily unlocks the TV.

When entering the V-Chip Lock menu, this process deletes your old pass code and prompts you to enter a new pass code. Press HOME to exit the menu without resetting the pass code.

Deactivating the Front Button Lock

Press and hold the MENU button on the TV front panel for over eight seconds.

IMPORTANT

Cut along the dotted line and file bypass instructions in a safe place for future reference.

IMPORTANT

When changing or deleting your pass code, you must use the remote control included with this TV. You cannot use a Mitsubishi remote control from another component or a “universal” remote.

This page intentionally left blank

Appendix B: Remote Control Programming

Programming for Most Equipment Types

1. Move the slide switch at the top of the remote to the position for the product you want to control.
2. Press and hold POWER on the remote control.
3. Enter the first three-digit code listed for your equipment, and then release the POWER button on the remote control.
4. Point the remote control at the equipment and press the POWER button.
 - If the equipment responds, the remote control is properly programmed to operate the equipment.
 - If the equipment does not respond, repeat steps 2–4 with the next three-digit code listed for your equipment.
5. Once you have determined the correct code number, mark it for future reference.

Special Programming for Use with an A/V Receiver

If you frequently use an A/V receiver with the TV and your other A/V equipment, use the following special programming instructions. When programmed in this way, the TV remote will control the volume and mute functions of the A/V receiver no matter what the position of the slide switch.

1. Program the AUDIO position for your A/V receiver as described above. Make note of the correct code for your A/V receiver.
2. Move the slide switch to the TV position.
3. Press and hold the POWER key.
4. While still holding the POWER key, enter the three-digit code for your A/V receiver.

To Reset the Remote to Control TV Volume and Mute

Move the slide switch to TV. Program the remote with three-digit code 935 using the procedure at the top of the page.

IMPORTANT

The remote control may return to its initial setting when the batteries are changed. You may need to reprogram it.

A/V Receivers

A/V Receiver Brand	Code
MITSUBISHI	010, 011, 012, 013, 014
AIWA	225, 226, 241
BOSE	351
B & K	352
DENON	234, 235, 236, 245, 246, 359, 361
FISHER	204
GARRARD	213
HARMAN KARDON	215, 223, 242, 362
JENSEN	223, 229
JVC	232, 233
KENWOOD	200, 208
KLH	363
KOSS	357
MAGNAVOX	227, 228
MARANTZ	224, 350, 360
MCINTOSH	216
NAKAMICHI	206, 217
ONKYO	209, 214, 240, 247
OPTIMUS	203, 227, 231, 230
PANASONIC	219, 218, 221
PARASOUND	356
PHILIPS	223, 248
PIONEER	205, 207
POLK AUDIO	353
QUASAR	219, 218, 221
RCA	203, 205, 227, 231, 230
ROTEL	366
SANSUI	203, 211, 239
SHARP	234, 237
SHERWOOD	354, 355
SONY	222, 249, 364, 365
TEAC	212, 213, 211, 210
TECHNICS	221, 218, 219
VICTOR	232, 233
YAMAHA	201, 202, 243, 244

Cable Boxes

Cable Brand	Code
ABC	124
ARCHER	125
CABLEVIEW	105,
CITIZEN	122, 105
COLOR VOICE	128, 129, 130, 106, 107
COMTRONICS	128, 129, 130, 106, 107
CURTIS	112, 113
DIAMOND	124, 125
EAGLE	129
GCBRAND	105
GE	112, 113
GEMINI	122
GENERAL INSTRUMENT/ JERROLD/MOTOROLA	119, 123, 124, 125, 126, 127, 120, 121, 122
HAMLIN	112
HITACHI	103, 124
MACOM	103, 104, 105, 108
MAGNAVOX	128, 129, 130, 106, 107, 133, 138
MOTOROLA	123, 146
MEMOREX	130
MOVIE TIME	105,
PANASONIC	114
PARAGON	117
PHILIPS	128, 129, 130, 106, 107, 131, 133, 138
PIONEER	101, 106, 116
PULSAR	105
RCA	115
REGAL	112
REMBRANDT	105, 138
SAMSUNG	105
SONY	147, 177
ZENITH/DRAKE SATELLITE	100

Appendix B: Remote Control Programming, continued

Cable Boxes, continued

SCIENTIFIC ATLANTA	112, 113, 194
SIGNATURE	119,124,125,126,127,120,121,122
SLMARK	105,101
SPRUCER	105
STARCOM	119,124,125,126,127,120,121,122
STARGATE	105
TELEVIEW	101,105
TOCOM	135,136
TOSHIBA	104
UNIKA	125
UNITED CABLE	119,124,125,126,127,120,121,122
UNIVERSAL	122
VIDEOWAY	106
VIEWSTAR	129,130
ZENITH	117,100

DVD Players

DVD Brand	Code
DAEWOO	063, 021, 044, 078
DBX	030, 031
DIMENSIA	065
EMERSON	063, 046, 038, 039, 023, 045, 062, 040
FISHER	025, 028, 029, 027
FUNAI	047, 046, 040
GE	053, 065, 044, 079
GO VIDEO	057, 069, 070, 071
GOLDSTAR	026
HITACHI	043, 065, 020, 047
INSTANT REPLAY	044, 043
JVC	030, 031, 076, 077
KENWOOD	030, 026, 031
LXI	047, 026, 020, 027, 028, 025, 029
MAGNAVOX	051, 043, 044
MARANTZ	030, 031
MARTA	026
MEMOREX	044, 029
MGA	060, 067, 068, 061, 062
MINOLTA	020, 065
MULTITECH	067, 047
NEC	030, 031
OLYMPIC	044, 043
OPTIMUS	048, 041, 055, 026
ORION	046, 040
PANASONIC	043, 044, 041, 042
PENNEY	044, 020, 065, 025, 030, 031
PENTAX	020, 031, 065
PHILCO	051, 044, 047, 043, 046, 040, 063
PHILIPS	051, 043, 044
PIONEER	043
PROSCAN	065, 020, 043, 044, 051, 066, 021, 022, 053
QUASAR	041, 042, 043, 044
RADIO SHACK	053, 044, 025, 056, 029, 060, 047
RCA	020, 021, 022, 043, 044, 049, 051, 053, 065, 066
REALISTIC	044, 025, 056, 029, 060, 047
SAMSUNG	057, 022, 053
SANSUI	046, 040
SANYO	025, 029
SCOTT	021, 022, 029, 060, 067, 068, 046, 040
SEARS	025, 026, 027, 028, 020
SHARP	055, 056
SIGNATURE 2000	047, 055
SONY	048, 049, 050, 073, 074, 075
SV2000	047
SYLVANIA	051, 043, 044, 047
SYMPHONIC	047
TASHIRO	026
TATUNG	030, 031
TEAC	030, 047, 031
TECHNICS	041, 042, 043, 044
TEKNIKA	044, 047
TOSHIBA	021, 066
TOTEVISION	026
VECTOR RESEARCH	031
WARDS	055, 056, 029, 064, 026
YAMAHA	025, 030, 031
ZENITH	064, 026

Satellite Receivers/SAT/DTV

Brand	Code
MITSUBISHI	006 (same as 173)
ECHOSTAR/DISH NETWORK	175, 182, 183, 188
EXPRESS VU	175
G.E.	176
HITACHI	173, 181, 184
HNS (Hughes)	173
JVC (ECHOSTAR)	175
MAGNAVOX	171, 172
PANASONIC	174
PHILIPS	171, 172
PROSCAN	176, 179, 180, 185
RCA	176, 179, 180, 185
SAMSUNG - TERRESTRIAL	192
SONY	177
STAR CHOICE	173
TOSHIBA	170, 189, 190, 191
UNIDEN	171, 172
WEBTV	187
ZENITH/LG	193

VCRs

VCR Brand	Code
MITSUBISHI	001, 060, 067, 068, 061, 062, 002
AKAI	049, 034, 035, 036
AUDIO DYNAMIC	031
BELL & HOWELL	025,
BROKSONIC	040, 046
CANON	043, 045
CITIZEN	026
CRAIG	025, 049, 026
CURTIS MATHES	065, 044, 047
DAEWOO	063, 021, 044, 078
DBX	030, 031
DIMENSIA	065
EMERSON	063, 046, 038, 039, 023, 045, 062, 040
FISHER	025, 028, 029, 027
FUNAI	047, 046, 040
GE	053, 065, 044, 079
GO VIDEO	057, 069, 070, 071
GOLDSTAR	026
HITACHI	043, 065, 020, 047
INSTANT REPLAY	044, 043
JVC	030, 031, 076, 077
KENWOOD	030, 026, 031
LXI	047, 026, 020, 027, 028, 025, 029
MAGNAVOX	051, 043, 044
MARANTZ	030, 031
MARTA	026
MEMOREX	044, 029
MGA	060, 067, 068, 061, 062
MINOLTA	020, 065
MULTITECH	067, 047
NEC	030, 031
OLYMPIC	044, 043
OPTIMUS	048, 041, 055, 026
ORION	046, 040
PANASONIC	043, 044, 041, 042
PENNEY	044, 020, 065, 025, 030, 031
PENTAX	020, 031, 065
PHILCO	051, 044, 047, 043, 046, 040, 063
PHILIPS	051, 043, 044
PIONEER	043
PROSCAN	065, 020, 043, 044, 051, 066, 021, 022, 053
QUASAR	041, 042, 043, 044
RADIO SHACK	053, 044, 025, 056, 029, 060, 047
RCA	020, 021, 022, 043, 044, 049, 051, 053, 065, 066
REALISTIC	044, 025, 056, 029, 060, 047
SAMSUNG	057, 022, 053
SANSUI	046, 040
SANYO	025, 029
SCOTT	021, 022, 029, 060, 067, 068, 046, 040
SEARS	025, 026, 027, 028, 020
SHARP	055, 056
SIGNATURE 2000	047, 055
SONY	048, 049, 050, 073, 074, 075
SV2000	047
SYLVANIA	051, 043, 044, 047
SYMPHONIC	047
TASHIRO	026
TATUNG	030, 031
TEAC	030, 047, 031
TECHNICS	041, 042, 043, 044
TEKNIKA	044, 047
TOSHIBA	021, 066
TOTEVISION	026
VECTOR RESEARCH	031
WARDS	055, 056, 029, 064, 026
YAMAHA	025, 030, 031
ZENITH	064, 026

Appendix B: Remote Control Programming, continued

After entering the correct code for each position of the slide switch on the remote control, use the slide switch to select the product you wish to control when an operational button is pressed. Only one of the devices listed below operates in each slide-switch position.

Slide-Switch Position	Affected Device
TV	TV; A/V receiver volume and mute with special programming
Cable/DBS/DTV	Cable Box Satellite Receiver DTV Receiver
VCR	VCR
DVD	DVD Player LD Player
Audio	A/V Receiver Mitsubishi CD Player*

*If you have a Mitsubishi A/V receiver, you may be able to use the AUDIO position in conjunction with some Mitsubishi CD players. The AUDIO position must be programmed to 010.

When your remote control has been programmed to operate another manufacturer's product, the functions performed in each slide-switch position can vary. The most common functions are shown in the following table.

IMPORTANT

Some manufacturers may change their products, or they may use more than one remote control system. If this is the case, the TV remote control may not be able to operate your VCR, DVD player, cable box, satellite receiver, or A/V receiver.

<p>VCR</p> <ul style="list-style-type: none"> • POWER • CHANNEL up/down • PLAY • REC • PAUSE • STOP • FF/FWD • REW/REV • DEVICE MENU (Mitsubishi VCRs)
<p>Cable Boxes and Satellite Receivers</p> <ul style="list-style-type: none"> • POWER • CHANNEL up/down • 0-9 number buttons (on some models) • ENTER (on some models) • CANCEL (on some models) • ADJUST up/down/ left/right (on some models) • GUIDE (on some models) • DEVICE MENU (Mitsubishi satellite receivers)
<p>A/V Receivers</p> <ul style="list-style-type: none"> • POWER • VOLUME • MUTE
<p>Mitsubishi A/V Receivers</p> <ul style="list-style-type: none"> • Direct Input Selection buttons: numbers, SQV and QV (on some models)
<p>Mitsubishi CD Players (not all functions for all models)</p> <ul style="list-style-type: none"> • PLAY • FF/FWD • REW/REV • PAUSE • STOP
<p>DVD and Laser Disc Players (not all functions for all models)</p> <ul style="list-style-type: none"> • POWER • DEVICE MENU • 0-9 number buttons (on some models) • PLAY • STOP • ARROW up/down/left/right (on some models) • FF/FWD • REW/REV • PAUSE • CANCEL (on some models) • ENTER • CHANNEL (on some models)

Appendix C: Specifications

Picture Technology		
Projection System	3 LCD, 0.7" x 3, 1280 x 720 pixels	
Lamp	110 watt high-pressure mercury discharge	
Reception		
Channel Frequency Reception	Over-the-Air: VHF 2–13, UHF 14–69 Analog Cable: 1–125 Digital Cable: 1–135	
Channel Type*	Over the Air	Analog NTSC, Digital ATSC with sub-channels (all 18 video formats)
	Cable	Analog NTSC (non-scrambled) Digital QAM 64 and 256 with sub-channels (non-scrambled)

* Note for Digital Channels: The channel numbers displayed on screen are determined by the broadcaster or cable company and can vary from the standard frequency number. If there is no channel-number information provided by the broadcaster or cable company, the TV creates a channel number. The created channel number uses the frequency number as the main channel number and the program number as the sub-channel number.

Inputs			
Description	Qty.	Signal Type	Input Specifications
Antenna/Cable input	1	RF	F connector, 75-ohm
HDMI (digital video/audio)	2	HDMI EIA-861B standard for digital audio and video	HDMI standard connector Video: 480i, 480p, 720p, 1080i Audio: PCM stereo Not intended for use with personal computers.
Video/S-Video (one front, two rear)	3	NTSC 480i only	Video: RCA Pin Plug, 1.0 V p-p, 75 ohm S-Video: Four-Pin DIN Plug Y: 1.0 Vp-p 75-ohm C: 0.286 Vp-p (burst signal), 75-ohm
Component Video (YPrPb)	2	EIA-770.1 & EIA 770.2 480i, 480p, EIA 770.3 720p and 1080i (video standards)	RCA Pin Plug (EIA-770.3 Standard Levels and Timing) Y: 1.0 Vp-p (includes synch), 75-ohm Pr: 700 mV p-p, 75-ohm Pb: 700 mV p-p, 75-ohm
Audio Inputs	7 pairs	Analog left and right audio	RCA Pin Plug 500 mV (full scale), 43-k ohm

Appendix C: Specifications, continued

Outputs		
Video	1	RCA Pin Plug 1.0 Vp-p, 75-ohm Signal Type: NTSC 480i only
Audio (Signal)	2 pairs	RCA Pin Plug, 500 mV rms \pm 200 mV (full scale) for analog sources 1.5 Vrms \pm 0.5 Vrms (full scale) for digital sources.
Audio (Speakers)	2	10 watt, 5.5" x 2.2"
Digital Audio Output	1	RCA Pin Plug, Signal Type, Dolby Digital, PCM

Physical Characteristics and Power Consumption					
Models	Dimensions (inches)			Weight (lbs.)	Power Consumption
	Height	Width	Depth		
WD-52526	34"	49.6	17.8	114	225 watts
WD-62526	40.5	58.3	19.9	133	225 watts

The HDMI input is compliant with EIA-861B standards for standard, extended, and high-definition video; digital audio, and HDCP copy protection. The HDMI input is not intended for use with personal computers or devices outputting video signals with computer resolutions.

Appendix D: General Cleaning

IMPORTANT

DO NOT use any kind of abrasive cleaner on the surface of the TV screen.

Cleaning

Normally, light dusting with a dry, non-scratching duster will keep your TV clean. If cleaning beyond this is needed, please use the following guidelines:

First, turn off the TV and unplug the power cord from the power outlet.

Top and Sides of the TV

- Gently wipe down your TV with a soft, non-abrasive cloth such as cotton flannel or a clean cloth diaper, lightly moistened with water. Dry with a second dry, soft, non-abrasive cloth.
- For oily dirt, add a few drops of mild liquid detergent, such as dishwashing detergent, to the water used to moisten the cloth. Rinse with a second cloth moistened only with water. Dry with a third dry, soft, non-abrasive cloth.

Screen

- Follow the instructions for the top and sides, wiping gently in an up and down motion, following the grooves in the screen.
- Clean the entire screen evenly, not just sections of the screen.
- Do not allow liquid to drip down the grooves of the screen, as some liquid may enter the TV between the screen and the screen frame.
- You may purchase Mitsubishi Screen Cleaner, part number CLEANER-VSS, by calling (800) 553-7278.

General Cleaning Warnings

- DO NOT allow liquid to enter the TV through the ventilation slots or any crevice.
- DO NOT use any strong or abrasive cleaners, as these can scratch the surfaces.
- DO NOT use any cleaners containing ammonia, bleach, alcohol, benzene, or thinners, as these can dull the surfaces.
- DO NOT spray liquids or cleaners directly on the TV's surfaces.
- DO NOT scrub or rub the TV harshly. Wipe it gently.

Appendix E: Filter Cleaning

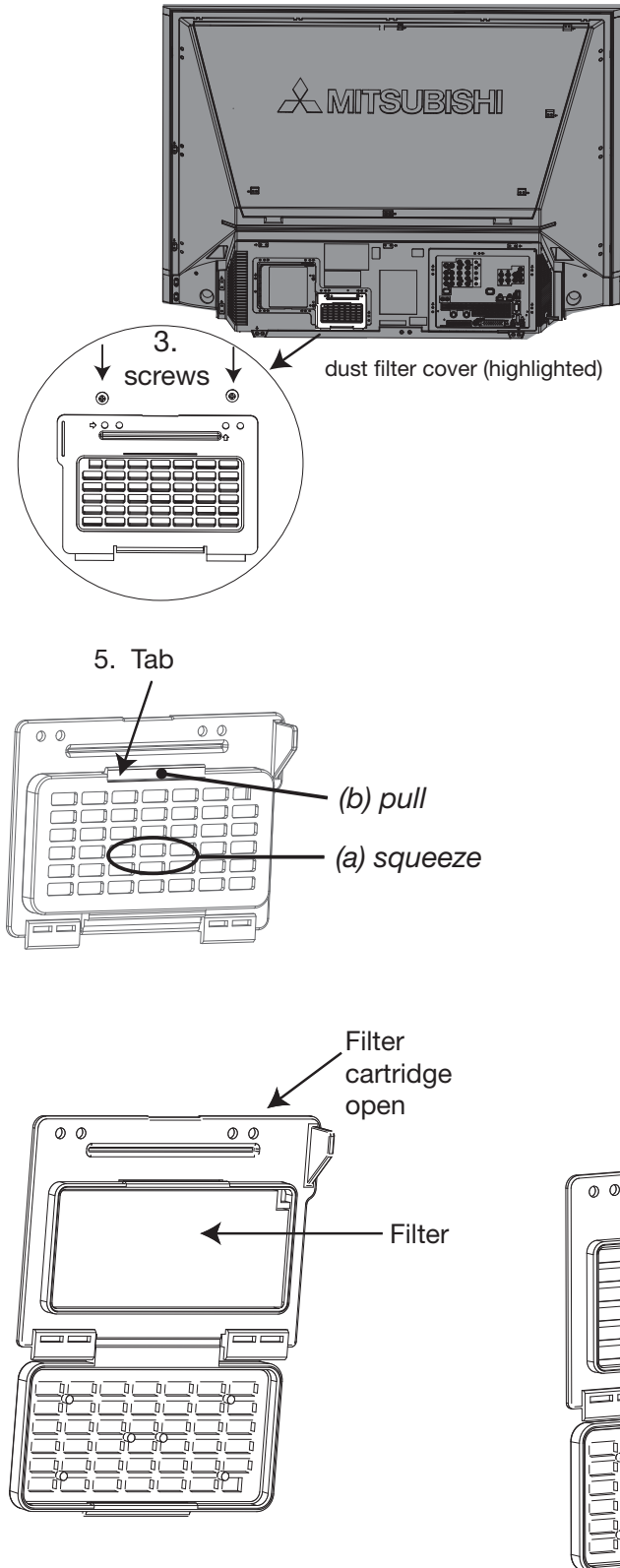

Cleaning the Dust Filter

Clean the filter annually and whenever you replace the lamp cartridge.

Tool needed: Phillips screwdriver

1. Turn the television off and unplug the AC cord.
2. Carefully access the back of the television. If the TV must be moved, use two people.
3. Using a Phillips screwdriver, remove the two screws that hold the dust filter cover in place.
4. Carefully remove the dust filter cover from the TV and set the screws aside in a safe place for reuse.
5. **To open the dust filter cover, please follow carefully:** while squeezing the grating between the thumb and fingers of one hand, pull the tab with the index finger of your other hand. See (a) and (b) in the illustration to the left.
6. Clean the filter material by dusting with a lint-free cloth.
7. If the filter is soiled, carefully pull it out of the cover and rinse it with water. Do not use detergents or soap on the filter.
8. Completely air dry the filter before placing it back into the dust filter cover. Make sure to place the filter with the notched edge at the upper right corner.
9. Replace the filter in the TV and secure with the screws.

IMPORTANT: Never operate this TV without a clean filter in place.

Appendix F: Lamp Cartridge Replacement

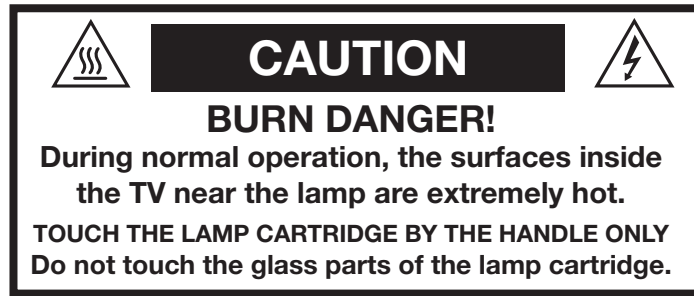

CAUTION: If the television is on, press **POWER** to turn it off and unplug the AC power cord. Allow the television to cool for at least one hour before attempting to replace the lamp cartridge.

LAMP LIFE

The light source for this television is a lamp, which is part of a lamp cartridge assembly. The actual life of the lamp in this television can vary, based on the lamp itself, the air temperature around the TV while it is operating, and your viewing patterns. Warmer air or poor ventilation shortens the lamp life, as does turning the television on and off frequently.

When the end of the lamp's average life is approaching, the TV displays a warning message for one minute when you power on the TV. The message will reappear the next five times you turn on the TV. If you wish, you may continue to use the current lamp until it stops working. **After you change the lamp cartridge, you must reset the lamp reminder through the TV Setup menu.** Otherwise, the warning message will appear again earlier than necessary. Mitsubishi warrants the lamp for one (1) year from date of the original purchase at retail. It is likely, however, that the lamp will last significantly longer than this.

TO ORDER A NEW LAMP

To Receive a Replacement Lamp Under Warranty	To Purchase a Replacement Lamp After Warranty
Call (800) 332-2119. Please have model number, serial number, and TV purchase date available.	Call (800) 553-7278. Order lamp part number 915P028010.

WARNING

- Do not remove the lamp cartridge immediately after turning off the television. You may get burned because of the lamp's high temperature. Allow the television to cool for one hour before attempting to replace the lamp cartridge.
- Do not remove the lamp cartridge except when replacing it. Careless treatment can result in injury or fire.
- Do not touch the lamp glass element. It may be very hot and break, causing injuries or burns.
- Be sure not to insert any metal or flammable object into the lamp cartridge opening, as it may cause fire or electrical shock. If a foreign object is inserted into the opening, unplug the AC cord of the TV and contact your dealer for service.
- Install the lamp cartridge securely. Failure to do so may cause a fire.
- Do not touch the lamp glass elements. Oils from your fingers may cause premature lamp failure.

 = MERCURY

THE LAMP INSIDE THIS PRODUCT CONTAINS MERCURY AND MUST BE RECYCLED OR DISPOSED OF ACCORDING TO LOCAL, STATE OR FEDERAL LAWS. For disposal or recycling information, please contact your local authorities or the Electronic Industries Alliance: www.eiae.org

IMPORTANT

Reset the lamp hours through the TV setup menu each time you replace the lamp cartridge. Otherwise, the lamp warning message will reappear sooner than necessary.

Appendix F: Lamp Cartridge Replacement, continued

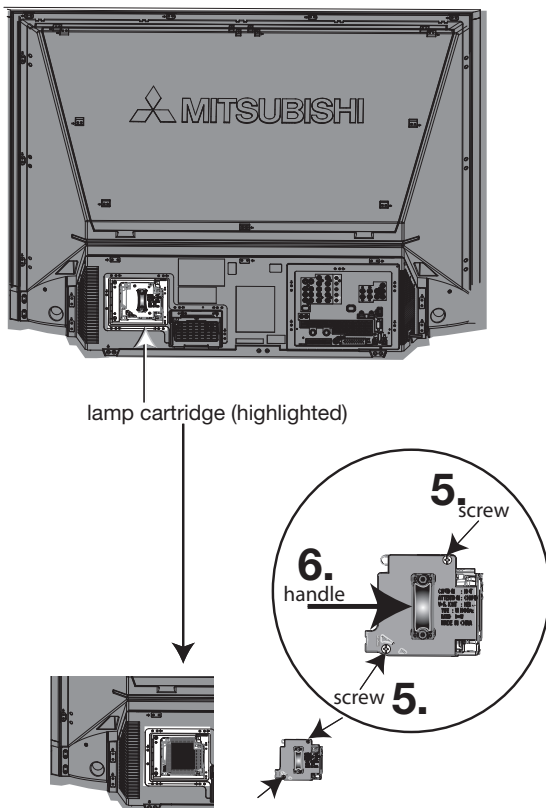
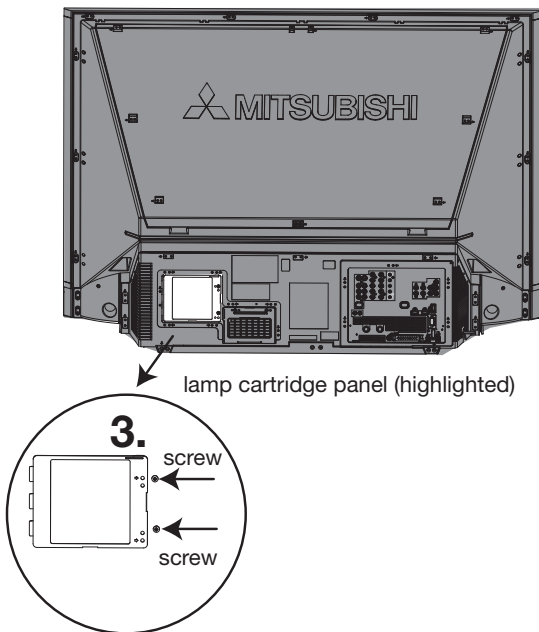

Replacing the Lamp Cartridge

Tool needed: Phillips screwdriver

1. Turn the television off and unplug the AC cord. The TV should be off for at least one hour to allow the current lamp to cool.
2. Carefully access the back of the television. If the TV must be moved, use two people.
3. Using a phillips screwdriver, remove the two screws on the right side that hold the recessed plastic cover in place.
4. Remove the plastic cover and set aside with the screws.
5. After removing the cover, you will be able to see the lamp cartridge. With the screwdriver, completely loosen the two screws of the cartridge (one on the bottom left corner and one on the top right corner).
The two screws cannot be completely removed.
6. Gently grasp the plastic handle and pull straight out (towards you).
7. Insert the new lamp cartridge securely. Do not touch the glass surface of the cartridge.
8. With the screwdriver, tighten the screws on the lamp cartridge.
9. Replace the plastic cover and screws.
10. Reset the lamp reminder message. Press TV MENU, select the Setup menu, and then select the Lamp Reminder option to reset the hours to zero.

To order a new lamp under warranty, call (800) 332-2119. Please have model number, serial number and TV purchase date available. To purchase a new lamp after warranty, call (800) 553-7278 and order lamp part number 915P028010.

Appendix G: Troubleshooting

General TV Operation		
Symptom		Remarks
1.	The TV remote control does not work.	<ul style="list-style-type: none"> • Check that the batteries are installed correctly. • Check that the selected switch is set to "TV." • Be no more than 20 feet from the TV when using the remote control. • Program the remote control to operate the TV (Appendix B).
2.	The TV takes several seconds to respond.	<ul style="list-style-type: none"> • It is normal for digital channels to take longer to tune in. • Press ENTER after a channel number to avoid delays. • Enter all of the digits and any necessary separator for that channel number.
3.	You cannot access a channel.	<ul style="list-style-type: none"> • Use number keys instead of CHANNEL up/down. • Be sure the channel you want to view is in memory. See page 42. • Check that the TV is turned to the correct device or antenna for that channel by pressing the DEVICE button. • Make sure the V-Chip lock is off. • If you cannot tune to a virtual digital channel even though the TV has already memorized digital channels, tune to the actual channel number used by the broadcaster. The virtual channel will then be automatically added to memory.
4.	On-screen displays appear each time you change a function.	This is part of normal TV operation.
5.	You cannot program the TV to turn on automatically (timer function)	<ul style="list-style-type: none"> • The TV may be locked. • The clock may not be set.
6.	You have forgotten your V-Chip pass code.	See Appendix A, Bypassing the V-Chip Lock.
7.	V-Chip is not working.	<ul style="list-style-type: none"> • Make sure that V-Chip is On. • If V-Chip Hours are currently set to disable the V-Chip lock, the V-Chip will not block programming. • V-Chip blocking cannot block programs received on the COMPONENT or HDMI inputs. Use the parental lock system of the source device instead. • Not all programs have V-Chip ratings.
8.	The TV will not turn on after being plugged in.	If green light on front panel is blinking, wait for at least one minute for the light to turn off, then press Power again.
9.	TV functions do not respond to the remote control or to front panel control and TV will not power off.	Use the System Reset button.
10.	TV turned itself off and the light on the front panel started to blink.	<ul style="list-style-type: none"> • Momentary power fluctuation caused the TV to turn off to prevent damage. Wait for the green light to stop flashing and turn On again. • If the TV does not stay turned On, use the System Reset button. If this happens frequently, obtain an AC line power conditioner/surge protector. • An unusual digital signal may have been received, triggering a protection circuit. Wait for the light to stop flashing and turn TV on.
11.	Name options not available for some channels.	Only memorized analog channels can be named.
12.	When a device is selected from the Device Selection menu, the screen is blue (no signal source).	<ul style="list-style-type: none"> • Make sure the selected device is turned on. • Begin play of the VCR.
13.	Devices are grayed out in the PIP Selection menu.	The devices are unavailable for PIP.
14.	When ChannelView™ list is displayed, information appears incomplete	Available information for digital channels is sent from the broadcaster or cable provider. No other data is available.
15.	The message "Lamp will soon exceed..." keeps displaying after the lamp has been replaced.	Reset the lamp reminder in the Setup menu.

Appendix G: Troubleshooting, continued

Picture		
	Symptom	Remarks
1.	PIP does not display a picture.	<ul style="list-style-type: none"> Make sure the V-Chip lock is off. Not all inputs can be displayed as a PIP.
2.	There is a large black or gray rectangle on the screen.	The TV's analog closed captioning has been set to "text" mode in the Captions menu. Turn off this mode because there is no text information being broadcast.
3.	You cannot see a picture when playing a VHS tape.	<ul style="list-style-type: none"> Display the Device Selection menu and select the correct VCR. Check your VCR's owner's guide for further troubleshooting.
4.	When viewing a stopped VCR, white lines are rolling on the screen.	<ul style="list-style-type: none"> Turn off video mute for the VCR. Begin playing the tape. Change the VCR input to the antenna input.
5.	Screen is black when trying to view digital channels.	The PerfectColor™ color balance has been incorrectly set. Press VIDEO repeatedly until you see the PerfectColor option and press ENTER.

Sound		
	Symptom	Remarks
1.	There is no sound even when the volume is turned up.	<ul style="list-style-type: none"> Check to see if the MUTE button is on. The TV's "Listen to:" setting may be set to SAP. Check that the "TV Speakers" setting is On in the Audio/Video menu.
2.	The sound does not match the screen picture.	<ul style="list-style-type: none"> The TV's "Listen to:" setting may be set to SAP. If using stereo or A/V receiver speakers, check their input selection. If using stereo or A/V receiver, check that AUDIO OUTPUT on TV's back panel is connected to the A/V receiver.

LED Indicators		
	Symptom	Remarks
1.	Lamp indicator light is a steady red.	Turn the TV off for at least 2 minutes. Turn back on. If light is still red, the lamp has failed. Replace it. See Appendix F for lamp replacement information.
2.	Lamp indicator light is a steady yellow.	Lamp may fail soon. Purchase a new lamp. See Appendix F for lamp replacement information.
3.	Lamp indicator light is a flashing yellow.	Lamp cover door is open or lamp cartridge is not secure. See Appendix F for lamp replacement information.
4.	Status indicator light is a steady yellow.	Operating temperature or room temperature has exceeded proper levels. Clean the TV's dust filter or cool the room. See Appendix E for filter cleaning information.
5.	Status indicator light is a steady/flashing red.	Unplug the TV from the AC outlet and wait at least one minute. Plug in the TV. If the light is still red, service is required. Contact your dealer or a Mitsubishi Authorized Service Center to arrange for a service evaluation. Listings of Mitsubishi Authorized Service locations can be obtained from our web site, www.mitsubishi-tv.com or by calling 1-800-332-2119.

Appendix G: Troubleshooting, continued

System Reset Button

If the TV does not respond to either the remote control or the front panel controls or will not power off, press the SYSTEM RESET button on the front panel with a pointed item such as the point of a ball point pen or end tip of a paperclip.

The TV will turn off and the green LED will flash quickly for about one minute. When the green LED stops flashing, you may turn on the TV again. The changes you made while the TV was most recently on, before you used the SYSTEM RESET button, may be lost; the changes you made previously, however, are not lost. Only those changes since the last power on may be lost when the system reset button is pressed. All other settings are retained.

TV Reset Menu

Select any device from the Device Selection menu.

Press TV MENU followed by 1,2,3 to open the RESET SERVICE MENU.

Read on-screen warnings before proceeding, as some user data or settings may be erased.

Select Reset System Defaults (CAUTION: All settings except your V-Chip pass code will be reset to the original factory defaults).

Demo Mode

This TV has a demo mode for use in retail stores. To turn off demo mode:

1. Press TV MENU.
2. When the menu appears, press the following buttons in sequence:

0, QV, 0

Service

If you are unable to correct a problem with your TV, consult your Mitsubishi dealer or a Mitsubishi Authorized Warranty Service Center.

- DO NOT adjust any controls other than those described in this Owner's Guide.
- DO NOT remove the protective back cover of your TV.

Menus not described and shown in this Owner's Guide are designed for factory use and for authorized service personnel. Damage caused to the TV by unauthorized changes or changes to these menus made by unauthorized persons are not covered under warranty.

Support

- To order replacement or additional remote controls, lamp cartridges, or Owner's Guides, call 800-553-7278.
- For questions, call Consumer Relations at 800-332-2119.
- E-mail: MDEAservice@mdea.com
- Website: www.mitsubishi-tv.com

Trademark and License Information

LICENSOR'S SUPPLIERS DO NOT MAKE OR PASS ON TO END USER OR ANY OTHER THIRD PARTY, ANY EXPRESS, IMPLIED OR STATUTORY WARRANTY OR REPRESENTATION ON BEHALF OF SUCH SUPPLIERS, INCLUDING, BUT NOT LIMITED TO THE IMPLIED WARRANTIES OF NON-INFRINGEMENT, TITLE, MERCHANTABILITY OR FITNESS FOR A PARTICULAR PURPOSE.

Manufactured under license from Dolby Laboratories. Dolby® and the double-D symbol are registered trademarks of Dolby Laboratories.

HDMI™ the HDMI logo and High-Definition Multimedia Interface are trademarks or registered trademarks of HDMI Licensing LLC.

This product incorporates copyright protection technology that is protected by U.S. patents and other intellectual property rights. Use of this copyright protection technology must be authorized by Macrovision, and is intended for home and other limited pay-per-view uses only unless otherwise authorized by Macrovision. Reverse engineering or disassembly prohibited.

This product includes technology owned by Microsoft Corporation and cannot be used or distributed without a license from Microsoft Licensing, Inc.

MultiMediaCard™ is trademark of Infineon Technologies and licensed to the MultiMediaCard Association.

 The PanelLink Cinema Partners logo and the "PanelLink Cinema," "PLC" and "PLC Content Ready" word marks are trademarks of Silicon Image, Inc. and are used under a license from Silicon Image, Inc or PanelLink Cinema, LLC.

ViewPoint®, QuickView™, SuperQuickView™, Diamond Shield™, PerfectColor™, SharpEdge™, and ChannelView™, are trademarks of Mitsubishi Digital Electronics America, Inc.

MITSUBISHI TV SOFTWARE

END-USER LICENSE AGREEMENT FOR EMBEDDED SOFTWARE

IMPORTANT – READ CAREFULLY: This License Agreement is a legal agreement between you (either an individual or an entity) and Mitsubishi Digital Electronics America, Inc. (MDEA) for all software pre installed and/or provided along with this television (“Software”). By utilizing this television and Software, you agree to be bound by the terms of this License Agreement.

The Software is protected by United States copyright laws and international treaty provisions, as well as other intellectual property laws and treaties. The Software is licensed, not sold.

1. **LICENSE GRANT.** MDEA grants you a non-exclusive, non-transferable, limited right and license to use one copy of the Software only with the Mitsubishi television model that included this owner’s guide and owned by you.

2. **RIGHTS AND LIMITATIONS.**

Software Not for Resale. You may not resell or otherwise transfer for value the Software, except in conjunction with a sale of the TV that Software has been pre installed.

Prohibition on Reverse Engineering, Decompilation and Disassembly. The Software contains trade secrets or other proprietary material in its human perceivable form and to protect them, you may not reverse engineer, decompile, or disassemble, or otherwise reduce the Software to any human perceivable form, except to the extent that the foregoing restriction is expressly prohibited by applicable law.

Separation of Components. The Software is licensed as a single product. Its component parts may not be separated for use on more than one TV.

No Rental. You may not rent, lease, lend, or sublicense the Software.

Trademarks. This License Agreement does not grant you any rights to any trademarks of MDEA.

3. **VIOLATIONS.** You understand that any use, copying or transfer of the Software, except as permitted pursuant to this License, may subject you to serious criminal and civil penalties including damages and an award to MDEA of attorneys’ fees in connection with any violation of this License. You further understand that you may be held legally responsible for any copyright infringement or other violation of intellectual property rights that is caused, encouraged, or induced by your failure to abide by the terms of the License. This license is effective until terminated, and will terminate immediately without notice from MDEA or judicial resolution if you fail to comply with any provision of this License.

4. **COPYRIGHT.** All title and intellectual property rights in and to the Software (including but not limited to any images, photographs, animations, video, audio, music, text, and “applets” incorporated into the Software), and any accompanying printed materials are owned by or licensed to MDEA. All title and intellectual property rights in and to the content which may be accessed through use of the Software is the property of the respective content owner and may be protected by applicable copyright or other intellectual property laws and treaties. This License Agreement grants you no rights to use such content, except that you own the media on which the Software is recorded, but MDEA and its licensors retain ownership of the Software itself. All rights not expressly granted are reserved by MDEA.

5. **EXPORT RESTRICTIONS.** MDEA is licensing the Software for use within the United States. You agree that you will not export or re-export the Software. You specifically agree not to export or re-export the Software: (i) to any country to which the U.S. has embargoed or restricted the export of goods or services, which currently include, but are not necessarily limited to Cuba, Iran, Iraq, Libya, North Korea, Sudan, and Syria, or to any national of any such country, wherever located, who intends to transmit or transport the Software back to such country; (ii) to any person or entity who you know or have reason to know will utilize the Software in the design, development, or production of nuclear, chemical, or biological weapons; or (iii) to any person or entity who has been prohibited from participating in U.S. export transactions by any federal agency of the U.S. government. You warrant and represent that neither the BXA nor any other U.S. federal agency has suspended, revoked, or denied your export privileges.

6. **DISCLAIMER OF WARRANTY. EXCEPT AS OTHERWISE PROVIDED IN THIS LICENSE OR IN THE LIMITED WARRANTY APPLICABLE TO THE TV, MDEA MAKES NO OTHER WARRANTIES OF ANY KIND WHATSOEVER REGARDING THE SOFTWARE AND HEREBY EXPRESSLY DISCLAIMS ALL WARRANTIES OF ANY KIND WHATSOEVER, EXPRESS OR IMPLIED, WITH RESPECT TO THE SOFTWARE. ALL IMPLIED WARRANTIES, INCLUDING, WITHOUT LIMITATION, THE IMPLIED WARRANTIES OF MERCHANTABILITY AND FITNESS FOR A PARTICULAR PURPOSE ARE HEREBY EXPRESSLY DISCLAIMED BY MDEA. IN NO EVENT SHALL MDEA BE LIABLE TO YOU OR ANY THIRD PARTIES, IN CONTRACT, IN TORT OR OTHERWISE, FOR ANY DIRECT, INDIRECT, SPECIAL, INCIDENTAL OR CONSEQUENTIAL DAMAGES OF ANY KIND OR NATURE. BECAUSE SOME JURISDICTIONS DO NOT ALLOW THE EXCLUSION OR LIMITATION OF IMPLIED WARRANTIES, THE ABOVE LIMITATION MAY NOT APPLY TO YOU.**

7. **LIMITATION OF LIABILITY. MDEA SHALL NOT, UNDER ANY CIRCUMSTANCES BE LIABLE TO YOU OR ANY THIRD PARTIES FOR ANY DAMAGES OF ANY NATURE, WHETHER INDIRECT, SPECIAL, INCIDENTAL, CONSEQUENTIAL OR OTHERWISE, INCLUDING, BUT NOT LIMITED TO, ANY CLAIMS FOR LOST PROFITS, LOSS OF GOOD WILL OR EXPENDITURES MADE OR COMMITTED FOR IN RELIANCE ON THE CONTINUATION OF THIS LICENSE. YOU AGREE THAT NEITHER MDEA’S BREACH OF THIS LICENSE NOR ITS FAILURE TO REPAIR A DEFECT, ERROR OR BUG SHALL CONSTITUTE A FAILURE OF THE ESSENTIAL PURPOSE OF THIS LICENSE. BECAUSE SOME JURISDICTIONS DO NOT ALLOW THE EXCLUSION OR LIMITATION OF LIABILITY FOR CONSEQUENTIAL OR INCIDENTAL DAMAGES, THE ABOVE LIMITATIONS MAY NOT APPLY TO YOU. MDEA’s liability to you for direct damages for any cause whatsoever and regardless of the form of the action, will be limited to the money paid by you for the TV (based on fair market value of the TV) that caused the damages.**

8. **GENERAL.** This License Agreement will be governed by the laws of the State of California.

Mitsubishi LCD Rear Projection Television Limited Warranty

MITSUBISHI DIGITAL ELECTRONICS AMERICA, INC. (“MDEA”) warrants as follows to the original purchaser of this television from an authorized MITSUBISHI Audio/Video Dealer, should it prove defective by reason of against defects arising from improper workmanship and/or material:

a. Parts. The lenticular (i.e. front picture) screen is warranted against defects in materials and workmanship for a period of thirty (30) days from the date of the original purchase at retail. The lamp and all other parts (except any software incorporated into this television) are warranted for a period of one (1) year from the date of the original purchase at retail. We will repair or replace, at our option, any defective part without charge for the part. Parts used for replacement may be replaced with those of like kind and quality and may be new or remanufactured. Parts used for replacement are warranted for the remainder of the original warranty period.

b. Embedded Software. MDEA warrants that all software incorporated into this television set (the “Embedded Software”) will perform in accordance with the functional description of Embedded Software in all material respects, but MDEA does not warrant that the Embedded Software is error-free. MDEA also does not warrant that the Embedded Software will be compatible under IEEE 1394 AV/C and HAVi software standards with products produced by any other manufacturer. The limited warranty contained in this section shall continue for a period of one (1) year from the date of the original purchase at retail. If, after prompt notice within the warranty period, MDEA determines that the Embedded Software has failed to perform in accordance with such functional description in all material respects and if such failure is not due to accident, misuse, modification or misapplication of the Embedded Software, then MDEA shall modify or replace the nonconforming Embedded Software at no charge to you, which at MDEA’s sole discretion may be fulfilled by means of modification or replacement software contained on a replacement memory card for Customer installation. The foregoing shall be MDEA’s sole obligation to you under this limited warranty. All rights under this limited warranty on the Embedded Software are also subject to your acceptance of and compliance with the terms of the Software License Agreement applicable to this television, and this limited warranty on the Embedded Software shall be null and void if the Embedded Software is modified or changed in any manner except as specifically authorized by MDEA.

c. Labor. For thirty (30) days after the original purchase at retail, we will repair or replace, at our option, the lenticular screen if it proves defective. For certain items that are designed to be replaced by the consumer, including (but not limited to) some Embedded Software, the consumer is solely responsible for any replacement labor. Air filter cleaning is normal consumer required maintenance and labor for this procedure is not covered under warranty. Please refer to the Owner’s Guide for air filter cleaning procedures. For all other parts, we will provide the labor for a warranty repair by an authorized MITSUBISHI service center without charge for one (1) year from the original date of purchase at retail.

d. Notice. To obtain warranty service, you must notify an authorized MITSUBISHI service center of any defect within the applicable warranty time period.

e. This LCD Projection Television uses three LCD panels to create the screen image. This technology creates the image using small dots, or picture elements (pixels). Your LCD Projection TV is manufactured to a high level of performance and quality, in fact, 99.99% perfect in the number of properly functioning pixels. As in other display technology, sometimes a pixel is continuously active, inactive or the incorrect color. Our standard is clear; MDEA warrants only that the percentage of properly functioning pixels will be not less than 99.99% of all pixels.

BEFORE REQUESTING SERVICE, please review the instruction booklet to insure proper installation and correct customer control adjustment. If the problem persists please arrange for warranty service.

1. TO OBTAIN WARRANTY SERVICE:

a. Contact your nearest authorized MITSUBISHI service center, whose name and address can be obtained from your MITSUBISHI dealer, by writing at the address provided below, calling MDEA at the 800-332-2119, or by using the support feature of our website site at www.Mitsubishi-tv.com.

b. Warranty service will be provided in your home or, if required, at an authorized service shop, provided that your television is located within the geographic territory customarily covered by an authorized MITSUBISHI service center. If not, you must either deliver your television to an authorized service location at your own expense, or pay for any travel and/or transportation costs the service center may charge to and from your home. Actual service labor will be provided without charge.

c. Proof of purchase date from an authorized MITSUBISHI dealer is required when requesting warranty service. Present your sales receipt or other document which establishes proof and date of purchase. **THE RETURN OF THE OWNER REGISTRATION CARD IS NOT A CONDITION OF COVERAGE UNDER THIS LIMITED WARRANTY.** However, please return the Owner Registration Card so that we can contact you should a question of safety arise which could affect you.

d. To obtain a replacement lamp during the warranty period, please contact the MDEA Consumer Relations Department at (800) 332-2119. After the warranty period you may order the lamp directly from the MDEA Parts Department at (800) 553-7278.

2. THIS LIMITED WARRANTY DOES NOT COVER:

a. Up to .01% pixel outages (small dot picture elements that are dark or incorrectly illuminated).

b. Damage to the lenticular screen or Fresnel lens, screen frame, cosmetic damage or to any other damage where such damage is caused by unauthorized modification, alteration, repairs to or service of the product by anyone other than an authorized MITSUBISHI service center; physical abuse to or misuse of the product (including any failure to carry out any maintenance as described in the Owner’s Guide including air filter cleaning or any product damaged by excessive physical or electrical stress); any products that have had a serial number or any part thereof altered, defaced or removed; product use in any manner contrary to the Owner’s Guide; freight damage; or any damage caused by acts of God or other factors beyond the reasonable control of MDEA, such as power surge damage caused by electrical system or lightning.

(Continued on next page)

Mitsubishi LCD Rear Projection Television Limited Warranty (continued)

This limited warranty also excludes service calls where no defect in the product covered under this warranty is found, service calls related to unsatisfactory audio or visual reception or signal unless caused by a defect in the product that is covered under this limited warranty, all costs, expenses or any other damages arising from product installation, or set-ups, any adjustments of user controls (including contrast, brightness, color, tint, fine tuning, sharpness), other adjustment necessary to prepare the unit for display or use, connection with any external audio receiver, antenna, cable or satellite systems, or service of products purchased or serviced outside the U.S.A. Please consult the operating instructions contained in the Owner's Guide furnished with the product for information regarding user controls.

3. ANY EXPRESS WARRANTY NOT PROVIDED HEREIN, AND ANY REMEDY WHICH, BUT FOR THIS PROVISION, MIGHT ARISE BY IMPLICATION OR OPERATION OF LAW, IS HEREBY EXCLUDED AND DISCLAIMED. THE IMPLIED WARRANTIES OF MERCHANTABILITY AND OF FITNESS FOR ANY PARTICULAR PURPOSE ARE EXPRESSLY LIMITED TO A TERM OF ONE YEAR.

4. UNDER NO CIRCUMSTANCES SHALL MDEA BE LIABLE TO PURCHASER OR ANY OTHER PERSON FOR ANY INCIDENTAL, SPECIAL OR CONSEQUENTIAL DAMAGES, WHETHER ARISING OUT OF BREACH OF WARRANTY, BREACH OF CONTRACT, OR OTHERWISE.

5. Some states do not allow limitations on how long an implied warranty lasts, or the exclusion or limitation of incidental, special, or consequential damages, so the above limitations or exclusions may not apply to you.

6. This limited warranty gives you specific legal rights, and you may also have other rights which vary from state to state.



MITSUBISHI DIGITAL ELECTRONICS AMERICA, INC.

9351 Jeronimo Road
Irvine, CA 92618-1904

Index

A

- A/V Memory Reset. *See* Reset
- A/V Receiver
 - and the Remote Control 61
 - Connecting 29
 - Special Programming for the Remote Control 61
- A/V Reset. *See* Reset
- Antenna
 - Adjusting 46
 - Connecting 26
- ANT 1 Antenna Input 20
- Audio/Video Menu 41, 53
- Audio Inputs 20, 21

B

- Back Panel (illustrated) 20
- Batteries. *See* Remote Control

C

- Cable Box
 - and the Remote Control 32, 61, 63
 - Connecting 24, 25, 28
- Captions Menu 41, 47
- Channels 33, 43, 45. *See also* SQV, QV
 - Digital Channels 64
 - Memorizing 42
 - Naming 45
- Channel Menu 41, 45
- Cleaning
 - Dust Filter 67
 - General 66
- Clock, Set Date and Time 42
- Color Adjustments (PerfectColor™) 55
- Copy Restrictions 29, 33

D

- Date. *See* Clock, Set Date and Time
- Daylight Savings Time 42
- Demo Mode 72
- Device Selection Menu 32
- DIGITAL AUDIO OUTPUT Jack 21
- DVDs
 - and V-Chip Ratings 52
 - Display Formats 36
- DVD Player 29
 - and the Remote Control 18, 62
 - Connecting 29
 - Viewing as Program Source 32
- DVI Analog Audio Input 21
- DVI Device, Connecting 30

F

- Film Mode (for films converted for broadcast) 53
- Filter Cleaning 67
- Format Definitions 36
- Freeze Picture. *See* Pause
- Front Button Lock 51
- Front Panel 15

G

- Ghost Images 9
- GUIDE Key (button) 18, 32

H

- HDMI Device, Connecting 30
- HDMI Inputs 14, 21, 34, 36, 64, 65
 - and V-Chip 52
- HDTV Device, Connecting 24

I

- Icon Order Menu 41, 44
- INFO Key On-Screen Information 33
- INPUT Jacks (VIDEO/S-VIDEO/AUDIO) 20, 64
- Input Name Menu 41, 44

L

- Lamp Cartridge Replacement 68
- LAMP Indicator. *See* LED Indicators
- Lamp Reminder 43
- Language, Digital Broadcasts 54
- Language (for on-screen menus) 42
- LED Indicators 15, 16, 71
- Locks
 - Front-Button Lock 51
 - Lock TV by Time 51
 - V-Chip. *See* V-Chip

M

- Memorize Channels. *See* Channels
- Mute
 - Audio (on-screen indicator) 33
 - Audio Mute and Closed Captions 47
 - MUTE key 18
 - Video Mute (blue screen) 53

O

- On-Screen Information 33

P

- Parental Controls. *See* V-Chip Lock Menu
- Pass Code
 - Resetting 59
 - Setting 49

Pause

- and PIP/POP 34
- PAUSE Key 18
- PerfectColor™ Color Adjustment 55
- PIP/POP (Picture in Picture/Picture outside Picture) 34
 - PIP Device Selection Menu 35
- POWER/TIMER Indicator. *See* LED Indicators

Q

- QV (QuickView™) 18

R**Recording**

- RECORD OUTPUT jack 21
- VCR Connections 27, 28
- REC Key 18, 63
- Remote Control
 - Batteries 19
 - Functions 18
 - Programming 61

Reset

- A/V (all A/V settings) 15
- A/V Memory (for individual devices) 53
- Lamp Reminder 43
- Pass Code 59
- PerfectColor (Color Adjustments) 55
- Remote Control 19
- System Reset Button 15, 70, 72
- TV Reset Menu 72

S

- S-Video, Connecting 24, 27, 28
 - S-VIDEO Jacks 15, 20, 64
- SAP (Second Audio Program) 54
- Satellite Receiver 32, 62, 63
 - Connecting 24
- Setup Menu 41, 42
- Signal Definitions 36
- Speakers, TV 27, 53, 65, 71
- Specifications, TV 64
- SQV (SuperQuickView™) 45, 46
- Stand, TV 8
- STATUS Indicator. *See* LED Indicators
- Stereo System. *See* A/V Receiver
- System Reset. *See* Reset

T

- Time. *See* Clock, Set Date and Time
- Timer 43
- Time Zone 42

V

- V-Chip Lock, Bypassing 59
- V-Chip Lock Menu 49
- V-Chip Menu 49
- V-Chip Ratings (U.S.) 52
- VCR
 - and Programming the Remote Control 62
 - Connecting 27, 28
 - Troubleshooting 71
- VIDEO Inputs (S-Video/Composite Video) 20
- Video Settings 55
- Viewing Device, Change. *See* Device Selection Menu



Website:

www.mitsubishi-tv.com

E-mail:

MDEAservice@mdea.com

**To order replacement or
additional remote controls, lamp
cartridges, or Owner's Guides,
call**

800-553-7278

**For questions, call Consumer
Relations at**

800-332-2119