

myprojectorlamps.com

**The most trusted, dependable name
in projector lamp sales.**



<http://www.myprojectorlamps.com>



<http://www.myprojectorlamps.ca>



<http://www.myprojectorlamps.eu>

The following projector manual has not been modified or altered in any way.



LCD

Projector

User Manual

X300

MODEL LVP-X300U

ENGLISH

FRANÇAIS

DEUTSCH

ITALIANO

ESPAÑOL

中文

APPENDIX

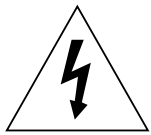
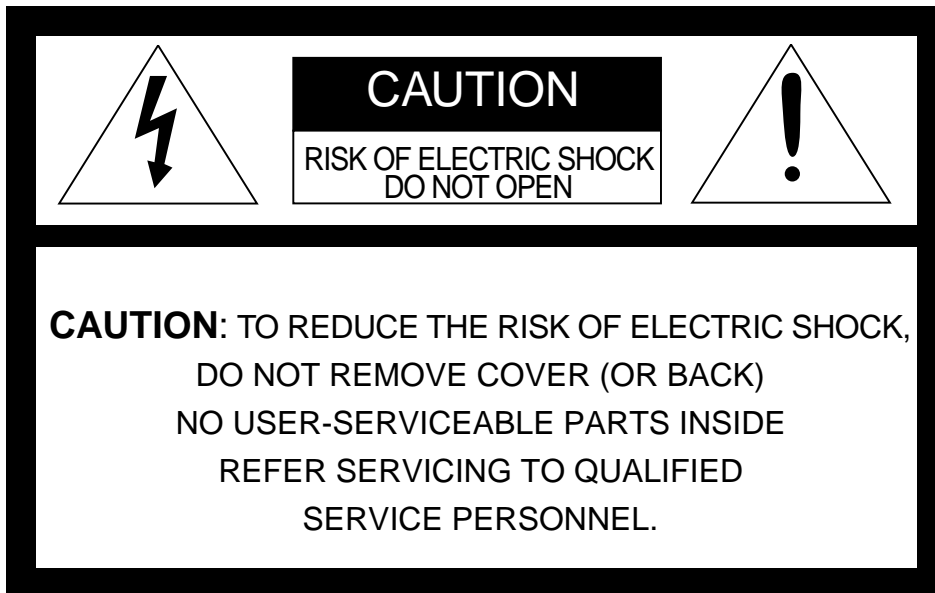

The lightning flash with arrowhead symbol, within an equilateral triangle, is intended to alert the user to the presence of uninsulated “dangerous voltage” within the product’s enclosure that may be of sufficient magnitude to constitute a risk of electric shock.



The exclamation point within an equilateral triangle is intended to alert the user to the presence of important operating and maintenance (servicing) instructions in the literature accompanying the appliance.

WARNING:

TO PREVENT FIRE OR SHOCK HAZARD, DO NOT EXPOSE THIS APPLIANCE TO RAIN OR MOISTURE.

CAUTION:

TO PREVENT ELECTRIC SHOCK, DO NOT USE THIS (POLARIZED) PLUG WITH AN EXTENSION CORD, RECEPTACLE OR OTHER OUTLET UNLESS THE BLADES CAN BE FULLY INSERTED TO PREVENT BLADE EXPOSURE.

NOTE:

SINCE THIS PROJECTOR IS PLUGGABLE EQUIPMENT, THE SOCKET-OUTLET SHALL BE INSTALLED NEAR THE EQUIPMENT AND SHALL BE EASILY ACCESSIBLE.

WARNING

Use the attached specified power supply cord. If you use another power-supply cord, it may cause interference with radio and television reception.

Use the attached RGB cable, RS-232C cable with this equipment so as to keep interference within the limit of a FCC Class A device.

This apparatus must be grounded.

The projector automatically shuts off when the lamp is used up in about 2,000 hours and cannot be used until lamp replacement.

DO NOT LOOK DIRECTLY INTO THE LENS WHEN PROJECTOR IS IN THE POWER ON MODE.

When using the projector in Europe COMPLIANCE NOTICE

This LCD - Video Projector complies with the requirements of the EC Directive 89/336/EEC “EMC Directive” as amended by Directive 93/68/EEC and 73/23/EEC “Low Voltage Directive” as amended by Directive 93/68/EEC.

The electro-magnetic susceptibility has been chosen at a level that gains proper operation in residential areas, on business and light industrial premises and on small-scale enterprises, inside as well as outside of the buildings. All places of operation are characterised by their connection to the public low voltage power supply system.

WARNING

Use the attached RGB cable or RS-232C cable with this equipment so as to keep interference within the limits of a EN55022 Class B and EN55013. Please follow WARNINGS instructions.

Important safeguards	4
Overview	6
Using the remote control	8
Battery installation	8
Installation	9
Basic connections	10
Projector + AV equipment.....	10
Projector + DVD player or HDTV decoder	10
Projector + personal computer	10
For IBM PC or IBM PC compatibles.....	11
For Macintosh	11
Preparing the projector for operation	12
To operate projector power ON	13
Menu operation	15
Picture adjustment.....	18
Specification of RGB signals in each computer mode of the projector	19
Advanced feature for presentation	20
PinP (Picture in Picture).....	20
Expand	20
Still	20
Mouse remote control	21
Lamp replacement	22
Maintenance	23
Troubleshooting	24
Indicators	25
Specifications	26
Kensington Lock	26
Connectors	27
Dimensional drawings	27
Replacement parts list	27

Trademark, Registered trademark

Macintosh is registered trademark of Apple Computer Inc.

IBM and VGA are trademarks or registered trademarks of International Business Machines Corporation.

MicroSaver and Kensington are registered trademarks of Kensington Technology Group.

Other brand or product names are trademarks or registered trademarks of their respective holders.

Important safeguards

Please read all these instructions regarding your LCD projector and retain them for future reference. Follow all warnings and instructions marked on the LCD projector.

1. **Read instructions**
All the safety and operating instructions should be read before the appliance is operated.
2. **Retain instructions**
The safety and operating instructions should be retained for future reference.
3. **Warnings**
All warnings on the appliance and in the operating instructions should be adhered to.
4. **Instructions**
All operating instructions must be followed.
5. **Cleaning**
Unplug this projector from the wall outlet before cleaning it. Do not use liquid aerosol cleaners. Use a damp soft cloth for cleaning.
6. **Attachments and equipment**
Never add any attachments and/or equipment without the approval of the manufacturer as such additions may result in the risk of fire, electric shock or other personal injury.
7. **Water and moisture**
Do not use this projector near water or in contact with water.
8. **Accessories**
Do not place this projector on an unstable cart, stand, tripod, bracket or table. Use only with a cart, stand, tripod bracket, or table recommended by the manufacturer or sold with the projector. Any mounting of the appliance should follow the manufacturer's instructions and should use a mounting accessory recommended by the manufacturer.



An appliance and cart combination should be moved with care. Quick stops, excessive force and uneven surfaces may cause the appliance and cart combination to overturn.

9. **Ventilation**
Slots and openings in the cabinet are provided for ventilation, ensuring reliable operation of the projector and to protect it from overheating. Do not block these openings or allow them to be blocked by placing the projector on a bed, sofa, rug, or bookcase. Ensure that there is adequate ventilation and that the manufacturer's instructions have been adhered to.

10. **Power sources**
This projector should be operated only from the type of power source indicated on the marking label. If you are not sure of the type of power, please consult your appliance dealer or local power company.
11. **Power-cord protection**
Power-supply cords should be routed so that they are not likely to be walked on or pinched by items placed upon or against them. Pay particular attention to cords at plugs, convenience receptacles, and points where they exit from the appliance.
12. **Overloading**
Do not overload wall outlets and extension cords as this can result in a fire or electric shock.
13. **Objects and liquids**
Never push objects of any kind through openings of this projector as they may touch dangerous voltage points or short-out parts that could result in a fire or electric shock. Never spill liquid of any kind on the projector.
14. **Servicing**
Do not attempt to service this projector yourself. Refer all servicing to qualified service personnel.
15. **Damage requiring service**
Unplug this projector from the wall outlet and refer servicing to qualified service personnel under the following conditions:
 - (a) If the power-supply cord or plug is damaged.
 - (b) If liquid has been spilled, or objects have fallen into the projector.
 - (c) If the projector does not operate normally after you follow the operating instructions. Adjust only those controls that are covered by the operating instructions. An improper adjustment of other controls may result in damage and may often require extensive work by a qualified technician to restore the projector to its normal operation.
 - (d) If the projector has been exposed to rain or water.
 - (e) If the projector has been dropped or the cabinet has been damaged.
 - (f) If the projector exhibits a distinct change in performance - this indicates a need for service.
16. **Replacement parts**
When replacement parts are required, be sure that the service technician has used replacement parts specified by the manufacturer or parts having the same characteristics as the original part. Unauthorized substitutions may result in fire, electric shock or other hazards.
17. **Safety check**
Upon completion of any service or repair to this projector, ask the service technician to perform safety checks determining that the projector is in a safe operating condition.

WARNING:**Unplug immediately if there is something wrong with your projector.**

Do not operate if smoke, strange noise or odor comes out of your projector. It might cause fire or electric shock. In this case, unplug immediately and contact your dealer.

Never remove the cabinet.

This projector contains high voltage circuitry. An inadvertent contact may result in an electric shock. Except as specifically explained in the Owner's Guide, do not attempt to service this product yourself. Please contact your dealer when you want to fix, adjust or inspect the projector.

Do not modify this equipment.

It can lead to fire or electric shock.

If you break or drop the cabinet.

Do not keep using this equipment if you break or drop it. Unplug the projector and contact your dealer for inspection. It may lead to fire if you keep using the equipment.

Do not face a lens to the sun.

It can lead to fire.

Use correct voltage.

If you use incorrect voltage, it can lead to fire.

Do not place the projector on uneven surface.

Place the projection on a leveled and stable surface only. Please do not place equipment on unstable surfaces.

Do not look into the lens when it is operating. It may hurt your eyes.

Never let children look into the lens when it is on.

Do not turn off the main power abruptly or unplug the projector during operation.

It can lead to lamp breakage, fire, electric shock or other trouble.

Place of installation

For safety's sake, refrain from setting the projector at any place subjected to high temperature and high humidity. Please maintain an operating temperature, humidity, and altitude as specified below.

- Operating temperature: between +41°F (+5°C) and +104°F (+40°C)
- Operating humidity: between 30 and 90%
- Never put any heat-producing device under the projector so that the projector does not overheat.
- Do not attach the projector to a place that is unstable or subject to vibration.
- Do not install the projector near any equipment that produces a strong magnetic field. Also refrain from installing near the projector any cable carrying a large current.
- Place the projector on a solid, vibration free surface: otherwise it may fall, causing serious injury to a child or adult, and serious damage to the product.
- Do not stand the projector: it may fall, causing serious injury and damage to the projector.
- Place the projector within a slope of $\pm 15^\circ$. Slanting the projector more than $\pm 15^\circ$ may cause trouble or explosion of the lamp.
- Do not place the projector near air-conditioning unit or heater to avoid hot air to the exhaust and ventilation hole of the projector.

COMPLIANCE NOTICE OF FCC

This equipment has been tested and found to comply with the limits for a Class A digital device, pursuant to Part 15 of the FCC Rules. These limits are designed to provide reasonable protection against harmful interference when the equipment is operated in a commercial environment. This equipment generates, uses, and can radiate radio frequency energy and, if not installed and used in accordance with the instruction manual, may cause harmful interference to radio communications. Operation of this equipment in a residential area is likely to cause harmful interference in which case the user will be required to correct the interference at his own expense.

This digital apparatus does not exceed the Class A limits for radio noise emissions from digital apparatus as set out in the interference-causing equipment standard entitled "Digital Apparatus", ICES-003 of the Department of Communications.

Changes or modifications not expressly approved by Mitsubishi could void the user's authority to operate this equipment.

COMPLIANCE NOTICE OF INDUSTRY CANADA

This Class [A] digital apparatus complies with Canadian ICES-003.

Overview

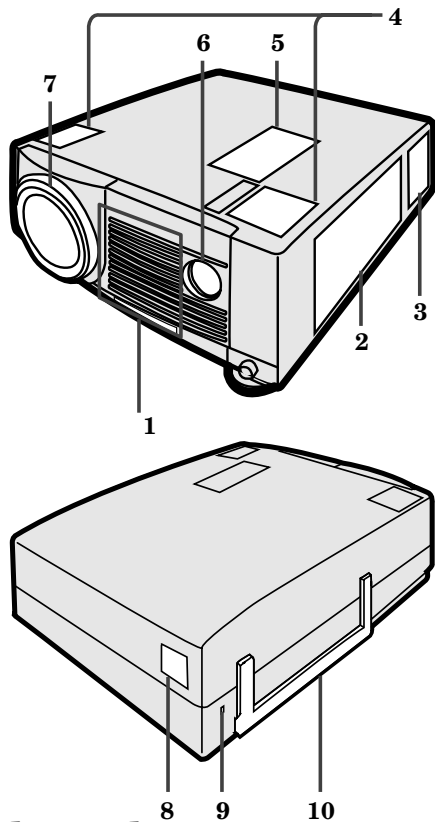

- 1 Air inlet slots (Front)
- 2 Terminal board
- 3 Air outlet slots
- 4 Speaker (Left/Right)
- 5 Control panel
- 6 Remote control sensor (Front)
- 7 Lens
- 8 Remote control sensor (Rear)
- 9 Kensington Security Lock Standard connector
- 10 Easy-carry handle

Control panel

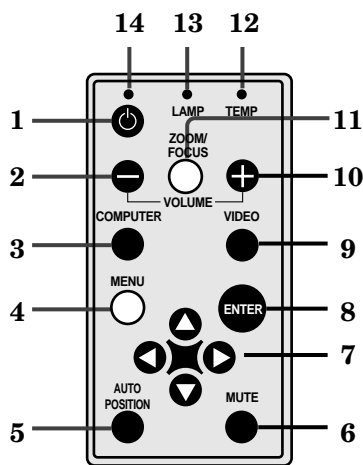

- 1 Power button
- 2 - (VOLUME) button
- 3 COMPUTER button
- 4 MENU button
- 5 AUTO POSITION button
- 6 MUTE button
- 7 Direction buttons
- 8 ENTER button
- 9 VIDEO button
- 10 + (VOLUME) button
- 11 ZOOM/FOCUS button
- 12 Temperature (TEMP) indicator
- 13 LAMP indicator
- 14 Power indicator

Terminal board

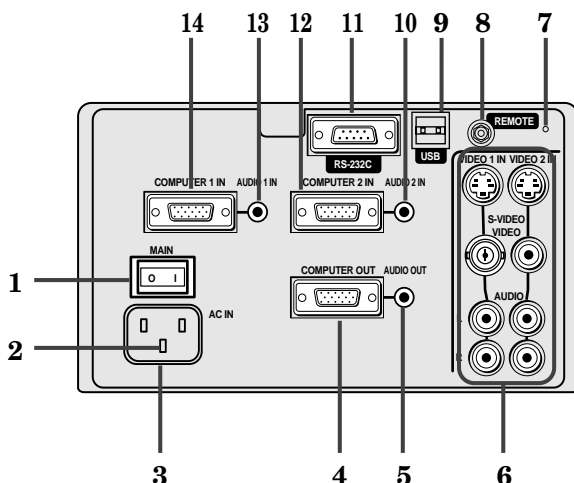

- 1 Main power
I : ON
O : OFF
- 2 Ground terminal
- 3 Power jack
- 4 COMPUTER OUT terminal
- 5 Audio output jack
- 6 Video/audio input terminals
- 7 Reset button
- 8 Wired remote control (REMOTE) jack
- 9 USB terminal
- 10 Audio input 2 (AUDIO 2 IN) terminal
- 11 RS-232C terminal
- 12 COMPUTER 2 IN terminal
- 13 Audio input 1 (AUDIO 1 IN) terminal
- 14 COMPUTER 1 IN terminal

Bottom side

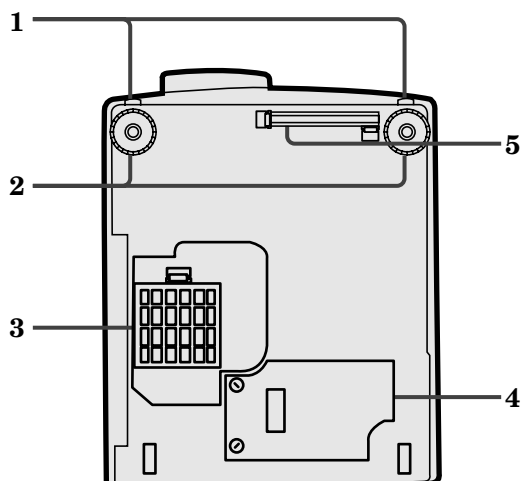

- 1 Release buttons (Left/Right)
- 2 Adjustment foot (Left/Right)
- 3 Air inlet cover (bottom) / Filter cover (For bottom air inlet slots)
- 4 Lamp cover
- 5 Filter cover (For front air inlet slots)

Caution:

Do not replace the lamp right after using the projector. The lamp is very hot.

Remote control

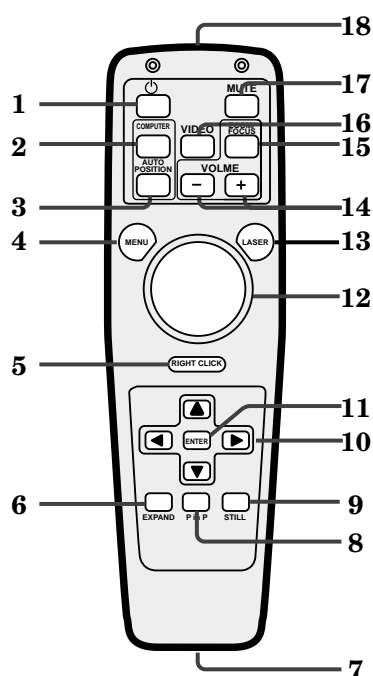

- 1 Power button
- 2 COMPUTER button
- 3 AUTO POSITION button
- 4 MENU button
- 5 RIGHT CLICK button (For mouse)
- 6 EXPAND button
- 7 Wired remote control jack
- 8 Picture in Picture (PiP) button
- 9 STILL button
- 10 Direction buttons
- 11 ENTER button
- 12 Mouse pointer button
- 13 LASER button
- 14 +, - buttons
- 15 ZOOM/FOCUS button
- 16 VIDEO button
- 17 MUTE button
- 18 Remote control transmission area
- 19 Left click button (For mouse)

- When pressing the mouse pointer button, all buttons on the remote control will light up. The light will be turned off about 10 seconds after releasing the mouse pointer button.

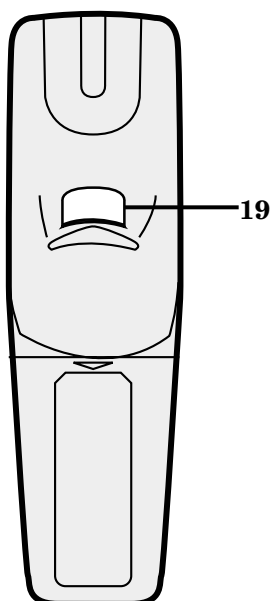

About laser beam

This remote control is class 2 (max. output 1 mW laser diode 645 nm) laser equipment.

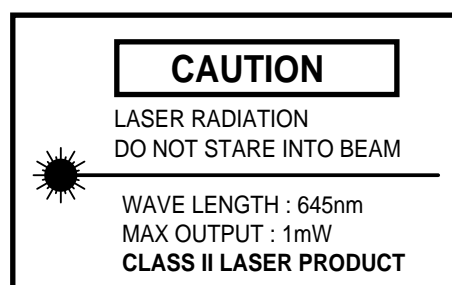

CAUTION :

Pressing the LASER button provided remote control emits laser beam. Do not look into the beam light directly. Do not point the laser beam at people. Looking the laser beam directly may damage eyesight.

Using the remote control

Battery installation

Use two AA size batteries.

1. Remove the back cover of the remote control by pushing the battery compartment door in the direction of the arrow.
2. Load the batteries making sure that they are positioned correctly (+ to +, and - to -).
3. Replace the back cover.

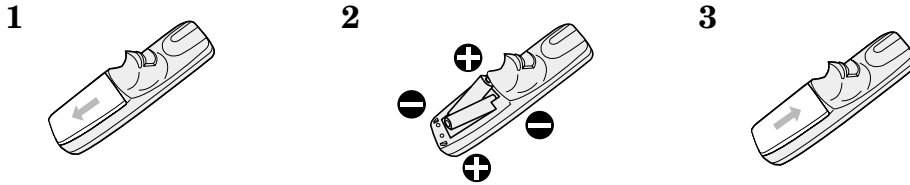

Important:

- Do not use a new battery with an old one.
- Load batteries in the correct position.
- Do not heat, take apart, or throw batteries into fire.
- Do not try to recharge batteries. Do not use rechargeable batteries.
- If the solution of batteries comes in contact with your skin or clothes, rinse with water. If the solution comes in contact with your eyes, rinse them with water and then consult your doctor.

Operation area (for wireless control system)

The range for operation is about 10 m when the remote control points to the projector. The distance to the screen back to the projector must be less than 7 m. Depending on the type of the screen, the distance is different.

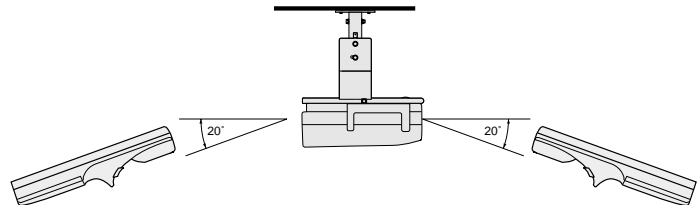
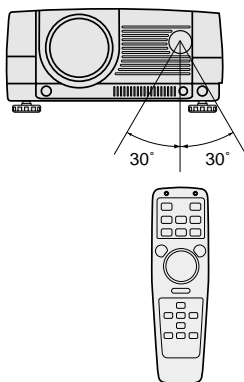
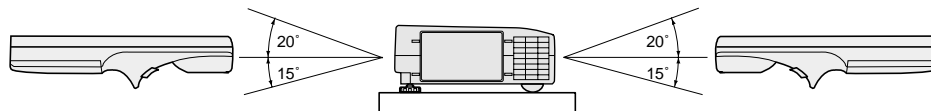

Important:

Avoid the direct sunlight or fluorescent light to the remote control sensor. Also keep the distance of more than 2 m between the remote control sensor and fluorescent lamp on the remote control may not work correctly.

Using the wired remote control

Attached remote control for this projector can be used as a wired remote control with remote control cable. Wired remote control is useful for operating in a distance or outside of the operating area.

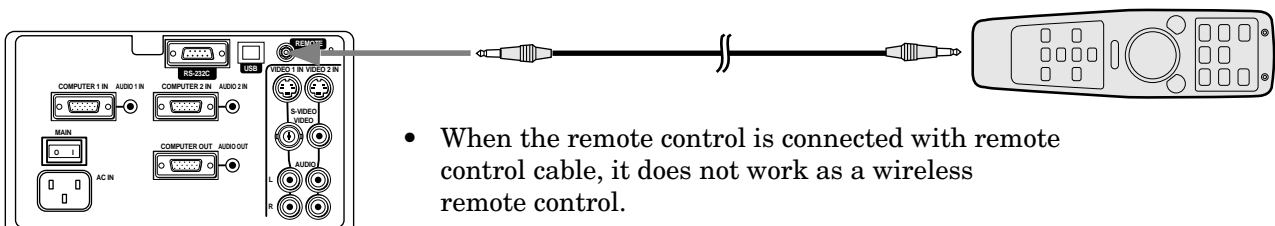

- When the remote control is connected with remote control cable, it does not work as a wireless remote control.

- When you need a longer cable, use a pin-pin cable.
- When using the wired remote control, the laser beam may be darker. It is normal.

Installation

Orientation of the projector

Picture size can be set by changing the distance between the screen and the projector.

Front projection

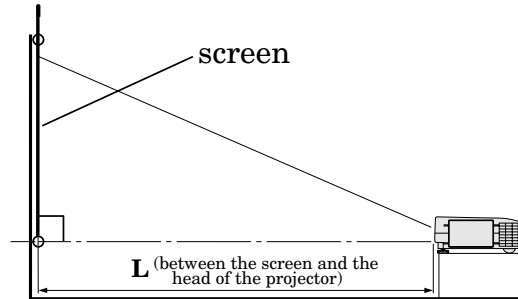

To find the approximate distance between the projector and screen: Multiply the width of the screen $\times 1.9$ (min.), Multiply the width of the screen $\times 2.4$ (max.).

- Refer to the chart for recommended distances in maximum zoom and minimum zoom.

Screen			Distance from screen (L) / (approximate)			
Diagonal size (inch)	Height inches (inch)	Width feet (inch)	Maximum zoom (min.)		Minimum zoom (max.)	
			(cm)	(inch)	(cm)	(inch)
40 "	24 "	32 "	155	61 "	195	77 "
60 "	36 "	48 "	235	92 "	296	116 "
80 "	48 "	64 "	315	124 "	396	156 "
100 "	60 "	80 "	394	155 "	496	195 "
120 "	72 "	96 "	474	187 "	597	235 "
140 "	84 "	112 "	554	218 "	697	274 "
160 "	96 "	128 "	634	250 "	797	314 "
180 "	108 "	144 "	714	281 "	898	353 "
200 "	120 "	160 "	794	312 "	998	393 "
300 "	180 "	240 "	1194	470 "	—	—

- The above numbers are approximate, and may be slightly different from the actual measurements.

Front projection, ceiling mount

For ceiling mount, you need the ceiling mount kit. Ask a specialist for installation. For more details, consult your dealer.

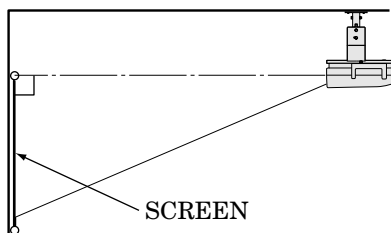

- When using the ceiling mount, set IMAGE REVERSE in the INSTALLATION menu to (Mirror invert). You can not use KEYSTONE when IMAGE REVERSE is set to (Invert) or (Mirror invert). See Page 16.
- Projected images may appear darker when the unit is used as a ceiling installation than when it is used in the tabletop position. This does not signify a product malfunction.

Rear projection

Ask a specialist for installation. For more details, consult your dealer.

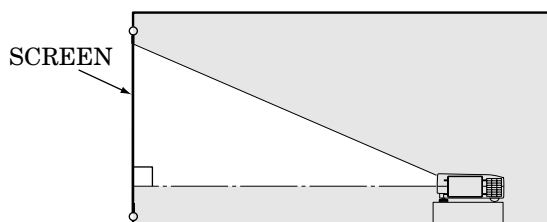

- For rear projection, set IMAGE REVERSE in the INSTALLATION menu to (Mirror). See Page 16.

Caution:

- Placing the projector on a carpet reduces ventilation from the fan at the bottom and might cause problems. Place a hard board or similar item under the projector to facilitate ventilation of the unit.
- Place the projector more than 20 in. from the wall to prevent blocking the intake, exhaust slots and ventilation of this projector because hot air comes out of it.
- Do not use the projector under the following circumstances, which may cause fire or electric shock.
 - in a dusty or humid place
 - while the projector is lying sideways or upside down
 - near a heater
 - in a kitchen or oily, smoky or damp place
 - in direct sunlight
 - with high temperature, such as the closed car
 - where the temperature is lower than 41°F or higher than 104°F

Important:

- Do not put stress on the lens, as this may cause damage.

Basic connections

This projector can be connected to equipment such as VCRs, video cameras, videodisc players, and personal computers having analog RGB output.

Important:

- Make sure that your equipment is turned off before connection.
- Plug in firmly and unplug by holding the plug, not by pulling the main power cable.
- If connected units are set too close to one another, the image may be affected.
- Refer to the owner's guide of each component for details of connections.

Projector + AV equipment

Important:

- Match the color of video and audio plugs on the AV cable with the connections.
- S-video signals take priority over video signals. If you input both S-video signals and normal video signals at the same time, the normal video input automatically is inhibited.

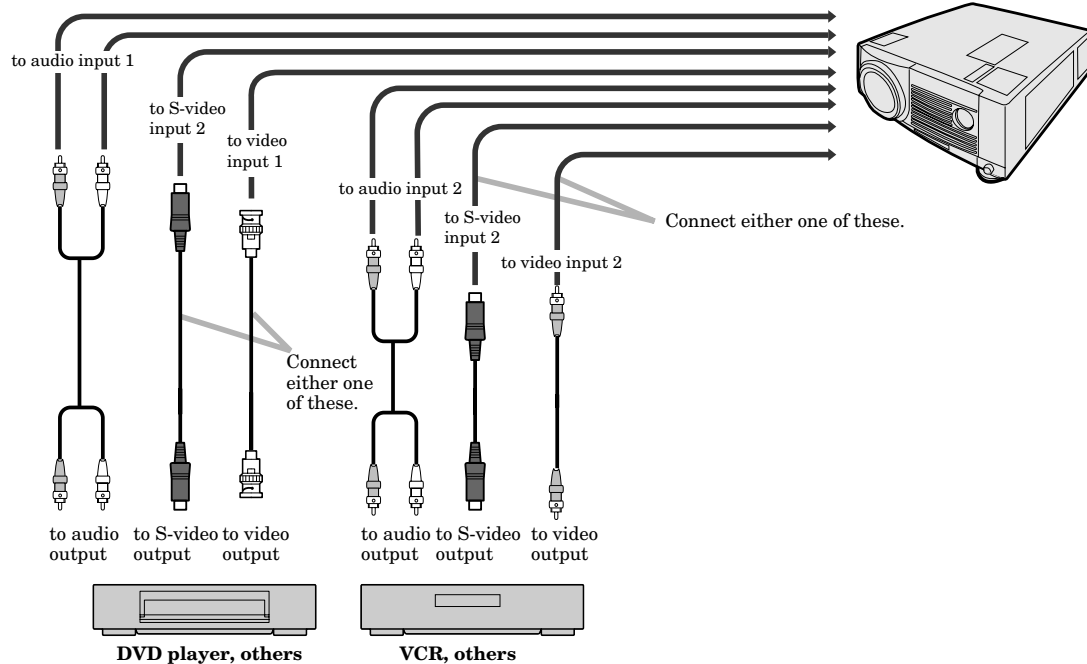

Projector + DVD player or HDTV decoder

Some DVD players have output terminal for 3 line fitting (Y, C_B, C_R). When connecting them to the projector, connect to COMPUTER 1 IN or COMPUTER 2 IN of the projector. In this case, set "Y, C_B, C_R" for COMPUTER INPUT setting in SIGNAL menu.

Connecting with DVD player

DVD player generally has SDTV system component video output (Y, C_B, C_R) terminal. When connecting the projector with DVD player, the COMPUTER INPUT in the SIGNAL setting menu becomes [Y, C_B, C_R] automatically.

Connecting with HDTV decoder

Many HDTV decoders have HDTV system component video output (Y, P_B, P_R) terminal. When connecting the projector with this type of HDTV decoder, the COMPUTER INPUT in the SIGNAL setting menu becomes [Y, P_B, P_R] automatically.

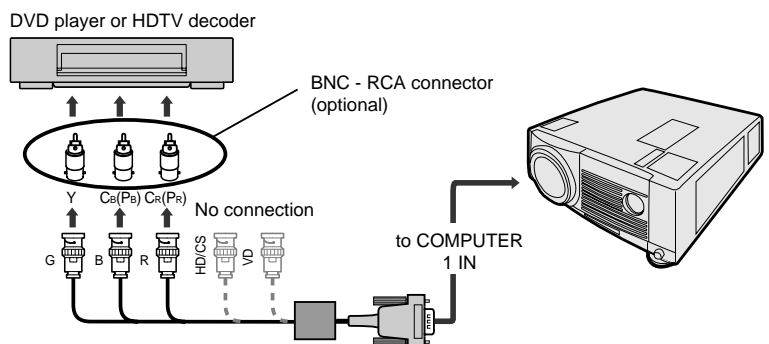

- Y, P_B, P_R is an example of the terminal names for a HDTV decoder.
- The terminal name is different depending on the connected equipment.
- Use mini D-SUB 15 pin-BNC conversion cable for connection.
- Some DVD players may not project the image correctly.
- When connecting with HDTV equipment which has R, G, B output, set RGB for the COMPUTER INPUT in the SIGNAL setting menu.

Projector + Personal computer

Connection

For IBM PC or IBM PC compatibles

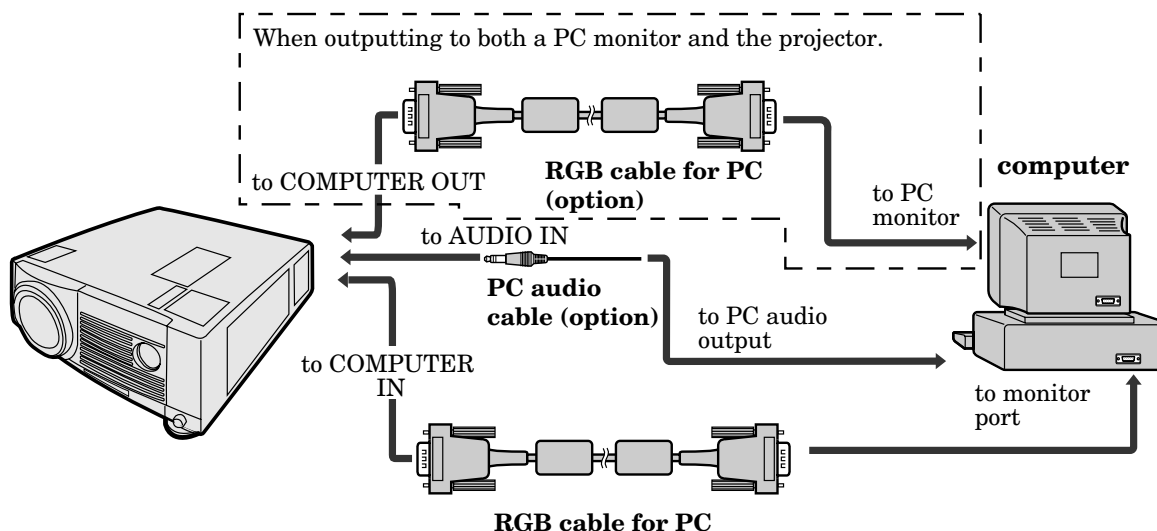

For Macintosh

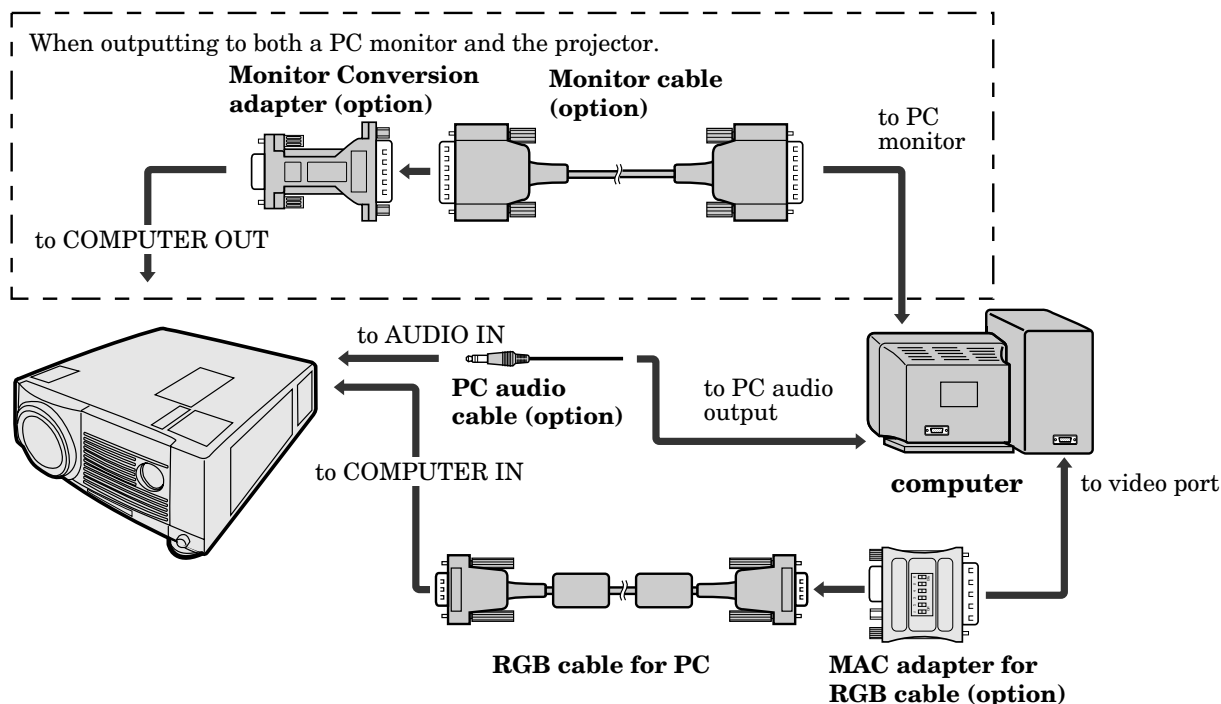

Important:

- Connectors or analog RGB output adapters may be necessary depending on the personal computer connected to this projector. Please contact your dealer.
- The audio input for a personal computer is a stereo mini jack. There are some personal computers that have different types of audio outputs or none at all. Please ask your dealer for details.
- A monitor output adapter is necessary for a Macintosh if it has no video port. Please contact your dealer.
- If you use the MAC adapter for RGB cable, set the dip switch to the appropriate position.

Preparing the projector for operation

Getting ready for projection

1. Connect the power cord provided to the projector.
2. Connect the power cord to the wall power outlet.
3. Remove the lens cap.

Warning:

- Do not look directly into the lens when projector is "ON".
- The lens cap is for protecting the lens. If you leave the power on with the cap on, the cap may be warped. Please remove the lens cap when you turn the power on.
- This projector is equipped with the power cords for both U.S. and Europe. Use the appropriate power cord for your country.
- A three-pin grounding type power plug is used with the projector. Do not remove the grounding pin on the power plug. If you are unable to insert the plug into the outlet, contact your electrician to replace your A/C outlet.
- The supplied power cord for U.S. is used for 120V only. Never connect to any outlet or power supply having a different voltage or frequency. If you connect to the power supply having a different voltage, please use the appropriate power cord.
- Use 100-240V AC 50/60Hz correct voltage otherwise it may lead to fire or electric shock.
- Do not place any objects on the power cord, and keep the projector away from heat sources to avoid breaking the power cord. A broken power cord can cause fire or electric shock.
- Do not revise or alter the power cord otherwise it may cause fire or electric shock.
Contact your dealer if the cord is broken.

Caution:

- Plug in firmly and unplug by holding the plug, not by pulling the cable out.
- Do not plug in or out with wet hands. It may cause an electric shock.

Adjusting the angle of projection

For the best result, project onto a flat screen with a 90 degree angle to the floor. If necessary, tilt the projector by adjusting two foot adjustments on the bottom of the projector.

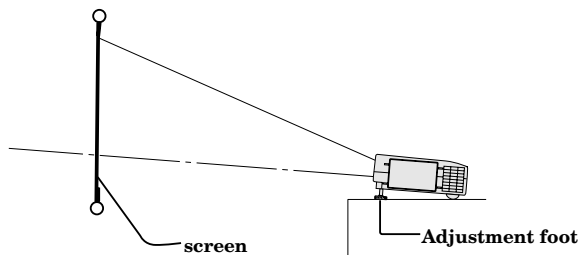

1. Lift the projector to the appropriate angle.
2. Press the buttons by the projector's adjustable front feet, this will allow the feet to slide out to the approximate position.
3. Release the foot adjustment buttons to lock the feet in that position.
4. Rotate the projector feet for fine adjustment.

After using the projector

5. Return the adjustable feet into the projector.

Important:

- Screen on a flat wall with a 90° angle to the floor.
- Align projector to produce a full screen display as illustrated on page 9.
- The distance from the projector to the screen must be compatible with screen size chart on page 9. Note the distance from the screen chart.

To operate projector power ON

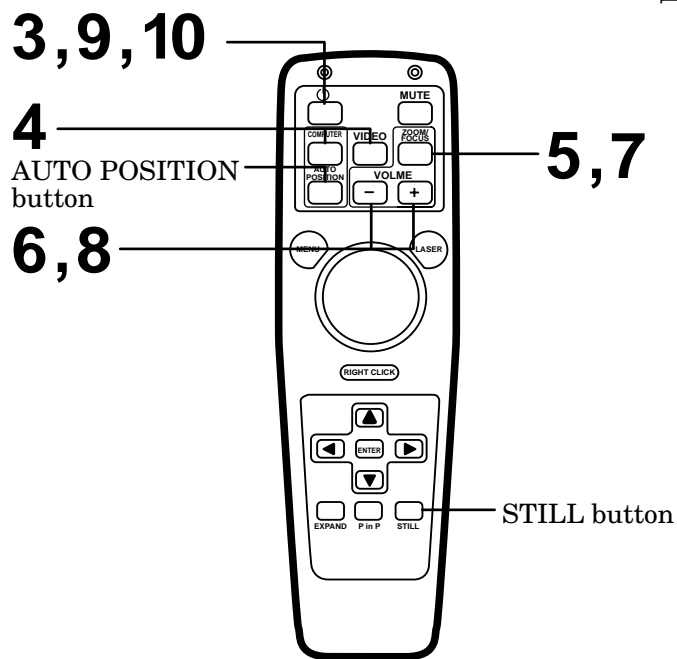
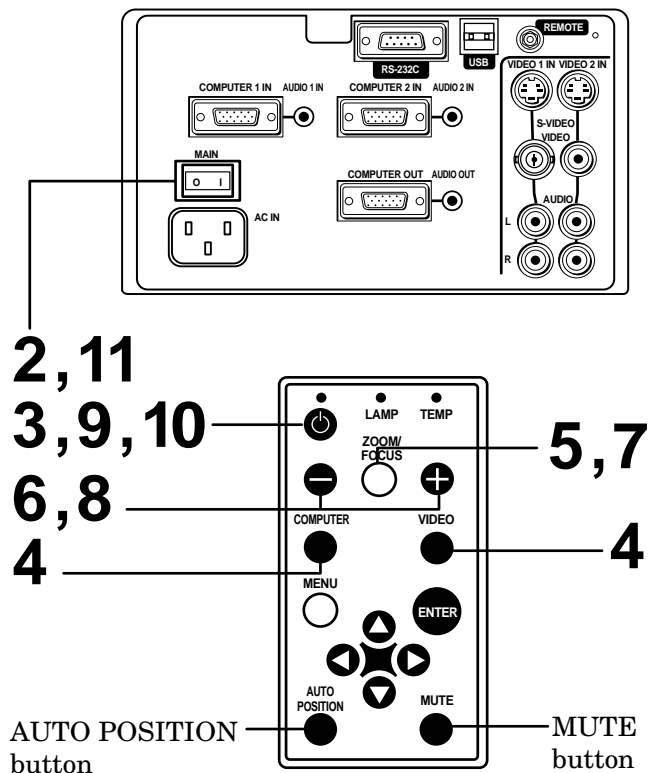

1. Turn on the equipment connected to the projector.
2. Put the projector into standby mode by pressing the main power switch. The POWER indicator lights up red.
3. Turn the projector on by pressing the POWER button. The light source lamp starts warming up, eventually turning completely on. In case the light source lamp does not come on, wait for one minute before switching power on again.
 - If the main power switch to the unit is turned off within two minutes of turning off the light source lamp, power will not be applied to the lamp for one minute when the next time the main unit power switch is turned on. When this happens, the indicator lamp will blink for one minute.

condition	indicator	LAMP	POWER
stand-by		-	red
when light source lamp is on		green	green
light source lamp held off temporarily		-	red

Important:

- A darkened image may be seen right after pressing the POWER button due to warming up of this projector. While warming up, no other commands can be accepted.
- When the lamp indicator is blinking red, the service life of the lamp is about to end. Replace the lamp. See pages 22 and 25.

- The picture might not be of optimum performance in extreme hot or cold conditions. (The projector is not malfunctioning.)
- 4. Select the desired external input source by using the COMPUTER or VIDEO button.
 - The projector automatically selects the appropriate signal format. The selected signal format is displayed on the screen.
 - When selecting the COMPUTER input, the image may flicker. Press the ◀ or ▶ button to adjust the image.
 - When input signal is jittering, please adjust by ◀ or ▶ button also connecting with DVD player or MUSE decoder etc.
 - When supplying unstable signal like Still or Reverse play with VCR, “NO SIGNAL” may appear on the screen. In this case, you may avoid this issue by selecting the right color format like NTSC, PAL in OPTION menu.
- 5. Press the ZOOM/FOCUS button to FOCUS. “FOCUS” will appear on the display.
- 6. Adjust with the + or - button to get a fine picture.
- 7. Press the ZOOM/FOCUS button to ZOOM. “ZOOM” will appear on the display.
- 8. Adjust with the + or - button to get an approximate size.
 - Focus and zoom adjustment is possible in the normal picture mode only. In PinP or EXPAND mode, the adjustment is impossible.

To operate projector power ON (Continue)

Turning off the projector

9. Press the POWER button.

The message “POWER OFF? YES : PRESS AGAIN” appears on the screen.

- To exit from this mode, press any button except POWER, LASER, mouse pointer, R/L-click, STILL and VOLUME + and - buttons.

10. Press the POWER button again.

The light source lamp will be turned off.

Pressing the POWER button second time will shut off the light source lamp, but the exhaust fan continues to operate for 120 seconds to cool down the light source lamp and LCD panels. In this time, the lamp indicator will be turned off.

11. Turn off the main power switch. When turning off the main switch, the POWER indicator turns off.

- In cases where the main power switch is accidentally turned off when either the intake/exhaust fan or the power source lamp is in operation, allow the unit to cool down for 10 minutes with the power turned off. Repeat step 3 when turning on the power source lamp. If the lamp does not turn on immediately, repeat this step two or three times. Replace the lamp if it should still fail to turn on.

AUTO POSITION button

When the source is selected to COMPUTER and the image is not in the right place, set the screen to the brightest display possible, then press the AUTO POSITION button on the remote control. If the image is still not in the right place.

- Set screen to the brightest display as possible (e.g., full-screen display of the “Trash” window) before deploying the automatic adjustment function.
- If the screen saver is running, turn off the screen saver before using the automatic adjustment button.

The volume from the speaker

Press the volume + or – button to change the volume from the speaker.

The volume control bar will appear on the screen.



- The volume control bar will disappear about 10 seconds after releasing the volume buttons.
- The volume buttons do not work when MENU selection bar or MENU is displayed.
- The volume from the audio output terminals and PC audio output terminal are not changed.
- If the high level of audio signal, for example DVD is supplied into PC AUDIO IN terminal, the speaker out may be distorted.

AV mute

Image and audio are temporarily erased with pressing the MUTE button. To restore the image and audio to the normal mode, press the MUTE button again.

- To prevent the damage of the LCD, the image and audio will be restored automatically to the normal mode, 10 minutes after setting the AV mute mode.
- The audios from the audio output terminals and PC audio output terminal are not muted.

Caution:

- When you have finished using this equipment, wait 120 seconds for the exhaust fans to stop. Then turn off the main switch and unplug the power cable from the wall outlet, for safety purposes.
- After the lamp is turned off, the lamp cannot be switched on again for 60 seconds as a precautionary measure. It will take another 60 seconds before the lamp indicator goes off. If you wish to turn on the projector again, wait until the indicator is off then press the POWER button.
- The exhaust fan rotates faster when the temperature around the projector rises.
- When the temperature around the projector becomes too high, the sign “TEMP!!” blinks red on the screen. If the temperature stays too high, the lamp will be shut off automatically.

The projector automatically shuts off when the lamp is used up in about 2,000. You must replace the lamp.

Menu operation

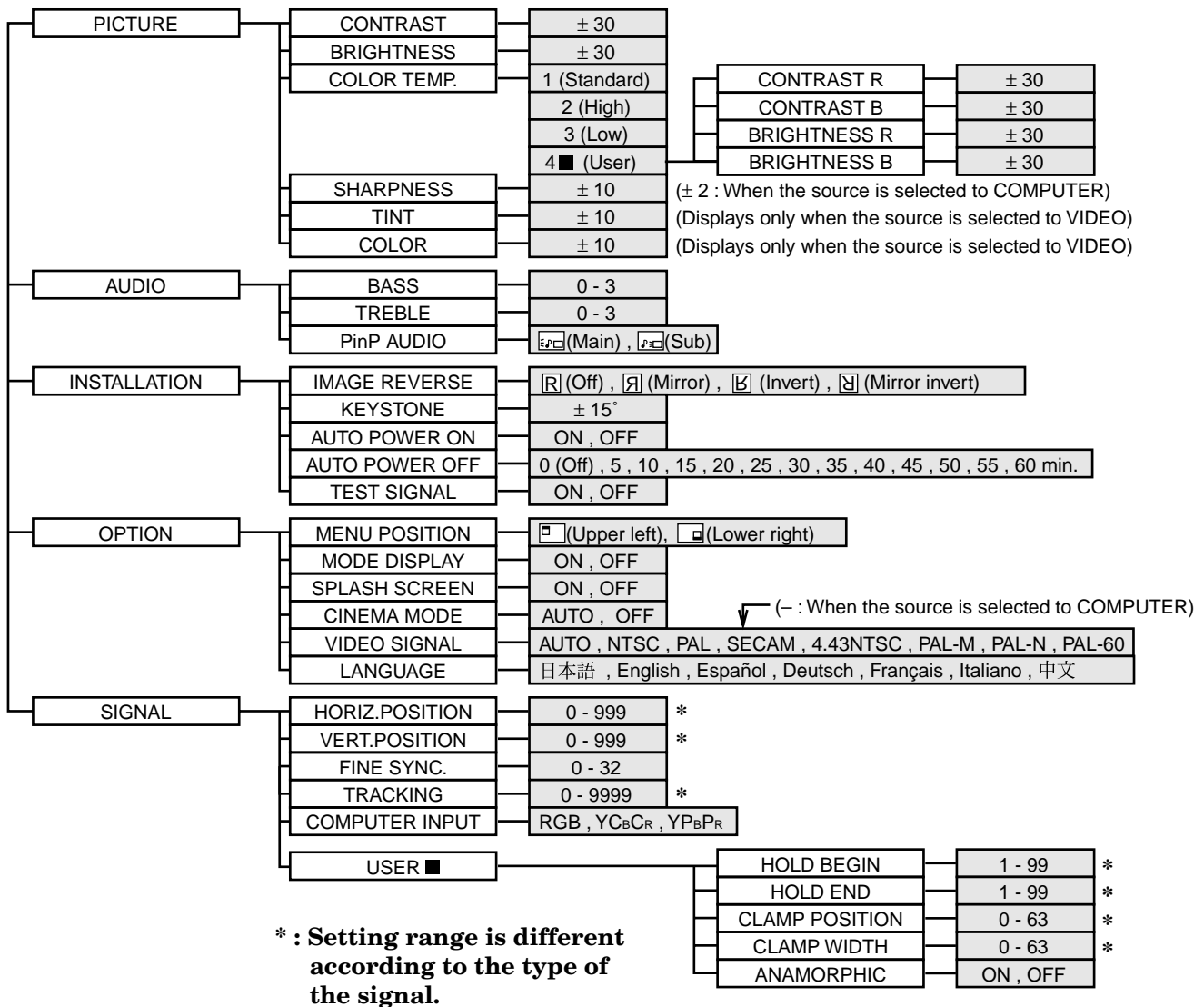

Basic operation

Several settings can be adjusted using Menu.

EXAMPLE: Auto power off time setting

1. Press the MENU button.



2. Press the ◀ or ▶ button to select the OPTION menu.



3. Press the ENTER button (or ▼ button).

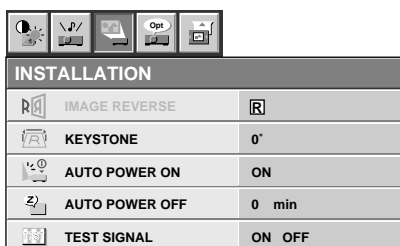

4. Press the ▲ or ▼ button to select AUTO POWER OFF.

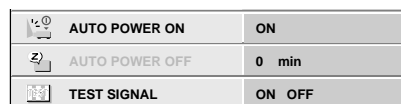

5. Press the ◀ or ▶ button to adjust auto power off time.

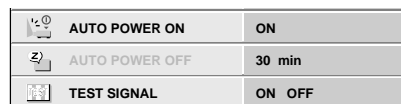

6. Exit the menu system by pressing the MENU button several times.

- If the menu operation is not working, press the RESET button on the terminal board using the suitable implement
- If the COMPUTER or VIDEO button is pressed, the MENU selection bar or MENU will disappear.
- The settings with ■ mark, you should press the ENTER button after selecting.

Menu operation (continued)

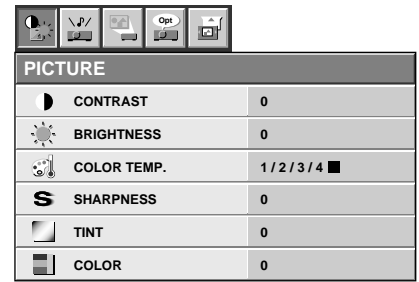

① PICTURE

- CONTRAST** Adjusts the picture contrast. The contrast becomes higher as the number increases.
- BRIGHTNESS** Adjusts image brightness. The image becomes brighter as the number increases.
- COLOR TEMP.** ... Adjusts color temperature. See page 18.
- SHARPNESS** Adjusts the picture sharpness. The sharpness becomes sharper as the number increases.
- TINT** Adjusts the color balance in the image. The color balance of the image shifts green as the number increases and shifts to purple as the number decreases (displays only when the source is selected to VIDEO).
- COLOR** Adjusts the color intensity of the image (displays only when the source is selected to VIDEO).





PICTURE	
CONTRAST	0
BRIGHTNESS	0
COLOR TEMP.	1 / 2 / 3 / 4 ■
SHARPNESS	0
TINT	0
COLOR	0



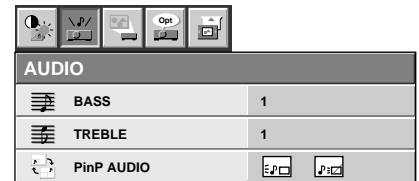



② AUDIO

- BASS** Adjusts the level of low frequencies.
- TREBLE** Adjusts the level of high frequencies.
- PinP AUDIO** Use to select the audio output in the PinP mode,  (Main) or  (Sub).





AUDIO	
BASS	1
TREBLE	1
PinP AUDIO	 

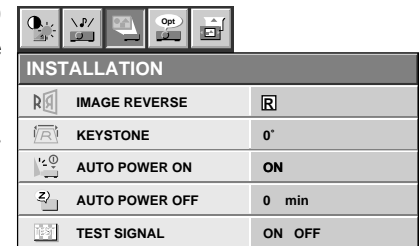

③ INSTALLATION

- IMAGE REVERSE** Use to reverse or invert the projected image.  (Mirror) is used for rear projection.  (Mirror invert) is effective when the projector is ceiling-mounted.
- KEystone** Adjusts keystone correction of the image. If the image has keystone distortion, select the approximate setting. For normal use, select 0°. You can use it only when IMAGE REVERSE is  (Invert) or  (Mirror invert).
- AUTO POWER ON** To select whether to boot up automatically when the power is turned on external to the projector. In this case, the main power switch of the projector has to be ON. Set this when the projector is hanging on the ceiling.
- The projector is in stand-by mode when the lamp is not on. In this case, use the remote control to turn on the lamp.
- AUTO POWER OFF** .. Use to select the length of time before projector switches to stand-by when there is no input signal selected source. Select 0 min. to cancel this function.
- TEST SIGNAL** Use to display the built-in test patterns on the screen.
- The display will disappear when the setting is OFF or when you press any button except MENU, , , STILL, LASER, mouse pointer or R/L-click.





INSTALLATION	
IMAGE REVERSE	 
KEystone	0°
AUTO POWER ON	ON
AUTO POWER OFF	0 min
TEST SIGNAL	ON OFF

④ OPTION

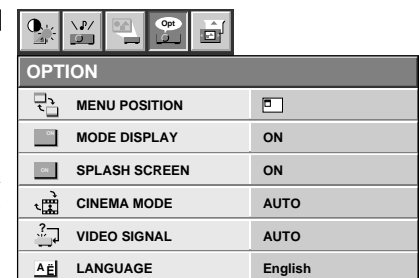
- MENU POSITION** . Use to select the position where the menu is displayed,  (upper left) or  (lower right).
- MODE DISPLAY** ... Use to display the mode display on the screen.
- SPLASH SCREEN** . Use to display the splash screen on the screen when the power is turned ON.
- CINEMA MODE** When AUTO is set, the video signal is processed appropriately for cinema source during inputting the cinema source with NTSC format. If the video signal is processed during inputting the other source, set to OFF.
- When setting CINEMA MODE to AUTO, some images may not switch to cinema mode during inputting the cinema source.
 - When setting CINEMA MODE to AUTO, images may not switch to video mode immediately after switching the cinema source to video source. At that time, the image quality of the video source may get worse. If you wish to switch the mode immediately, press ENTER button.
- VIDEO SIGNAL** . When AUTO is set, the appropriate video format is automatically selected according to the input signal. If the image does not appear correctly, select the desired video format manually. Adjust the unit to the appropriate format when the unit either is not projecting normally in auto mode or is projecting PAL-M/PAL-N signals.
- LANGUAGE** Use to select the language for the projector display such as menu. (日本語/ English / Español / Deutsch / Français / Italiano /中文)



OPTION	
MENU POSITION	 
MODE DISPLAY	ON
SPLASH SCREEN	ON
CINEMA MODE	AUTO
VIDEO SIGNAL	AUTO
LANGUAGE	English

⑤ **SIGNAL**

HORIZ. POSITION Use to adjust the horizontal position of the image.

VERT. POSITION Use to adjust the vertical position of the image.





FINE SYNC. Use to synchronize the projector with PC input signals so that the image is not blurred.

TRACKING Use to avoid image noise such as wide stripes.

COMPUTER INPUT The unit adjusts itself automatically when connected to either DVD players with a component video output terminal (YCbCr or YPbPr) or equipment with HDTV signal output capabilities. In cases where the unit is connected to equipment that include an RGB output terminal and which output HDTV signals, adjust the unit to RGB mode.

- In case of the HDTV, you cannot adjust the horizontal position and the vertical position of the image.



SIGNAL		
	HORIZ. POSITION	0
	VERT. POSITION	0
	FINE SYNC.	0
	TRACKING	0
	COMPUTER INPUT	RGB
USER		■

⑥ **SIGNAL - USER** (Normally, there is no need for adjustments.)





HOLD BEGIN /

HOLD END Adjusts the image when curving near the top.

CLAMP POSITION/

CLAMP WIDTH If you use something similar, the brighter colors of the projected image may become blurred. In this case, adjust CLAMP POSITION or CLAMP WIDTH.

ANAMORPHIC ... Set to ON when displaying DVD discs which are recorded as squeezed images (in right and left direction).

USER		
	HOLD BEGIN	1
	HOLD END	1
	CLAMP POSITION	0
	CLAMP WIDTH	0
	ANAMORPHIC	ON

Picture adjustment

Adjusting the image

You can adjust the picture by using the IMAGE menu.

EXAMPLE: USER setting of COLOR TEMP.

1. Select COLOR TEMP in IMAGE menu.
2. Press the ◀ or ▶ button to select 4 ■.
3. Press the ENTER button.

COLOR TEMP.	
▶ CONTRAST R	0
▶ CONTRAST B	0
☀ BRIGHTNESS R	0
☀ BRIGHTNESS B	0

4. Press the ▲ or ▼ button to select the desired item.
5. Press the ◀ or ▶ button to adjust the item.
6. Repeat steps 4 and 5 for more adjusting.
7. Exit the menu system by pressing the MENU button several times.

PICTURE	
▶ CONTRAST	0
☀ BRIGHTNESS	0
☀ COLOR TEMP.	1 / 2 / 3 / 4 ■
S SHARPNESS	0
■ TINT	0
■ COLOR	0

To control the level of white-to-black in the image :

Adjust CONTRAST in IMAGE menu. Press the ▶ button to increase the contrast and the ◀ button to reduce it.

To control the light level of the image :

Adjust BRIGHTNESS in IMAGE menu. Press the ▶ button to lighten the image and the ◀ button to darken the image.

To adjust the detail and clarity of the image :

Adjust SHARPNESS in IMAGE menu. Press the ▶ button to make the picture seem sharper and the ◀ button to make it softer.

To determine the intensity of the color :

Adjust COLOR in IMAGE menu. Press the ▶ button to increase the amount of color in the image and the ◀ button to decrease it.

To adjust the red-green color balance of the image :

Adjust TINT in IMAGE menu. Press the ▶ button to increase the amount of red in the image and the ◀ button to increase the amount of green in the image.

Adjustment from personal computer

Although this projector sets proper signal systems automatically for the image signal from personal computers, it cannot be applied to some of personal computers. In this case, press the AUTO POSITION button. If the images are still not projected correctly, use the MENU display to adjust the projected images.

Adjusting the images from personal computers in MENU display

Adjust as below for the following symptoms.

SIGNAL	
☐ HORIZ. POSITION	0
☐ VERT. POSITION	0
☐ FINE SYNC.	0
☐ TRACKING	0
☐ COMPUTER INPUT	RGB
USER	■

Image moved to right or left :

Adjust HORIZ. POSITION in SIGNAL menu. Press the ▶ button to move the image to left. Press the ◀ button to move the image to right.

Image moved to up or down :

Adjust VERT. POSITION in SIGNAL menu. Press the ▶ button to move the image to upward. Press the ◀ button to move the image to down.

Image flickers / Image is out of focus :

Adjust FINE SYNC. in SIGNAL menu.

USER	
☐ HOLD BEGIN	1
☐ HOLD END	1
☐ CLAMP POSITION	0
☐ CLAMP WIDTH	0
☐ ANAMORPHIC	ON

Top part of image curves :

Adjust HOLD BEGIN or HOLD END in USER menu for image which top part is the least curved.

Wide stripes appear :

Adjust CLAMP POSITION or CLAMP WIDTH of each menu in SIGNAL - USER menu.

Image does not move naturally :

Adjust VERT. SYNC. of the menu in SIGNAL - USER menu. Select AUTO for normal setting.

- Do not change each menu setting in USER menu for normal setting.

Simple adjustment method

1. Select HORIZ. POSITION in SIGNAL menu.
2. Press the ◀ or ▶ button to adjust the horizontal start position (the left end).
3. Select TRACKING in SIGNAL menu.
4. Press the ◀ or ▶ button to adjust the horizontal end position (the right end).
5. Repeat steps 1 to 4 for fine adjustment.
6. Select VERT. POSITION in SIGNAL menu.
7. Press the ◀ or ▶ button to adjust the vertical start position (the top end).

Specification of RGB signals in each computer mode of the projector

Signal mode	resolution (H x V)	horizontal frequency (kHz)	Vertical frequency (Hz)	Normal mode (H x V)	Real mode (H x V)
TV60	–	15.73	59.94	1024 x 768	–
TV50	–	15.63	50.00	1024 x 768	–
HiVision	–	33.75	60.00	1024 x 576	–
PC98	640 x 400	24.82	56.42	1024 x 640	640 x 400
CGA70	640 x 400	31.47	70.09	1024 x 640	640 x 400
CGA85	640 x 400	37.86	85.08	1024 x 640	640 x 400
VGA60	640 x 480	31.47	59.94	1024 x 768	640 x 480
VGA72	640 x 480	37.86	72.81	1024 x 768	640 x 480
VGA75	640 x 480	37.50	75.00	1024 x 768	640 x 480
VGA85	640 x 480	43.27	85.01	1024 x 768	640 x 480
SVGA56	800 x 600	35.16	56.25	1024 x 768	800 x 600
SVGA60	800 x 600	37.88	60.32	1024 x 768	800 x 600
SVGA72	800 x 600	48.08	72.19	1024 x 768	800 x 600
SVGA75	800 x 600	46.88	75.00	1024 x 768	800 x 600
SVGA85	800 x 600	53.67	85.06	1024 x 768	800 x 600
XGA43i	1024 x 768	35.52	86.96	1024 x 768	1024 x 768
XGA60	1024 x 768	48.36	60.00	1024 x 768	1024 x 768
XGA70	1024 x 768	56.48	70.07	1024 x 768	1024 x 768
XGA75	1024 x 768	60.02	75.03	1024 x 768	1024 x 768
XGA85	1024 x 768	68.68	85.00	1024 x 768	1024 x 768
SXGA70a	1152 x 864	63.85	70.01	1024 x 768	1024 x 768
SXGA75a	1152 x 864	67.50	75.00	1024 x 768	1024 x 768
SXGA85a	1152 x 864	77.49	85.06	1024 x 768	1024 x 768
SXGA60a	1280 x 960	60.00	60.00	1024 x 768	1024 x 768
SXGA75a	1280 x 960	75.00	75.00	1024 x 768	1024 x 768
SXGA43i	1280 x 1024	46.43	86.87	960 x 768	1024 x 768
SXGA60	1280 x 1024	63.98	60.02	960 x 768	1024 x 768
SXGA75	1280 x 1024	79.98	75.03	960 x 768	1024 x 768
SXGA85	1280 x 1024	91.15	85.02	960 x 768	–
MAC13	640 x 480	35.00	66.67	1024 x 768	640 x 480
MAC16	832 x 624	49.72	74.55	1024 x 768	832 x 624
MAC19	1024 x 768	60.24	75.02	1024 x 768	1024 x 768
MAC21	1152 x 870	68.59	74.96	1024 x 768	1024 x 768
HP75	1024 x 768	62.94	74.92	1024 x 768	1024 x 768
HP72	1280 x 1024	78.13	72.00	960 x 768	1024 x 768
SUN66a	1152 x 900	61.85	66.00	984 x 768	1024 x 768
SUN76a	1152 x 900	71.81	76.63	984 x 768	1024 x 768
SUN76	1280 x 1024	81.13	76.11	960 x 768	1024 x 768
IBM60	1280 x 1024	63.42	60.00	960 x 768	1024 x 768

- Pressing the EXPAND button on the remote control twice will switch to the screen displaying the picture as its original size (real screen display). In the real screen display, pictures will be black-framed when picture resolution is lower than 1,024 x 768.

Important:

- Some computers may not be compatible with the projector.
- The projector's maximum resolution is 1,024 x 768 pixels. It may not display correctly for the pictures of higher resolutions than 1,024 x 768.
- The picture with a SYNC on G (Green) signal may jitter.
- The picture with a SYNC on G (Green) signal may be tinged with green.

- If the resolution and frequency of your computer are not shown on the table, change the resolution of your computer. You may find the compatible resolution and frequency.
- Set the COMPUTER INPUT in SIGNAL menu to RGB, when inputting the HDTV signal as RGB signal.
- In case of the HDTV, the image quality may be reduced, principally.

About DDC™

The projector complies with VESA™ DDC™1/2B (EDID) specification. If your computer provides DDC™1/2B (EDID) function, setup will be done automatically. For use this function, you must download the driver from our Internet Home Page. Please contact your dealer or Mitsubishi sales office for more details.

Advanced features for presentation

PinP (Picture in Picture)

One of the special features of this unit is the picture-in-picture (PinP) mode. PinP allows you to view different sources at the same time.

1. Press the PinP button on the remote control.
The sub image will appear.

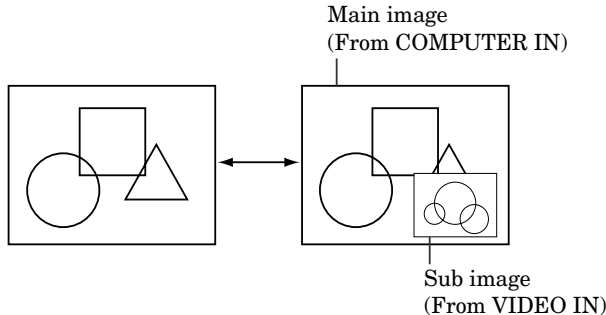

- Pressing the PinP button repeatedly will select on and off.
 - You can change the position of the sub image by pressing the ▲, ▼, ◀ or ▶ button.
 - You can change the size of the sub image by pressing the + or - button.
2. If necessary, select the desired external input source of the sub image by using the VIDEO button.
 - You can change the external input source of the main image by using the COMPUTER button.
 3. Press the PinP button on the remote control again.
The sub image will be disappeared.
- During PinP mode, the audio selected in PinP AUDIO of the AUDIO menu is outputted.
 - During PinP mode, you cannot adjust the zoom/focus and the volume.
 - Adjusting contrast, brightness, tint or color isn't available during PinP mode.
 - When connecting DVD player or MUSE decoder etc. to COMPUTER IN terminal, PinP are not available.
 - During PinP mode, the expand mode is not available.

Expand

By pressing the EXPAND button on the remote control, you can view the detailed image of the picture. You can also view the screen displaying the picture as its original size (real screen display) by pressing the button again.

Using the Expand mode

1. Press the EXPAND button.
 - You can magnify different areas of the active picture by pressing the ▲, ▼, ◀ or ▶ button.
 - You can change the magnification of the zoomed area by pressing the + or - button.
2. Press the EXPAND button on the remote control again.
The real screen display will appear on the screen.
3. Press the COMPUTER or VIDEO button.
The normal screen display will appear on the screen.

- **Display enlargement does not work with video input or S-video input.**
- In EXPAND mode or REAL mode, pressing the COMPUTER or VIDEO button will switch to the normal screen display .
The normal screen display will appear on the screen.
- In EXPAND mode, you cannot adjust the zoom/focus and the volume.
- When displaying the images through VIDEO IN terminal or the video images through COMPUTER IN terminal, expanded image display is not available. Only real screen display is available.
- During expand mode, the PinP mode is not available.

REAL screen display

- During REAL mode, Press the ◀ or ▶ buttons for fine adjustment. the ▲ and ▼ buttons are not working at this time.
- The expanding rate cannot be changed by pressing either the + or - button. They are working for volume adjustment.

Still

How to stop the picture temporarily (still picture).

1. Press the STILL button on the remote control.
The picture will stop temporary.

To resume picture activity.

2. Press the STILL button on the remote control again.

Mouse remote control

By connecting to personal computer through the USB, PS/2 or ADB port, you can operate your computer with the projector remote control.

Connection

Projector + PC with USB connector

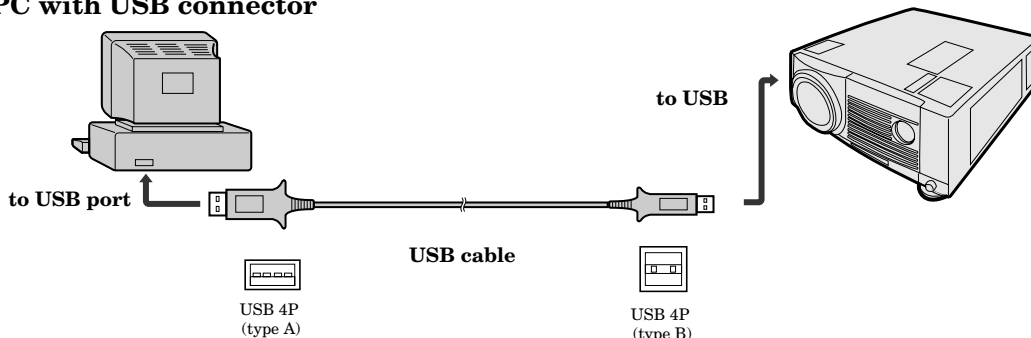

- You can use the mouse remote control function with computer supported USB only. If your system is Windows® 98 or higher, your computer supported USB in standard. If your system is Windows® 95 or lower, please contact your dealer. If your computer is Macintosh with USB port, you can use this function.

Projector + IBM PC or IBM PC compatibles

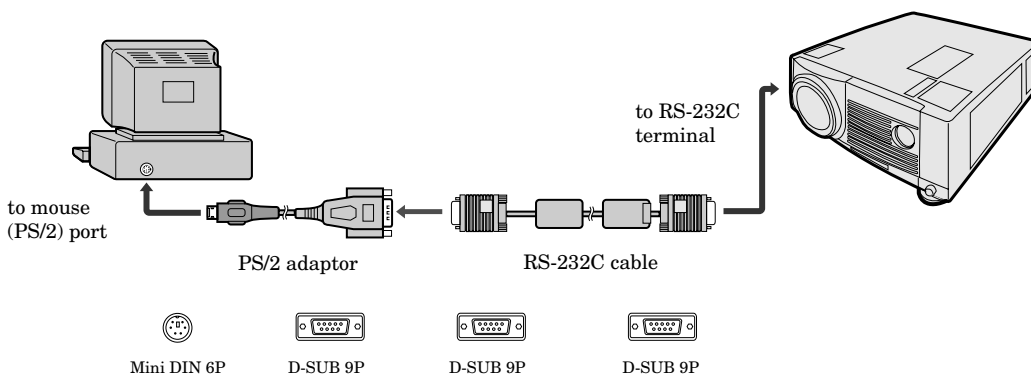

Projector + Macintosh

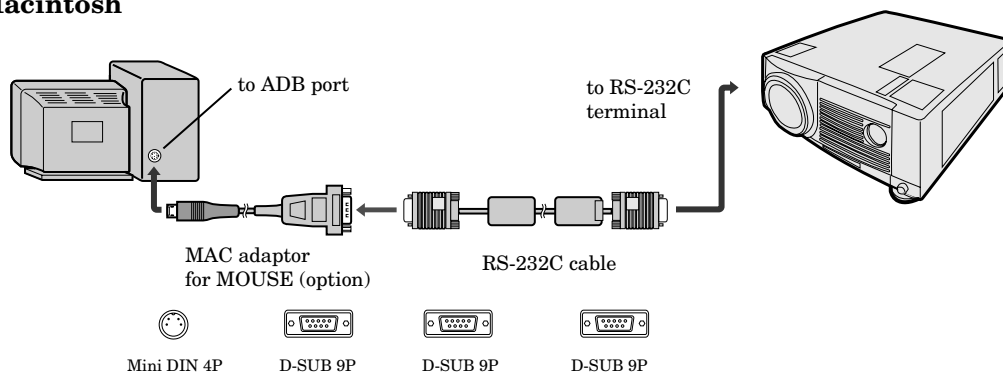

Operation

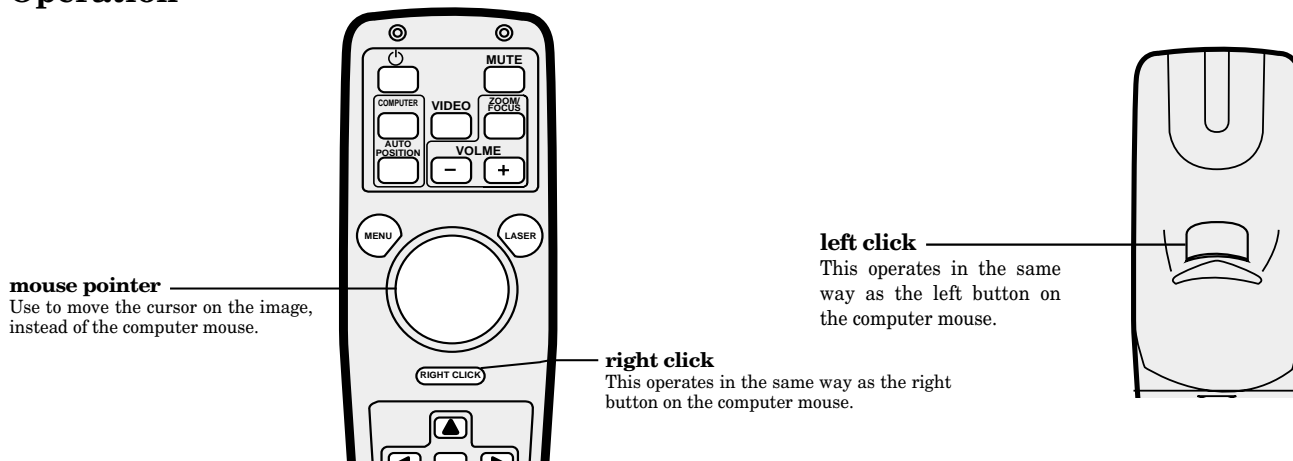

- If the mouse remote control is not working, restart the computer.

Lamp replacement

The lamp is designed to project the image on the LCD panels. When the lamp no longer functions, replace it with a new one.

Caution:

- Do not remove the lamp immediately after using the projector, you may get burned because of the high temperature of the lamp.
- When you replace the lamp, press the power button to power off, then wait for 120 seconds in stand-by mode to allow the lamp and LCD panels to cool. Turn off the main switch, unplug the power cord from the outlet, and wait one hour so that the lamp is cooled to the touch.
- Do not remove the lamp except for replacement. Careless treatment can cause injury or fire.
- Do not touch the lamp element directly. It may break and cause you to injure or burn yourself.
- Be sure not to drop the lamp lid screw into the projector. Also be sure not to insert metal or any flammable objects, it may cause fire or electric shock. If any objects are inserted, please unplug and contact your dealer.
- Install the lamp securely, failure may cause a fire.

1. Reverse the projector gently.

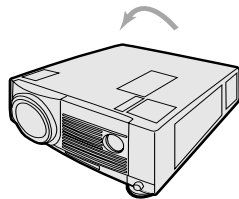

2. Loosen the screws of the lamp lid on the top cover using a phillips screwdriver (+), and remove the lid.
- Remove the lamp cover in the direction of the arrow as indicated.

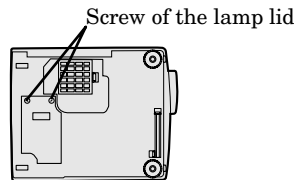

3. Loosen screws (a) using a phillips screwdriver (+), and remove them.

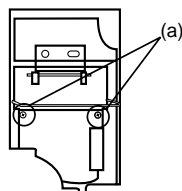

4. Hold onto the projector by the handle as you pull out the lamp. Once the lamp has been removed, do not spill liquid on it, place it near flammable objects or where children can touch it. Otherwise, it will cause injury or fire.

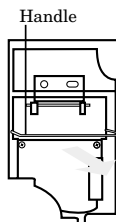

5. Insert the new lamp securely into the projector body in the right direction.

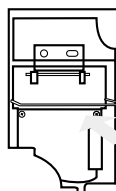

6. Tighten up the screws (a) using a phillips screwdriver (+).
7. Tighten up the screws of the lamp lid using a phillips screwdriver (+).

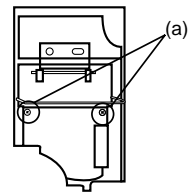

How to reset the operation time meter

Plug in the power cord, switch on the projector, and reset lamp time by pressing the ◀, ▶ and POWER buttons simultaneously.

Important:

- If the 3 buttons was not pressed at the same time, the lamp time may not be reset.
- Please confirm the TEMP indicator illuminates about 2 seconds and the lamp time has been reset.
- The projector will not turn on if you do not secure the lamp lid.
- You must reset the operation time meter after you replace the lamp.
- Do not reset the operation time meter unless the lamp has been replaced.

Caution:

- Do not spill liquid on the lamp or place it near flammable objects or where children can touch it. Otherwise, it could cause injury or fire.
- Be sure that the projector guide is firmly inserted between the right and left lamp guides.

The life of the lamp

The average life of the lamp for the projector is about 2,000 hours of consecutive use. Life span may differ according to operating environment, and may be shorter than 2,000 hours. Decreases in luminescence and/or color brightness will indicate that the light source lamp needs to be replaced. When lamp operation time exceeds 1,500 hours, the indicator will flash alternately between green and red (while the lamp is in operation; when the lamp is not in operation, the indicator will appear red only). When the lamp has been used for about 1,900 hours, the message "LAMP!!" will appear on the screen for one minute. When the lamp has been used for about 2,000 hours, the projector will automatically shut off for the safety of the lamp and the power indicator light will be red. The projector cannot be used until the lamp has been replaced and operation timer has been reset.

Caution:

- The lamp is fragile. If broken, be careful not to cut yourself with glass fragments.
- The lamp life depends on the environment. For replacement lamps, please contact your dealer.

The projector automatically shuts off after about 2,000 hours, and you cannot use the projector until you replace the lamp.

Maintenance

Caution:

Be sure to turn off the projector and unplug the power cord from the wall outlet before you perform any maintenance on the projector.

Cleaning the air-filter

This projector has two air-filters, for bottom air-outlet slots and for front air outlet slots. Clean the air-filter frequently. If the filter or ventilation slots become clogged with dirt or dust, the temperature inside the projector may rise and shut off the power (the TEMP indicator starts to blink red).

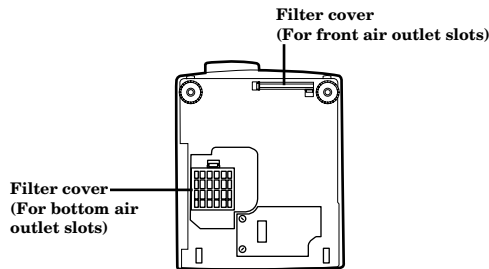

For bottom air outlet slots

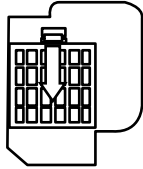
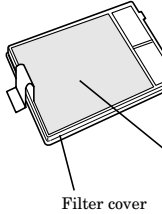
1. To remove the filter cover, press the ridged area gently, push the cover in the direction of the arrow and lift.
2. Remove the air-filter from the filter cover.
3. Wash the air-filter.
 - Use water or a mild detergent diluted with water to clean the filter. Rinse the filter thoroughly and let it dry completely.
4. Attach the filter to the cover.
5. Reinstall the filter cover.

For front air outlet slots

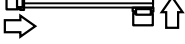
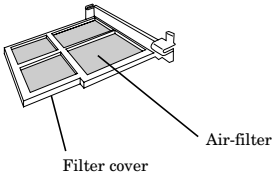
1. To remove the filter cover, press the two ridged area gently and pull the cover.
2. Remove the dust from the air-filter by using a vacuum cleaner.
 - Do not wash the air-filter.
3. Reinstall the filter cover.

Important:

- If the filter is damaged or becomes extremely dirty, contact your dealer for replacement.
- The power will not turn on if the air-filter cover is improperly installed.

Caution:

Be sure to use the projector with an air-filter. If not, dust may get inside the projector, causing a fire or a breakdown.

Cleaning the projector and the ventilation slots

Use a soft cloth to clean the projector and the ventilation slots. When the slots become dirty, wipe them with a soft cloth dampened with a diluted mild detergent, and then wipe them with a dry cloth.

To protect the surface of the projector from fading or deteriorating:

- Do not spray insecticide on or inside the projector.
- Do not use benzine or thinner to clean it.
- Do not let rubber or plastic materials come into contact with the projector.

Cleaning the lens

Use a standard lens-cleaning brush or a piece of lens tissue dampened with lens cleaning fluid. The lens surface is fragile. Use only recommended, nonabrasive lens-cleaning materials. Do not touch the lens with your fingers.

Troubleshooting

The following offers solutions to some of the common problems you may encounter. We suggest that you consult this chart before contacting your dealer.

PROBLEMS	CAUSE	POSSIBLE SOLUTIONS
The power is off.	<ul style="list-style-type: none"> The air inlet slots, outlet slots or air filter is clogged with dust or some objects. <p>POWER indicator does not light up.</p> <ul style="list-style-type: none"> Power cord is unplugged from the outlet. Power cord is disconnected from the projector. The main switch is turned off. The lamp lid is open. <p>POWER indicator blinks red.</p> <ul style="list-style-type: none"> The projector has been turned on again too soon after having been turned off. When the power switch was turned off while the fan was running, during or after lamp operation. The room temperature is too high. (Does the LAMP indicator show an unusual condition?) <p>POWER indicator blinks between red and green.</p> <ul style="list-style-type: none"> Lamp is no longer working. The filter cover is not closed. When the LAMP indicator or the TEMP indicator is either on or blinking, the main unit requires repairs. 	<ul style="list-style-type: none"> Remove the object. Plug the power cord into the outlet. Insert the power cord into the projector. Turn the main switch on. Close the lamp lid. Wait for the lighting sequence. Turn the power switch on and off several times. Refer to "Indicators" on page 25. Replace the lamp with a new one. Close the cover correctly. Contact your dealer.
No picture appears on the screen.	<ul style="list-style-type: none"> Lens is covered by lens cap. When the LAMP indicator or the TEMP indicator is either on or blinking, the main unit requires repairs. The equipment connected to this projector is not turned on. Hookup is not made correctly with other equipment. The input source is not selected correctly. 	<ul style="list-style-type: none"> Take the lens cap off. Replace the lamp with a new one. Turn on the connected equipment. Confirm the hookup. Select the correct source according to the equipment connected to this projector.
The image is turned off.	<ul style="list-style-type: none"> The air inlet slots, outlet slots or air filter is clogged with dust or some objects. (In this case, the TEMP indicator does not light up.) 	<ul style="list-style-type: none"> Remove the object and turn off the main power switch. After about 10 minutes, Turn the projector on.
The image is distorted.	<ul style="list-style-type: none"> The projector is not at a right angle to the screen. 	<ul style="list-style-type: none"> Adjust the angle of the projector to make a right angle to the screen. See page 12.
The image is dark.	<ul style="list-style-type: none"> Brightness, tint and color are not adjusted correctly. 	<ul style="list-style-type: none"> Adjust brightness, tint and color correctly.
The image is blurred.	<ul style="list-style-type: none"> The projecting distance is beyond the focused area. Lens is dirty. Screen size exceeds screen size specifications. Brightness and contrast are not adjusted correctly. FINE adjustment is not made correctly. Tracking is not adjusted. The projector is not at a right angle to the screen. 	<ul style="list-style-type: none"> Adjust the projecting distance. See page 9. Clean lens. Reduce screen size to within 40" to 300". Adjust brightness, contrast. Make FINE adjustment. Adjust tracking. Adjust the angle of the projector to make a right angle to the screen. See page 12.
The image remains blurred.	<ul style="list-style-type: none"> When you see the stationary image for a long time, it may remain on the screen if you change the image. It is not a breakdown. The blurred image will disappear in a few minutes. 	
Red, blue or green dots are viewed on the text of image.	<ul style="list-style-type: none"> It is normal. 	
The image is distorted on the screen and noise is heard.	<ul style="list-style-type: none"> The cable for connection with other equipment is not plugged securely into the terminal. The projector is installed too close to other equipment. 	<ul style="list-style-type: none"> Plug the connecting cable securely into the terminal. See pages 10-11. Install the projector far away from other equipment.
No sound is heard.	<ul style="list-style-type: none"> Volume is not turned up. Connection to other equipment is not made correctly. 	<ul style="list-style-type: none"> Turn up the volume. Check connections. See pages 10-11.
Nothing is displayed on the PC monitor.	<ul style="list-style-type: none"> The PC monitor is not turned on. 	<ul style="list-style-type: none"> Turn on the monitor.
Warm air comes out of the exhaust vents.	<ul style="list-style-type: none"> This is typical of the LCD projector. 	
Adjustments cannot be made.	<ul style="list-style-type: none"> The operation is incorrectly made due to noise or interference. 	<ul style="list-style-type: none"> Press the reset button on the Terminal board. See page 15.

Indicators

The projector has three indicators each of which shows the working condition of the projector.

The following offers solutions to possible problems. If a problem persists, turn the projector off and consult your dealer.

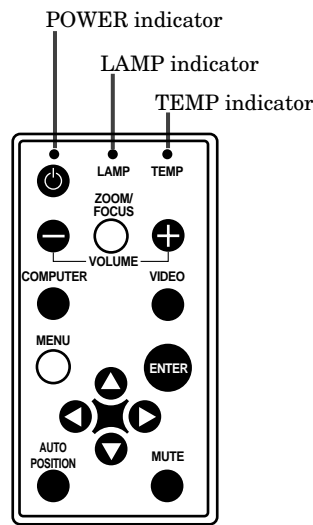

Normal condition

POWER	LAMP	TEMP	CONDITION	Notes
Steady red	Off	Off	Stand-by	
Steady green	Blinking green	Off	Lamp stand-by (about for 1 minute)	The power button cannot be used to switch ON and OFF
Steady green	Steady green	Off	The POWER is ON. (Normal condition)	

Abnormal condition

POWER	LAMP	TEMP	CONDITION	POSSIBLE SOLUTIONS
Steady green	Steady green ↓ Off	Blinking green Steady red	Unusual temperature <ul style="list-style-type: none"> The ventilation slits or air filter is clogged with dust or debris. The fan has stopped due to an impediment. The room temperature is too high. The filter is dirty. 	<ul style="list-style-type: none"> Remove the object from the ventilation slits. Pull out the power plug and remove the object. If you cannot, consult your dealer. Relocate the projector to a cooler place. Clean the filter.
Steady green	Blinking green/red	Off	Lamp duration warning. (Lightning duration total about 1, 500 hours. When the POWER is ON.)	Replace the lamp. Exchange with a new lamp if the same problem recurs.
Steady red	Blinking red	Off	Lamp duration warning. (Lightning duration total about 1, 500 hours. When the POWER is OFF.)	
Steady red	Steady red	Off	Lamp duration warning. (Lightning duration total about 2,000 hours.)	
Blinking green/red	Off	Off	The lamp or filter cover is not closed.	Close the cover correctly.
Blinking green/red	Steady or Blinking	Steady or Blinking	Abnormal.	Contact your dealer.

Specifications

Type	LCD projector
Model	LVP-X300U
Rated power supply	AC100 ~ 240V, 50 / 60Hz
Rated input	2.9 A
LCD panels	1.3-inch LCD panel: 3 pieces (for R, G, B) Pixels 1,024 × 768 = 786,432 pixels Total 2,359,296 pixels Active pixel rate: 99.99 % or more (each panel)
Colors	16,770,000 colors
Projection lens	F 1.8~2.2 f = 52 ~ 66 mm
Light source lamp	190 W NSH
Picture size	40 ~ 300 inch (aspect ratio 4:3)
PC compatibility	Resolution : 640 x 400 - 1024 x 768 + Compressed 1280 x 1024 Sync on Green available
Video compatibility	NTSC / NTSC 4.43 / PAL (including PAL-M, N) / SECAM, PAL-60 DVD (Component) / HDTV (1080i)
Audio output	2 W stereo
Speaker	6 cm square type (8Ω 2W) × 2
S-video input	Luminance signal: 1.0 Vp-p 75Ω (negative sync.) Chroma signal: 0.286 Vp-p 75Ω (burst signal)
Video input	1.0 Vp-p 75Ω (negative sync.)
Audio inputs	350 mVrms, 10kΩ or more
Analog RGB input (mini D-SUB 15P)	RGB: 0.7Vp-p 75Ω (negative sync.) YCbCr: Y:1.0Vp-p (negative sync.) CbCr:0.7Vp-p HD/CS : TTL level (positive or negative) VD : TTL level (positive or negative)
PC audio input	350 mVrms, 10kΩ or more ø3.5mm stereo mini jack
Control connector	Serial (D-SUB 9 pin female connector) RS-232C standards PS/2 (Mouse function), USB terminal for Mouse, Wired remote terminal
Outside dimensions	299 × 127 × 367 mm (width × height × depth) Legs and lens are not included.
Weight	Approx. 6.0kg
Length of power cord	114 inch (2.9m)
Temperature, humidity (performance guarantee)	+41°F (+5°C) ~ +104°F (+40°C), 30~90%

Kensington Lock

This projector has a Kensington Security Standard connector for use with a Kensington MicroSaver Security System. Refer to the information that came with the Kensington System for instructions on how to use it to secure the projector. Please contact to Kensington Technology Group as shown below.

Kensington Technology Group
2855 Campus Drive
San Mateo, CA 94403, U.S.A.

Phone : (650)572-2700 Fax : (650)572-9675

Connectors

PC analog RGB input

Use to input video signals (analog RGB) of a personal computer.

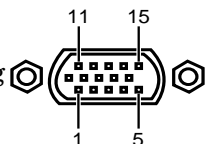

(Pin assignment of Mini D-SUB 15P jack)

PIN NO.	SPEC	PIN NO.	SPEC
1	R(RED)/C _R	9	—
2	G(GREEN)/Y	10	GROUND
3	B(BLUE)/C _B	11	GROUND
4	GROUND	12	DDC-DATA
5	GROUND	13	HD/CS
6	GROUND	14	VD
7	GROUND	15	DDC-CLK
8	GROUND		

RS-232C input

Use to control the projector with the personal computer, or control the personal computer with remote control. Please use RS-232C crossover cable provided.

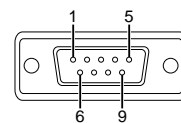

PIN NO.	NAME	I/O
1	DCD / CLOCK	IN
2	RXD	IN
3	TXD	OUT
4	N.C.	—
5	GND	—
6	DTR	IN
7	CTS / 5V	IN / OUT
8	RTS	IN
9	RI / DATA	OUT

Dimensional drawings

(mm)

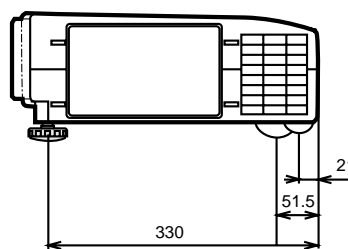
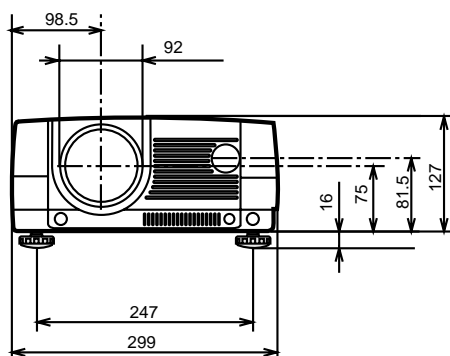
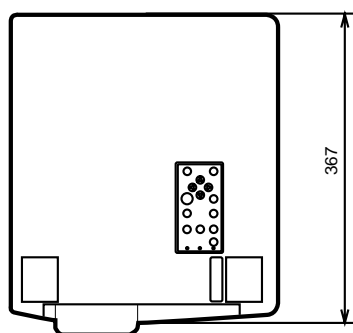

What's included in the box

2 AC power cable	246C346-10	1 USB cable	246C376-10
	246C346-20	1 Remote control	939P790-10
1 Video cable	246C323-10	1 Remote control cable	246C217-30
1 Audio cable	242C938-10	1 User's manual	871D280-20
1 RGB cable for PC	246C318-10	1 Quick reference card	857B017-10
1 RS-232C cable	246C320-20	2 Battery for remote	—
1 PS/2 adapter	246C367-10		

Replacement part

(Option / Not included in the box)

Spare mercury lamp	499B021-10 (VLT-X300LP)
--------------------	----------------------------



LCD

Projector

User Manual

X300

Control this projector by using a personal computer

This projector can be controlled by connecting a personal computer with RS-232C terminal.

Functions can be controlled by a personal computer:

- Turn the ON or OFF
- Changing input signals
- Button input by remote control or control panel
- Reading warning data
- Menu setting

Connection

Projector + IBM PC or IBM PC compatibles

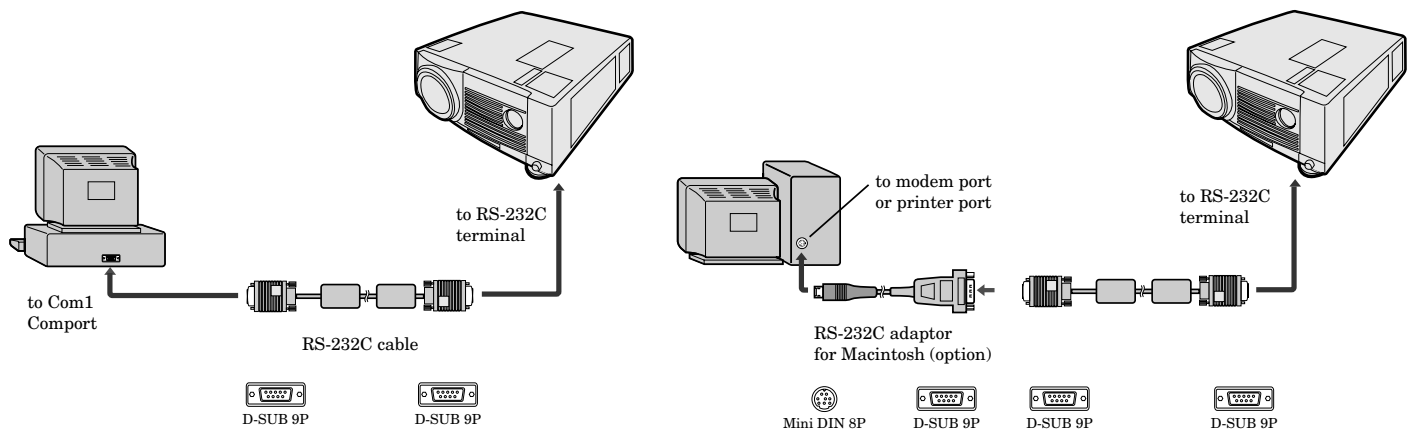

Note: If your PC (IBM or IBM compatible) is equipped only with a 25-pin serial port connector, a 25-pin serial port adapter is required. Contact your dealer for details.

1) Interface

PROTOCOL	RS-232C
BAUD RATE	9600 [bps]
DATA LENGTH	8 [bits]
PARITY BIT	NONE
STOP BIT	1 [bits]
FLOW CONTROL	NONE

This projector uses RXD, TXD and GND lines for RS-232C control.
For RS-232C cable, the reverse type cable should be used.

2) Control command diagram

The command is structured by the address code, function code, data code and end code. The length of the command is different by each function.

	Address code	Function code	Data code	End code
HEX	30h 30h	Function	Data	0Dh
ASCII	'0' '0'	Function	Data	⏏

[Address code] 30h 30h (In ASCII code, '0' '0') fixed.

[Function code] A code of each fixed control move.

[Data code] A code of each fixed control data (number) and not always indicated.

[End code] 0Dh (In ASCII code, '⏏') fixed.

3) Control sequence

- (1) The command from a personal computer to the projector will be sent in 400ms.
- (2) The projector will send a return command 400ms* after it has received an encode. If the command isn't received correctly, the projector will not send the return command.
- (3) The personal computer checks the command and confirms if the command which has been sent has been executed or not.
- (4) This projector sends various codes other than the return code. When having a control sequence by RS-232C, reject other codes from personal computer side.

- *: The sending time of return command may delay depending on the condition (during changing the input signal, etc.).

[Example] Turn the power ON (' is for ASCII code)

Sending commands from the PC etc.	Status code from projector	Meaning
30 30 21 0D '0' '0' '!' '↵'		Command for POWER ON
	30 30 21 0D '0' '0' '!' '↵'	Command received (Command echo back)

4) Operation commands

The operation commands execute the basic operation setting of this projector. It may not operate when changing the signal.

Operation	ASCII	HEX
POWER ON	!	21h
POWER OFF	"	22h
INPUT COMPUTER 1	_r1	5Fh 72h 31h
INPUT COMPUTER 2	_r2	5Fh 72h 32h
INPUT VIDEO 1	_v1	5Fh 76h 31h
INPUT VIDEO 2	_v2	5Fh 76h 32h

- POWER OFF command will not work for 1 minute after the power is turned on.
- POWER ON command will not work for 1 minute after the power is turned off.

[Example] Set the input signal to COMPUTER 1 (' is for ASCII code)

Sending commands from the PC etc.	Status code from projector	Meaning
30 30 5F 72 31 0D '0' '0' '_' 'r' '1' '↵'		Command for setting the input signal to COMPUTER 1
	30 30 5F 72 31 0D '0' '0' '_' 'r' '1' '↵'	Command received (Command echo back)

5) Remote commands

Some remote control operations can be done by remote command codes.

Button's name on remote	ASCII	HEX
+ VOLUME	r06	72h 30h 36h
- VOLUME	r07	72h 30h 37h
MUTE	ra6	72h 61h 36h
EXPAND	r02	72h 30h 32h
PinP	r04	72h 30h 34h
▲	r53	72h 35h 33h
▼	r2b	72h 32h 62h
◀	r4f	72h 34h 66h
▶	r59	72h 35h 39h
MENU	r54	72h 35h 34h
ENTER	r10	72h 31h 30h
ZOOM/FOCUS	r0f	72h 33h 66h
AUTO POSITION	r09	72h 30h 39h
STILL	ra4	72h 61h 34h

Control this projector by using a personal computer (Continued)

[Example] Display MENU selection bar. (' ' is for ASCII code)

Sending commands from the PC etc.	Status code from projector	Meaning
30 30 72 35 34 0D '0' '0' 'r' '5' '4' '↵'		Command as same as MENU button
	30 30 72 35 34 0D '0' '0' 'r' '5' '4' '↵'	Command received (Command echo back)

6) Warning commands

Read the past warning data. The personal computer doesn't attach the data code onto the warning commands to send. On the other hand, the projector which has received a command attaches the warning data as the data code to reply.

	ASCII	HEX
past data 1 (newest)	Ep1	45h 70h 31h
past data 2	Ep2	45h 70h 32h
past data 3	Ep3	45h 70h 33h
clear past data	Ec	45h 63h

The past data

Ep* (* is 7 digits, hexadecimal notation)

*=(MBS)b1,b2,b3,b4,b5,b6,b7,b8, b9, b10, b11, b12, b13, b14, b15, b16, b17, b18, b19, b20, b21, b22, b23, b24, b25, 0, 0, 0(LSB)

b1=Operation time (during boot up '0' / when the power is ON, '1')

b2=Communication error between microcomputer and IC PIO1

b3=Communication error between microcomputer and IC PIO2

b4=Communication error between microcomputer and IC PIO3

b5=Communication error between microcomputer and IC PIO4

b6=Communication error between microcomputer and IC PIO5

b7=Stand-by power short

b8=Switch power short (SC connector)

b9=Switch power short (SP connector)

b10=Switch power short (SD connector)

b11=The air inlet fan is stopped

b12=The air outlet fan is stopped

b13=The power fan is stopped

b14=The audio fan is stopped (This fan is not installed.)

b15=The lamp cover is not closed

b16=The filter cover (bottom) is not closed

b17=The filter cover (front) is not closed

b18=The temperature sensor is off (SZ connector)

b19=Communication error between microcomputer and decoder

b20=Abnormal temperature (outside)

b21=Abnormal temperature (lamp)

b22=Abnormal temperature (LCD)

b23=Abnormal temperature (The difference value of lamp from outside)

b24= The life of a lamp

b25=The lamp is not illuminating.

[Example 1] The outlet fan was down when the power was ON and the newest past data of the warning was confirmed.

Sending commands from the PC etc.	Status code from projector	Meaning
30 30 45 70 31 0D '0' '0' 'E' 'p' '1' '↵'		Command to confirm past data
	30 30 45 70 38 30 31 30 30 30 0D '0' '0' 'E' 'p' '1' '8' '0' '1' '0' '0' '0' '0' '↵' *	Warning command (Outlet fan is stopped when the power is ON) carried out

* : '8' '2' '0' '0' '0' '0' mean the numbers as shown below

Bit	b1	b2	b3	b4	b5	b6	b7	b8	b9	b10	b11	b12	b13	b14	b15	b16	b17	b18	b19	b20	b21	b22	b23	b24	b25	0	0	0
ASCII	1	0	0	0	0	0	0	0	0	0	0	1	0	0	0	0	0	0	0	0	0	0	0	0	0	0	0	0
HEX	8				0				1				0				0				0							

b1=1(The power is ON), b12=1(The outlet fan is stopped), Other= 0

7) Reading command diagram

Monitor projector operation status. The power ON, OFF and input terminal settings can be monitored.

	ASCII		HEX	
	Function	Data (Receive)	Function	Data (Receive)
POWER ON	vP	1	76h 50h	31h
POWER OFF	vP	0	76h 50h	30h
INPUT COMPUTER 1	vI	r1	76h 49h	72h 31h
INPUT COMPUTER 2	vI	r2	76h 49h	72h 32h
INPUT VIDEO 1	vI	v1	76h 49h	76h 31h
INPUT VIDEO 2	vI	v2	76h 49h	76h 32h

When a personal computer sends the command, data code will not be attached. On the other hand, the projector which has received a command will attach the recent operating status and then send.

[Example] Input was Video 1 when the operating status of the input terminal was confirmed.

Sending commands from the PC etc.	Status code from projector	Meaning
30 30 76 49 OD '0' '0' 'v' 'I' '↵'		Command to confirm input
	30 30 76 49 76 31 OD '0' '0' 'v' 'I' 'v' '1' '↵'	Command (Input is Video 1) carried out

8) Menu setting commands

The menu setting commands execute the menu setting of this projector. If the personal computer doesn't send the commands without attaching the data code, the projector which has received the command replays the setting data as data code.

ITEM	ASCII	HEX	VALUE
CONTRAST	P	50h	±30±30±30 (R from G+Main data+B from G)
BRIGHTNESS	Q	51h	±30±30±30 (R from G+Main data+B from G)
COLOR TEMP.	A	41h	1 (Standard), 2 (High), 3 (Low), 4 (User)
SHARPNESS(COMPUTER input)	R1	52h 31h	±2
SHARPNESS(VIDEO input)	R2	52h 32h	±10
TINT	S	53h	±10
COLOR	T	54h	±10
BASS	AUB	41h 55h 42h	0 - 3
TREBLE	AUT	41h 55h 54h	0 - 3
PinP AUDIO	AUP	741h 55h 50h	0 (Main), 1 (Sub)
IMAGE REVERSE	IR	49h 52h	0 (Off), 1 (Mirror), 2 (Invert), 3 (Mirror invert)
KEYSTONE	KS	4Bh 53h	±15
AUTO POWER ON	APON	41h 50h 4Fh 4Eh	0 (ON), 1 (OFF)
AUTO POWER OFF	APOF	41h 50h 4Fh 46h	00 (Off), 05, 10, 15, 20, 25, 30, 35, 40, 45, 50, 55, 60
TEST SIGNAL	TS	54h 53h	0 (ON), 1 (OFF)
MENU POSITION	MP	4Dh 50h	0 (Upper left), 1 (Lower right)
MODE DISPLAY	MD	4Dh 44h	0 (ON), 1 (OFF)
SPLASH SCREEN	SS	53h 53h	0 (ON), 1 (OFF)
CINEMA MODE	CM	43h 4Dh	0 (AUTO), 1 (OFF)
VIDEO SIGNAL	VS	56h 53h	0 (AUTO), 1 (NTSC), 2 (PAL), 3 (SECAM), 4 (4.43NTSC), 5 (PAL-M), 6 (PAL-N), 7 (PAL-60)
LANGUAGE	LG	4Ch 47h	0 (日本語), 1 (English), 2 (Español), 3 (Deutsch), 4 (Français), 5 (Italiano), 6 (中文)
HORIZ. POSITION	HP	48h 50h	+ (increase), - (decrease)
VERT. POSITION	VP	56h 50h	+ (increase), - (decrease)
FINE SYNC.	FN	46h 4Eh	00 - 31
TRACKING	TRK	54h 52h 4Bh	+ (increase), - (decrease)
COMPUTER INPUT	CIN	67h 49h 4Eh	0 (RGB), 1 (YCbCr), 2 (YPbPr)
HOLD BEGIN	HLB	48h 4Ch 42h	00 - 15
HOLD END	HLE	48h 4Ch 45h	00 - 15
CLAMP POSITION	CLP	43h 4Ch 50h	000 - 255
CLAMP WIDTH	CLW	43h 4Ch 57h	000 - 255
ANAMORPHIC	SC	53h 43h	0 (ON), 1 (OFF)

Control this projector by using a personal computer (Continued)

How to set the grade

Use ASCII letters code to set the grade for setting data. Please refer to the table below for HEX code.

ASCII	'+'	'-'	'0'	'1'	'2'	'3'	'4'	'5'	'6'	'7'	'8'	'9'
HEX	2Bh	2Dh	30h	31h	32h	33h	34h	35h	36h	37h	38h	39h

[Example 1] Set the AUTO POWER ON to OFF.

Sending commands from the PC etc.	Status code from projector	Meaning
30 30 41 50 4F 4E 30 0D '0' '0' 'A' 'P' 'O' 'N' '0' '↵'		Command for setting the AUTO POWER ON to ON
	30 30 41 50 4F 4E 30 0D '0' '0' 'A' 'P' 'O' 'N' '0' '↵'	Command received (Command echo back)

The data code of CONTRAST and BRIGHTNESS is structured by the difference data of R from G, the main data and the difference data of B from G.

[Example 2] Set the difference data of R from G to +10, the setting main data to 0 and the difference data of B from to -5.

Sending commands from the PC etc.	Status code from projector	Meaning
30 30 50 2B 31 30 2B 30 30 2D 30 35 0D '0' '0' 'P' '+' '1' '0' '+' '0' '0' '-' '0' '5' '↵'		Command for setting the picture control
	30 30 50 2B 31 30 2B 30 30 2D 30 35 0D '0' '0' 'P' '+' '1' '0' '+' '0' '0' '-' '0' '5' '↵'	Command received (Command echo back)

[Example 3] The TINT was set to +10 when the setting status was confirmed.

Sending commands from the PC etc.	Status code from projector	Meaning
30 30 53 0D '0' '0' 'S' '↵'		Command to confirm setting of TINT
	30 30 53 2B 31 30 0D '0' '0' 'S' '+' '1' '0' '↵'	Command (setting of TINT is +10) carried out

