

***myprojectorlamps.com***

**The most trusted, dependable name  
in projector lamp sales.**



<http://www.myprojectorlamps.com>



<http://www.myprojectorlamps.ca>



<http://www.myprojectorlamps.eu>

The following projector manual has not been modified or altered in any way.

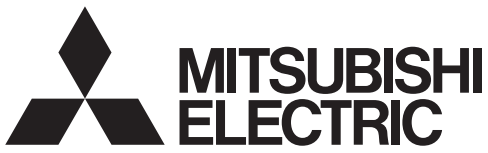

DLPT™ PROJECTOR

MODEL

**HC910**

User Manual

*HC910*

This User Manual is important to you.  
Please read it before using your projector.

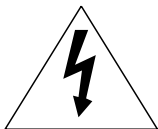
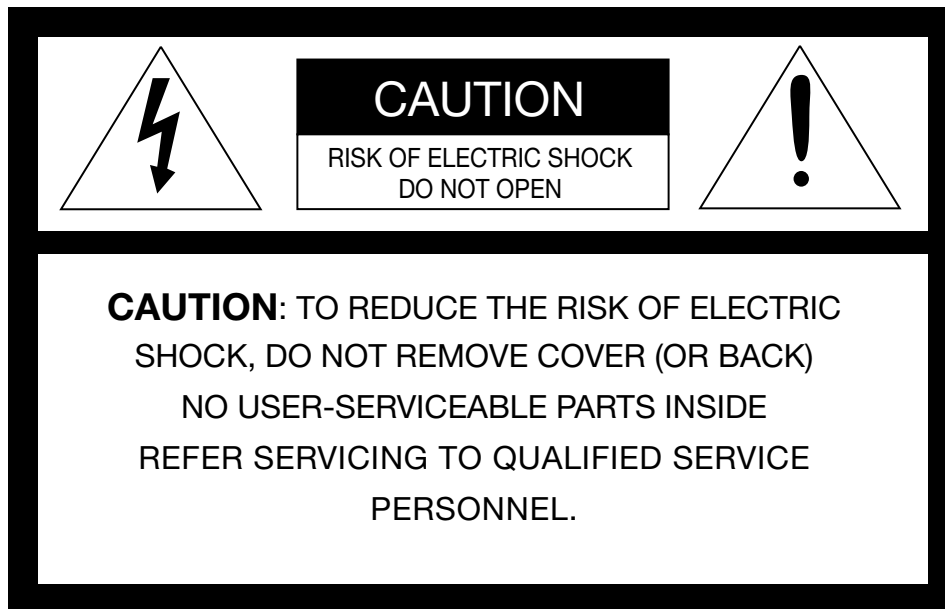

The lightning flash with arrowhead symbol within an equilateral triangle is intended to alert the user to the presence of uninsulated “dangerous voltage” within the product’s enclosure that may be of sufficient magnitude to constitute a risk of electric shock.



The exclamation point within an equilateral triangle is intended to alert the user to the presence of important operating and maintenance (servicing) instructions in the literature accompanying the appliance.

**WARNING:**

TO PREVENT FIRE OR SHOCK HAZARD, DO NOT EXPOSE THIS APPLIANCE TO RAIN OR MOISTURE.

**CAUTION:**

TO PREVENT ELECTRIC SHOCK, DO NOT USE THIS (POLARIZED) PLUG WITH AN EXTENSION CORD, RECEPTACLE OR OTHER OUTLET UNLESS THE BLADES CAN BE FULLY INSERTED TO PREVENT BLADE EXPOSURE.

**NOTE:**

SINCE THIS PROJECTOR IS PLUGGABLE EQUIPMENT, THE SOCKET-OUTLET SHALL BE INSTALLED NEAR THE EQUIPMENT AND SHALL BE EASILY ACCESSIBLE.

**WARNING**

Use the attached specified power supply cord. If you use another power-supply cord, it may cause interference with radio and television reception.

Use the attached RS-232C cable and RGB cable with this equipment so as to keep interference within the limit of a FCC Class B device.

This apparatus must be grounded.

**DO NOT LOOK DIRECTLY INTO THE LENS WHEN THE PROJECTOR IS IN THE POWER ON MODE.**

**CAUTION**

Not for use in a computer room as defined in the Standard for the Protection of Electronic Computer/ Data Processing Equipment, ANSI/NFPA 75.

**When using the projector in Europe:**

**COMPLIANCE NOTICE**

This Projector complies with the requirements of the EC Directive 89/336/EEC “EMC Directive” as amended by Directive 92/31/EEC and 93/68/EEC, and 73/23/EEC “Low Voltage Directive” as amended by Directive 93/68/EEC.

The electro-magnetic susceptibility has been chosen at a level that gains proper operation in residential areas, on business and light industrial premises and on small-scale enterprises, inside as well as outside of the buildings. All places of operation are characterised by their connection to the public low voltage power supply system.

**WARNING**

Use the attached RS-232C cable and RGB cable with this equipment so as to keep interference within the limits of an EN55022 Class B device. Please follow WARNING instructions.

# Contents

Important safeguards .....	4
Preparing your projector.....	6
Using the remote control.....	9
Setting up your projector.....	10
Viewing video images.....	12
Viewing computer images .....	18
Menu operation .....	21
Adjusting projected images.....	24
Advanced features .....	27
Asking for installation .....	28
Using filter .....	29
Replacing the lamp .....	30
Troubleshooting.....	32
Indicators.....	35
Specifications.....	36



Note: This symbol mark is for EU countries only.  
 This symbol mark is according to the directive 2002/96/EC Article 10  
 Information for users and Annex IV.

Your MITSUBISHI ELECTRIC product is designed and manufactured with high quality materials and components which can be recycled and reused.

This symbol means that electrical and electronic equipment, at their end-of-life, should be disposed of separately from your household waste.

Please, dispose of this equipment at your local community waste collection/recycling centre.

In the European Union there are separate collection systems for used electrical and electronic product.

Please, help us to conserve the environment we live in!

## Declaration of Conformity

Model number : HC910  
 Trade name : MITSUBISHI ELECTRIC  
 Responsible party : Mitsubishi Digital Electronics America, Inc.  
 9351 Jeronimo Road, Irvine, CA 92618 U.S.A  
 Telephone number : +1-(949) 465-6000

This device complies with Part 15 of the FCC Rules. Operation is subject to the following two conditions:  
 (1) this device may not cause harmful interference, and  
 (2) this device must accept any interference received, including interference that may cause undesired operation.

## Trademark, Registered trademark

Macintosh is registered trademark of Apple Computer Inc.

DLP™, Digital Micromirror Device and DMD are all trademarks of Texas Instruments.

Other brand or product names are trademarks or registered trademarks of their respective holders.

# Important safeguards

Please read all these instructions regarding your projector and retain them for future reference. Follow all warnings and instructions marked on the projector.

1. Read instructions  
All the safety and operating instructions should be read before the appliance is operated.
2. Retain instructions  
The safety and operating instructions should be retained for future reference.
3. Warnings  
All warnings on the appliance and in the operating instructions should be adhered to.
4. Instructions  
All operating instructions must be followed.
5. Cleaning  
Unplug this projector from the wall outlet before cleaning it. Do not use liquid aerosol cleaners. Use a damp soft cloth for cleaning.
6. Attachments and equipment  
Never add any attachments and/or equipment without the approval of the manufacturer as such additions may result in the risk of fire, electric shock or other personal injury.
7. Water and moisture  
Do not use this projector near water or in contact with water.
8. Accessories  
Do not place this projector on an unstable cart, stand, tripod, bracket or table. Use only with a cart, stand, tripod bracket, or table recommended by the manufacturer or sold with the projector. Any mounting of the appliance should follow the manufacturer's instructions and should use a mounting accessory recommended by the manufacturer.



An appliance and cart combination should be moved with care. Quick stops, excessive force and uneven surfaces may cause the appliance and cart combination to overturn.

9. Ventilation  
Slots and openings in the cabinet are provided for ventilation, ensuring reliable operation of the projector and to protect it from overheating. Do not block these openings or allow them to be blocked by placing the projector on a bed, sofa, rug, or bookcase. Ensure that there is adequate ventilation and that the manufacturer's instructions have been adhered to.

10. Power sources  
This projector should be operated only from the type of power source indicated on the marking label. If you are not sure of the type of power, please consult your appliance dealer or local power company.
11. Power-cord protection  
Power-supply cords should be routed so that they are not likely to be walked on or pinched by items placed upon or against them. Pay particular attention to cords at plugs, convenience receptacles, and points where they exit from the appliance. Do not put the power cord under a carpet.
12. Overloading  
Do not overload wall outlets and extension cords as this can result in a fire or electric shock.
13. Objects and liquids  
Never push objects of any kind through openings of this projector as they may touch dangerous voltage points or short-out parts that could result in a fire or electric shock. Never spill liquid of any kind on the projector.
14. Servicing  
Do not attempt to service this projector by yourself. Refer all servicing to qualified service personnel.
15. Damage requiring service  
Unplug this projector from the wall outlet and refer servicing to qualified service personnel under the following conditions:
  - (a) If the power-supply cord or plug is damaged.
  - (b) If liquid has been spilled, or objects have fallen into the projector.
  - (c) If the projector does not operate normally after you follow the operating instructions. Adjust only those controls that are covered by the operating instructions. An improper adjustment of other controls may result in damage and may often require extensive work by a qualified technician to restore the projector to its normal operation.
  - (d) If the projector has been exposed to rain or water.
  - (e) If the projector has been dropped or the cabinet has been damaged.
  - (f) If the projector exhibits a distinct change in performance - this indicates a need for service.
16. Replacement parts  
When replacement parts are required, be sure that the service technician has used replacement parts specified by the manufacturer or parts having the same characteristics as the original part. Unauthorized substitutions may result in fire, electric shock or other hazards.
17. Safety check  
Upon completion of any service or repair to this projector, ask the service technician to perform safety checks determining that the projector is in a safe operating condition.

**WARNING:****Unplug immediately if there is something wrong with your projector.**

Do not operate if smoke, strange noise or odor comes out of your projector. It might cause fire or electric shock. In this case, unplug immediately and contact your dealer.

**Never remove the cabinet.**

This projector contains high voltage circuitry. An inadvertent contact may result in an electric shock. Except as specifically explained in the User Manual do not attempt to service this product by yourself. Please contact your dealer when you want to fix, adjust or inspect the projector.

**Do not modify this equipment.**

It can lead to fire or electric shock.

**If you break or drop the cabinet.**

Do not keep using this equipment if you break or drop it. Unplug the projector and contact your dealer for inspection. It may lead to fire if you keep using the equipment.

**Do not face the projector lens to the sun.**

It can lead to fire.

**Use correct voltage.**

If you use incorrect voltage, it can lead to fire.

**Do not place the projector on uneven surface.**

Place the projection on a leveled and stable surface only. Please do not place equipment on unstable surfaces.

**Do not look into the lens when it is operating. It may hurt your eyes.**

Never let children look into the lens when it is on.

**Do not turn off the main power abruptly or unplug the projector during operation.**

It can lead to lamp breakage, fire, electric shock or other trouble. It is best to wait for the fan to turn off before turning the main power off.

**Do not touch the air outlet grille and bottom plate, which become hot.**

Do not touch them or put other equipment in front of the air outlet grille. The air outlet grille and bottom plate, when heated, may cause injury or damage to other equipment. Also, do not set the projector on the desk which is easily affected by heat.

**Do not look into the air outlet grille when projector is operating.**

Heat, dust, etc. may blow out of it and hurt your eyes.

**Do not block the air inlet and outlet grilles.**

If they are blocked, heat may be generated inside the projector, causing deterioration in the projector quality and fire.

**Place of installation**

For safety's sake, refrain from setting the projector at any place subjected to high temperature and high humidity. Please maintain an operating temperature, humidity, and altitude as specified below.

- Operating temperature: between +41°F (+5°C) and +95°F (+35°C)
- Operating humidity: between 30% and 90%
- Never put any heat-producing device under the projector so that the projector does not overheat.
- Do not attach the projector to a place that is unstable or subjected to vibration.
- Do not install the projector near any equipment that produces a strong magnetic field. Also refrain from installing near the projector any cable carrying a large current.
- Place the projector on a solid, vibration free surface; otherwise it may fall, causing serious injury to a child or adult, and serious damage to the product.
- Do not stand the projector; it may fall, causing serious injury and damage to the projector.
- Slanting the projector more than  $\pm 10^\circ$  (right and left) or  $\pm 15^\circ$  (front and rear) may cause trouble or explosion of the lamp.
- Do not place the projector near air-conditioning unit or heater to avoid hot air to the exhaust and ventilation hole of the projector.

**COMPLIANCE NOTICE OF FCC**

This equipment has been tested and found to comply with the limits for a Class B digital device, pursuant to Part 15 of the FCC Rules. These limits are designed to provide reasonable protection against harmful interference in a residential installation. This equipment generates, uses and can radiate radio frequency energy and, if not installed and used in accordance with the instructions, may cause harmful interference to radio communications. However, there is no guarantee that interference will not occur in a particular installation. If this equipment does cause harmful interference to radio or television reception, which can be determined by turning the equipment off and on, the user is encouraged to try to correct the interference by one or more of the following measures:

- Reorient or relocate the receiving antenna.
- Increase the separation between the equipment and receiver.
- Connect the equipment into an outlet on a circuit different from that to which the receiver is connected.
- Consult the dealer or an experienced Radio / TV technician for help.

Changes or modifications not expressly approved by Mitsubishi could void the user's authority to operate this equipment.







**COMPLIANCE NOTICE OF INDUSTRY CANADA**

This Class B digital apparatus complies with Canadian ICES-003.

# Preparing your projector

## Checking accessories

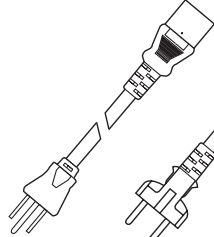
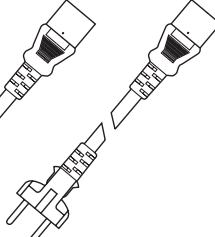
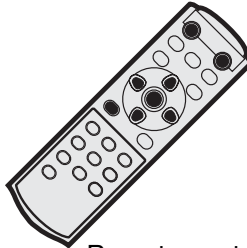
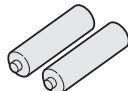
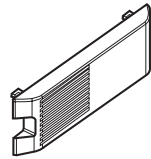
The following accessories are provided with this projector. Check to be sure that all of the accessories are packed in the package.

<p>■ <b>Cables</b></p>  <p>Mini D-SUB 15-pin</p>  <p>Mini D-SUB 15-pin</p> <p>RGB cable for PC (246C521-10)</p>	 <p>D-SUB 9-pin</p>  <p>8-pin</p> <p>RS-232C cable (246C508-10)</p> <ul style="list-style-type: none"><li>• Used for projector control by computer.</li></ul>	<p>■ <b>Power supply parts</b></p>   <p>Power cord (two) (246C483-10, 246C383-20)</p>
<p>■ <b>Remote control parts</b></p>  <p>Remote control (290P133-10)</p>  <p>R03 (Size-AAA) battery (two)</p>	<p>■ <b>Filter parts</b></p>  <p>Filter cover (Filter) (761B421-20)</p>  <p>Cap (761C765-10)</p>	<p>■ <b>Others</b></p> <ul style="list-style-type: none"><li>• Lens cap (Attached to the projector)</li><li>• User manual (English only) (871D420-70)</li><li>• CD-ROM (with User manual) (919C137-30)</li><li>• Safety manual (871D421-30)</li><li>• Quick Start up (857D064-70)</li></ul>

### Important:

- The attached power cords are to be used exclusively for this product. Never use them for other products.

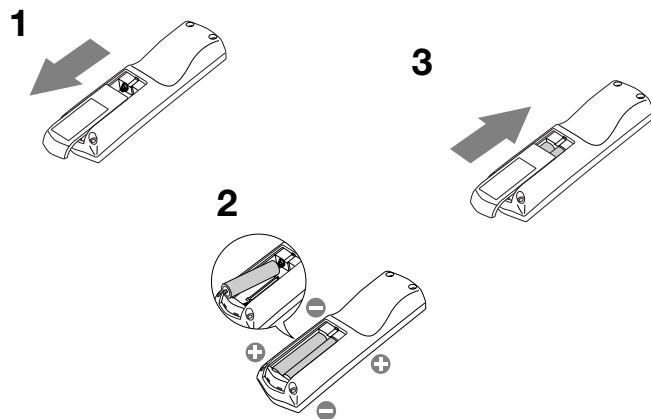

### Inserting the batteries into the remote control

1. Remove the rear lid of the remote control.
2. Check the polarity (+), (-) of the batteries, and set them correctly, inserting their (-) side first.
  - If the battery is inserted from the (+) side first, inserting the (-) side is difficult because the coil spring end hits on the battery side. If the battery is forced to insert in this way, the outer label of the battery may get ripped and it may cause a short-circuit and heating.
3. Attach the rear lid.

### Important:

- Use two size-AAA batteries (R03).
- Replace the two batteries with new ones when the remote control is slow to operate.

### CAUTION:

- Use of a battery of wrong type may cause explosion.
- Only Carbon-Zinc or Alkaline-Manganese Dioxide type batteries should be used.
- Dispose of used batteries according to your local regulations.
- Batteries may explode if misused. Do not recharge, disassemble, or dispose of them in fire.
- Be sure to handle the batteries according to the instructions.
- Load the batteries with its positive (+) and negative (-) sides correctly oriented as indicated on the remote control.
- Keep batteries out of reach of children and pets.
- Remove the batteries, if the remote control is not used for a long time.
- Do not combine a new battery with an old one.
- If the solution of batteries comes in contact with your skin or clothes, rinse with water. If the solution comes in contact with your eyes, rinse them with water and then consult your doctor.

## Overview

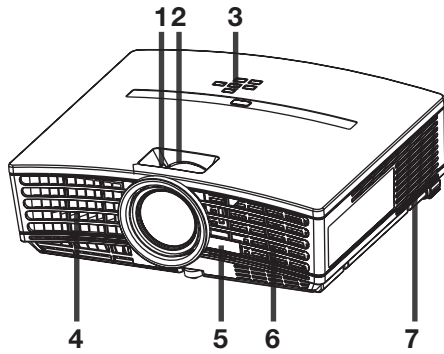

- 1 FOCUS ring
- 2 ZOOM ring
- 3 Control panel
- 4 Air outlet grille
- 5 Remote control sensor (Front)
- 6 Air inlet grille
- 7 Air outlet grille

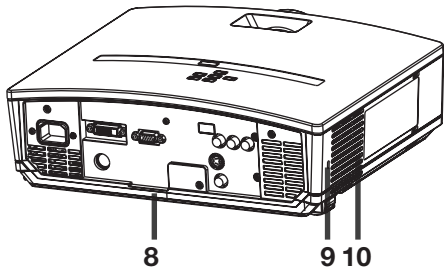

## Control area

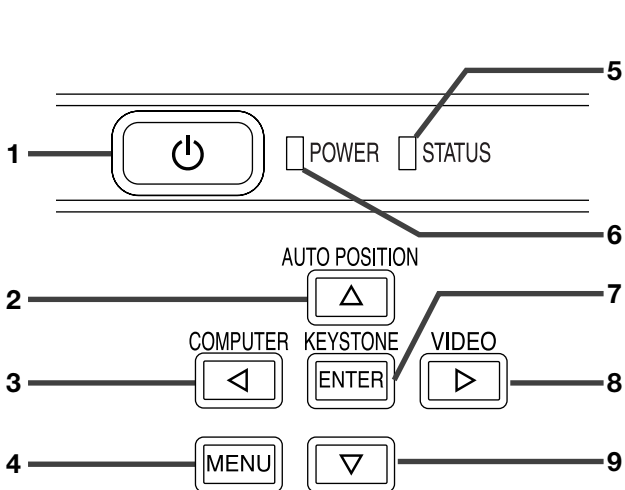

- 1 POWER button
- 2 AUTO POSITION / ▲ button
- 3 COMPUTER / ◀ button
- 4 MENU button
- 5 STATUS indicator
- 6 POWER indicator
- 7 KEYSTONE/ENTER button
- 8 VIDEO/ ▶ button
- 9 ▼ button

### Important:

- While the menu is on the screen for the keystone adjustment or password entry is being displayed, the COMPUTER, VIDEO, and AUTO POSITION buttons function as the ◀, ▶, and ▲ buttons respectively.
- While the menu is on the screen, the KEYSTONE button functions as the ENTER button.

## Terminal panel

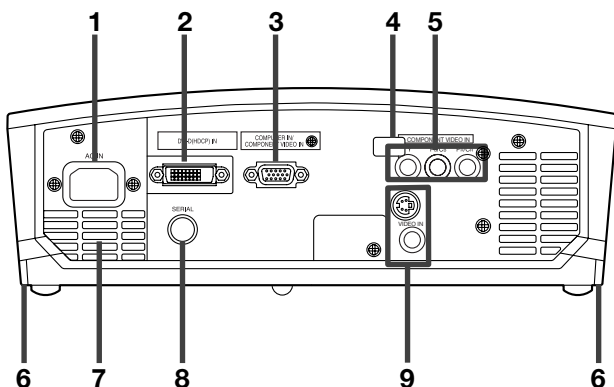

- 1 Power jack
- 2 DVI-D (HDCP) IN terminal (DVI-D 24-pin)
- 3 COMPUTER IN/ COMPONENT VIDEO IN terminal (Mini D-SUB 15-pin)
- 4 Remote control sensor (Rear)
- 5 COMPONENT VIDEO IN terminals
- 6 Foot adjustment buttons (Left/Right)
- 7 Air outlet grille
- 8 SERIAL terminal (8-pin)
  - Used for projector control by computer. Contact your dealer for details.
- 9 VIDEO IN / S-VIDEO IN terminals



## Preparing your projector (Continue)

### Bottom side

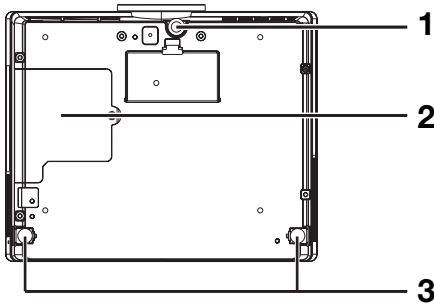

- 1 Adjustment foot (Front)
- 2 Lamp cover
- 3 Adjustment feet (Rear)

#### Caution:

Do not replace the lamp immediately after using the projector because the lamp would be extremely hot and it may cause burns.

### Remote control

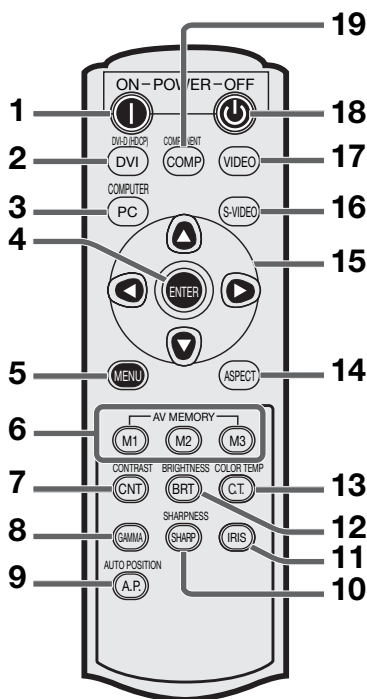

- 1 ON ( | ) button
- 2 DVI-D(HDCP) button
- 3 COMPUTER button
- 4 ENTER button
- 5 MENU button
- 6 AV MEMORY buttons
- 7 CONTRAST button\*
- 8 GAMMA button\*
- 9 AUTO POSITION button
- 10 SHARPNESS button\*
- 11 IRIS button
- 12 BRIGHTNESS button\*
- 13 COLOR TEMP button\*
- 14 ASPECT button
- 15 Direction buttons
- 16 S-VIDEO button
- 17 VIDEO button
- 18 OFF ( ) button
- 19 COMPONENT button

\* : See below for the picture quality adjusting buttons.

#### Important:

When you press any button on the remote control, the buttons on the remote control are lit. Wait approx. 5 seconds after releasing the button to turn them off.

### Using the picture quality adjusting buttons

When you press any of the picture quality adjusting buttons, the screen for adjusting the picture quality appears. Adjust the picture quality by pressing the ► and ◀ buttons. The picture quality adjustment can be made alternatively in the IMAGE menu. (See Page 22.) Items in the menus are shown in parentheses below.

- CONTRAST (CONTRAST) ..... Adjust the contrast of the projected image.  
 GAMMA (GAMMA MODE) ..... Selects one of the preset gamma mode.  
 SHARPNESS (SHARPNESS) ..... Adjust the sharpness of the projected image.  
 BRIGHTNESS (BRIGHTNESS) ..... Adjust the brightness of the projected image.  
 COLOR TEMP (COLOR TEMP.) ..... Selects one of the preset color temperatures (HIGH BRIGHTNESS/9300K/6500K/5900K/USER). Color adjustment of USER mode is also available. Select "USER" and press the ENTER button for color adjustment of USER mode. Use the ▲ or ▼ button to select an item and ► or ◀ button to adjust the selected item. (Refer to page 25.)

# Using the remote control

## Operational range of the remote control

Front of projector

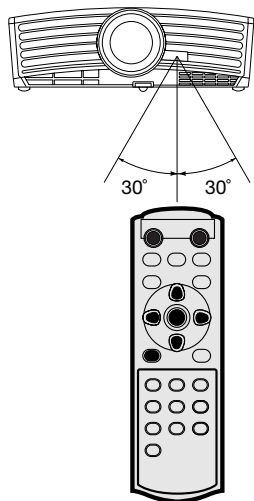

Rear of projector

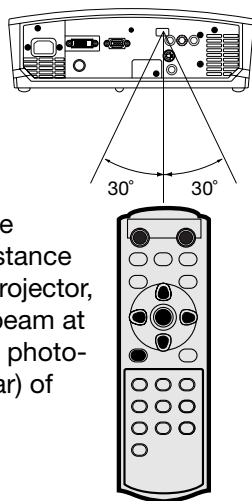

Operate the remote control within a distance of 10 m from the projector, pointing the light beam at the remote control photo-sensor (front or rear) of the projector.

- Keep the remote control photo-sensor out of direct sunlight or fluorescent lamp light.
- Keep the remote control photo-sensor at least 2 m away from fluorescent lamps. Otherwise, the remote control may malfunction.
- If there is an inverter-operated fluorescent lamp near the remote control, the remote control operation may become unstable.

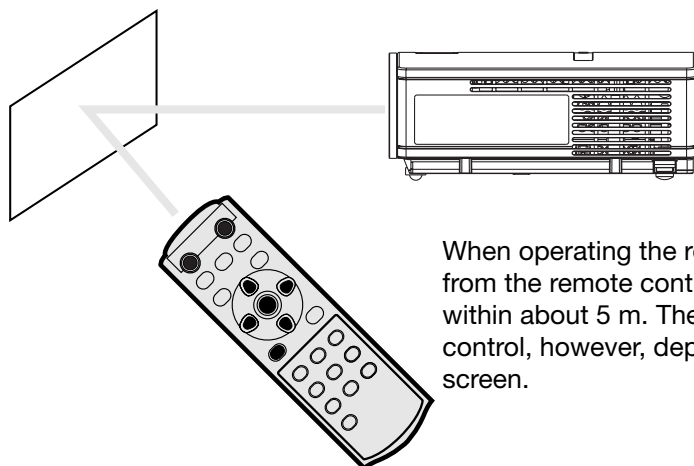

When operating the remote control, keep the distance from the remote control to the projector via the screen within about 5 m. The operable range of the remote control, however, depends on the characteristics of the screen.

## Reception angle

### Vertical directions

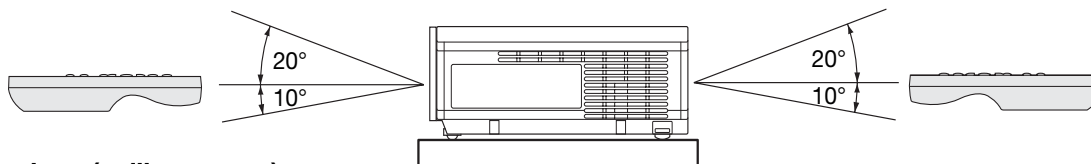

### Vertical directions (ceiling mount)

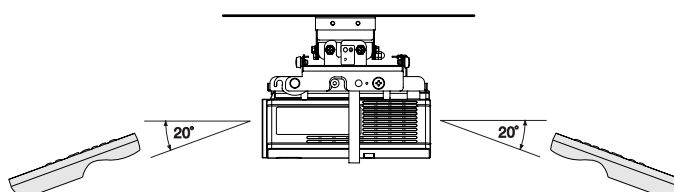

# Setting up your projector

## Setting up the screen

Install the screen perpendicularly to the projector. If the screen can not be installed in such a way, adjust the projection angle of the projector. (See below.)

- Install the screen and projector so that the projector's lens is placed at the same height and horizontal position of the screen center.
- Do not install the screen where it is exposed to direct sunlight or lighting. Light directly reflecting on the screen makes the projected images whitish and hard to view.

## Basic setup

Determine the distance from the screen to the projector according to the size of the images to be projected. (See Page 11.)

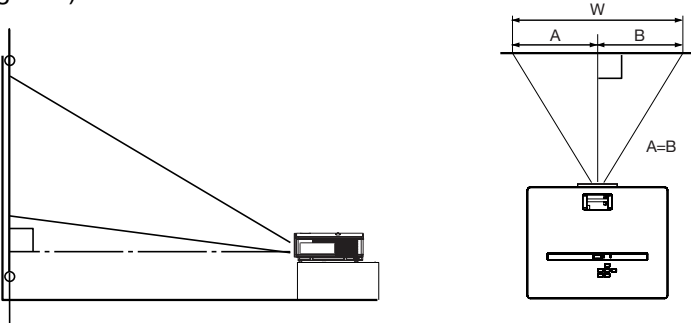

- Do not place this projector on a carpet or blanket because the exhaust vent and the intake vent on the bottom surface are blocked and the inside of the projector is heated, causing a breakdown or fire.
- Depending on the installation conditions, warm air that is emitted from the exhaust vents may flow into the intake vent, causing the projector to display "TEMPERATURE!!" and then stop projecting images.

## Adjusting the projection angle

This projector is provided with three feet for adjusting the projection angle on the bottom surface. Adjust the projection angle depending on the position of the projector.

### Adjustment of the projection angle

For the best projection, project images on a flat screen installed at 90 degrees to the floor. If necessary, tilt the projector using the two adjustment feet on the bottom of the projector.

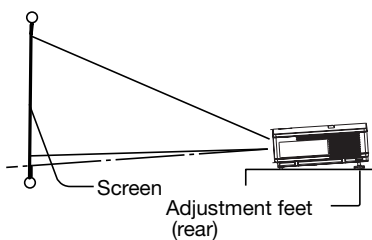

1. Tilt up the projector to the appropriate angle.
2. Press the foot adjustment buttons next to the adjustment feet (rear), and the adjustment feet will come out.
3. Release the buttons to lock the adjustment feet (rear) to that position.
4. Rotate the adjustment feet (rear) for fine adjustment.

### After using the projector:

5. Put the adjustment feet (rear) back into the projector by pressing the foot adjustment buttons.
- If necessary, rotate the adjustment feet (front) for fine adjustment.

## When projected images are distorted to a trapezoid:

When the screen and the projector are not placed perpendicularly to each other, projected images become trapezoidal. If you cannot make the projector and the screen perpendicular to each other by mechanical adjustments, adjust keystone. (See Page 16.)

- When the keystone adjustment is applied, the correct aspect ratio may not be obtained.
- When the keystone adjustment is applied, the resolution lowers. In addition, vertical stripes appear and straight lines bend in images with complicated patterns. To prevent such symptoms, keep the screen and the projector perpendicular to each other as much as possible.
- Though the projected image may be distorted momentarily when you change the setting value of the keystone adjustment, such symptom is not a malfunction.
- Though the projected image may be distorted depending on the setting value of the keystone adjustment and the type of the input signal, such symptom is not a malfunction. In such a case, adjust the setting value within the range where the projected image is not distorted.
- The setting value displayed at the time of the keystone adjustment may vary depending on the type of the input signal.
- The keystone mode does not function when the REAL mode is applied.

## Screen size and projection distance

Refer to the following table to determine the screen size.

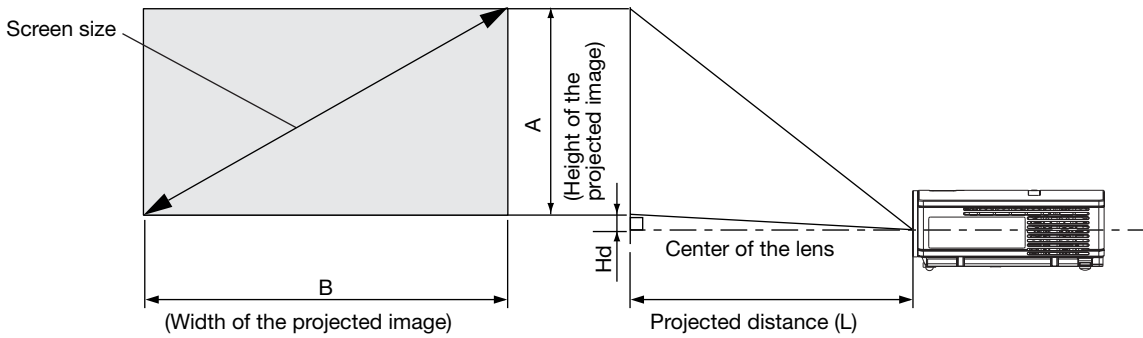

When the aspect ratio of the screen is 4:3, the positional relation between the projected image and the screen is as shown on the right. Refer to the following table for installation.

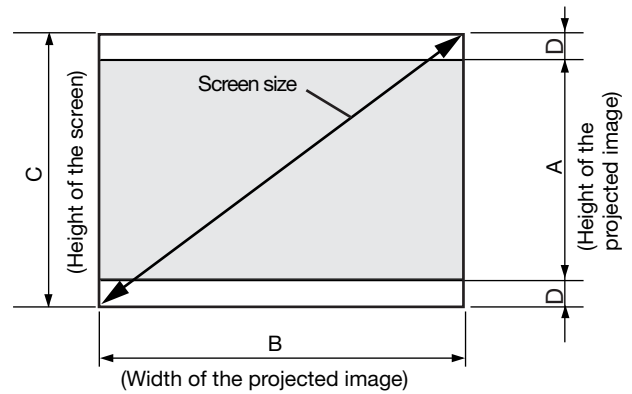

### When the aspect ratio of the screen is 16:9

Screen size						Projected distance (L)				Hd	
16:9 Diagonal		Height A		Width B		Min.		Max.			
inch	cm	inch	cm	inch	cm	inch	m	inch	m	inch	cm
40	102	20	50	35	89	55	1.4	67	1.7	6.4	16.2
60	152	29	75	52	133	84	2.1	102	2.6	9.6	24.3
80	203	39	100	70	177	113	2.9	137	3.5	12.7	32.4
100	254	49	125	87	221	142	3.6	171	4.4	15.9	40.5
150	381	74	187	131	332	213	5.4	258	6.6	23.9	60.7
200	508	98	249	174	443	285	7.2	345	8.8	31.9	80.9
250	635	123	311	218	553	357	9.1	-	-	39.8	101.1
275	699	135	342	240	609	393	10.0	-	-	43.8	111.3

- The above figures are approximate and may be slightly different from the actual measurements.

### When the aspect ratio of the screen is 4:3

Screen size						Size of the projected image				Blank space (D)		Projected distance (L)				Hd	
4:3 Diagonal		Height C		Width B		Height A		Width B				Min.		Max.			
inch	cm	inch	cm	inch	cm	inch	cm	inch	cm	inch	cm	inch	m	inch	m	inch	cm
40	102	24	61	32	81	18	46	32	81	3.0	8	51	1.3	62	1.6	5.8	14.9
60	152	36	91	48	122	27	69	48	122	4.5	11	77	2.0	94	2.4	8.8	22.3
80	203	48	122	64	163	36	91	64	163	6.0	15	103	2.6	125	3.2	11.7	29.7
100	254	60	152	80	203	45	114	80	203	7.5	19	130	3.3	157	4.0	14.6	37.1
150	381	90	229	120	305	67.5	171	120	305	11.3	29	196	5.0	237	6.0	21.9	55.7
200	508	120	305	160	406	90	229	160	406	15.0	38	262	6.6	316	8.0	29.2	74.3
250	635	150	381	200	508	112.5	286	200	508	18.8	48	327	8.3	-	-	36.6	92.8
300	762	180	457	240	610	135	343	240	610	22.5	57	393	10.0	-	-	43.9	111.4

- The above figures are approximate and may be slightly different from the actual measurements.

# Viewing video images

## A. Connecting the projector to video equipment

### Preparation:

- Make sure that the power of the projector and that of the video equipment are turned off.

### Basic home theater system connection

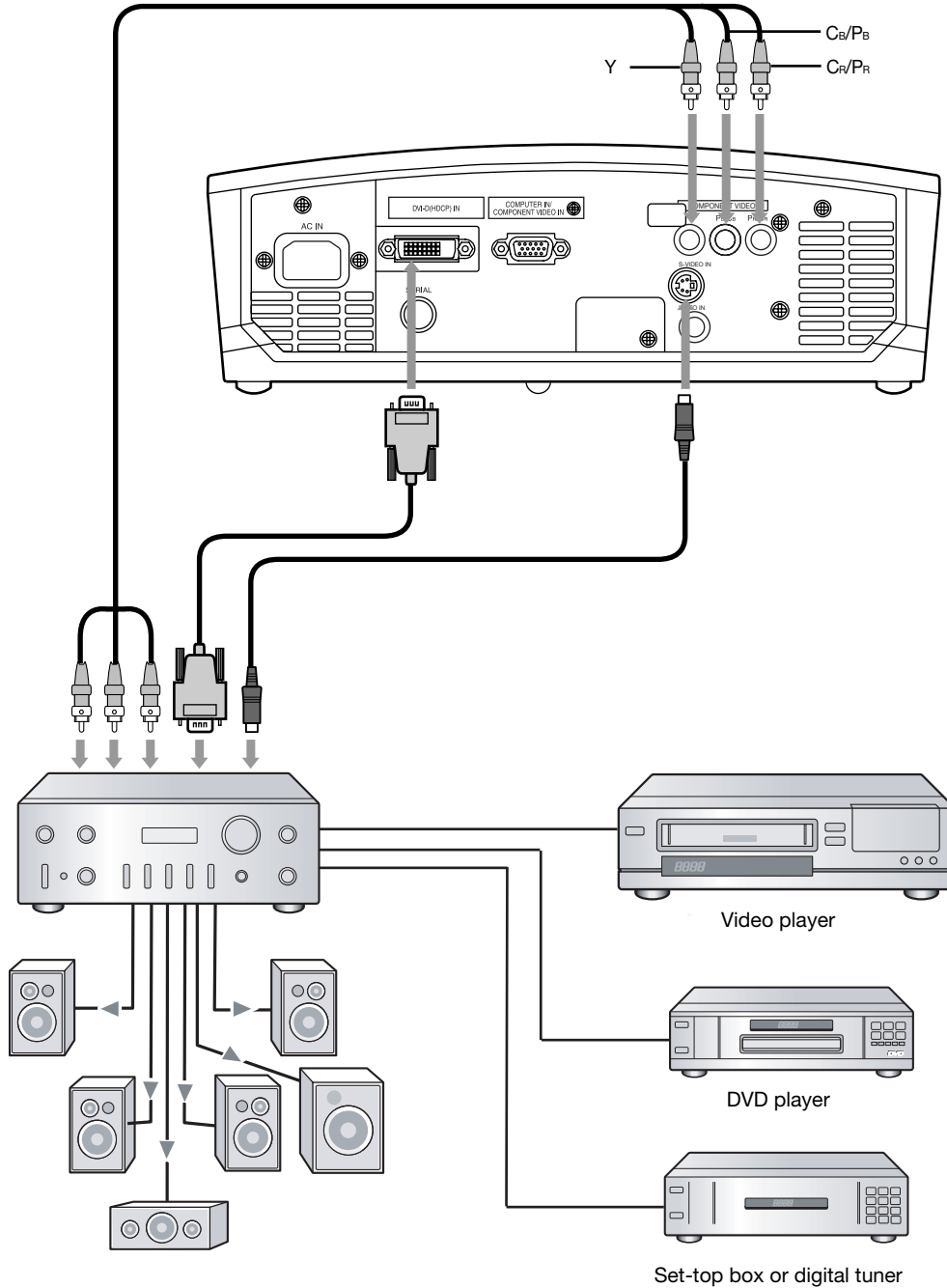

## Connecting to a video player, etc.

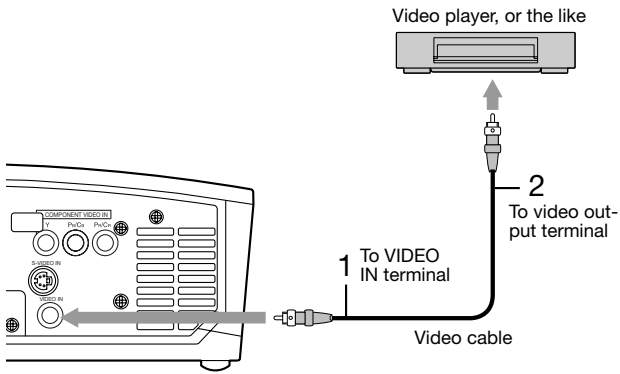

1. Connect one end of the optional video cable to the VIDEO IN terminal of the projector.
2. Connect the other end of the video cable to the video output terminal of the video equipment.

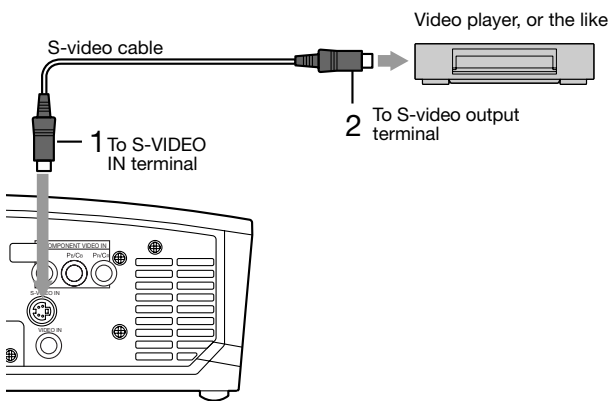

**When the video equipment is equipped with the S-video output terminal, make the connection as follows.**

1. Connect one end of the optional S-video cable to the S-VIDEO IN terminal of the projector.
2. Connect the other end of the S-video cable to the S-video output terminal of the video equipment.

- Also read the instruction manual of the equipment to be connected.
- Contact your dealer for details of connection.

### When a TV tuner or VCR is connected:

When you use this projector with a TV tuner or VCR connected, no image may appear or a message of NO SIGNAL may appear on the screen when you change the channel via any channel that is not being received. In such a case, set the channels of the TV tuner or VCR again. To avoid such symptom, use the TV tuner or VCR with its channel skip function (that is a function not to display channels that are not being received) enabled.

## Connecting to a DVD player

To connect this projector to video equipment that has component video output terminals, such as a DVD player, use the COMPONENT terminals.

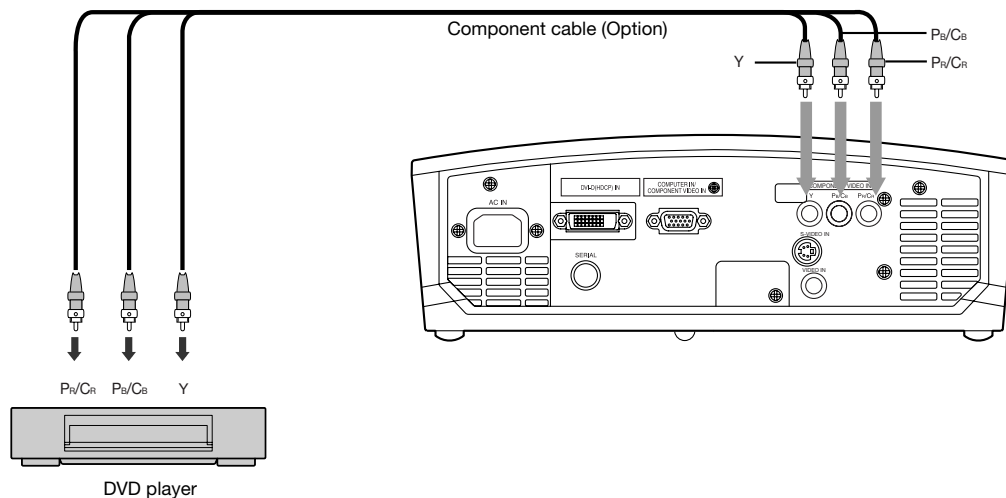

- Images may not be projected correctly depending on the type of the DVD player you use.
- Though it may take some time before an image is displayed on the screen depending on the type of the input signal, such symptom is not a malfunction.

## Viewing video images (continued)

### Connecting to video equipment having a DVI-D terminal

You can project high-quality images by connecting the DVI-D terminal of this projector to video equipment having a DVI-D output terminal. In addition, this projector supports HDCP and is able to receive encrypted digital video data that are output from DVD players.

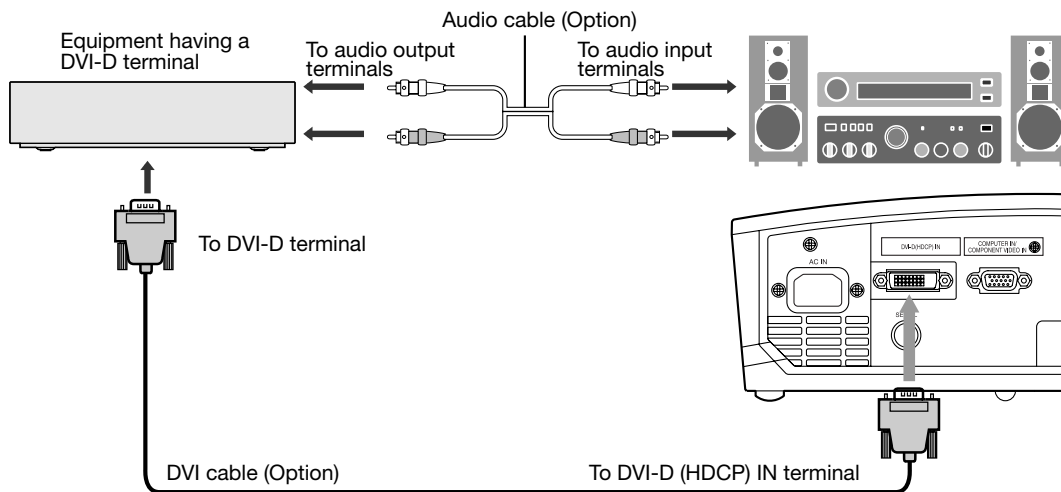

- For connection to the DVI-D IN terminal, use a commercially available DVI cable.
- Select DVI as the input source.
- Only RGB signals are supported. Component video signals are not supported.
- HDCP (High-bandwidth Digital Content Protection), developed by Intel Corporation, is a method to encrypt digital video data for the purpose of copy protection.
- When DVI is selected as the input source, setting of COLOR, TINT, FINE SYNC., TRACKING and HOLD is unavailable.

### When you connect this projector and a DVI-Digital device (such as a DVD player) via the DVI-D (HDCP) terminal, black color may appear dark and deep, depending on the type of the connected device.

- This depends on the black level setting of the connected device. There are two kinds of methods to digitally transfer image data, in which different black level settings are employed respectively. Therefore, the specifications of the signals output from DVD players differ, depending on the type of the digital data transfer method they use.
- Some DVD players are provided with a function to switch the methods to output DVI-Digital signals. When your DVD player is provided with such function, set it as follows.

EXPAND or ENHANCED → NORMAL

- See the users guide of your DVD player for details.
- When your digital device does not have such function, adjust the BRIGHTNESS to +16 and CONTRAST to -16 in the IMAGE menu of this projector, or adjust the black color by viewing the image.

### B. Plugging in the power cord

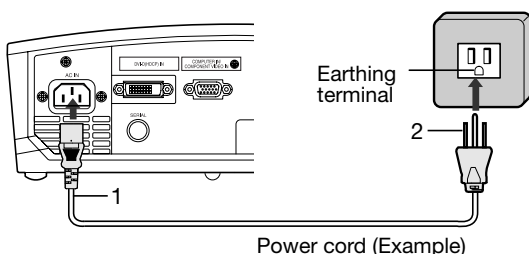

- 1 Plug the attached power cord into the power cord inlet of this projector.
- 2 Plug the other end of the power cord into a power outlet.

- The power cords for use in the U.S. and Europe are included with this projector. Use the appropriate one for your country.
- This projector uses the power plug of three-pin grounding type. Do not take away the grounding pin from the power plug. If the power plug doesn't fit your wall outlet, ask an electrician to change the wall outlet.
- The provided power cord for the U.S. is rated at 120 V. Never connect this cord to any outlet or power supply using other voltages or frequencies than rated. If you use a power supply using other voltage than rated, prepare an appropriate power cord separately.

## C. Projecting images

### Preparation:

- Remove the lens cap.
- Turn on the power of the connected video equipment.

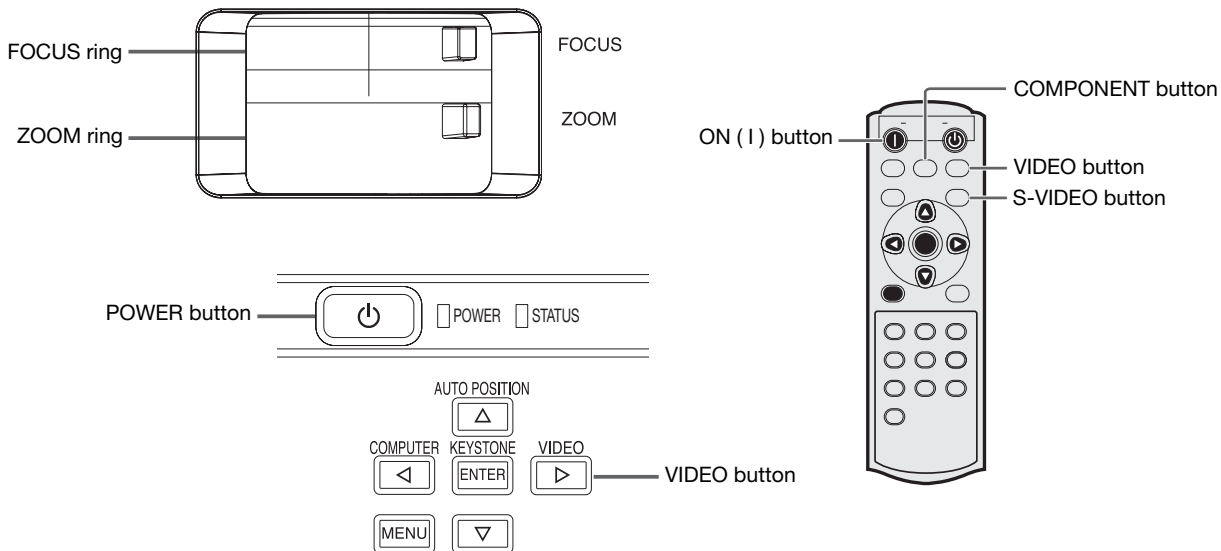

1. Confirm the POWER indicator lights up red.
  - If the projector was turned off before the lamp was cooled down sufficiently last time, the fan may start rotating and the POWER button may not work after the power cord is plugged. (The STATUS indicator blinks green.) After the fan stops rotating, press the POWER button to turn back on the POWER indicator.
2. Press the POWER button on the projector or ON ( I ) button on the remote control.
  - It may take about one minute for the lamp to light up.
  - The lamp fails to light up on rare occasions. In such a case, wait for a few minutes and then try again.
  - Do not cover the lens with the lens cap while the lamp is on. Do not strip off the aluminium sheet inside the lens cap.
  - The STANDARD lamp mode is activated by default whenever the projector is turned on. When the LOW lamp mode has been chosen, the default STANDARD lamp mode is switched to the LOW lamp mode in 1 minute.
3. Select an input source.
  - Press the VIDEO button on the projector or the VIDEO, S-VIDEO or COMPONENT button on the remote control that is corresponding to the terminal in use.
  - The input source is switched between VIDEO, S-VIDEO and COMPONENT at every press of the VIDEO button on the projector.
  - Though it may take some time before an image is displayed on the screen depending on the type of the input signal, such symptom is not a malfunction.
  - Some images become easier to view when the setting of aspect ratio is changed. (See Page 17.)
4. Adjust the position of the projector to keep an appropriate projection distance with which images are projected in their specified sizes.
5. Adjust the position of the projector so that the projector and the screen are perpendicular to each other. (See Page 10.)
  - When the projector cannot be positioned perpendicularly to the screen, adjust the projection angle. (See Page 10.)
6. Adjust the size of the projected image by turning the ZOOM ring.
7. Adjust the focus by turning the FOCUS ring.

Repeat steps 4 to 7, if necessary.



## Viewing video images (continued)

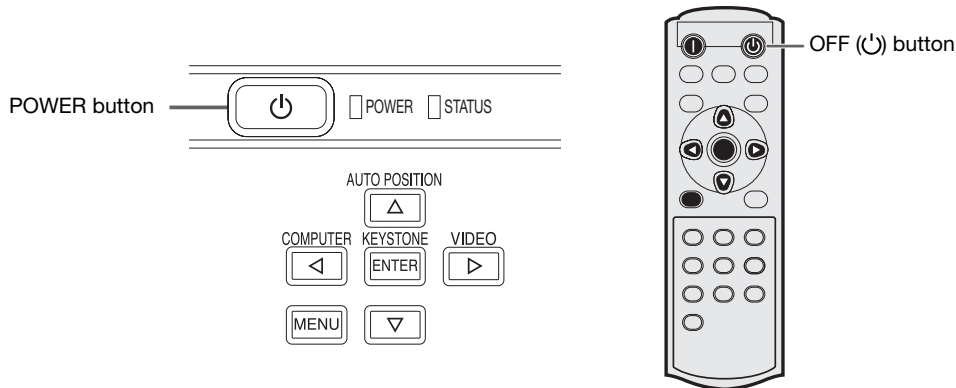

### To stop projecting:

8. Press the POWER button on the projector or the OFF (⏻) button on the remote control.
  - A confirmation message is displayed.
  - To cancel the procedure, leave the projector for a while or press the MENU button.
9. Press the POWER button on the projector or the OFF (⏻) button on the remote control again.
  - The lamp goes out and the projector goes into a standby mode. In this standby mode, the POWER indicator blinks red.
10. Wait about one minute for the POWER indicator to be lit in red steadily.
  - During this period of one minute in the standby mode, the intake fan and exhaust fan rotate to cool the lamp.
  - Do not unplug the power cord while the POWER indicator is blinking. Unplugging the power cord immediately after use may cause a breakdown.
  - Though the fan makes loud sounds during cooling, such symptom is not a malfunction.
11. Unplug the power cord from the outlet.
  - Cover the lens with the lens cap to protect it from dust.

### When projected images are distorted to a trapezoid:

#### With the control area of the projector:

1. Press the KEystone button on the control area of the projector.
2. Equalize the widths at the top and bottom of the screen by pressing the ▲ or ▼ button, viewing the screen.

#### With the INSTALLATION menu:

(See Page 21 for menu setting.)

1. Display the INSTALLATION menu.
2. Select KEystone by pressing the ▲ or ▼ button.
3. Equalize the widths at the top and bottom of the screen by pressing the ◀ or ▶ button, viewing the screen.

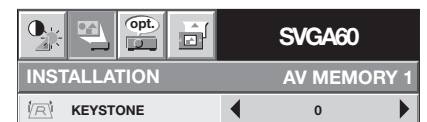

#### To cancel the menu:











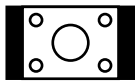
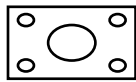
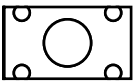

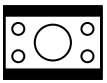
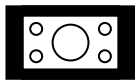

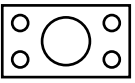
4. Press the MENU button several times.

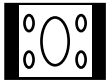
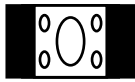
### IRIS button

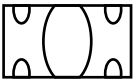
The iris function adjusts the contrast optically by opening and closing the lens aperture. The iris can be switched between two modes, OPEN and CLOSE. When OPEN is selected, the image becomes brighter. When CLOSE is selected, black levels of the image are reproduced with more clarity though the brightness is lowered. When you press the IRIS button, the current setting appears. When pressing it again while the setting is being displayed, the setting can be changed. It takes about 6 seconds for the iris to shift between OPEN state and CLOSE state.

## Setting the aspect ratio

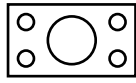
You can change the aspect ratio of the input video signal (or the ratio of width to height of the image). Change the setting according to the type of the input video signal.

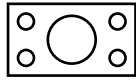
	4 : 3	16 : 9	EXPAND	REAL*
Original image size	Projects images with an aspect ratio of 4:3 when the input signal is 4:3 image.	Projects images with an aspect ratio of 16:9.	Projects images in the CinemaScope size or Vista size together with subtitles.	Projects images in their original size as input.
 4:3 image (480i, 576i, 480p, 576p, and PC)			 Available only when the input signal is 480i or 576i.	
 4:3 CinemaScope and Vista image			 Available only when the input signal is 480i or 576i.	
 Squeezed 4:3 (480i, 576i, 480p, 576p)			 Available only when the input signal is 480i or 576i.	
 16:9 image (1080i)			Not available.	Not available.
 16:9 image (720p)			Not available.	Not available.

Bold frames  are recommended modes.

\* : The REAL mode may not function depending on the input signal. For more details, refer to page 37.

- DVDs are usually labeled either FULLSCREEN or WIDESCREEN. FULLSCREEN DVDs produce a 4:3 image as shown above, and WIDESCREEN DVDs produce a 16:9 image as shown above, sometimes with or without thin black bars on the top or bottom of the picture. If you are purchasing DVDs for enjoyment with your projector, WIDESCREEN versions of DVDs will fill most of the screen and produce the best viewing results.

## How to change the settings:

### With the remote control:

1. Press the ASPECT button.
  - Every time the ASPECT button is pressed, the aspect mode changes from AUTO to 4:3, to 16:9, to EXPAND, to REAL, and back to AUTO.
  - When the keystone adjustment is applied, the REAL mode can not be selected.

### With the FEATURE menu:

(See Page 21 for menu setting.)

1. Display the FEATURE menu.
2. Select ASPECT by pressing the ▲ or ▼ button.
3. Select your desired aspect ratio by pressing the ◀ or ▶ button.

### To cancel the menu:

4. Press the MENU button.

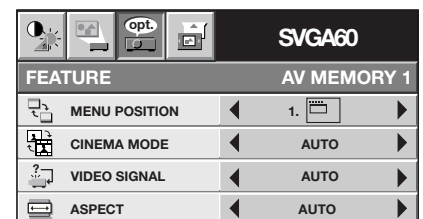

### Important :

- When a 4:3 image is kept displayed for a long time before displaying 16:9 image, the afterimages of the black bars may appear on the 16:9 image screen. Consult your dealer in this case.

# Viewing computer images

## A. Connecting the projector to a computer

### Preparation:

- Make sure that the power of the projector and that of the computer are turned off.
- When connecting the projector to a desktop computer, disconnect the RGB cables that are connected to the monitor.

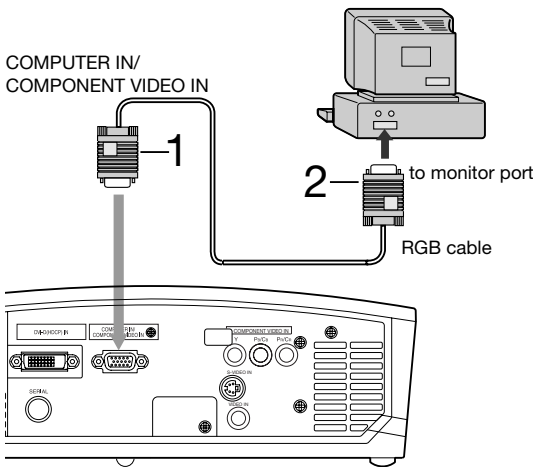

### For analog connection:

1. Connect one end of the supplied RGB cable to the COMPUTER IN/COMPONENT VIDEO IN terminal of the projector.
2. Connect the other end of the RGB cable to the monitor port of the computer.
  - Additional devices, such as a conversion connector and an analog RGB output adapter, are required depending on the type of the computer to be connected.
  - When viewing images supplied from an analog-connected computer, press the COMPUTER button on the remote control.
  - This projector does not support 3-line signals (SYNC-ON-GREEN signals).

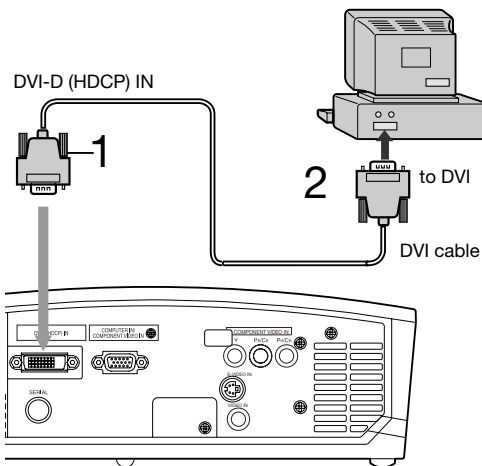

### For digital connection:

1. Connect one end of a commercially available DVI cable to the DVI-D IN terminal of the projector.
2. Connect the other end of the DVI cable to the DVI terminal of the computer.
  - Additional devices, such as a conversion connector and an analog RGB output adapter, are required depending on the type of the computer to be connected.
  - When viewing images supplied from a digital-connected computer, press the DVI-D(HDCP) button on the remote control.

- Turn on the power of the projector before that of the computer.
- Additional devices, such as a conversion connector and an analog RGB output adapter, are required depending on the type of the computer to be connected.
- Use of a long cable may decrease the quality of projected images.
- Also read the instruction manual of the equipment to be connected.
- Images may not be projected correctly, depending on the type of the connected computer.
- Contact your dealer for details of connection.

## B. Plugging the power cord

Plug the power cord in the same way as described in "Viewing video images." (See Page 14.)

## C. Projecting images

### Preparation:

- Remove the lens cap.
- Turn on the power of the connected computer.

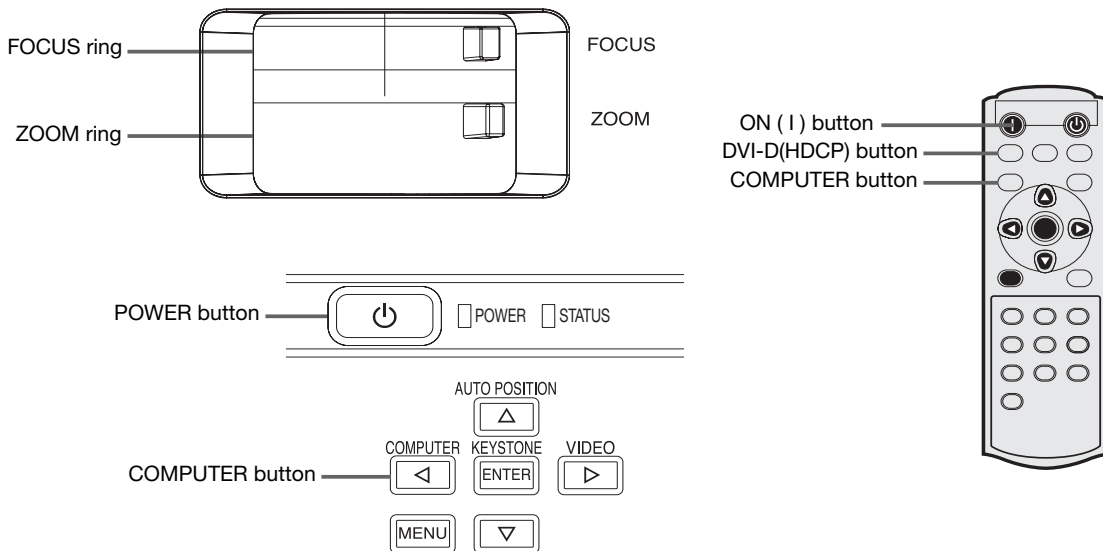

1. Confirm the POWER indicator lights up red.
  - If the projector was turned off before the lamp was cooled down sufficiently last time, the fan may start rotating and the POWER button may not work after the power cord is plugged. (The STATUS indicator blinks green.) After the fan stops rotating, press the power button to turn back on the POWER indicator.
2. Press the POWER button on the projector or ON ( I ) button on the remote control.
  - It may take about one minute for the lamp to light up.
  - The lamp fails to light up on rare occasions. In such a case, wait for a few minutes and then try again.
  - Do not cover the lens with the lens cap while the lamp is on. Do not strip off the aluminium sheet inside the lens cap.
  - The STANDARD lamp mode is activated by default whenever the projector is turned on. When the LOW lamp mode has been chosen, the default STANDARD lamp mode is switched to the LOW lamp mode in 1 minute.
3. Select an input source.
  - Press the COMPUTER button on the projector or the COMPUTER or DVI-D(HDCP) button on the remote control that is corresponding to the terminal in use.
  - The input source is switched between COMPUTER and DVI at every press of the COMPUTER button on the projector.
  - Though it may take some time before an image is displayed on the screen depending on the type of the input signal, such symptom is not a malfunction.
  - Images may not be projected in the correct position, depending on the type of the input signal. In such a case, press the AUTO POSITION button. (See Page 20.)
4. Adjust the position of the projector to keep an appropriate projection distance with which images are projected in their specified sizes.
5. Adjust the position of the projector so that the projector and the screen are perpendicular to each other. (See Page 10.)
  - When the projector cannot be positioned perpendicularly to the screen, adjust the projection angle. (See Page 10.)
6. Adjust the size of the projected image by turning the ZOOM ring.
7. Adjust the focus by turning the FOCUS ring.

Repeat steps 4 to 7, if necessary.

### Important :

- When a 4:3 image is kept displayed for a long time before displaying 16:9 image, the afterimages of the black bars may appear on the 16:9 image screen. Consult your dealer in this case.

## Viewing computer images (continued)

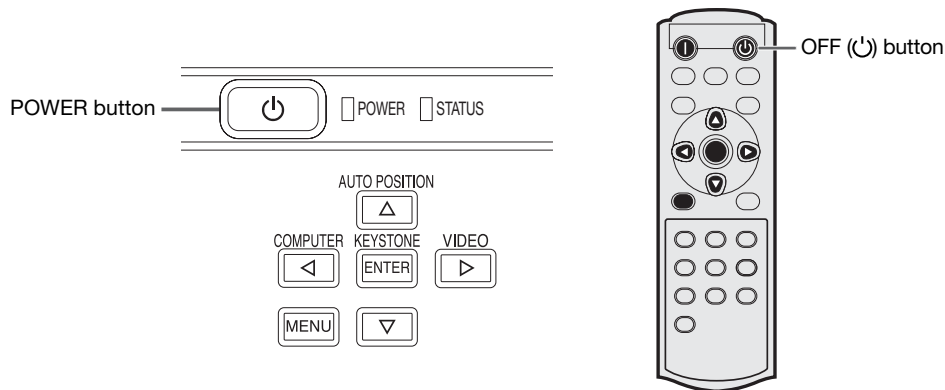

### To stop projecting:

8. Press the POWER button on the projector or the OFF (⏻) button on the remote control.
  - A confirmation message is displayed.
  - To cancel the procedure, leave the projector for a while or press the MENU button.
9. Press the POWER button on the projector or the OFF (⏻) button on the remote control again.
  - The lamp goes out and the projector goes into a standby mode. In this standby mode, the POWER indicator blinks red.
10. Wait about one minute for the POWER indicator to be lit in red steadily.
  - During this period of one minute in the standby mode, the intake fan and exhaust fan rotate to cool the lamp.
  - Do not unplug the power cord while the POWER indicator is blinking. Unplugging the power cord immediately after use may cause a breakdown.
  - Though the fan makes loud sounds during cooling, such symptom is not a malfunction.
11. Unplug the power cord from the outlet.
  - Cover the lens with the lens cap to protect it from dust.

### AUTO POSITION button

When the image supplied from the computer is displaced, carry out the following procedure.

1. Display a bright image (such as a full-screen display of the Recycle Bin window).
2. When the screen saver has been enabled, disable it.
3. Press the AUTO POSITION button.

The projector automatically makes optimum positional settings for the input signal.

  - If the image is not projected in the correct position even after you press the AUTO POSITION button several times, change the settings in the SIGNAL menu to put the image in the correct position. (See Page 26.)
  - When you carry out this procedure with a dark image, the image may be displaced.

### When connecting to a notebook computer:

When the projector is connected to a notebook computer, images may not be projected in some cases. In such cases, set the computer so that it can output signals externally. The setting procedure varies depending on the type of the computer. See the instruction manual of your computer.

### Example of the setting procedure for external output

Press the [Fn] key and any of the keys [F1] to [F12] at the same time. (The key to be pressed depends on the type of the computer you use.)

- Menus are not displayed when no signal is supplied to the projector.

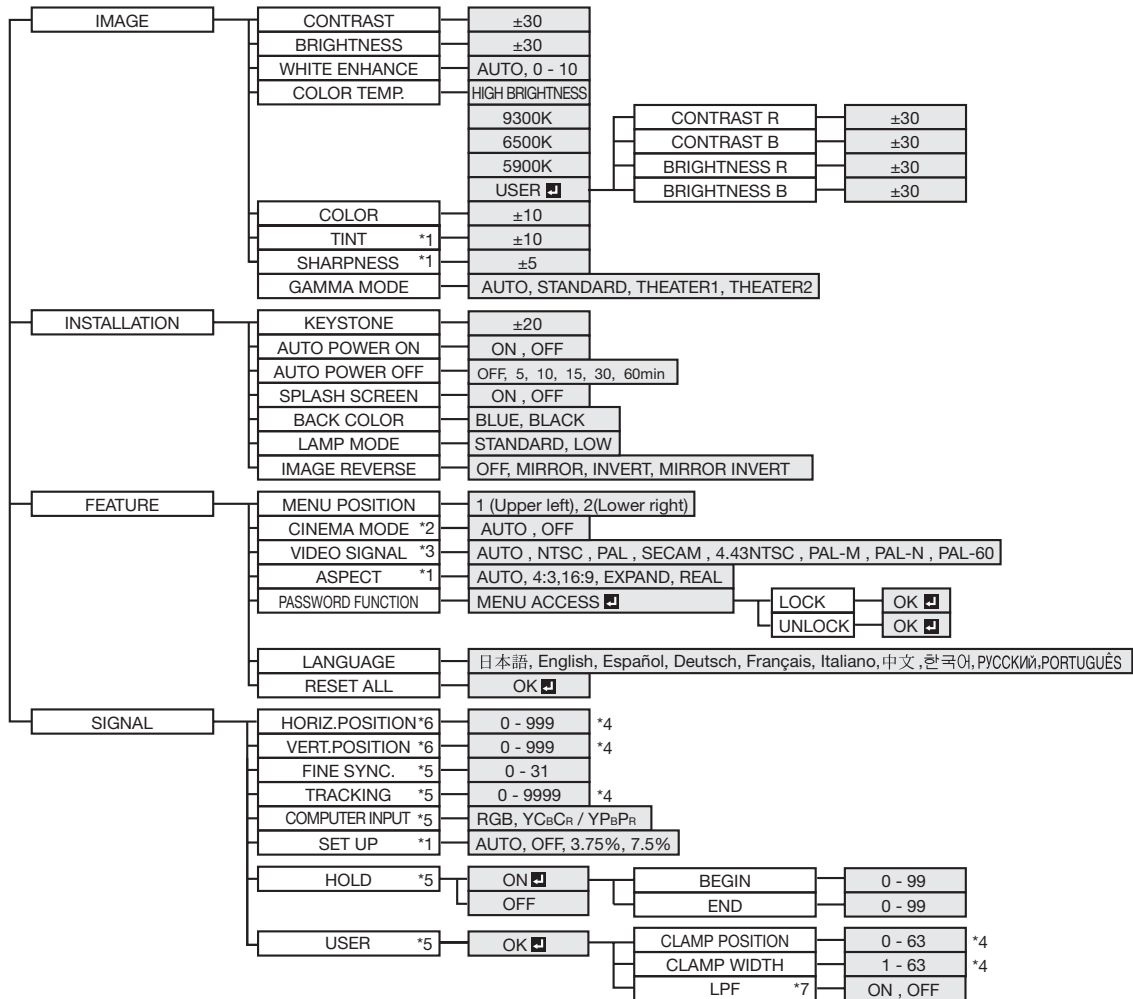

- \* 1: Not available with certain signals.
- \* 2: Available only when the input signal is TV50, TV60, 480i, or 576i.
- \* 3: Available only when the source is VIDEO or S-VIDEO.
- \* 4: Setting range differs depending on the input signals.
- \* 5: Not available when the source is VIDEO, S-VIDEO, or DVI.
- \* 6: Not available when the source is DVI or COMPUTER.
- \* 7: Available only when the input signal is 480i, 480p, 576i, or 576p.

## How to set the menus:

Following describe how to set AUTO POWER OFF time as an example.

1. Press the MENU button.
  - When no signal is input, the menu does not appear.



2. Press the ◀ or ▶ button to select a menu to use.



3. Press the ENTER button (or ▼ button).

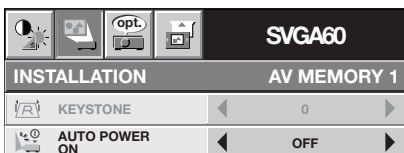

4. Press the ▲ or ▼ button to select an item to adjust.



5. Set the selected item by pressing the ◀ or ▶ button.



To cancel the menu:

6. Press the MENU button several times.

### Important:

- When the MENU button doesn't function, unplug the power cord from the wall outlet. Wait about 10 minutes, plug the power cord in, and try again.
- After selecting the items marked with , press the ENTER button.

# Menu operation (continued)

## Available settings in the menus

Set the following items on their relevant menus.

### 1. IMAGE menu

SVGA60	
IMAGE	AV MEMORY 1
CONTRAST	◀ 0 ▶
BRIGHTNESS	◀ 0 ▶
WHITE ENHANCE	◀ AUTO ▶
COLOR TEMP.	◀ 6500K ▶
COLOR	◀ 0 ▶
TINT	◀ 0 ▶
SHARPNESS	◀ 0 ▶
GAMMA MODE	◀ AUTO ▶

### 2. INSTALLATION menu

SVGA60	
INSTALLATION	AV MEMORY 1
KEYSTONE	◀ 0 ▶
AUTO POWER ON	◀ OFF ▶
AUTO POWER OFF	◀ OFF ▶
SPLASH SCREEN	◀ ON ▶
BACK COLOR	◀ BLUE ▶
LAMP MODE	◀ STANDARD ▶
IMAGE REVERSE	◀ OFF ▶

### 3. FEATURE menu

SVGA60	
FEATURE	AV MEMORY 1
MENU POSITION	◀ 1. ▶
CINEMA MODE	◀ AUTO ▶
VIDEO SIGNAL	◀ AUTO ▶
ASPECT	◀ AUTO ▶
PASSWORD FUNCTION	◀ MENU ACCESS ▶
LANGUAGE	◀ English ▶
RESET ALL	◀ OK ▶

### 4. SIGNAL menu

SVGA60	
SIGNAL	AV MEMORY 1
HORIZ. POSITION	◀ 0 ▶
VERT. POSITION	◀ 0 ▶
FINE SYNC.	◀ 0 ▶
TRACKING	◀ 0 ▶
COMPUTER INPUT	◀ RGB ▶
SET UP	◀ AUTO ▶
HOLD	◀ ON ▶
USER	◀ OK ▶

## 1. IMAGE menu

ITEM	SETTING	FUNCTION
CONTRAST	±30	Use to adjust the contrast of the projected image. (See Page 24.)
BRIGHTNESS	±30	Use to adjust the brightness of the projected image. (See Page 24.)
WHITE ENHANCE	AUTO / 0 - 10	Use to enhance only the white level of the image. Select AUTO for normal use. (See Page 24.)
COLOR TEMP.	5 options	Use to adjust the color temperature. (See Page 25.)
COLOR	±10	Use to adjust the color thickness of the projected image. (See Page 24.)
TINT	±10	Use to adjust the color tint of the projected image. (See Page 24.)
SHARPNESS	±5	Use to adjust the sharpness of the projected image. (See Page 24.)
GAMMA MODE	AUTO	The proper gamma mode is automatically selected depending on the input signal. Default is AUTO. THEATER1 is automatically selected for Video equipment image input signals such as 480i and 720p and STANDARD for computer image input signals such as XGA and SVGA.
	STANDARD	Select to secure the contrast even when the room lighting is increased to some extent.
	THEATER1	Select when watching movies in dim lighting as in a theater.
	THEATER2	Select to gain the halftone to make the skin color more vibrant even in a dark scene. This mode is suitable for TV viewing.

- For more enhanced color reproduction, set WHITE ENHANCE to 0. The white portion of the color wheel will be disabled and you can reproduce true-to-life images.

## 2. INSTALLATION menu

ITEM	SETTING	FUNCTION
KEYSTONE	±20	Use to correct vertical keystone distortion.
AUTO POWER ON	ON / OFF	When ON is chosen, the lamp is automatically lit when the power cord is plugged in the wall outlet. Choose ON when using the projector mounted on the ceiling. <ul style="list-style-type: none"> <li>The projector is in the stand-by mode when the lamp is off. Use the remote control to turn on the lamp.</li> </ul>
AUTO POWER OFF	OFF / 5 - 60min	Use to set the time elapsed before the projector enters the stand-by mode when there is no signal input from the source.
SPLASH SCREEN	ON / OFF	Choose ON to display the splash screen when the power is turned on.
BACK COLOR	BLUE / BLACK	Use to change the color of the screen that appears when no signal is supplied.
LAMP MODE	STANDARD	Select this option when you want to view images in a well-lit room.
	LOW	Select to moderate the intensity of the lamp. The operating sound is reduced and the lamp lifetime becomes longer. <ul style="list-style-type: none"> <li>Frequent switching of the lamp mode may damage the lamp.</li> </ul>
IMAGE REVERSE	OFF	Select when viewing images from the front with the projector installed on the floor.
	MIRROR	Select when viewing images projected from the behind of the screen with the projector installed on the floor.
	INVERT	Select when viewing images projected from the behind of the screen with the projector installed on the ceiling.
	MIRROR INVERT	Select when viewing images from the front with the projector installed on the ceiling.

- The STANDARD lamp mode is activated by default whenever the projector is turned on. When the LOW lamp mode has been chosen, the default STANDARD lamp mode is switched to the LOW lamp mode in 1 minute.

**3. FEATURE menu**

ITEM	SETTING	FUNCTION
MENU POSITION	2 options	Use to change the position of the menu.
CINEMA MODE	AUTO OFF	The film mode will be automatically activated when a film source signal is input. The film mode will not be activated.
VIDEO SIGNAL	8 options	When AUTO is selected, the appropriate video format is automatically selected depending on the input signal. If the image isn't displayed correctly, select the desired video format manually.
ASPECT	AUTO 4:3  16:9 EXPAND REAL	Select to change the aspect ratio automatically depending on the input signal. Select to project images with an aspect ratio of 4:3 when the input signal is 4:3 images. Select to project images with an aspect ratio of 16:9. Select to enlarge and project images of CinemaScope size or Vista size. Select to project images in their original size as input. Not available when the keystone adjustment is applied.
PASSWORD FUNCTION		Use to enable or cancel the password lock. See page 27 for details.
LANGUAGE	10 languages	Use to select the language used in the menus.
RESET ALL		Use to reset the settings of the menu (excluding PASSWORD FUNCTION and LANGUAGE) to the factory setting values.

**4. SIGNAL menu**

ITEM	SETTING	FUNCTION
HORIZ. POSITION *		Use to adjust the horizontal position of the projected image.
VERT. POSITION *		Use to adjust the vertical position of the projected image.
FINE SYNC.		Use to eliminate flickering or blur, if appears, viewing the projected image.
TRACKING		Use to eliminate vertical wide stripes, if appears, viewing the projected image.
COMPUTER INPUT	RGB  YCbCr/YpPr	Select this option when connecting the projector to high definition video equipment having R, G, and B output terminals. Select this option when connecting the projector to a DVD player or other device having Y, C <sub>B</sub> , and C <sub>R</sub> (or Y, P <sub>B</sub> , and P <sub>R</sub> ) component video output terminals.
SET UP	AUTO OFF 3.75%/7.5%	Select to change the SET UP mode automatically. Select to make black lighter. Select to make black thicker. <ul style="list-style-type: none"> <li>When 7.5% is chosen, the brightness is decreased by set-up cancel function for U.S. Choose OFF when the image is dark.</li> </ul>
HOLD USER		Use to adjust the image when flagging occurs near the top of the screen.
CLAMP POSITION/ CLAMP WIDTH		Use to correct solid white or solid black in the projected image.
LPF		Use to select whether or not to enable the LPF.

- Though horizontal strips may appear on the enlarged projected image, such symptom is not a malfunction.
- Options marked with an asterisk (\*) become unavailable depending on the type of the input signal.
- When you change the horizontal or vertical position to a large extent, noise may appear.
- The adjustable range of the vertical position varies depending on the type of the input signal. Though the image may stay in the same position even when the setting value is changed, such symptom is not a malfunction.



# ***Adjusting projected images***

---

## **To adjust the brightness (CONTRAST and BRIGHTNESS):**

You can make adjustments for the brightness of the projected image using the menu.

(See Page 21 for menu setting.)

1. Display the IMAGE menu.
2. Select CONTRAST or BRIGHTNESS by pressing the ▲ or ▼ button.
3. Adjust the selected item by pressing the ◀ or ▶ button.

### **To cancel the menu:**

4. Press the MENU button.

## **CONTRAST**

Select to adjust the contrast of the image. Every time the ▶ button is pressed, the image becomes brighter and more defined. Every time the ◀ button is pressed, the image becomes darker and less defined.

## **BRIGHTNESS**

Every time the ▶ button is pressed, the image becomes brighter. Every time the ◀ button is pressed, the image becomes darker.

## **To adjust the color (COLOR and TINT):**

You can adjust the color of the projected image using the menu.

(See Page 21 for menu setting.)

1. Display the IMAGE menu.
2. Select COLOR or TINT by pressing the ▲ or ▼ button.
  - COLOR is unavailable when the computer or DVI-D is selected as the input source.
  - TINT is available only when the NTSC signal is input.
3. Adjust the selected item by pressing the ◀ or ▶ button.

### **To cancel the menu:**

4. Press the MENU button.

## **COLOR**

Use to adjust the color thickness of the projected image. Every time the ▶ button is pressed, the color becomes thicker. Every time the ◀ button is pressed, the color becomes lighter.

- COLOR is unavailable when the computer or DVI-D is selected as the input source.

## **TINT**

Use to adjust the tint of the projected image. Every time the ▶ button is pressed, the image appears more greenish. Every time the ◀ button is pressed, the image appears more reddish.

## **To sharpen or soften the projected image (SHARPNESS):**

You can adjust the sharpness of the projected image using the menu.

(See Page 21 for menu setting.)

1. Display the IMAGE menu.
2. Select SHARPNESS by pressing the ▲ or ▼ button.
3. Adjust the selected item by pressing the ◀ or ▶ button.

### **To cancel the menu:**

4. Press the MENU button.

## **To enhance or weaken the white level of the projected image (WHITE ENHANCE):**

Use to enhance only the white level of the image. Level 10 enhances the white level most. Default is AUTO. Level 3 is automatically selected for video equipment image input signals such as 480i and 720p and level 10 for computer image input signals such as XGA and SVGA. (See Page 21 for menu setting.)

1. Display the IMAGE menu.
2. Select WHITE ENHANCE by pressing the ▲ or ▼ button.
3. Adjust the selected item by pressing the ◀ or ▶ button.

### **To cancel the menu:**

4. Press the MENU button.

**To adjust the tone of white (COLOR TEMP.):**

You can select a preset color temperature (white tone) using the menu.  
(See Page 21 for menu setting.)

1. Display the IMAGE menu.
2. Select COLOR TEMP. by pressing the ▲ or ▼ button.
3. Select your desired color temperature by pressing the ◀ or ▶ button.





**To cancel the menu:**

4. Press the MENU button.

**To adjust the tone of white (To customize the color temperature):**

To customize (and store) the color temperature to your preference, carry out the following procedure.  
(See Page 21 for menu setting.)

1. Select COLOR TEMP. in the IMAGE menu.
2. Press the ◀ or ▶ button to select USER .
3. Press the ENTER button.
4. Press the ▲ or ▼ button to select the desired item.
5. Press the ◀ or ▶ button to adjust the selected item.
6. Repeat steps 4 and 5 for optimum adjustment results.

USER	AV MEMORY 1
 CONTRAST R	◀ 0 ▶
 CONTRAST B	◀ 0 ▶
 BRIGHTNESS R	◀ 0 ▶
 BRIGHTNESS B	◀ 0 ▶

**To cancel the menu:**

7. Press the MENU button.

**To enable the stored color temperature:**

1. Select USER by pressing the COLOR TEMP button on the remote control.

**About color temperature**

There are different kinds of white color. Color temperature is a way to show the differences in white. White of which temperature is low appears reddish. When the color temperature rises, white appears bluish. This projector adjusts this color temperature by changing the values of contrast blue and red.

To rise the color temperature:

Increase the CONTRAST B (blue) and decrease the CONTRAST R (red).

To reduce the color temperature:

Decrease the CONTRAST B (blue) and increase the CONTRAST R (red).

**AV MEMORY**

You can store up to 3 patterns of the image quality setting regardless the input source.

**To store the settings**

1. Press an AV MEMORY button (M1, M2 or M3 ) on the remote control to store the settings.
2. Set the items of the IMAGE menu.
  - The settings are automatically stored.
  - Setting the items by using the picture quality adjusting buttons on the remote control is also available.

**To enable the stored image quality settings**

1. Press the AV MEMORY button to enable the stored setting.
  - The image quality settings stored in the selected memory is enabled.
- When the input source is changed, the AV memory setting selected just before is automatically selected.
- When RESET ALL in the FEATURE menu is selected, all the settings of the AV memory are cleared.
- As the default setting, the AV memories are allocated to each input terminal as shown below.

COMPONENT VIDEO IN terminals	AV MEMORY 1
VIDEO IN terminal	AV MEMORY 2
S-VIDEO IN terminal	AV MEMORY 2
COMPUTER IN/COMPONENT VIDEO IN terminal	AV MEMORY 3
DVI-D (HDCP) IN terminal	AV MEMORY 3

- When image quality setting is changed, the setting of the input source allocated to the same AV memory also changes.

## Adjusting projected images (continued)

This projector automatically and properly projects video signals supplied from the computer. However, some video signals may not be projected, depending on the type of the computer. In such a case, press the AUTO POSITION button. (See Page 20.) When the signal is still not projected properly, adjust the projected image using the SIGNAL menu.

### How to adjust the image supplied from the computer using the menu:

Carry out the following procedures according to the symptoms.

- Wide strips appear. .... Adjust TRACKING in the SIGNAL menu.  
The projected image flickers.  
The projected image is blurred. .... Adjust FINE SYNC. in the SIGNAL menu.  
The projected image is displaced horizontally. .... Adjust HORIZ.POSITION in the SIGNAL menu. Every time the ◀ button is pressed, the image moves to the right. Every time the ▶ button is pressed, the image moves to the left.  
The projected image is displaced vertically. .... Adjust VERT.POSITION in the SIGNAL menu. Every time the ◀ button is pressed, the image moves down. Every time the ▶ button is pressed, the image moves up.

1. Display the SIGNAL menu.
2. Press the ▲ or ▼ button to select an item to adjust.
3. Adjust the selected item by pressing the ◀ or ▶ button.

#### To cancel the menu:

4. Press the MENU button.
- Do not change the settings of the SIGNAL menu in normal use.

#### Simple method to adjust the image position

##### To adjust the horizontal position:

1. Align the left edge of the image with the left side of the screen by adjusting HORIZ.POSITION. Then, align the right edge of the image with the right side of the screen by adjusting TRACKING.
2. Repeat step 1 above to complete the adjustment of the horizontal position.

##### To adjust the vertical position:

3. Align the upper edge of the image with the upper side of the screen by adjusting VERT.POSITION.

### LPF (Progressive filter)



You can select whether or not to enable the LPF. This item is set to OFF normally.

Vertical or horizontal streak noise may appear on the projected image, depending on the type of the DVD player you use. In such a case, you can reduce such streak noise by enabling the LPF. However, projected images become softened slightly.

1. Display the SIGNAL menu.
2. Press the ▲ or ▼ button to select USER.
3. Press the ENTER button.
4. Press the ▲ or ▼ button to select LPF.
5. Press the ◀ or ▶ button to choose ON or OFF.

#### To cancel the menu:

6. Press the MENU button.

USER	AV MEMORY 1
 CLAMP POSITION	◀ 0 ▶
 CLAMP WIDTH	◀ 1 ▶
 LPF	◀ OFF ▶

## Password function

This projector is equipped with the password function that is designed for prevention of wrong operation by children and restriction on operation by other than specified users.

MENU ACCESS.....All the buttons except for the POWER button on the projector are disabled. (The buttons on the remote control are enabled.) You can use this mode as a measure of prevention of wrong operation by children and restriction on operation by other than specified users.

### To enable the password function:

1. Display the FEATURE menu.
2. Press the ▲ or ▼ button to select PASSWORD FUNCTION.
3. Press the ENTER button.
  - The screen for setting the password function will appear.

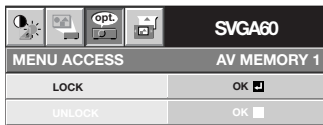

- When the password has already been set, the screen for canceling the password function will appear.
4. Press the ENTER button.
    - The screen for entering a password will appear.

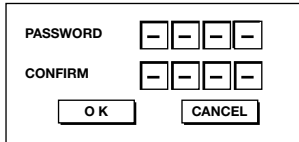

5. Press the ▲ or ▼ button to select a number from 0 to 9.
6. Press the ► button.
  - You can set the next digit.
7. Repeat steps 5 and 6 to set a four-digit password.
8. Enter the password again for confirmation using the same steps.
9. Select OK, and press the ENTER button.
  - If the entered passwords don't match, an error message will appear.
  - To cancel the procedure, select CANCEL and press the ENTER button.
  - You can cancel the procedure by pressing the MENU button alternatively.

### To cancel the password function:

1. Display the FEATURE menu.
2. Press the ▲ or ▼ button to select PASSWORD FUNCTION.
3. Press the ENTER button.
  - The screen for canceling the password function will appear.



4. Press the ENTER button.
  - The screen for entering the password will appear.
5. Press the ▲ or ▼ button to select a number from 0 to 9.
6. Press the ► button.
  - You can set the next digit.
7. Repeat steps 5 and 6 to enter the four-digit password.
8. Press the ► button, select OK, and press the ENTER button.
  - If you enter a wrong password, an error message will appear.
  - To cancel the procedure, press the ► button, select CANCEL, and press the ENTER button.
  - You can cancel the procedure by pressing the MENU button alternatively.

### Important:

- If you forget your password, hold down the MENU and ENTER buttons on the control panel at the same time about three seconds to cancel the password function.

# Asking for installation

## To view images projected by the ceiling-mounted projector from the front:

When the projector is installed on the ceiling, the special ceiling mount bracket, which is separately sold, is required. Be sure to ask a certified installation specialist for installation of the projector. Contact your dealer for details.

- Mitsubishi assumes no responsibilities for any damage caused by use of other manufacturer's ceiling bracket and by inadequate installation conditions even within the warranty period.

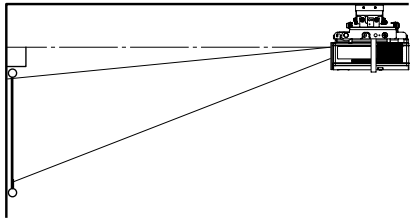

- When installing the projector on the ceiling, set IMAGE REVERSE in the INSTALLATION menu to MIRROR INVERT.
- Ask your installation specialist to provide a breaker. When you do not use the projector, be sure to shut down the main power by the breaker.
- When the projector is installed on the ceiling, projected images may appear darker than those projected when the projector is installed on the floor. This symptom is not a malfunction.
- Do not install the projector where the exhaust vents are exposed to air emitted by an air conditioning. Such installation may cause a breakdown.
- Do not install the projector near a fire alarm because it emits hot air from its exhaust vents.

## To view images projected on the translucent screen from behind:

Be sure to ask a certified installation specialist for installation of the projector. Contact your dealer for details.

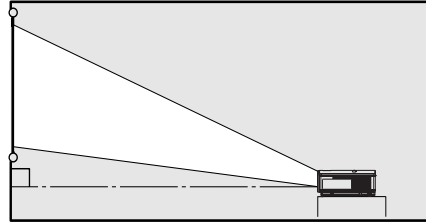

- To view images projected from behind the screen, set IMAGE REVERSE in the INSTALLATION menu to MIRROR.

## Dimension Drawings (unit : mm)

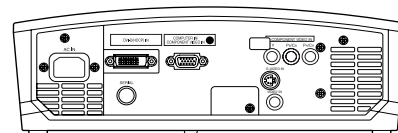
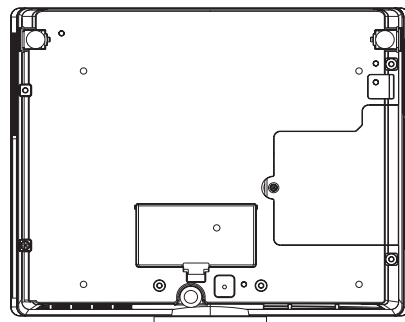
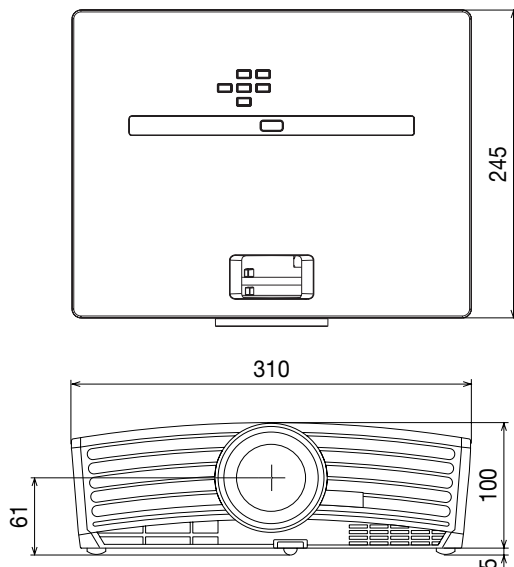

# Using filter

This projector has a filter cover (filter) for keeping dust out. When using the projector in a dusty place, attach this filter cover.

## Installation

**Before installing this filter to the projector, be sure to unplug the projector from the outlet.**

1. Fit three hooks of the filter cover into the projector.
2. Push the filter cover in the direction of the arrow.
  - If you use excess force to push the filter cover, the hooks may be damaged.
3. Tighten the attachment screw (a) firmly.

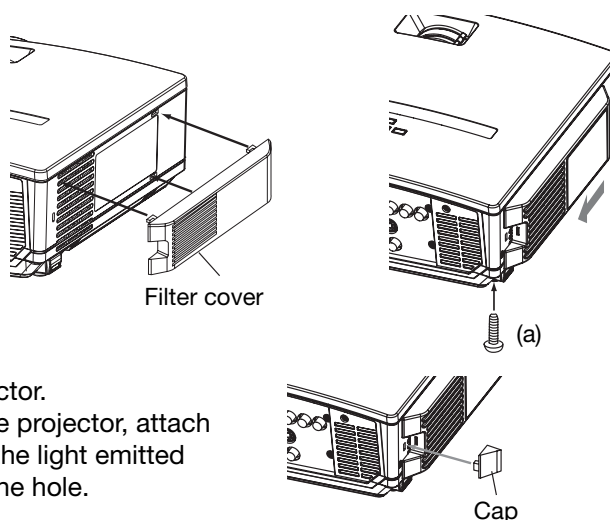

- Don't use any other filters than that designed for this projector.
- If you are disturbed by the light emitted from the side of the projector, attach the filter to block the light. Further, if you are disturbed by the light emitted from the hole of theft-proof lock, put the supplied cap on the hole.

## Cleaning

**Before cleaning, be sure to turn off the main power switch and unplug the projector from the outlet.**

- Clean the filter frequently (at least once a month). When dust accumulates on the filter at the air inlet, the temperature inside the projector may rise abnormally high, causing damage to the internal parts and reducing the lifetime of the panel.
- In case of any abnormality including an abnormal rise of the inside temperature, the projector may automatically turn off and go into the standby mode where the light source lamp is turned off in order to protect its internal parts.

### Cleaning the filter

1. Remove the screw (a) from the filter cover.
  - Be careful not to lose the screw.
2. Move the filter cover in the direction of the arrow.
3. Release three hooks and remove the filter cover from the projector.
  - If you use excess force to pull the filter cover, the latches may be damaged.
4. Remove the holder that is retaining the filter while pushing the tab of the holder in the direction of the arrow.
5. Remove the filter from the filter cover.
6. Clean dirt and dust adhering to the filter using a vacuum.
  - If stubborn stains persist, wash the filter with diluted detergent, rinse with water, and dry well.
7. Attach the filter to the filter cover.
  - Make sure that the filter is positioned correctly.
8. Fit and push the holder as far as it will go and press it in the direction of the arrow to install.
9. Fit three hooks of the filter cover into the projector.
10. Push the filter cover in the direction of the arrow.
  - If you use excess force to push the filter cover, the hooks may be damaged.
11. Tighten the attachment screw (a) of the filter cover firmly.

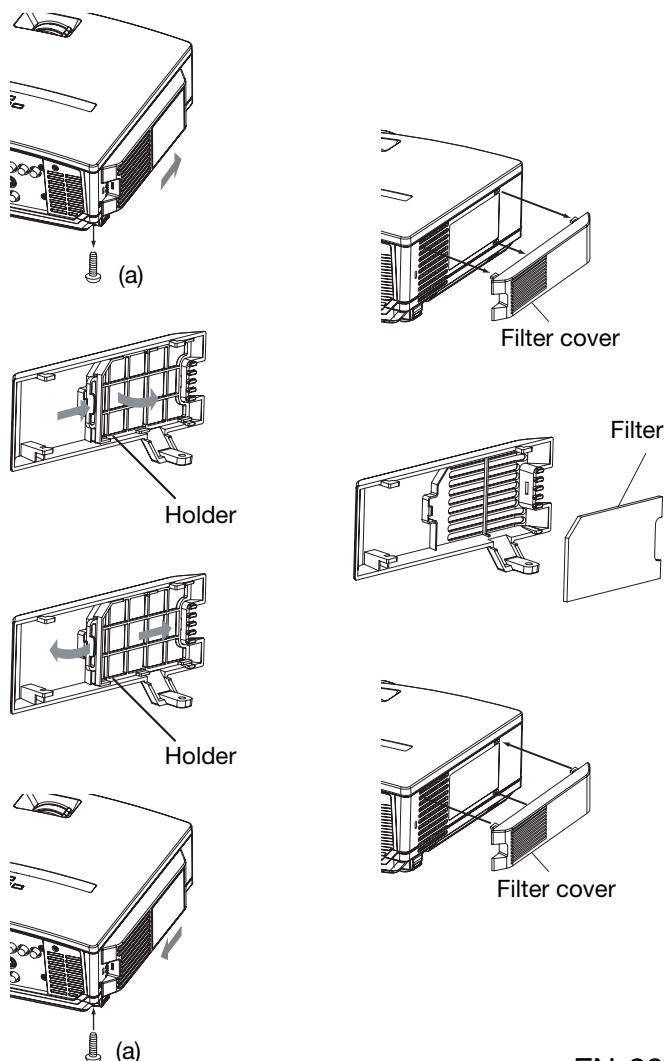

# Replacing the lamp

This projector is equipped with a lamp to project images. This lamp is a consumable. It may burn out or its brightness may decrease during use. In such cases, replace the lamp with a new one as soon as possible. Be sure to replace the lamp with a new lamp separately sold that is exclusive to this projector. Contact your dealer for purchase of the lamp.

## WARNING:

- Be careful not to drop the lamp fixing screws into the inside of the projector. Don't put a metal piece or flammable object into the projector. Using the projector with any foreign object present inside may result in electric shock or fire. When you can't remove the foreign object from the inside, contact your dealer for removal.
- Be sure to install the lamp securely. When the lamp isn't installed properly, it won't illuminate. Improper installation may also result in fire.
- Don't shake the removed lamp or don't lift it above your face. You may be injured in your eye by flying or falling glass fragments.
- Don't replace the lamp immediately after use because the lamp cover is very hot. You may get burned. Turn off the power using the POWER button. After the lamp goes out, wait about two minutes until the intake and exhaust fans for cooling the lamp stop rotating. Then unplug the power cord, and wait at least one hour to allow the lamp to cool down enough to the touch.

## Interval of lamp replacement

The recommended interval of lamp replacement is about 3000 hours<sup>\*1</sup> <sup>\*2</sup> of consecutive use. Such interval differs depending on the operating environment and may be shorter than 3000 hours<sup>\*1</sup> <sup>\*2</sup>. Decrease in luminescence and/or color brightness indicates that the lamp needs to be replaced. When the lamp operation time exceeds 2250 hours<sup>\*1</sup>, the indicator will blink alternately between green and red (while the lamp is lit; when the lamp is not lit, the indicator will be lit red only) and the lamp replacement message will appear on the screen for one minute everytime the lamp is turned on. When the lamp has been used for about 2850 hours<sup>\*1</sup>, the replacement message (LAMP EXCHANGE) will appear on the screen for one minute every 20 hours<sup>\*1</sup> thereafter.

**When the lamp operation time exceeds 3000 hours<sup>\*1</sup> <sup>\*2</sup>, the projector automatically shuts off and can't be used until the lamp is replaced and the lamp operation time is reset.**

<sup>\*1</sup> Duration when LAMP MODE of the INSTALLATION menu is set to LOW. When it is set to STANDARD, this duration will be shorted.

<sup>\*2</sup> Duration when LAMP MODE is set to STANDARD, this duration will be shorted to 2000 hours.

## Caution:

- Don't remove the lamp for any purpose other than replacement. Unnecessary removal of the lamp may result in a breakdown.
- This projector uses a high-pressure mercury lamp as the light source. The high-pressure mercury lamp may explode or fail to illuminate permanently because of an impact, scratch, or deterioration through use. The period of time until explosion or permanent failure to illuminate varies considerably from lamp to lamp, depending on operation conditions. Therefore, the lamp may explode soon after the start of use.
- The possibility of explosion of the lamp increases if you use it beyond its replacement period. When the instruction of lamp replacement appears, replace it with a new one immediately even if the lamp is still lighting normally.
- When the high-pressure mercury lamp explodes, glass fragments will scatter inside or outside the lamp box and the gas charged inside the lamp will diffuse inside or outside the projector. The gas inside the lamp contains mercury. Be careful not to breathe it or avoid it from entering your eye or mouth. If you should breathe it or if it should enter your eye or mouth, see a doctor immediately.
- In the event that the high-pressure mercury lamp exploded, glass fragments may have been scattered inside the projector. Ask your dealer to replace the lamp and to inspect the inside of the projector. When you clean or replace the lamp by yourself, be sure to hold the handle of the lamp. You may get injured by glass fragments.
- Don't replace the lamp while the projector is installed on the ceiling. Glass fragments may fall from the projector, entering your eye or mouth causing injury.
- When placing the projector upside down to replace the lamp or conduct maintenance, ensure that the projector is securely placed before working with it.

## To replace the lamp:

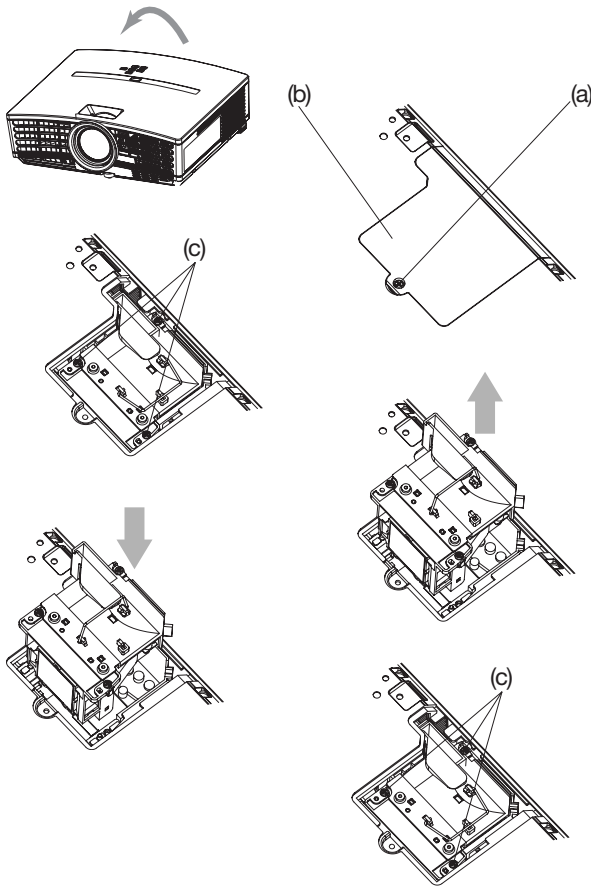

1. Reverse the projector gently.
2. Loosen the screw (a) using a Phillips screwdriver (+), and remove the lamp cover (b).
3. Loosen the screws (c) using a Phillips screwdriver (+).
4. Pull up the handle.
5. Pull out the lamp box by the handle while holding the projector.
  - Pull the lamp box out of the projector slowly. If it is pulled out quickly, the lamp may break scattering glass fragments.
  - Do not spill liquid on the removed lamp box or do not place it near any flammable object or where children can reach to prevent injury or fire.
6. Load a new lamp box securely into the projector in the right orientation.
7. Put the handle back to the original position.
  - Make sure that the handle is locked.
8. Tighten up the screws (c) using a Phillips screwdriver (+).
9. Tighten up the screw (a) using a Phillips screwdriver (+) to secure the lamp cover.

### Reset of the lamp operation time

Plug in the power cord, turn on the lamp, and reset the lamp operation time by holding down the ◀, ▶, and POWER buttons on the control panel at the same time about three seconds.

#### Important:

- Unless these three buttons are pressed at the same time, the lamp operation time isn't reset.
- Make sure that the STATUS indicator is lit twice and the lamp operation time is reset successfully.
- The projector doesn't turn on if the lamp cover isn't attached securely.
- Be sure to reset the lamp operation time whenever you replace the lamp.
- Do not reset the lamp operation time unless you replace the lamp.
- This projector uses a lamp that contains mercury. Disposal of the lamp or the projector with the lamp may be regulated due to environmental considerations. For disposal or recycling information, please contact your local authorities or the Electronic Industries Alliance: [www.eiae.org](http://www.eiae.org). (For the U.S. only.)

## Maintenance

### Caution:

Be sure to turn off the lamp and unplug the power cord from the wall outlet before you perform any maintenance on the projector.

### Cleaning of the projector and the ventilation slots

Use a soft cloth to clean the projector and the ventilation grilles. When the grilles become dirty, wipe them with a soft cloth dampened with diluted mild detergent, and then wipe them with a dry cloth.

To protect the surface of the projector from fading or deteriorating:

- Do not spray insecticide on or inside the projector.
- Do not use benzine or thinner to clean it.
- Do not let rubber or plastic materials contact with projector.

### Cleaning of the lens































Use a standard lens-cleaning brush or a piece of lens tissue dampened with lens cleaning fluid. The lens surface is fragile. Use only recommended, nonabrasive lens-cleaning materials. Do not touch the lens with your fingers.



# Troubleshooting

Before asking for repair of the projector, check the following. If the symptom persists, stop using the projector, be sure to unplug the power plug, and then contact your dealer.

## No image appears on the screen.

Problem	Solution																				
Power can not be turned on.	<ul style="list-style-type: none"> <li>Check whether the indicators are on or off and how they are lightning.</li> </ul> <table border="1"> <thead> <tr> <th>POWER</th> <th>STATUS</th> <th>Solution</th> </tr> </thead> <tbody> <tr> <td> Off</td> <td> Off</td> <td> <ul style="list-style-type: none"> <li>Connect the power cord to the projector.</li> <li>Plug the power cord into a wall outlet.</li> </ul> </td> </tr> <tr> <td rowspan="4"> Steady red</td> <td> Off</td> <td> <ul style="list-style-type: none"> <li>If any objects are blocking the air inlet or outlet grille, remove them and carry out the following.                             <ol style="list-style-type: none"> <li>Unplug the power cord from the wall outlet.</li> <li>Make sure that the projector has cooled off.</li> <li>Plug the power cord into the wall outlet.</li> <li>Press the POWER button.</li> </ol> </li> </ul> </td> </tr> <tr> <td> Blinking orange</td> <td> <ul style="list-style-type: none"> <li>If any objects are blocking the air inlet or outlet grille, remove them.</li> <li>Don't expose the air outlet grilles to hot air emitted from a heating appliance.</li> </ul> </td> </tr> <tr> <td> Blinking green</td> <td> <ul style="list-style-type: none"> <li>After the STATUS indicator stops blinking, press the POWER button.                             <ul style="list-style-type: none"> <li>If you unplug the power cord while the fan is rotating, the lamp may not turn on about one minute when you plug the power cord next time.</li> <li>The lamp can't turn on again for one minute after it goes out.</li> </ul> </li> <li>Press the POWER button several times.</li> </ul> </td> </tr> <tr> <td> Steady red</td> <td> <ul style="list-style-type: none"> <li>Replace the lamp. (The lamp is at the end of its life.)</li> </ul> </td> </tr> <tr> <td rowspan="2"> Blinking red / green</td> <td> Off</td> <td> <ul style="list-style-type: none"> <li>Attach the lamp cover on the bottom.</li> </ul> </td> </tr> <tr> <td> Steady or Blinking</td> <td> <ul style="list-style-type: none"> <li>Unplug the power cord from the wall outlet and contact your dealer.</li> </ul> </td> </tr> </tbody> </table>	POWER	STATUS	Solution	 Off	 Off	<ul style="list-style-type: none"> <li>Connect the power cord to the projector.</li> <li>Plug the power cord into a wall outlet.</li> </ul>	 Steady red	 Off	<ul style="list-style-type: none"> <li>If any objects are blocking the air inlet or outlet grille, remove them and carry out the following.                             <ol style="list-style-type: none"> <li>Unplug the power cord from the wall outlet.</li> <li>Make sure that the projector has cooled off.</li> <li>Plug the power cord into the wall outlet.</li> <li>Press the POWER button.</li> </ol> </li> </ul>	 Blinking orange	<ul style="list-style-type: none"> <li>If any objects are blocking the air inlet or outlet grille, remove them.</li> <li>Don't expose the air outlet grilles to hot air emitted from a heating appliance.</li> </ul>	 Blinking green	<ul style="list-style-type: none"> <li>After the STATUS indicator stops blinking, press the POWER button.                             <ul style="list-style-type: none"> <li>If you unplug the power cord while the fan is rotating, the lamp may not turn on about one minute when you plug the power cord next time.</li> <li>The lamp can't turn on again for one minute after it goes out.</li> </ul> </li> <li>Press the POWER button several times.</li> </ul>	 Steady red	<ul style="list-style-type: none"> <li>Replace the lamp. (The lamp is at the end of its life.)</li> </ul>	 Blinking red / green	 Off	<ul style="list-style-type: none"> <li>Attach the lamp cover on the bottom.</li> </ul>	 Steady or Blinking	<ul style="list-style-type: none"> <li>Unplug the power cord from the wall outlet and contact your dealer.</li> </ul>
POWER	STATUS	Solution																			
 Off	 Off	<ul style="list-style-type: none"> <li>Connect the power cord to the projector.</li> <li>Plug the power cord into a wall outlet.</li> </ul>																			
 Steady red	 Off	<ul style="list-style-type: none"> <li>If any objects are blocking the air inlet or outlet grille, remove them and carry out the following.                             <ol style="list-style-type: none"> <li>Unplug the power cord from the wall outlet.</li> <li>Make sure that the projector has cooled off.</li> <li>Plug the power cord into the wall outlet.</li> <li>Press the POWER button.</li> </ol> </li> </ul>																			
	 Blinking orange	<ul style="list-style-type: none"> <li>If any objects are blocking the air inlet or outlet grille, remove them.</li> <li>Don't expose the air outlet grilles to hot air emitted from a heating appliance.</li> </ul>																			
	 Blinking green	<ul style="list-style-type: none"> <li>After the STATUS indicator stops blinking, press the POWER button.                             <ul style="list-style-type: none"> <li>If you unplug the power cord while the fan is rotating, the lamp may not turn on about one minute when you plug the power cord next time.</li> <li>The lamp can't turn on again for one minute after it goes out.</li> </ul> </li> <li>Press the POWER button several times.</li> </ul>																			
	 Steady red	<ul style="list-style-type: none"> <li>Replace the lamp. (The lamp is at the end of its life.)</li> </ul>																			
 Blinking red / green	 Off	<ul style="list-style-type: none"> <li>Attach the lamp cover on the bottom.</li> </ul>																			
	 Steady or Blinking	<ul style="list-style-type: none"> <li>Unplug the power cord from the wall outlet and contact your dealer.</li> </ul>																			
No image appears on the screen.	<ul style="list-style-type: none"> <li>Check that the lens cap is removed.</li> <li>It may take about one minute for the lamp to light up.</li> <li>The lamp fails to light up on rare occasions. In such a case, wait for a few minutes and then try again.</li> <li>If the projector was turned off before the lamp was cooled down sufficiently last time, the fan may start rotating and the POWER button may not work after the power cord is plugged. After the fan stops rotating, press the POWER button to turn back on the POWER indicator.</li> <li>Check that the intake vent is clean.</li> <li>Check that the lamp cover is closed. (See Page 31.)</li> <li>Check that the cables connected to the external devices are not broken.</li> <li>When an extension cable is being used, replace it with the supplied cable for check. When images are displayed correctly, add an RGB signal amplifier to the extension cable.</li> </ul>																				
Projected images suddenly disappear.	<ul style="list-style-type: none"> <li>This problem may occur when the intake vent and/or exhaust vents are blocked. (In such a case, the STATUS indicator brinks orange.)             <ul style="list-style-type: none"> <li>Remove the objects blocking the intake vent and/or exhaust vents and then carry out the following procedure.                 <ol style="list-style-type: none"> <li>Wait for the intake fan and/or exhaust fan to stop. (Wait until the STATUS indicator goes out.)</li> <li>Unplug the power cord from the wall outlet.</li> <li>Wait about 10 minutes.</li> <li>Plug the power cord into the wall outlet.</li> <li>Press the POWER button.</li> </ol> </li> </ul> </li> <li>When the STATUS indicator is steady red, it is indicating that the lamp should be replaced. Replace the lamp in this case.</li> </ul>																				

**No image appears on the screen. (Continued)**

Problem	Solution
"NO SIGNAL" is displayed.	<ul style="list-style-type: none"> <li>• Turn on the power of the connected device, or check whether there is something wrong with the connected device.</li> <li>• Check whether the external device output signals. (Check this especially when the external device is a notebook computer.)</li> <li>• Check that the cable connected to the external device isn't defective.</li> <li>• Check that the projector is connected to the external device using the correct terminals.</li> <li>• Check that the connected device is correctly selected as the input source.</li> <li>• When an extension cord is being used, replace it with the supplied cable and check whether images are projected correctly. If images are projected correctly, use an RGB signal amplifier along with the extension cord.</li> </ul>

**Images are not displayed correctly.**

Problem	Solution
Projected images are shaking. Projected images are displaced.	<ul style="list-style-type: none"> <li>• Check that the cable connected to the external device isn't intermittent.</li> <li>• Connect the cable's plug with the external device's connector firmly.</li> <li>• Press the AUTO POSITION button.</li> <li>• Some computers output out-of-spec signals on rare occasion. Adjust the SIGNAL menu. (See page 26.)</li> </ul>
Projected images are distorted.	<ul style="list-style-type: none"> <li>• Adjust the projector and the screen so that they are perpendicular to each other. (See Page 11.)</li> </ul>
Projected images are dark.	<ul style="list-style-type: none"> <li>• Adjust BRIGHTNESS and CONTRAST in the IMAGE menu. (See Page 24.)</li> <li>• Replace the lamp. (See Page 30.)</li> </ul>
Projected images are blurred.	<ul style="list-style-type: none"> <li>• Adjust the focus. (See Pages 15 and 19.)</li> <li>• Clean the lens.</li> <li>• Press the ◀ or ▶ button on the remote control to eliminate flicker.</li> <li>• Adjust TRACKING and FINE SYNC. in the SIGNAL menu. (See Page 26.)</li> <li>• Adjust BRIGHTNESS and CONTRAST in the IMAGE menu. (See Page 24.)</li> <li>• Adjust the projector and the screen so that they are perpendicular to each other. (See Page 11.)</li> </ul>
White dots are seen on projected images. Black dots are seen on projected images.	<ul style="list-style-type: none"> <li>• This symptom is normal for a DLP™ projector and is not a malfunction. (A very small number of pixels may stay lit or out, but such symptom is not a malfunction. Pixels of 99.99% or more are effective.)</li> </ul>
Rainbow effect is seen on projected images.	<ul style="list-style-type: none"> <li>• This is due to color breaking noise that occurs in a DLP™ system and is not a malfunction.</li> </ul>
Fine streaks are seen on projected images.	<ul style="list-style-type: none"> <li>• This is due to interference with the screen surface and is not a malfunction. Replace the screen or displace the focus a little.</li> </ul>
Projected images become wavy.	<ul style="list-style-type: none"> <li>• Connect the plugs of the cables to external devices securely.</li> <li>• Keep the projector away from devices that emit interfering radio waves.</li> <li>• When the keystone adjustment is carried out, the image may not be displayed correctly depending on the type of input signal. This isn't a product malfunction. In this case, readjust the keystone so that the amount of keystone correction is as small as possible.</li> </ul>
Hue is not appropriate.	<ul style="list-style-type: none"> <li>• Check that the cables connected to the external devices are not broken.</li> </ul>
Tint in projected images is incorrect.	<ul style="list-style-type: none"> <li>• Check that COMPUTER INPUT in the SIGNAL menu is correctly set. (See page 23.)</li> <li>• Check that the cable connected to the external device isn't broken.</li> </ul>
Only the motion areas in the images supplied from the computer aren't displayed.	<ul style="list-style-type: none"> <li>• This is caused by the computer being used. Contact the manufacturer of your computer.</li> </ul>
Projected images are obscured.	<ul style="list-style-type: none"> <li>• Match the output resolution of your computer with the resolution of the projector. For the method to change the output resolution of the computer, contact the manufacturer of your computer. (See page 37.)</li> <li>• Some images and texts appear obscured during the keystone adjustment. In such cases, use the projector without applying the keystone adjustment. (See page 10.)</li> </ul>

## Troubleshooting (continued)

### Others

Problem	Solution
The exhaust vents emit warm air.	<ul style="list-style-type: none"><li>This air comes out after cooling the inside of the projector. You may feel hot, but this is not a malfunction.</li></ul>
The menu can't be used.	<ul style="list-style-type: none"><li>The microcomputers inside the projector may be wrongly operating because of noise. → Press the POWER button to turn off the lamp and unplug the power cord from the wall outlet. Wait about 10 minutes, plug the power cord in, and try again.</li></ul>
"TEMPERATURE!!" is displayed.	<ul style="list-style-type: none"><li>This indication appears when the ambient temperature rises high. When the ambient temperature stays high, the lamp goes out. → Eliminate any causes of the rise in the ambient temperature.</li><li>This indication appears when the air inlet or outlet grille is blocked. When they are kept blocked, the lamp goes out. → Remove the objects blocking the air inlet or outlet grille.</li></ul>
The  mark appears.	<ul style="list-style-type: none"><li>This mark appears when ineffective operation is carried out. This isn't a product malfunction.</li></ul>
The remote control doesn't function easily or at all.	<ul style="list-style-type: none"><li>Check that the batteries are loaded in the remote control or the batteries are not weak. (See page 6.)</li><li>Check that the remote control sensor isn't exposed to direct sunlight or fluorescent light. (See page 9.)</li><li>Use the remote control within its operation range. (See page 9.)</li><li>Use the remote control at least 10 cm away from the projector.</li></ul>
The buttons on the control panel (except for the POWER button) don't function.	<ul style="list-style-type: none"><li>The password function is working. → Cancel the password lock. (See page 27.)</li></ul>
Abnormal sound is heard.	<ul style="list-style-type: none"><li>Because the color wheel spins at a high speed, metallic sounds may be heard in rare occasions. Such symptom is not a malfunction.</li></ul>

If the following problem occurs after the lamp is replaced, check the following first.

Problem	Solution
The projector does not turn on.	<ul style="list-style-type: none"><li>Fit the lamp cover securely. (See Pages 30 and 31.)</li><li>Reset the lamp operating time. (See Page 31.)</li></ul>
The STATUS indicator blinks.	<ul style="list-style-type: none"><li>Reset the lamp operating time. (See Page 31.)</li></ul>

### Kensington Lock

This projector has a Kensington Security Standard connector for use with Kensington MicroSaver Security System. Refer to the information that came with the Kensington System for instructions on how to use it to secure the projector. Please contact Kensington Technology Group below.

Kensington Technology Group  
2855 Campus Drive  
San Mateo, CA 94403, U.S.A.

Phone : +1- (650)572-2700      Fax : +1- (650)572-9675

# Indicators

This projector has two indicators, each of which shows the operation condition of the projector. The following offer solutions to possible problems. If these problem persist, turn the projector off and consult your dealer.

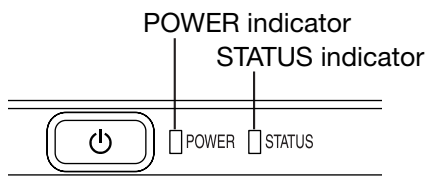

## Normal condition

POWER	STATUS	CONDITION	NOTE
Steady red	Off	Stand-by	
Steady green	Blinking green	Lamp stand-by (about 1 minute)	The POWER button cannot be used to switch between on and off.
Steady green	Steady green	The power is on. (Normal condition)	

## Abnormal condition

POWER	STATUS	CONDITION	POSSIBLE SOLUTION
Steady green or Steady red	Blinking orange	Abnormal temperature <ul style="list-style-type: none"> <li>The ventilation grilles are clogged with dust or dirt.</li> <li>The room temperature is high.</li> </ul>	<ul style="list-style-type: none"> <li>Clean the ventilation grilles.</li> <li>Relocate the projector to a cooler place.</li> </ul>
Steady red	Blinking green	The protection circuit is working or the lamp is in an abnormal condition.	<ul style="list-style-type: none"> <li>Wait until the STATUS indicator goes out, then press the POWER button.</li> <li>If the above solution is not effective, replace the lamp.</li> </ul>
Steady green	Blinking green/red	Lamp operation time warning. (Total lamp operation time reached 2250 hours <sup>*1</sup> while the power was on.)	Replace the lamp. Change with a new lamp if this problem recurs.
Steady red	Blinking red	Lamp operation time warning. (Total lamp operation time reached 2250 hours <sup>*1</sup> while the power was off.)	
Steady red	Steady red	Lamp operation time warning. (Total lamp operation time reached 3000 hours <sup>*1, *2</sup> while the power was off.)	
Blinking green/red	Off	The lamp cover isn't closed.	Close the cover correctly.
Blinking green/red	Steady or Blinking	Abnormal.	Contact your dealer.

\*1 Duration when LAMP MODE of the INSTALLATION menu is set to LOW. When it is set to STANDARD, this duration will be shorted.

\*2 Duration when LAMP MODE is set to STANDARD, this duration will be shorted up to 2000 hours.

# Specifications

The specifications and outside appearance of the projector are subject to change without prior notice.

Type	DLP™ projector		
Model	HC910		
Display Technology	0.65-inch Single chip DMD (Aspect ratio 16:9) Pixel 1024 x 576 = 589824 pixels		
Projection lens	F 2.4 - 2.6 f= 23 - 27.6 mm		
Light-source lamp	200 W		
Image size (Projection distance)	40" min. to 275" max. (Projection distance 1.3 to 10 m)		
Maximum number of display colors	16770000 (full-color display)		
Maximum resolution	Computer signal	Maximum resolution : 1280 x 1024 dots (Analog) / compressed Panel resolution : 1024 x 576 dots	
	Video signal	NTSC / PAL / SECAM / NTSC 4.43 / PAL-M / PAL-N / PAL-60	
	Component signal	480i, 480p, 576i, 576p, 720p, 1080i Panel resolution : 1024 x 576 dots	
Computer input	[Signal type]	[Terminal type]	[Line]
	Analog RGB	D-SUB 15P	1
	Digital RGB	DVI	1
Video input	[Signal type]	[Terminal type]	[Line]
	Video input	RCA	1
	S-Video input	S	1
	Component video input	RCA	1
Control terminal/Others	RS-232C (8-pin)		
Operating temperatures	+41°F (+5°C) to +95°F (+35°C)		
Rated voltage	AC100 - 240V, 50/60Hz		
Power consumption	2.9 A		
Dimensions	310 mm (W) x 100 mm (H) x 245 mm (D) * Not included protrusion.		
Weight	2.9 kg		
Others	S-video input	Luminance signal : Vp-p=1.0 V 75Ω (negative sync) Chrominance signals : Vp-p=0.286 V 75Ω (burst signal)	
	Video input	Vp-p=1.0 V 75Ω (negative sync)	
	Component video input	YCbCr : Vp-p=1.0 V 75Ω (Y) (negative sync) Vp-p=0.7 V 75Ω (Cb, Cr)	
	Analog input	RGB : Vp-p=0.7 V 75Ω (negative sync) YCbCr : Vp-p=1.0 V (Y) (negative sync) Vp-p=0.7 V (Cb, Cr) HD/CS : TTL-level (negative or positive polarity) VD : TTL-level (negative or positive polarity)	
	Digital input (DVI)	DVI interface (TMDS single link)	

## Replacement part

### (Option / Not included in the box)

Spare lamp

VLT-HC910LP

**Specification of RGB signals in each computer mode of the projector**

Signal mode	Resolution (H x V)	Horizontal frequency (kHz)	Vertical frequency (Hz)	Normal mode (H x V)*1	Real mode (H x V)
TV60, 480i(525i)	—	15.73	59.94	1024 x 576	—
TV50, 576i(625i)	—	15.63	50.00	1024 x 576	—
1080i 60 (1125i 60)	—	33.75	60.00	1024 x 576	—
1080i 50 (1125i 50)	—	28.13	50.00	1024 x 576	—
480p (525p)	—	31.47	59.94	1024 x 576	—
576p (625p)	—	31.25	50.00	1024 x 576	—
720p 60 (750p 60)	—	45.00	60.00	1024 x 576	—
720p 50 (750p 50)	—	37.50	50.00	1024 x 576	—
PC98	640 x 400	24.82	56.42	924 x 576	640 x 400
CGA70	640 x 400	31.47	70.09	924 x 576	640 x 400
CGA84	640 x 400	37.86	84.13	924 x 576	640 x 400
CGA85	640 x 400	37.86	85.08	924 x 576	640 x 400
VGA60	640 x 480	31.47	59.94	768 x 576	640 x 480
VGA72	640 x 480	37.86	72.81	768 x 576	640 x 480
VGA75	640 x 480	37.50	75.00	768 x 576	640 x 480
VGA85	640 x 480	43.27	85.01	768 x 576	640 x 480
SVGA56	800 x 600	35.16	56.25	768 x 576	—
SVGA60	800 x 600	37.88	60.32	768 x 576	—
SVGA72	800 x 600	48.08	72.19	768 x 576	—
SVGA75	800 x 600	46.88	75.00	768 x 576	—
SVGA85	800 x 600	53.67	85.06	768 x 576	—
XGA43i	1024 x 768	35.52	86.96	768 x 576	—
XGA60	1024 x 768	48.36	60.00	768 x 576	—
XGA70	1024 x 768	56.48	70.07	768 x 576	—
XGA75	1024 x 768	60.02	75.03	768 x 576	—
XGA85	1024 x 768	68.68	85.00	768 x 576	—
MAC13	640 x 480	35.00	66.67	768 x 576	640 x 480
MAC16	832 x 624	49.72	74.55	768 x 576	—
MAC19	1024 x 768	60.24	75.02	768 x 576	—
HP75	1024 x 768	62.94	74.92	768 x 576	—
SXGA60	1280 x 1024	60.02	63.98	720 x 576	—

\*1 : When ASPECT in the FEATURE menu is set to AUTO.  
 \*2 : Available for the signal for DVI-D terminal.

**Important:**

- Some computers aren't compatible with the projector.
- The projector's maximum resolution is 1024 x 576 pixels. It may not display images of higher resolutions than 1024 x 576 correctly.
- If the resolution and frequency of your computer aren't shown on the table, find the compatible resolution and frequency by changing the resolution of your computer.

- Set COMPUTER INPUT in the SIGNAL menu to RGB when inputting the HDTV signal as RGB signal.
- In the case of XGA, the right side of the image may not appear. In this case, adjust TRACKING in the SIGNAL menu.
- TV60 and TV50 are equivalent to 480i and 576i respectively. When these signals are supplied to the VIDEO or S-VIDEO signal, the signal mode is indicated as TV60 or TV50. When they are supplied to the COMPONENT terminal, the signal mode is indicated as 480i or 576i.

### Connectors

**SERIAL (8-pin)**

Pin No.	Name	I/O
1	TXD	IN
2	—	—
3	—	—
4	GND	—
5	—	—
6	—	—
7	RXD	OUT
8	—	—

**COMPUTER IN / COMPONENT VIDEO IN (Mini D-SUB 15-pin)**

Pin No.	Spec.
1	R(RE D)/C <sub>r</sub>
2	G(GREEN)/Y
3	B(BLUE)/C <sub>b</sub>
4	GND
5	GND
6	GND
7	GND
8	GND
9	DDC 5V
10	GND
11	GND
12	DDC Data
13	HD/CS
14	VD
15	DDC Clock

**DVI-D (HDCP) (DVI-D 24-pin)**

PIN No.	SPEC	PIN No.	SPEC
1	DATA 2-	13	—
2	DATA 2+	14	+5V Power
3	DATA 2 Shield	15	Ground
4	—	16	Hot Plug Detect
5	—	17	DATA 0-
6	DDC Clock	18	DATA 0+
7	DDC Data	19	DATA 0 Shield
8	—	20	—
9	DATA 1-	21	—
10	DATA 1+	22	Clock Shield
11	DATA 1 Shield	23	Clock+
12	—	24	Clock-

# MITSUBISHI Projector Contact Information

## North America

MESCA (Mitsubishi Electric Sales Canada Inc.)  
<http://www.mitsubishielectric.ca>  
 Information Technologies Group, 4299 14th Avenue,  
 Markham, Ontario L3R 0J2, Canada  
**Sales & Technical Inquiries**  
 Phone :+1-(800) 450-6487  
 Fax :+1-(905) 475-7958  
 E-mail :projectors@mitsubishielectric.ca  
**Customer Care**  
 E-mail :support@mitsubishielectric.ca

MDEA (Mitsubishi Digital Electronics America, Inc.)  
 (Warranty Registration)  
<http://www.mitsubishi-presentations.com/>  
 Presentation Products Division, 9351 Jeronimo Road,  
 Irvine, CA 92618 U.S.A  
**Sales & Inquires**  
 Phone :+1(888) 307-0349 or +1(949)465-6000  
 E-mail :ppdinfo@mdea.com  
**Technical Inquires**  
 Phone :+1-(888) 307-0309  
 E-mail :TSUPPORT@mdea.com

## Europe

MEU-FRA (Mitsubishi Electric Europe B.V French Branch)  
 25, Boulevard des Bouvets 92 741, Nanterre CEDEX,  
 France  
**Sales Inquiries**  
 Phone :+33 (0)1 55-68-55-53  
 Fax :+33 (0)1 55-68-57-31  
**Technical Inquiries**  
 Phone :+33 (0)1 55-68-56-42  
 Fax :+33 (0)1 55-68-57-31

MEU-GER (Mitsubishi Electric Europe B.V. German Branch)  
<http://www.mitsubishi-evs.de/>  
 Gothaer Strasse 8, 40880 Ratingen, Germany  
**Sales Inquiries**  
 Phone :09180 - 939673  
 Fax :09180 - 939674  
**Technical Inquiries**  
 Phone :0049 - 2102 - 486 1330  
 Fax :0049 - 2102 - 486 1340

MEU-IR (Mitsubishi Electric Europe B.V. Irish Branch)  
<http://www.mitsubishi.ie/>  
 Westgate Business Park, Ballymount, Dublin 24, Ireland  
**Sales Inquiries**  
 Phone :+353-1-4198807  
 Fax :+353-1-4198890  
**Technical Inquiries**  
 Phone :+353-1-4198808  
 Fax :+353-1-4198895

MEU-IT (Mitsubishi Electric Europe B.V. Italian Branch)  
 Centro Direzionale Colleoni, Palazzo Persero-Ingresso 2,  
 Via Paracelso 12, 20041 Agrate Brianza, Italy  
**Sales & Technical Inquiries**  
 Phone :+39-(0)39-60531  
 Fax :+39-(0)39-6053214  
 E-mail :info.projector@it.mee.com

MEU-NL (Mitsubishi Electric Europe B.V. Benelux Branch)  
<http://www.mitsubishi.nl/LCD/ProdFrame.html>  
 Nijverheidsweg 23A, 3641 RP Mijdrecht, The Netherlands  
**Sales Inquiries**  
 Phone :+31-297-282461  
 Fax :+31-297-283936  
 E-mail :info@mitsubishi.nl  
**Technical Inquiries**  
 Phone :+31-297-282461  
 Fax :+31-297-283936  
 E-mail :info@mitsubishi.nl

Russia (Mitsubishi Electric Europe B.V Moscow  
 Representative Office)  
<http://www.mitsubishi-projector.ru/>  
 Moscow Representative Office, 52/5 Kosmodamianskaya  
 Nab., 115054, Moscow, Russia  
**Sales & Technical Inquiries**  
 Phone :+(7095) 721-2068  
 Fax :+(7095) 721-2071

MEU-SP (Mitsubishi Electric Europe B.V. Spanish Branch)  
<http://www.mitsubishielectric.es/>  
 Ctra. de Rubi, 76-80, 08173 Sant Cugat del Valles,  
 Barcelona, Spain  
**Sales Inquiries**  
 Phone :+34-93.565.31.54  
 Fax :+34-93.589.43.88  
 E-mail :mitsubishi.profesional@sp.mee.com  
**Technical Inquiries**  
 Phone :+34-93.586.27.51  
 Fax :+34-93.588.53.87  
 E-mail :mitsubishi.profesional@sp.mee.com

MEU-SWE (Mitsubishi Electric Europe B.V Scandinavian  
 Branch)  
 Hammarbacken 14, Box 750, S-19127, Sollentuna, Sweden  
**Sales Inquiries**  
 Phone :+46-(0)8-6251070  
 Fax :+46-(0)8-6251036  
**Technical Inquiries**  
 Phone :+46-(0)8-6251052  
 Fax :+46-(0)8-6251036

MEU-UK (Mitsubishi Electric Europe)  
<http://www.mitsubishi.co.uk/evs/>  
 Visual Information Systems Division, Travellers Lane,  
 Hatfield, Hertfordshire, AL10 8XB U.K.  
**Sales Inquiries**  
 Phone :+44 (1707) 278684  
 Fax :+44 (1707) 278541  
 E-mail :projector.info@meuk.mee.com  
**Technical Inquiries**  
 Phone :+44 (870) 606 5008  
 Fax :+44 (1506) 431927  
 E-mail :projector.info@meuk.mee.com

## Asia

CHINA (Mitsubishi Electric Air-Conditioning & Visual  
 Information Systems (Shanghai) Ltd.)  
 26/F., Oriental Center, 699 Nanjing Rd(W), Shanghai,  
 200041, China  
**Sales Inquiries**  
 Phone :+86(21) 5211-0882-3010  
 Fax :+86(21) 5211-0576  
**Technical Inquiries**  
 Phone :+86(21) 5211-0882-3018  
 Fax :+86(21) 5211-0576

HONG KONG (Mitsubishi Electric Ryoden Air-Conditioning  
 & Visual Information Systems (HongKong) Ltd.)  
 7th Floor, Manulife Tower, 169 Electric Road, North Point,  
 Hong Kong  
**Sales Inquiries**  
 Phone :+852-2510-1505  
 Fax :+852-2510-0463  
**Technical Inquiries**  
 Phone :+852-2422-0161  
 Fax :+852-2487-0181

SINGAPORE (Mitsubishi Electric Asia Pte. Ltd.)  
<http://www.mitsubishielectric.com.sg>  
 307, Alexandra Road, #05-01/02 Mitsubishi Electric  
 Building, Singapore 159943  
**Sales Inquiries**  
 Phone :+65-6473-2308  
 Fax :+65-6475-9503  
 E-mail :Peripherals@asia.meap.com  
**Technical Inquiries**  
 Phone :+65-6470-2666  
 Fax :+65-6475-9503

INDIA (Mitsubishi Electric Asia Pte. Ltd.)  
 307, Alexandra Road, #05-01/02 Mitsubishi Electric  
 Building, Singapore 159943  
**Sales Inquiries**  
 Phone :+65-6473-2308  
 Fax :+65-6475-9503  
 E-mail :Peripherals@asia.meap.com  
**Technical Inquiries**  
 Phone :+65-6470-2666  
 Fax :+65-6475-9503

INDONESIA (Mitsubishi Electric Asia Pte. Ltd.)  
 307, Alexandra Road, #05-01/02 Mitsubishi Electric  
 Building, Singapore 159943  
**Sales Inquiries**  
 Phone :+65-6473-2308  
 Fax :+65-6475-9503  
 E-mail :Peripherals@asia.meap.com  
**Technical Inquiries**  
 Phone :+65-6470-2666  
 Fax :+65-6475-9503

PHILLIPINES (Mitsubishi Electric Asia Pte. Ltd.)  
<http://www.mitsubishielectric.com.sg>  
 307, Alexandra Road, #05-01/02 Mitsubishi Electric  
 Building, Singapore 159943  
**Sales Inquiries**  
 Phone :+65-6473-2308  
 Fax :+65-6475-9503  
 E-mail :Peripherals@asia.meap.com  
**Technical Inquiries**  
 Phone :+65-6470-2666  
 Fax :+65-6475-9503

VIETNAM (Mitsubishi Electric Asia Pte. Ltd.)  
 307, Alexandra Road, #05-01/02 Mitsubishi Electric  
 Building, Singapore 159943  
**Sales Inquiries**  
 Phone :+65-6473-2308  
 Fax :+65-6475-9503  
 E-mail :Peripherals@asia.meap.com  
**Technical Inquiries**  
 Phone :+65-6470-2666  
 Fax :+65-6475-9503

STC (Setsuyo Astec Corporation Seoul Branch)  
 4F,Dongseo Game Channel Bldg,660-11 Deungchon-Dong,  
 Kangseo-Ku, Seoul, Korea  
**Sales & Technical Inquiries**  
 Phone :+82-(0)2-2657-9841-3  
 Fax :+82-(0)2-2657-9900

MALAYSIA (Antah Melco Sales & Services Sdn. Bhd.)  
 6, Jalan 13/6 46860 Petaling Jaya Selangor, Darul Ehsan,  
 Malaysia  
**Sales & Technical Inquiries**  
 Phone :+60-(0)3-79552088 (Ext. 203)  
 Fax :+60-(0)3-79563950/+60-(0)3-79582576  
**Technical & Service Inquiries**  
 Phone :+60-(0)3-79552088 (Ext. 106)  
 Fax :+60-(0)3-79563950/+60-(0)3-79582576

ME-TWN (Mitsubishi Electric Taiwan Co., Ltd.)  
<http://www.mitsubishi-kyw.co.th/>  
 11TH FL., 88 SEC. 6, CHUNG SHAN N. RD., TAIPEI, 111R.  
 O.C.  
**Sales & Technical Inquiries**  
 Phone :+886-2-2832-8255  
 Fax :+886-2-2833-9813

MKY (Mitsubishi Electric Kang Yong Watana Co., Ltd.)  
<http://www.mitsubishi-kyw.co.th/>  
 Road, Huamark Bangkok, Bangkok 10240, Thailand  
**Sales & Technical Inquiries**  
 Phone :+66-2-731-6841  
 Fax :+66-2-379-4763

## Oceania

ME-AUST (Mitsubishi Electric Australia)  
<http://www.mitsubishi-electric.com.au/prod.asp?prod=proj>  
 348 Victoria Road, Rydalmerne, N.S.W. 2116, Australia  
**Sales & Technical Inquiries**  
 Phone :+(612)9684-7777  
 Fax :+(612)9684-7208  
 E-mail :diamonddigital@meaust.meap.com  
**Technical Inquiries**  
 Phone :+(612)9684-7694  
 Fax :+(612)9684-7684  
 E-mail :service@meaust.meap.com

BDT (Black Diamond Technologies Ltd.)  
 (Warranty Registration) <http://www.bdt.co.nz/projectors/warranty.asp>  
 1 Parliament St, Lower Hutt, Wellington, New Zealand  
**Sales & Technical Inquiries**  
 Phone :+64-(0)4-560-9100  
 Fax :+64-(0)4-560-9133  
 E-mail :projectorsales@bdt.co.nz  
**Technical Inquiries**  
 Phone :+64-(0)4-560-9100  
 Fax :+64-(0)4-560-9133  
 E-mail :service@bdt.co.nz

Manufactured by Mitsubishi Electric Corporation  
 1 Zusho Baba, Nagaokakyo-City, Kyoto Japan

