



DLP™ PROJECTOR

MODEL

XD700U

WD720U

User Manual



XD700U

WD720U

This User Manual is important to you.
Please read it before using your projector.

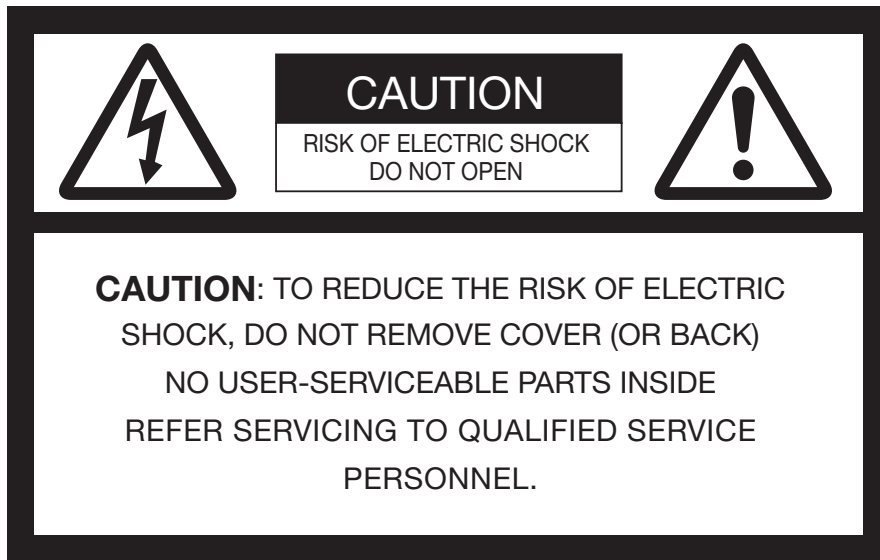

The lightning flash with arrowhead symbol within an equilateral triangle is intended to alert the user to the presence of uninsulated “dangerous voltage” within the product’s enclosure that may be of sufficient magnitude to constitute a risk of electric shock.



The exclamation point within an equilateral triangle is intended to alert the user to the presence of important operating and maintenance (servicing) instructions in the literature accompanying the appliance.

WARNING:

TO PREVENT FIRE OR SHOCK HAZARD, DO NOT EXPOSE THIS APPLIANCE TO RAIN OR MOISTURE.

CAUTION:

TO PREVENT ELECTRIC SHOCK, DO NOT USE THIS (POLARIZED) PLUG WITH AN EXTENSION CORD, RECEPTACLE OR OTHER OUTLET UNLESS THE BLADES CAN BE FULLY INSERTED TO PREVENT BLADE EXPOSURE.

NOTE:

SINCE THIS PROJECTOR IS PLUGGABLE EQUIPMENT, THE SOCKET-OUTLET SHALL BE INSTALLED NEAR THE EQUIPMENT AND SHALL BE EASILY ACCESSIBLE.

WARNING

Use the attached specified power supply cord. If you use another power supply cord, it may cause interference with radio and television reception.

CAUTION

The attached power cord is to be used exclusively for this product. Never use it for other products.

This apparatus must be grounded.

DO NOT LOOK DIRECTLY INTO THE LENS WHEN THE PROJECTOR IS IN THE POWER ON MODE.

Contents

Important safeguards	4
Overview	6
Remote control	8
Installation	9
Basic connections	12
Preparation	15
Basic operation	17
Menu operation	21
Image adjustment.....	31
Network settings	34
Advanced display utilities.....	39
Advanced features	47
Lamp replacement	51
Troubleshooting.....	53
Indicators.....	57
Specifications	58

Trademark, Registered trademark

- Macintosh is a registered trademark of Apple Inc.
- DLP™, Digital Micromirror Device, DMD, and BrilliantColor™ are all trademarks of Texas Instruments.
- HDMI, the HDMI logo and High-Definition Multimedia Interface are trademarks or registered trademarks of HDMI Licensing LLC.
- Microsoft, Windows, Windows 2000, Windows XP, Windows Vista, Windows 7, and Internet Explorer are registered trademarks, trademarks, or trade names of Microsoft Corporation in the U.S. and/or other countries.
- The trademark of PJLink is trademark applied for registration or registered trademark in Japan, the United States, and other countries and areas.
- Crestron RoomView Connected is a trademark of Crestron Electronics, Inc.
- Other brand or product names are trademarks or registered trademarks of their respective holders.

Important safeguards

Please read all these instructions regarding your projector and retain them for future reference. Follow all warnings and instructions marked on the projector.

1. Read instructions
All the safety and operating instructions should be read before the appliance is operated.
2. Retain instructions
The safety and operating instructions should be retained for future reference.
3. Warnings
All warnings on the appliance and in the operating instructions should be adhered to.
4. Instructions
All operating instructions must be followed.
5. Cleaning
Unplug this projector from the wall outlet before cleaning it. Do not use liquid aerosol cleaners. Use a damp soft cloth for cleaning.
6. Attachments and equipment
Never add any attachments and/or equipment without the approval of the manufacturer as such additions may result in the risk of fire, electric shock or other personal injury.
7. Water and moisture
Do not use this projector near water or in contact with water.
8. Accessories
Do not place this projector on an unstable cart, stand, tripod, bracket or table. Use only with a cart, stand, tripod bracket, or table recommended by the manufacturer or sold with the projector. Any mounting of the appliance should follow the manufacturer's instructions and should use a mounting accessory recommended by the manufacturer.



An appliance and cart combination should be moved with care. Quick stops, excessive force and uneven surfaces may cause the appliance and cart combination to overturn.

9. Ventilation
Slots and openings in the cabinet are provided for ventilation, ensuring reliable operation of the projector and to protect it from overheating. Do not block these openings or allow them to be blocked by placing the projector on a bed, sofa, rug, or bookcase. Ensure that there is adequate ventilation and that the manufacturer's instructions have been adhered to.
10. Power sources
This projector should be operated only from the type of power source indicated on the marking label. If you are not sure of the type of power, please consult your appliance dealer or local power company.
11. Power-cord protection
Power-supply cords should be routed so that they are not likely to be walked on or pinched by items placed upon or against them. Pay particular attention to cords at plugs, convenience receptacles, and points where they exit from the appliance. Do not put the power cord under a carpet.
12. Overloading
Do not overload wall outlets and extension cords as this can result in a fire or electric shock.
13. Objects and liquids
Never push objects of any kind through openings of this projector as they may touch dangerous voltage points or short-out parts that could result in a fire or electric shock. Never spill liquid of any kind on the projector.
14. Servicing
Do not attempt to service this projector by yourself. Refer all servicing to qualified service personnel.
15. Damage requiring service
Unplug this projector from the wall outlet and refer servicing to qualified service personnel under the following conditions:
 - (a) If the power-supply cord or plug is damaged.
 - (b) If liquid has been spilled, or objects have fallen into the projector.
 - (c) If the projector does not operate normally after you follow the operating instructions. Adjust only those controls that are covered by the operating instructions. An improper adjustment of other controls may result in damage and may often require extensive work by a qualified technician to restore the projector to its normal operation.
 - (d) If the projector has been exposed to rain or water.
 - (e) If the projector has been dropped or the cabinet has been damaged.
 - (f) If the projector exhibits a distinct change in performance - this indicates a need for service.
16. Replacement parts
When replacement parts are required, be sure that the service technician has used replacement parts specified by the manufacturer or parts having the same characteristics as the original part. Unauthorized substitutions may result in fire, electric shock or other hazards.
17. Safety check
Upon completion of any service or repair to this projector, ask the service technician to perform safety checks determining that the projector is in a safe operating condition.

Important safeguards (continued)

WARNING:

Unplug immediately if there is something wrong with your projector.

Do not operate if smoke, strange noise or odor comes out of your projector. It may cause fire or electric shock. In this case, unplug immediately and contact your dealer.

Never remove the cabinet.

This projector contains high voltage circuitry. An inadvertent contact may result in an electric shock. Except as specifically explained in User Manual, do not attempt to service this product by yourself. Please contact your dealer when you want to fix, adjust, or inspect the projector.

Do not modify this equipment.

It can lead to fire or electric shock.

Do not keep using the damaged projector.

If the projector is dropped and the cabinet is damaged, unplug the projector and contact your dealer for inspection. It may lead to fire if you keep using the damaged projector.

Be sure to unplug the power cord from the wall outlet if the projector is fractured or deformed.

Otherwise, it may result in fire or electric shock. Ask your dealer for repair.

Do not face the projector lens to the sun.

It can lead to fire.

Use correct voltage.

If you use incorrect voltage, it can lead to fire.

Do not place the projector on uneven surface.

Place the projection on a leveled and stable surface only.

Do not look into the lens when it is operating.

It may hurt your eyes. Never let children look into the lens when it is on.

Do not put any objects immediately in front of the lens while the lamp is on.

The lens and the objects get hot and can cause fire or breakdown.

Do not unplug the power cord during operation.

It can lead to lamp breakage, fire, electric shock or other trouble.

Do not touch the exhaust vents and bottom plate.

Do not touch them or put other equipment close to the exhaust vents because they become hot during operation. The heated exhaust vents and bottom plate may cause injury or damage to other equipment. Also, do not put the projector on a desk that is easily affected by heat.

Do not look into the exhaust vents when projector is operating.

Heat, dust, etc. may blow out of them and hurt your eyes.

Do not block the intake and exhaust vents.

If they are blocked, heat may be generated inside the projector, causing deterioration in the projector quality and fire.

Do not use flammable solvents (benzene, thinner, etc.) and flammable aerosols near the projector.

Flammable substances may ignite causing fire or breakdown because the temperature inside the projector rises very high while the lamp is illuminating.

Do not use the projector with condensation on it.
It can lead to breakdown or other failure.

Place of installation

For safety's sake, do not use the projector at any place subjected to high temperature and high humidity. Please maintain an operating temperature, humidity, and altitude as specified below.

- Operating temperature: between +41°F (+5°C) and +95°F (+35°C)
- Operating humidity: between 30% and 90%
- Never put any heat-producing device under the projector to prevent the projector from being overheated.
- Do not install the projector at a place that is unstable or subject to vibration.
- Do not install the projector near any equipment that produces a strong magnetic field. Also refrain from installing the projector near any cable carrying a large amount of current.
- Place the projector on a solid, vibration-free surface. Otherwise it may fall, causing serious injury or damage.
- Do not stand the projector on its end. It may fall, causing serious injury or damage.
- Slanting the projector more than $\pm 10^\circ$ (right and left) or $\pm 15^\circ$ (front and rear) may cause trouble or explosion of the lamp.
- Do not place the projector near air-conditioning unit, heater, or humidifier to avoid hot or moist air to the exhaust and ventilation hole of the projector.
- Do not place the projector in the following places. Otherwise, a short circuit, heat generation, or melting of the power cord coating may occur, causing fire, electric shock, product failure, or deformation.
 - Outdoors or non air-conditioned place
 - Place where a gas such as a hydrogen sulfide is generated (i.e. hot spring)
 - Place where there is too much salt such as near the coast
- Be sure to use this projector at an altitude of less than 1500 meters.

Do not place a container containing water or other liquid on the projector.

If water spills on or enters the projector, it may result in fire or electric shock.

Do not put any object that is heavy or larger than the outer frame on the projector.

Otherwise, the object may fall losing its balance and cause injury.

Do not subject the projector to strong shocks or vibrations. Do not handle the projector roughly.

The projector may be damaged, resulting in fire or electric shock.

When removing the lamp from the ceiling-mounted projector

Be sure to use the lamp replacement attachment designed specifically for this projector when replacing the lamp with a new one. Lamp fragments may fall from the inside if the lamp were broken.

Overview

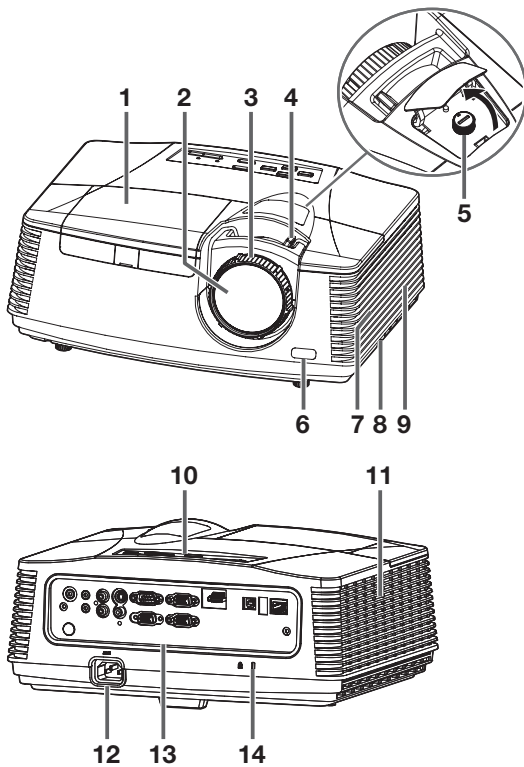

- 1 Lamp cover
- 2 Lens
- 3 FOCUS ring
- 4 ZOOM ring
- 5 LENS SHIFT dial
- 6 Remote control sensor (front)
- 7 Speaker
- 8 Lock bar
- 9 Intake vent
- 10 Control panel
- 11 Exhaust vent
- 12 Power jack
- 13 Terminal panel
- 14 Kensington Lock

Caution:

- Do not replace the lamp immediately after using the projector because the lamp would be extremely hot and it may cause burns.

Control panel

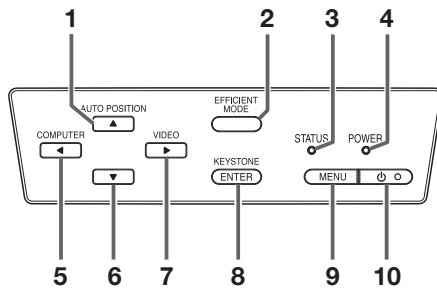

- 1 AUTO POSITION/▲ button
- 2 EFFICIENT MODE button
- 3 STATUS indicator
- 4 POWER indicator
- 5 COMPUTER/◀ button
- 6 ▼ button
- 7 VIDEO/▶ button
- 8 KEYSTONE/ENTER button
- 9 MENU button
- 10 POWER button (ON/STANDBY)

The status is changed between ON and STANDBY.

Terminal panel

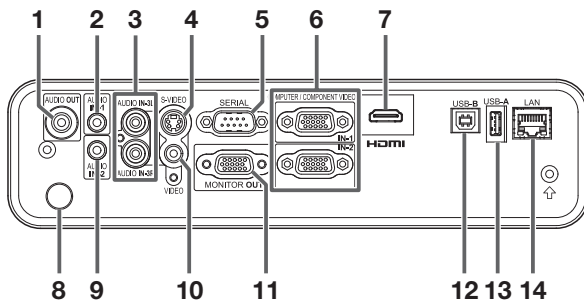

- 1 AUDIO OUT terminal (mini jack)
- 2 AUDIO IN-1 terminal (mini jack)
- 3 AUDIO IN-3 terminals (L, R)
- 4 S-VIDEO terminal
- 5 SERIAL (RS-232C) terminal (D-SUB 9-pin)
- 6 COMPUTER/COMPONENT VIDEO IN terminals (1, 2) (mini D-SUB 15-pin)
- 7 HDMI terminal (HDMI 19-pin)
- 8 Remote control sensor (rear)
- 9 AUDIO IN-2 terminal (mini jack)
- 10 VIDEO terminal
- 11 MONITOR OUT terminal (mini D-SUB 15-pin)
- 12 USB-B terminal
- 13 USB-A terminal
- 14 LAN terminal (RJ-45)

Overview (continued)

Bottom side

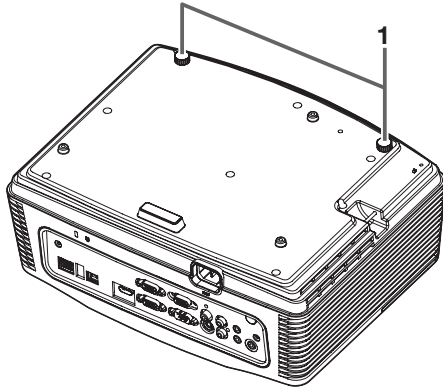

1 Adjustment feet

Remote control

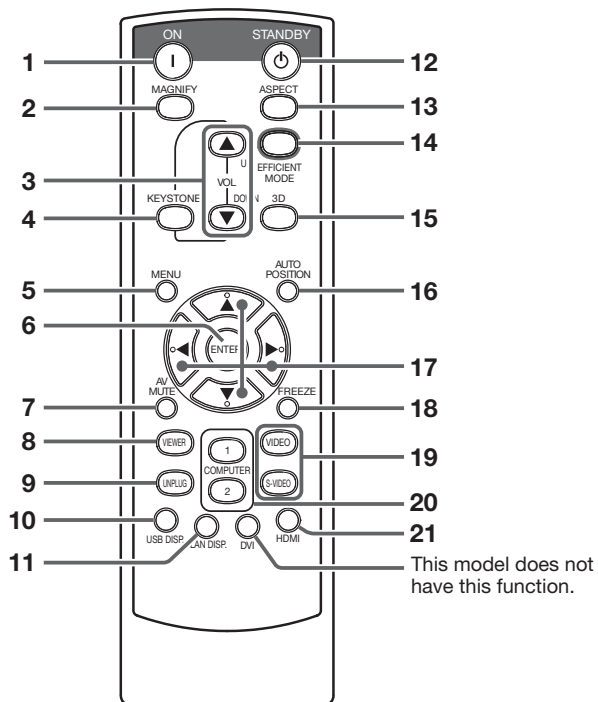

- 1 ON button
- 2 MAGNIFY button
- 3 VOLUME UP, DOWN buttons
- 4 KEYSTONE button
- 5 MENU button
- 6 ENTER button
- 7 AV (Audio/Video) MUTE button
- 8 VIEWER button
- 9 UNPLUG button
- 10 USB DISP. button
- 11 LAN DISP. button
- 12 STANDBY button
- 13 ASPECT button
- 14 EFFICIENT MODE button
- 15 3D button
- 16 AUTO POSITION button
- 17 ▲, ▼, ◀, ▶ buttons
- 18 FREEZE button
- 19 VIDEO, S-VIDEO buttons
- 20 COMPUTER (1, 2) buttons
- 21 HDMI button

Remote control

Battery installation

Use two (AA, R6) size batteries.

Inserting the batteries into the remote control

1. Remove the back cover of the remote control by pushing the battery compartment door in the direction of the arrow.
2. Load the batteries making sure that they are positioned correctly (+ to +, and - to -).
 - Load the batteries from - spring side, and make sure to set them tightly.
3. Replace the back cover.

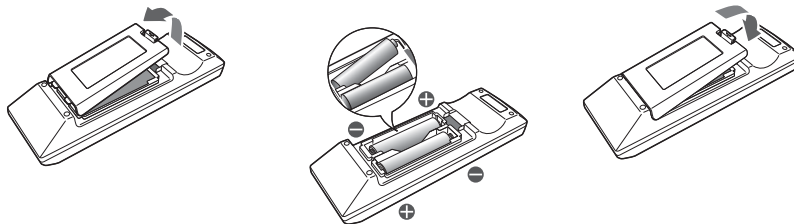

Removing the batteries from the remote control

Remove the back cover of the remote control and take out the batteries.

Caution:

- Use of a battery of wrong type may cause explosion.
- Only Carbon-Zinc or Alkaline-Manganese Dioxide type batteries should be used.
- Dispose of used batteries according to your local regulations.
- Before you dispose of the batteries, insulate them by placing insulation tape on the positive (+) and negative (-) terminals. If you dispose of the batteries together with other conductive objects such as a metal piece, they may short out, resulting in fire or explosion.
- Batteries may explode if misused. Do not recharge, disassemble, or heat the batteries, or put them into fire or water.
- Be sure to handle the batteries according to the instructions.
- Load the batteries with its positive (+) and negative (-) sides correctly oriented as indicated on the remote control.
- Keep batteries out of reach of children and pets. If children swallow the battery, see a doctor immediately.
- Remove the batteries, if the remote control is not used for a long time.
- Do not combine a new battery with an old one.
- If the solution of batteries comes in contact with your skin or clothes, rinse with water. If the solution comes in contact with your eyes, rinse them with water and then consult your doctor.
- Do not carry or store the batteries together with metallic ballpoint pens, necklaces, coins, or hairpins. Otherwise, they may short out, causing explosion or liquid leakage and resulting in fire or injury.
- Do not store the batteries where they are exposed to direct sunlight or subjected to high temperature and high humidity. High temperature and high humidity may cause corrosion or liquid leakage.

Operation range (of the remote control)

The maximum operation distance of the remote control is about 10 m (or about 32 feet) when the remote control is pointed at the remote control sensor of the projector. When the remote control is pointed to the screen, the distance from the remote control to the projector via the screen should be 5 m or less. However, the operation distance varies depending on the type of the screen used.

Reception angle (horizontal)

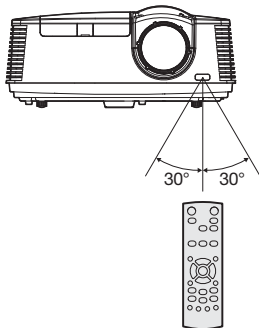

Reception angle (vertical)

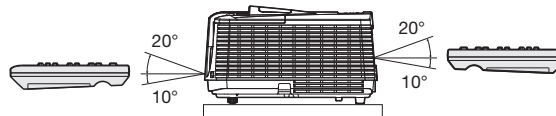

Reception angle (vertical), ceiling mount

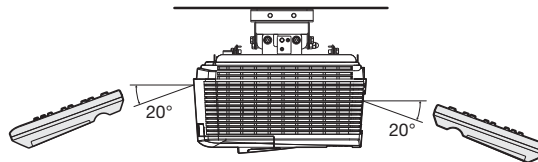

Important:

- Do not expose the remote control sensor to direct sunlight or fluorescent. Keep a distance at least 2 m (6.5 feet) between the remote control sensor and the fluorescent light to ensure correct operation of the remote control. Inverted fluorescent light, if located near the projector, may interfere the remote control.
- When you use the remote control too close to the remote control sensor, the remote control may not work correctly.

Installation

Screen size and projection distance

Refer to the following tables to determine the screen size and projection distance.

- The figures in the tables are approximate and may be slightly different from the actual measurements.
- The lens shift height shows distances from the factory default position.

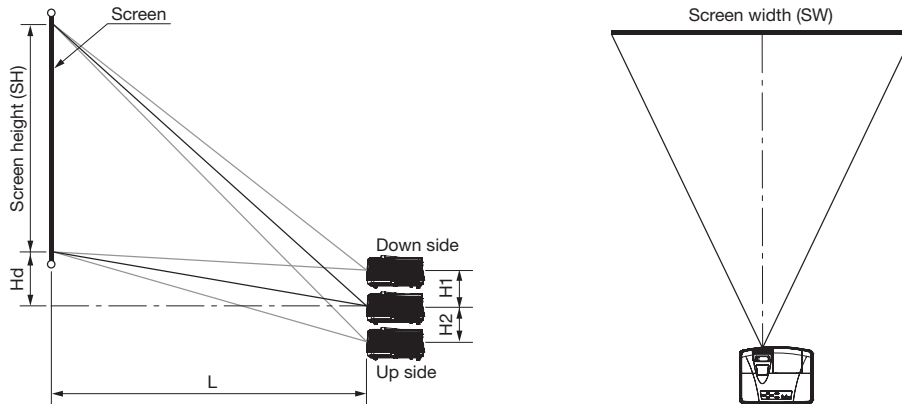

For XD700U:

Screen size (4:3)					Hd		Projection distance (L)				Lens shift height				
Diagonal size		Width (SW)		Height (SH)			Shortest (Wide)		Longest (Tele)		H1		H2		
inch	cm	inch	cm	inch	cm	inch	cm	inch	m	inch	m	inch	cm	inch	cm
40	102	32	81	24	61	3.6	9	45	1.1	67	1.7	3	7	2	4
60	152	48	122	36	91	5	14	68	1.7	102	2.6	4	10	2	6
80	203	64	163	48	122	7	18	91	2.3	137	3.5	5	14	3	8
100	254	80	203	60	152	9	23	115	2.9	171	4.3	7	17	4	10
120	305	96	244	72	183	11	27	138	3.5	206	5.2	8	20	5	13
150	381	120	305	90	229	14	34	173	4.4	258	6.5	10	25	6	16
200	508	160	406	120	305	18	46	231	5.9	344	8.7	13	34	8	21
250	635	200	508	150	381	23	57	289	7.3	-	-	17	42	10	26
300	762	240	610	180	457	27	69	348	8.8	-	-	20	51	12	31

For WD720U:

Screen size (16:10)					Hd		Projection distance (L)				Lens shift height				
Diagonal size		Width (SW)		Height (SH)			Shortest (Wide)		Longest (Tele)		H1		H2		
inch	cm	inch	cm	inch	cm	inch	cm	inch	m	inch	m	inch	cm	inch	cm
40	102	34	86	21	54	6.2	16	49	1.2	73	1.9	3	7	3	6
60	152	51	129	32	81	9	23	74	1.9	111	2.8	4	11	4	10
80	203	68	172	42	108	12	31	100	2.5	149	3.8	6	15	5	13
100	254	85	215	53	135	15	39	125	3.2	187	4.8	7	18	6	16
120	305	102	258	64	162	18	47	150	3.8	225	5.7	9	22	8	19
150	381	127	323	79	202	23	59	188	4.8	282	7.2	11	27	9	24
200	508	170	431	106	269	31	78	251	6.4	377	9.6	14	36	13	32
250	635	212	538	132	337	38	98	314	8.0	-	-	18	46	16	40
300	762	254	646	159	404	46	117	377	9.6	-	-	22	55	19	48

Installation (continued)

Screen size and projection distance (continued)

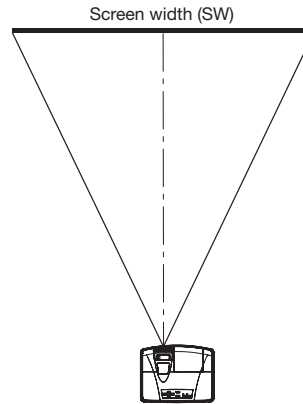
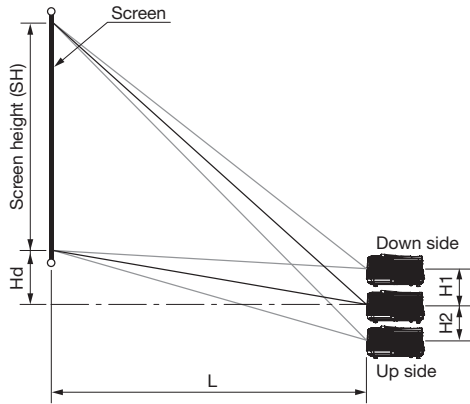

For WD720U: (continued)

When the aspect ratio of the screen is 4:3

When the aspect ratio of the screen is 4:3, the positional relation between the projected image and the screen is as shown on the right. Refer to the following table for installation.

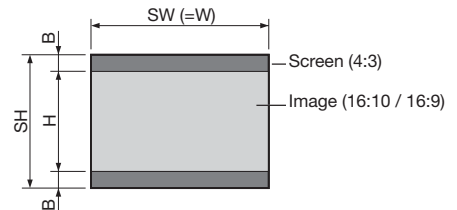

• When the aspect ratio of the image is 16:10 (WXGA)

Screen size (4:3)						Size of the projected image (16:10)						Black space (B)		Hd		Projection distance (L)				Lens shift height			
Diagonal size		Width (SW)		Height (SH)		Diagonal size		Width (W)		Height (H)						Shortest (Wide)		Longest (Tele)		H1		H2	
inch	cm	inch	cm	inch	cm	inch	cm	inch	cm	inch	cm	inch	cm	inch	cm	inch	m	inch	m	inch	cm	inch	cm
40	102	32	81	24	61	38	96	32	81	20	51	2	5	6	15	46	1.2	69	1.8	3	7	2	6
60	152	48	122	36	91	57	144	48	122	30	76	3	8	9	22	70	1.8	105	2.7	4	10	4	9
80	203	64	163	48	122	75	192	64	163	40	102	4	10	12	30	94	2.4	141	3.6	5	14	5	12
100	254	80	203	60	152	94	240	80	203	50	127	5	13	15	37	118	3.0	177	4.5	7	17	6	15
120	305	96	244	72	183	113	288	96	244	60	152	6	15	17	44	141	3.6	212	5.4	8	21	7	18
150	381	120	305	90	229	142	359	120	305	75	191	8	19	22	55	177	4.5	266	6.8	10	26	9	22
200	508	160	406	120	305	189	479	160	406	100	254	10	25	29	74	236	6.0	356	9.0	14	34	12	30
250	635	200	508	150	381	236	599	200	508	125	318	13	32	36	92	296	7.5	-	-	17	43	15	37
300	762	240	610	180	457	283	719	240	610	150	381	15	38	44	111	355	9.0	-	-	20	52	18	45

• When the aspect ratio of the image is 16:9

Screen size (4:3)						Size of the projected image (16:9)						Black space (B)		Hd		Projection distance (L)				Lens shift height			
Diagonal size		Width (SW)		Height (SH)		Diagonal size		Width (W)		Height (H)						Shortest (Wide)		Longest (Tele)		H1		H2	
inch	cm	inch	cm	inch	cm	inch	cm	inch	cm	inch	cm	inch	cm	inch	cm	inch	m	inch	m	inch	cm	inch	cm
40	102	32	81	24	61	37	93	32	81	18	46	3	8	7	17	45	1.1	67	1.7	2	6	2	5
60	152	48	122	36	91	55	140	48	122	27	69	5	11	10	26	68	1.7	102	2.6	4	9	3	8
80	203	64	163	48	122	73	187	64	163	36	91	6	15	14	35	91	2.3	137	3.5	5	12	4	11
100	254	80	203	60	152	92	233	80	203	45	114	8	19	17	43	114	2.9	172	4.4	6	15	5	13
120	305	96	244	72	183	110	280	96	244	54	137	9	23	20	52	138	3.5	207	5.2	7	19	6	16
150	381	120	305	90	229	138	350	120	305	68	171	11	29	26	65	172	4.4	259	6.6	9	23	8	20
200	508	160	406	120	305	184	466	160	406	90	229	15	38	34	86	230	5.8	346	8.8	12	31	11	27
250	635	200	508	150	381	229	583	200	508	113	286	19	48	43	108	288	7.3	-	-	15	39	13	34
300	762	240	610	180	457	275	699	240	610	135	343	23	57	51	130	346	8.8	-	-	18	46	16	40

Installation (continued)

Front projection, ceiling mounting

For ceiling mounting, you need the ceiling mount kit designed for this projector. Ask a specialist for installation. For details, consult your dealer.

- The warranty on this projector does not cover any damage caused by use of any non-recommended ceiling mount kit or installation of the ceiling mount kit in an improper location.

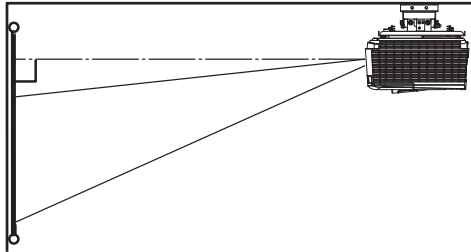

- When using the projector mounted on the ceiling, set Image Reverse in the Installation menu to Mirror Invert. See page 27.
- When the projector is mounted on the ceiling, images may appear darker than those projected in the case of tabletop mounting. This isn't a product malfunction.

Ceiling mount installation

If you wish to install the projector using a ceiling mount, please use the screw holes as the illustration shows.

Important:

- Screws are not included. Please obtain the appropriate screws for your type of ceiling. (M4 diameter)
- It is recommended that you keep a reasonable space between the bracket and the projector to allow for proper heat distribution.

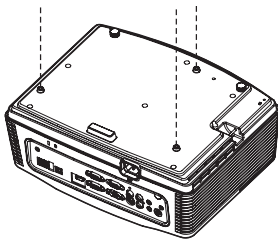

Caution:

- Installation must be done by a qualified professional. When the projector is installed on the ceiling using the ceiling mount kit, it is recommended to hold the mount kit and the projector using a metal bar or wire in addition to the mount kit fixing screws to prevent the projector from falling due to an earthquake or other cause. For that purpose, use a metal bar, wire, or screw that bears a load of at least 55 kgf. When using a metal wire, secure one end to a screw hole marked with an arrow on the rear terminal panel and the other end to the mount

kit. (Don't use screw holes without arrow marks.) In this case, make sure that the screw is inserted in the projector at least 5 mm. The length of the screw should be 20 mm or shorter. Also make sure that no electrical current is flowing in the mount kit due to current leakage or other cause.

Rear projection

Ask a specialist for installation. For details, consult your dealer.

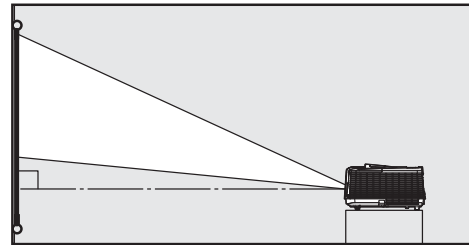

- For rear projection, set Image Reverse in the Installation menu to Mirror. See page 27.

Caution:

- Placing the projector directly on a carpet impairs ventilation by the fans, causing damage or failure. Put a hard board under the projector to facilitate ventilation.
- Place the projector at least 50 cm (or 20 inch) away from the wall to prevent the intake vents and the exhaust vents that emit hot air from being blocked.
- Do not use the projector in the following locations and manners, which may cause fire or electric shock.
 - In a dusty or humid place.
 - In a sideways or upside-down position.
 - Near a heater.
 - In an oily, smoky, or damp place such as a kitchen.
 - In direct sunlight.
 - Where the temperature rises high, such as in a closed car.
 - Where the temperature is lower than +41°F (or +5°C) or higher than +95°F (or +35°C).
- Keep foliage plants and pets away from the projector. The temperature around the exhaust vents and that of the cabinet on the top of the exhaust vents become high. Take special care for small children.

Important:

- Do not apply force to the lens, because the lens may be damaged.
- Be sure to use this projector at an altitude of less than 1500 meters.

Basic connections

This projector can be connected with various devices such as a VCR, video camera, videodisc player, and personal computer that have analog RGB output connectors.

Important:

- Make sure that the connected device is turned off before starting connection.
- Plug in the power cords of the projector and the connected devices firmly. When unplugging, hold and pull the plug. Do not pull the cord.
- When the projector and the connected devices are located too close to each other, the projected image may be affected by their interference.
- See the owner's guide of each device for details about its connections.

Projector + AV device

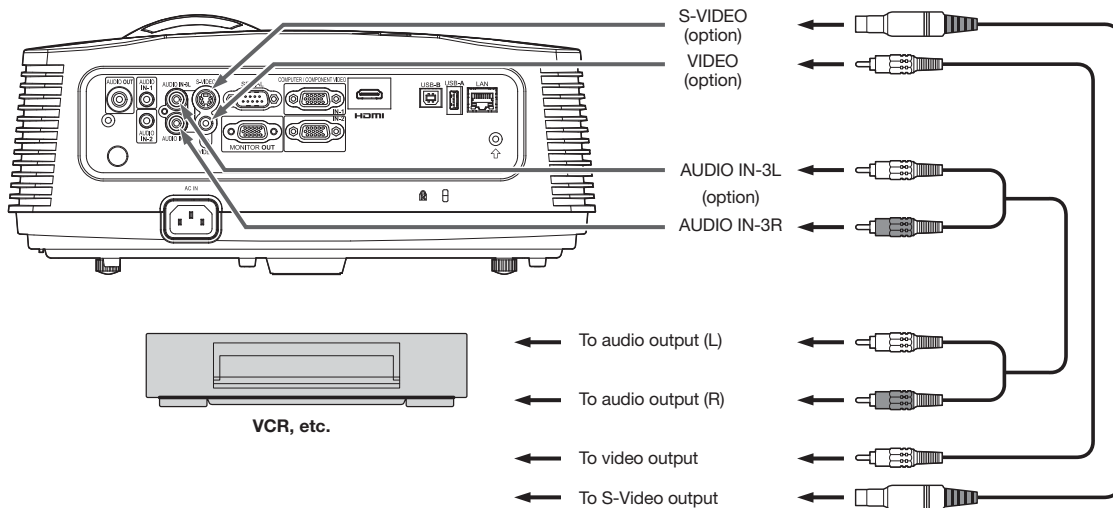

Important:

- Match the colors of the video and audio plugs on the Audio cable with those of the terminals.
- Speaker output is mono.

Projector + DVD player or HDTV decoder

Some DVD players have an output connector for 3-line fitting (Y, C_B, C_R). When connecting such DVD player with this projector, use the COMPUTER/COMPONENT VIDEO IN terminal.

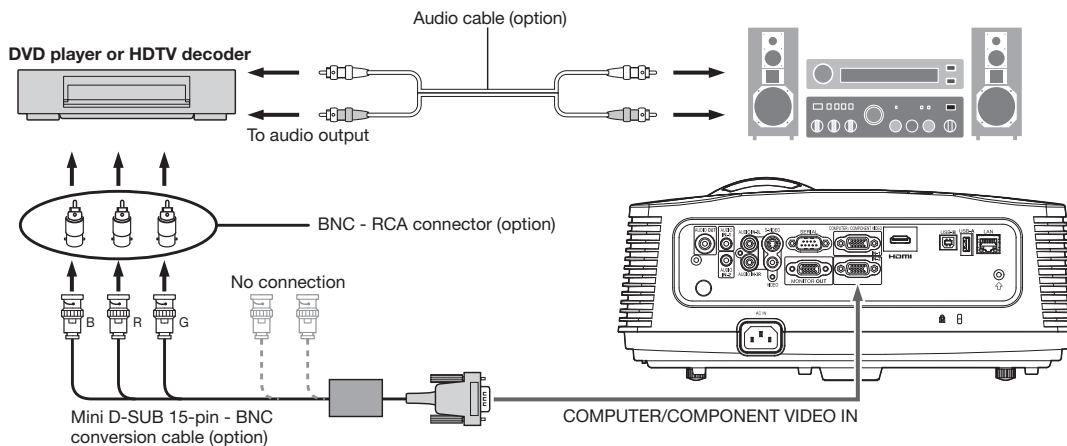

Important:

- The terminal's names Y, P_B, and P_R are given as examples of when a HDTV decoder is connected.
- The terminal's names vary depending on the connected devices.
- Use a mini D-SUB 15-pin - BNC conversion cable for connection.
- Image may not be projected correctly with some DVD players.
- When connecting a HDTV decoder having RGB output terminals, set Computer Input to RGB in the Signal menu.

Basic connections (continued)

Connection (for video equipment having an HDMI terminal)

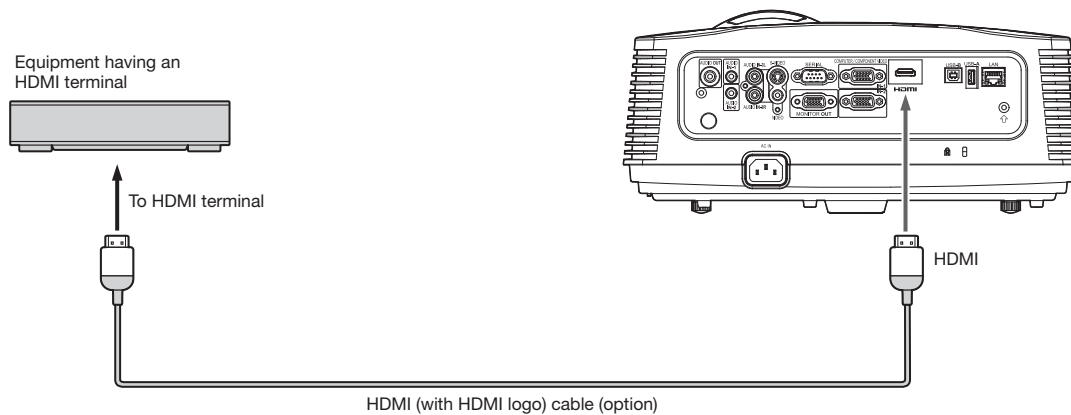

Important:

- Use a commercially available HDMI (with HDMI logo) cable.
- You don't have to connect any cable for audio input. You can input video and audio using an HDMI cable only.
- When HDMI audio isn't output, it may be output by turning off the power of the video equipment with the projector and the video equipment connected to each other and then turning back on the power.
- Some cables may not be connected correctly depending on the size and shape of their connectors.

When you connect this projector and a Digital device (such as a DVD player) via the HDMI terminal, black color may appear dark and deep, depending on the type of the connected device.

- This depends on the black level setting of the connected device. There are two kinds of methods to digitally transfer image data, in which different black level settings are employed respectively. Therefore, the specifications of the signals output from DVD players differ, depending on the type of the digital data transfer method they use.
- Some DVD players are provided with a function to switch the methods to output digital signals. When your DVD player is provided with such function, set it as follows.
EXPAND or ENHANCED → NORMAL
 - See the users guide of your DVD player for details.
- Set Input Level in the Picture menu depending on the device to be used.

Basic connections (continued)

Projector + Computer

For computer with mini D-SUB

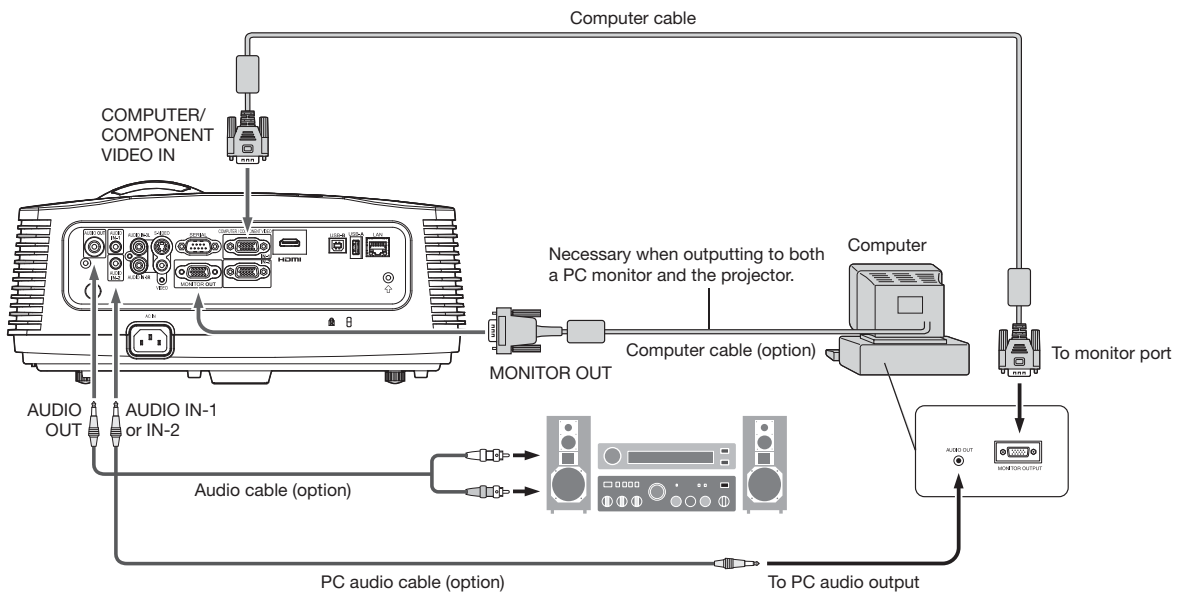

For analog connection:

1. Connect one end of the supplied computer cable to the COMPUTER/COMPONENT VIDEO IN terminal (1, 2) of the projector.
2. Connect the other end of the computer cable to the monitor port of the computer.

For monitor connection:

Connect the computer cable from the monitor to the MONITOR OUT terminal of the projector.

- Images may not be displayed correctly depending on the type of the input signal. See the instruction manual of the monitor.
- Signals are coming from the COMPUTER/COMPONENT VIDEO IN-1 terminal of the projector.
- When Standby Mode of the Efficient Mode menu in the Installation menu is set to Monitor Out, the MONITOR OUT terminal outputs signals during standby mode.

Important:

- When you use a longer computer cable instead of the provided cable, the image may not be projected correctly.
- Some computers require additional connectors or analog RGB output adapters to be connected with this projector. Contact your dealer for further information.
- This projector uses stereo mini jack for its audio input. Check the type of the audio output terminal of the connected computer and prepare a proper cable for connection. Some computers don't have the audio output terminal.
- Speaker output is mono.
- When the audio cable is connected to the AUDIO OUT terminal, the speaker output is muted.

For Macintosh

- If your Macintosh has no video port, a monitor output adapter is required. Contact your dealer for further information.
- Some Macintoshes require a MAC adapter for the computer cable for connection with this projector. Contact your dealer for further information.

About DDC

The COMPUTER/COMPONENT VIDEO IN-1 terminal of this projector complies with the DDC 1/2B standard. When a computer supporting this standard is connected to this terminal, the computer will automatically load the information from this projector and prepare for output of appropriate images.

- After connecting a computer supporting this standard to this terminal, plug the power cord of the projector in the wall outlet first, and then boot up the computer.

Preparation

Preparation for projection

1. Attach the provided power cord to the projector.
2. Plug the power cord in the wall outlet.
3. Remove the lens cap.

Warning:

- Do not look into the lens directly when the projector is on.
- The lens cap is for protecting the lens. If you leave the lens cap on the lens with the projector turned on, it may be deformed because of heat build-up. Remove the lens cap when you turn on the projector.
- One of power cords for the U.S., Europe, U.K., Australia, and South Korea is provided appropriately.
- This projector uses the power plug of three-pin grounding type. Do not remove the grounding pin from the power plug. If the power plug doesn't fit your wall outlet, ask an electrician to change the wall outlet.
- In case that the power cord for the U.S. is provided with this projector, never connect this cord to any outlet or power supply using other voltages or frequencies than rated. If you want to use a power supply using other voltage than rated, prepare an appropriate power cord separately.
- Use 100-240 V AC 50/60 Hz to prevent fire or electric shock.
- Do not place any objects on the power cord or do not place the projector near heat sources to prevent damage to the power cord. If the power cord should be damaged, contact your dealer for replacement because it may cause fire or electric shock.
- Do not modify or alter the power cord. If the power cord is modified or altered, it may cause fire or electric shock.

Caution:

- Plug in the power cord firmly. When unplugging, hold and pull the power plug, not the power cord.
- Do not plug in or out the power cord with your hand wet. It may cause electric shock.
- When you move the projector, turn off the power, unplug the power cord from the wall outlet, and then remove the connected cords. Otherwise, the power cord may be damaged, resulting in fire or electric shock.
- If dust or metallic substance is on or around the pins of the power plug, unplug the power cord and clean it using a dry cloth. If you continue to use the projector without cleaning, it may result in fire or electric shock. Clean the power plug periodically at least once a year.
- Be sure to unplug the power cord from the wall outlet if the projector will not be used for a long period of time. Otherwise, it may cause fire.

Important:

- When Standby Mode of the Efficient Mode menu in the Installation menu is set to LAN, Speaker Out, or Monitor Out, the fans rotate at very low speed during standby after plugging the power cord (with 5 second high speed rotation at the beginning) and after turning off the lamp. This is to cool down the projector operating various functions during standby and is not a malfunction. (When Standby Mode is set to Low, the fans stop during standby.)

Adjusting the position of the projected image

To adjust the position of the projected image on the screen, use the LENS SHIFT dial.

1. Rotate the LENS SHIFT dial inside the top cover of the projector to adjust the image position.
 - Rotating the dial clockwise (or counterclockwise for a ceiling-mount projector) moves the image up.
 - Rotating the dial counterclockwise (or clockwise for a ceiling-mount projector) moves the image down.
- Be careful not to be caught in the opening in the lens while the lens is moving.
- While the lens shift is working, the screen may flicker.
- Projected images may become distorted, have decreased resolution, or have shadows at their corners if they are positioned close to the top or bottom.

Preparation (continued)

Adjustment of the projection angle

For the best projection, project images on a flat screen installed at 90 degrees to the floor. If necessary, tilt the projector using the two adjustment feet on the bottom of the projector.

Using the adjustment feet (front)

1. Tilt up the projector to the appropriate angle.
2. Rotate the adjustment feet (front) for fine adjustment.

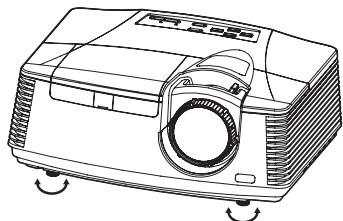

Important:

- Install the screen on a flat wall at 90 degrees to the floor.
- Slanting the projector more than $\pm 10^\circ$ (right and left) or $\pm 15^\circ$ (front and rear) may cause trouble or explosion of the lamp. You can tilt the projector up to 8 degrees using the adjustment feet only.
- Images may not be projected in a shape of a regular rectangle or with its aspect ratio 4:3, depending on the installation conditions of the projector and the screen.

When projected images are distorted to a trapezoid

When Auto Keystone in the Installation menu is set to On, this projector automatically corrects vertical keystone distortion. For fine adjustment, press the KEYSTONE button on the projector or the remote control to display Keystone, and adjust the image by pressing the \blacktriangle , \blacktriangledown button (or VOLUME \blacktriangle , \blacktriangledown button on the remote control).

In the following cases:



Press the \blacktriangledown button.



Press the \blacktriangle button.

- In the keystone adjustment, you can obtain an optimum result when the LENS SHIFT dial is at the factory default position. (See page 9.)
- The automatic keystone adjustment may not be carried out correctly because of the ambient temperature and the installation conditions of the projector and the screen. In such cases, correct the keystone manually.
- When the projector is projecting images where acceleration is present, such as in a vehicle and aircraft, the automatic keystone adjustment may not function correctly. In such a case, set Auto Keystone in the Installation menu to Off and correct the keystone manually.

- You can correct the vertical keystones. However, their adjustment ranges are limited in such correction.

Important:

- When the keystone adjustment is carried out, the adjustment value is indicated. Note that this value doesn't mean a projection angle.
- The allowable range of the adjustment value in the keystone adjustment varies depending on the installation condition, input signal and aspect settings in MENU.
- When the keystone adjustment takes effect, the resolution decreases. In addition, stripes may appear or straight lines may bend in images with complicated patterns. They are not due to product malfunctions.
- Noise may appear on the screen during the keystone adjustment because of the type of the video signal being projected and the setting values of the keystone adjustment. In such cases, set the keystone adjustment values in the range where the image is displayed without noise.
- When the keystone adjustment is carried out, the image may not be displayed correctly because of the type of input signal.

Basic operation

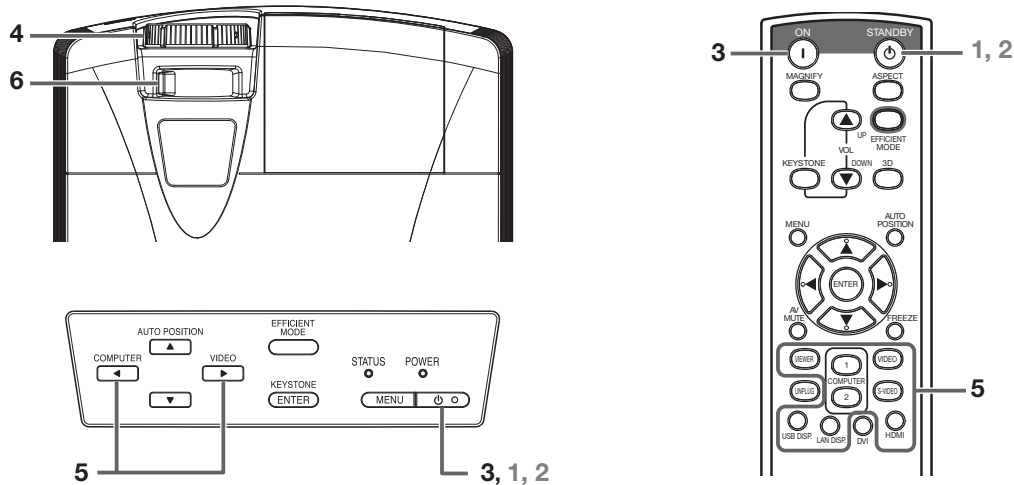

Power-on

1. Turn on the device connected to the projector first.
2. Plug the power cord in the wall outlet.
 - The POWER indicator lights up.
 - If the power cord is unplugged from the wall outlet before the projector is cooled down completely after use, the fans may start rotating when the power cord is plugged in next time and the POWER button may not function. In this case, wait for the fans to stop and press the POWER button to light the indicator.
3. Press the POWER button on the control panel or the ON button on the remote control.
 - It may take about one minute for the lamp to light up.
 - The lamp occasionally fails to light up. Wait a few minutes and try to light the lamp again.
 - After the POWER button is pressed, the image may flicker before the lamp becomes stable. This is not a product malfunction.
 - Regardless of the setting of Lamp Mode in the Installation menu, the Standard lamp mode is activated by default whenever the projector is turned on. The Lamp Mode is set to either Standard or Low depending on the setting last selected, and you cannot switch the Lamp Mode in about one minute after the lamp is on.

Indicator	STATUS	POWER
Condition		
Stand-by	-	Red
When the lamp is on.	Green	Green

Important:

- If the lamp exceptionally turned off due to the power interruption or voltage drop, it can happen that the lamp does not turn on even if you switch again the power supply on. In that case, please pull the electric cord out of the consent and put it again in the consent about 10 minutes later.
- Do not cover the lens with the lens cap while the lamp is on.

- The projector starts warming up when the POWER button is pressed. During the warm-up process, images may appear dark and no commands are accepted.
 - By blinking red, the STATUS indicator indicates that the lamp should be replaced soon. Replace the lamp when the STATUS indicator blinks red. (See page 53 and 57.)
 - Images may not be projected with good quality in an extremely hot or cold environment. (This is not a product malfunction.)
 - In order to ensure the safety in case of trouble with the projector, use an electrical outlet having an earth leakage breaker to supply the power to the projector. If you do not have such outlet, ask your dealer to install it.
4. Adjust the focus by turning the focus ring.
 5. Choose your desired external input source using the COMPUTER, HDMI, LAN DISP, USB DISP, VIEWER, VIDEO, or S-VIDEO button.
 - The input source is switched between Computer1, Computer2, HDMI, LAN Display, USB Display, and PC Less Presentation at every press of the COMPUTER button on the control panel.
 - The input source is switched between Video and S-Video at every press of the VIDEO button on the control panel.
 - When pressing the COMPUTER (1 or 2), HDMI, LAN DISP, USB DISP, VIEWER, VIDEO, or S-VIDEO button on the remote control, the input source switches directly as the button pressed.
 - You cannot change the input source while the menu is being displayed.
 - When Computer is chosen as the source, images supplied from the computer may flicker. Press the ◀ or ▶ button on the remote control to reduce flicker, if it occurs.
 - To avoid permanently imprinting a fixed image onto your projector, please do not display the same stationary images for long period.

Basic operation (continued)

- Adjust the image size by turning the zoom ring.
 - Adjust the vertical position of the displayed image by turning the LENS SHIFT dial.
- If necessary, adjust the focus and zoom again.

When fine streaks are seen on projected images

This is due to interference with the screen surface and is not a malfunction. Replace the screen or displace the focus a little.

Power-off

Use the following procedure to turn off the projector. The lamp may deteriorate if the projector is powered off and on repeatedly within 30 minutes after the lamp is lighted.

- Press the POWER button on the control panel or the STANDBY button on the remote control.
 - The message "Power Off? Press \cup again" appears on the screen.
 - To cancel, press any button except the POWER button.
(Some buttons on the remote control don't function for cancel.)
- Press the POWER button on the control panel or the STANDBY button on the remote control within 10 seconds again.
 - The lamp will go out and the STATUS indicator will start blinking.
- Wait about 90 seconds for the STATUS indicator to be turned off.
- Unplug the power cord.
 - The POWER indicator will go out.
 - If the power cord should be unplugged accidentally while either the STATUS indicator is blinking or the lamp is on, allow the projector to cool down for 10 minutes with the power off. To light the lamp again, press the POWER button (or ON button). If the lamp doesn't light up immediately, repeat pressing the POWER button (or ON button) two or three times. If it should still fail to light up, replace the lamp.

Important:

- When storing the projector in the carrying case, the lens should face up.
Before carrying the projector, rotate the focus ring and zoom ring to adjust the lens to the shortest. This prevents the possible damages of the lens.

Direct Power OFF

You can turn off this projector just by unplugging the power cord without pressing the POWER button.

- Don't shut down the projector while the STATUS indicator is blinking after the lamp lights up because the lamp's life may be shortened.
- Don't turn the projector back on right after shutting it down because the lamp's life may be shortened. (Wait about 10 minutes before turning the projector back on.)
- Before shutting down the projector, be sure to close the menu screen. If you shut down the projector without closing the menu, the setting data of the menu may not be saved.
- If you shut down the projector while controlling the projector using the network function, the application software such as ProjectorView may fail. For details, see "User Manual of LAN Control Utility" contained in the CD-ROM.

AUTO POSITION button

When the image isn't projected in the right position with Computer selected as the input source, follow the procedure below.

- Project a bright image such as the "Recycle Bin" window on the full screen.
- If the screen saver is running, turn it off.
- Press the AUTO POSITION button.
 - If the image is still not in the right position, adjust the image position using the Signal menu. See page 25.

Volume from the speaker

Press the VOLUME \blacktriangle or \blacktriangledown button to change the volume from the speaker.

The volume control bar will appear on the screen.



- The volume control bar will disappear about 10 seconds after the VOLUME button is released.
- The VOLUME buttons don't function while the menu is being displayed.
- When a high-level audio signal, such as a DVD audio signal, is supplied to the AUDIO IN terminal, the output from the speaker may be distorted.

You can change the volume also by using the Volume setting in the Audio menu.

(See page 22 for menu setting.)

- Display the Audio menu.
- Select Volume by pressing the \blacktriangle or \blacktriangledown button.
- Adjust the volume by pressing the \blacktriangleleft or \blacktriangleright button.
- Press the MENU button to exit the menu.

AV mute

The video and audio signals are temporarily muted when the AV MUTE button is pressed. To cancel muting, press the AV MUTE button again.

Basic operation (continued)

Setting the aspect ratio

You can change the aspect ratio of the input video signal (or the ratio of width to height of the image). Change the setting according to the type of the input video signal.

With the remote control:

1. Press the ASPECT button.
 - Every time the ASPECT button is pressed, the aspect mode changes from Normal to 16:9, to Full, and back to Normal.

With the Picture menu:

(See page 22 for menu setting.)

1. Display the Picture menu.
2. Select Aspect Ratio by pressing the ▲ or ▼ button.



3. Select your desired aspect ratio by pressing the ◀ or ▶ button.

When 16:9 is selected. (For XD700U only)

4. Press the ENTER button.
5. Select your desired position (Center, Upper or Lower) by pressing the ◀ or ▶ button.

To cancel the menu:

6. Press the MENU button.

Important:

- When a 16:9 image is kept displayed for a long time before displaying 4:3 image, the afterimages of the black bars may appear on the 4:3 image screen. Consult your dealer in this case.

Caution:

- The lamp can't be lit again for one minute after turned off for safety purpose. It will take another one minute for the STATUS indicator to go out. If you want to turn on the projector again, wait until the indicator goes out, and then press the POWER button.
- The exhaust fans rotate faster as the temperature around the projector rises.
- When the temperature around the projector rises high, the sign "Temperature!!" blinks red on the screen. If the temperature stays high, the lamp will go out automatically.

Important:

- Do not display a still picture for a long time because the afterimages may persist on the screen.

When connecting to a laptop computer:

When this projector is connected to a laptop computer, there may be times when images may not be projected. When it occurs, set the computer so that it can output signals externally. The procedure varies across computers in use. See the instruction manual of your computer.

Watching 3D content

You can enjoy 3D content with this projector.

In order to watch 3D content, you need to have the following items:

- Field-sequential 3D video contents
- DLP™ Link™ active 3D glasses

(Field-sequential: The system which displays alternately the image for the left eye and the right eye.)

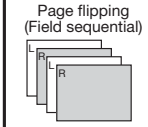
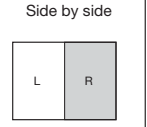
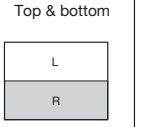
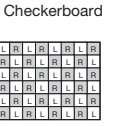
3D image Format			
			
Supported	Not supported	Not supported	Not supported

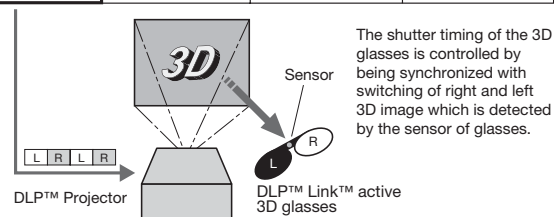

Play the field-sequential 3D video contents on a computer or DVD player, and then, connect the cable with the projector.

Go to the Picture menu (or press the 3D button on the remote control) and set the 3D option to On. (See page 23.)

Put on the 3D glasses to watch the contents.

If the contents are not projected correctly, go to the Picture menu, and switch the 3D Sync Invert option to On.

Important:

- You cannot project the 3D content from the input source LAN Display, USB Display, and PC Less Presentation.
- If the viewing distance is nearer than the recommended distance, it will cause physical discomfort and eye fatigue.
- Watch the contents in front of the screen, not at big angle. If you are viewing the screen at big angle, you may not be able to view 3D contents correctly.
- If you are not viewing 3D contents correctly, check to see if the 3D glasses are powered on or adequately charged. See the instruction manual of the 3D glasses for more information.
- There are personal differences in viewing the 3D images. For persons with myopia, hypermetropia, astigmatism or left and right sights, please wear glasses to correct them then wear the 3D glasses.
- The picture seems misplaced at the start of projecting the 3D images, however, this is not a malfunction.
- With the 3D option set to On, contents displayed on the projector appear darker. It is normal and does not mean the projector is malfunctioning.

Basic operation (continued)

- The MAGNIFY mode cannot be used when viewing 3D contents on the projector.
- It may occur that the image may not be enough 3D image because setting such as fluorescent lighting may occur loss of synchronism of glasses.
- 3D image may not appear on the screen depending on the PC performance such as graphics board, memory, or CPU.
- The signals specified in the table on page 60 can be displayed with viewing 3D contents on the projector. If a different signal is inputted, the projector shows no 3D contents even with the 3D option set to On in the Picture menu.
- If DVD is run by 480p signals, 3D image may not be displayed correctly depending on the DVD player.
- When 3D image is projected on the screen in 120Hz or using certain type of playback software of PC, the image may not appear on the screen.
- When viewing the pictures that roll over and shake or many dynamic pictures, if you feel uncomfortable, please look at another place.
- When viewing contents with movements such as rotation, or horizontal or vertical oscillation, you may feel as if you are actually moving. If such a feeling results in discomfort, look away from the screen.
- When using the 3D glasses, be careful not to strike the screen or other people by mistake. As the images are in 3D, you may mistake the distance from the screen, causing to strike the screen which may result in injury. When using the 3D glasses, do not place breakable objects near the glasses. You may move by mistaking the 3D objects you are viewing as the real objects, causing damages to surrounding objects that may lead to injury.
- When using the 3D glasses, make sure your eyes are on an approximate horizontal level. If you suffer from myopia (short sightedness), hyperopia (far-sightedness), astigmatism, or have eyesight differences between the left and right eyes, please use corrective glasses or other such methods to correct your eyesight before putting on the 3D glasses.
- When you view the 3D images, keep a distance from the screen of about three times the effective height of the screen.

Caution:

Notes on danger to public health during watching 3D image

- Stop viewing the 3D image immediately if you feel tired, discomfort, or any other abnormality. It may cause you to feel unwell if continuing to watch the 3D image in such cases. Please take the necessary rest, do not continue watch the 3D image for a long time. Stop using the 3D glasses if you can clearly see double images when viewing 3D content. Prolonged use may cause eyesight fatigue.
- The following people need to refrain from use as with 2D image.
 - a photosensitive patient
 - a patient with heart disease
 - a person in poor physical condition
 - a sleepy person
 - a very tired person
 - a drunk person
 - children
- When watching 3D movies, take an appropriate break after watching a movie. When watching 3D content on interactive devices such as 3D games or computers, take an appropriate break every 30-60 minutes. Prolonged use may cause eyesight fatigue.
- When you feel uncomfortable, stop viewing 3D images and playing 3D games until you are restored. If necessary, consult a doctor. Also, stop driving a car until you are restored (for about 2 hours). The period to restore varies with the individual.
- As a guide, 3D glasses should not be used by children younger than 5 - 6 years old. As it is difficult to judge younger children's reactions to fatigue or discomfort, their physical condition may deteriorate suddenly. When this product is being used by a child, the parent or guardian should check to ensure that the child's eyes are not becoming tired.

Menu operation

You can make various settings using the displayed menus.

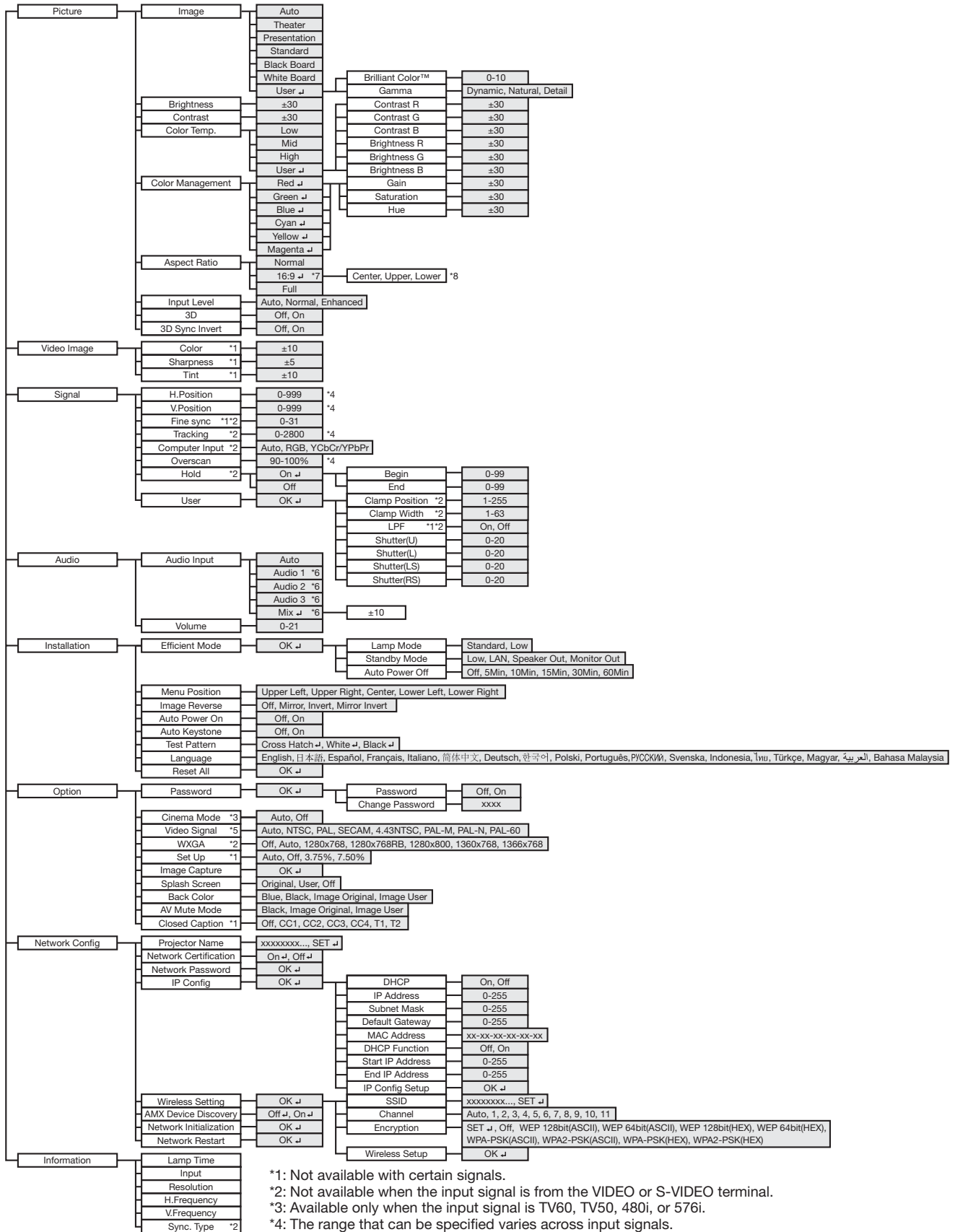

- *1: Not available with certain signals.
- *2: Not available when the input signal is from the VIDEO or S-VIDEO terminal.
- *3: Available only when the input signal is TV60, TV50, 480i, or 576i.
- *4: The range that can be specified varies across input signals.
- *5: Available only when the input signal is from the VIDEO or S-VIDEO terminal.
- *6: Audio 1, Audio 2, Audio 3, and Mix ↵ cannot be selected when the input source is HDMI input.
- *7: "↵" is not displayed and is not available in WD720U.
- *8: This function is not available in WD720U.

Menu operation (continued)

How to set the menus

1. Press the MENU button.
 - The Main Menu appears on the screen.

The item being selected is displayed in red letters on a blue background.

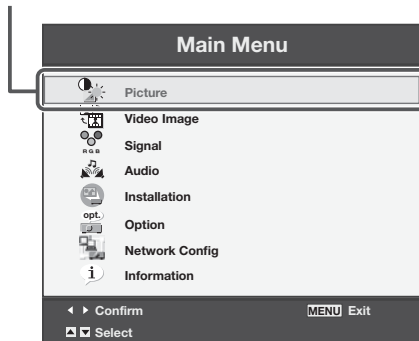

2. Press the ▲ or ▼ button to select a menu to use.

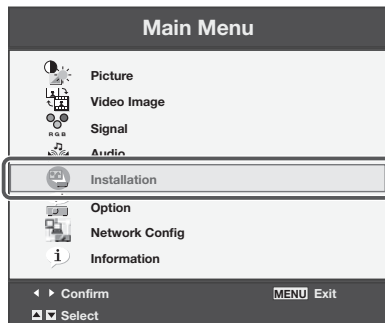

3. Press the ENTER button (or ► button).
 - The selected menu is displayed.

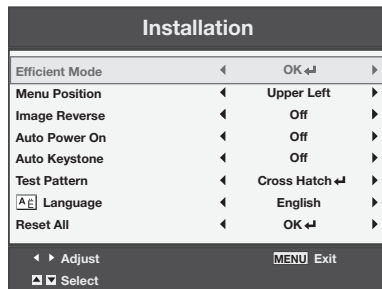

4. Press the ▲ or ▼ button to select an item to adjust.

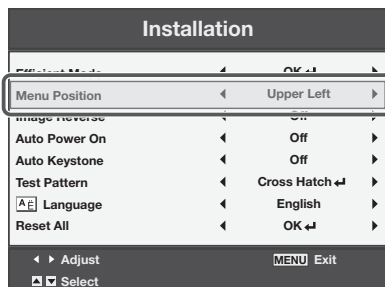

5. Set the selected item by pressing the ◀ or ▶ button.

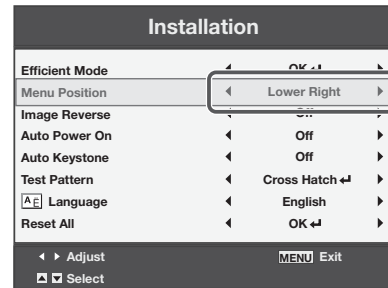

6. To cancel the menu, press the MENU button several times.

Important:

- When an item marked with “↵” is selected, pressing the ENTER button makes its value effective or displays another screen for further setting.
- When the MENU button doesn't function, unplug the power cord from the wall outlet. Wait about 10 minutes, plug the power cord in, and try again.
- The menus and screens shown in this manual may be different from those of the actual projector.

Menu operation (continued)

Menu items

Set the following items provided in the respective menus.

Picture menu

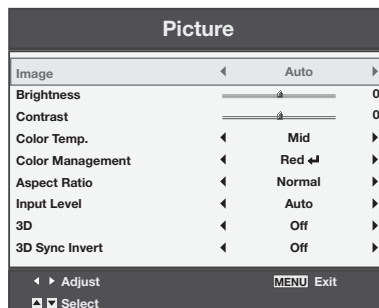

ITEM	SETTING	FUNCTION
Image	Auto	Automatically sets an optimal color balance based on the input signal. Use this setting for most cases.
	Theater	Makes projected images soft and smooth. Best suited for movies.
	Presentation	Makes projected images bright and crisp.
	Standard	Makes projected images look natural.
	Black Board	Reproduces natural color tones when images are projected directly onto a black board.
	White Board	Reproduces natural color tones when images are projected directly onto a white board.
	User ↵	Use to set Gamma or BrilliantColor™. (See page 32.)
Brightness	±30	Adjusts the brightness of projected images. (See page 31.)
Contrast	±30	Adjusts the contrast of projected images. (See page 31.)
Color Temp.	4 options	Adjusts the color temperature. (See page 31.)
Color Management	Red ↵ / Green ↵ / Blue ↵ / Cyan ↵ / Yellow ↵ / Magenta ↵	You can change to any desired color by adjusting each of Gain, Saturation and Hue of six different colors. (See page 32.)
Aspect Ratio	Normal	Automatically sets the aspect ratio in relative to the input signal. Use this setting for most cases.
	16:9 ↵	Select to expand squeezed (or horizontally compressed) images such as DVD images to 16:9. For XD700U only: Press the ENTER button to select the image display position within the screen from Center, Upper, and Lower.
	Full	Select this setting when you want to project images in the full screen.
Input Level	Auto / Normal / Enhanced	For HDMI signal input: Auto: The proper setting is automatically selected. Normal: Select when grayish black occurs. Enhanced: Select when solid black occurs. (See page 13.)
	3D	Set to On/Off of 3D display.
3D Sync Invert	Off / On	Switches the order of the image for left eye and for right eye.

- When Image is switched, projected images may be distorted.

Menu operation (continued)

Video Image menu



ITEM	SETTING	FUNCTION
Color	±10	Adjusts the color tone of projected images. (See page 31.) You cannot select this setting when the Computer1, Computer2, or HDMI is selected as the input source.
Sharpness	±5	Adjusts the sharpness of projected images. (See page 31.)
Tint	±10	Adjusts the color tint of projected images. (See page 31.) You can select this setting only when NTSC is selected as the input signal.

- You cannot adjust Tint when the TV50 (PAL, SECAM) signal is inputted.
- When Computer1, Computer2, or HDMI is selected, Tint does not work.

Menu operation (continued)

Signal menu

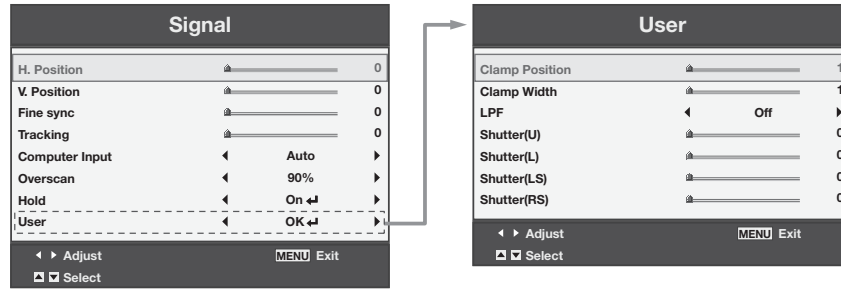

ITEM	SETTING	FUNCTION
H. Position	0-999	Select this setting to adjust the horizontal position of projected images.
V. Position	0-999	Select this setting to adjust the vertical position of projected images.
Fine sync	0-31	Select this setting to eliminate flickering or blurs, if they appear, when you are viewing projected images.
Tracking	0-2800	Select this setting to eliminate vertical wide stripes, if they appear, when you are viewing projected images.
Computer Input	Auto	Automatically sets the appropriate setting.
	RGB	Select this setting when you connect the projector to high definition video equipment having R, G, and B output terminals.
	YCbCr/YPbPr	Select this setting when you connect the projector to a DVD player or other device having Y, C _B , and C _R (or Y, P _B , and P _R) component video output terminals.
Overscan	100%-90%	Use this setting to adjust the display area of projected images.
Hold	Off / On ↵	Use this setting to adjust projected images when flagging occurs in the upper area of the screen.
User	OK ↵	The Signal-User menu is displayed for the following adjustments.
Clamp Position	1-255	Use this setting to correct solid white or solid black that appears in projected images.
Clamp Width	1-63	Use this setting to correct solid black that appears in projected images.
LPF	On / Off	Select this setting to enable or disable LPF.
Shutter(U)	0-20	Use this setting to adjust projected images when noise appears in the top part of the image.
Shutter(L)	0-20	Use to adjust the image when noise appears on the bottom part of the image.
Shutter(LS)	0-20	Use this setting to adjust projected images when noise appears in the left half of the image.
Shutter(RS)	0-20	Use this setting to adjust projected images when noise appears in the right half of the image.

- Horizontal strips may appear in the enlarged projected image, though these conditions are not a malfunction.
- When you change the value of the horizontal or vertical position drastically, noise may appear.
- The adjustable range of the vertical position varies depending on the type of the input signal. The image may be stationary even when the value is changed. These conditions are not a malfunction.
- Shutter does not work correctly during keystone adjustment.
- When you increase the value of Overscan, noise may appear on the screen.

Important:

- You can set the Picture, Signal, and Signal-User menus only when the signal is inputted.

Menu operation (continued)

Audio menu

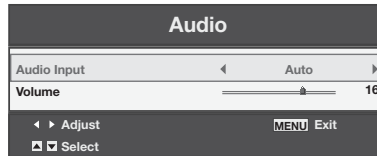

ITEM	SETTING	FUNCTION
Audio Input	Auto	Selects Audio 1 when the input source is Computer1, selects Audio 2 when the input source is Computer2, selects Audio 3 when the input source is Video/S-Video, and selects HDMI when the input source is HDMI.
	Audio 1 / Audio 2 / Audio 3	Selects audio input.
	Mix ↵	Selects mix signal of Audio 1 and Audio 2. You can change the balance of Audio 1/Audio 2 using Mix ↵.
Volume	0-21	Adjusts the volume of the audio from the speaker.

- In Audio Input, HDMI audio is selected when the input source is HDMI input. The audio of Audio 1, Audio 2, Audio 3, and Mix ↵ cannot be selected.

Menu operation (continued)

Installation menu

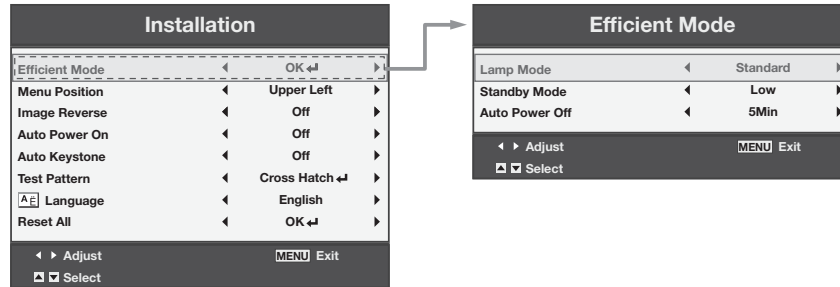

ITEM	SETTING	FUNCTION
Efficient Mode	OK ↵	Displays the Efficient Mode menu for the following settings.
Lamp Mode	Standard	Select this option when you want to view images in a well-lit room.
	Low	Select to moderate the intensity of the lamp. The operating sound is reduced and the lamp lifetime becomes longer. <ul style="list-style-type: none"> When this mode is switched, projected images may flicker. If this mode is frequently switched, the lamp may be deteriorated.
Standby Mode	Low	Select this option when you don't use the LAN control, speaker output and monitor output during power standby. This option disables them and reduces the power consumption during the power standby.
	LAN	Select this option when you control the projector via the LAN during power standby.
	Speaker Out	Select this option when you want to output audio from the speaker during power standby.
	Monitor Out	Select this option when you want to output video signal from the MONITOR OUT terminal in addition to the audio from the speaker during power standby.
Auto Power Off	Off / 5-60 Min	Selects a desired timer setting until the projector enters the standby mode when there is no signal input from the source.
Menu Position	5 options	Use this setting to change the position of the menu on the screen.
Image Reverse	Off	Select this setting when you want to view images from the front with the projector set on the floor.
	Mirror	Select this setting when you want to view images from behind the screen with the projector set on the floor.
	Invert	Select this setting when you want to view images from behind the screen with the projector set at the ceiling.
	Mirror Invert	Select this setting when you want to view images from the front with the projector set at the ceiling.
Auto Power On	Off / On	When this mode is set to On, the lamp is automatically lit when the power cord is plugged in the wall outlet. Select On when you set the projector at the ceiling. <ul style="list-style-type: none"> When the lamp is off, the projector is in standby. Use the remote control to turn on the lamp.
Auto Keystone	Off / On	Select Auto Keystone function.
Test Pattern	Cross Hatch ↵	Select to show the test cross hatch pattern.
	White ↵	Select to show the maximum brightness image.
	Black ↵	Select to show the minimum brightness image.
Language	18 languages	Selects a desired language for the menu.
Reset All	OK ↵	Resets all menu settings except for Password and Language to the default.

- You can display the Efficient Mode menu also by pressing the EFFICIENT MODE button.
- Regardless of the setting of Lamp Mode in the Installation menu, the Standard lamp mode is activated by default whenever the projector is turned on. The Lamp Mode is set to either Standard or Low depending on the setting last selected, and you cannot switch the Lamp Mode in about one minute after the lamp is on.
- When the Standby Mode is set to Speaker Out or Monitor Out, the audio selected with Audio Input in the Audio menu is output during standby mode. However, no audio is output when the last selected input was HDMI.
- During standby mode, you cannot change the audio input and the volume from the speaker.
- When Standby Mode is set to LAN, Speaker Out, or Monitor Out, the fans rotate at very low speed during standby after plugging the power cord (with 5 second high speed rotation at the beginning) and after turning off the lamp. This is to cool down the projector operating various functions during standby and is not a malfunction. When Standby Mode is set to Low, the fans stop during standby.
- To cancel the test pattern, press any button.

Menu operation (continued)

Option menu

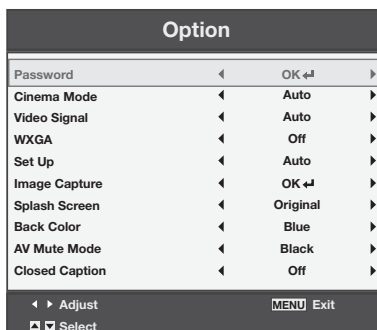

ITEM	SETTING	FUNCTION
Password	OK ↵	Use this setting to activate or deactivate the password lock.
Cinema Mode	Auto / Off	Select Auto to automatically activate the film mode when the input video signal is a video signal from a film.
Video Signal	8 options	Select Auto to automatically set the appropriate video format in relative to the input signal. If projected images aren't displayed correctly, select a desired video format manually.
WXGA	Off / Auto / 1280 x 768 / 1280 x 768RB / 1280 x 800 / 1360 x 768 / 1366 x 768	Select the appropriate format when the input signal is a WXGA video signal and the Auto mode does not display images properly. Select Off when the input signal is other than a WXGA video signal.
Set Up	Auto Off 3.75% / 7.50%	Select this setting to automatically change the Set Up mode. Select this setting to lower the density of black. Use this setting when images are dark. Select this setting to increase the density of black. <ul style="list-style-type: none"> When 7.50% is set, the brightness is decreased by the setup cancel function for the U.S.
Image Capture	OK ↵	Use to capture the screen for the splash screen. (See page 47.)
Splash Screen	Original User	Displays the original image for the splash screen when the projector is powered on. Displays the image captured for the splash screen when the projector is powered on.
Back Color	Off Blue / Black Image Original	Displays no splash screen when the projector is powered on. Displays blue or black background while no signal is inputted. Displays the original image for the splash screen while no signal is inputted.
AV Mute Mode	Image User Black Image Original	Displays the image captured for the splash screen while no signal is inputted. Displays black background when the AV MUTE button is pressed. Displays the original image for the splash screen when the AV MUTE button is pressed.
Closed Caption	Image User Off CC1 / CC2 / CC3 / CC4 / T1 / T2	Displays the image captured for the splash screen when the AV MUTE button is pressed. Does not display captions. Displays captions.

- You can select Cinema Mode only when the input signal is a TV60, TV50, 480i, or 576i video signal.
- Captions are not displayed while information about the menu, volume setting, or input signal selection is being displayed on the screen.
- The closed caption function displays text information included in the NTSC signal, which is mainly used for TV broadcasting in North America.

Menu operation (continued)

Network Config menu

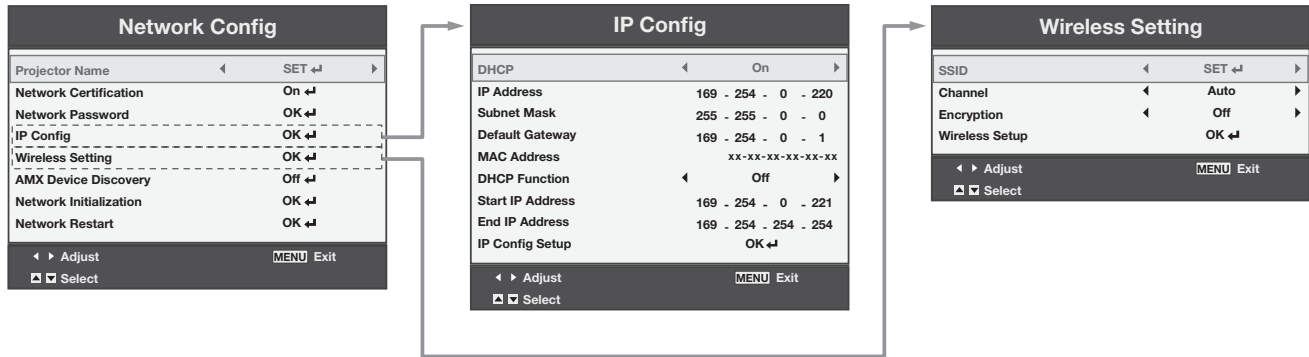

ITEM	SETTING	FUNCTION
Projector Name	xxxxxxx... SET ↵	Displays Projector Name. Displays Projector Name in blank when Projector Name is not set. Set Projector Name. Enter up to 15 character alphabets (capital/small), numeric characters, or marks.
Network Certification	On ↵ / Off ↵	Select whether to enable the network certification or not. Select On for normal use.
Network Password	OK ↵	Set the password for PJLink certification.
IP Config	OK ↵	Select this setting for IP Configuration. (See page 35.)
DHCP	On / Off	Use this setting when you obtain IP Config automatically by DHCP server.
IP Address	xxx-xxx-xxx-xxx	Displays IP Address.
Subnet Mask	xxx-xxx-xxx-xxx	Displays Subnet Mask.
Default Gateway	xxx-xxx-xxx-xxx	Displays Default Gateway.
MAC Address	xx-xx-xx-xx-xx-xx	Displays MAC Address.
DHCP Function	On / Off	Use this setting when the projector behaves as a DHCP server.
Start IP Address	xxx-xxx-xxx-xxx	Displays Start IP Address. However, Start IP Address is not set as factory default, and cannot be displayed.
End IP Address	xxx-xxx-xxx-xxx	Displays End IP Address. However, End IP Address is not set as factory default, and cannot be displayed.
IP Config Setup	OK ↵	Set the IP configuration.
Wireless Setting	OK ↵	Select this setting for wireless configuration.
SSID	xxxxxxx... SET ↵	Displays SSID. Set SSID. Enter up to 32 characters (alphabets or numeric characters).
Channel	Auto / 1 / 2 / 3 / 4 / 5 / 6 / 7 / 8 / 9 / 10 / 11	Select the wireless channel.
Encryption	SET ↵ / Off / WEP 128bit(ASCII) / WEP 64bit(ASCII) / WEP 128bit(HEX) / WEP 64bit(HEX) / WPA-PSK(ASCII) / WPA2-PSK(ASCII) / WPA-PSK(HEX) / WPA2-PSK(HEX)	Select the wireless encrypted communication.
Wireless Setup	OK ↵	Set the wireless configuration.
AMX Device Discovery	Off ↵ / On ↵	Use this setting when using an AMX controller.
Network Initialization	OK ↵	Initializes network setting.
Network Restart	OK ↵	Restarts network function.

Menu operation (continued)

Information menu

Information	
Lamp Time	2000H
Input	Computer1
Resolution	1024x768
H. Frequency	60.00 kHz
V. Frequency	60.00 Hz
Sync. Type	3Wire

MENU Exit

ITEM	DESCRIPTION
Lamp Time	This menu shows a lamp operating time (hour) calculated assuming that Lamp Mode is Low. <ul style="list-style-type: none">When the Lamp Mode is Standard, this menu shows a longer lamp operating time than the actual time. (See page 52 for the interval of lamp replacement.)
Input	Indicates the name of the terminal to which the currently projected video signal is being inputted.
Resolution	Indicates the resolution of the currently projected video signal.
H. Frequency	Indicates the horizontal frequency of the currently projected video signal.
V. Frequency	Indicates the vertical frequency of the currently projected video signal.
Sync. Type	Indicates the type of the sync signal for the currently projected video signal.

Image adjustment

To adjust the brightness (Contrast and Brightness):

You can make adjustments for the brightness of the projected image using the menu.
(See page 22 for menu setting.)

1. Display the Picture menu.
2. Select Contrast or Brightness by pressing the ▲ or ▼ button.
3. Adjust the selected item by pressing the ◀ or ▶ button.

To cancel the menu:

4. Press the MENU button.

Contrast

Select to adjust the contrast of the image. Every time the ▶ button is pressed, the image becomes brighter and more clearly defined. Every time the ◀ button is pressed, the image becomes darker and less clearly defined.

Brightness

Every time the ▶ button is pressed, the image becomes brighter. Every time the ◀ button is pressed, the image becomes darker.

To adjust the color (Color and Tint):

You can adjust the color of the projected image using the menu.

(See page 22 for menu setting.)

1. Display the Video Image menu.
2. Select Color or Tint by pressing the ▲ or ▼ button.
 - Color and Tint is selectable only when the input signal is Video.
 - Tint is selectable only when the NTSC or 4.43NTSC signal is inputted.
3. Adjust the selected item by pressing the ◀ or ▶ button.

To cancel the menu:

4. Press the MENU button.

Color

Use to adjust the color density of the projected image. Every time the ▶ button is pressed, the color becomes darker. Every time the ◀ button is pressed, the color becomes lighter.

Tint

Use to adjust the tint of the projected image. Every time the ▶ button is pressed, the image appears more greenish. Every time the ◀ button is pressed, the image appears more reddish.

To sharpen or soften the projected image (Sharpness):

You can adjust the sharpness of the projected image using the menu.

(See page 22 for menu setting.)

1. Display the Video Image menu.
2. Select Sharpness by pressing the ▲ or ▼ button.
3. Adjust the selected item by pressing the ◀ or ▶ button.

To cancel the menu:

4. Press the MENU button.

To adjust the tone of white (Color Temp.):

You can select a preset color temperature (white tone) using the menu.

(See page 22 for menu setting.)

1. Display the Picture menu.
2. Select Color Temp. by pressing the ▲ or ▼ button.
3. Select your desired color temperature by pressing the ◀ or ▶ button.

To cancel the menu:

4. Press the MENU button.

To adjust the tone of white (To customize the color temperature):

To set (and store) a user-defined color temperature, perform the following procedure.

(See page 22 for menu setting.)

1. Select Color Temp. in the Picture menu.
2. Press the ◀ or ▶ button to select User ↵.
3. Press the ENTER button.
 - The Color Temp. User menu appears.

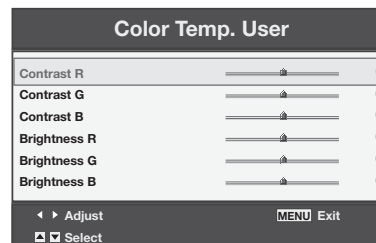

4. Press the ▲ or ▼ button to select the desired item.
5. Press the ◀ or ▶ button to adjust the selected item.
6. Repeat steps 4 and 5 for optimum adjustment results.

To cancel the menu:

7. Press the MENU button.

To enable the stored color temperature:

1. Set Color Temp. to User ↵ in the Picture menu.

About color temperature

There are different variations in white color. Color temperature is a way to show these variations in white. When the temperature is low, white appears reddish. When the temperature rises, white appears bluish. For example, you can change the temperature using the following procedures.

To raise the temperature: Increase Contrast B (blue) and decrease Contrast R (red).

To reduce the temperature: Decrease Contrast B (blue) and increase Contrast R (red).

- If you set Contrast R, G, and B to negative values, the brightness of the image can't retain the original even when you maximize the value of Contrast in the Picture menu.

Image adjustment (continued)

Image

You can set user-defined values for the brightness and hue using the menu. (See page 22 for menu setting.)

1. Display the Picture menu.
2. Select Image by pressing the ▲ or ▼ button.
3. Select User ↵ by pressing the ◀ or ▶ button.
4. Press the ENTER button.
 - The Image User menu appears.

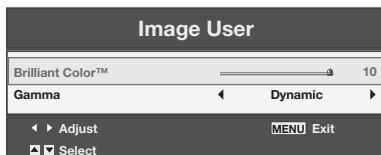

5. Select a setting you want to set.

Gamma

Use this setting to set an optimal gamma value and modulation of lamp power. The level of brightness can be adjusted for subdued colors.

- Dynamic Select when viewing crisp, clear images in a brightly lit room or strong daylight. The level of brightness is adjusted to higher levels.
- Natural Select when viewing images of which colors are more faithfully reproduced. The level of brightness and vividness is adjusted to optimal levels.
- Detail Select when viewing images of which brightness should be kept relatively low, such as movies and music video clips.

BrilliantColor™

Use this setting to make colors with medium brightness, such as yellow and the skin tone appear natural. Press the ◀ button to decrease the value to lessen the effect. Press the ▶ button to increase the value to heighten the effect. (BrilliantColor™ has no effect at value 0.)

6. Select a value by pressing the ◀ or ▶ button.
 - For more enhanced color reproduction, set BrilliantColor™ to 0. The white area of the color wheel is disabled, and you can reproduce true-color images.

Color Management

You can individually adjust the tone of red, green, blue, cyan, yellow and magenta using the menu.

1. Display the Picture menu.
2. Press the ▲ or ▼ button to select Color Management.
3. Press the ◀ or ▶ button to select a color to be adjusted: Red, Green, Blue, Cyan, Yellow or Magenta.
4. Press the ENTER button.
 - The Color Management menu for the selected color appears on the screen.

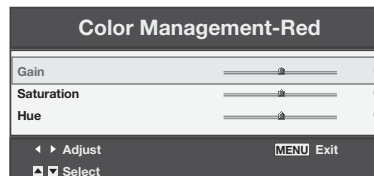

5. Press the ▲ or ▼ button to select an item to be adjusted: Gain, Saturation or Hue.
6. Press the ◀ or ▶ button to adjust the item.

To cancel the menu:

7. Press the MENU button.

Image adjustment (continued)

How to adjust the computer image

This projector automatically and properly projects video signals being inputted from the computer. However, some video signals may not be projected, depending on the type of the computer. When it occurs, press the AUTO POSITION button. (See page 18.) When the signal is still not projected properly, adjust the projected image using the Signal menu.

How to adjust the image supplied from the computer using the menu:

Perform the following procedures when the following conditions occur.

When wide strips appear.

..... Adjust Tracking in the Signal menu.

When the projected image flickers.

When the projected image is blurred.

..... Adjust Fine sync in the Signal menu.

When the projected image is displaced horizontally.

..... Adjust H.Position in the Signal menu. Every time the ◀ button is pressed, the image moves to the right. Every time the ▶ button is pressed, the image moves to the left.

When the projected image is displaced vertically.

..... Adjust V.Position in the Signal menu. Every time the ◀ button is pressed, the image moves down. Every time the ▶ button is pressed, the image moves up.

When the top part of the image flags.

..... Change the setting of Hold in the Signal menu. To select On ↵, press the ENTER button, and Adjust Begin or End to minimize the flagging.

A solid black or solid white appears in the image.

..... Adjust Clamp Position or Clamp Width in the Signal-User menu.

Noise appears in the right or left half of the image.

..... Adjust Shutter(LS) or Shutter(RS) in the Signal-User menu.

Noise appears in the top or bottom part of the image.

..... Adjust Shutter(U) or Shutter(L) in the Signal-User menu.

1. Display the Signal menu.
2. Press the ▲ or ▼ button to select a setting to adjust.
3. Adjust the selected setting by pressing the ◀ or ▶ button.

To cancel the menu:

4. Press the MENU button.
 - Do not change the settings of the Signal menu for ordinary use.

Simple method to adjust the image position

To adjust the horizontal position:

1. Align the left edge of the image with the left side of the screen by adjusting H.Position. Then, align the right edge of the image with the right side of the screen by adjusting Tracking.
2. Repeat step 1 to complete the adjustment of the horizontal position.

To adjust the vertical position:

3. Align the upper edge of the image with the upper side of the screen by adjusting V.Position.

LPF (Progressive filter)

You can select to enable or disable the LPF. This option is set to Off normally.

Vertical or horizontal streaks may appear in the projected image, depending on the type of the DVD player, game console or computer in use. If this occurs, reduce noise by enabling the LPF. Projected images appear slightly faint.

Network settings

You can set the network of the projector using the menu.

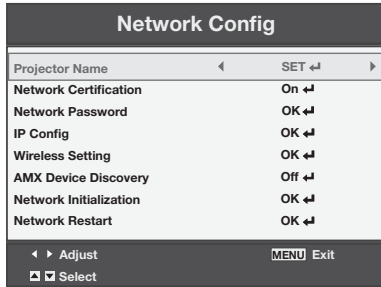

Setting Projector Name

(See page 22 for menu setting.)

1. Display the Network Config menu.
2. Press the ▲ or ▼ button to select Projector Name.



3. Press the ◀ or ▶ button to select SET.
4. Press the ENTER button.
 - The PROJECTOR NAME screen appears.

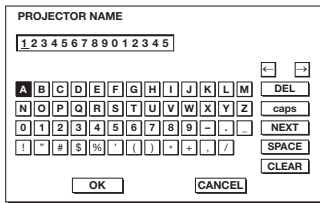

5. Press the ▲, ▼, ◀, and ▶ buttons to move the key cursor to select the characters or marks to enter, and press the ENTER button.

- Projector Name can be set using up to 15 characters including alphabets (capital/small), numeric characters, or marks.
 - ← key: Shifting the position of enter cursor to the left for each character.
 - key: Shifting the position of enter cursor to the right for each character.
 - DEL key: Deleting the character in the position of enter cursor for each character.
 - caps/CAPS key: Switching an alphabet character to CAPITAL or small.
 - NEXT/PREV key: Switching the marks listed on the fourth line.
 - SPACE key: Inserting a space in the position of enter cursor.
 - CLEAR key: Deleting all the entered characters.

6. Select OK to complete the setting with the name stored. Select CANCEL to complete the setting without storing.
 - The display returns to the Network Config menu after selecting OK or CANCEL.
 - It may take some time to reflect the setting.

Enabling or disabling the network certification

You can select whether or not to certify the network communication using the network password. (See page 22 for menu setting.)

1. Display the Network Config menu.
2. Press the ▲ or ▼ button to select Network Certification.

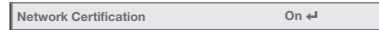

3. Press the ENTER button.
 - Certification dialog appears.



4. Press the ◀ or ▶ button to select ON or OFF.
5. Select the item to set, and press the ENTER button.
 - To cancel the setting, press the MENU button.
 - It may take some time to reflect the setting.

Network Password settings

(See page 22 for menu setting.)

1. Display the Network Config menu.
2. Press the ▲ or ▼ button to select Network Password.

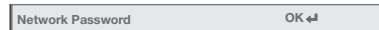

3. Press the ENTER button.
 - The CURRENT NETWORK PASSWORD screen appears.

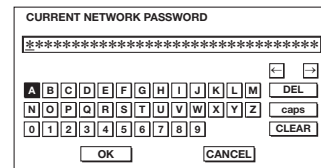

4. Press the ▲, ▼, ◀, and ▶ buttons to move the key cursor to select the characters or marks to enter, and press the ENTER button.

- Password can be set using up to 32 characters including alphabets (capital/small) or numeric characters.
 - ← key: Shifting the position of enter cursor to the left for each character.
 - key: Shifting the position of enter cursor to the right for each character.
 - DEL key: Deleting the character in the position of enter cursor for each character.
 - caps/CAPS key: Switching an alphabet character to CAPITAL or small.
 - CLEAR key: Deleting all the entered characters.
- The default password is “admin”.

Network settings (continued)

- Select OK, and NEW NETWORK PASSWORD screen appears if the entered password is correct.
 - If the entered password is not correct, the CURRENT NETWORK PASSWORD screen appears again.

NEW NETWORK PASSWORD

CONFIRM NETWORK PASSWORD

← →

A B C D E F G H I J K L M DEL

N O P Q R S T U V W X Y Z caps

0 1 2 3 4 5 6 7 8 9 CLEAR

OK CANCEL

- Enter the NEW NETWORK PASSWORD and CONFIRM NETWORK PASSWORD.
 - Password can be set using up to 32 characters including alphabets (capital/small) or numeric characters.
 - ← key: Shifting the position of enter cursor to the left for each character.
 - key: Shifting the position of enter cursor to the right for each character.
 - ↕ key: Shifting the position of enter cursor between NEW NETWORK PASSWORD and CONFIRM NETWORK PASSWORD.
 - DEL key: Deleting the character in the position of enter cursor for each character.
 - caps/CAPS key: Switching an alphabet character to CAPITAL or small.
 - CLEAR key: Deleting all the entered characters.
- When NEW NETWORK PASSWORD and CONFIRM NETWORK PASSWORD are matched, the setting is completed after changing the Network Password.
 - If the entered content is not matched, NEW NETWORK PASSWORD screen appears again after an error dialog is displayed.
 - It may take some time to reflect the settings.

IP Config settings

(See page 22 for menu setting.)

- Display the Network Config menu.
- Press the ▲ or ▼ button to select IP Config.

IP Config OK

- Press the ENTER button.
 - The IP Config menu appears.

IP Config

DHCP	On
IP Address	169 . 254 . 0 . 220
Subnet Mask	255 . 255 . 0 . 0
Default Gateway	169 . 254 . 0 . 1
MAC Address	xx-xx-xx-xx-xx-xx
DHCP Function	Off
Start IP Address	169 . 254 . 0 . 221
End IP Address	169 . 254 . 254 . 254
IP Config Setup	OK

Adjust MENU Exit

Select

Setting or clearing DHCP

- Display the IP Config menu.
- Press the ▲ or ▼ button to select DHCP.

DHCP On

- Press the ◀ or ▶ button to select On or Off.
 - To cancel the setting, press the MENU button.
 - When DHCP is set to On, IP Address, Subnet Mask, Default Gateway, and DHCP Function cannot be set. If you want to set these settings, set DHCP to Off and perform the IP settings as follows.

IP Address settings

- Display the IP Config menu.
- Press the ▲ or ▼ button to select IP Address.

IP Address 169 . 254 . 0 . 220

- Press the ENTER button.
 - The first octet is selected.

IP Address 169 . 254 . 0 . 220

- Press the ▲ or ▼ button to select the numeric value.
- Press the ◀ or ▶ button to select the octet.
 - The second or final octet is selected.

IP Address 169 . 254 . 0 . 220

- Press the ENTER button.
 - To cancel the setting, press the MENU button.
 - Set the numeric value within the range from 0 to 255. However, set the numeric value for the final octet within the range from 1 to 254.

Network settings (continued)

Subnet Mask settings

1. Display the IP Config menu.
2. Press the ▲ or ▼ button to select Subnet Mask.

Subnet Mask 255 - 255 - 0 - 0

3. Press the ENTER button.
 - The first octet is selected.

Subnet Mask 255 - 255 - 0 - 0

4. Press the ▲ or ▼ button to select the numeric value.
5. Press the ◀ or ▶ button to select the octet.
 - The second or final octet is selected.

Subnet Mask 255 - 255 - 0 - 0

6. Press the ENTER button.
 - To cancel the setting, press the MENU button.
 - Set the numeric value within the range from 0 to 255. However, set the numeric value for the final octet within the range from 0 to 254.

Default Gateway settings

1. Display the IP Config menu.
2. Press the ▲ or ▼ button to select Default Gateway.

Default Gateway 169 - 254 - 0 - 1

3. Press the ENTER button.
 - The first octet is selected.

Default Gateway 169 - 254 - 0 - 1

4. Press the ▲ or ▼ button to select the numeric value.
5. Press the ◀ or ▶ button to select the octet.
 - The second or final octet is selected.

Default Gateway 169 - 254 - 0 - 1

6. Press the ENTER button.
 - To cancel the setting, press the MENU button.
 - Set the numeric value within the range from 0 to 255. However, set the numeric value for the final octet within the range from 1 to 254.

Setting or clearing DHCP Function

1. Display the IP Config menu.
2. Press the ▲ or ▼ button to select DHCP Function.

DHCP Function ◀ On ▶

3. Press the ◀ or ▶ button select On or Off.
 - To cancel the setting, press the MENU button.
 - When DHCP Function is set to Off, Start IP Address and End IP Address cannot be set. If you want to set these settings, set DHCP Function to On and perform the IP settings as follows.

Start IP Address setting

1. Display the IP Config menu.
2. Press the ▲ or ▼ button to select Start IP Address.

Start IP Address 169 - 254 - 0 - 221

3. Press the ENTER button.
 - The first octet is selected.

Start IP Address 169 - 254 - 0 - 221

4. Press the ▲ or ▼ button to select the numeric value.
5. Press the ◀ or ▶ button to select the octet.
 - The second or final octet is selected.

Start IP Address 169 - 254 - 0 - 221

6. Press the ENTER button.
 - Set the numeric value within the range from 0 to 255. However, set the numeric value for the final octet within the range from 2 to 254. Moreover, set the numeric value larger than IP address in the same subnet class.

End IP Address setting

1. Display the IP Config menu.
2. Press the ▲ or ▼ button to select End IP Address.

End IP Address 169 - 254 - 0 - 224

3. Press the ENTER button.
 - The first octet is selected.

End IP Address 169 - 254 - 0 - 224

4. Press the ▲ or ▼ button to select the numeric value.
5. Press the ◀ or ▶ button to select the octet.
 - The second or final octet is selected.

End IP Address 169 - 254 - 0 - 224

6. Press the ENTER button.
 - Set the numeric value within the range from 0 to 255. However, set the numeric value for the final octet within the range from 3 to 254. Moreover, set the numeric value larger than Start IP address in the same subnet class.

IP Config Setup setting

1. Display the IP Config menu.
2. Press the ▲ or ▼ button to select IP Config Setup.

IP Config Setup OK ↵

3. Press the ENTER button.
 - Confirmation dialog appears.
4. If the ENTER button is pressed again, the IP Config setting will be reflected.
 - It may take some time to reflect the setting.

Network settings (continued)

Wireless Setting

(See page 22 for menu setting.)

1. Display the Network Config menu.
2. Press the ▲ or ▼ button to select Wireless Setting.



3. Press the ENTER button.
 - The Wireless Setting menu appears.

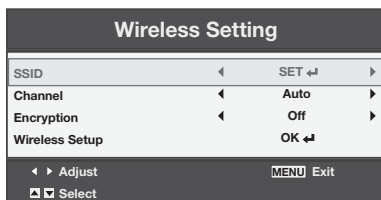

SSID setting

1. Display the Wireless Setting menu.
2. Press the ▲ or ▼ button to select SSID.



3. Press the ◀ or ▶ button to select SET ↵.
4. Press the ENTER button.
 - The SSID screen appears.

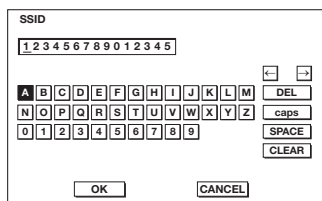

5. Press the ▲, ▼, ◀, and ▶ buttons to move the key cursor to select the characters or marks to enter, and press the ENTER button.
 - SSID can be set using up to 32 characters including alphabets (capital/small) or numeric characters.
 - ← key: Shifting the position of enter cursor to the left for each character.
 - key: Shifting the position of enter cursor to the right for each character.
 - DEL key: Deleting the character in the position of enter cursor for each character.
 - caps/CAPS key: Switching an alphabet character to CAPITAL or small.
 - CLEAR key: Deleting all the entered characters.
6. Select OK to complete the setting with the SSID stored. Select CANCEL to complete the setting without storing.
 - The display returns to the Wireless Setting menu after selecting CANCEL.

Channel setting

1. Display the Wireless Setting menu.
2. Press the ▲ or ▼ button to select Channel.



3. Press the ◀ or ▶ button to select Auto or 1 to 11.
 - To cancel the setting, press the MENU button.

Encryption setting

1. Display the Wireless Setting menu.
2. Press the ▲ or ▼ button to select Encryption.



3. Press the ◀ or ▶ button to select SET ↵.
4. Press the ENTER button.
 - Encryption dialog appears.



5. Press the ◀ or ▶ button to select OFF ↵ or another encryption.
6. Select the item to set, and press the ENTER button.
 - The KEY screen appears.
 - To cancel the setting, press the MENU button.

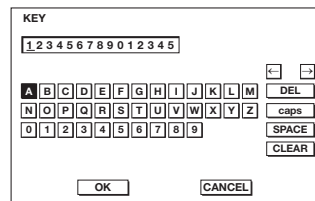

7. Press the ▲, ▼, ◀, and ▶ buttons to move the key cursor to select the characters or marks to enter, and press the ENTER button.
 - KEY can be set using up to 64 characters including alphabets (capital/small) or numeric characters.
 - ← key: Shifting the position of enter cursor to the left for each character.
 - key: Shifting the position of enter cursor to the right for each character.
 - DEL key: Deleting the character in the position of enter cursor for each character.
 - caps/CAPS key: Switching an alphabet character to CAPITAL or small.
 - CLEAR key: Deleting all the entered characters.
8. Select OK to complete the setting with the Encryption and KEY stored. Select CANCEL to complete the setting without storing.
 - The display returns to the Wireless Setting menu after selecting CANCEL.

Network settings (continued)

- The number of characters of KEY varies depending on the Encryption setting.
 - WEP 128bit(ASCII): 13 chars
 - WEP 64bit(ASCII): 5 chars
 - WEP 128bit(HEX): 26 digits
 - WEP 64bit(HEX): 10 digits
 - WPA-PSK(ASCII): 8-63 chars
 - WPA2-PSK(ASCII): 8-63 chars
 - WPA-PSK(HEX): 64 digits
 - WPA2-PSK(HEX): 64 digits
- If the entered content is outside character number range, the KEY screen appears again after an error dialog is displayed.

Wireless Setup setting

- Display the Wireless Setting menu.
- Press the ▲ or ▼ button to select Wireless Setup.



- Press the ENTER button.
 - Confirmation dialog appears.
- If the ENTER button is pressed again, the Wireless Setting will be reflected.
 - It may take some time to reflect the setting.

Enabling or disabling the AMX Device Discovery

Select this setting when using the AMX controller.
(See page 22 for menu setting.)

- Display the Network Config menu.
- Press the ▲ or ▼ button to select AMX Device Discovery.



- Press the ENTER button.
 - AMX dialog appears.



- Press the ◀ or ▶ button to select ON ↵ or OFF ↵.
- Select the item to set, and press the ENTER button.
 - To cancel the setting, press the MENU button.
 - It may take some time to reflect the setting.

Initialization of network settings

(See page 22 for menu setting.)

- Display the Network Config menu.
- Press the ▲ or ▼ button to select Network Initialization.



- Press the ENTER button.
 - Network Initialization dialog appears.
- If the ENTER button is pressed again, the network settings will be initialized.
 - It may take some time to initialize the settings.

Restart of network function

(See page 22 for menu setting.)

- Display the Network Config menu.
- Press the ▲ or ▼ button to select Network Restart.



- Press the ENTER button.
 - Network Restart dialog appears.
- If the ENTER button is pressed again, the network function will be restarted.
 - It may take some time to restart the function.

How to use network function

- When connecting a computer and projector with LAN, configure the both IP Addresses in the same network group.
If connecting in different network group, be sure to use a router. As for the settings of a router, ask the network administrator.
- Configure the IP Config correctly. If the settings are not correct, the communication may be unavailable. For the detail, consult the network administrator.
- Depending on the settings of Standby Mode of the projector, LAN function may be unavailable. See page 27 for the detail of Standby Mode.

Glossary

For more detail of the glossary below, refer to the technical book that is commercially available.

Term	Description
DHCP	Abbreviation for Dynamic Host Configuration Protocol. This protocol automatically assigns IP Address to networked devices.
IP Address	Numerical address to identify networked computers.
Subnet Mask	A numeric value to define the number of bits used for a network address of a divided network (or subnet) in an IP Address.
Default Gateway	A server (or router) to communicate across networks (subnets) that are divided by Subnet Mask.
MAC Address	Abbreviation for Media Access Control Address. MAC Address is a unique ID number assigned to each network adapter. And this is based on which data are sent and received between network adapters.

Advanced display utilities

USB Display

You can project the computer images inputted via a USB connection.

You don't have to install any drivers on your computer to use this function.

Important:

- Supported OS's are Windows XP, Windows Vista and Windows 7.
- Only 1-to-1 screen projection is supported.
- Moving images cannot be displayed.

Connection

Connect the projector and the computer using a commercially available USB cable.

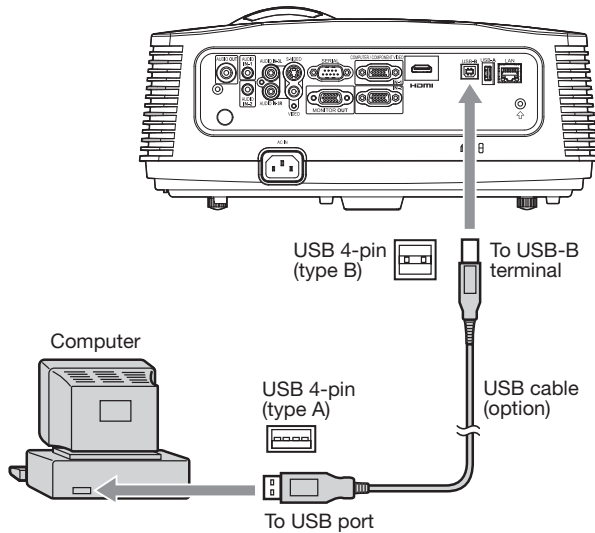

Important:

- The USB-B terminal on this projector is compatible with USB 2.0.
- Do not use a USB hub between the projector and the computer.

Operation

1. Select a USB Display input by pressing the USB DISP. button on the remote control or the COMPUTER button on the projector.
 - Each time you press the COMPUTER button, the input source is switched between Computer1, Computer2, HDMI, LAN Display, USB Display and PC Less Presentation.
 - When the USB Display input is selected, the splash screen for USB Display appears on the screen.



2. When the computer is connected to the projector, the computer image is automatically displayed on the screen.
3. When ending the USB Display projection, unplug the USB cable from the projector.
 - It is not necessary to "Safely Remove Hardware" on the computer or to press the UNPLUG button on the remote control.

Important:

- When the image is projected, the computer resolution will be changed to WXGA/XGA according to the projector model and will be automatically recovered after unplugging the USB cable.

Advanced display utilities (continued)

LAN Display

You can project the computer images inputted via a wired or wireless LAN.

You can also perform the following during the LAN Display projection:

- 4-to-1 split screen projection
Images from up to 4 computers can be projected split on 1 projector screen.
- Remote desktop
Connecting an input device such as a mouse or keyboard to the USB-A terminal on the projector enables the following computer operations from the projector.
 - Showing local files of the computer
 - Operating the application software
 - Showing server files on the network
 - Browsing of the internet

To use the LAN Display function, you need to install the software “LAN Display System” contained in the attached CD-ROM.

Important:

- Supported OS's are Windows XP, Windows Vista and Windows 7.
- Remote desktop cannot be performed during 4-to-1 split screen projection and during wireless LAN communication.
- Moving images cannot be displayed.

Installation of software

Installing LAN Display System

Before starting installation, be sure to read “ReadMe(En).txt” contained in the CD-ROM. Copy “LAN Display System.exe” contained in the TOOLS folder of CD-ROM to the hard disk of your computer.

1. Double click “LAN Display System.exe”, and start up the installer of the LAN Display System.
2. The Setup window is displayed. Click [Next].
 - Installation is started.



3. When the installation has been completed, LAN Display System is automatically executed.

When deleting LAN Display System (Uninstallation)

Important:

- When uninstalling LAN Display System, it should be ended in advance. If the application continues operating, uninstallation cannot be performed normally.

1. Select [Start]-[All Programs]-[LAN Display System]-[Uninstall].
2. The LAN Display System Uninstall window is displayed. Click [Yes].
 - The uninstallation is started.

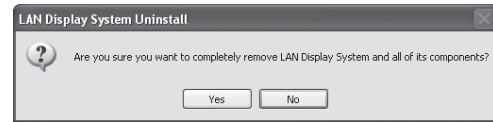

3. When the uninstallation has been completed, click [OK].



- Logs and setting files are automatically deleted.

Connection

Connect the projector and the computer either by using a commercially available LAN cable or USB wireless LAN adapter.

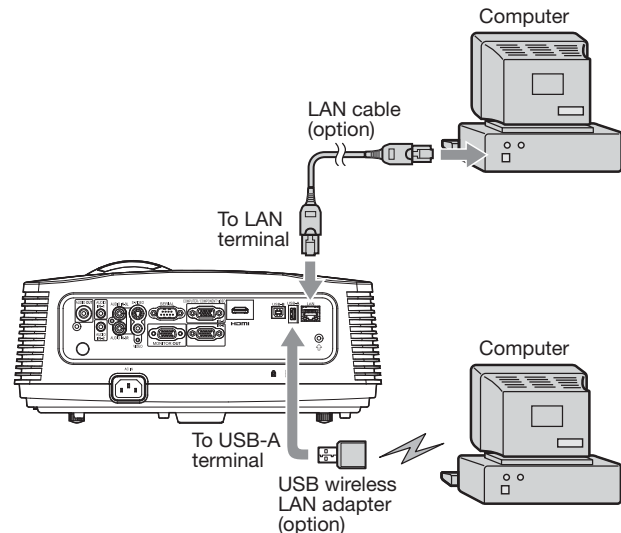

Important:

- For wired LAN connection, use a category-5 LAN cable. Both straight-through and crossover cables can be used.
- The USB-A terminal on this projector is compatible with USB 2.0.
- Do not use a USB hub for the connection.
- Supported USB device is standard USB HID device with power consumption less than 5V/500mA.
- Some USB wireless LAN adapters cannot be used depending on the specifications.
- IP address, subnet mask, default gateway values are the same for both wired LAN and wireless LAN.
- Data are not filtered between wired LAN and wireless LAN interface.

Advanced display utilities (continued)

Projection

Selecting a LAN Display input

- Press the LAN DISP. button on the remote control or the COMPUTER button on the projector.
 - Each time you press the COMPUTER button, the input source is switched between Computer1, Computer2, HDMI, LAN Display, USB Display and PC Less Presentation.
 - When the LAN Display input is selected, the splash screen for LAN Display appears on the screen.

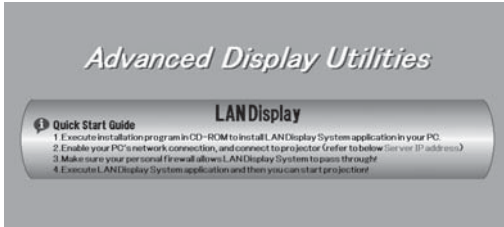

Starting the LAN Display System

- Click the LAN Display System icon (🖥️) to execute the program.
 - The program starts to search for projectors automatically.
 - During searching for projectors, Searching icon is displayed.



- When a projector is found, the computer logs in to the projector automatically and the computer image is projected. The main user interface appears on the computer screen.
- When multiple projectors are found, the following window appears on the computer screen.

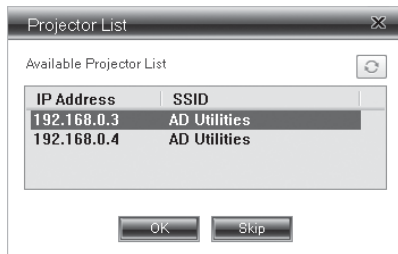

Select a projector and click [OK]. The computer logs in to the projector and the computer image is projected.

Operating the LAN Display System

- Click the buttons on the main user interface to operate the projection.

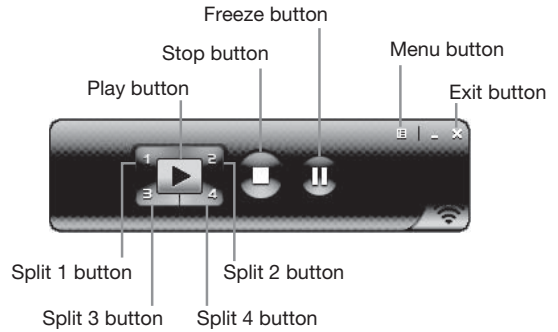

- Play button:** Projects the image in full screen.
- Split 1-4 buttons:** Click either of the buttons to project the image on relevant split screen.
- Stop button:** Stops the projection.
- Freeze button:** Freezes the projected image.
- Menu button:** Displays the menu window. (See the next step for details.)
- Exit button:** Exits the LAN Display System.

- Click the Menu button on the main user interface to display the menu window and select functions.

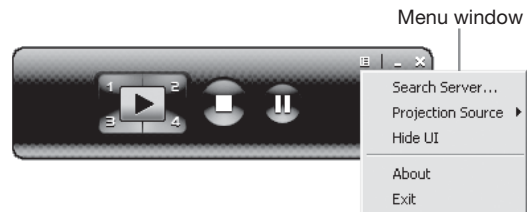

- Search Server** Searches for the projectors on the network. If this function is selected, the LAN Display projection will quit automatically.
- Projection Source** Chooses the computer screen to be projected, main screen or virtual extended screen which is activated by computer's virtual display function.

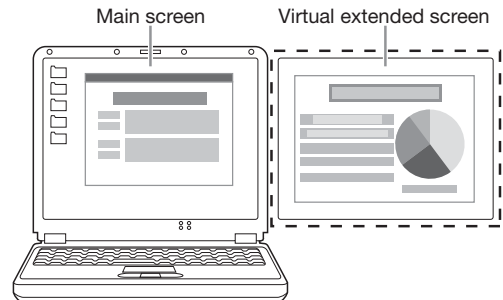

Advanced display utilities (continued)

Important:

- Virtual display function is only supported by Windows XP.
- To project a virtual extended screen, the attached Virtual display driver must be installed.
- **Hide UI**
Hides or displays the main user interface.
- **About**
Displays the version information of the LAN Display System.
- **Exit**
Exits the LAN Display System.

Ending the LAN Display projection

5. Click the Exit button on the main user interface or the menu window to exit the LAN Display System.
6. In case of the wireless LAN communication, unplug the USB wireless LAN adapter from the projector. Before unplugging, be sure to press the UNPLUG button on the remote control and select [Yes] on the screen by pressing the ◀ or ▶ button and then ENTER button.

Using remote desktop

Connect an USB device such as a mouse or keyboard to the USB-A terminal on the projector. While the computer images are projected with the LAN Display, the computer can be operated with the device.

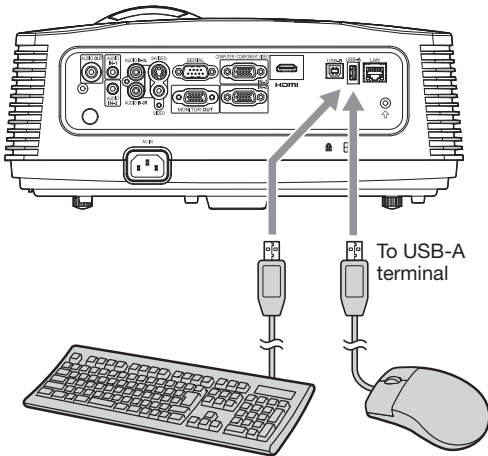

One of the USB devices can be connected.

Installing the virtual display driver

To project a virtual extended screen, install the Virtual display driver as follows.

1. Double click “Virtual display driver.exe” contained in the folder “LAN Display System”, and start up the installer of the Virtual display driver.
2. The Setup window is displayed. Click [Next] and operate according to the instructions on the window.

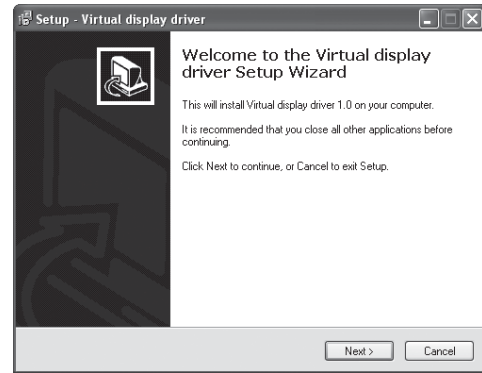

3. When the installation has been completed, restart the computer.

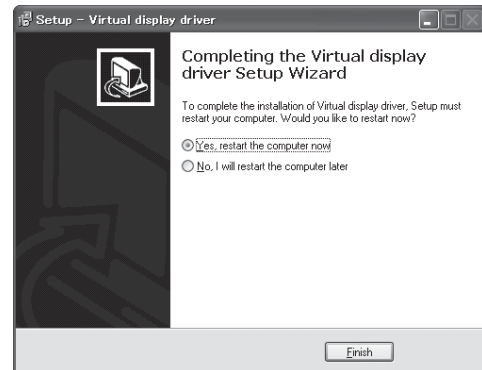

Important:

- Do not switch the input source to USB Display or PC Less Presentation during the wireless LAN communication. If switched, the communication will be disconnected.
- When the image is projected, the computer resolution will be changed to WXGA/XGA according to the projector model and will be automatically recovered after the LAN Display System is ended.
- During wireless LAN communication, the projector cannot communicate with the access point.
- Only infrastructure mode is available to wireless LAN communication. Adhoc mode is not available.

Advanced display utilities (continued)

PC Less Presentation

You can project JPEG images and the PtG contents stored in the USB device such as a USB memory without using a computer.

Also, you can perform effective presentation of them using the AutoRun function and the slideshow function.

To create PtG contents, you need to install the software "PtG Converter-Lite" contained in the attached CD-ROM.

Important:

- Supported USB Flash drive format is FAT32.
- Only one logical partition in USB Flash drive is supported.
- Supported USB device is standard USB mass storage device with power consumption less than 5V/500mA.
- JPG file preview limitation:
 - File size: 10MB or less
 - Pixel: 40 megapixel (24 bits) or less
 - Dimension: 8192*6144 or less
 - File Name: ASCII characters are supported.
 - Thumbnail: file thumbnail (obtained from EXIF) is supported.
- PtG file preview limitation:
 - File Name: ASCII characters are supported.
 - Thumbnail: file thumbnail is supported.
- PC Less Presentation does not support the following image:
 - Extended DCT-based process
 - Lossless process
 - Hierarchical process
 - Progressive scan
 - Input format of YUV4:1:1, gray level with 16x16 pixels MCU
 - Decoded image width less than 64 pixels for YUV4:2:0/4:2:2 and 32 pixels for YUV4:4:4
 - Decoded height less than 32 pixels
 - Source images of 12-bits per sample

Installation of PtG Converter-Lite

About PtG Converter-Lite

PtG Converter-Lite is a software which converts PPT files created by Microsoft Office PowerPoint into PtG files that can be projected by PC Less Presentation. Pause/page marks and animations contained in the PPT files are also converted.

Features

- Converting up to 20 pages of PPT
- Converting into 800*600*16bpp PtG

System requirement

- CPU: Intel Pentium-M 1.5G or above
- Memory: 256 MB or more (recommended)
- OS: Windows XP, Windows Vista and Windows 7
- Microsoft Office: Microsoft Office 2003 and Microsoft Office 2007

Installing PtG Converter-Lite

Before starting installation, be sure to read "ReadMe(En).txt" contained in the CD-ROM. Copy "PtG Converter-Lite.exe" contained in the TOOLS folder of CD-ROM to the hard disk of your computer.

1. Double click "PtG-Converter-setup.exe", and start up the installer of the PtG Converter-Lite.
2. The Setup window is displayed. Click [Next].
 - Installation is started.

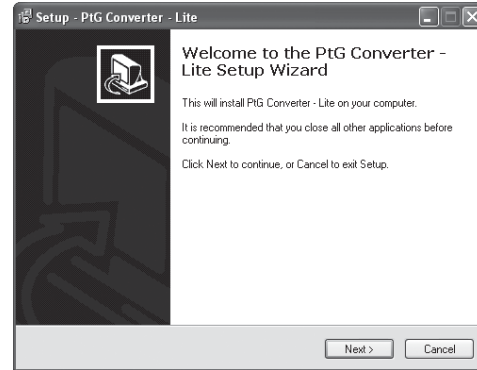

3. When the installation has been completed, click [Finish].

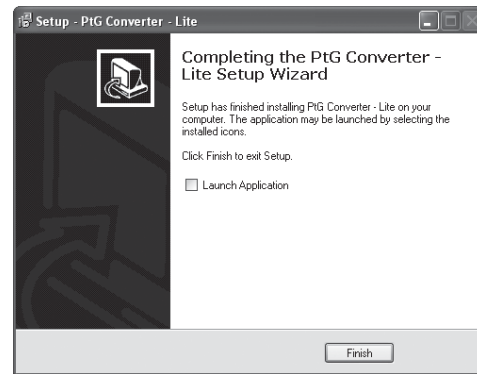

When deleting PtG Converter-Lite (Uninstallation)

Important:

- When uninstalling PtG Converter-Lite, it should be ended in advance. If the application continues operating, uninstallation cannot be performed normally.

1. Select [Start]-[All Programs]-[PtG Converter]-[Uninstall].
2. The PtG Converter-Lite Uninstall window is displayed. Click [YES].
 - The uninstallation is started.

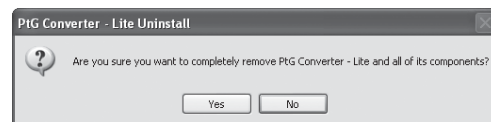

3. When the uninstallation has been completed, click [OK].

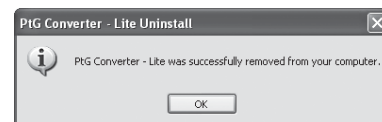

- Logs and setting files are automatically deleted.

Advanced display utilities (continued)

Conversion of a PPT file to PtG file using the PtG Converter-Lite

- Click the PtG Converter-Lite icon “” to execute the program.

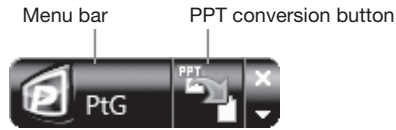

- Menu bar
 - Right-click to open the menu.
 - Max Circle Animation: Selects the max time of animation.
 - About: Displays the software version information.
 - Exit: Exits the PtG Converter-Lite.
 - PPT conversion button: Starts the conversion from the PPT file to the PtG file.
- Click the PPT conversion button.
 - The file selection screen appears.

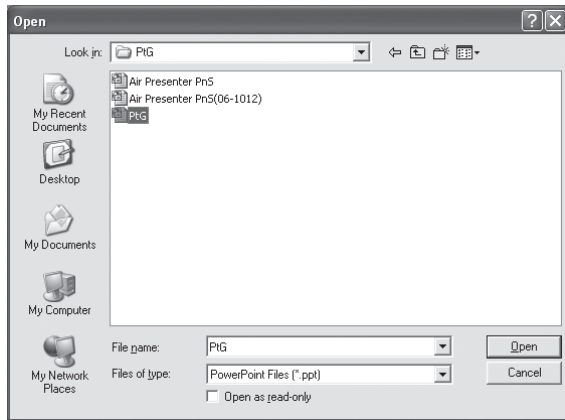

- Select the PPT file you want to convert, and click [Open].
 - The screen for specifying the file destination and name appears.

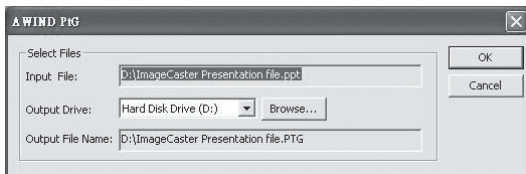

- Set the file destination and the name.
 - The converted file is stored in the same folder as original file by default.
 - The name of the converted file is the same as original file's by default.
- Click [OK] to start conversion.
- When the conversion has been completed, click [OK].



Important:

- All the animation effects available on a computer display can be converted. However, the followings are not supported.
 - Animation effects with the timer setting or the repeat setting
 - Animation effects taking 60 seconds or more in a single movement
 - Pages having more than 3 second downtime setting
 - VBA object embedded files
 - OLE object embedded files

Connection

Connect a USB device to the USB-A terminal on the projector.

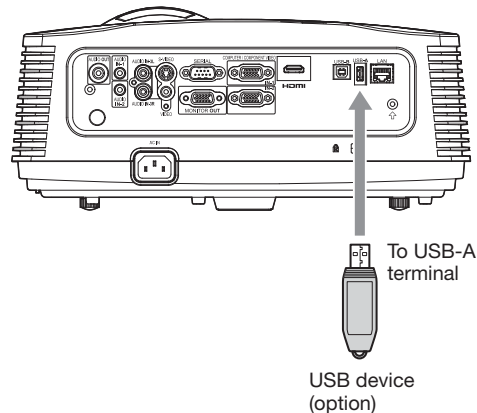

Important:

- The USB-A terminal on this projector is compatible with USB 2.0.
- Do not use a USB hub for the connection.

Performing the PC Less Presentation

Selecting a PC Less Presentation input

- Press the VIEWER button on the remote control or the COMPUTER button on the projector.
 - Each time you press the COMPUTER button, the input source is switched between Computer1, Computer2, HDMI, LAN Display, USB Display and PC Less Presentation.
 - When the PC Less Presentation input is selected, the PC Less Presentation screen appears.

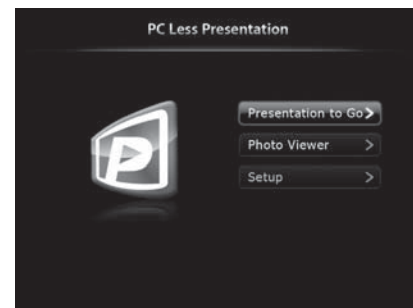

Advanced display utilities (continued)

Setting up

- Press the ▲ or ▼ button on the remote control to select Setup and press the ENTER button.
 - The Setup screen appears.



- Press the ▲ or ▼ button to select a setting item and press the ◀ or ▶ button to change the setting.
 - AutoRun:**
Enables or disables the AutoRun and slideshow function.

	AutoRun	Slideshow
OFF	Disables.	Disables.
PtG	Enables for PtG files.	Enables for all files.
Photo	Enables for JPEG files.	Enables for all files.

- Interval:**
Sets the interval for PtG pause mark or photo slideshow to 5/10/30/60/300 seconds.
 - Repeat:**
Enables or disables the repeat execution of AutoRun and slideshow function for photo files and PtG file.
 - Sorting:**
Sets the file sorting rule to File Name (Ascending), File Name (Descending), Time (New to Old) or Time (Old to New).
- To return to the PC Less Presentation screen, press the ENTER button.

Displaying PtG file

- Press the ▲ or ▼ button on the remote control to select Presentation to Go and press the ENTER button.
 - The file selection screen appears.

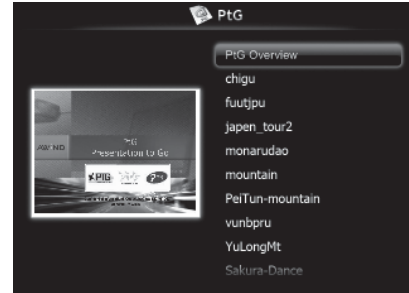

- Press the ▲ or ▼ button to select a file or folder you want to display and press the ENTER button.
 - If you select a folder, the underlying file names are displayed. Then, select a file.
 - An image on page 1 is displayed on the screen.
- Change the page by pressing the ▲, ▼ or ▶ button.
 - ▲ button: to previous page
 - ▼ button: to next page
 - ▶ button: to next pause
- Press the ◀ button to quit the display.
 - The screen goes back to the file selection screen.

Displaying JPEG file

- Press the ▲ or ▼ button on the remote control to select Photo Viewer and press the ENTER button.
 - The file selection screen appears.

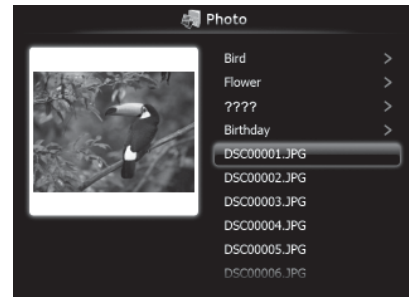

- Press the ▲ or ▼ button to select a file or folder you want to display and press the ENTER button.
 - If you select a folder, the underlying file names are displayed. Then, select a file.
 - The image of the selected file is displayed on the screen.
- Change the file by pressing the ▲, ▼ or ▶ button.
 - ▲ button: to previous file
 - ▼ button: to next file
 - ▶ button: to next file
- Press the ◀ button to quit the display.
 - The screen goes back to the file selection screen.

Advanced display utilities (continued)

Displaying with AutoRun function

5. Create an "AUTORUN" folder in the root directory of the USB device using a computer or other.
6. Save a PtG file or JPEG files in the AUTORUN folder.
Important:
 - The AutoRun function supports single PtG file only. The first PtG file is played if multiple PtG files exists in AUTORUN folder.
7. Connect the USB device to the USB-A terminal.
 - The files specified by the AutoRun setting (PtG or Photo) are played back automatically.
8. Press the ENTER button to start or pause the playback.
9. Press the ▲, ▼ or ► button to change the file to be played back.
 - ▲ button: to previous page/previous file
 - ▼ button: to next page/next file
 - ► button: to next pause/next file
10. Press the ◀ button to quit the AutoRun display.
 - The screen goes back to the file selection screen.

Displaying with slideshow function

5. Press the ▲ or ▼ button on the remote control to select Presentation to Go or Photo Viewer and press the ENTER button.
 - The file selection screen appears.
6. Press the ▲ or ▼ button to select a file or folder you want to display and press the ENTER button.
 - If you select a folder, the underlying file names are displayed. Then, select a file.
 - When a PtG file is selected, the file is displayed with the slideshow.
 - When a JPEG file is selected, all the files in the same folder as the JPEG file exists are displayed with the slideshow.
7. Press the ENTER button to start or pause the playback.
8. Press the ▲, ▼ or ► button to change the file to be played back.
 - ▲ button: to previous page/previous file
 - ▼ button: to next page/next file
 - ► button: to next pause/next file
9. Press the ◀ button to quit the slideshow.
 - The screen goes back to the file selection screen.

Ending the PC Less Presentation

Unplug the USB device from the projector. Before unplugging, be sure to press the UNPLUG button on the remote control and select [Yes] on the screen by pressing the ◀ or ► button and then ENTER button.

Advanced features

Displaying a user-defined image during startup or muting

You can display your desired image as the startup screen (or splash screen). Using the menu, you can also use it as the background that is displayed while the video is muted or no signal is inputted.

Important:

- You can capture the computer images from the Computer1, Computer2, HDMI, LAN Display, USB Display, and PC Less Presentation input sources.

Procedure

(See page 22 for menu setting.)

1. Select the input source Computer1, Computer2, or HDMI.
2. Display your desired image.
3. Display the Option menu.
4. Select Image Capture by pressing the ▲ or ▼ button.



5. Press the ENTER button.
 - When the capture starts, the captured image will be displayed.
 - When you press ENTER button once, any button doesn't function until the capture completes.
 - When image resolution is lower than XGA (1024 x 768), the image is captured by adjusting its resolution to XGA.
 - When image resolution is higher than XGA (1024 x 768), the image area of XGA is only captured.

Important:

- The captured images will be deleted at the same time as pressing the ENTER button. If you pressed ENTER button wrongly, try to capture the same images again.
- The captured image is displayed from the next startup when Splash Screen in the Option menu is set to User. If the captured image isn't displayed, check to see if Splash Screen in the Option menu is set to Off. (See page 28.)
- To display the captured image while the video is muted, set AV Mute Mode in the Option menu to Image User. (See page 28.)
- When Back Color in the Option menu is set to Image User, the captured image is displayed while no signal is inputted.
- Some images can't be captured correctly because of their signal type.

Freeze

To stop the motion in the image temporarily (or to display a still image):

Press the FREEZE button on the remote control.

- The image freezes temporarily.

To resume the motion in the image:

Press the FREEZE button on the remote control again.

Important:

- Do not keep displaying a still picture for an extended period of time, as the afterimages may linger on the screen.

Magnify

By pressing the MAGNIFY button on the remote control, you can magnify the image to view the details.

- The MAGNIFY mode doesn't function with some input signals. For details, see page 60.
- The MAGNIFY mode doesn't work with video or S-video signal.

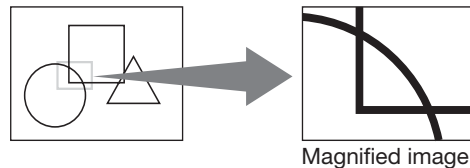

Magnified image

To use the MAGNIFY mode:

1. Press the MAGNIFY button.
 - You can select the area to be magnified by pressing the ▲, ▼, ◀ or ▶ button on the remote control.
 - You can change the magnification of the selected area by pressing the VOLUME ▲ or ▼ button.
2. Press the MAGNIFY button again to exit the MAGNIFY mode.
 - The regular operation screen will appear.

Important:

- In the MAGNIFY mode, you can't adjust the volume.

Advanced features (continued)

Password lock

This projector provides the password lock function that is intended to prevent wrong operations by children and set controlled access for specified users. If the password lock is enabled, when the projector is turned on, the startup screen (or splash screen) will appear and stay on the screen until the password is entered. When the password is entered, the startup screen will switch to the regular operation screen.

To set a password:

(See page 22 for menu setting.)

1. Display the Option menu.
2. Press the ▲ or ▼ button to select Password.

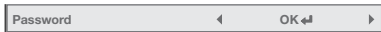

3. Press the ENTER button.
 - The Password menu appears.



4. Press the ▲ or ▼ button to select Change Password.
5. Press the ENTER button.
 - The screen for entering a new password appears.

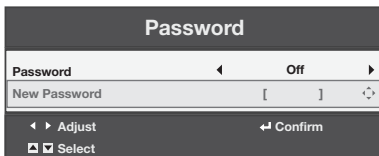

- When the password has already been set, the screen for entering the old password appears instead. In such a case, enter the old password using the same operation as in next step and press the ENTER button. Then the screen for entering a new password appears.
6. Enter a 4 digit password using the ▲, ►, ▼ and ◀ buttons.
(▲=1, ►=2, ▼=3, ◀=4)
 - To cancel the procedure, press the MENU button.
 7. Press the ENTER button.
 8. Press the MENU button to exit the menu.

To enable or disable password lock:

(See page 22 for menu setting.)

1. Display the Option menu.
2. Press the ▲ or ▼ button to select Password.
3. Press the ENTER button.
 - The Password menu appears.
4. Press the ▲ or ▼ button to select Password.



5. Press the ◀ or ▶ button to select On or Off.
6. Press the MENU button to exit the menu.

Important:

- To disable the password lock when the screen for entering the password is displayed, press the MENU and ENTER buttons on the projector at the same time.

Advanced features (continued)

Supervising and controlling by computer

You can supervise and control the projector's operation using a personal computer via a LAN network.

Major functions

ProjectorView Global+

Batch projector controlling / supervising application software

- Batch operation of stand-alone projector / multiple projectors
- Scheduling function to turn ON/OFF for each day of the week
- Checking each condition of the projector and detecting a theft
- Setting of the projector's IP Config
- Activating Visual PA2 to display the specified characters on the projector's screen
- Projector's Text Speech function to read aloud messages displayed on the Visual PA2 window

AMX Device Discovery

The projector is monitored and controlled by the controller system of AMX.

Crestron RoomView Connected™

The projector is monitored and controlled by the controller system and software of Crestron Electronics, Inc.

PJLink™

This projector supports standard protocol PJLink™ for projector control and you can control and monitor projector's operations using the same application among projectors of different models and different manufacturers.

About ProjectorView Global+

- For details, see "LAN control UTILITY operation manual" in the CD-ROM.

About AMX Device Discovery

- This is a technology suggested by AMX to facilitate configuration of the control system of AMX and its target devices.
For details, see the website of AMX.
URL <http://www.amx.com/>

About Crestron RoomView Connected™

- This is a technology suggested by Crestron Electronics, Inc. to facilitate configuration of the control system of Crestron and its target devices.
For details, see the website of Crestron Electronics, Inc.
URL <http://www.crestron.com>
URL <http://www.crestron.com/getroomview/>

About PJLink™

- To use PJLink™ function, the PJLink™ application software is required.
- To use this function, set the network certification properly according to the setting of the network application to be used. (See page 34.)
- For the specifications of PJLink™, access to the Web site of Japan Business Machine and Information System Industries Association (JBMIA). (<http://pjlink.jbmia.or.jp/english>)
- This projector is fully compliant to the specifications of JBMIA PJLink™ Class 1. It supports all the commands defined by PJLink™ Class 1, and the compliance has been verified with the PJLink™ standard specifications Version 1.0.

Important:

- For the commands for PJLink™, see the table on the next page.
- The control may not be performed correctly or the monitoring data may not be obtained correctly in the following conditions:
 - During standby
 - During input source switching
 - During auto position execution
 - During AV mute
 - During command processing
 - Before the splash screen disappears after the power is turned on.
- During AV mute, etc., it may take approx. 5 seconds to receive a response to a command.
- Use 1 controller to control/monitor 1 projector.
- For how to control/monitor using PJLink™, see the operation manual of the PJLink™ application you use.
- When you monitor the projector's operating state using this function by issuing inquiry commands successively, issue an inquiry command after receiving the response to the previous inquiry command from the projector.

Advanced features (continued)

Connection

For details of the connection, see “LAN control UTILITY operation manual” in the CD-ROM.

When Standby Mode of the Efficient Mode menu in the Installation menu of the projector is set to Low, the LAN network is disabled. To enable the LAN network, set Standby Mode to LAN. (See page 27.)

Configure the initial network settings first.

You can configure the initial settings using the projector menu (see pages 34 to 38) or ProjectorView Global+. For details of ProjectorView Global+, see “LAN control UTILITY operation manual” in the CD-ROM.

Using the User Manual

The User Manual for LAN Control Utility is prepared in the Portable Document Format (PDF) in the CD-ROM.

Opening the User Manual:

1. Load the CD-ROM into the CD-ROM drive.
2. Open CD-ROM “PROJECTOR.”
3. Double-click on “MANUAL_LAN.HTML” within the CD-ROM. A language selection list for the User Manual will be displayed.
4. Move the mouse pointer to the desired language and click.

PJLink™ supported commands

The table below shows commands to control the projector using the PJLink™ protocol.

Command	Description	Remark (Parameter)
POWR	Power control	0 = Standby 1 = Power on
POWR ?	Inquiry about the power state	0 = Standby 1 = Power on 2 = Cooling down 3 = Warming up
INPT	Input switching	11 = Computer1 12 = Computer2 21 = Video 22 = S-Video 31 = HDMI 41 = PC Less Presentation 42 = USB Display 51 = LAN Display
INPT ?	Inquiry about input switching	
AVMT	Mute control	30 = Video and audio mute disable 31 = Video and audio mute enable
AVMT ?	Inquiry about the mute state	
ERST ?	Inquiry about the error state	1st byte: Fan error, 0 or 2 2nd byte: Lamp error, 0 to 2 3rd byte: Temperature error, 0 or 2 4th byte: Cover open error, 0 or 2 5th byte: Always 0 6th byte: Other error, 0 or 2 0 to 2 mean as follows: 0 = No error detected, 1 = Warning, 2 = Error
LAMP ?	Inquiry about the lamp state	1st value (1 to 5 digits): Cumulative lamp operating time (This item shows a lamp operating time (hour) calculated based on that Lamp Mode is Low.) 2nd value: 0 = Lamp off, 1 = Lamp on
INST ?	Inquiry about the available inputs	The following value is returned. “11 12 21 22 31 41 42 51”
NAME ?	Inquiry about the projector name	The projector name set on the Network Config menu or the Crestron RoomView Setup window is returned.
INF1 ?	Inquiry about the manufacturer name	“MITSUBISHI” is returned.
INF2 ?	Inquiry about the model name	“XD700U” or “WD720U” is returned.
INF0 ?	Inquiry about other information	No other information is available. No parameter is returned.
CLSS ?	Inquiry about the class information	“1” is returned.

- This projector is fully compliant to the specifications of JBMIA PJLink™ Class 1. It supports all the commands defined by PJLink™ Class 1, and the compliance has been verified with the PJLink™ standard specifications Version 1.0.

Lamp replacement

This projector is equipped with a lamp to project images. This lamp is a consumable. It may burn out or its brightness may decrease during use. In such cases, replace the lamp with a new one as soon as possible. Be sure to replace the lamp with a new lamp separately sold that is exclusive to this projector. Contact your dealer for purchase of the lamp.

Spare lamp for XD700U/WD720U: VLT-XD700LP

Caution:

- Do not remove the lamp immediately after using the projector. You may get burned because the lamp is very hot after use.
- Before replacing the lamp, press the POWER button to turn off the lamp and wait for two minutes for lamp to cool down. Unplug the power cord from wall outlet and wait one hour for the lamp to cool down completely.
- Do not remove the lamp except for replacement. Careless handling can cause injury or fire.
- Do not touch the lamp with bare hands or give a shock to the lamp. Attach the lamp properly. Improper handling may cause explosion.
- Be sure not to drop the lamp lid screw into the projector. Also be sure not to put metal or any flammable objects inside because it may cause fire or electric shock. If any objects should fall inside, unplug and contact your dealer.
- Install the lamp securely to prevent failure and fire.
- If the lamp should break, small glass fragments may fall out through the vents and some may remain inside of the projector or the lamp box. When taking the lamp box out, be sure to turn over the projector and hold the handle of the lamp box to avoid injury due to the glass fragments.
- If the lamp should break, never shake the lamp box or hold it in front of your face after removing it. The glass fragments may fall out and cause injury to your eyes.
- When removing the lamp from the ceiling-mounted projector, use the lamp replacement attachment packed with the projector or option lamp to prevent glass fragments from scattering.
- Be sure to use the lamp dedicated to this projector, VLT-XD700LP for XD700U/WD720U. Use of other lamps may cause a failure of the projector.

A) When the projector is placed on the table

Make sure that the projector is securely held in place.

1. Remove the cover (a) of the screw fixing the lamp cover with a fingernail. If it is difficult to remove it with a fingernail, use a finetipped tool such as flathead screwdriver.

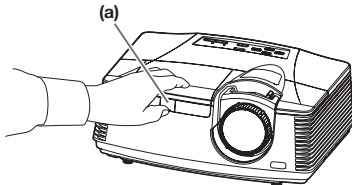

2. Remove the screw (b) and slide the lamp cover (c) for removal.

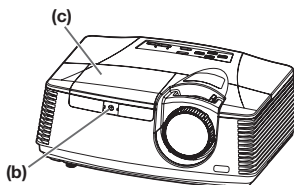

3. Loosen the two screws (d) of the lamp unit, and then pull out the lamp unit (f) by the handle (e).

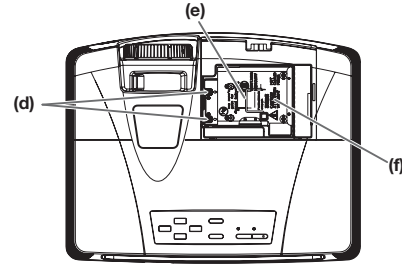

Caution:

- When replacing the lamp, do not loosen the screws other than two screws (d). It may cause the failure of projector.
 - Pull the lamp unit out of the projector slowly. If it is pulled out quickly, the lamp may break, scattering glass fragments.
 - Do not spill liquid on the removed lamp unit or do not place it near any flammable object or where children can reach to prevent injuries or fire.
4. Insert the new lamp unit, and secure it with two screws firmly.
 5. Secure the lamp cover with screw (b) back again, and mount the cover (a).

Caution:

- Make sure that the lamp cover is secured firmly. Otherwise, the POWER indicator flashes red and green, disallowing the projector to be powered on.

B) When the projector is mounted to the ceiling

When removing the lamp unit from the projector mounted to the ceiling, never fail to use the lamp replacement attachment to protect yourself from glass fragments and so on.

- Contact your dealer when replacing the lamp unit with the projector mounted to the ceiling.
1. Remove the lamp cover referring to the procedure 1 and 2 of "A) When the projector is placed on the table".

Caution:

- When opening the lamp cover to replace the lamp of the ceiling-mounted projector, pay careful attention because glass fragments may exist inside the lamp cover.
2. Loosen the two screws (d) of the lamp unit.

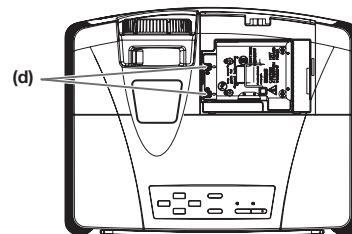

Caution:

- When replacing the lamp, do not loosen the screws other than two screws (d). It may cause the failure of projector.

Lamp replacement (continued)

- Assemble the lamp replacement attachment by folding two taping portions (g) and two cutout portions (h) along the folding line as the figure.

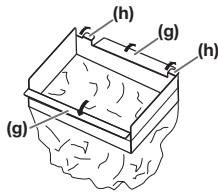

- Insert the two cutout portions (h) in the slit of the projector, paste the two taping portions (g) with the tape included in the lamp replacement attachment, and then fix the lamp replacement attachment to the projector.

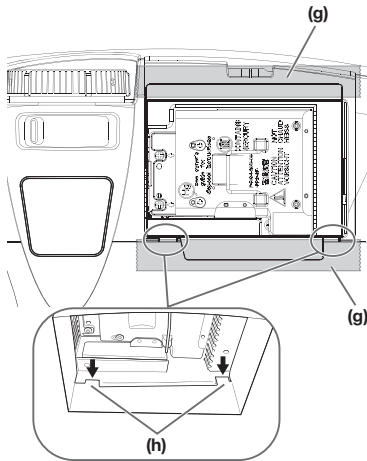

- Pull out the lamp unit (f) in the bag by the handle (e).

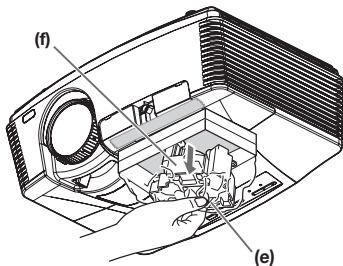

- Remove the tape fixing the lamp replacement attachment, and remove the lamp replacement attachment with the lamp unit remaining in the bag.

Caution:

- Pull the lamp unit out of the projector slowly. If it is pulled out quickly, the lamp may break, scattering glass fragments.
- Do not spill liquid on the removed lamp unit or do not place it near any flammable object or where children can reach to prevent injuries or fire.

- Insert the new lamp unit, and secure it with two screws firmly.
- Secure the lamp cover with screw (b) back again, and mount the cover (a).

Caution:

- Make sure that the lamp cover is secured firmly. Otherwise, the POWER indicator flashes red and green, disallowing the projector to be powered on.

Reset of the lamp operation time

Plug in the power cord, and reset the lamp operation time by keep pressing the ◀, ▶, and POWER buttons on the control panel at the same time.

Important:

- Unless these three buttons are pressed at the same time, the lamp operation time isn't reset.
- Make sure that the STATUS indicator is lit twice and the lamp operation time is reset successfully.
- The projector doesn't turn on if the lamp cover isn't attached securely.
- Be sure to reset the lamp operation time whenever you replace the lamp.
- Do not reset the lamp operation time unless you replace the lamp.

Caution:

- The lamp is fragile. If it is broken, be careful not to cut yourself with glass fragments.
- Contact your dealer for a new lamp.

Interval of lamp replacement

The recommended interval of lamp replacement is about 5000 hours^{*1,2} of consecutive use. Such interval differs depending on the operating environment and may be shorter than 5000 hours^{*1,2}.

Decrease in luminescence and/or color brightness indicates that the lamp needs to be replaced. When the lamp operation time exceeds 3750 hours^{*1}, the indicator will blink alternately between green and red (while the lamp is lit; when the lamp is not lit, the indicator will be lit red only) and the lamp replacement message will appear on the screen for one minute everytime the lamp is turned on. When the lamp has been used for about 4750 hours^{*1}, the replacement message (Lamp Replacement) will appear on the screen for one minute every 25 hours^{*1} thereafter.

When the lamp operation time exceeds 5000 hours^{*1,2}, the projector automatically shuts off and can't be used until the lamp is replaced and the lamp operation time is reset.

*1: Duration when Lamp Mode of the Installation menu is set to Low. When it is set to Standard, this duration will be shorted.

*2: When Lamp Mode is set to Standard, this duration will be shorted to 3000 hours.

Important:

- Do not open the lamp cover when the projector is set at a ceiling or a high place. Lamp fragments may fall from the inside if the lamp were broken. Please contact your dealer when you need to replace the lamp with a new one.







































Caution:

- This projector uses a lamp that contains mercury. Disposal of the lamp or the projector with the lamp may be regulated due to environmental considerations. For disposal or recycling information, please contact your local authorities or the Electronic Industries Alliance: www.eiae.org. (For the U.S. only.)

Troubleshooting

Before asking for repair of the projector, check the following. If the symptom persists, stop using the projector, be sure to unplug the power plug, and then contact your dealer.

No image appears on the screen.

Problem	Solution																								
Power can not be turned on.	<ul style="list-style-type: none"> • Check whether the indicators are on or off and how they are lightning. <table border="1" data-bbox="488 327 1453 991"> <thead> <tr> <th data-bbox="488 327 618 359">POWER</th> <th data-bbox="618 327 743 359">STATUS</th> <th data-bbox="743 327 1453 359">Solution</th> </tr> </thead> <tbody> <tr> <td data-bbox="488 359 618 411">  Off </td> <td data-bbox="618 359 743 411">  Off </td> <td data-bbox="743 359 1453 411"> <ul style="list-style-type: none"> • Connect the power cord to the projector. • Plug the power cord into a wall outlet. </td> </tr> <tr> <td data-bbox="488 411 618 548">  Steady red </td> <td data-bbox="618 411 743 548">  Off </td> <td data-bbox="743 411 1453 548"> <ul style="list-style-type: none"> • If any objects are blocking the intake or exhaust vents, remove them and carry out the following. <ol style="list-style-type: none"> 1. Unplug the power cord from the wall outlet. 2. Make sure that the projector has cooled off. 3. Plug the power cord into the wall outlet. 4. Press the POWER button. </td> </tr> <tr> <td data-bbox="488 548 618 642">  Steady red </td> <td data-bbox="618 548 743 642">  Blinking orange </td> <td data-bbox="743 548 1453 642"> <ul style="list-style-type: none"> • If any objects are blocking the intake or exhaust vents, remove them. • Don't expose the exhaust vents to hot air emitted from a heating appliance. </td> </tr> <tr> <td data-bbox="488 642 618 758">  Steady red </td> <td data-bbox="618 642 743 758">  Blinking green </td> <td data-bbox="743 642 1453 758"> <ul style="list-style-type: none"> • After the STATUS indicator stops blinking, press the POWER button. <ul style="list-style-type: none"> • If you unplug the power cord while the fan is rotating, the lamp may not turn on about 1 minute when you plug the power cord next time. • The lamp can't turn on again for 1 minute after it goes out. • Press the POWER button several times. </td> </tr> <tr> <td data-bbox="488 758 618 821">  Steady red </td> <td data-bbox="618 758 743 821">  Steady red </td> <td data-bbox="743 758 1453 821"> <ul style="list-style-type: none"> • Replace the lamp. (The lamp is at the end of its life.) </td> </tr> <tr> <td data-bbox="488 821 618 991">  Blinking red/green </td> <td data-bbox="618 821 743 873">  Off </td> <td data-bbox="743 821 1453 873"> <ul style="list-style-type: none"> • Attach the lamp cover on the top. </td> </tr> <tr> <td data-bbox="488 873 618 991"></td> <td data-bbox="618 873 743 991">  Steady or Blinking </td> <td data-bbox="743 873 1453 991"> <ul style="list-style-type: none"> • Unplug the power cord from the wall outlet and contact your dealer. </td> </tr> </tbody> </table> 	POWER	STATUS	Solution	 Off	 Off	<ul style="list-style-type: none"> • Connect the power cord to the projector. • Plug the power cord into a wall outlet. 	 Steady red	 Off	<ul style="list-style-type: none"> • If any objects are blocking the intake or exhaust vents, remove them and carry out the following. <ol style="list-style-type: none"> 1. Unplug the power cord from the wall outlet. 2. Make sure that the projector has cooled off. 3. Plug the power cord into the wall outlet. 4. Press the POWER button. 	 Steady red	 Blinking orange	<ul style="list-style-type: none"> • If any objects are blocking the intake or exhaust vents, remove them. • Don't expose the exhaust vents to hot air emitted from a heating appliance. 	 Steady red	 Blinking green	<ul style="list-style-type: none"> • After the STATUS indicator stops blinking, press the POWER button. <ul style="list-style-type: none"> • If you unplug the power cord while the fan is rotating, the lamp may not turn on about 1 minute when you plug the power cord next time. • The lamp can't turn on again for 1 minute after it goes out. • Press the POWER button several times. 	 Steady red	 Steady red	<ul style="list-style-type: none"> • Replace the lamp. (The lamp is at the end of its life.) 	 Blinking red/green	 Off	<ul style="list-style-type: none"> • Attach the lamp cover on the top. 		 Steady or Blinking	<ul style="list-style-type: none"> • Unplug the power cord from the wall outlet and contact your dealer.
POWER	STATUS	Solution																							
 Off	 Off	<ul style="list-style-type: none"> • Connect the power cord to the projector. • Plug the power cord into a wall outlet. 																							
 Steady red	 Off	<ul style="list-style-type: none"> • If any objects are blocking the intake or exhaust vents, remove them and carry out the following. <ol style="list-style-type: none"> 1. Unplug the power cord from the wall outlet. 2. Make sure that the projector has cooled off. 3. Plug the power cord into the wall outlet. 4. Press the POWER button. 																							
 Steady red	 Blinking orange	<ul style="list-style-type: none"> • If any objects are blocking the intake or exhaust vents, remove them. • Don't expose the exhaust vents to hot air emitted from a heating appliance. 																							
 Steady red	 Blinking green	<ul style="list-style-type: none"> • After the STATUS indicator stops blinking, press the POWER button. <ul style="list-style-type: none"> • If you unplug the power cord while the fan is rotating, the lamp may not turn on about 1 minute when you plug the power cord next time. • The lamp can't turn on again for 1 minute after it goes out. • Press the POWER button several times. 																							
 Steady red	 Steady red	<ul style="list-style-type: none"> • Replace the lamp. (The lamp is at the end of its life.) 																							
 Blinking red/green	 Off	<ul style="list-style-type: none"> • Attach the lamp cover on the top. 																							
	 Steady or Blinking	<ul style="list-style-type: none"> • Unplug the power cord from the wall outlet and contact your dealer. 																							
No image appears on the screen.	<ul style="list-style-type: none"> • Cancel the AV mute by pressing the AV MUTE button. • Check that the lens cap is removed. • It may take about 1 minute for the lamp to light up. • The lamp fails to light up on rare occasions. In such a case, wait for a few minutes and then try again. • If the projector was turned off before the lamp was cooled down sufficiently last time, the fan may start rotating and the POWER button may not work after the power cord is plugged. Press the POWER button to turn back on the POWER indicator. • Check that the intake vent is clean. • Check that the lamp cover is closed. (See page 51 or 52.) • Check that the cables connected to the external devices are not broken. • When an extension cable is being used, replace it with the supplied cable for check. When images are displayed correctly, add an RGB signal amplifier to the extension cable. 																								
Power turns off.	<ul style="list-style-type: none"> • This problem may occur when the intake vent and/or exhaust vents are blocked. (In such a case, the STATUS indicator brinks orange.) <ul style="list-style-type: none"> → Remove the objects blocking the intake vent and/or exhaust vents and then carry out the following procedure. <ol style="list-style-type: none"> 1. Wait for the intake fan and/or exhaust fan to stop. (Wait until the STATUS indicator goes out.) 2. Unplug the power cord from the wall outlet. 3. Wait about 10 minutes. 4. Plug the power cord into the wall outlet. 5. Press the POWER button. • When the STATUS indicator is steady red, it is indicating that the lamp should be replaced. Replace the lamp in this case. • Check that Auto Power Off has been set to Off. • If the lamp has deteriorated, it may go out after a while it illuminates. 																								

Troubleshooting (continued)

No image appears on the screen. (continued)

Problem	Solution
The screen for entering the password appears.	<ul style="list-style-type: none"> • Password in the Password menu has been set to On to enable the password lock. → Enter the password or contact the person in charge of management of the projector. (See page 48.)
“No signal” is displayed.	<ul style="list-style-type: none"> • Turn on the power of the connected device, or check whether there is something wrong with the connected device. • Check whether the external device output signals. (Check this especially when the external device is a notebook computer.) • Check that the cable connected to the external device isn't defective. • Check that the projector is connected to the external device using the correct terminals. • Check that the connected device is correctly selected as the input source. • When an extension cord is being used, replace it with the supplied cable and check whether images are projected correctly. If images are projected correctly, use an RGB signal amplifier along with the extension cord.

Images are not displayed correctly.

Problem	Solution
Projected images are shaking. Projected images are displaced.	<ul style="list-style-type: none"> • Check that the cable connected to the external device isn't intermittent. • Connect the cable's plug with the external device's connector firmly. • Press the AUTO POSITION button. • Some computers output out-of-spec signals on rare occasion. Adjust the Signal menu. (See page 25.) • When the input signal is a WXGA video signal, confirm the setting selected in WXGA in the Option menu. • When the input signal is other than a WXGA video signal, select Off in WXGA in the Option menu.
Projected images are distorted.	<ul style="list-style-type: none"> • Adjust the projector and the screen so that they are perpendicular to each other. (See page 16.)
Projected images are dark.	<ul style="list-style-type: none"> • Adjust Brightness and Contrast in the Picture menu. (See page 31.) • Replace the lamp. (See page 51.)
Projected images are blurred.	<ul style="list-style-type: none"> • Adjust the focus. (See page 17.) • Clean the lens. • Press the ◀ or ▶ button on the remote control to eliminate flicker. • Adjust Tracking and Fine sync in the Signal menu. (See page 25.) • Adjust Brightness and Contrast in the Picture menu. (See page 31.) • Adjust the projector and the screen so that they are perpendicular to each other. (See page 16.)
Afterimages persist on the screen.	<ul style="list-style-type: none"> • This phenomenon is improved by keeping projecting an evenly bright image. (Such “image burn-in” phenomenon where afterimages persist on the screen may occur if a stationary image is kept displayed on the screen for a long time.)
White dots are seen on projected images. Black dots are seen on projected images.	<ul style="list-style-type: none"> • This phenomenon is normal for a DLP™ projector and is not a malfunction. (A very small number of pixels may visibly or invisibly be persistent all the time, but they are not a sign of system malfunctions. Over 99.99% of the pixels are effective.)
Fine streaks are seen on projected images.	<ul style="list-style-type: none"> • This is due to interference with the screen surface and is not a malfunction. Replace the screen or displace the focus a little. • Vertical or horizontal streak noise may appear on the projected image, depending on the type of the DVD player, game console or computer you use. In such a case, you can reduce such streak noise by enabling the LPF.

Troubleshooting (continued)

Images are not displayed correctly. (continued)

Problem	Solution
Projected images become wavy.	<ul style="list-style-type: none"> • Connect the plugs of the cables to external devices securely. • Keep the projector away from equipment generating interfering radio waves. • When the keystone adjustment is carried out, the image may not be displayed correctly because of the type of input signal. This isn't a product malfunction. In this case, readjust the keystone so that the amount of keystone correction is as small as possible.
Hue is not appropriate.	<ul style="list-style-type: none"> • Check that the cables connected to the external devices are not broken.
Tint in projected images is incorrect.	<ul style="list-style-type: none"> • Check that Computer Input in the Signal menu is correctly set. (See page 25.) • Check that the cable connected to the external device isn't broken.
Different color tint.	<ul style="list-style-type: none"> • When comparing images projected by two projectors, tints in the displayed images may be different because of variation between their optical components. This is not a malfunction. • When comparing the image projected by this projector with those displayed on the television or PC monitor, tints in the displayed images may be different because of difference in the range of color reproducibility. This is not a malfunction.
Only the motion areas in the images supplied from the computer aren't displayed.	<ul style="list-style-type: none"> • This is caused by the computer being used. Contact the manufacturer of your computer.
Projected images are obscured.	<ul style="list-style-type: none"> • Match the output resolution of your computer with the resolution of the projector. For the method to change the output resolution of the computer, contact the manufacturer of your computer. (See page 60.) • Some images and texts appear obscured during the keystone adjustment. In such cases, use the projector without applying the keystone adjustment. (See page 16.)
Projected images are flickering.	<ul style="list-style-type: none"> • After the POWER button or ON button on the remote has been pressed, or the Lamp Mode setting has changed, images may be flickering until the lamp lights stably. This is an expected behavior. • When selecting the input signal, Auto Position, and Image, the projected image may be flickering temporarily. This is not a product malfunction.
Projector images are twitching.	<ul style="list-style-type: none"> • Projector may be vibrating. Set Auto Keystone to Off or lower the VOLUME ▼ button of the Remote control.

Others

Problem	Solution
The exhaust vents emit warm air.	<ul style="list-style-type: none"> • This air comes out after cooling the inside of the projector. You may feel hot, but this is not a malfunction.
No audio is output.	<ul style="list-style-type: none"> • Check that the volume isn't set to low. • Check the Audio Input setting. • When the external device is connected with an HDMI cable, set the audio output of the device to PCM output.
The menu can't be used.	<ul style="list-style-type: none"> • The microcomputers inside the projector may be wrongly operating because of noise. → Press the POWER button to turn off the lamp and unplug the power cord from the wall outlet. Wait about 10 minutes, plug the power cord in, and try again.
"Temperature!!" is displayed.	<ul style="list-style-type: none"> • This indication appears when the ambient temperature rises high. When the ambient temperature stays high, the lamp goes out. → Eliminate any causes of the rise in the ambient temperature. • This indication appears when the intake or exhaust vents are blocked. When they are kept blocked, the lamp goes out. → Remove the objects blocking the intake or exhaust vents.
The Ⓞ mark appears.	<ul style="list-style-type: none"> • This mark appears when ineffective operation is carried out. This isn't a product malfunction.
The remote control doesn't function easily or at all.	<ul style="list-style-type: none"> • Check that the batteries are loaded in the remote control or the batteries are not weak. (See page 8.) • Check that the remote control sensor isn't exposed to direct sunlight or fluorescent light. (See page 8.) • Use the remote control within its operation range. (See page 8.) • Use the remote control at least 10 cm away from the projector.

Troubleshooting (continued)

Others (continued)

Problem	Solution
The fans sound during standby.	<ul style="list-style-type: none">When Standby Mode of the Efficient Mode menu in the Installation menu is set to LAN, Speaker Out, or Monitor Out, the fans rotate at very low speed during standby after plugging the power cord (with 5 second high speed rotation at the beginning) and after turning off the lamp. This is to cool down the projector operating various functions during standby and is not a malfunction.
Abnormal sound is heard.	<ul style="list-style-type: none">Because the color wheel spins at a high speed, metallic sounds may be heard in rare occasions. Such symptom is not a malfunction.

If the following problem occurs after the lamp is replaced, check the following first.

Problem	Solution
The projector does not turn on.	<ul style="list-style-type: none">Fit the lamp cover securely. (See page 51 or 52.)Reset the lamp operating time. (See page 52.)
The STATUS indicator blinks.	<ul style="list-style-type: none">Reset the lamp operating time. (See page 52.)

Maintenance

Warning:

- Do not use flammable solvents (benzene, thinner, etc.) and flammable aerosols when cleaning the projector body and lens. Flammable substances may ignite causing fire or breakdown while the lamp is illuminating.

Caution:

- Be sure to turn off the lamp and unplug the power cord from the wall outlet before you perform any maintenance on the projector.
- Ask your dealer for annual cleaning of the inside of the projector. If you continue to use the projector with dust inside, it may result in fire or malfunction.

Cleaning of the projector and the vents

Use a soft cloth to clean the projector and the vents. When the vents become dirty, wipe them with a soft cloth dampened with diluted mild detergent, and then wipe them with a dry cloth.

To protect the surface of the projector from fading or deteriorating:

- Do not spray insecticide on or inside the projector.
- Do not use benzine or thinner to clean it.
- Do not let rubber or plastic materials contact with projector.

Cleaning of the lens

Use a standard lens-cleaning brush or a piece of lens tissue dampened with lens cleaning fluid. The lens surface is fragile. Use only recommended, nonabrasive lens-cleaning materials. Do not touch the lens with your fingers.

Kensington Lock

This projector has a Kensington Security Standard connector for use with Kensington MicroSaver Security System. Refer to the information that came with the Kensington System for instructions on how to use it to secure the projector. Please contact Kensington Technology Group below.

Kensington Technology Group
2855 Campus Drive
San Mateo, CA 94403, U.S.A.
Phone: +1- (650)572-2700 Fax: +1- (650)572-9675

Indicators

This projector has two indicators, each of which shows the operation condition of the projector. The following offer solutions to possible problems. If these problem persist, turn the projector off and consult your dealer.

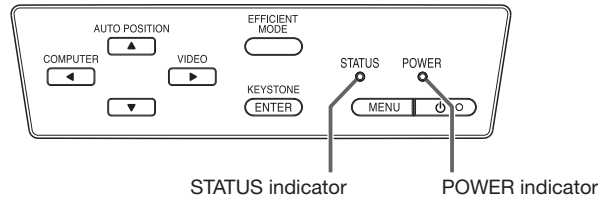

Normal condition

POWER	STATUS	CONDITION	NOTE
 Steady red	 Off	Stand-by	
	 Blinking green	Lamp stand-by for power-off	The power cannot be turned on by pressing the POWER button.
 Steady green	 Blinking green	Lamp stand-by for power-on	The power cannot be turned off by pressing the POWER button.
	 Steady green	The power is on. (Normal condition)	

Abnormal condition

POWER	STATUS	CONDITION	POSSIBLE SOLUTION
 Steady green or Steady red	 Blinking orange	Abnormal temperature <ul style="list-style-type: none"> The vents are clogged with dust or dirt. The room temperature is high. 	<ul style="list-style-type: none"> Clean the vents. Relocate the projector to a cooler place.
 Steady red	 Blinking green	The protection circuit is working or the lamp is in an abnormal condition.	<ul style="list-style-type: none"> Wait until the STATUS indicator goes out, then press the POWER button. If the above solution is not effective, replace the lamp.
 Steady green	 Blinking green/red	The lamp operation time exceeds the time elapsed until the lamp lifetime notice while the power is on. (See page 52.)	Replace the lamp. Change with a new lamp if this problem recurs.
 Steady red	 Blinking red	The lamp operation time exceeds the time elapsed until the lamp lifetime notice while the power is off. (See page 52.)	
 Steady red	 Steady red	The lamp operation time exceeds the time elapsed until the lamp lifetime. (See page 52.)	
 Blinking green/red	 Off	The lamp cover isn't closed.	Close the cover correctly.
 Blinking green/red	 Steady or Blinking	Abnormal.	Contact your dealer.

Specifications

Type	DLP™ projector	
Model	XD700U	WD720U
Rated power supply	100 - 240 V AC, 50/60 Hz	
Power consumption	4.1 A During standby: 0.5W (when Standby Mode is Low)	
Display Technology	0.7-inch single chip Digital Micromirror Device (DMD) Pixels: 1024 x 768 = 786432 pixels	0.65-inch single chip Digital Micromirror Device (DMD) Pixels: 1280 x 800 = 1024000 pixels
Colors	16770000 colors	
Projection lens	F 2.4-2.8, f = 20.6-30.1 mm	
Light source lamp	280 W	
Picture size	40 - 300 inch (Wide) (aspect ratio 4:3)	40-300 inch (Wide) (aspect ratio 16:10)
PC compatibility	Resolution: 640 x 480 (Expand) - 1024 x 768 (Real) - 1600 x 1200 (Compress) Sync on Green available	Resolution: 640 x 480 (Expand) - 1280 x 800 (Real) - 1600 x 1200 (Compress) Sync on Green available
Video compatibility	NTSC/NTSC 4.43/PAL (including PAL-M, N)/SECAM/PAL-60 Component Video (DVD/HDTV) (480i, 576i, 480p, 576p, 1080i, 720p, 1080p)	
Speaker	10 W mono x 1	
S-video input	Luminance signal: 1.0 Vp-p 75 Ω (negative sync.) Chroma signal: 0.286 Vp-p 75 Ω (burst signal)	
Video input	1.0 Vp-p 75 Ω (negative sync.)	
Audio input	350 mVrms, 10 kΩ or more	
Analog RGB input	RGB: 0.7 Vp-p 75 Ω (negative sync.) YP _B P _R /YC _B C _R : Y: 1.0 Vp-p (negative sync.) P _B P _R /C _B C _R : 0.7 Vp-p HD/CS: TTL level (positive or negative) VD: TTL level (positive or negative)	
HDMI input	HDMI 19-pin HDMI interface (TMDS single link) (only PCM audio is supported)	
Control connector	SERIAL terminal (RS-232C), LAN terminal (RJ-45)	
Outside dimensions	345 x 134 x 270 mm (width x height x depth)	
Weight	Approx. 4.1 kg	
Length of power cord	71 inch (1.8 m)	
Temperature, humidity (performance guaranteed)	+41°F (+5°C) - +95°F (+35°C), 30 - 90%	

- The specifications and outside appearance of the projector are subject to change without prior notice.

Specifications (continued)

Connectors

COMPUTER/COMPONENT VIDEO IN, MONITOR OUT (mini D-SUB 15-pin)

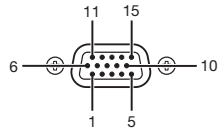

COMPUTER/COMPONENT VIDEO IN

Pin No.	Spec.
1	R (RED)/C _R
2	G (GREEN)/Y
3	B (BLUE)/C _B
4	GND
5	GND
6	GND
7	GND
8	GND
9	DDC 5V
10	GND
11	GND
12	DDC Data
13	HD/CS
14	VD
15	DDC Clock

MONITOR OUT

Pin No.	Spec.
1	R (RED)/C _R
2	G (GREEN)/Y
3	B (BLUE)/C _B
4	-
5	GND
6	GND
7	GND
8	GND
9	-
10	GND
11	-
12	-
13	HD/CS
14	VD
15	-

HDMI (HDMI 19-pin)

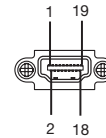

Pin No.	Spec.
1	TMDS Data 2 +
2	TMDS Data 2 Shield
3	TMDS Data 2 -
4	TMDS Data 1 +
5	TMDS Data1 Shield
6	TMDS Data 1 -
7	TMDS Data 0 +
8	TMDS Data 0 Shield
9	TMDS Data 0 -
10	TMDS Clock +
11	TMDS Clock Shield
12	TMDS Clock -
13	CEC
14	-
15	SCL
16	SDA
17	DDC Ground
18	+5 V Power
19	Hot Plug Detect

Dimension drawings (unit: mm)

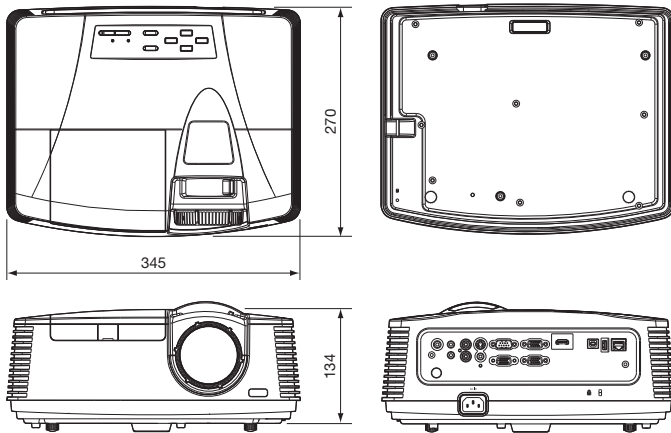

What's included in the box

AC power cord*	for the U.S.	J2552-0063-03	Remote control
	for Europe	J2552-0247-00	Safety Manual/Quick Start up
	for the U.K.	J2552-0065-02	CD-ROM
	for Australia	J2552-0053-00	Battery (2)
	for South Korea	J2552-0247-00	Lens cap
Computer cable		J2552-0072-05	Soft case
			Lamp replacement attachment

* One of power cords for the U.S., Europe, U.K., Australia, and South Korea is provided appropriately.

Replacement part (option/not included in the box)

Spare lamp: VLT-XD700LP

Specifications (continued)

Specification of RGB signals in each computer mode of the projector

Signal mode	Resolution (H x V)	Horizontal frequency (kHz)	Vertical frequency (Hz)	XD700U (H x V)	WD720U (H x V)	
TV60, 480i (525i)	-	15.73	59.94	1024 x 768	1066 x 800	*2 *4
TV50, 576i (625i)	-	15.63	50.00	1024 x 768	1066 x 800	*2
1080i 60 (1125i 60)	-	33.75	60.00	1024 x 576	1280 x 720	*2 *3
1080i 50 (1125i 50)	-	28.13	50.00	1024 x 576	1280 x 720	*2 *3
480p (625p)	-	31.47	59.94	1024 x 768	1066 x 800	*2 *3 *4
576p (625p)	-	31.25	50.00	1024 x 768	1066 x 800	*2 *3
720p 60 (750p 60)	-	45.00	60.00	1024 x 576	1280 x 720	*2 *3 *4
720p 50 (750p 50)	-	37.50	50.00	1024 x 576	1280 x 720	*2 *3
1080p 60 (1125p 60)	-	67.50	60.00	1024 x 576	1280 x 720	*2 *3
1080p 50 (1125p 50)	-	56.25	50.00	1024 x 576	1280 x 720	*2 *3
CGA84	640 x 400	37.86	84.13	1024 x 640	1280 x 800	
CGA85	640 x 400	37.86	85.08	1024 x 640	1280 x 800	
VGA60	640 x 480	31.47	59.94	1024 x 768	1066 x 800	*3 *4
VGA72	640 x 480	37.86	72.81	1024 x 768	1066 x 800	
VGA75	640 x 480	37.50	75.00	1024 x 768	1066 x 800	
VGA85	640 x 480	43.27	85.01	1024 x 768	1066 x 800	
SVGA56	800 x 600	35.16	56.25	1024 x 768	1066 x 800	
SVGA60	800 x 600	37.88	60.32	1024 x 768	1066 x 800	*3 *4
SVGA72	800 x 600	48.08	72.19	1024 x 768	1066 x 800	
SVGA75	800 x 600	46.88	75.00	1024 x 768	1066 x 800	
SVGA85	800 x 600	53.67	85.06	1024 x 768	1066 x 800	
XGA60	1024 x 768	48.36	60.00	1024 x 768	1066 x 800	*3 *4
XGA70	1024 x 768	56.48	70.07	1024 x 768	1066 x 800	
XGA75	1024 x 768	60.02	75.03	1024 x 768	1066 x 800	
HP75	1024 x 768	62.94	74.92	1024 x 768	1066 x 800	
XGA85	1024 x 768	68.68	85.00	1024 x 768	1066 x 800	
XGA120	1024 x 768	97.55	119.99	1024 x 768	1066 x 800	*3 *4
SXGA70a	1152 x 864	63.85	70.01	1024 x 768	1066 x 800	
SXGA75a	1152 x 864	67.50	75.00	1024 x 768	1066 x 800	
SXGA85a	1152 x 864	77.49	85.06	1024 x 768	1066 x 800	
WXGA60	1280 x 768	47.77	59.87	1024 x 614	1280 x 768	
WXGA60a	1280 x 800	49.70	59.81	1024 x 640	1280 x 800	*3 *4
WXGA60b	1360 x 768	47.71	60.01	1024 x 578	1280 x 722	
WXGA60c	1366 x 768	47.71	59.79	1024 x 575	1280 x 720	*1 *2
WXGA120a	1280 x 800	101.56	119.91	1024 x 640	1280 x 800	*3 *4
SXGA60b	1280 x 960	60.00	60.00	1024 x 768	1066 x 800	*3
SXGA75b	1280 x 960	75.00	75.00	1024 x 768	1066 x 800	
SXGA85b	1280 x 960	85.94	85.00	1024 x 768	1066 x 800	
SXGA60	1280 x 1024	63.98	60.02	960 x 768	1000 x 800	*3
SXGA75	1280 x 1024	79.98	75.02	960 x 768	1000 x 800	
SXGA85	1280 x 1024	91.15	85.02	960 x 768	1000 x 800	
SUN66a	1152 x 900	61.85	66.00	984 x 768	1024 x 800	
SUN76a	1152 x 900	71.81	76.64	984 x 768	1024 x 800	
SUN66	1280 x 1024	71.68	66.68	960 x 768	1000 x 800	
SUN76	1280 x 1024	81.13	76.11	960 x 768	1000 x 800	
SIG72	1280 x 1024	76.92	72.30	960 x 768	1000 x 800	
SIG76	1280 x 1024	82.01	76.00	960 x 768	1000 x 800	
WXGA+60	1440 x 900	55.94	59.89	1024 x 640	1280 x 800	*3
SXGA+60	1400 x 1050	65.32	59.98	1024 x 768	1066 x 800	*3
SXGA+75	1400 x 1050	82.28	74.87	1024 x 768	1066 x 800	
UXGA60	1600 x 1200	75.00	60.00	1024 x 768	1066 x 800	*3
MAC13	640 x 480	35.00	66.67	1024 x 768	1066 x 800	
MAC16	832 x 624	49.72	74.55	1024 x 768	1066 x 800	
MAC19	1024 x 768	60.24	75.02	1024 x 768	1066 x 800	

*1: When you input the signals WXGA60, WXGA60a, WXGA60b, or WXGA60c, select the supported image size from WXGA of the Option menu.

*2: The MAGNIFY mode is not supported.

*3: The HDMI terminal is available for these signals.

*4: The signals can be displayed with viewing 3D contents on the projector. If a different signal is inputted, the projector shows no 3D contents even with the 3D option set to On in the Picture menu.

3D image may not appear on the screen depending on the PC performance such as graphics board, memory, or CPU.

When 3D image is projected on the screen in 120Hz or using certain type of playback software of PC, the image may not appear on the screen.

Important:

- Some computers aren't compatible with the projector.
- The projector's maximum resolution is 1024 x 768 pixels (XD700U) or 1280 x 800 pixels (WD720U). It may not display images of higher resolutions than its maximum resolution correctly.
- Images with SYNC on G (Green) signal may jitter.
- Images with SYNC on G (Green) signal may be tinged with green.
- If the resolution and frequency of your computer aren't shown on the table, find the compatible resolution and frequency by changing the resolution of your computer.
- Set Computer Input in the Signal menu to RGB when inputting the HDTV signal as RGB signal.
- TV60 and TV50 are equivalent to 480i and 576i respectively. When these signals are supplied to the VIDEO or S-VIDEO terminal, the signal mode is indicated as TV60 or TV50. When they are supplied to the COMPONENT terminal, the signal mode is indicated as 480i or 576i.

 **MITSUBISHI ELECTRIC CORPORATION**
1 Zusho Baba, Nagaokakyo-City, Kyoto Japan