

myprojectorlamps.com

**The most trusted, dependable name
in projector lamp sales.**



<http://www.myprojectorlamps.com>



<http://www.myprojectorlamps.ca>



<http://www.myprojectorlamps.eu>

The following projector manual has not been modified or altered in any way.

marantz®

Model VP-10S1 User Guide

DLP™ Projector



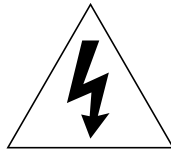
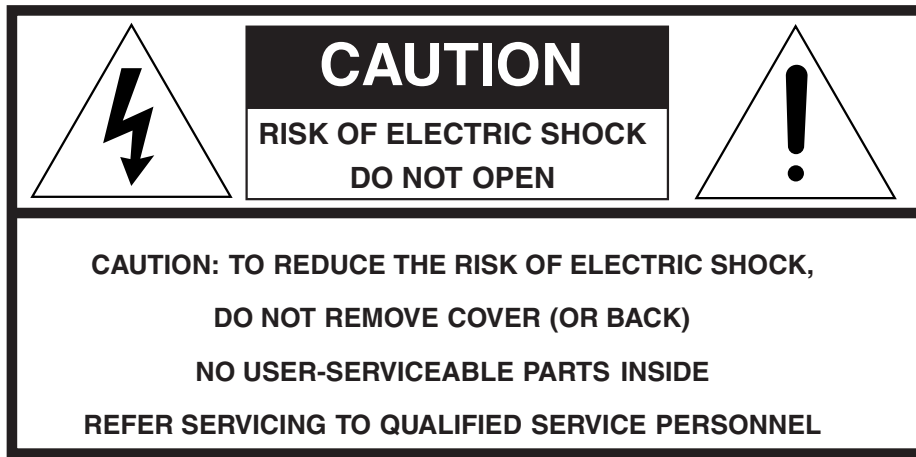

The lightning flash with arrowhead symbol within an equilateral triangle is intended to alert the user to the presence of uninsulated “dangerous voltage” within the product’s enclosure that may be of sufficient magnitude to constitute a risk of electric shock to persons.



The exclamation point within an equilateral triangle is intended to alert the user to the presence of important operating and maintenance (servicing) instructions in the literature accompanying the product.

WARNING

TO REDUCE THE RISK OF FIRE OR ELECTRIC SHOCK,
DO NOT EXPOSE THIS PRODUCT TO RAIN OR MOISTURE.

CAUTION: TO PREVENT ELECTRIC SHOCK, MATCH WIDE BLADE OF PLUG TO WIDE SLOT, FULLY INSERT.

ATTENTION: POUR ÉVITER LES CHOCS ÉLECTRIQUES, INTRODUIRE LA LAME LA PLUS LARGE DE LA FICHE DANS LA BORNE CORRESPONDANTE DE LA PRISE ET POUSSER JUSQU’AU FOND.

For the customers in the USA:

This equipment has been tested and found to comply with the limits for a Class B digital device, pursuant to Part 15 of the FCC Rules. These limits are designed to provide reasonable protection against harmful interference in a residential installation. This equipment generates, uses and can radiate radio frequency energy and, if not installed and used in accordance with the instructions, may cause harmful interference to radio communications. However, there is no guarantee that interference will not occur in a particular installation. If this equipment does cause harmful interference to radio or television reception, which can be determined by tuning the equipment off and on, the user is encouraged to try to correct the interference by one or more of the following measures:

- Reorient or relocate the receiving antenna.
- Increase the separation between the equipment and receiver.
- Connect the equipment into an outlet on a circuit different from that to which the receiver is connected.
- Consult the dealer or an experienced radio/TV technician for help.

NOTE:

Changes or modifications not expressly approved by the party responsible for compliance could void the user’s authority to operate the equipment.

For the customers in Canada:

This Class B digital apparatus meets all requirements of the Canadian Interference-Causing Equipment regulations.

IMPORTANT SAFETY INSTRUCTIONS

READ BEFORE OPERATING EQUIPMENT

This product was designed and manufactured to meet strict quality and safety standards. There are, however, some installation and operation precautions which you should be particularly aware of.

1. Read these instructions - All the safety and operating instructions should be read before the product is operated.
2. Keep these instructions - The safety and operating instructions should be kept for future reference.
3. Heed all warnings - All warnings on the product and in the operating instructions should be adhered to.
4. Follow all instructions - All operating and use instructions should be followed.
5. Do not use this apparatus near water - Do not use this product near water-for example, near a bath tub, wash bowl, kitchen sink, or laundry tub, in a wet basement, or near a swimming pool, and the like.
6. Clean only with dry cloth - Unplug this product from the wall outlet before cleaning. Do not use liquid cleaners or aerosol cleaners. Use a dry cloth for cleaning.
7. Do not block any ventilation openings. Install in accordance with the manufacture's instructions.
8. Do not install near any heat sources such as radiators, heat registers, stoves, or other apparatus (including amplifiers) that produce heat.
9. Do not defeat the safety purpose of the polarized or grounding-type plug. A polarized plug has two blades with one wider than the other. A grounding type plug has two blades and a third grounding prong. The wide blade or the third prong are provided for your safety. If the provided plug does not fit into your outlet, consult an electrician for replacement of the obsolete outlet.

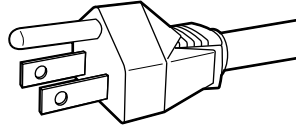

AC GROUNDING-TYPE PLUG

10. Protect the power cord from being walked on or pinched particularly at plugs, convenience receptacles, and the point where they exit from the apparatus.
11. Only use attachments/accessories specified by the manufacturer.
12. Use only with the cart, stand, tripod, bracket, or table specified by the manufacturer, or sold with the apparatus. When a cart is used, use caution when moving the cart/apparatus combination to avoid injury from tip-over.



13. Unplug this apparatus during lightning storms or when unused for long periods of time.
14. Refer all servicing to qualified service personnel. Servicing is required when the apparatus has been damaged in any way, such as power-supply cord or plug is damaged, liquid has been spilled or objects have fallen into the apparatus, the apparatus has been exposed to rain or moisture, does not operate normally, or has been dropped.
15. This product should not be placed in a built-in installation such as a bookcase or rack unless proper ventilation is provided or the manufacturer's instructions have been adhered to.
16. To prevent fire or shock hazard, do not place objects filled with liquids, such as vases, on the apparatus.

This Class B digital apparatus complies with Canadian ICES-003.

Cet appareil numérique de la Classe B est conforme à la norme NMB-003 du Canada.

Lamp Handling Precautions

DANGER

The P-VIP lamp is a high voltage glass mercury vapor lamp. The lamp can break or fail to light if handled wrongly during replacement or because of temperature in the room where the projector is being used or stored.

Lamp life also varies according to the lamp with some even breaking or burning out as soon as they are used the first time. If the lamp breaks, glass fragments may be scattered inside the lamp unit and projector, and mercury gas from the bulb may seep from the projector's vent.

Before use, carefully read the User Guide of the projector and the Lamp Replacement Instructions. Remember to handle the lamp with care. In the event of serious trouble, call for Marantz authorized dealer.

- Never look directly into the lamp with unprotected eyes while lit. The bright light can cause sore eyes and impair vision.
- Never directly expose skin to the light of the lamp. Direct exposure can inflame the skin.
- Do not drop, impact, subject to excessive force or otherwise damage the lamp.
- Replacing the lamp runs the risk of burns and electric shock, therefore shut off power supply, unplug the AC power cable from its electrical outlet and wait at least 60 min for the lamp to cool down before attempting to replace it.
- If the lamp breaks, unplug the AC power cable from its electrical outlet and call for Marantz authorized dealer to replace it. Do not replace the lamp yourself or clean up broken glass inside the projector as this can result in cuts as well as scratching inside the projector.
- If the projector is hung from a ceiling or installed in a high place, it is extremely dangerous to replace the lamp. In this case, do not replace or service the lamp yourself.

CAUTION

- The chance of the lamp breaking is high after extended use. It is recommended to replace the lamp when near the end of its designed life. Do not use a lamp beyond the maximum lighting time.
- Use only Marantz original lamp units. Check the model code of the lamp unit matches that in this User Guide.
- Before replacing the lamp, read carefully "Lamp Unit Replacement" in this User Guide. Replace the lamp as explained therein.
- Entrust disposal of a used lamp to a licensed industrial waste handler or return it to the place of purchase. Do not break the lamp or discard with general waste.
- If the lamp breaks, leave the area immediately and stay away for at least 30 min, and ventilate the room so as not to inhale the mercury vapor.
- If you inhale the mercury vapor, see a physician immediately.

Précautions à prendre pour manipuler la lampe

DANGER

La lampe P-VIP est une lampe à vapeur de mercure en verre à haute tension. La lampe peut se casser ou ne pas s'allumer si elle est manipulée de manière incorrecte pendant son remplacement ou du fait de la température dans la pièce où le projecteur est utilisé ou rangé.

La durée de service des lampes varie aussi en fonction de la lampe, certaines se cassant ou grillant même dès leur première utilisation. Si la lampe se casse, des fragments de verre peuvent s'éparpiller à l'intérieur de l'unité lampe et du projecteur, et le mercure de l'ampoule peut fuir par l'orifice de ventilation du projecteur.

Avant d'utiliser la lampe, lisez attentivement le Guide de l'utilisateur du projecteur et les Instructions de remplacement de la lampe. Pensez à manipuler la lampe avec précautions. En cas de problème sérieux, contactez un distributeur agréé Marantz.

- Ne regardez jamais directement la lampe sans vous protéger les yeux lorsqu'elle est allumée. La forte lumière pourrait irriter vos yeux et affaiblir votre vue.
- N'exposez jamais directement la peau à la lumière de la lampe. Une exposition directe peut enflammer la peau.
- Ne laissez pas tomber la lampe, ne la heurtez pas, ne lui appliquez pas de force excessive ou ne la détériorez pas.
- Le remplacement de la lampe fait courir un risque de brûlures et de décharge électrique ; coupez l'alimentation, débranchez le câble d'alimentation secteur de sa prise électrique et attendez au moins 60 min. que la lampe refroidisse avant d'essayer de la remplacer.
- Si la lampe se casse, débranchez le câble d'alimentation secteur de sa prise électrique et contactez un distributeur agréé Marantz pour qu'il la remplace. Ne remplacez pas la lampe vous-même ni ne nettoyez le verre brisé à l'intérieur du projecteur, car vous pourriez vous couper et rayer également l'intérieur du projecteur.
- Si le projecteur est suspendu à un plafond ou est installé dans un endroit en hauteur, il est extrêmement dangereux de remplacer la lampe. Dans ce cas, ne remplacez pas ni n'entretenez la lampe vous-même.

ATTENTION

- Le risque que la lampe se casse est élevé après une utilisation prolongée. Il est recommandé de remplacer la lampe lorsque la fin de sa durée de service spécifiée est proche. N'utilisez pas une lampe au-delà de la durée d'éclairage maximum.
- N'utilisez que des unités lampes d'origine Marantz. Vérifiez que le code de modèle de l'unité lampe correspond à celui indiqué dans ce Guide de l'utilisateur.
- Avant de remplacer la lampe, lisez attentivement la section "Remplacement de l'unité lampe" dans ce Guide de l'utilisateur. Remplacez la lampe conformément aux explications qui y sont données.
- Pour jeter une lampe usée, remettez-la à un éliminateur de déchets industriels agréé ou rappez-la à l'endroit où vous l'avez achetée. Ne cassez pas la lampe ni ne la jetez avec les ordures ménagères.
- Si la lampe se casse, sortez immédiatement de la pièce et n'y rentrez pas pendant au moins 30 min., puis aérez la pièce afin de ne pas inhaler la vapeur de mercure.
- Si vous inhalez la vapeur de mercure, consultez immédiatement un médecin.

TABLE OF CONTENTS

PRECAUTIONS IN USE	2
Precautions in Relocation.....	2
Precautions in Installation	2
Precautions in Operation.....	2
Lamp Replacement Precautions	3
Lens Changes	3
FEATURES	4
ACCESSORIES	5
NAMES AND FUNCTIONS OF PARTS	6
Front and Top	6
Rear and Terminals.....	7
Bottom	7
Remote Controller	8
Remote Controller Operating Range.....	9
How to Load Batteries into the Remote Controller	9
INSTALLATION	10
How to Install	10
Screen Size and Projection Distance (16:9 Screen) - (inch)	11
Screen Size and Projection Distance (16:9 Screen) - (m).....	12
Screen Size and Projection Distance (4:3 Screen) - (inch)	13
Screen Size and Projection Distance (4:3 Screen) - (m).....	14
CONNECTIONS	15
Connecting the AC Power Cable.....	15
Connecting to Video Equipment.....	15
Connecting to an HD-Video, Satellite, Cable Tuner or PC	16
Connecting to a Home Theater System	16
INITIAL SETTING	17
Activating the Power.....	17
Focusing and Zooming.....	17
Positioning the Projected Image.....	18
Keystone Correction.....	19
BASIC OPERATIONS	20
Activating the Power.....	20
Shutting Power OFF.....	20
Selecting an Input signal	21
Selecting Aspect Mode.....	21
When Using a 16:9 Screen	22
When Using a 4:3 Screen	23
MENU OPERATIONS	24
Menu Structure	24
How to Operate Menus	25
Picture Adjust	26
Fine Menu	27
Setting	29
System	30
Display	31
Configuration	32
Trigger 2	33
Preset	34
MAINTENANCE	35
Lamp Life and Replacement	35
Lamp Unit Replacement.....	36
Color Temperature Adjustment	38
Lens Cleaning	39
Replacement Parts.....	39
Optional Accessories.....	39
SPECIFICATIONS	40
GLOSSARY	41
TROUBLESHOOTING	42
ERROR MODE	43
ON SCREEN MESSAGE	43
DIMENSIONS	44

PRECAUTIONS IN USE

Precautions in Relocation

- Hold the projector by the grooves in the bottom when relocating. Work in group of 4 or more to carry the projector.

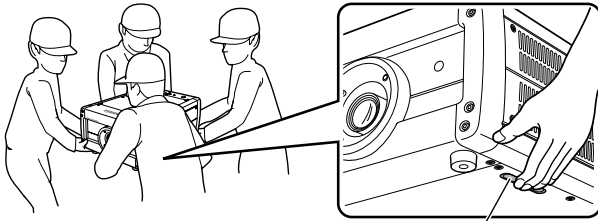

Hold projector by this groove.

- Ensure sufficient space around the projector when relocating the unit. Do not carry the projector through narrow places, up/down stairs or anywhere that poses danger.
- Never drag or roll the projector when relocating the unit.
- Unplug the AC power cable and disconnect any other cables from the projector before relocating the unit.
- If the projector is hung from a ceiling or installed in a high place, do not detach and relocate the unit yourself. Contact your nearest Marantz Authorized Dealer or Service Center.
- This projector is heavy. Use due caution not to drop it or strain your back when lifting the unit.

Precautions in Installation

- If installing the projector on a flat surface, select a location that is level, stable and sturdy enough to support the projector's weight.
- Keep the projector 11 13/16 inch (30 cm) or more from walls and other equipment when installed. If locating in a rack or similar arrangement, ensure a clearance of 3 15/16 inch (10 cm) or more from the top surface of the equipment below it as well as a clearance of 11 13/16 inch (30 cm) or more from objects on all sides.
- To hang the projector from a ceiling, contact the Marantz Authorized Dealer or Service Center. To ensure safe installation, the ceiling must be reinforced to support the projector's weight. Do not install the projector yourself. Hanging the projector from the ceiling requires a separately solder hanger and pole.
- Use a 100-120V/220-240V AC, 50/60 Hz, 5 A power supply to run the projector.
- To maintain projector performance, do not install the projector in humid, dusty or smoky places.

- Do not install the projector in extremely hot or cold places.
Operating temperature : 50°F to 95°F (10°C to 35°C)
Storage temperature : -4°F to 140°F (- 20°C to +60°C)
Altitude : 0 to 4,900 ft (0 to 1,500 m)
above sea level

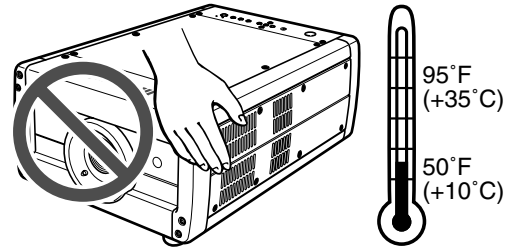

- If installed on a flat surface, keep objects off the projector.
- If installed on a ceiling, do not hang from or hook anything on the projector.

Precautions in Operation

- Never look directly into the lamp with unprotected eyes while lit.
- Never directly expose skin to the light of the lamp.
- When used in a dark room, the projected images (special images, flashing lights and images, flashing vivid reds, inverted images of strong contrast, sudden scene changes, etc.) may have harmful effects on viewers. Keep the room as bright as possible for viewing and watch from a suitable distance.
- The vent, lamp cover and adjacent areas may get extremely hot during use. Do not touch these areas during use as it may result in burns.
Also, wait at least 60 min after shutting off the power for the projector to cool down.

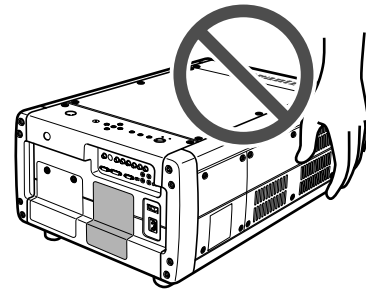

- If the cooling fan vent is blocked, a protective circuit trips and automatically shuts off the lamp. However, there is nothing wrong with the equipment. In such case, unplug the AC power cable from its electrical outlet and wait at least 10 min. Then, remove the obstruction from in front of the vent and plug the power cable back into its electrical outlet. The projector will resume normal operation.
- This projector is not intended for business use. Marantz assumes no responsibility whatsoever for damages caused directly or indirectly during use for business purposes or by trouble that occurs during such use.

Lamp Replacement Precautions

- Replacing the lamp runs the risk of burns and electric shock, therefore shut off power supply, unplug the AC power cable from its electrical outlet and wait at least 60 min for the lamp to cool down before attempting to replace it.
- If the lamp breaks, contact your nearest Marantz Authorized Dealer or Service Center.

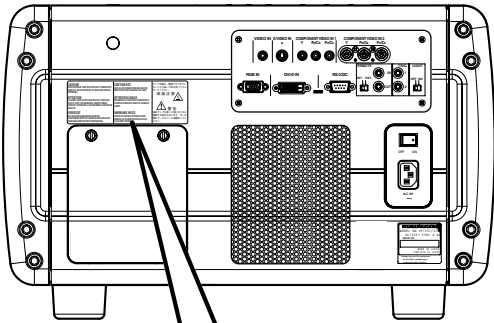

<p>CAUTION HIGH-PRESSURE LAMP MAY EXPLODE IF IMPROPERLY HANDLED. REFER SERVICING TO QUALIFIED SERVICE PERSONNEL.</p> <p>ATTENTION LA LAMPE SOUS HAUTE PRESSION PEUT EXPLOSER SI ELLE N'EST PAS MANIPULEE CORRECTEMENT. CONFIEZ L'OPERATION A UN PERSONNEL D'ENTRETIEN QUALIFIE.</p> <p>VORSICHT BEI FALSCHER HANDHABUNG KANN DIE HOCHDRUCKLAMPE EXPLODIEREN UBERLASSEN SIE WARTUNGSARBEITEN NUR FACHPERSONAL.</p>	<p>CAUTION HOT UNPLUG THE POWER CORD AND WAIT 60 MINUTES BEFORE CHANGING THE LAMP.</p> <p>ATTENTION CHAUD DEBRANCER LE CORD ON D'ALIMENTATION ET ATENDER 60 MINUTES AVANT DE CHANGER LAMPE.</p> <p>WARNUNG HEISS ZIEHEN SIE DEN NETZSTECKER AB UND WARTEN SIE 60 MINUTEN BEVOR SIE DIE GLUHLAMPE WECHSELN.</p>	<p>ラ セ 行</p> <p>高 破 際 だ</p>
--	---	---

- Before replacing the lamp, read carefully “Lamp Handling Precautions” (pg. iii) and “Lamp Unit Replacement” (pg. 36). Replace the lamp as explained therein.

Lens Changes

- The lens of this projector can be changed as liked. (LN-10VP32/LN-10VP40/LN-10VP53) With the right lens, you can set the projection distance and screen size according to the environment of use.

Lens	Projection distance of 100 inch image
LN10VP32	Approx. 125.51 to 156.88 inch
LN10VP40	Approx. 159.88 to 209.18 inch
LN10VP53	Approx. 209.18 to 313.77 inch

* The above projections distances are given for a screen with an aspect ratio of 16:9. For screen sizes and projection distances by lens, see pg. 11-14.

- To change the lens, contact your nearest Marantz Authorized Dealer or Service Center. Do not change the lens yourself.
- The lenses used with this projector are as follows.

Projector (Found on rear panel nameplate)	Lens
VP10S1/U1S SHT(32)	LN10VP32
VP10S1/U1S STD(40)	LN10VP40
VP10S1/U1S LNG(53)	LN10VP53

Note: Pixel defects

DMD™ (Digital Micromirror Device™) is one of the most advanced technologies for consumer products. The DMD™ made by high precision technology, however some pixel defects may be found on the projected image. We are trying our best to control the quality in order to reduce the number of defective pixels. It is almost impossible to have zero pixel defects, even using the most advanced technology. This is not a problem only for Marantz, but all DLP™ projector manufactures. Therefore we have to note that the warranty does not cover the DMD™ for pixel defects. We appreciate your understandings.

Note: Lamp

P-VIP lamp is one of the most advanced technologies for consumer products. The lamp made by high precision technology, however some lamps might be failing before it reaches its life. And projector's brightness is getting darker along with accumulated lamp usage hours. We are trying our best to control the quality in order to reduce lamp failures. It is almost impossible to have zero failure, even using the most advanced technology. This is not a problem only for Marantz, but all projector manufactures. Therefore we have to note that the warranty does not cover the P-VIP lamp for lamp failures: explosion, and non-lighting except initial use. And also we have to note that the warranty does not cover the P-VIP lamp for lamp failures: flickering, and getting darker along with accumulated lamp usage hours. We appreciate your understandings.

FEATURES

- High Picture Quality Technology -

❖ DLP™ technology to deliver a high contrast ratio (3600:1)

- Incorporates three HD2 DMD™ elements (1280 x 720 pixel, 16:9 wide panel) to distinctly reproduce R/G/B colors. Using an optimized system for movie viewing with the below image circuit and optical parts, the VP-10S1 brings high color reproduction and rich tones that balance pitch black with bright white to images.

❖ Built-in image processing IC by Faroudja to project high quality video images

- Images are sharply detailed, smooth and high quality owing to a powerful 3-chip set that builds into a dedicated processor an image processing IC featuring Faroudja's proud "DCDi™" high quality contouring technology, "high performance adaptive IP conversion" and "2-3 pull-down capabilities".

- Wide Array of Features -

❖ Motorized zoom, focus and vertical / horizontal lens shift

- Using the included remote controller or by operating buttons on the projector, the user can zoom in/out, focus the image, and vertically and horizontally shift the lens.

❖ Automatic color temperature adjustment

- Using the included color temperature sensor, the VP-10S1 automatically adjusts color temperature after lamp changes or as lighting changes over time.

❖ Image quality adjustment capabilities for making images as one prefers

- 4 picture modes to select as demanded by the listening / viewing environment and image source (Theater, Standard, Dynamic and User)
- Fine-adjustment menus that allow the user to adjust images as they like
- 12 user memory for saving adjusted images
- Color temperature setting (5250K, 5800K, 6500K, 7500K, 9300K)
- Black level adjustment (0 IRE, 7.5 IRE/ EXPAND, NORMAL [For DVI-D input])

- Create a Comfortable Home Theater Environment -

❖ Versatile input support including high-vision satellite broadcast

- Supports input of NTSC, PAL, SECAM and high-vision satellite broadcasts (480i, 480p, 720p, 1035i, 1080i).
- Rich array of input jacks including HDCP supported DVI-D digital input jack and dual system component jacks

❖ Easy to install and operate

- Motorized lens shift feature for vertically and horizontally positioning the projection point
- Digital correction of horizontal-vertical keystone distortion
- Projection modes for ceiling-mount projection and rear projection
- Light-up luminous remote control
- Light-up I/O jacks for easy connections and setup in dark environments
- Equipped with RS-232C port and 12V trigger terminal for custom installation
- Marantz system bus port

❖ Designed for silence and safety

- Low operating noise thanks to double-shielded construction and fan speed control
- Highly rigid to minimize radiating noise
- 1,500 hr long-life 250W P-VIP lamp

– DLP, Digital Micromirror Device and DMD are trademarks of Texas Instruments.

– "DCDi" is a trademark of Faroudja. Faroudja is a wing of Genesis Microchip Inc.

– The DVI logo is a trademark of the DDWG (Digital Display Working Group).

– All trademarked product names mentioned in this manual are the property of their respective companies.

ACCESSORIES

After opening the package, check the below accessories have been included.

- Lens cap x 1

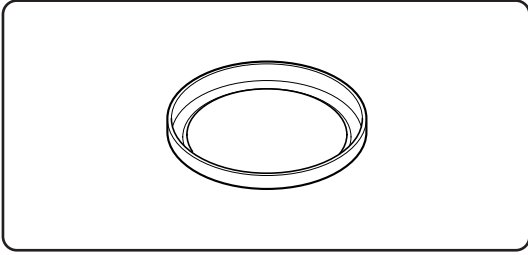

- Attachment for Color temperature sensor x 1

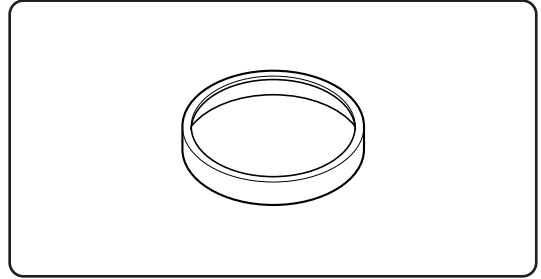

- Remote controller x 1

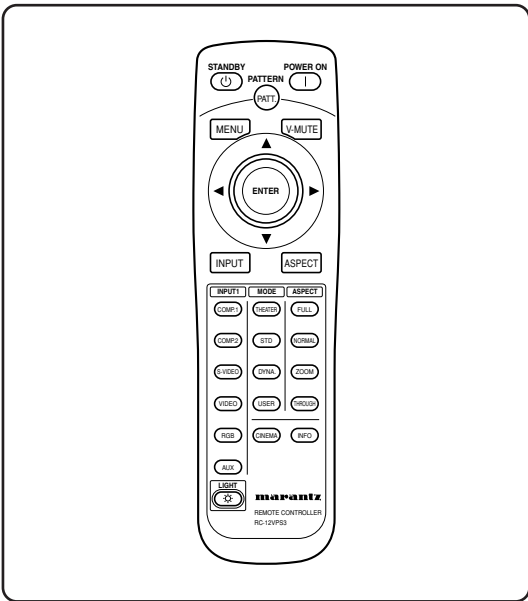

- AC power cable x 1

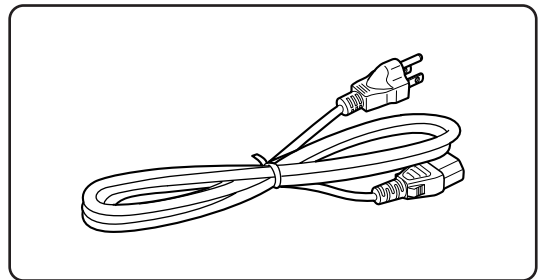

- AA batteries x 2

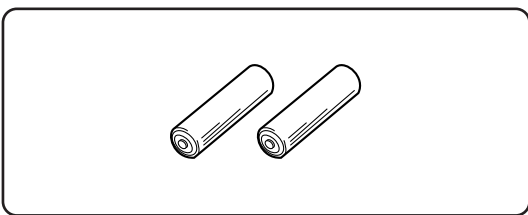

- Control adapter cable (RCA miniature jack) x 1

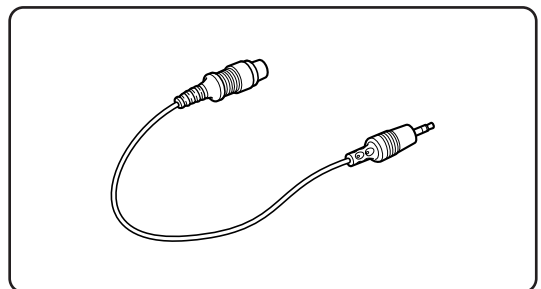

- Color temperature sensor x 1

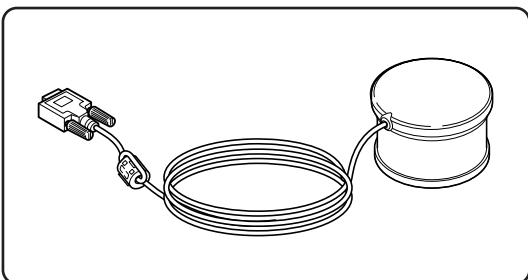

- User Guide x 1

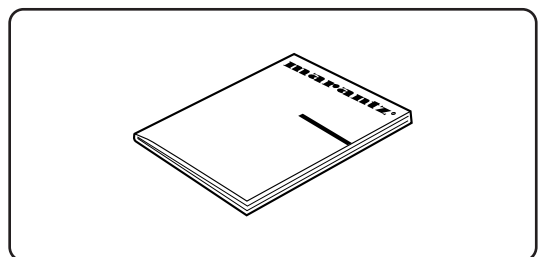

- Warranty Card (1 copy each for USA, CANADA)

NAMES AND FUNCTIONS OF PARTS

Front and Top

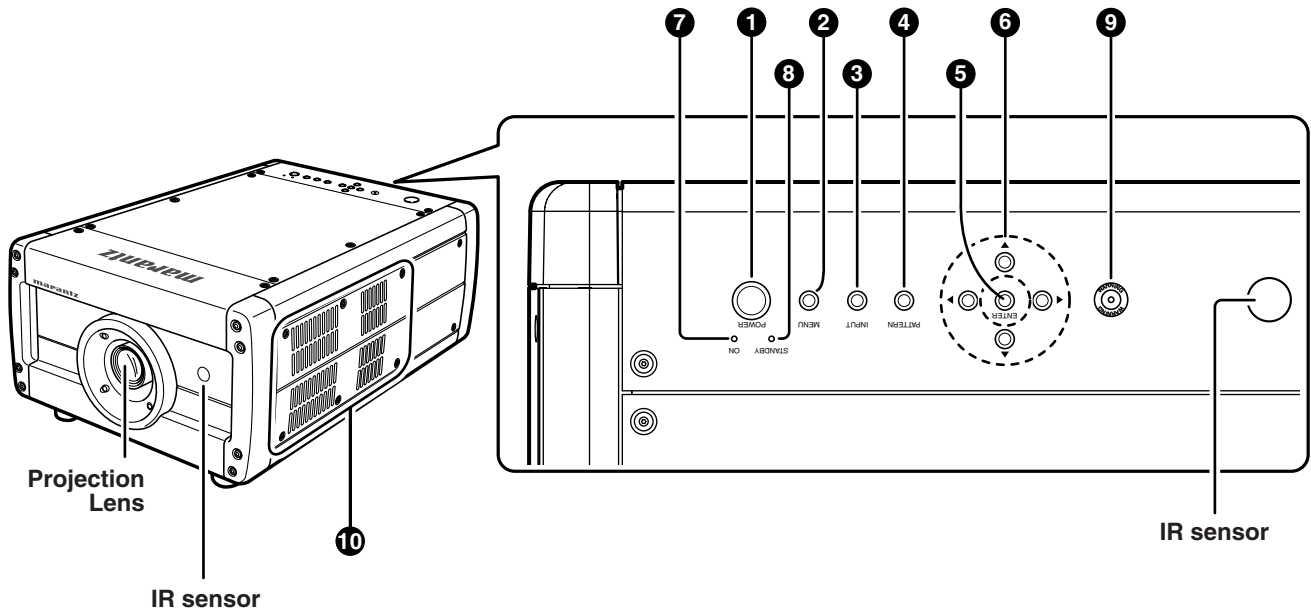

❶ POWER button (👉 pg. 20)

Switches power ON/OFF (standby).

❷ MENU button (👉 pg. 25)

Displays the on-screen menu (*OSD).

* OSD: Acronym for On Screen Display. With this projector, OSD entails menus for making adjustments and settings.

❸ INPUT button (👉 pg. 21)

Selects the Input signal.

Pressing the button one time displays the currently selected Input signal. Every time the button is pressed after that, the Input signal rotates in the order of COMPONENT 1 → COMPONENT 2 → S-VIDEO → VIDEO → RGB → AUX.

❹ PATTERN button (👉 pg. 17)

Projects a focus pattern on the screen. The focus and zoom can then be set using the cursor buttons.

❺ ENTER button

Enters items selected on menus and settings.

❻ Cursor buttons

Press the cursor buttons (▲[UP], ▼[DOWN], ◀[LEFT], ▶[RIGHT]) to select menu items.

❼ POWER ON indicator

Lights up blue when power is on. When power is shut off, the lamp flashes for about 1 min before going out.

❽ STANDBY indicator

Lights up red when the projector is on standby.

❾ WARNING indicator

Lights up or flashes if trouble occurs with the projector.

For error mode, see the list in "Error Mode List" (👉 pg. 43).

❿ Vents (Exhaust / Intake)

Notes:

- Keep hands away from the exhaust vent as hot air is blown from inside the projector.
- Do not block the intake vent. This prevents cooling and causes the protective circuit to trip. (👉 pg. 2)

⓫ ON/OFF switch

This is the main power switch.

⓬ AC IN socket (👉 pg. 15)

Connect the included AC power cable here to supply power to the projector.

Rear and Terminals

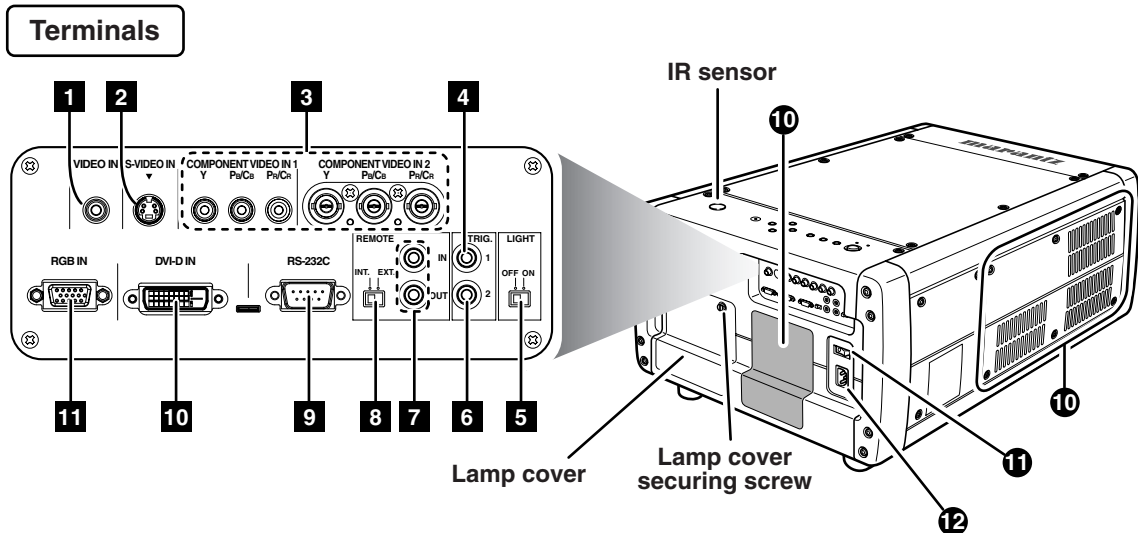

❖ Terminals

1 VIDEO IN jack

Connect to the video (composite) output of a video device.

2 S-VIDEO IN jack

Connect to the S-video output of a video device.

3 COMPONENT VIDEO IN 1 & 2 jacks

Jacks 1 and 2 have each Y, P_B/C_B and P_R/C_R jacks. Connect to the component video output of a video device, AV amp/processor, DVD player, etc.

4 TRIG. 1 (TRIGGER 1) jack

Use to control an external unit from this projector by interlocking the external unit to power ON/OFF (standby) on this projector. The TRIG. 1 jack outputs 0 V when the projector is on standby and 12 V when POWER button is in the on position.

Note:

To connect with external devices, use an ordinal 3.5mm mini-plug (mono) cable.

5 LIGHT ON/OFF switch

Switches the terminal lamps on/off.

6 TRIG. 2 (TRIGGER 2) jack

The TRIG. 2 jack outputs 12 V in each aspect ratio mode (Full, Normal, Zoom or Through). For setting instructions, see "Trigger 2" (pg. 33).

Notes:

- Do not use the TRIG. 1 or 2 jack for power supply.
- To connect with external devices, use an ordinal 3.5mm mini-plug (mono) cable.

7 REMOTE IN / OUT jacks

Use to control this projector when combined with Marantz products into a system. Connect the REMOTE CONTROL OUT of the other Marantz product to the REMOTE CONTROL IN of this projector and the REMOTE CONTROL IN of this other Marantz product to the REMOTE CONTROL OUT of this projector.

Note:

Use the included bus control adapter cable to connect this projector to other Marantz products.

8 REMOTE switch (INT. / EXT.)

Set to "EXT." to control this projector from another connected Marantz product, whereas set to "INT." to control this projector and other connected products from this projector.

9 RS-232C port

This is the control terminal for custom installers.

10 DVI-D IN jack

Connect to the RGB digital output of a video device or PC.

Note: When using the DVI-D IN jack, operate the projector as explained in the precautions on pg. 16.

11 RGB IN jack

Connect to the RGB output of a video device or PC.

Bottom

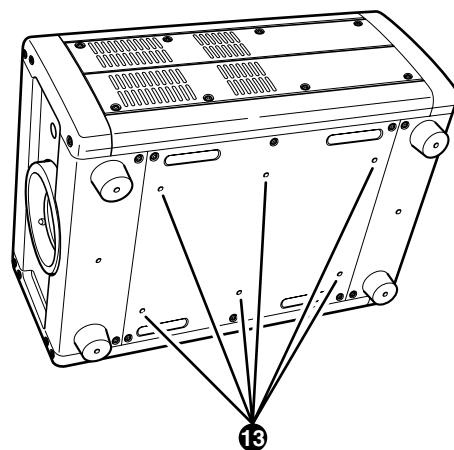

13 Screw holes for ceiling mount kit

Use to hang the projector from a ceiling. To hang the projector from a ceiling, contact your nearest Marantz Authorized Dealer or Service Center.

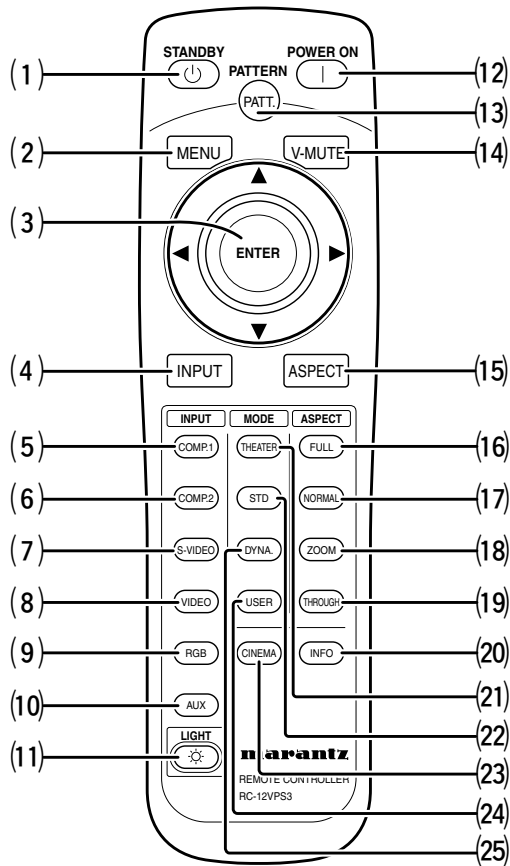

(1) STANDBY button (pg. 20)

Sets the projector on standby provided power to the projector is on.

(2) MENU button (pg. 25)

Displays the on-screen menu (*OSD).

* OSD: Acronym for On Screen Display. With this projector, OSD entails menus for making adjustments and settings.

(3) ▲/▼/◀/▶/ENTER button

Press the cursor buttons (▲[UP], ▼[DOWN], ◀[LEFT], ▶[RIGHT]) to select menu items. Press the button at its center to enter the selected item.

(4) INPUT button (pg. 21)

Selects the Input signal.

Pressing the button one time displays the currently selected Input signal. Every time the button is pressed after that, the Input signal rotates in the order of COMPONENT 1 → COMPONENT 2 → S-VIDEO → VIDEO → RGB → AUX.

(5) COMP. 1 (Component video in 1) button (pg. 21)

Selects the device connected to the COMPONENT VIDEO IN 1 jack as the Input signal.

(6) COMP. 2 (Component video in 2) button (pg. 21)

Selects the device connected to the COMPONENT VIDEO IN 2 jack as the Input signal.

(7) S-VIDEO button (pg. 21)

Selects the device connected to the S-VIDEO IN jack as the Input signal.

(8) VIDEO button (pg. 21)

Selects the device connected to the VIDEO IN jack as the Input signal.

(9) RGB button (pg. 21)

Selects the device connected to the RGB IN jack as the Input signal.

(10) AUX button (pg. 21)

Selects the device connected to the DVI-D IN jack as the Input signal.

(11) LIGHT button

Lights up backlit buttons (POWER ON, STANDBY, MENU, V-MUTE, INPUT, ASPECT, PATTERN) for about 7 sec.

(12) POWER ON button (pg. 17)

Turns on power to the projector.

(13) PATT. (Pattern) button (pg. 17)

Projects a focus pattern on the screen. The focus and zoom can then be set using the cursor buttons.

(14) V-MUTE button

Blacks out the projected image. Pressing the button again returns the image.

(15) ASPECT (Aspect select) button (pg. 21)

Selects the aspect ratio.

Pressing the button one time displays the currently selected aspect ratio. Every time the button is pressed after that, the aspect ratio mode rotates in the order of Full → Normal → Zoom → Through.

(16) FULL button (pg. 21)

Selects the full mode as the aspect ratio.

(17) NORMAL button (pg. 21)

Selects the normal mode as the aspect ratio.

(18) ZOOM button (pg. 21)

Selects the zoom mode as the aspect ratio.

(19) THROUGH button (pg. 21)

Selects the through mode as the aspect ratio.

(20) INFO. button (pg. 35)

Displays information on settings. Pressing the button again disappears the information display.

(21) THEATER button (pg. 25)

Selects the theater mode.

The theater mode is for enjoying movie software because of its high fidelity reproduction of black. Every time the button is pressed, the selection rotates in the order of Theater 1 → Theater 2 → Theater 3 → Default.

(22) STD button (pg. 25)

Selects the standard mode.

The standard mode is for enjoying normal image software. Every time the button is pressed, the selection rotates in the order of Standard 1 → Standard 2 → Standard 3 → Default.

(23) CINEMA button

Pressing the button one time displays the currently selected cinema mode. Pressing the button after that switches the 2-3 pull-down feature between Auto/Off.

(24) USER button (pg. 25)

Selects the user mode.
The user mode is for enjoying images at a user-selected gamma curve.
Every time the button is pressed, the selection rotates in the order of User 1 → User 2 → User 3.

(25) DYNA. button (pg. 25)

Selects the dynamic mode.
The dynamic mode is for enjoying visually dynamic images.
Every time the button is pressed, the selection rotates in the order of Dynamic 1 → Dynamic 2 → Dynamic 3 → Default.

Remote Controller Operating Range

Use the remote controller within 16.4 ft (5 m) of the projector. The projector may not respond to the remote controller if the remote controller is pointed in a different direction from the projector, if there are objects between the remote controller and projector or if strong light shines on the projector's IR sensor.

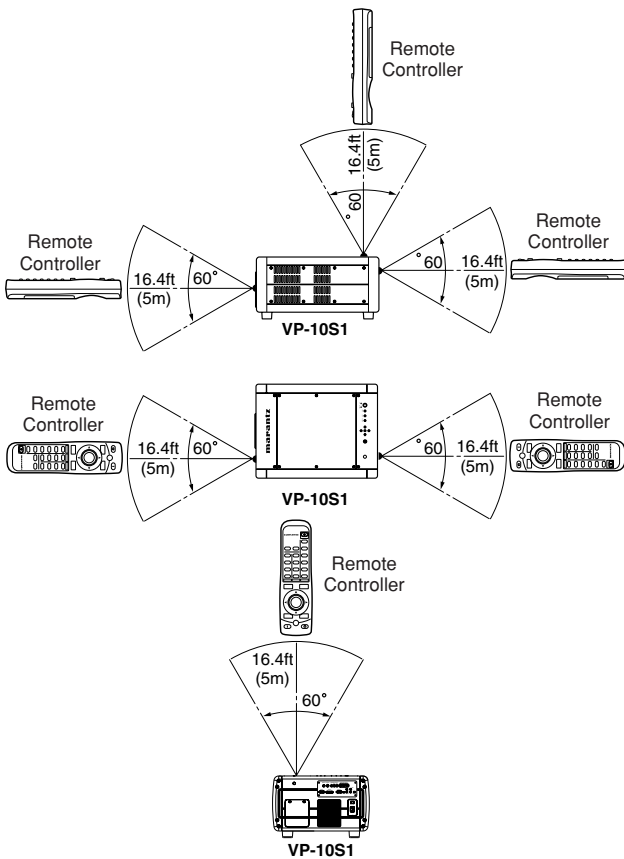

How to Load Batteries into the Remote Controller

1. Detach the battery case cover from the back of the remote controller.

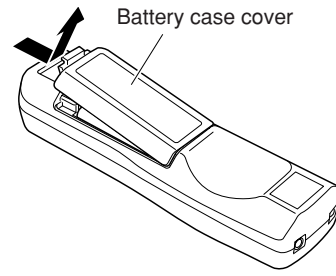

2. Insert two AA batteries with their +/- poles matching the indications inside the battery compartment.

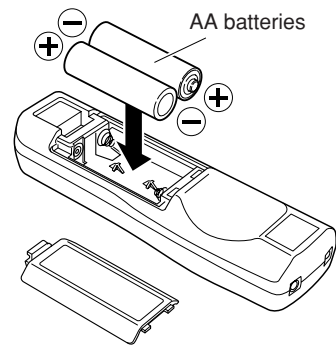

3. Reattach the battery case cover as before.

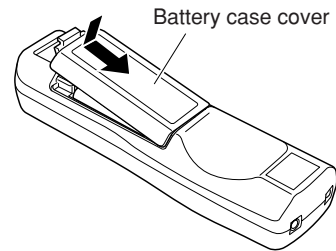

CAUTION

- The available battery types are limited: manganese dry cell and alkaline dry cell.
- Do not mix different battery types.
- Do not mix old and new batteries.
- Only batteries of the same type are to be used.
- Remove exhausted batteries from the Remote Controller.
- Do not attempt to recharge non-rechargeable batteries.
- Do not use rechargeable batteries.
- Batteries are to be inserted with the correct polarity.
- The supply terminals are not to be short-circuited.
- Never throw batteries in a fire or attempt to open up its outer casing.
- If the user does not intend to use the Remote Controller for a long time, remove the batteries.
- Keep away from heat.
- Do not be subjected to strong shock.
- Do not be subjected to moisture. If the unit gets moistured, wipe it off immediately.
- The Remote Controller operation may not function if the projector's IR sensors are exposed to direct sun light or strong artificial light, or if there is an obstacle between the IR sensors and the Remote Controller.

INSTALLATION

How to Install

Note :

- Before installing the projector, carefully read "Precautions in Use" (📖 pg. 2) in this User Guide.
- Specialized skill is required to hang this projector from a ceiling. For safety reasons, do not install the projector yourself. Contact your nearest Marantz Authorized Dealer or Service Center. Hanging the projector from the ceiling requires a separately solder hanger and pole.
- Do not look through the lens with power to the projector on. Exposure to the lamp can harm eyes.

❖ When installing on a flat surface

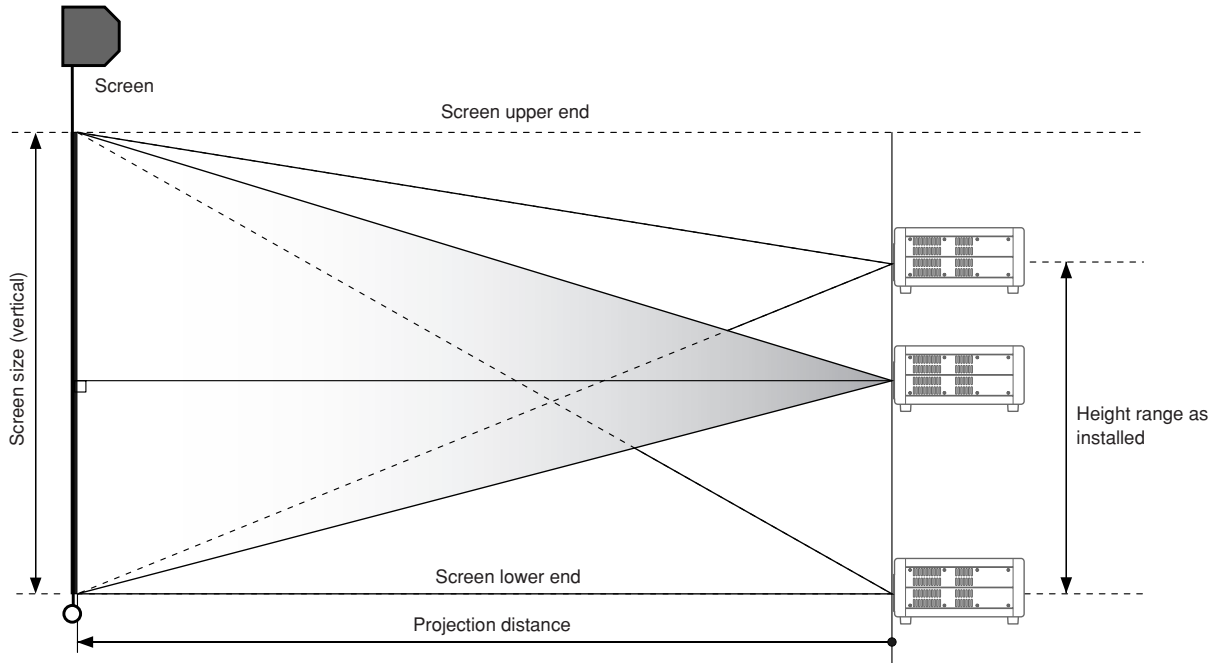

❖ When mounting on a ceiling

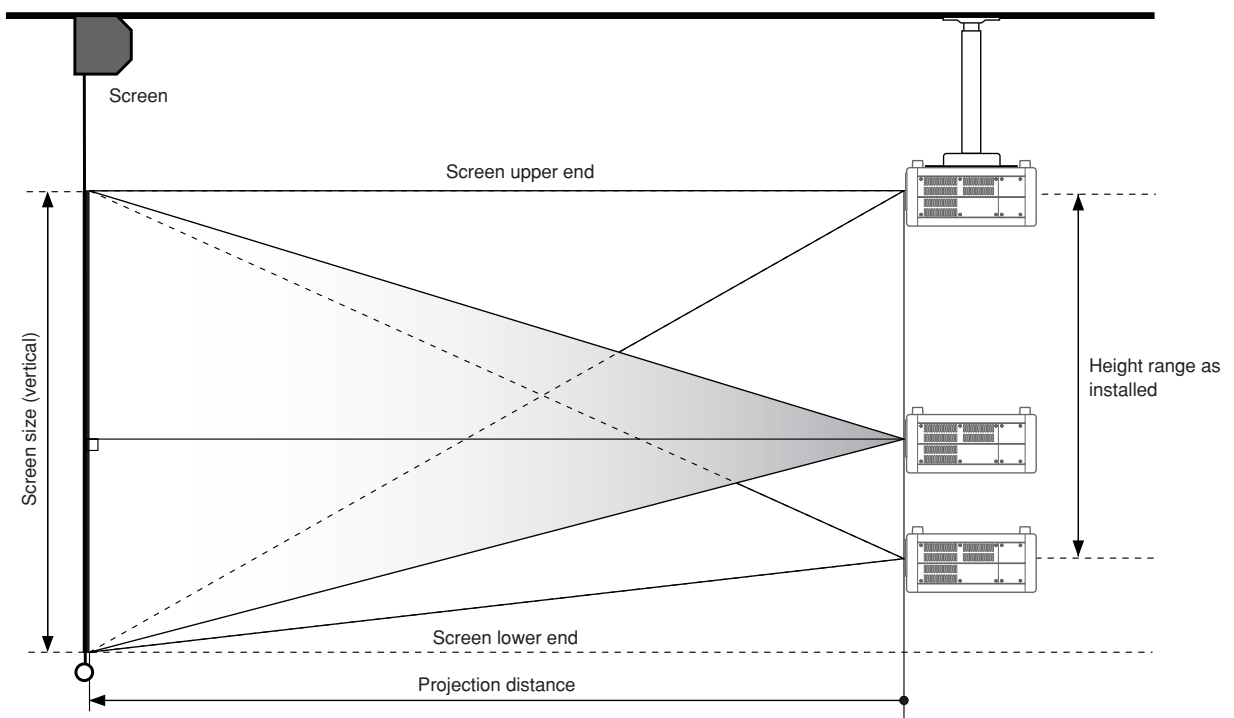

Screen Size and Projection Distance (16:9 Screen) - (inch)

The projection distance for projecting a 16:9 image on a 16:9 screen is shown below.

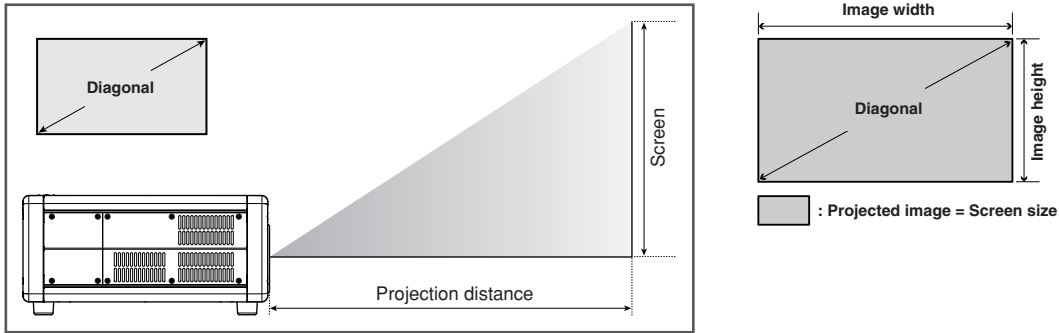

16:9 Screen			Throw distance (inch)					
Screen size	Image width	Image height	LN10VP32		LN10VP40		LN10VP53	
(inch)	(inch)	(inch)	Min	Max	Min	Max	Min	Max
60	52.29	29.42		94.13		125.51		188.26
70	61.01	34.32	87.85	109.82	109.82	146.42	146.42	219.64
72	62.75	35.30	90.36	112.96	112.96	150.61	150.61	225.91
80	69.73	39.22	100.41	125.51	125.51	167.34	167.34	251.01
82	71.47	40.20	102.92	128.64	128.64	171.53	171.53	257.29
84	73.21	41.18	105.43	131.78	131.78	175.71	175.71	263.56
90	78.44	44.12	112.96	141.20	141.20	188.26	188.26	282.39
92	80.18	45.10	115.47	144.33	144.33	192.44	192.44	288.67
100	87.16	49.03	125.51	156.88	156.88	209.18	209.18	313.77
106	92.39	51.97	133.04	166.30	166.30	221.73	221.73	332.59
110	95.87	53.93	138.06	172.57	172.57	230.10	230.10	345.14
120	104.59	58.83	150.61	188.26	188.26	251.01	251.01	376.52
123	107.20	60.30	154.37	192.97	192.97	257.29	257.29	385.93
133	115.92	65.20	166.92	208.66	208.66	278.21	278.21	417.31
135	117.66	66.19	169.43	211.79	211.79	282.39	282.39	423.59
150	130.74	73.54	188.26	235.33	235.33	313.77	313.77	470.65
170	148.17	83.34	213.36	266.70	266.70	355.60	355.60	533.40
200	174.32	98.05	251.01	313.77	313.77	418.36	418.36	627.53
250	217.89	122.57	313.77	392.21	392.21	522.95	522.95	784.42
300	261.47	147.08	376.52		470.65		627.53	941.30

Note : When installing the projector, allow for $\pm 5\%$ tolerance in the above projection distances.

❖ How to calculate projection distance

- When using the LN10VP32 lens
 Min. projection distance (inch) = Diagonal (inch) x 1.255
 Max. projection distance (inch) = Diagonal (inch) x 1.5688
- When using the LN10VP40 lens
 Min. projection distance (inch) = Diagonal (inch) x 1.5688
 Max. projection distance (inch) = Diagonal (inch) x 2.0918
- When using the LN10VP53 lens
 Min. projection distance (inch) = Diagonal (inch) x 2.0918
 Max. projection distance (inch) = Diagonal (inch) x 3.1377

Screen Size and Projection Distance (16:9 Screen) - (m)

The projection distance for projecting a 16:9 image on a 16:9 screen is shown below.

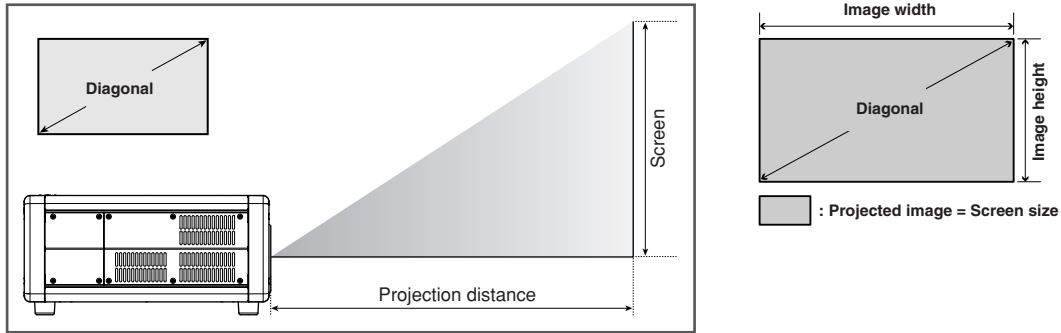

16:9 Screen				Throw distance (m)					
Screen size		Image width	Image height	LN10VP32		LN10VP40		LN10VP53	
(inch)	(m)	(m)	(m)	Min	Max	Min	Max	Min	Max
60	1.52	1.33	0.75		2.39		3.19		4.78
70	1.78	1.55	0.87	2.23	2.79	2.79	3.72	3.72	5.58
72	1.83	1.59	0.90	2.30	2.87	2.87	3.83	3.83	5.74
80	2.03	1.77	1.00	2.55	3.19	3.19	4.25	4.25	6.38
82	2.08	1.82	1.02	2.61	3.27	3.27	4.36	4.36	6.54
84	2.13	1.86	1.05	2.68	3.35	3.35	4.46	4.46	6.69
90	2.29	1.99	1.12	2.87	3.59	3.59	4.78	4.78	7.17
92	2.34	2.04	1.15	2.93	3.67	3.67	4.89	4.89	7.33
100	2.54	2.21	1.25	3.19	3.98	3.98	5.31	5.31	7.97
106	2.69	2.35	1.32	3.38	4.22	4.22	5.63	5.63	8.45
110	2.79	2.44	1.37	3.51	4.38	4.38	5.84	5.84	8.77
120	3.05	2.66	1.49	3.83	4.78	4.78	6.38	6.38	9.56
123	3.12	2.72	1.53	3.92	4.90	4.90	6.54	6.54	9.80
133	3.38	2.94	1.66	4.24	5.30	5.30	7.07	7.07	10.60
135	3.43	2.99	1.68	4.30	5.38	5.38	7.17	7.17	10.76
150	3.81	3.32	1.87	4.78	5.98	5.98	7.97	7.97	11.95
170	4.32	3.76	2.12	5.42	6.77	6.77	9.03	9.03	13.55
200	5.08	4.43	2.49	6.38	7.97	7.97	10.63	10.63	15.94
250	6.35	5.53	3.11	7.97	9.96	9.96	13.28	13.28	19.92
300	7.62	6.64	3.74	9.56		11.95		15.94	23.91

Note : When installing the projector, allow for $\pm 5\%$ tolerance in the above projection distances.

❖ How to calculate projection distance

- When using the LN10VP32 lens
 - Min. projection distance (m) = Diagonal (inch) x 3.188/100
 - Max. projection distance (m) = Diagonal (inch) x 3.985/100
- When using the LN10VP40 lens
 - Min. projection distance (m) = Diagonal (inch) x 3.985/100
 - Max. projection distance (m) = Diagonal (inch) x 5.313/100
- When using the LN10VP53 lens
 - Min. projection distance (m) = Diagonal (inch) x 5.313/100
 - Max. projection distance (m) = Diagonal (inch) x 7.970/100

Screen Size and Projection Distance (4:3 Screen) - (inch)

The projection distance for projecting a 16:9 image on a 4:3 screen is shown below.

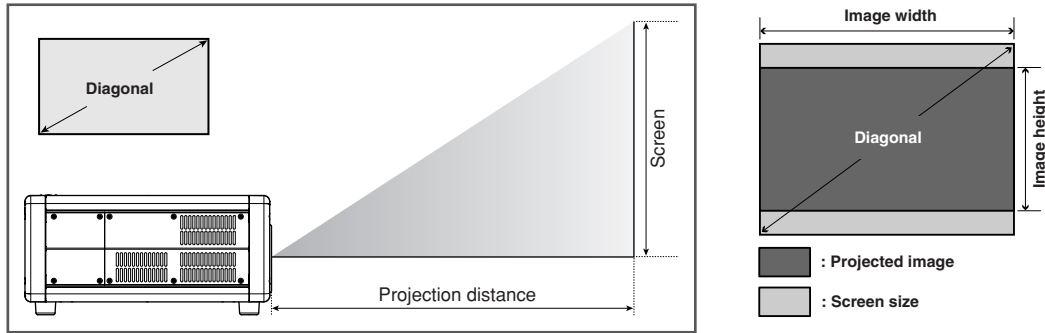

16:9 Screen			Throw distance (inch)					
Screen size	Image width	Image height	LN10VP32		LN10VP40		LN10VP53	
(inch)	(inch)	(inch)	Min	Max	Min	Max	Min	Max
60	48.00	27.00				115.20		172.80
70	56.00	31.50		100.80		134.40		201.60
72	57.60	32.40		103.68		138.24		207.36
80	64.00	36.00	92.16	115.20	115.20	153.60	153.60	230.40
82	65.60	36.90	94.46	118.08	118.08	157.44	157.44	236.16
84	67.20	37.80	96.77	120.96	120.96	161.28	161.28	241.92
90	72.00	40.50	103.68	129.60	129.60	172.80	172.80	259.20
92	73.60	41.40	105.98	132.48	132.48	176.64	176.64	264.96
100	80.00	45.00	115.20	144.00	144.00	192.00	192.00	288.00
106	84.80	47.70	122.11	152.64	152.64	203.52	203.52	305.28
110	88.00	49.50	126.72	158.40	158.40	211.20	211.20	316.80
120	96.00	54.00	138.24	172.80	172.80	230.40	230.40	345.60
123	98.40	55.35	141.70	177.12	177.12	236.16	236.16	354.24
133	106.40	59.85	153.22	191.52	191.52	255.36	255.36	383.04
135	108.00	60.75	155.52	194.40	194.40	259.20	259.20	388.80
150	120.00	67.50	172.80	216.00	216.00	288.00	288.00	432.00
170	136.00	76.50	195.84	244.80	244.80	326.40	326.40	489.60
200	160.00	90.00	230.40	288.00	288.00	384.00	384.00	576.00
250	200.00	112.50	288.00	360.00	360.00	480.00	480.00	720.00
300	240.00	135.00	345.60	432.00	432.00	576.00	576.00	864.00

Note : When installing the projector, allow for $\pm 5\%$ tolerance in the above projection distances.

❖ How to calculate projection distance

- When using the LN10VP32 lens
 Min. projection distance (inch) = Diagonal (inch) x 1.1520
 Max. projection distance (inch) = Diagonal (inch) x 1.4400
- When using the LN10VP40 lens
 Min. projection distance (inch) = Diagonal (inch) x 1.4400
 Max. projection distance (inch) = Diagonal (inch) x 1.9200
- When using the LN10VP53 lens
 Min. projection distance (inch) = Diagonal (inch) x 1.9200
 Max. projection distance (inch) = Diagonal (inch) x 2.8800

Screen Size and Projection Distance (4:3 Screen) - (m)

The projection distance for projecting a 16:9 image on a 4:3 screen is shown below.

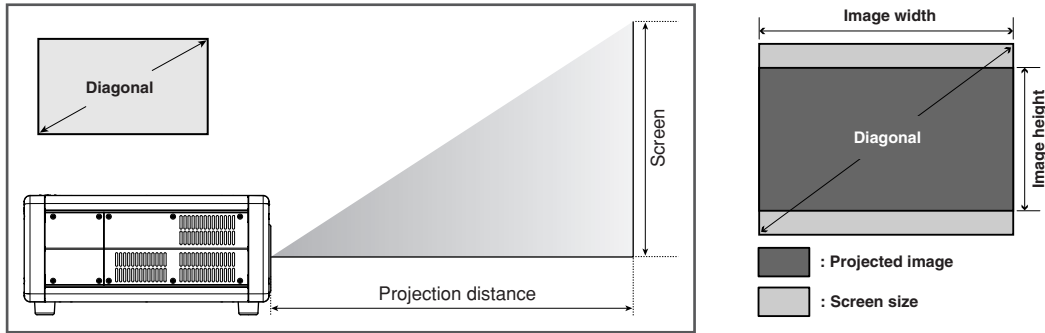

4:3 Screen				Throw distance (m)					
Screen size		Image width	Image height	LN10VP32		LN10VP40		LN10VP53	
(inch)	(m)	(m)	(m)	Min	Max	Min	Max	Min	Max
60	1.52	1.22	0.69				2.93		4.39
70	1.78	1.42	0.80		2.56		3.41		5.12
72	1.83	1.46	0.82		2.63		3.51		5.27
80	2.03	1.63	0.91	2.34	2.93	2.93	3.90	3.90	5.85
82	2.08	1.67	0.94	2.40	3.00	3.00	4.00	4.00	6.00
84	2.13	1.71	0.96	2.46	3.07	3.07	4.10	4.10	6.14
90	2.29	1.83	1.03	2.63	3.29	3.29	4.39	4.39	6.58
92	2.34	1.87	1.05	2.69	3.36	3.36	4.49	4.49	6.73
100	2.54	2.03	1.14	2.93	3.66	3.66	4.88	4.88	7.32
106	2.69	2.15	1.21	3.10	3.88	3.88	5.17	5.17	7.75
110	2.79	2.24	1.26	3.22	4.02	4.02	5.36	5.36	8.05
120	3.05	2.44	1.37	3.51	4.39	4.39	5.85	5.85	8.78
123	3.12	2.50	1.41	3.60	4.50	4.50	6.00	6.00	9.00
133	3.38	2.70	1.52	3.89	4.86	4.86	6.49	6.49	9.73
135	3.43	2.74	1.54	3.95	4.94	4.94	6.58	6.58	9.88
150	3.81	3.05	1.71	4.39	5.49	5.49	7.32	7.32	10.97
170	4.32	3.45	1.94	4.97	6.22	6.22	8.29	8.29	12.44
200	5.08	4.06	2.29	5.85	7.32	7.32	9.75	9.75	14.63
250	6.35	5.08	2.86	7.32	9.14	9.14	12.19	12.19	18.29
300	7.62	6.10	3.43	8.78	10.97	10.97	14.63	14.63	21.95

Note : When installing the projector, allow for $\pm 5\%$ tolerance in the above projection distances.

❖ How to calculate projection distance

- When using the LN10VP32 lens
 Min. projection distance (m) = Diagonal (inch) x 2.927/100
 Max. projection distance (m) = Diagonal (inch) x 3.658/100
- When using the LN10VP40 lens
 Min. projection distance (m) = Diagonal (inch) x 3.658/100
 Max. projection distance (m) = Diagonal (inch) x 4.877/100
- When using the LN10VP53 lens
 Min. projection distance (m) = Diagonal (inch) x 4.877/100
 Max. projection distance (m) = Diagonal (inch) x 7.315/100

CONNECTIONS

❖ When making connections be sure to:

- Turn off the projector and any connected equipment before making any connections.
- Use the proper cables for each connection. See the instruction manual of each connected device.
- Securely insert the plug into the jack to connect cables. Loose connections can lead to trouble.

❖ When disconnecting cables:

- Grab the plug and not the cable itself. Pulling on the cable can damage the cable and cause incomplete connections later on.

Connecting the AC Power Cable

Connect the included AC power cable to the AC IN socket on the projector rear and plug the other end into an electrical outlet (100-120/220-240V AC, 50/60 Hz, 5 A or more).

Keep the **ON/OFF** switch in the off position until all devices have been connected.

Note :

- Check the AC power cable is securely inserted into the AC IN socket on the projector rear.
- Before connecting the AC power cable, attach a grounding wire to the plug end. Before detaching the grounding wire, always unplug the AC power cable from its electrical outlet.

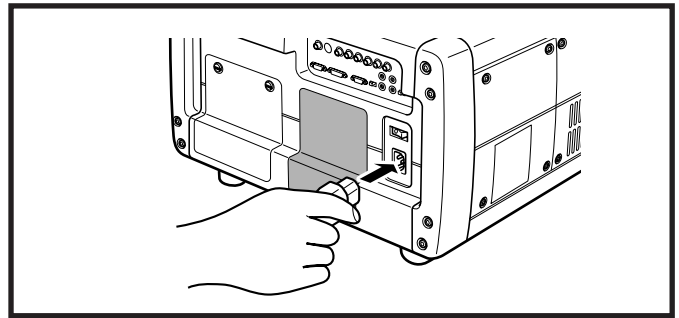

Connecting to Video Equipment

This projector can connect to VCR, DVD player and other type of video equipment.

Connecting a video equipment to the S-VIDEO IN and VIDEO IN jacks

1. Connect one end of an S-video cable to the S-VIDEO IN jack on the projector rear. Similarly, connect one end of a video cable to the VIDEO IN jack on the projector rear.
2. Connect the other end of the S-video cable to the S-video output jack on the VCR. Similarly, connect the other end of the video cable to the video output jack on the VCR.

Connecting a DVD player to the COMPONENT VIDEO IN 1 or 2 jack (Devices can be connected to both terminals at the same time.)

1. Connect the pin-jacks on one end of the component video cable to the COMPONENT VIDEO IN 1 or 2 jack on the projector rear.
2. Connect the pin-jacks on the other end of the cable to the corresponding jacks on the DVD player.

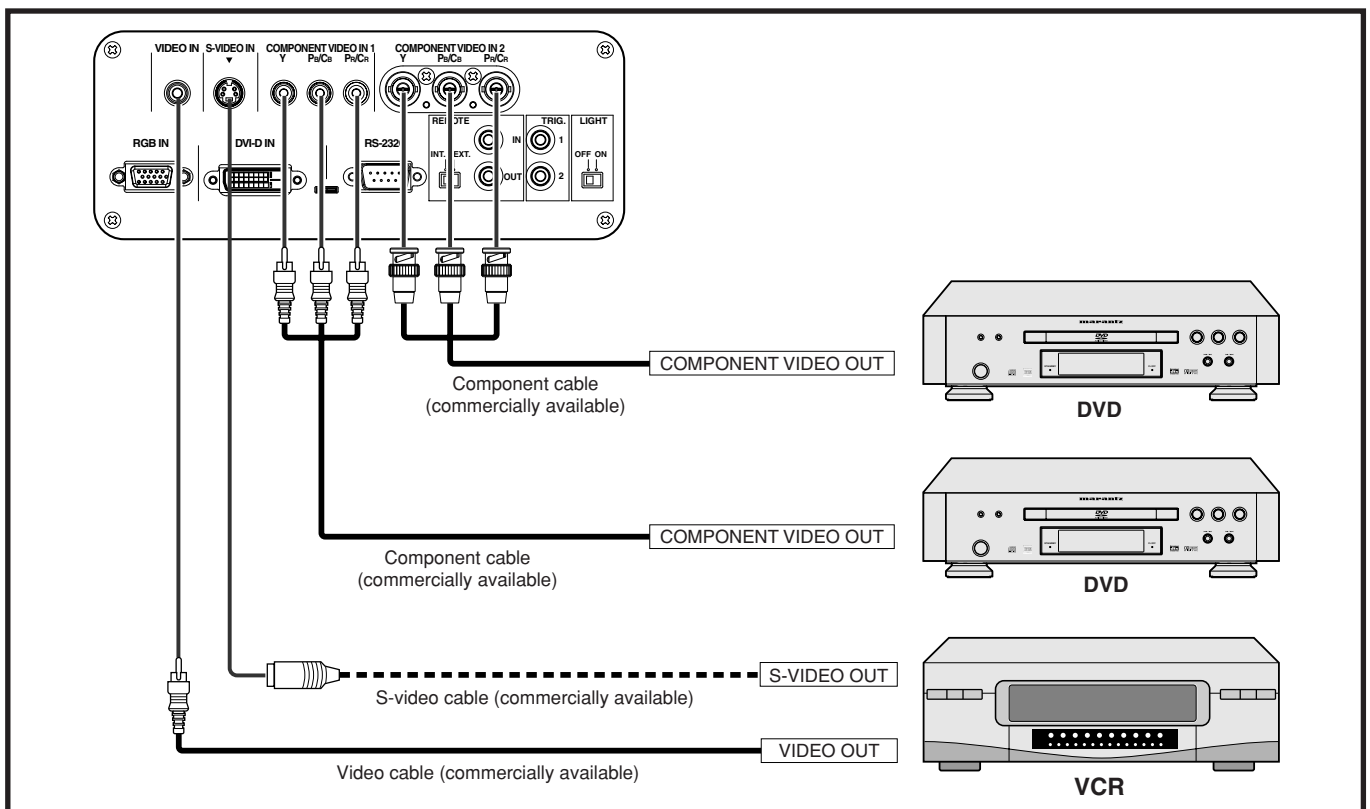

Connecting to an HD-Video, Satellite, Cable Tuner or PC

You can connect this projector to an HD-Video or PC using the RGB IN jack as well as to a satellite, cable tuner or PC using the DVI-D input jack.

1. Connect one end of an RGB cable (or DVI-D cable) to the RGB IN jack (or DVI-D IN jack) on the projector rear.
2. Connect the other end of the cable to the RGB output jack of the HD-Video or PC (or the DVI-D output jack of the satellite, cable tuner or PC).

Note : To project images from a device connected to the DVI-D jack, do as follows. The images can be distorted if you do not follow the procedure. For details on DVI-D jack of the connected device, see the instruction manual of that device.

1. Turn on power to the projector. (pg. 17)
2. Set the Input signal of the projector to AUX (DVI-D IN). (pg. 21)
3. Turn on power to the device (i.e. DVD player) connected to the projector's DVI-D jack.

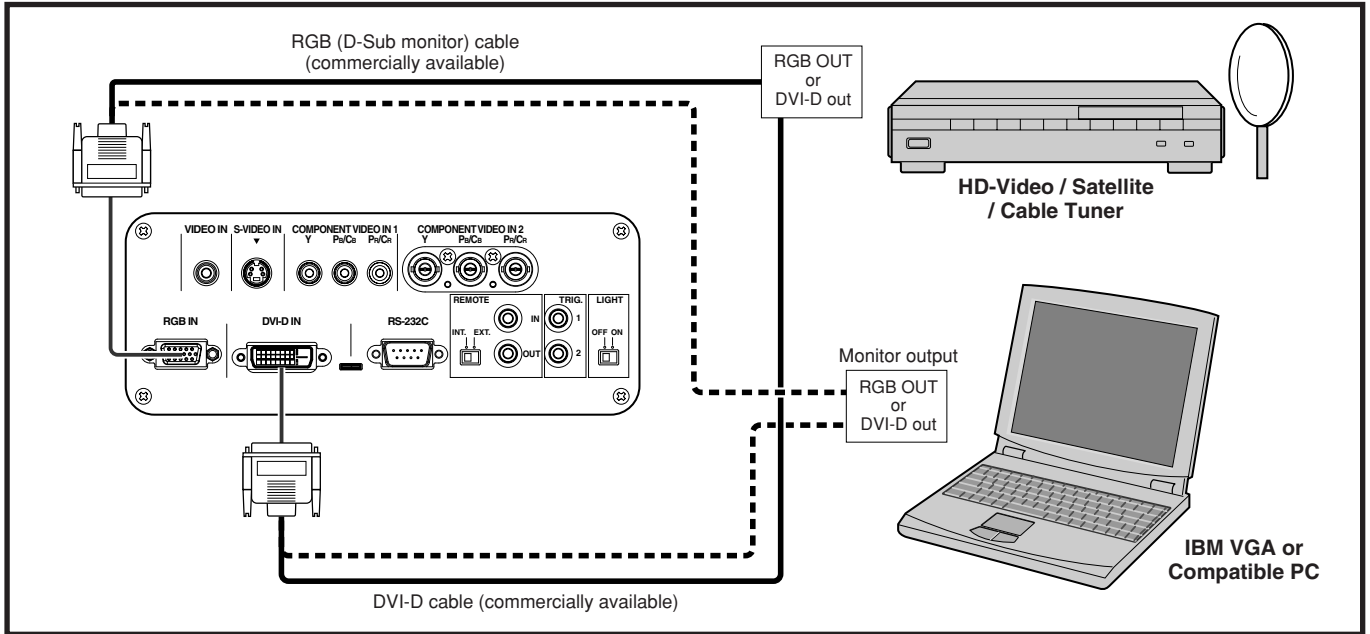

Connecting to a Home Theater System

You can control an entire home theater system using a PC and Marantz receiver equipment. To install the below system, contact your nearest Marantz Authorized Dealer or Service Center.

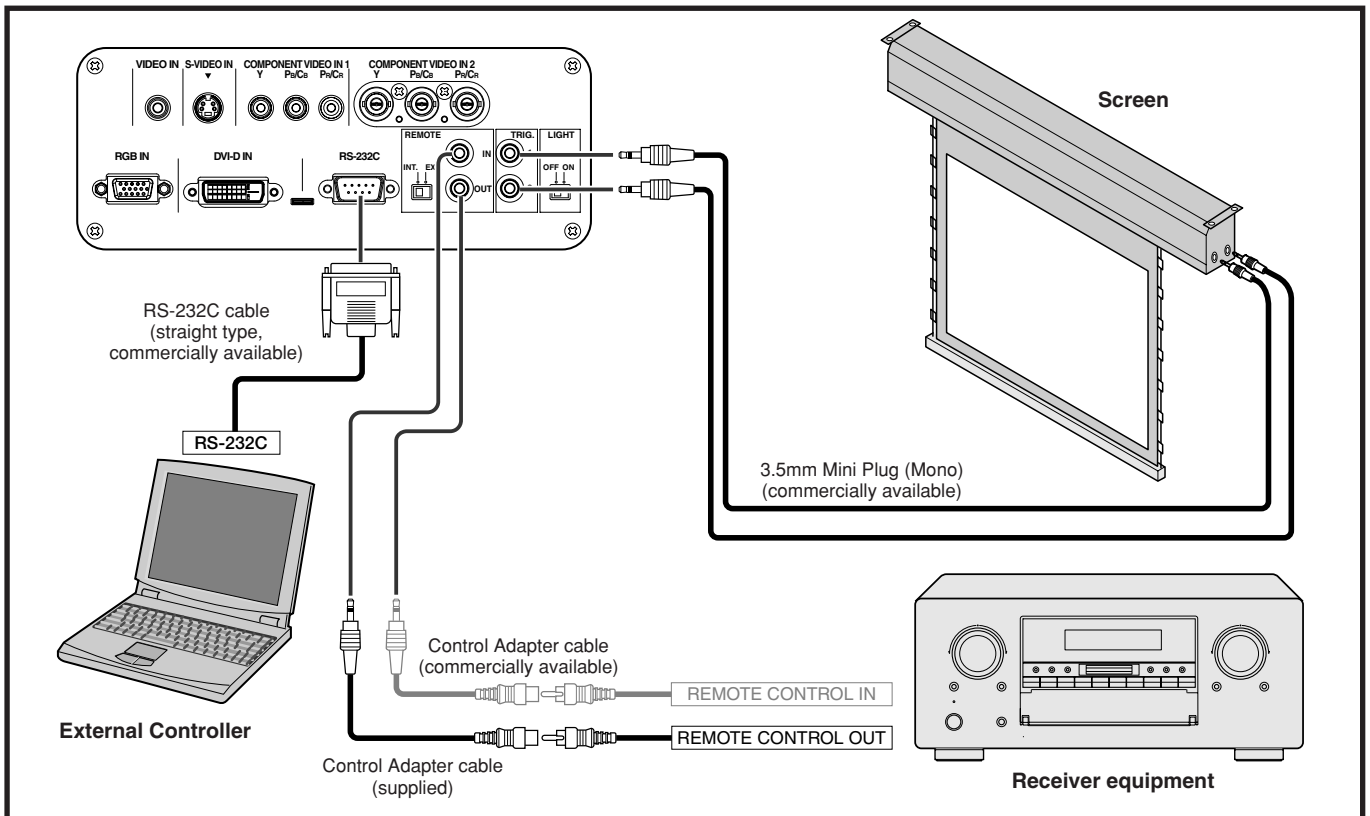

INITIAL SETTING

Activating the Power

1. Connect the included AC power cable. (▶ pg. 15)
2. Set the **ON/OFF** switch on the projector rear in the on position. The **STANDBY** indicator on the projector will light up.

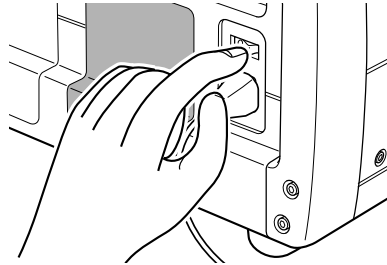

3. Press the **POWER ON** button on the remote controller or the **POWER** button on the projector. The **POWER ON** indicator on the projector will light up.

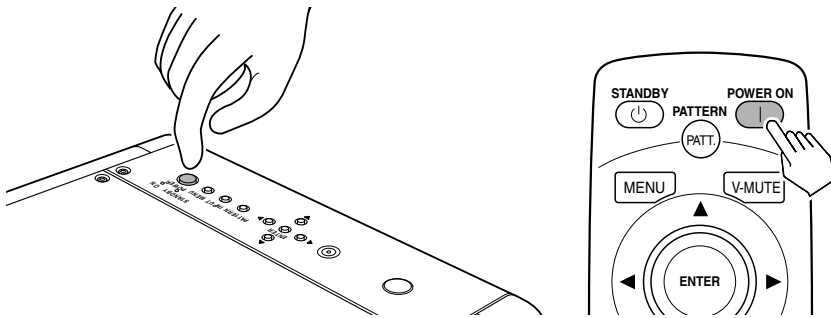

Focusing and Zooming

You can adjust the focus and projected image size using the focus pattern.

1. Press the **PATTERN** button to project the focus pattern on the screen.

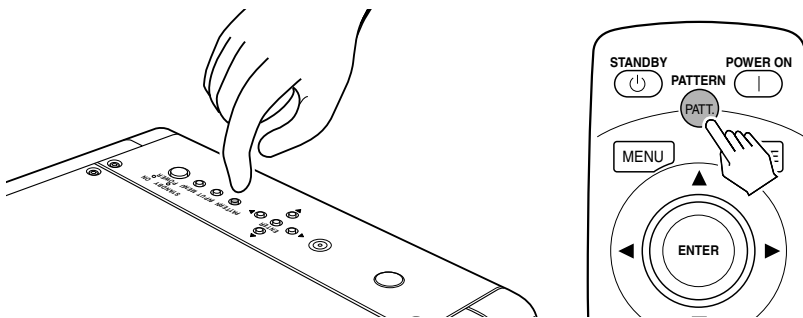

2. To focus the pattern, press the ◀ / ▶ buttons on the remote controller or projector. Tapping the buttons fine-adjusts the focus. Holding the buttons down quickly changes the focus. Adjust the focus so that the focus pattern appears its sharpest, as shown below.



3. To adjust the size of the projected image, press the ▲ / ▼ buttons on the remote controller or projector. Tapping the buttons fine-adjusts the size. Holding the buttons down quickly changes the size.
4. Press the **PATTERN** button again to cancel the focus pattern. This completes focusing and zooming.

Positioning the Projected Image

You can position the projected image on the screen using the “Lens shift” feature in the menu (OSD).
 (For an explanation of this feature, see “Configuration” pg. 32.)
 First, project an image on the screen. (If you haven’t an Input signal, display the focus pattern.)

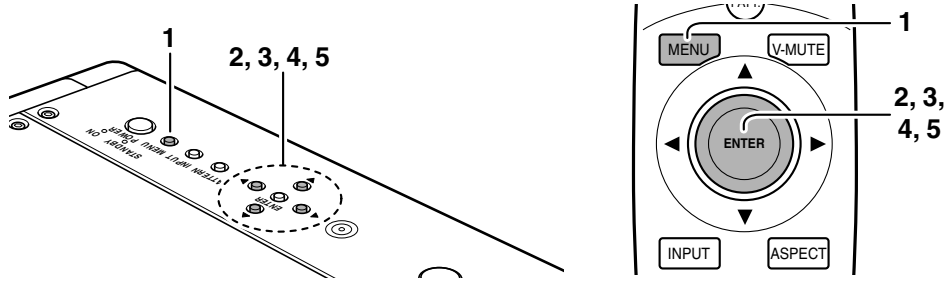

1. Press the **MENU** button on the remote controller or projector to display the menu.
2. Select “Config” using the ▲ / ▼ buttons, then press the ► button.
3. Select “Lens shift” using the ▲ / ▼ buttons, then press the ► button.
 (If you haven’t an Input signal at this point, display the focus pattern.)
4. Position the projected image vertically on the screen using the ▲ / ▼ buttons on the remote controller or projector.

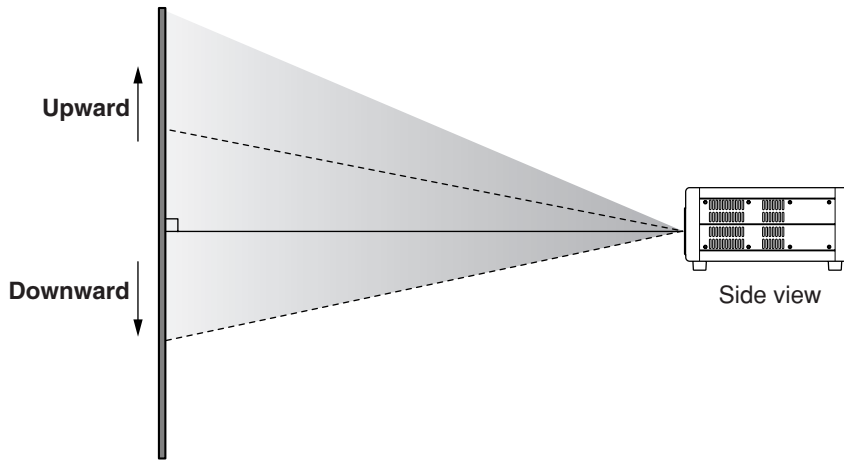

5. Position the projected image horizontally on the screen using the ◀ / ▶ buttons on the remote controller or projector.

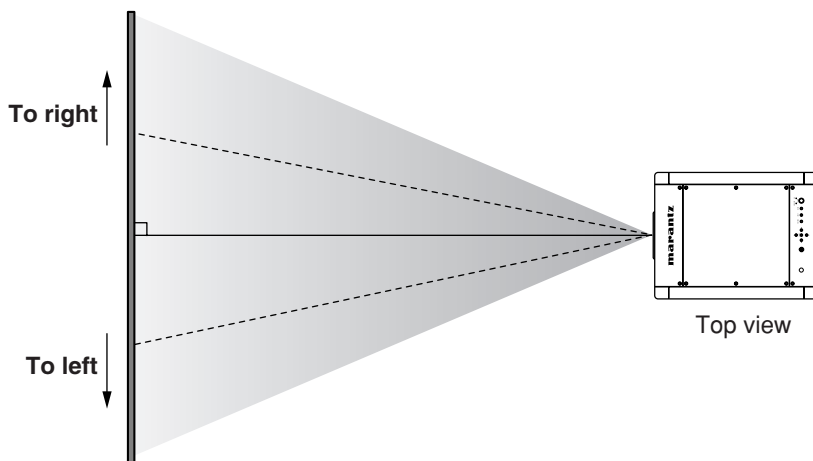

Keystone Correction

If the projected image appears trapezoidal in shape, you can correct it using the “Keystone V” and “Keystone H” features in the menu (OSD). (For an explanation of this feature, see “Display”  pg. 31.)

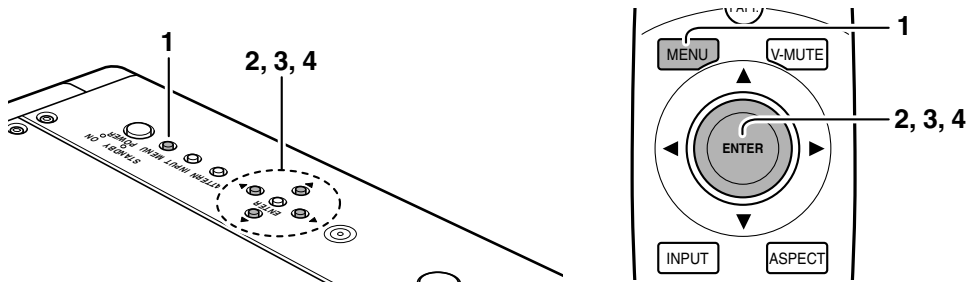

1. Press the **MENU** button on the remote controller or projector to display the menu.
2. Select “Display” using the **▲ / ▼** buttons, then press the **▶** button.
3. Select “Keystone V” or “Keystone H” using the **▲ / ▼** buttons, then press the **▶** button.
4. Correct in the vertical or horizontal distortion using the **◀ / ▶** buttons on the remote controller or projector.

- Vertical keystone correction -

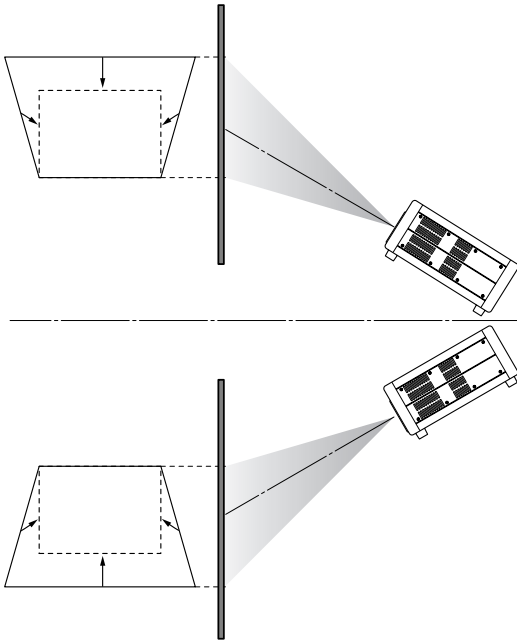

- Horizontal keystone correction -

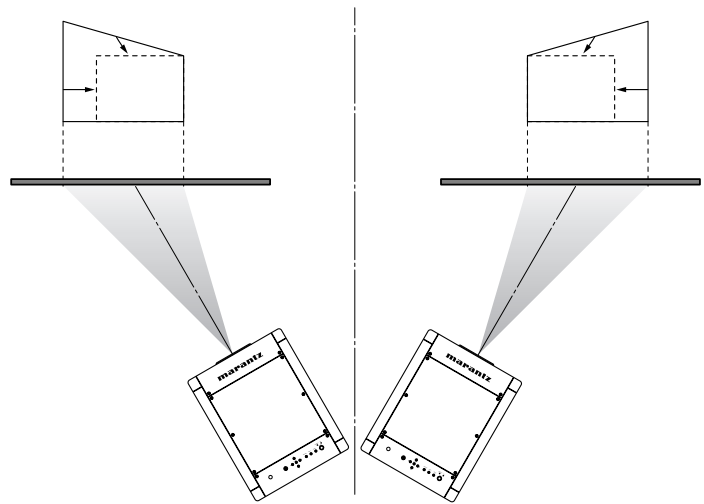

Note : Horizontal keystone is best corrected when the projector is installed on a flat surface and the image is shifted to the maximum height using the “Lens shift” feature in the menu.

BASIC OPERATIONS

Activating the Power

1. Connect the included AC power cable. (▶ pg. 15)
2. Set the **ON/OFF** switch in the on position. The **STANDBY** indicator will light up.

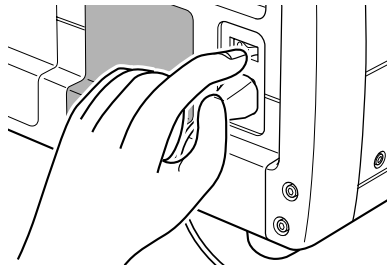

3. Press the **POWER ON** button on the remote controller or the **POWER** button on the projector. The **POWER ON** indicator on the projector will light up.

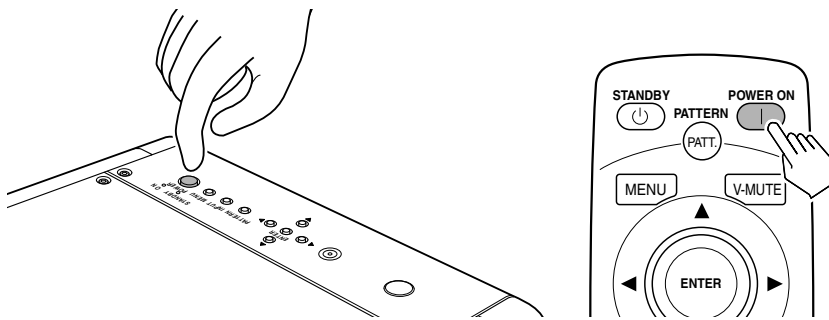

Shutting Power OFF

1. Press the **STANDBY** button on the remote controller or the **POWER** button on the projector.

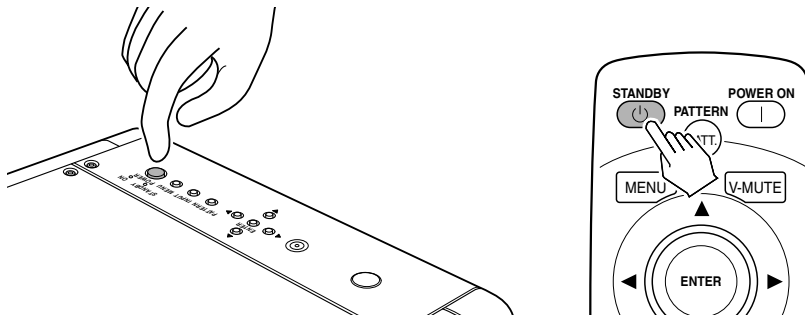

2. The fan will continue running for about 1 min to internally cool the projector. In the meantime, the **POWER ON** indicator on the projector will flash blue and the buttons on the projector and the remote controller will be irresponsive to touch. After the fan stops, the **POWER ON** indicator stops flashing and the **STANDBY** indicator lights up to indicate that the projector is on standby.
3. Set the **ON/OFF** switch in the off position. The **STANDBY** indicator will go out.

Note :

- Until the projector goes on standby, the cooling fan turns to internally cool the project. Do not unplug the AC power cable until you set the **ON/OFF** switch in the off position in the above procedure. Shutting off power prematurely can damage the projector.
- While the projector is on standby, power is not completely off. If not planning to use the projector for a long period of time, set the **ON/OFF** switch in the off position and unplug the AC power cable from its electrical outlet.
- If the **WARNING** indicator lights up or flashes red, check the fan has stopped, set the **ON/OFF** switch in the off position and unplug the AC power cable from its electrical outlet.
- Immediately after shutting off the power, power cannot be reactivated from either the **POWER** button on the projector or the **POWER ON** button on the remote controller. Check the projector is on standby and then press the **POWER** button on the projector or the **POWER ON** button on the remote controller.

Selecting an Input signal

You can select the Input signal from amongst the devices connected to the projector. Every time the **INPUT** button on the projector or the remote controller is pressed, the Input signal rotates in the order of COMPONENT 1 → COMPONENT 2 → S-VIDEO → VIDEO → RGB → AUX. The Input signal can also be switched to a specific source by pressing the **COMP.1**, **COMP.2**, **S-VIDEO**, **VIDEO**, **RGB** or **AUX** button.

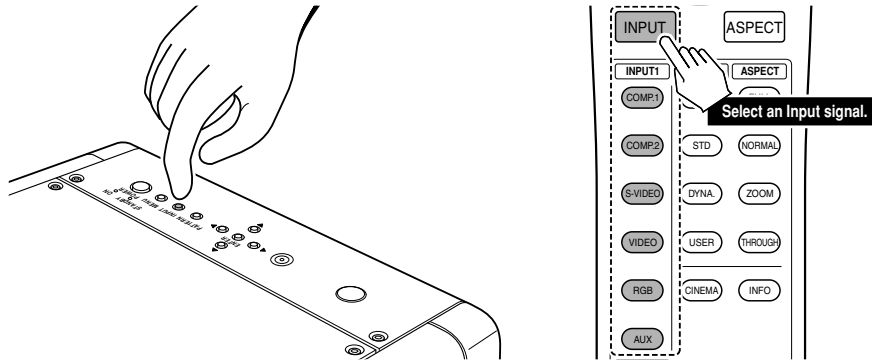

Selecting Aspect Mode

You can set the aspect ratio of the projected image to any of four modes, using the remote controller. Every time the **ASPECT** button on the remote controller is pressed, the aspect mode rotates in the order of Full → Normal → Zoom → Through. The aspect ratio can also be switched to a specific mode by pressing the **FULL**, **NORMAL**, **ZOOM** or **THROUGH** button. And the aspect mode can also be selected from the menu. (pg. 29)

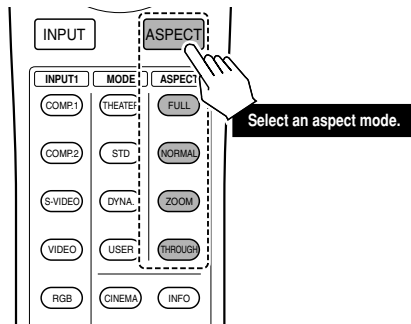

To set the aspect mode for your screen, see the next page.

When Using a 16:9 Screen

- To project a video source of a 4:3 aspect ratio, use either the Full, Normal or Zoom mode.
 - To project a video source of a 16:9 aspect ratio such as 1080i, 1035i or 720p, use the Full mode.
 - To project squeezed video sources, use the Full mode.
- See "Setting" (🔍 pg. 29).

❖ Original image

16:9 Video Source

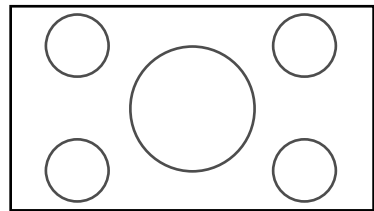

4:3 Video Source

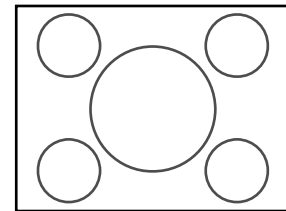

❖ Full mode

A wide image of a 16:9 aspect ratio is projected in the proper vertical-to-horizontal proportions.

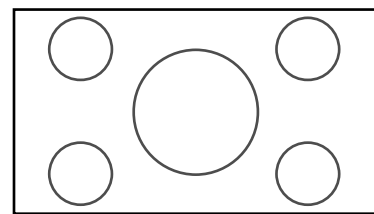

A 4:3 image appears horizontally elongated when projected.

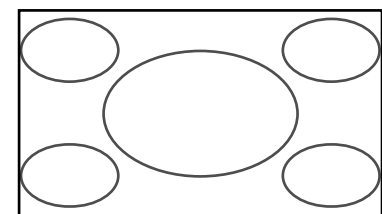

❖ Normal mode

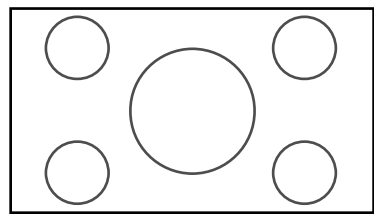

A 4:3 image is projected in the proper vertical-to-horizontal proportions.

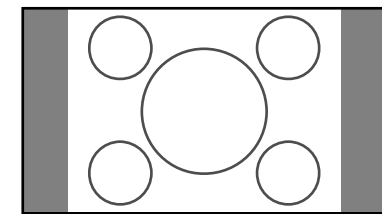

❖ Zoom mode

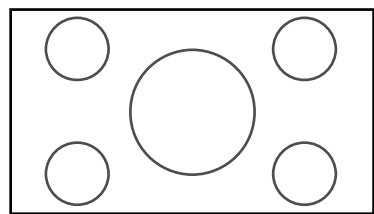

The image is enlarged to the maximum height and width of the screen, regardless of the aspect ratio of the 4:3 image.

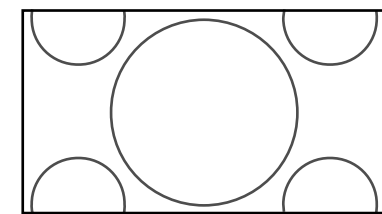

❖ Through mode

The image is displayed at the same resolution as an RGB/Video signal of 720 or less scanning lines.

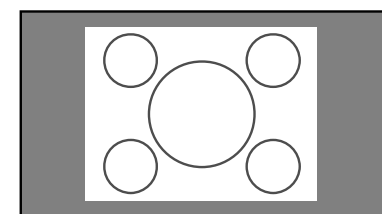
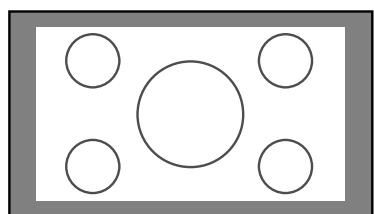

When Using a 4:3 Screen

- To project a video source of a 4:3 aspect ratio, use either the Full, Normal or Zoom mode.
- To project a video source of a 16:9 aspect ratio such as 1080i, 1035i or 720p, use the Full mode.
- To project squeezed video sources, use the Full mode.

See "Setting" (🔍 pg. 29).

❖ Original image

16:9 Video Source

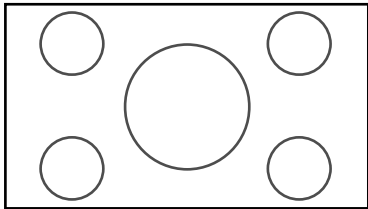

4:3 Video Source

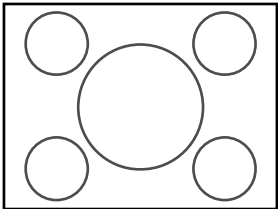

❖ Full mode

A wide image of a 16:9 aspect ratio is projected in the proper vertical-to-horizontal proportions.

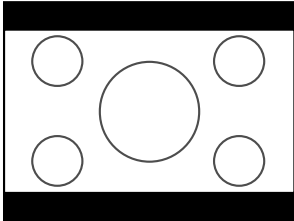

A 4:3 image appears horizontally elongated when projected.

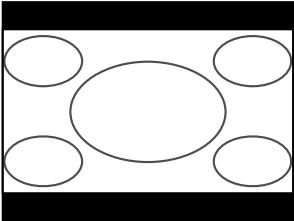

❖ Normal mode

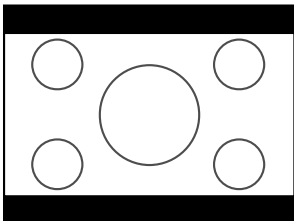

A 4:3 image is projected in the proper vertical-to-horizontal proportions.

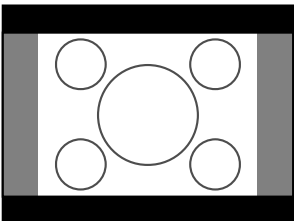

❖ Zoom mode

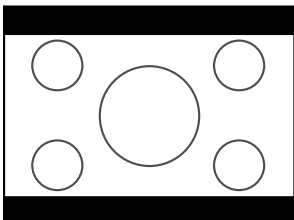

The image is enlarged to the maximum height and width of the screen, regardless of the aspect ratio of the 4:3 image.

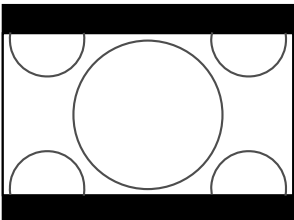

❖ Through mode

The image is displayed at the same resolution as an RGB/Video signal of 720 or less scanning lines.

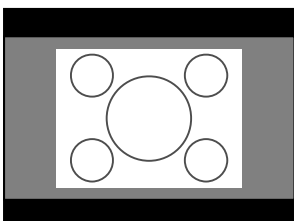
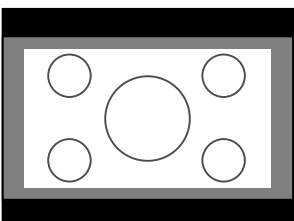

MENU OPERATIONS

Menu Structure

Main Menu	Item	Value
* Picture Adjust pg. 26	Contrast	0 ↔ 100
	Brightness	0 ↔ 100
	Color	0 ↔ 100
	Sharpness	0 ↔ 31
	Tint	R50 ↔ G50
	Noise Reduction	0 ↔ 63
	Color Temp. (Temperature)	1 ↔ 5
	Fine Menu	

Setting	Item	Value	
Setting pg. 29	Lamp mode	High / Low	
	High Bright	On / Off	
	Aspect	Full	
		Normal	
		Through	
		Zoom	
	OSD Position	16:9	
		4:3	
		Through	
	VCR Mode	On / Off	
Cinema	Auto / Off		
Black Setup	0IRE / 7.5IRE		

During DVI input, "NORMAL" or "EXPAND" is shown.

System	Item	Value	
System pg. 30	Component 1	Auto	
		NTSC	
		PAL	
		480p	
		540p	
		576p	
		720p	
	Component 2	Auto	
		NTSC	
		PAL	
		480p	
		540p	
		576p	
		720p	
	S-Video System	Auto	
		NTSC	
		PAL	
		SECAM	
	Video System	Auto	
		NTSC	
		PAL	
		SECAM	
	RGB System	Auto	
		NTSC	
		PAL	
480p			
540p			
576p			
720p			
DVI System	RGB		
	Y Pb Pr		
	Y Cb Cr		

Fine Menu	Item	Value	
* Luminance	H Detail Gain	0 ↔ 31	
	H Detail Threshold	0 ↔ 31	
	H Edge Gain	0 ↔ 31	
	H Edge Threshold	0 ↔ 31	
	V Detail Gain	0 ↔ 31	
	V Detail Threshold	0 ↔ 31	
	V Edge Gain	0 ↔ 31	
	V Edge Threshold	0 ↔ 31	
	* Chrominance	H Edge Gain	0 ↔ 31
		H Edge Threshold	0 ↔ 31
V Edge Gain		0 ↔ 31	
* Enhancement		0 ↔ 31	
Delay		-3 ↔ 0 ↔ +3	
Sub Control	Contrast Red	0 ↔ 255	
	Contrast Green	0 ↔ 255	
	Contrast Blue	0 ↔ 255	
	Brightness Red	0 ↔ 255	
	Brightness Green	0 ↔ 255	
	Brightness Blue	0 ↔ 255	
	* Clamp Position	-128 ↔ 127	
	* Clamp Width	-128 ↔ 127	
	Miscellaneous	* DCDi	On / Off
		FRC	Auto / On
* CCS		On / Off	
* Sharpness Filter		0 ↔ 4	

Main Menu	Item	Value
* Display pg. 31	Keystone V (Vertical)	-30 ↔ 0 ↔ 30
	Keystone H (Horizontal)	-30 ↔ 0 ↔ 30
	* Auto Adjust	Yes / No
	* Picture Shift V (Vertical)	-50 ↔ 0 ↔ 50
	* Picture Shift H (Horizontal)	-50 ↔ 0 ↔ 50
	* Size V (Vertical)	-50 ↔ 0 ↔ 50
	* Size H (Horizontal)	-50 ↔ 0 ↔ 50
	* Phase	0 ↔ 31

Config (Configuration)	Item	Value	
Config (Configuration) pg. 32	Auto Power Off	Enable / Disable	
	Installation	Front / F. Ceiling	
		Rear / R. Ceiling	
	Language	English	
		Français	
		Deutsch	
		Español	
		Italiano	
	Português		
	Focus / Zoom		
Lens Shift			
* Color Temp. Calibration	Yes / No		
Reset Lamp Life	Yes / No		
Reset All	Yes / No		

Trigger 2	Item	Value
Trigger 2 pg. 33	Full	On / Off
	Normal	On / Off
	Through	On / Off
	Zoom	On / Off

Preset	Item	Value
* Preset pg. 34	Mode	Theater/ Standard/ Dynamic/ User
	Index	1 / 2 / 3 / Default

*: The menu item does not appear or adjustment is not possible with some input signals and settings.

How to Operate Menu

This projector uses menus to make setting and adjustment easy.
1. Press the **MENU** button. The MENU screen will appear on the screen.

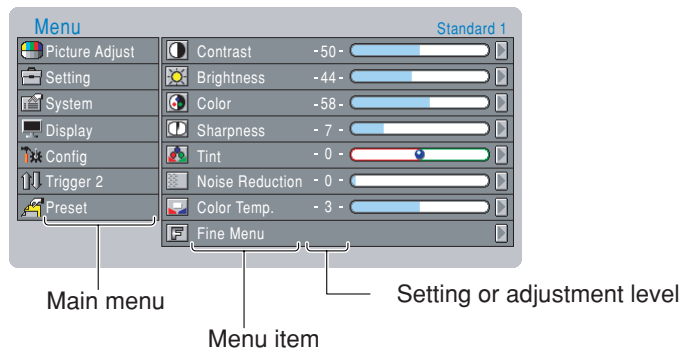

- 2.** Use the ▲ and ▼ buttons to select a main menu (Picture Adjust, Setting, System, Display, Config, Trigger 2, Preset) and press the ► button.
- 3.** Use the ▲ and ▼ buttons to select a menu item and press the ► button.
- 4.** Use the ▲, ▼, ◀ and ▶ buttons to make the setting or adjustment of the selected item.
 - The current setting or adjustment level of all items is displayed along the right side of each the menu item.
- 5.** Press the **MENU** button again to close the menu. The MENU screen will go out.

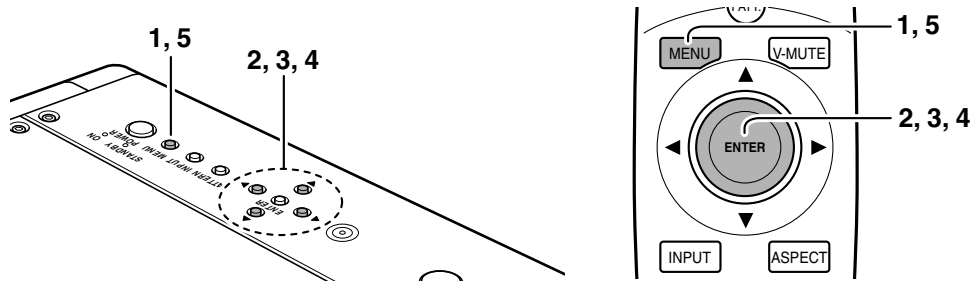

❖ Picture Mode and Memory

This projector offers 4 pictures modes: Theater, Standard, Dynamic and User. Select them by pressing the **THEATER**, **STD**, **DYNA**. and **USER** buttons on the remote controller. Moreover, each of these picture modes has 3 indexes for saving picture quality adjustments.

Picture mode	Index
Theater	1, 2, 3, Default
Standard	1, 2, 3, Default
Dynamic	1, 2, 3, Default
User	1, 2, 3

As suggested by the above table, adjust picture quality to your liking and save the adjustments in indexes 1, 2 and 3.
 See "Preset" (pg. 34)

Picture Adjust

You can adjust picture quality to your liking in each of the picture modes and save those adjustments in memory. This projector makes 3 memory indexes (1, 2 and 3) available for each picture mode.

❖ For a video signal input, the following adjustments can be made.

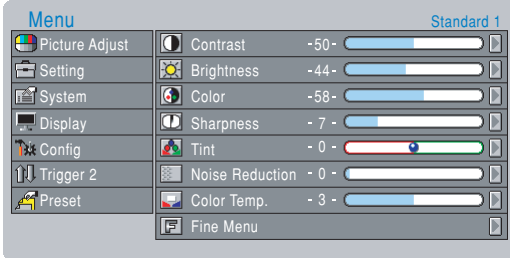

Menu item	Adjustment range
Contrast	0 ← → 100
	Weak → Strong
Brightness	0 ← → 100
	Dark → Bright
Color	0 ← → 100
	Light → Deep
Sharpness	0 ← → 31
	Soft → Sharp
Tint	R50 ← → G50
	Purple → Green
Noise Reduction	0 ← → 63
	Weak → Strong
Color Temp. (Color Temperature)	1 2 3 4 5
	Red ← → Blue

Note:

- Some menu items cannot be adjusted depending on the input signal.
- If default is selected as the index, picture quality cannot be adjusted. To adjust picture quality, select an index from 1 to 3. See "Preset" (pg. 34)

❖ Contrast



❖ Color Temp. (Color Temperature)

- 1 : Red comes out strong. Color temperature is about 5250 K.
- 2 : Red is mildly strong. Color temperature is about 5800 K.
- 3 : Normal. Color temperature is about 6500 K.
- 4 : Blue is mildly strong. Color temperature is about 7500 K.
- 5 : Blue comes out strong. Color temperature is about 9300 K.



❖ Adjusting Picture Quality

1. Select the desired menu item and press the ► button. An adjustment bar appears on the screen.
2. Use the ◀ and ▶ buttons to adjust the item.
3. Press the ▲ button to enter the setting and return to menu item selection.

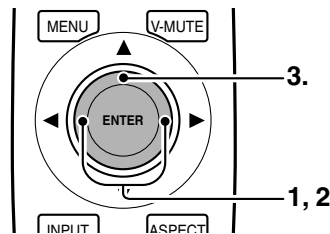
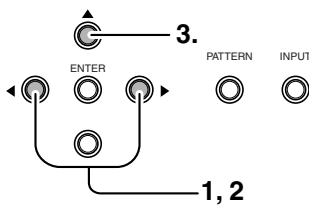

Fine Menu

Picture quality can be fine-adjusted from the Fine Menu.

Note : Some menu items cannot be adjusted depending on the input signal.

❖ Luminance

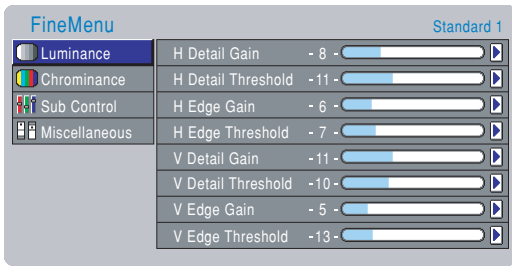

Menu item	Adjustment range
H Detail Gain	0 ← → 31
H Detail Threshold	0 ← → 31
H Edge Gain	0 ← → 31
H Edge Threshold	0 ← → 31
V Detail Gain	0 ← → 31
V Detail Threshold	0 ← → 31
V Edge Gain	0 ← → 31
V Edge Threshold	0 ← → 63

H Detail Gain (Horizontal Detail Processing Gain)

: Sets the degree of detail enhancement in the horizontal direction.

H Detail Threshold (Horizontal Detail processing Threshold)

: Sets the minimum luminance signal level accepted for horizontal detail gain processing.

H Edge Gain (Horizontal Large Edge Enhancement Gain)

: Sets the contour enhancement level in the horizontal direction.

H Edge Threshold (Horizontal Large Edge Enhancement Threshold)

: Sets the minimum luminance signal level accepted for processing horizontal edge gain.

V Detail Gain (Vertical Detail Processing Gain)

: Sets the degree of detail enhancement in the vertical direction.

V Detail Threshold (Vertical Detail Processing Threshold)

: Sets the minimum luminance signal level accepted for vertical detail gain processing.

V Edge Gain (Vertical Large Edge Enhancement Gain)

: Sets the contour enhancement level in the vertical direction.

V Edge Threshold (Vertical Large Edge Enhancement Threshold)

: Sets the minimum luminance signal level accepted for vertical edge gain processing.

Note : Sharpness controls overall gain. If the brightness signal is ineffective, raise the Sharpness.

❖ Chrominance



Menu item	Adjustment range
H Edge Gain	0 ← → 31
H Edge Threshold	0 ← → 31
V Edge Gain	0 ← → 31
Enhancement	0 ← → 31
Delay	-3 ↔ 0 ↔ +3

H Edge Gain (Horizontal Large Edge Enhancement Gain)

: Sets the contour enhancement gain of the color signal in the horizontal direction.

H Edge Threshold (Horizontal Large Edge Enhancement Threshold)

: Sets the minimum signal level accepted for color signal horizontal edge gain processing.

V Edge Gain (Vertical Large Edge Enhancement Gain)

: Sets the contour enhancement gain of the color signal in the vertical direction.

Enhancement (Enhancer Gain)

: Sets the overall enhancement of the color signal.

Delay

: Sets the time delay of the chrominance signal with respect to the luminance signal.

❖ Sub Control



Menu item	Adjustment range
Contrast Red	0 ← → 255
Contrast Green	0 ← → 255
Contrast Blue	0 ← → 255
Brightness Red	0 ← → 255
Brightness Green	0 ← → 255
Brightness Blue	0 ← → 255
Clamp Position	-128 ← → 127
Clamp Width	-128 ← → 127

Contrast Red

: Sets how much red contrast comes out in images.

Contrast Green

: Sets how much green contrast comes out in images.

Contrast Blue

: Sets how much blue contrast comes out in images.

Brightness Red

: Sets how bright red comes out in images.

Brightness Green

: Sets how bright green comes out in images.

Brightness Blue

: Sets how bright blue comes out in images.

Clamp Position

: Sets the clamp position.

Clamp Width

: Sets the clamp width.

❖ Miscellaneous

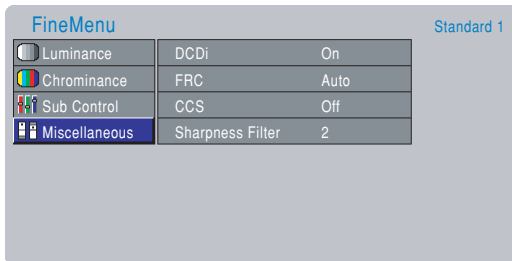

Menu item	Adjustment range
DCDi	On ← → Off
FRC	Auto ← → On
CCS	On ← → Off
Sharpness Filter	0 ← → 4

DCDi

: Turns the DCDi feature on/off.

FRC (Frame Rate Conversion)

Auto : Basically disables frame rate conversion, but it is enabled by the vertical frequency of the input signal.

On : Enables frame rate conversion. All input signals are converted to 60 Hz.

CCS (Cross Color Suppression Function)

On : Enables cross color suppression.

Off : Disables cross color suppression. Use this mode for sources that do contain cross colors, such as progressive scanning DVD players.

Sharpness Filter

: Sets the sharpness of DVI and RGB images.

Setting

You can make the following settings.

Menu		Standard 1
Picture Adjust	Lamp Mode	High
Setting	High Bright	Off
System	Aspect	Full
Display	OSD Position	16:9
Config	VCR Mode	Off
Trigger 2	Cinema	Auto
Preset	Black Setup	0 IRE

Lamp Mode	High / Low
High Bright	On, Off High Bright On : Display brightest image.
Aspect	Full, Normal, Zoom, Through
OSD Position	16:9, 4:3, Through
VCR Mode	On, Off
Cinema	Auto, Off Cinema mode: 2-3 pulldown for NTSC, 2-2 for PAL
Black Setup	0IRE, 7.5IRE /NORMAL, EXPAND (For DVI input) Adjusts black level to the source.

– OSD Position

You can select from three positions: 16:9, 4:3 and Through.

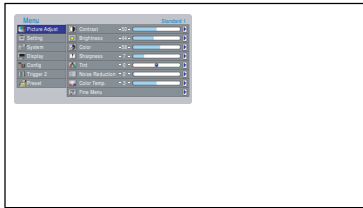

OSD position for 16:9

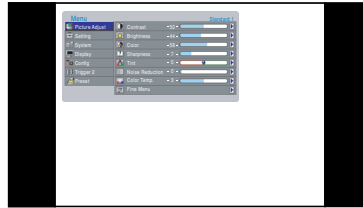

OSD position for 4:3

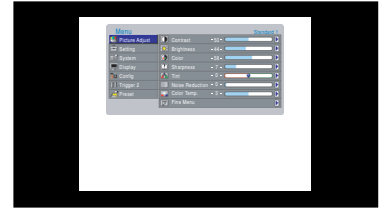

OSD position for Through

– VCR Mode

On : Stabilizes the picture. Use to play back video or input TV signals of weak electromagnetic waves if the image is unstable when the mode is off.

Off : Normally use this mode.

❖ How to Operate the Setting Menu

1. Select the desired menu item and press the ► button.
The setting item will appear on the screen.
2. Use the ▲ and ▼ buttons to set the item.
3. Press the ◀ button to enter the setting and return to menu item selection.

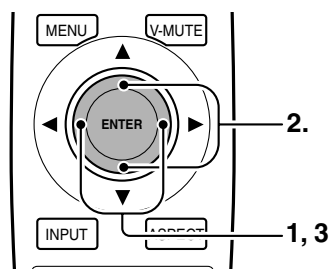
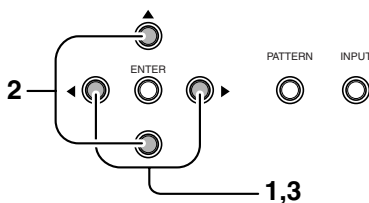

System

You can make the following settings.

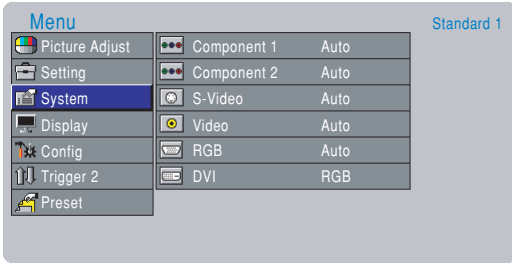

Component 1	Auto, NTSC, PAL, 480p, 540p, 576p, 720p, 1035i, 1080i
Component 2	Auto, NTSC, PAL, 480p, 540p, 576p, 720p, 1035i, 1080i
S-Video	Auto, NTSC, PAL, SECAM
Video	Auto, NTSC, PAL, SECAM
RGB	Auto, NTSC, PAL, 480p, 540p, 576p, 720p, 1035i, 1080i
DVI	RGB, YP_BP_R, YC_BC_R Sets the color space conversion for DVI input. RGB: Does not convert color space. YP _B P _R : Suitable for high definition TV signals such as 720p and 1080i. YC _B C _R : Suitable for signals such as 480p and 576p.

NTSC (3.58)

: Conventional analog broadcasting format used mainly in Japan, the USA, Canada, Taiwan and Korea.

PAL (4.43)

: Conventional analog broadcasting format used mainly in the UK and Germany.

SECAM

: Conventional analog broadcasting format used mainly in the France and Russia.

480p

: Standard digital broadcasting format.

540p

: Special digital broadcasting format (i.e., RCA DTC100).

576p

: Standard digital broadcasting format.

720p /1080i

: High Definition digital broadcasting format.

1035i

: Japanese "High-Vision" broadcasting format.

❖ How to Operate the System Menu

1. Select the desired menu item and press the ► button.
The setting item will appear on the screen.
2. Use the ▲ and ▼ buttons to set the item.
3. Press the ◀ button to enter the setting and return to menu item selection.

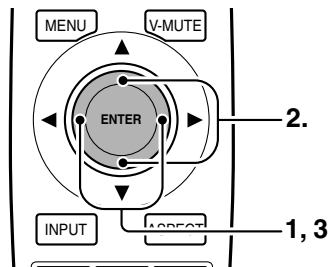
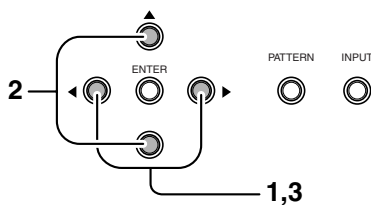

You can make the following settings.

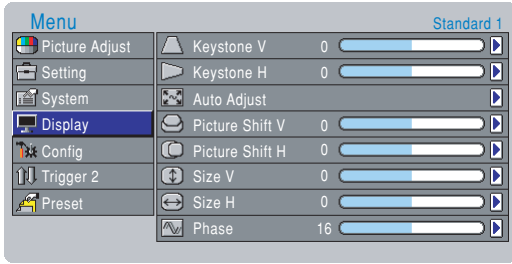

Menu item	Adjustment range
Keystone V (Electronic vertical keystone correction)	-30 ← → 30
Keystone H (Electronic horizontal keystone correction)	-30 ← → 30
Auto Adjust	Yes / No
Picture Shift V	-50 ← → 50
Picture Shift H	-50 ← → 50
Size V	-50 ← → 50
Size H	-50 ← → 50
Phase	0 ← → 31

– Keystone V / H

Corrects the trapezoidal shape of the projected image. (For details, “Keystone Correction” pg. 19.)

– Auto Adjust

Use this mode for RGB input when RGB System on the System menu is set to “Auto”.

Yes : The Picture Shift V/H, vertical/horizontal resolution and Phase of the RGB signal are set automatically.

No : Disables automatic image adjustment. Set Picture Shift V/H, Size V/H and Phase yourself.

Select “Yes” with the ◀ and ▶ buttons and press the **ENTER** button.

– Picture Shift V / H

Shifts the position of the image. Picture Shift V shifts the image up/down, while Picture Shift H shifts the image left/right.

– Size V / H

Sets the vertical and horizontal size of the image.

– Phase

Sets the phase of the analog RGB signal from the computer and the clock phase of the A/D converter. Adjust the image to where it looks the clearest.

❖ How to Operate the Display Menu

1. Select the desired menu item and press the ▶ button.
The setting item will appear on the screen.
2. Use the ◀ and ▶ buttons to set the item.
3. Press the ▲ button to enter the setting and return to menu item selection.

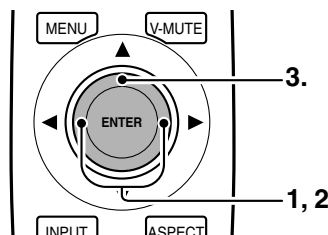
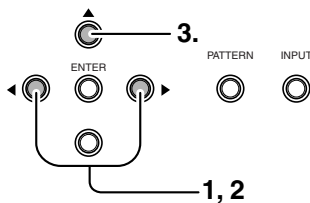

Configuration

You can configure the projector from the following settings.

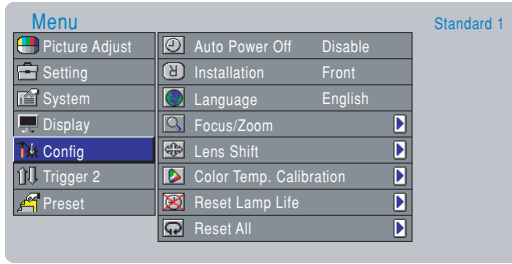

Auto Power Off	Enable / Disable
Installation	Front, F.Ceiling, Rear, R.Ceiling
Language	English, Français, Deutsch, Español, Italiano, Português
Focus/Zoom	Adjusts the focus and size of the projected image.
Lens shift	Positions (all directions) the projected image on the screen.
Color Temp. Calibration	Yes / No
Reset Lamp Life	Yes / No
Reset All	Yes / No

– Auto Power Off

When the auto power off feature is turned on, the below message appears on the screen if no signals are received and no operations are performed for 9 consecutive minutes. Power to the projector then shuts off automatically if the situation continues for another minute.

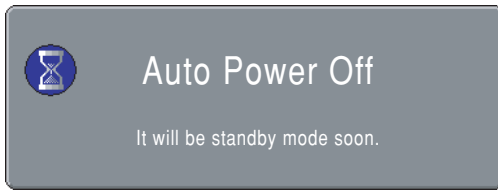

About 1 minute after the message appears on the screen, power to the projector shuts off.

Note:

After the above message appears on the screen, pressing any button on the projector other than the **POWER** button or any button on remote controller other than the **POWER ON** or **STANDBY** button resets the auto power off feature. The auto power off feature will start counting the time off any time after that, the moment that the projector goes without receiving any signals or being operated in anyway.

– Installation

Sets the projector installation mode.

- Front : Select this mode when the projector is installed on a flat surface in front of the screen.
- F. Ceiling : Select this mode when the projector is mounted on a ceiling in front of the screen.
- Rear* : Select this mode when the projector is installed on a flat surface behind the screen.
- R. Ceiling* : Select this mode when the projector is mounted on a ceiling behind the screen.

* When projecting the image from behind the screen, use a rear-projection screen.

– Focus/Zoom

Adjusts the focus and size of the projected image.

– Lens shift

Positions (all directions) the projected image on the screen. (For details, see “Positioning the Projected Image” pg. 18.)

– Color Temp. Calibration

After replacing the lamp or otherwise when the lighting changes, you can adjust the color temperature using the color temperature sensor. For instructions on how to adjust color temperature, see “Color Temperature Adjustment” pg. 38).

– Reset Lamp Life

If you replace the lamp before the 1,500 hour lamp life, be sure to reset the lamp life counter. To do this, select “Reset Lamp Life” from the Config menu. When you do so, the below message appears on the screen.

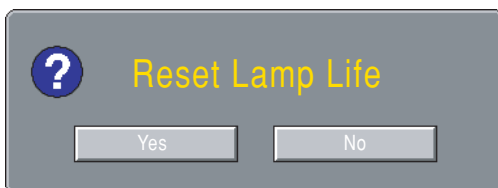

Select “Yes” and press the **ENTER** button. This will reset the lamp life counter.

– Reset All

Resets all settings to their factory defaults except the user-selected gamma curve and the lamp life counter. When you select “Yes”, the following message appears on the screen.



Select “Yes” and press the **ENTER** button.

❖ How to Operate the Config Menu

1. Select the desired menu item and press the ► button.
The setting item will appear on the screen.
2. Use the ▲ and ▼ buttons to set the item.
3. Press the ◀ button to enter the setting and return to menu item selection.

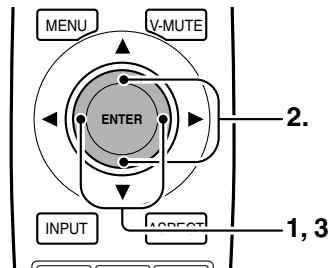
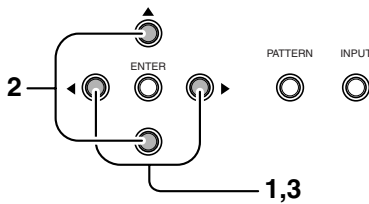

Trigger 2

You can turn the trigger signal output from the TRIG. 2 jack on (12 V output)/off (no output) for each of the aspect modes: Full, Normal, Zoom and Through. This trigger signal can be used to automatically match the screen aspect mode to projector operation, though it requires a powered dual aspect screen.

- On: 12 V output**
- Off: No output**

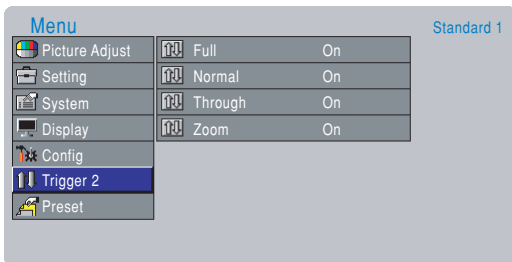

❖ How to Operate the Trigger 2 Menu

1. Select the desired menu item and press the ► button.
The setting item will appear on the screen.
2. Use the ▲ and ▼ buttons to set the item.
3. Press the ◀ button to enter the setting and return to menu item selection.

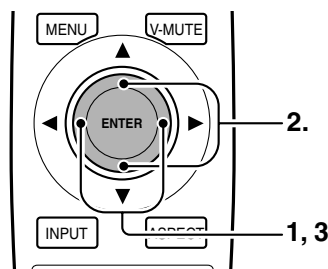
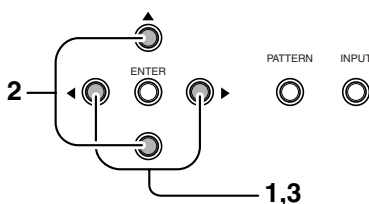

Preset

You can select a picture mode from the MENU screen. This projector offers 4 pictures modes: Theater, Standard, Dynamic and User. Moreover, each of these picture modes has 3 indexes for saving picture quality adjustments.

- **Theater** : Reproduces the kind of black suited for movie software.
- **Standard** : Suited for normal movie software.
- **Dynamic** : Suited for visually dynamic movie software.
- **User** : Enables you to adjust the gamma curve as preferred.

Note : Each picture mode has 3 indexes (1, 2 and 3) and a default setting. When default is selected, "Picture Adjust" cannot be selected from the menu.

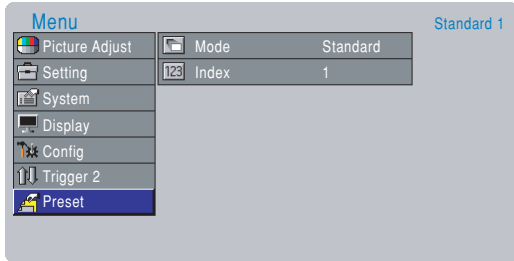

– Saving settings in an index

Select "Mode" from the above menu using the remote controller, then select an image mode from Theater, Standard, Dynamic and User. Next, select "Index" and set a value from "1" to "3". Return to "Picture Adjust" in the main menu and adjust picture quality to your liking. The adjustment made here is automatically saved in memory.

❖ How to Operate the Preset Menu

1. Select the desired menu item and press the ► button.
The setting item will appear on the screen.
2. Use the ▲ and ▼ buttons to set the item.
3. Press the ◀ button to enter the setting and return to menu item selection.

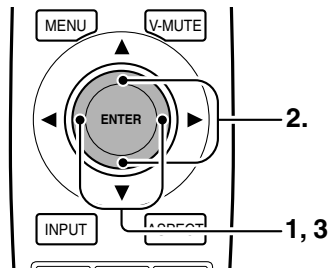
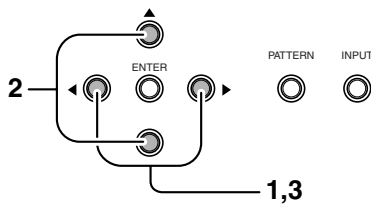

MAINTENANCE

Lamp Life and Replacement

❖ Lamp Life

Pressing the **INFO.** button on the remote controller displays the below message on the screen. The remaining lamp life appears on the second from last line.

Information	
Video Input	Component-1080i
Preset	User A1
Cinema Mode	Auto
Aspect	Full
Trigger 2	On
Lamp Life	927 Hours
Total Hours	3653 Hours

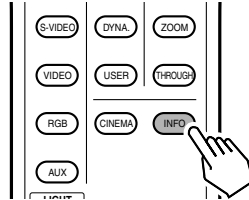

Note:

- The lamp lasts a maximum of 1,500 hours. Although every possible effort has gone into quality, the lamp can – though rarely - burn out after 1,000 hours of lighting. Therefore, it is recommended to replace the lamp promptly when lamp life falls under 500 hours. The lamp must not be used in excess of the maximum lamp life.
- This product is subjected to strict quality controls before shipping from the factory. The “Total Hours” item on the Information screen includes this checking time, therefore the “Total Hours” may not be “0” when the projector is used for the first time.

- When remaining lamp life drops below 100 hours and the projector is on, the below message with the remaining lamp life appears on the screen.

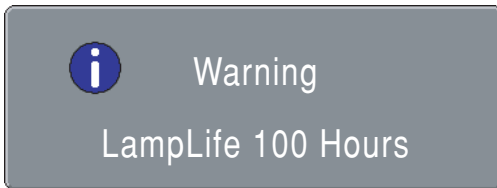

- When remaining lamp life drops below 5 hours, the below message appears on the screen.

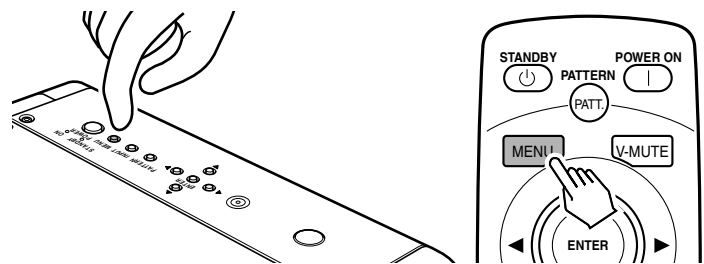
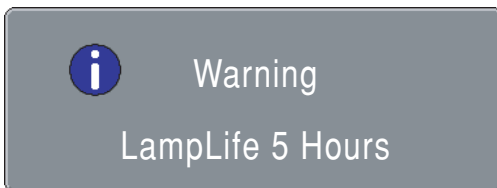

Press the **MENU** button to clear the message from the screen.

- Approximately 2 minutes after the lamp reaches the end of its life, power to the projector shuts off and the WARNING indicator lights up red. If the below message appeared on the screen before power shut off, promptly replace the lamp with a new one. (See “Lamp Unit Replacement” pg. 36.)

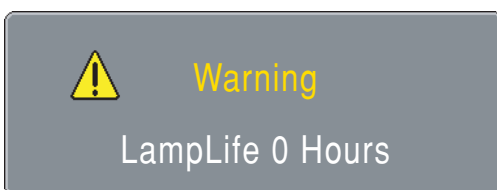

❖ Resetting the Lamp Life Counter

The lamp lasts a maximum of 1,500 hours. The projector is designed to shut off power if the lamp is used beyond this 1,500 hours. In such case, replace the lamp and reset the lamp life counter as follows.

1. After the “Lamp Life 0 Hours” message appears on the screen, power to the projector shuts off. Promptly replace the lamp with a new one. (See “Lamp Unit Replacement” pg. 36.)
2. After replacing the lamp, press either the **POWER** button on the projector or the **POWER ON** button on the remote controller.

The below message will appear on the screen for about 120 seconds.



3. Select “Yes” using the ◀ and ▶ buttons.
4. Press the **ENTER** button to reset the lamp life counter.

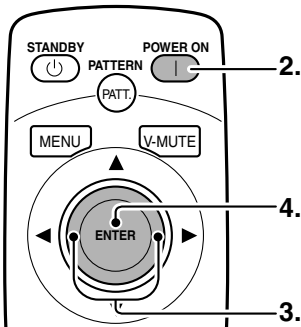
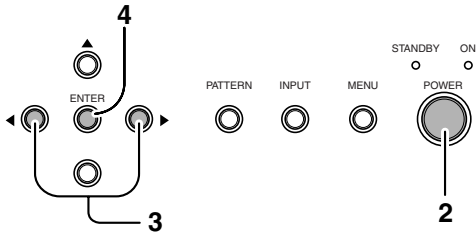

Lamp Unit Replacement

Note:

- The lamp is very hot while lit and shortly after being turned off. Do not touch the lamp or lamp unit while hot. Wait at least 1 hour for the lamp to cool down before handling it.
- Do not loosen any screws except those specifically mentioned in the below procedure.
- The lamp may break under excessive force or mechanical shock.
- Use only the Marantz original lamp unit LU10VPS1 (sold separately).

❖ How to Replace the Lamp

Preparation:

Turn off power to the projector before replacing the lamp. After the cooling fan stops, unplug the AC power cable and wait at least 1 hour for the lamp to cool down. Then, replace it.

1. Press the **STANDBY** button on the remote controller or the **POWER** button on the projector to shut off power to the projector.

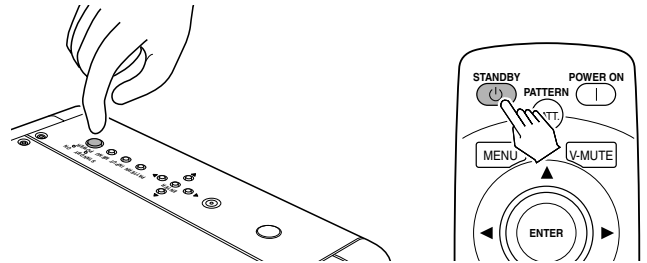

2. After the cooling fan stops, set the **ON/OFF** switch in the OFF position and unplug the AC power cable.

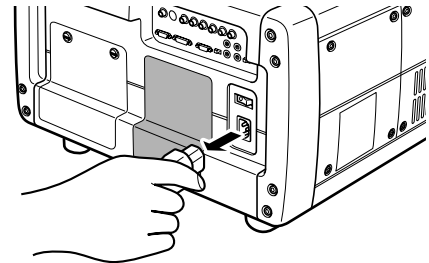

3. Wait at least 1 hour for the projector to cool down sufficiently.
4. Locate the lamp cover on the projector rear (see below). Read the caution and warning labels on the cover.

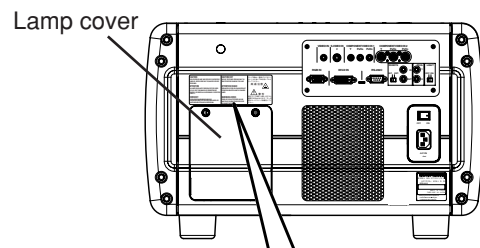

<p>CAUTION HIGH-PRESSURE LAMP MAY EXPLODE IF IMPROPERLY HANDLED. REFER SERVICING TO QUALIFIED SERVICE PERSONNEL.</p>	<p>CAUTION HOT UNPLUG THE POWER CORD AND WAIT 60 MINUTES BEFORE CHANGING THE LAMP.</p>
<p>ATTENTION LA LAMPE SOUS HAUTE PRESSION PEUT EXPLOSER SI ELLE N'EST PAS MANIPULEE CORRECTEMENT. CONFIER L'OPERATION A UN PERSONNEL D'ENTRETIEN QUALIFIE.</p>	<p>ATTENTION CHAUD DEBRANCHER LE CORD ON D'ALIMENTATION ET ATTENDRE 60 MINUTES AVANT DE CHANGER LA LAMPE.</p>
<p>VORSICHT BEI FALSCHER HANDHABUNG KANN DIE HOCHDRUCKLAMPE EXPLODIEREN UBERLASSEN SIE WARTUNGSARBEITEN NUR FACHPERSONAL.</p>	<p>WARNUNG HEISS ZIEHEN SIE DEN NETZSTECKER AB UND WARTEN SIE 60 MINUTEN BEVOR SIE DIE GLUHLAMPE WECHSELN.</p>

5. Loosen the 2 screws that lock down the lamp cover. (Slotted head screwdriver required.)

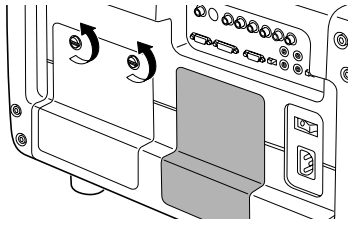

6. Detach the lamp cover in the direction of the arrow.

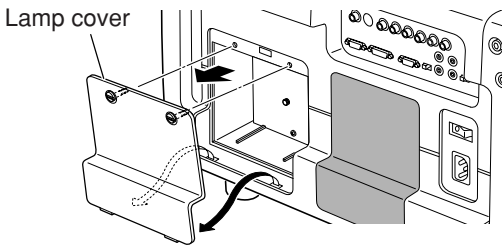

7. Remove the 2 screws that lock down the lamp shield. (Phillips screwdriver required.) Pull the lamp shield downward as indicated in the below figure and detach.

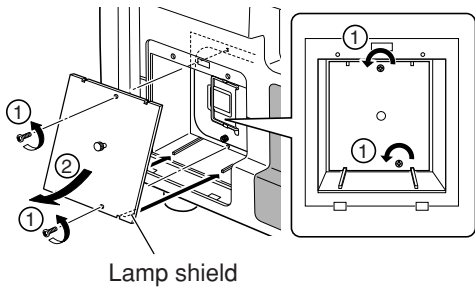

Lamp shield

8. Loosen the 2 screws that lock down the lamp unit. (Slotted head screwdriver required.) Grab the lamp unit by the handle and pull the unit out toward you.

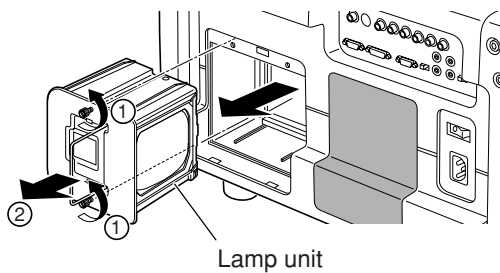

Lamp unit

9. Install a new lamp unit securely in the correct orientation. Lock the lamp unit in place with the 2 screws. (Slotted head screwdriver required.) Fold the handle over as it was before.

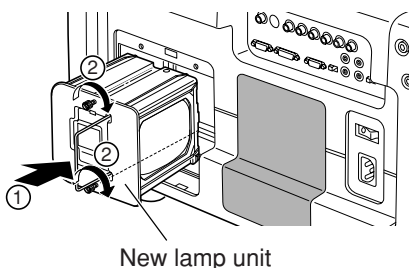

New lamp unit

10. Fit the top end of the lamp shield back into place as shown below, followed by the bottom end. Lock the lamp shield in place with the 2 screws removed in step 7. (Phillips screwdriver required.)

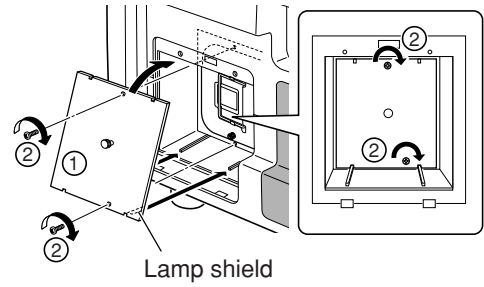

Lamp shield

11. Fit the bottom end of the lamp cover back into place as shown below, followed by the top end.

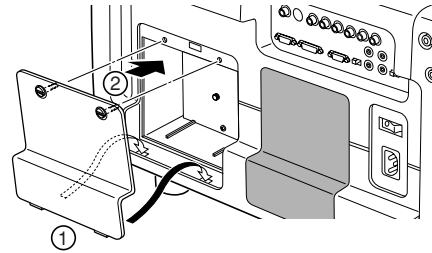

12. Lock the lamp cover in place with the 2 screws loosened in step 5. (Slotted head screwdriver required.)

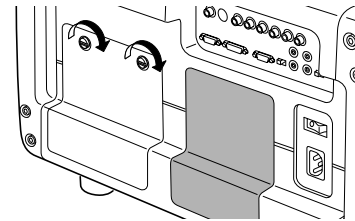

13. Plug in the AC power cable, turn on the projector and project an image.

- If you replaced the lamp before 1,500 hours of service, see "Reset Lamp Life" (pg. 32).
- If you replaced the lamp after 1,500 hours of service, see "Resetting the Lamp Life Counter" (pg. 36).

Color Temperature Adjustment

After replacing the lamp or otherwise when the lighting changes, you can adjust the color temperature using the included color temperature sensor. In the adjustment procedure, you must first initialize the sensor itself before adjusting color temperature. It takes about 10 minutes from when power to the projector is activated for the lamp's brightness to stabilize. Wait for lamp brightness to stabilize before adjusting color temperature.

1. Connect the cable of the color temperature sensor to the RS-232C port.

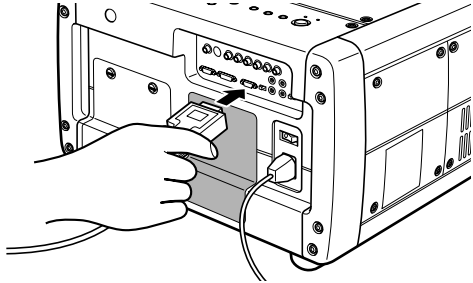

2. Press the **MENU** button, select "Color Temp. Calibration" from the menu and press the **▶** button. The below message appears on the screen.



3. Use **◀** and **▶** buttons to select "Yes" and press the **ENTER** button. The below message appears on the screen.



Before pressing the **ENTER** button, turn the color temperature sensor over on its dark side as shown in the below figure, to prevent outside light from penetrating to the sensor's receptacle.

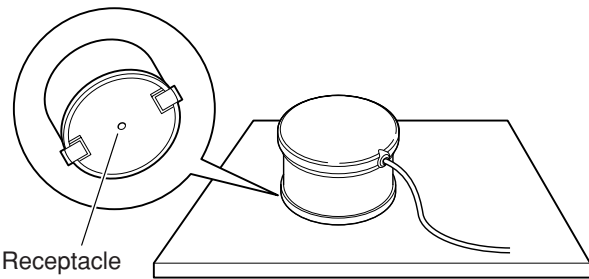

4. Press the **ENTER** button. The below message appears on the screen for a few seconds as the sensor itself is being initialized.

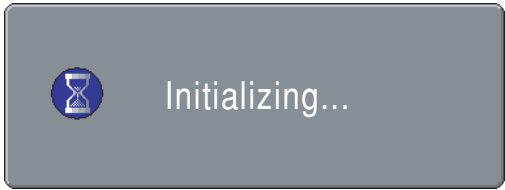

5. Fit the color temperature sensor onto the lens and press the **ENTER** button. The lens automatically shifts to the best position for performing color temperature adjustment. Color temperature adjustment then starts and the projector's **WARNING** and **STANDBY** indicators begin flashing simultaneously.

When installed on a flat surface

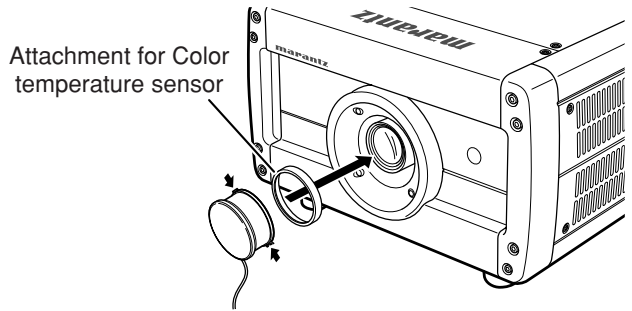

Attach the color temperature sensor so that the cable is to the bottom side of the projector as shown in the figure.

When mounted on a ceiling

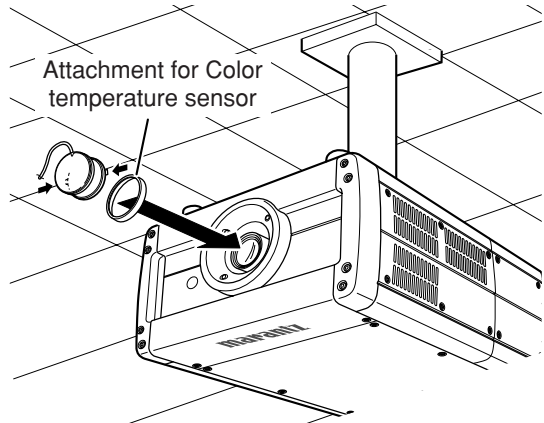

Attach the color temperature sensor so that the cable is to the bottom side of the projector (now upside-down) as shown in the figure.

6. When the **WARNING** and **STANDBY** indicators go out, color temperature adjustment is complete. Adjustment takes about 4 to 5 min. When the color temperature sensor is detached from the lens, the below message appears on the screen.

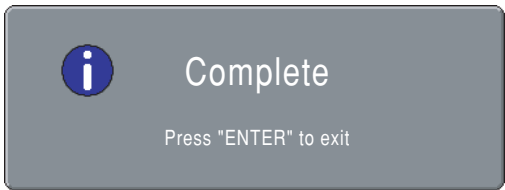

- Press the **ENTER** button to return to the menu and disconnect the cable of the color temperature sensor from the projector.

Note:

If color temperature adjustment is not correctly processed or if adjustment processing is interrupted in course by pressing the **MENU** button or for some other reason, the below message appears on the screen.

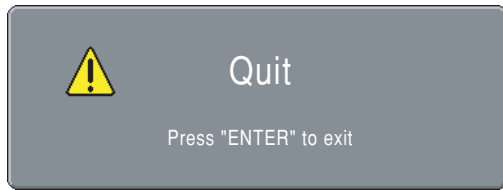

Also, adjustment processing can be interrupted by pressing the **MENU** button.

- Reposition the picture on the screen (up, down, left and right) using the "Lens shift" feature on the Config menu. (See "Configuration"  pg. 32.)

❖ Color Temperature Sensor Protection

If no operations are performed for approximately 10 minutes from the moment color temperature adjustment processing ends, power to the projector shuts off automatically in order to protect the color temperature sensor. If power is shut off to protect the color temperature sensor, do the following.

- **If the WARNING indicator is not lit**

When color temperature adjustment ends successfully and the sensor protection feature trips, the projector goes on standby. As usual, activate power by pressing either the **POWER ON** button on the remote control or the **POWER** button on the projector.

- **If the WARNING indicator is lit**

If color temperature adjustment does not end successfully and the sensor protection feature trips, the projector's WARNING and STANDBY indicators light simultaneously to indicate the error mode. Set the **ON/OFF** switch in the off position, unplug the AC power cable and then plug it back in. Then, set the **ON/OFF** switch in the on position and press either the **POWER ON** button on the remote control or the **POWER** button on the projector to reactivate power.

Lens Cleaning

If the lens becomes dirty or smudged, clean it with a soft dry cloth and an optical lens cleaner that is approved for eyeglasses or cameras. Do not use a dampened cloth, detergent, thinner or other harsh substances. These substances may damage the lens or leave stains. Do not clean the lens while the lamp is on. Always shut off power to the projector and wait at least 60 minutes before cleaning the lens.

Replacement Parts

If replacement parts are needed, contact your nearest Marantz dealer or authorized service center. Use only replacement parts specified by Marantz. Unauthorized substitutes may result in fire, electric shock or other hazards, and will forfeit warranted servicing.

Optional Accessories

- Lamp unit : LU10VPS1

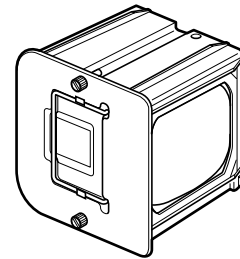

SPECIFICATIONS

❖ Optical characteristics

Technology	3-chip DLP™
Panel	0.8 inch 16:9 1280 x 720 pixels Digital Micromirror Device™
Lamp	P-VIP 250W AC
Lens	1.44 – 1.80:1 (LN10VP32) 1.80 – 2.40:1 (LN10VP40) 2.40 – 3.60:1 (LN10VP53)
Projection size	60 to 300 inch (when using 16:9 screen)
Light output	1200 ANSI LUMEN typical (Lamp Mode : High) 1000 ANSI LUMEN typical (Lamp Mode : Low)

❖ Input/Output

VIDEO IN	RCA x 1 NTSC-35.8 / PAL-4.43/SECAM Composite video 1.0Vp-p / 75 ohm
S-VIDEO IN	S jack x 1 NTSC-35.8/PAL-4.43 / SECAM S-video
COMPONENT VIDEO IN	RCA x 1 BNC x 1 Y, C _B /P _B , C _R /P _R
RGB/HD IN	D-sub M 15-pin x 1 Analog RGB, Y/P _B /P _R
DVI-D IN	DVI-D 24-pin x 1 T.M.D.S. compliant (Single link only)
REMOTE CONTROL IN	Miniature jack type x 1
REMOTE CONTROL OUT	Miniature jack type x 1
AC IN	3-prong grounding type
Trig. 1 Out/Trig. 2 Out	Miniature jack x 2 Output voltage: 12V DC or 0V
RS232C	RS232C receptacle plug x 1

❖ General specifications

Power requirement	AC 100-120V / 220-240V, 50/60 Hz
Power consumption	< 380 W
Standby consumption	< 2.0 W
Chassis isolation	Class-1
Safety	UL60950 CSA C22.2 No.60950 EN60950
EMC	FCC Part-15 Class-B EN55022 Class-B
Dimensions	20.1(W) x 26.5(D) x 12.8(H) inch 510(W) x 672(D) x 326(H) mm
Net Weight	90.3 lb (41 kg)
Operating temperature	50°F to 95°F (10 to 35°C)
Operating humidity	20 to 80%
Storage temperature	-4°F to 140°F (-20 to +60°C)
Storage humidity	5 to 80%
Operating altitude	0 to 4,921 ft (0 to 1,500 m)

❖ Accessories

- Lens cap x 1
- Remote controller x 1
- AA batteries X 2
- AC power cable x 1
- Color temperature sensor x 1
- Attachment for Color temperature sensor x 1
- Control adapter cable (mini jack to RCA) x 1
- User Guide x 1
- Warranty Card (1 copy each for USA, CANADA)

Specifications and appearance are subject to change without notice.

❖ Timing chart

Input Signal

System	Resolution	V (Hz)	H (KHz)	Scan
NTSC	768x240	59.94 / 60	15.73	I
PAL-B/G	960x287.5	50	15.63	I
SECAM	960x287.5	50	15.63	I
480/60p	720x480	59.94 / 60	31.5	P
576/50p	720x576	50	31.3	P
1035/60i	1920x518	59.94 / 60	33.8	I
1080/60i	1920x540	59.94 / 60	33.8	I
1080/50i	1920x540	50	28.1	I
1080/48i	1920x540	48	27.0	I
720/60p	1280x720	59.94 / 60	45.0	P
720/50p	1280x720	50	37.5	P
720/48p	1280x720	48	36.0	P
540/60p	1920x540	59.94 / 60	33.8	P
640x350 ^{#1}	640x350	70	31.5	P
640x350 ^{#1}	640x350	85	37.9	P
640x400 ^{#1}	640x400	70	31.5	P
640x400 ^{#1}	640x400	85	53.7	P
640x480	640x480	60	31.5	P
640x480 ^{#1}	640x480	72	37.9	P
640x480 ^{#1}	640x480	75	37.5	P
640x480 ^{#1}	640x480	85	43.3	P
800x600	800x600	56	35.2	P
800x600	800x600	60	37.9	P
800x600 ^{#1}	800x600	72	48.1	P
800x600 ^{#1}	800x600	75	46.9	P
800x600 ^{#1}	800x600	85	53.7	P
1024x768	1024x768	43	35.5	P
1024x768	1024x768	60	48.4	P
1024x768 ^{#1}	1024x768	70	56.5	P
1024x768 ^{#1}	1024x768	75	60.0	P
1024x768 ^{#1}	1024x768	85	68.7	P

Signal	Video	S-Video	Component	RGB	DVI	Note
NTSC	X	X	—	—	—	
PAL-B/G	X	X	—	—	—	
SECAM	X	X	—	—	—	
Video 60Hz	—	—	X	X	—	#2
Video 50Hz	—	—	X	X	—	
480/60p	—	—	X	X	X	#2
576/50p	—	—	X	X	X	
1035/60i	—	—	X	X	X	#2
1080/60i	—	—	X	X	X	#2
1080/50i	—	—	X	X	X	
1080/48i	—	—	X	X	X	
720/60p	—	—	X	X	X	#2
720/50p	—	—	X	X	X	
720/48p	—	—	X	X	X	
540/60p	—	—	X	X	X	#2
640x350@70Hz	—	—	—	X	X	
640x350@85Hz	—	—	—	X	X	
640x400@70Hz	—	—	—	X	—	
640x480@60Hz	—	—	—	X	X	
640x480@72Hz	—	—	—	X	—	VESA#901101
640x480@75Hz	—	—	—	X	—	
640x480@85Hz	—	—	—	X	—	
800x600@56Hz	—	—	—	X	X	VESA#900601
800x600@60Hz	—	—	—	X	X	VESA#900602
800x600@72Hz	—	—	—	X	—	VESA#900603A
800x600@75Hz	—	—	—	X	—	
800x600@85Hz	—	—	—	X	—	
1024x768@60Hz	—	—	—	X	X	
1024x768@70Hz	—	—	—	X	—	
1024x768@75Hz	—	—	—	X	—	

#2 : both of 59.94 and 60Hz

I : Interlaced signal
P : Progressive signal

Notes:

- The systems marked #1 are not displayed properly.
- Any signals not in the list above may not be projected properly.

GLOSSARY

Aspect ratio

Width and height ratio of an image. The aspect ratio of ordinary computer monitors and TV screens is 4:3. The aspect ratio for wide screens ranges from 16:9 to 21:9.

Black level

The level of brightness in black areas or the absence of light, which incidentally is black.

For NTSC of the US, it is 7.5IRE.

NORMAL: 16 (Black) to 235 (White)

For NTSC in Japan, it is 0IRE.

EXPAND: 0 (Black) to 246 (White).

Color temperature

Hue of white light. An image of low color temperature has a warm feeling (more yellow and red). An image of high color temperature has a cold feeling (more blue).

Keystone

Distortion of an image caused by projection to wrong vertical and horizontal angles.

A/D converter (Analog/Digital signal converter)

With this projector, all video signals are digitally processed by an A/D converter. The A/D converter converts analog video signals into data that supports digital processing.

TROUBLESHOOTING

Try the following troubleshooting before calling for service.

1. Are the connections made properly ?
2. Are you operating the unit properly, following the instructions ?

If the unit does not operate properly, check the items shown in the following table.

If any trouble cannot be solved by the instructions below, malfunction of the internal circuitry is suspected; immediately unplug the AC power cord and contact Marantz dealer or service center.

Symptom	Possible Cause	Remedy
No power	AC power cord is not connected correctly.	Connect the AC power cord properly.
	Lamp cover is not closed correctly.	Close the cover properly.
Image is not displayed.	A signal cable is not connected correctly.	Connect a signal cable properly.
	Selected input is incorrect.	Select the correct input source .
	The picture mute is active.	Press the MUTE button to release the mute.
Poor color.	Picture is not adjusted properly.	Adjust the picture in the MENU mode.
Picture is too dark.	Lamp life is running out.	Replace the lamp.
	Contrast or brightness is not adjusted properly.	Adjust contrast or brightness properly.
Picture is not clear.	Picture is out of focus.	Adjust the focus.
	Dew is on the lens.	Run the projector for about two hours.
Picture rolls.	A signal cable is not properly connected.	Connect a signal cable properly.
The Remote Controller does not work.	Batteries are exhausted.	Replace batteries.
	The distance to the unit is too far.	Make the distance between the unit and the remote control closer.
	IR sensor on unit is obstructed.	Remove any obstacles.
	The "EXTERNAL" position on the connector panel is selected.	Select the "INTERNAL" position.
Color temperature cannot be adjusted.	Is the sensor cable disconnected?	Correctly connect the sensor cable.
	Was the sensor correctly initialized?	Initialize the sensor by taking the correct procedures.
	Is the lens shift knob set to the correct (center) position?	Set the lens shift knob to the correct (center) position by taking the correct procedures.

Note:

- If the lamp still does not function after the replacement and initialization of the lamp life, contact a Marantz authorized dealer, or service center.

Note: This projector uses a microcomputer. External noise can cause malfunctions. In such case, shut power OFF and unplug the power cable from AC power outlet. Then, plug the AC power cable back in, press the **POWER** button on the projector or the **POWER ON** button on the remote control and check operation.

ERROR MODE

WARNING indicator, POWER ON indicator, and STANDBY indicator diagnose error mode of the projector as follows.

Error mode	Indicators			Possible Cause	Recommendation
	WARNING	POWER ON	STANDBY		
Lamp cover	ON	OFF	Flashing	The lamp cover is not closed properly.	Close the cover correctly.
Lamp	ON	OFF	OFF	The lamp has failed, or the lamp is completely worn out.	Replace the lamp and reset lamp life.
Temperature	Flashing	OFF	Flashing	Projector internal temperature is higher than the allowed level.	Check if anything is blocking the exhaust vent.
Fan	Flashing	OFF	ON	Trouble has occurred with the fan.	
Color temperature adjustment	ON	OFF	ON	Color temperature adjustment failed.	Retry adjustment.
Other	Flashing	OFF	OFF	Internal program error	Shut power OFF and ON again.

ON SCREEN MESSAGE

Use the list below to check the message displayed on the screen.

Message	Meaning	Remedy
NO SIGNAL	No input signal.	Properly connect the cables.
REPLACE LAMP!	The lamp has reached the end of its life.	Replace the lamp and reset lamp life.
OUT OF RANGE	Improper signal feed to the projector.	Adjust resolution, V(Hz) : refresh rate of the equipment, referring to the Timing Chart.

DIMENSIONS

❖ Top

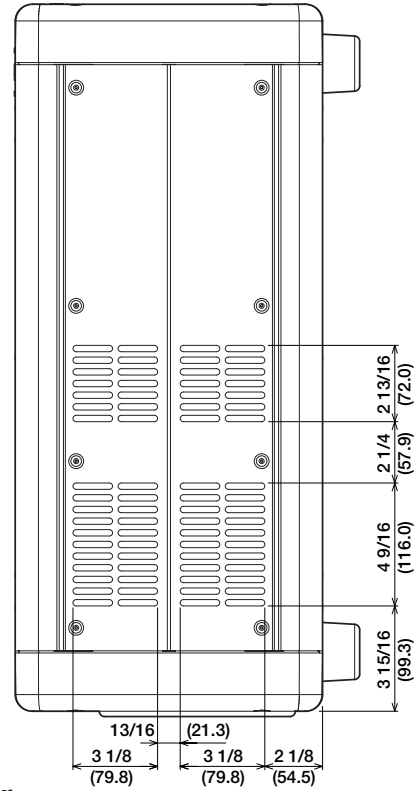
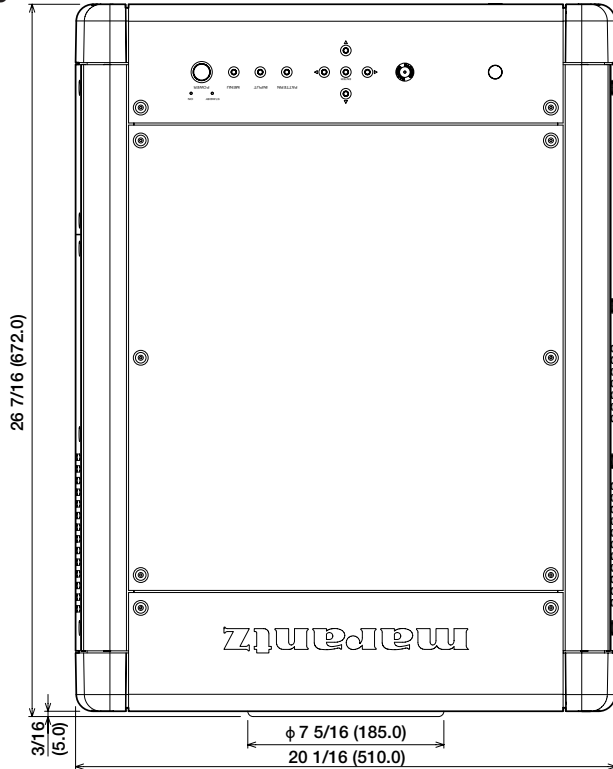

❖ Front

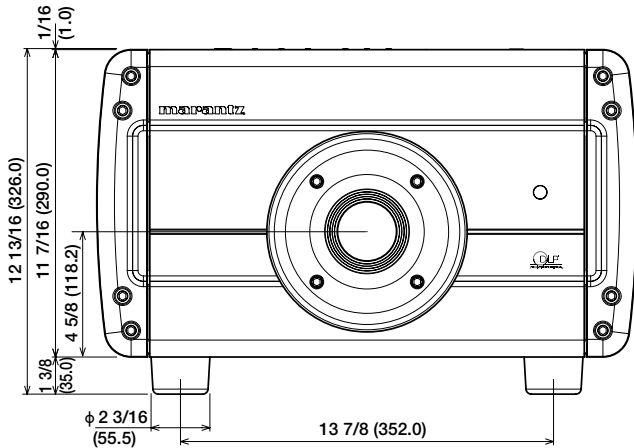

❖ Rear

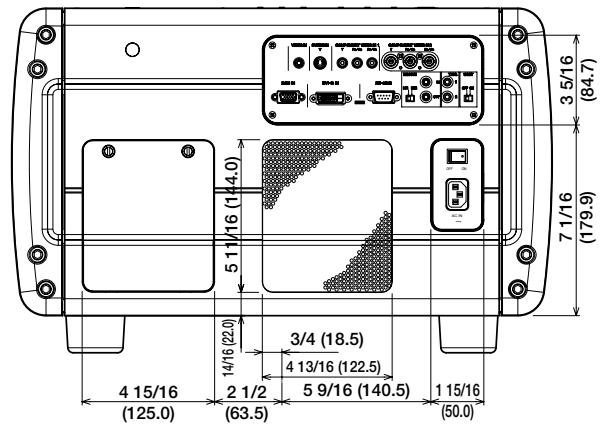

❖ Bottom

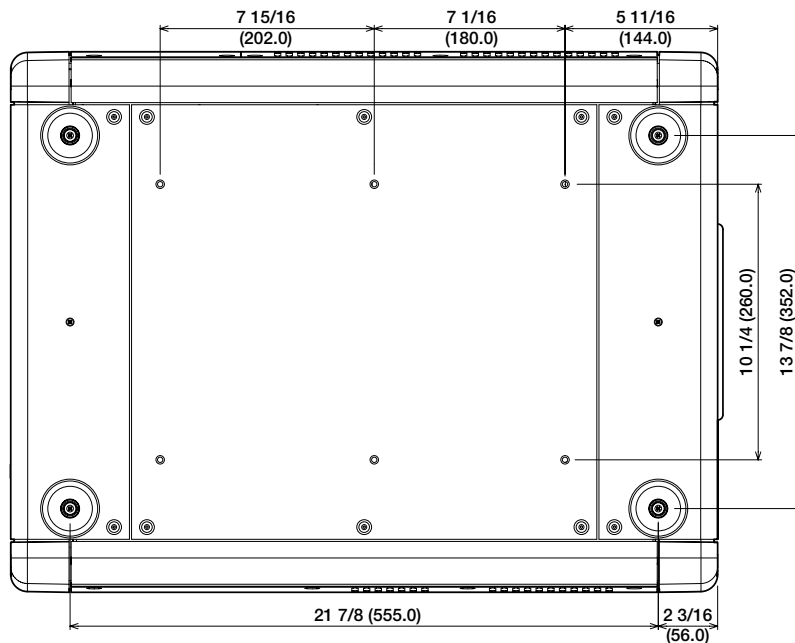

Unit : inch (mm)

www.marantz.com

You can find your nearest authorized distributor or dealer on our website.

JAPAN	Marantz Japan, Inc.	35-1 Sagami Ohno 7-Chome, Sagamihara-shi, Kanagawa 228-8505, Japan
U.S.A.	Marantz America, Inc.	1100 Maplewood Drive, Itasca, IL 60143, U.S.A.
EUROPE	Marantz Europe B.V.	P.O. Box 8744, 5605 LS Eindhoven, The Netherlands

marantz[®] is a registered trademark.

