

***myprojectorlamps.com***

**The most trusted, dependable name  
in projector lamp sales.**



<http://www.myprojectorlamps.com>

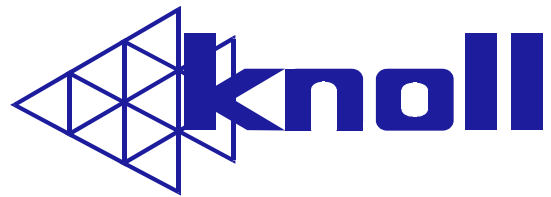


<http://www.myprojectorlamps.ca>



<http://www.myprojectorlamps.eu>

The following projector manual has not been modified or altered in any way.



# HD282

HDTV  
DLP Projector



Users Manual v1.1

---

**FCC Warning**

This equipment has been tested and found to comply with the limits for a Class B digital device, pursuant to part 15 of the FCC Rules. These limits are designed to provide reasonable protection against harmful interference in a residential installation. This equipment generates, uses and can radiate radio frequency energy and, if not installed and used in accordance with the instructions, may cause harmful interference to radio communications. However, there is no guarantee that interference will not occur in a particular installation. If this equipment does cause harmful interference to radio or television reception, which can be determined by turning the equipment off and on, the user is encouraged to try to correct the interference by one or more of the following measures:

Reorient or relocate the receiving antenna.

Increase the separation between the equipment and receiver.

Connect the equipment into an outlet on a circuit different from that to which the receiver is connected.

Consult the dealer or an experienced radio/TV technician for help.

**Canada**

This Class B digital apparatus complies with Canadian ICES-003.

Cet appareil numérique de la classe B est conforme à la norme NMB-003 du Canada.

**Safety Certifications**

UL, CUL, TÜV, NOM, IRAM, GOST, CCC, MIC, S-JQA

**Declaration of Conformity**

Knöll Systems, 11791 Machrina Way, #120, Richmond, BC V7A 4V3 Canada

We declare under our sole responsibility that the HD282 projector conforms to the following directives and norms:

EMC Directive 89/336/EEC, Amended by 93/68/EEC

EMC: EN 55022

EN 55024

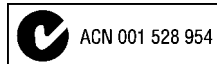
EN 61000-3-2

EN 61000-3-3

Low Voltage Directive 73/23/EEC, Amended by 93/68/EEC

Safety: EN 60950: 2000

October, 2002

**Australian Certification C-tick mark****Trademarks**

Apple, Macintosh, and PowerBook are trademarks or registered trademarks of Apple Computer, Inc. IBM is a trademark or registered trademark of International Business Machines, Inc. Microsoft, PowerPoint, and Windows are trademarks or registered trademarks of Microsoft Corporation. Digital Light Processing is a trademark or registered trademark of Texas Instruments. Faroudja, DCDi, and TrueLife are trademarks or registered trademarks of Faroudja. Knöll is a trademark or registered trademark of Pacific Sound & Signal Inc.

**WARNING:** This product contains chemicals, including lead, known to the State of California to cause birth defects or other reproductive harm. ***Wash hands after handling.***

**WARNING:** This product has a lamp, which contains a very small amount of mercury. Dispose of it as required by local, state, or federal ordinances and regulations. For more information, see [www.eiae.org](http://www.eiae.org).

**TABLE OF CONTENTS**

Safety Warnings	2
Safety Instructions	4
Introduction/Usage guidelines	5
Setting up and positioning the projector	6
Projection distances	7
Video device connections	8
Displaying a video image	10
Connecting a computer	11
Shutting down the projector	12
Troubleshooting your setup	12
Using the keypad buttons	15
Using the remote control	16
Optimizing video images	17
Customizing the projector	17
Using the menus	17
Picture menu	18
Settings menu	22
Maintenance	24
Cleaning the lens	24
Replacing the projection lamp	25
Specifications	26
Red LED behavior and projector errors	27
Source compatibility	27
Projector dimensions for ceiling mount installations	29
RS-232 terminal specifications	30
Warranty	34

## SAFETY INSTRUCTIONS

Please read and follow all safety instructions provided **BEFORE** using your new projector. Failure to comply with safety instructions may result in fire, electrical shock, or personal injury and may damage or impair protection provided by equipment. Please save all safety instructions.

### Safety Definitions:

**Warning:** Statements identify conditions or practices that could result in personal injury.

**Caution:** Statements identify conditions or practices that could result in damage to your equipment.

### Safety Symbols:



**Attention:** For information about usage of a feature, please refer to the User's Guide.



**Warning:** Hot surface. Do not touch.



An arrow pointing to the lamp door on the projector.

### Safety Terms:



**Warning:** Don't look directly into the lens when the lamp is turned on.



**Warning:** To replace the lamp, turn off the projector and unplug the power cord. To avoid burns, wait 30 minutes before opening the lamp door. Follow all instructions provided in this User's Guide.



**Warning:** Please use the power cord provided. Connect the power cord to a receptacle with a protective safety (earth) ground terminal.

**Warning:** Refer all service to qualified service personnel. Servicing your own projector will void the warranty. See the following page for the technical support contact information.

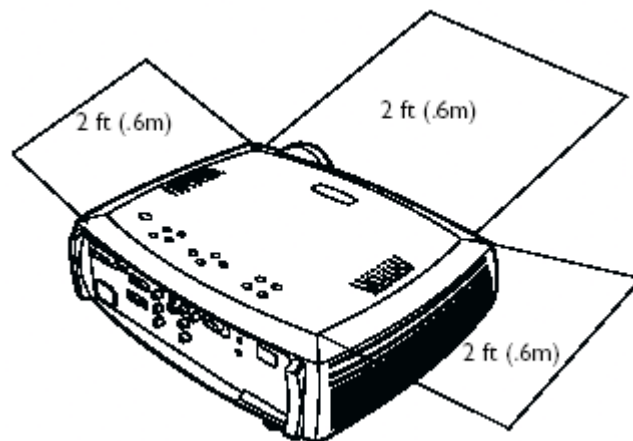
**Caution:** Don't block ventilation openings. Use of an unauthorized ceiling mount may lead to ventilation blockage and/or personal injury.

**Caution:** Don't subject projector to prolonged exposure to smoke.

**Caution:** Don't set liquids on the projector. Spilled liquids may damage your projector.

**Caution:** Don't place the projector on a hot surface or in direct sunlight.

**Caution:** Do not drop the projector. Transport the projector in a Knöll approved shipping carton.



### Important Operating Considerations

Do not place any objects along the side or the front of the projector for at least 2 feet (0.6m).

Do not place the projector on a tablecloth or other soft covering that may block the vents.

Do not use a non-Knöll ceiling mount. In the unlikely event of the bulb rupturing, thoroughly clean the area around the projector and discard any edible items placed in that area.

## INTRODUCTION

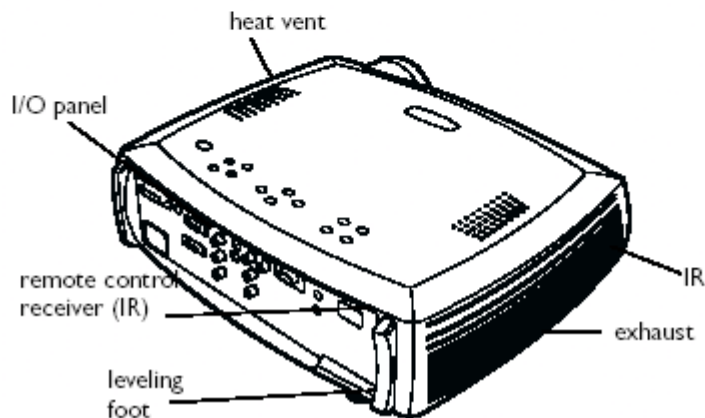
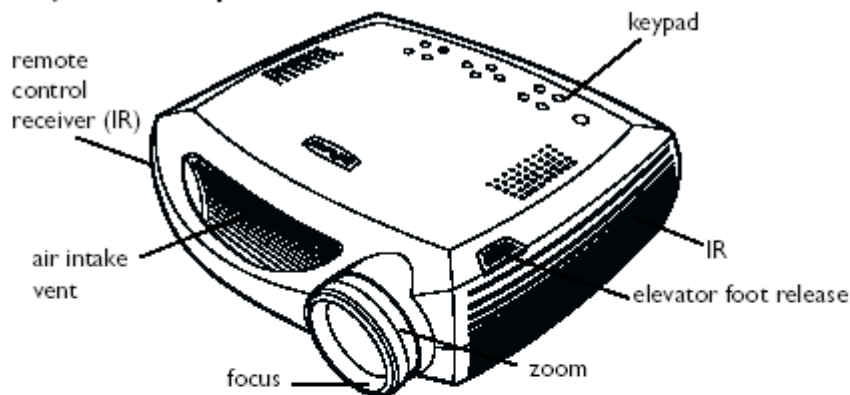
### The Knöll HD282 Introduction

Congratulations and thank you for your choice of a superior digital image projection device. Your new Knöll HD282 is specifically designed for home cinema applications. The HD282 sets new standards for high-definition digital perfection, featuring true High Definition 1280x720 resolution using the latest DLP™ technology and new DCDi video processing from Faroudja™. Calibrated to D65 color mastering standards, the HD282 reproduces colors and details the way the director intended. Whether you are watching movies or High Definition broadcasts or playing the latest video game, you will enjoy breathtaking image quality.

### Usage Guidelines

1. Do not look directly into the projection lens when the lamp is turned on. The bright light may harm your eyes.
2. Do not block the grills on the projector. Restricting the airflow can cause it to overheat and turn off. If this happens, you must wait a minute before turning it back on.
3. Handle the projector as you would any product with glass components. Be especially careful not to drop it.
4. Avoid leaving the projector in direct sunlight or extreme cold for extended periods of time. If this happens, allow it to reach room temperature before use.

### Projector components and features



5. Transport the projector in a vendor-approved hard or soft case.

6. Do not subject projector to prolonged exposure to smoke. Smoke may cause damage to the projector.

## SETTING UP THE PROJECTOR

There are a number of factors to consider when determining where to set up the projector, including the size and shape of your screen, the location of your power outlets, and the distance between the projector and the rest of your equipment. But here are some general guidelines.

**NOTE:** To ensure adequate cable access, do not place the projector within 6 inches (.15m) of a wall or other object.

Position the projector on a flat surface at a right angle to the screen.

The projector should be within 10 feet (3 m) of your power source and within 6 feet (1.8 m) of your video source(s), unless good quality extension cables are to be used.

When installing the projector on the ceiling, refer to the installation guide that comes with the Ceiling Mount Kit for more information. Knöll recommends use of an authorized Knöll CM25 ceiling mount. The addition of a CM20+6 extension bar lowers the projector 6" per bar as required. The ceiling mount kit may be sold separately.

Position the projector the desired distance from the screen.

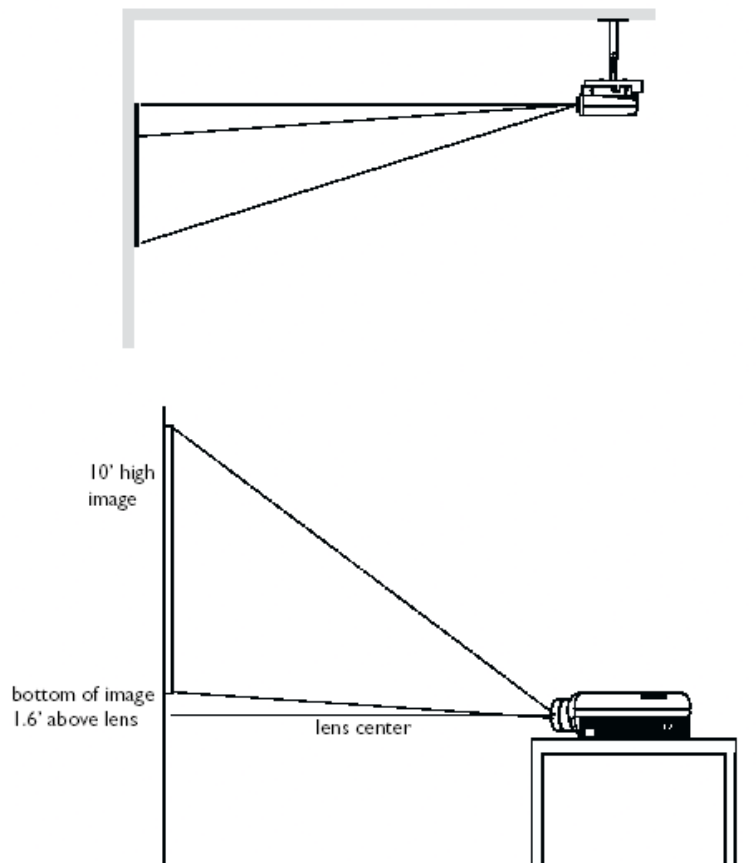
**NOTE:** The projector must be at least 5.6 feet (1.7 m) from the projection screen.

The distance from the lens of the projector to the screen, the zoom setting, and the video format determine the size of the projected image.

### Projector Positioning

The projected image becomes larger as the distance between the unit and screen increases.

The HD282 manual zoom allows the distance from the screen to be within a minimum and maximum range. See the chart on the next page for details. The example on the right shows a very large image 10' high by 17.8' wide. Note the bottom of the image starts about 1.6' above the lens center with a horizontally or flat mounted projector.



## HD282 Projection Distances 16:9 Image

<b>Screen Diagonal</b>	92"	103"	106"	110"	122.5"	146.75"	165.25"
<b>Min. Distance</b>	133.3"	149.6"	153.3"	160"	178.33"	213.33"	214"
<b>Max. Distance</b>	166.6"	187"	191.6"	200"	222.9"	266.6"	299"
<b>Screen Offset</b>	7.3"	8.2"	8.4"	8.8"	9.8"	11.7"	15"

**Note:** Maximum distance to screen (16.9) = 1.816 x screen diagonal size  
 Minimum distance to screen (16.9) = 1.452 x screen diagonal size  
 Screen offset (image drop or rise) (16.9) = 0.08 x screen diagonal size

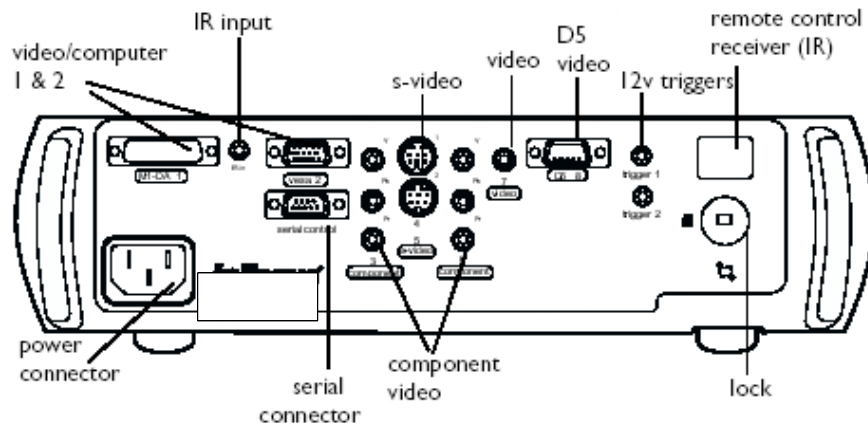
## Rear Connector Panel

The projector provides eight discreet video connectors:

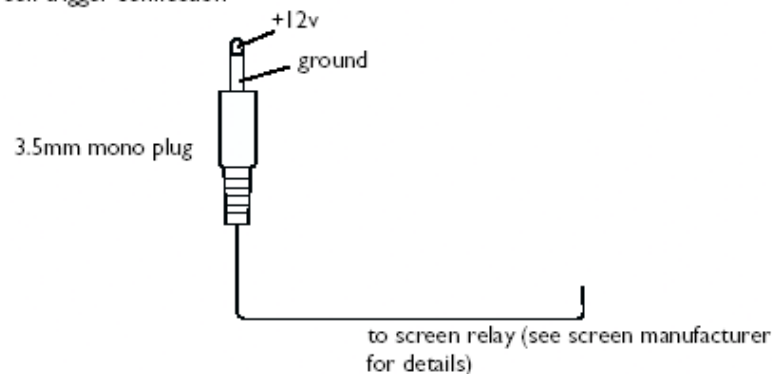
two component RCA, two S-video, one composite RCA, one M1-DA (HD, DVI, and computer), one VESA (HD, HD component, and computer) and one component D5.

It also has a mini-jack input for a Knöll, Niles or Xantech-compatible IR repeater and an RS-232 connector for serial control. The Command Line Interface (CLI) specifications and commands are listed in the Appendix.

Two 3.5 mm mini-jack triggers provide 12-volt current. Trigger 1 provides a constant output while the projector is on. If you connect your projection screen to Trigger 1, when you turn on the projector the screen will move down; when you turn the projector off, the screen will return to the storage position. Trigger 2 provides a 4:3 aspect trigger. When you select 4:3 in the Aspect Ratio menu or from the **Resize** button on the remote, a 12v signal will be sent after a five second delay. Use this trigger for screens with 4:3 aspect curtains. When you switch back to 16:9 format, the curtains open to reveal the entire screen.



screen trigger connection





## Video Connections

1. Place the projector on a flat surface or using a ceiling mount kit, on the ceiling. If you want to project from behind a rear projection screen, set up the projector behind your screen.
2. Position the projector the desired distance from the screen. The distance from the lens of the projector to the screen and the zoom setting determine the size of the projected image. See the table on page 7 for maximum and minimum distances for a given screen size.
3. Make sure the projector and source equipment and/or computer are turned off. Make sure the projector is unplugged and your equipment is turned off.

**WARNING:** Do not place the projector on a tablecloth or other soft covering that may block the vents. Do not use a non-Knöll ceiling mount. In the unlikely event of the bulb rupturing, thoroughly clean the area in front of the projector and discard any edible items placed in that area.

## Connecting a Video Device

You can connect VCRs, DVD players, camcorders, digital cameras, video games, HDTV receivers, and TV tuners to the projector. (You cannot directly connect the coaxial cable that enters your house from a cable or satellite company; the signal must pass through a tuner first. Examples of tuners are digital cable boxes, VCRs, digital video recorders, and satellite TV boxes. Basically, any device that can change channels is considered a tuner.) Audio must be provided by your own speakers, as the projector has no separate audio controls. If

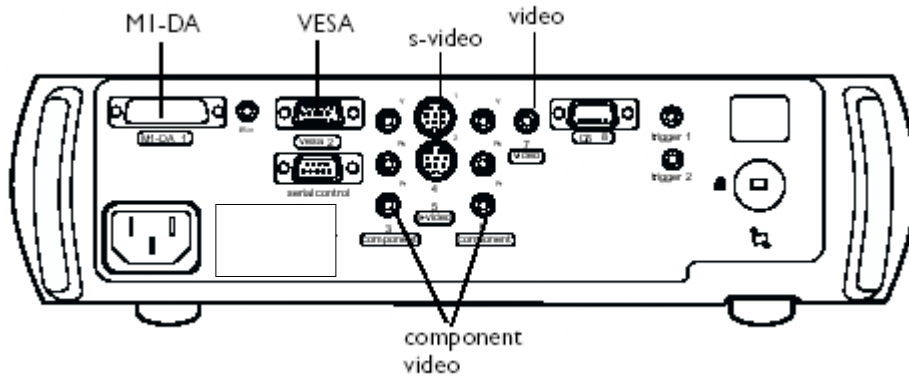
there is more than one output, select the highest quality one. DVI Component video and RGB (M1, HD15) have the best quality, followed by S-video, and then composite video.

**Table 1: Video connections**

Input signal	Connector	Connector label on projector
Standard Broadcast TV (not HDTV), via cable, digital cable, satellite TV, DirectTV	Component video S-video Composite video	Component 3, 6 S-video 4, 5 Video 7
HDTV	Component video VESA DVI	Component 3, 6 VESA 2 M1-DA 1
DVD	Component video S-video Composite video	Component 3, 6 S-video 4, 5 Video 7
VCR	Composite video S-video Component video	Video 7 S-video 4, 5 Component 3, 6
Video Camera	Composite video S-video	Video 7 S-video 4, 5
Video Game	VESA Composite video S-video Component video	VESA 2 Video 7 S-video 4, 5 Component 3, 6

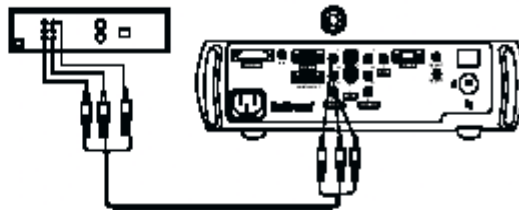
## Connecting a Video Device

If your video device has more than one output, select the highest quality one. DVI video has the best quality, followed by Component video, S-video, and then composite video.

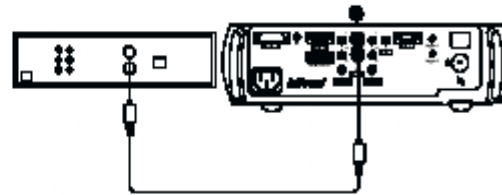


If the video device uses component cable connectors, plug the cable's green connectors into the green component-out connector on the video device and into the green component connector (labeled "Y") on the projector. Plug the component cable's blue connectors into the blue component-out connector on the video device and into the blue component connector (labeled "Pb") on the projector. Plug the component cable's red connectors into the red component-out connector on the video device and into the red component connector (labeled "Pr") on the projector.

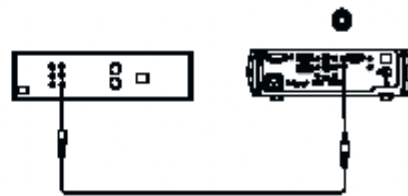
connect component cable



connect S-video cable



connect composite video cable



If the video device uses a round, four-prong S-video connector, plug an S-video cable into the S-video connector on the video device and into the **S-video** connector on the projector.

If the video device uses a yellow composite video connector, plug a composite video cable's yellow connector into the video-out connector on the video device. Plug the other yellow connector into the yellow **Video** connector on the projector.

If the video device uses a DVI connector, plug an M1-D cable into the video-out connector on the video device. Plug the other connector into the **M1-DA** connector on the projector.

connect M1-D cable



If the video device uses a VESA connector, plug a VESA cable into the video-out connector on the video device. Plug the other connector into the VESA connector on the projector.

connect VESA cable

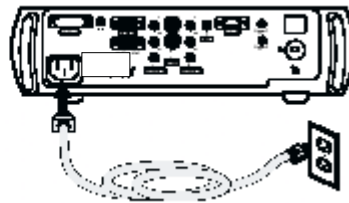


## Connecting the power cable

Connect the power cable to the connector on the back of the projector and to your electrical outlet. The Power LED on the keypad turns solid green.

**NOTE:** Always use the power cable that shipped with the projector.

connect power cable



## Displaying an Image (Video or Computer)

### Displaying a video image

Remove the lens cap.

Press the **Power** button on the top of the projector or the power button on the remote

The projector chimes if the chime feature is enabled. The LED flashes green and the fans start to run. When the lamp comes on, the startup screen displays and the LED is steady green. It can take a minute for the image to achieve full brightness.

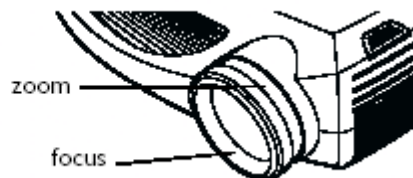
Plug in and turn on the video device.

An image from the video device should appear on the projection screen. If it doesn't, press the **Source** button on the keypad.

Adjust the height of the projector by pressing the release button to extend the elevator foot. Rotate the leveling foot, if necessary.

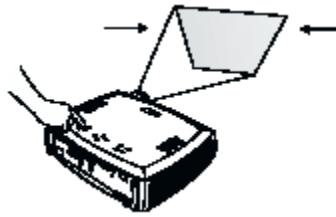
Position the projector the desired distance from the screen at a 90-degree angle to the screen. See page 34 for a table listing screen projected image sizes and distances to the screen. Adjust the zoom and/or focus rings by rotating them until the desired image size and sharpness are produced.

adjust zoom and focus

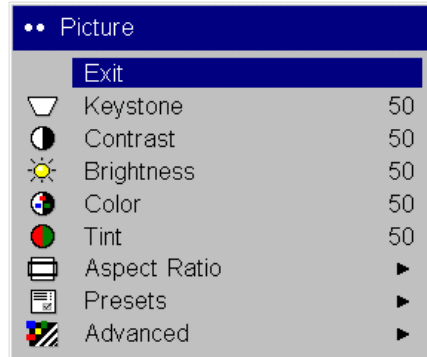


If the image is not square, adjust the keystone using the buttons on the keypad. Press the upper **Keystone** button to reduce the width of the upper portion of the image, and press the lower **Keystone** button to reduce the width of the lower portion.

adjust keystone



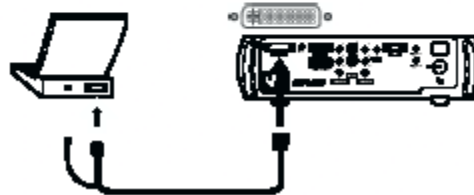
The **Contrast**, **Brightness**, **Color**, and **Tint** are factory calibrated to D65 colors, but you can adjust these settings in the Picture menu if necessary.



## Connecting to a computer

Connect either a VESA cable or M1 cable into the appropriate connector on the projector. Connect the other end to the video port on your computer. If you are using a desktop computer, you first need to disconnect the monitor cable from the computer's video port.

connect computer cable



You can control the projector from an LCD control panel or computer by connecting a RS-232 cable to the projector's **Serial** connector. Specific RS-232 commands can be found in the Appendix.

connect RS-232 cable



## Shutting down the projector

### Power Save

The projector has a Power Save feature in the System menu that automatically turns the lamp off after no signals are detected for 20 minutes. After 10 additional minutes with no signal, the projector powers down. If an active signal is received before the projector powers down, the image is displayed. You must press the **Power** button to display an image after 30 minutes have passed.

### Turning off the projector

To turn off the projector, press the **Power** button. The lamp turns off and the LED blinks green for about one minute while the fans continue to run to cool the lamp. When the lamp has cooled, the LED lights green and the fans stop. Unplug the power cable to completely power off the projector.

## Troubleshooting your setup

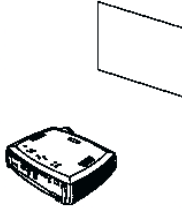
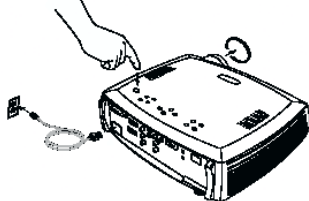
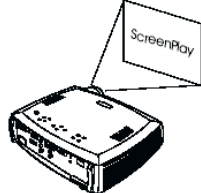
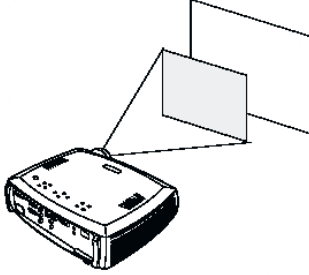

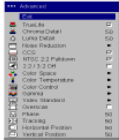
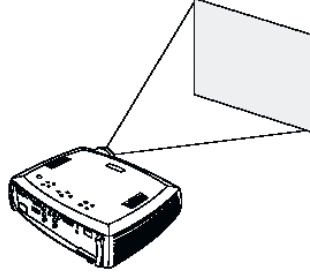

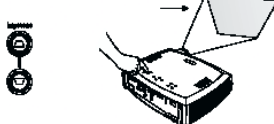

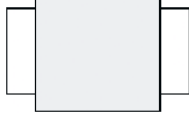
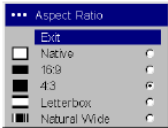


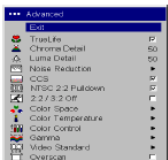


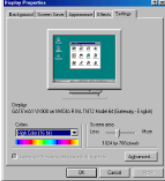

If your image appears correctly on the screen, skip to the next section. If it does not, troubleshoot the setup.


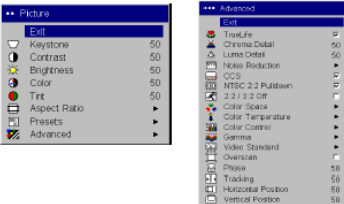

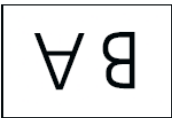
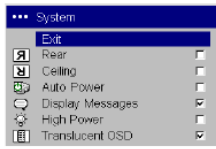







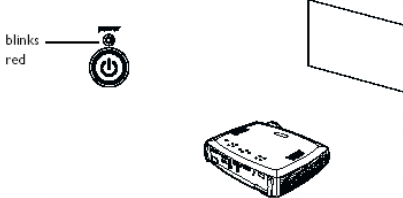
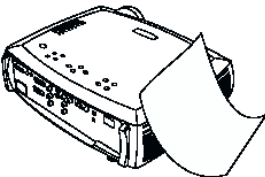
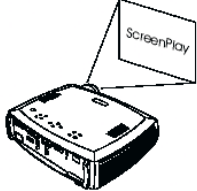
The LED on top of the projector's keypad indicates the state of the projector and can help you troubleshoot.

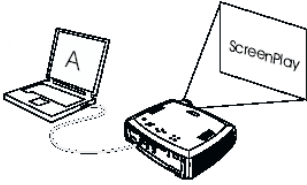

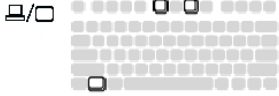
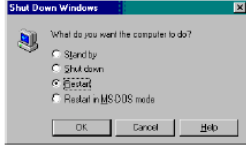
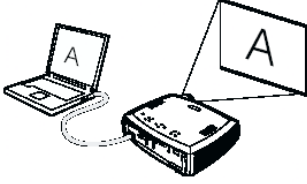
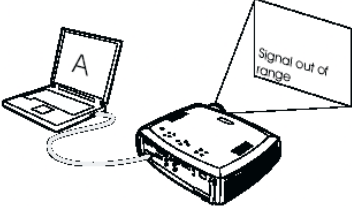

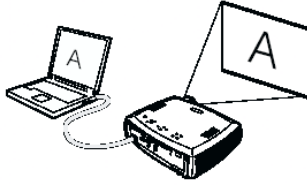
**Table 2: LED behavior and meaning**

LED color/behavior	Meaning
solid green	The projector is plugged in, or the projector has been turned on and the software has initialized. The projector has been turned off and the fans have stopped.
blinking green	The <b>Power</b> button has been pressed and the software is initializing, or the projector is powering down and the fans are running to cool the lamp.
blinking red The projector will not start up if the LED is blinking red. You must correct the problem, disconnect and reconnect the power cable, then power on the projector:  See page 34 for more information on blinking red LEDs.	A fan (blinks 4 times) or lamp (blinks 3 times) failure has occurred. Turn off the projector and wait one minute, then turn the projector on again. Also check for a blocked vent or a stopped fan (blinks 5 times).
solid red	An unidentifiable error: please contact Technical Support.

The following table shows some potential problems. In some cases, more than one possible solution is provided. Try the solutions in the order they are presented. When the problem is solved, you can skip the additional solutions.

Problem	Solution	Result
<p>No startup screen</p> 	<p>Plug power cable in and remove lens cap press Power button</p> 	<p>Correct image</p> 
<p>Image not centered on screen</p> 	<p>Move projector, adjust zoom, adjust height</p>  <p>Adjust horizontal or vertical position in Picture&gt;Advanced menu</p> 	<p>Correct image</p> 
<p>Image not square</p> 	<p>Adjust keystone on keypad</p> 	<p>Square image</p> 
<p>Image does not fit 16:9 screen</p> 	<p>Change aspect ratio to 16:9 in Picture&gt;Aspect ratio menu</p> 	<p>Correct image</p> 
<p>Edges of image distorted</p> 	<p>Turn Overscan on in the Picture&gt;Advanced menu</p> 	<p>Correct image</p> 
<p>Image fuzzy or cropped</p> 	<p>Set your computer's display resolution to the native resolution of the projector (Start&gt;Settings&gt;Control Panel&gt;Display&gt;Settings tab, select 1280x720)</p> <p>For a laptop, disable laptop monitor or turn-on dual- display mode</p> 	<p>Image clear and not cropped</p> 

<p>1. Projected colors don't match source 2. Colors are washed out or too deep 3. Image from component source appears greenish</p> 	<p>1. Adjust color, tint, color temperature, brightness, or contrast in the menus. 2. Pick another gamma setting 3. Pick another color space</p> 	<p>Correct image</p> 
<p>Image upside down</p> 	<p>Turn off Ceiling in Settings&gt;System menu</p> 	<p>Correct image</p> 
<p>Image reversed left to right</p> 	<p>Turn off Rear in Settings&gt;System menu</p> 	<p>Correct image</p> 
<p>Video image "torn" and fragmented</p> 	<p>Change Video Standard in Picture&gt;Advanced menu</p> 	<p>Correct image</p> 
<p>Lamp won't turn on, LED blinking red (page 11)</p> 	<p>Make sure vents aren't blocked; allow projector to cool for one minute</p> 	<p>Unplug projector; wait one minute; plug in projector and turn it on: lamp lights</p> 

Computer-specific troubleshooting		
<p>Only startup screen appears</p> 	<p>Press the Source button </p> <p>Activate laptop's external port</p>  <p>or restart laptop</p> 	<p>Computer image projected</p> 
<p>No computer image, just the words "Signal out of range"</p> 	<p>Adjust computer refresh rate in Control Panel&gt;Display&gt;Settings&gt;Advanced&gt;Adapter (location varies by operating system)</p> 	<p>Computer image projected</p> 

## Using the projector keypad buttons

Most buttons are described in detail in other sections, but here is an overview of their functions:

**Power**—turns the projector on and off.

**Menu**—opens the on-screen menus.

**Select**—confirms choices made in the menus.

**Up/down arrows**—navigates to and adjusts settings in the menus.

**Auto image**—resets the projector to the source.

**Presets**—cycles through the three available user preset settings.

**Keystone**—adjusts squareness of the image.

**Brightness**—adjusts intensity of the image.

**Resize**—changes the aspect ratio.

**Source**—changes the active source.



menu navigation buttons



## Using the remote control

The remote uses two (2) provided AAA batteries. They are easily installed by sliding the cover off the remote's back, aligning the + and - ends of the batteries, sliding them into place, and then replacing the cover.

To operate, point the remote at the projection screen or at the projector (not at the video device or computer). The range of optimum operation is 1 to 30 feet (9.14m).

Press the remote's **Menu** button to open the projector's menu system. Use the arrow buttons to navigate, and the **Select** button to select features and adjust values in the menus. The remote also has:

**Power** button to turn the projector on and off

**Backlight** button to light the remote's buttons in the dark

**Brightness** and **Contrast** buttons to adjust the image

**Blank** button to display a blank screen instead of the current image (to change the color of the screen)

**Source** buttons to switch among sources and a source toggle

**Resize** button to change the Aspect Ratio

**Auto Image** button to resynch the projector to the source

**Preset** button to restore stored settings

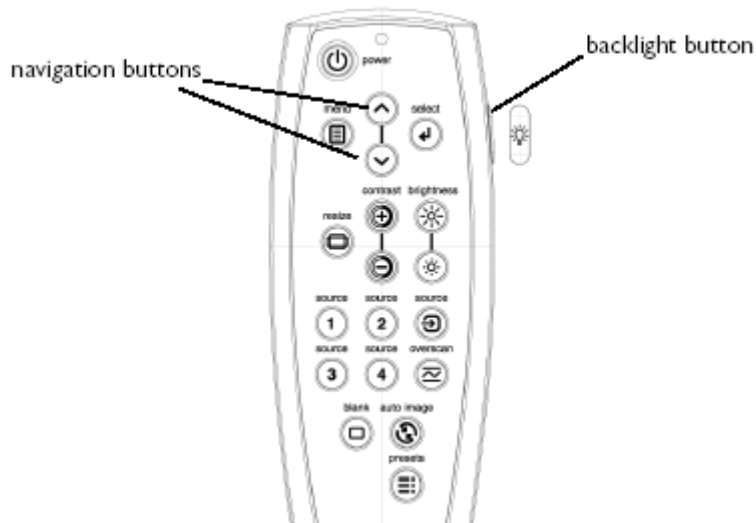
**Overscan** button to remove noise in a video image

## Troubleshooting the remote

Make sure the batteries are installed in the proper orientation and are not dead.

Try installing fresh alkaline batteries.

Make sure you're pointing the remote at the projector or the screen, not at the video device or the computer, and are within the remote range of 30 feet (9.14m).



## Optimizing video images

After the video device is connected properly and the image is on the screen, you can optimize the image using the onscreen menus.

Change the Aspect ratio. Aspect ratio is the ratio of the image width to image height. TV screens are usually 1.33:1, also known as 4:3. HDTV and most DVDs are 1.78:1, or 16:9. Choose the option that best fits your input source in the menus, or press the **Resize** button on the remote to cycle through the options.

Adjust the Keystone, Contrast, Brightness, Color, or Tint in the Picture menu.

Select a different Color Temperature or use the Color Control to adjust the gain and offset of the red, green, and blue color.

Select a specific Color Space or Gamma.

Select a different Video Standard. Auto tries to determine the standard of the incoming video. Select a different standard if necessary.

Turn overscan on to remove noise around the video image.

Fine tune component inputs using the TrueLife™ adjustments.

Choose High Power to maximize the light output.

Make sure your DVD player is set for a 16:9 television. See your DVD player's user's guide for instructions.

## Customizing the projector

You can customize the projector for your specific setup and needs.

For rear projection, turn Rear mode on in the **Settings>System** menu.

For ceiling mounted projection, turn Ceiling mode on in the **Settings>System** menu.

Turn the projector's display messages and power-on chime on and off.

Turn on power saving features.

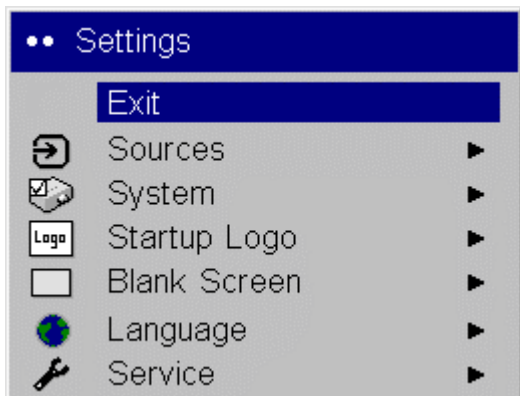
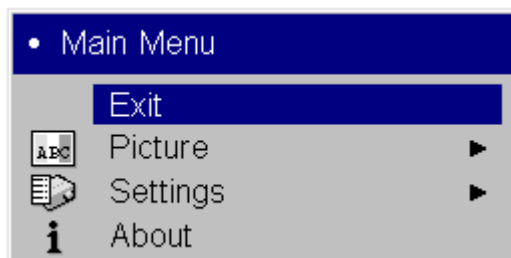
Specify blank screen colors and startup logos. Make the menus translucent.

Specify the menu language.

## Using the menus

To open the menus, press the menu button on the keypad or remote. (The menus automatically close after 60 seconds if no buttons are pressed.) The **Main** menu appears. Use the arrow buttons to move up and down to highlight the desired submenu, then press the **Select** button.

To change a menu setting, highlight it, press **Select**, then use the up and down arrow buttons to adjust the value, select an option using radio buttons, or turn the feature on or off using check boxes. Press **Select** to confirm your changes. Use the arrows to navigate to another setting. When your adjustments are complete, navigate to **Exit**, then press **Select** to go to the previous menu; press the **Menu** button at any time to close the menus.



Dots appear before the menu name. The number of dots indicate the menu's level, ranging from one (the Main menu) to four (the most nested menus).

The menus are grouped by usage:

The Picture menu provides image adjustments.

The Settings menu provides set-up type adjustments that are not changed often.

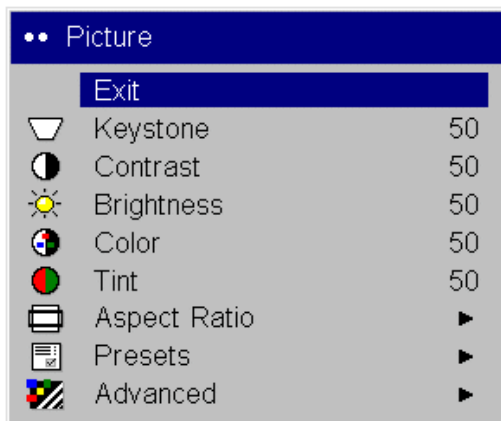
About	
Lamp Hours Used	1980
Active Source	Video 1
Signal Format	1024x768 @ 72Hz
Version	2.1

The About menu provides a read-only display of information about the projector and source.

Certain menu items may be hidden until a particular source is connected. For example, Tint is only available for NTSC video sources and will be hidden when other sources are active. Other

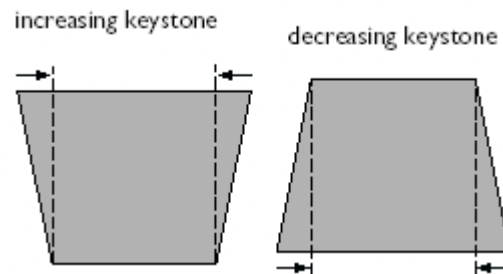
menu items may be grayed out when they are not available. For example, Brightness is grayed out until an image is active.

### Picture menu



To adjust the following five settings, highlight the setting, press **Select**, use the up and down arrows to adjust the values, then press select to confirm the changes.

**Keystone:** adjusts the image vertically and makes a squarer image. You can also adjust keystone from the keypad.



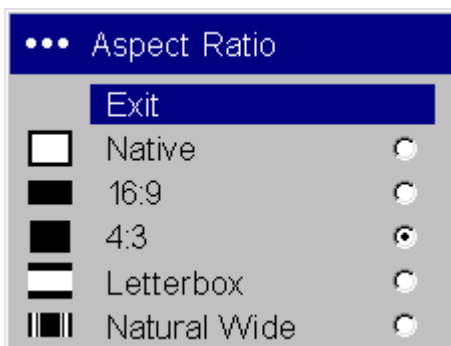
**Contrast:** controls the degree of difference

between the lightest and darkest parts of the picture and changes the amount of black and white in the image.

**Brightness:** changes the intensity of the image. You can also adjust brightness from the keypad.

**Color:** (video sources only) adjusts a video image from black and white to fully saturated color.

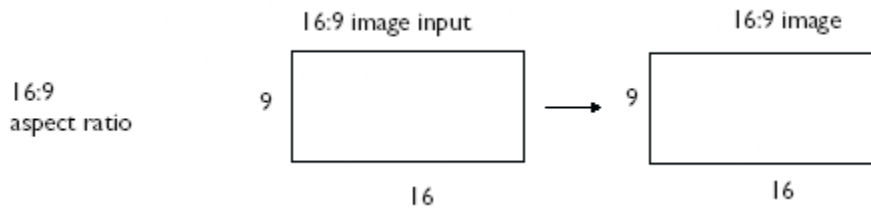
**Tint:** (NTSC video sources only) adjusts the red-green color balance in the image.



**Aspect Ratio:** Aspect ratio is the ratio of the image width to image height. TV screens are usually 1.33:1, also known as 4:3. HDTV and most DVDs are 1.78:1, or 16:9. You can choose Native, 4:3, 16:9, Letterbox, or Natural Wide. The default is 16:9. The goal is to show the most detail on the screen while preserving the ratio of width to height. The native resolution of the projector is 1280x720. Use Native, 4:3 or Natural Wide for 4:3 input sources; use Native, 16:9 or Letterbox for 16:9 input. Pressing the **Resize** button on the remote cycles through these options.

**Native:** this mode bypasses the internal scaler, displaying the image with no resizing. Since the native resolution is 1280x720 and 4x3 video images are approximately 640x480, 4x3 images will always be smaller than the display and will be centered in the display. Computer images 1024x768 or smaller will also be centered in the display. If a 16x9 video source or a 1280x1024 or larger computer source is viewed, it will display up to 1280 pixels and 720 lines from the center of the input.

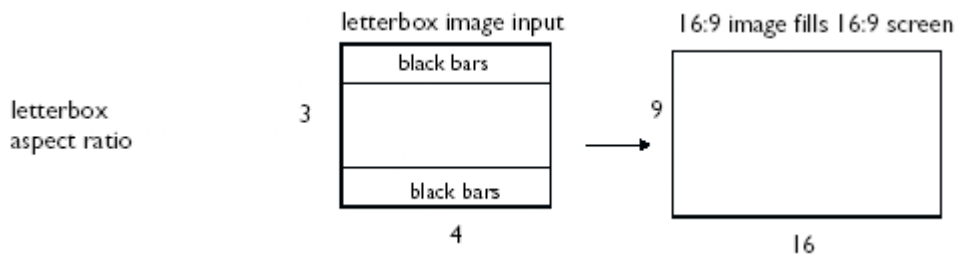
**16:9:** the default is **16:9**, which preserves the 16:9 aspect ratio and is designed to be used with content that is Enhanced for Widescreen TVs.



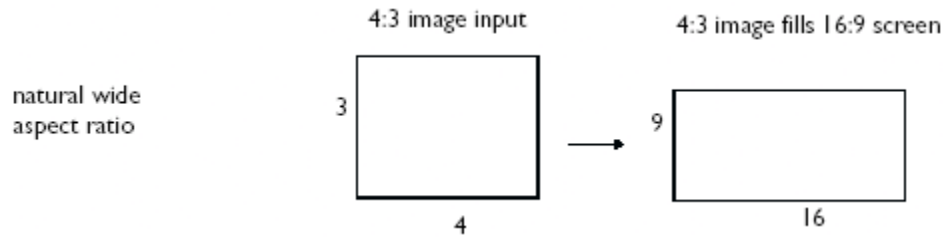
**4:3:** resizes the image from its original version to fit a standard 4:3 aspect ratio screen. If you have a 4:3 source on a 16:9 screen, the image is placed in a 16:9 space, so black bars appear at the sides of the image.



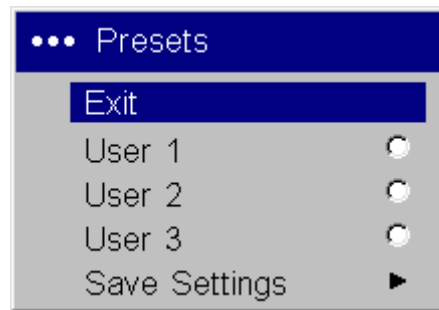
**Letterbox:** preserves the 16:9 aspect ratio. If you have a 16:9 source and screen, the image fills the screen. If your source is letterboxed, the image expanded to fill the screen.



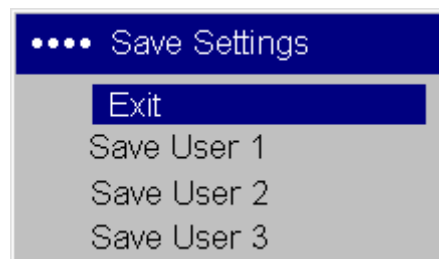
**Natural Wide:** this mode stretches a 4:3 image to fill the entire 16:9 screen. The center two-thirds of the image is unchanged; the edges of the image are stretched.



**Presets:** This allows you to customize settings and save the settings to be restored later. To restore the factory default settings, choose Factory Reset in the **Settings>Service** menu.



To set a preset for the current source, adjust the image, select **Save Settings** in the Presets menu, then choose Save User 1, 2, or 3. You can recall these settings in the future by selecting the appropriate user presets.



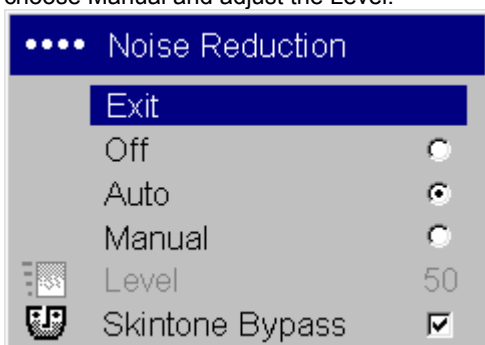
## Advanced settings

**TrueLife:** This option refers to Faroudja's TrueLife processing of the image. All standard definition interlaced video signals (composite, S-video and component) are routed through this processor. Extended and High Definition progressive component sources are not routed through this processor by default. You can turn TrueLife on to route these signals through the processor and then adjust the following 2 options:

**Chroma Detail:** This adjusts the color sharpness.

**Luma Detail:** This adjusts the sharpness.

**Noise Reduction:** adjusts signal noise reduction. Choose Off to have no noise reduction, choose Auto to have the software determine the amount of noise reduction, or choose Manual and adjust the Level.



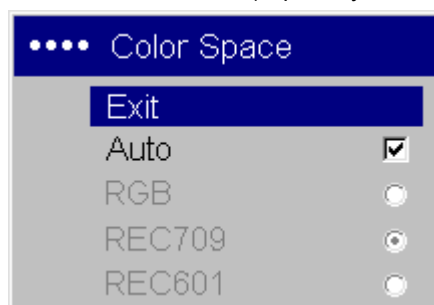
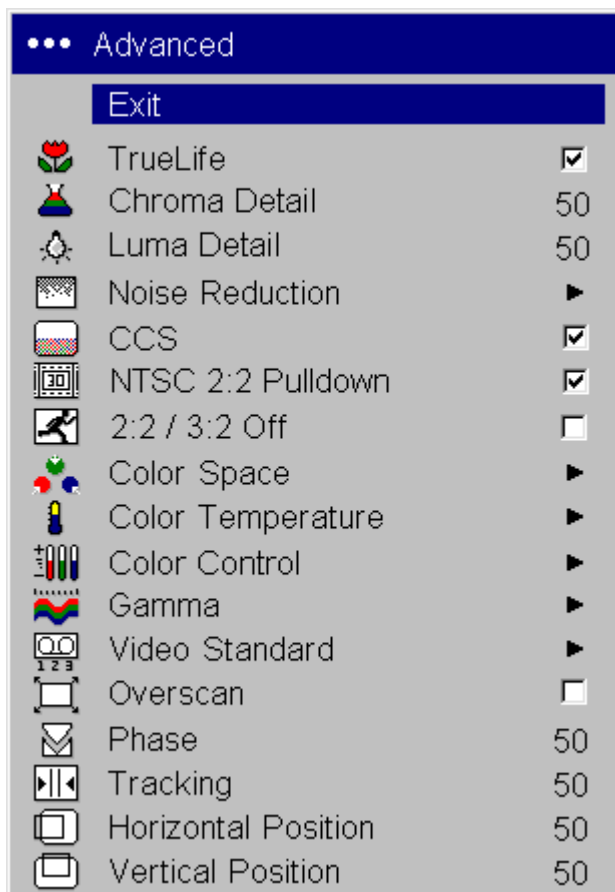
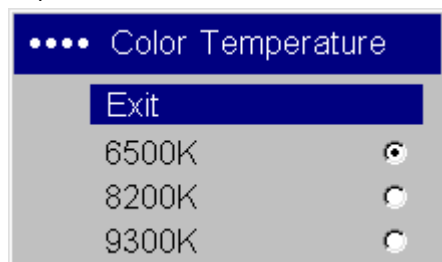
**Skintone Bypass** prevents the noise reduction processing from being applied to skin tones. Images of people often look better with less processing. Available when Auto or Manual are selected.

**CCS:** (Cross Color Suppression) processes the signal to remove any color information from the luma portion of the signal. It is On for all composite signals, Off for all component signals, and can be turned on or off for all S-video signals.

**NTSC 2:2 Pulldown:** Turn this feature on to correctly display NTSC signals created from 30-frames/second-source material (instead of the film standard 24 frames/ second).

**2:2/3:2 Off:** Turn this feature on to turn off film mode detection. Some video material (especially film animation) is difficult to distinguish from film.

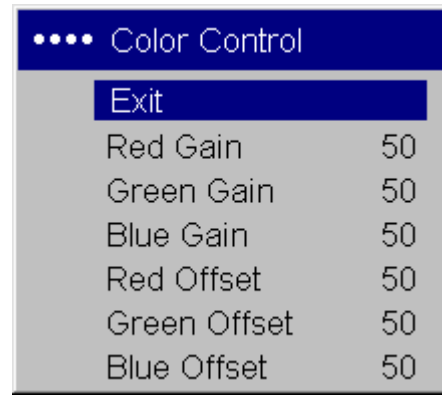
**Color Space:** This option applies to computer and HDTV sources (it won't appear in the menu for video sources). It allows you to select a color space that has been specifically tuned for the video input. When Auto is selected, the projector automatically determines the standard. To choose a different setting, turn off Auto, then choose RGB for computer sources, choose REC709 for component 1080i or 720p sources, or choose REC601 for component 480p or 576p sources.



**Color Temperature:** changes the intensity of the colors. Select a listed value.

**Color Control:** allows you to individually adjust the gain (relative warmth of the color) and the offset (the amount of black in the color) of the red, green, and blue colors.

**Gamma:** Gamma tables contain preset intensity configurations optimized for the input source. You can select a gamma table that has been specifically tuned for either film, video, Bright Room, or PC input. (Film input is material originally captured on a film camera, like a movie; video input is material originally captured on a video camera, like a TV show or sporting event.)



**NOTE:** Your viewing preferences may vary. Cycle through the gamma options and pick the one you like the best.

**Video Standard:** When it is set to Auto, the projector attempts to pick the video standard automatically based on the input signal it receives. (The video standard options may vary depending on your region of the world.) If the projector is unable to detect the correct standard, the colors may not look right or the image may appear “torn.” If this happens, manually select a video standard by selecting NTSC, PAL, or SECAM from the Video Standard menu.



**Overscan:** (video sources only) removes noise around the video image.

**The following options are for computer or HDTV sources only**

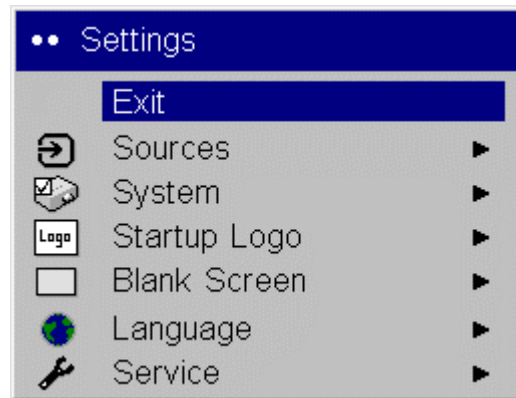
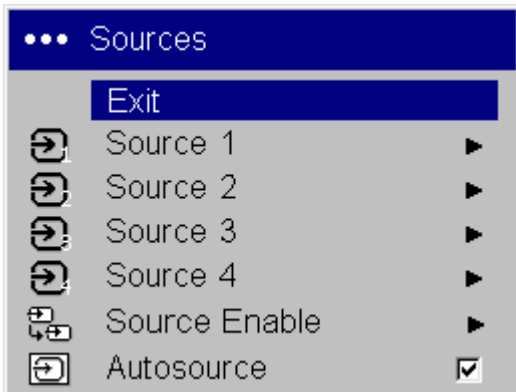
**Phase:** adjusts the phase of the video signal’s digital conversion.

**Tracking:** adjusts the frequency of the video signal’s digital conversion.

**Horizontal/Vertical Position:** adjusts the position of the source.

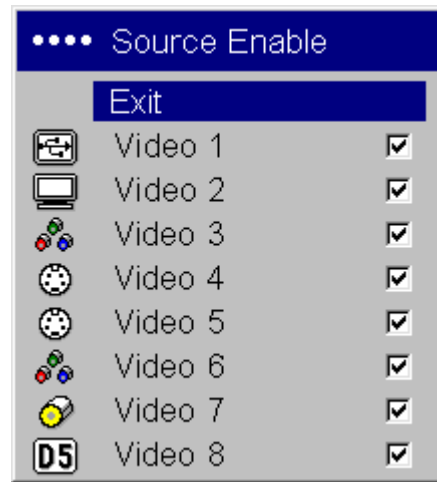
**Settings menu**

**Sources:** allows you to assign a particular input to a specific source key on the remote and enables or disables Autosource. When Autosource is not checked, the projector defaults to the last-used source. If no source is found, a blank screen displays. When Autosource is checked, the projector checks



the last-used source first at power up. If no signal is present, the projector checks the sources in order until a source is found or until power down.

The Source Enable feature is used to eliminate certain sources from this search, which will speed the search. By default, the check boxes for all sources are checked. Uncheck a source's box to eliminate it from the search.

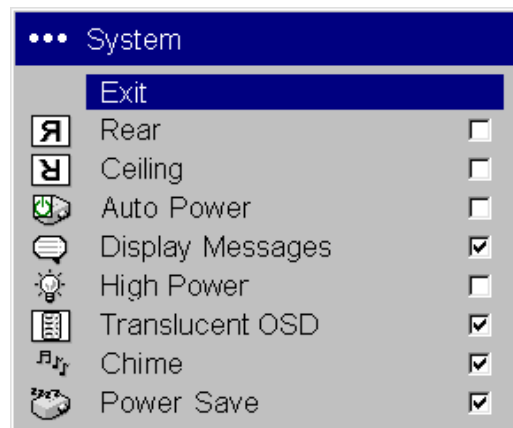


### System

All options in this menu toggle between on and off.

**Rear:** reverses the image so you can project from behind a translucent screen.

**Ceiling:** turns the image upside down for ceiling-mounted projection.



**NOTE:** It is recommended that all final image adjustments in Ceiling mode are made once the unit has fully warmed up (approximately 20 minutes).

**Auto Power:** When Auto Power is checked, the projector automatically goes into the startup state after the projector receives power. This allows control of ceiling mounted projectors with a wall power switch.

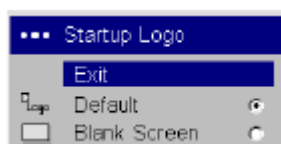
**Display Messages:** displays status messages (such as "Searching") in the lower-left corner of the screen.

**High Power:** Turn this on to increase the light output of the lamp. This also shortens lamp life and increases fan noise.

**Translucent OSD:** makes the menus translucent. This prevents the image from being completely covered by the menus while you are making image adjustments.

**Chime:** turn this on to hear a sound when the **Power** button is pressed.

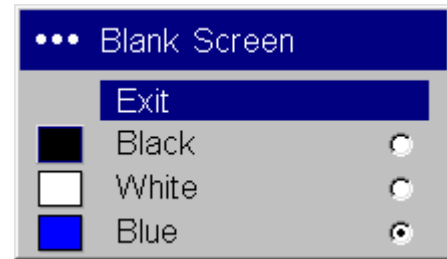
**Power Save:** when On, the lamp is automatically turned off after no signals are detected for 20 minutes. After 10 additional minutes with no signal, the projector powers down. If an active signal is received before the projector powers down, the image will be displayed.



**Startup Logo:** allows you to display a blank Black, White, or Blue screen instead of the default screen at startup and when no source is detected.



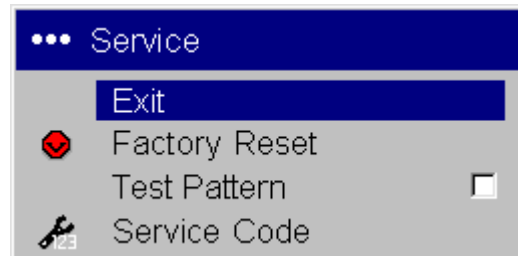
**Blank Screen:** determines what color displays when you press the **Blank** button on the remote or when no source is active.



**Language:** allows you to select a language for the onscreen display of menus and messages.

### Service Menu

Use these features, highlight them and press **Select**.



**Factory Reset:** restores all settings (except Lamp Hours, Ceiling, and Rear) to their default after displaying a confirmation dialog box.

**Test Pattern:** displays a test pattern when the **Blank** button on the remote is pressed. To select the patterns, use the up/down arrows on the remote or keypad.

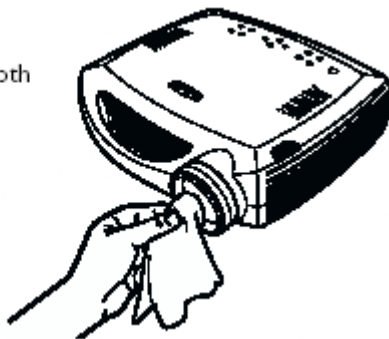
**Service Code:** only used by authorized service personnel.

## Maintenance

### Cleaning the lens

Apply a non-abrasive camera lens cleaner to a soft, dry cloth.

clean the lens  
with a soft dry cloth  
and non-abrasive  
cleaner



Avoid using an excessive amount of cleaner, and don't apply the cleaner directly to the lens.

Abrasive cleaners, solvents or other harsh chemicals might scratch the lens.

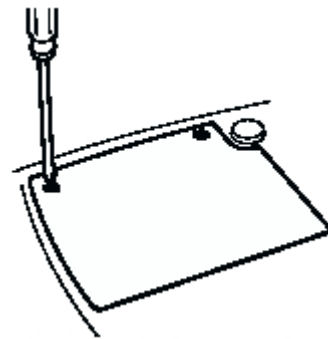
Lightly wipe the cleaning cloth over the lens in a circular motion. If you don't intend to use the projector immediately, replace the lens cap.

## Replacing the projection lamp

The lamp hour timer in the **About** menu counts the number of hours the lamp has been in use. After 1980 hours, the message “Change lamp” briefly appears on the screen at each startup. To maintain optimal video performance, we recommend changing the lamp after 2000 hours, depending on usage. You can order new lamp modules from your dealer.

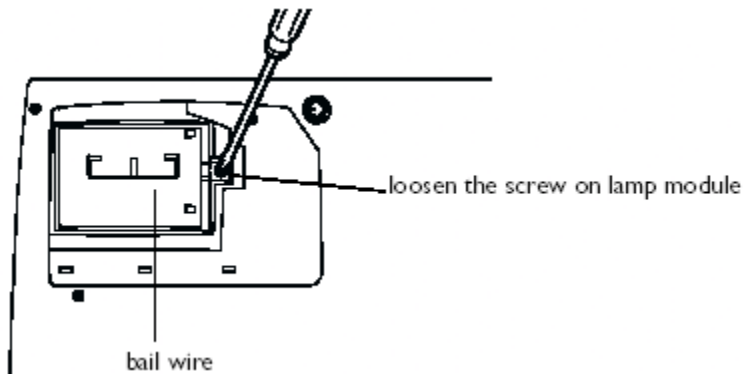
About	
Lamp Hours Used	1980
Active Source	Video 1
Signal Format	1024x768 @ 72Hz
Version	2.1

1. Turn off the projector and unplug the power cable.
2. Wait 60 minutes to allow the projector to cool thoroughly.
3. Turn the projector upside down and remove the lamp door by removing the two screws and sliding the lamp door tabs out of the three tab bays.



**CAUTION:** Never operate the projector with the lamp door removed. This disrupts the airflow and causes the projector to overheat.

4. Loosen the captive screw on the lamp module.



### WARNINGS:

To avoid burns, allow the projector to cool for at least 60 minutes before you replace the lamp.

*Do not drop the lamp module. The glass may shatter and cause injury.*

*Do not touch the glass lamp screen. Fingerprints can obscure projection sharpness.*

*Be extremely careful when removing the lamp module. In the unlikely event that the lamp ruptures, small glass fragments may be generated. The lamp module is designed to contain most of these fragments, but use caution when removing it.*

5. Carefully remove the lamp module by grasping and lifting the metal bail wire. Dispose of the lamp in an environmentally proper manner.
6. Install the new lamp module. Make sure that it is properly seated.

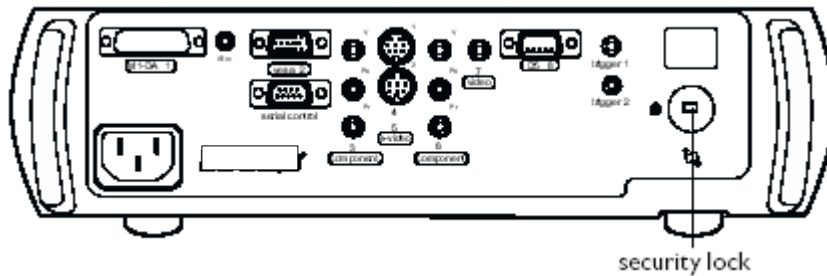
7. Tighten the single screw.
8. Replace the lamp door by sliding the tabs into the tab bays and tightening the two screws.
9. Plug in the power cable, then press the **Power** button to turn the projector back on.
10. Reset the lamp hour timer.

### Resetting the lamp timer

To reset the lamp age, simultaneously holding down the two **Brightness** buttons on the projector's keypad for 10 seconds.

### Using the security lock

The projector has a security lock for use with a PC Guardian Cable Lock System. This lock needs to be order from Knöll Systems. Refer to the information that comes with the lock for instructions on how to use it.



## Specifications

<b>Temperature</b> Operating	50 to 95° F (10 to 35° C) at 0 - 10,000 feet
Non-operating	-4 to 158° F (-20 to 70° C) at 0 -20,000 feet
<b>Altitude</b> Operating	0 to 10,000 feet (3,048 meters)
Non-operating	0 to 20,000 feet (6,096 meters)
<b>Humidity</b> Operating	10 percent to 95 percent relative humidity, non-condensing
Non-operating	10 percent to 95 percent relative humidity, non-condensing
Dimensions	13.8 x 12.8 x 4.3" (351W x 325L x 110H mm)
Weight	9.3 lbs. (4.24 kg) unpacked
Optics Focus Range	5 - 32.8 feet (1.5 – 10 meters)
Lamp Type	UHP lamp (dual watt: 200 and 250 watt) Model SP-Lamp-006
Input power requirements	100V-120V 4A 50/60 Hz 200V-240V 2A 50Hz

## Red LED behavior and projector errors

If the projector is not functioning properly and the red LED is blinking, consult the table below to determine a possible cause. There are two-second pauses between the blinking cycles.

Red LED Behavior	Explanation
One (1) blink	The lamp won't strike after five (5) attempts. Check the lamp and lamp door installations for loose connections.
Three (3) blinks	The projector has shut down the lamp. Turn off the projector, wait one minute, then turn it back on. Replace the lamp. Contact Technical Support for repair if replacing the lamp does not solve the problem.
Four (4) blinks	The fan has failed. Replace the lamp (the lamp module contains a fan). Contact Technical Support for repair if replacing the fan does not solve the problem.
Five (5) blinks	The projector is overheating. Check for a blocked air vent. Contact Technical Support for repair if clearing the air vents does not solve the problem.

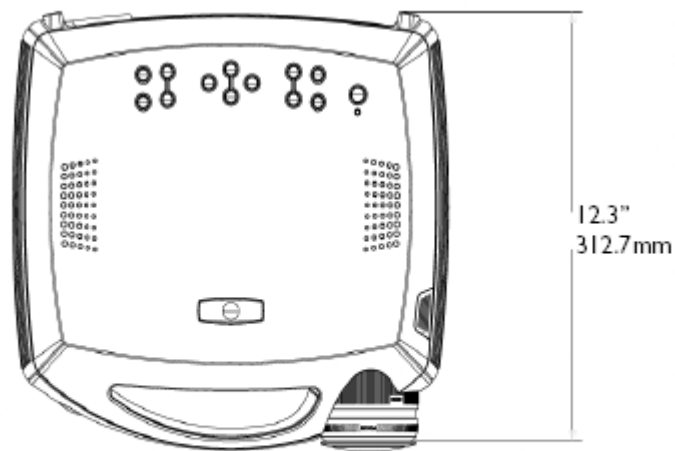
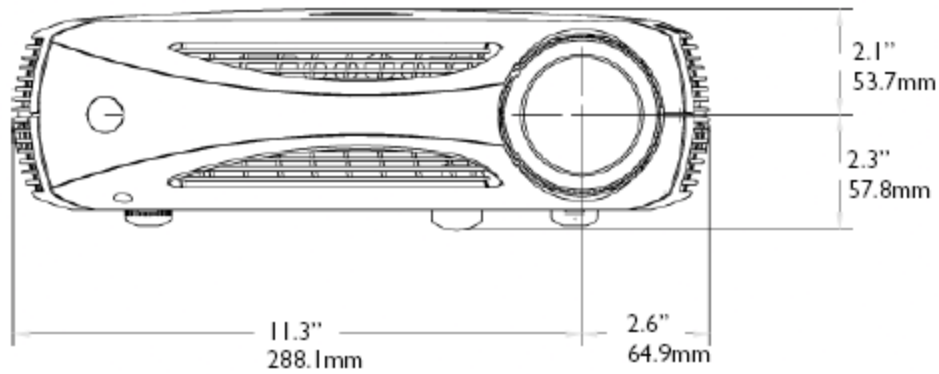
### Source Compatibility

Video	Component and RGB HDTV (720p, 1035i, 1080p, 1080p-24Hz) DVI/HDCP for digital video and encrypted digital video Component EDTV (480p, 576p progressive scan), SECAM: M, Component, Composite and S-Video standard video (480i, 576i, 576i RGB SCART with adapter, NTSC, NTSC M 4.43, PAL: B, H, I, M, N)
Computer	Digital and analog PC, Macintosh, 1280x1024 resolution
Communication	USB and RS-232

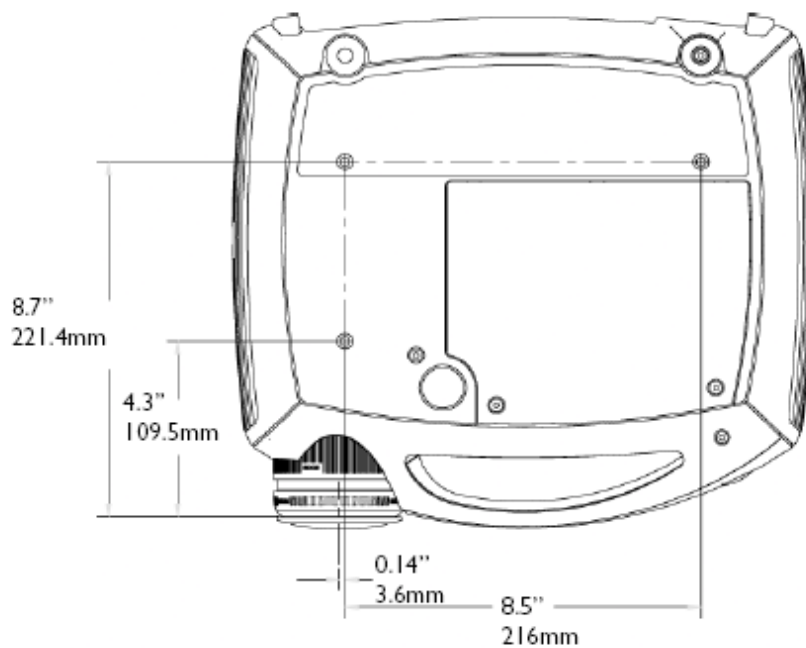
### Projector Inputs and Outputs

2-Component (Gold RCA)	HDTV, EDTV, and Standard TV component
1-Component (D5)	HDTV, EDTV, Standard TV, RGB SCART with adapter
2-S-Video	Standard Video
1-Composite (RCA)	Standard Video
1-MI-DA VESA	HDTV RGB, HDTV component, DVI, computer, and USB
1-HDI5 VESA	HDTV RGB, HDTV component, computer
1-9-pin Dsub male	RS-232
1-3.5 mm mini jack	IR Repeater (Niles/Xantech compatible)
2-3.5 mm mini jack	1-12v screen drop, 1-12v 4:3 aspect "curtains"

## Projector dimensions for ceiling mount installations



dimensions of optional cable cover: 12.4 x 3.9 x 3.2" (315 x 100 x 82mm)  
 total length with optional cable cover: 16.2" (411.5mm)



## RS232 Terminal Specifications and Commands

To control the projector from an LCD control panel, connect an RS-232 cable to the serial control connector on the projector and set your computer's serial port settings to match this communication configuration:

Setting	Value
Bits per second	19,200
Data bits	8
Parity	None
Stop bits	1
Flow control	None
Emulation	VT100

### Command format

All commands consist of 3 alpha characters followed by a request, all enclosed in parentheses. The request can be a read request (indicated by a "?") or a write request (indicated by 1 to 4 ASCII digits).

A read request format: (AAA?) where

- ( starts the command
- AAA denotes the command
- ? denotes the read request
- ) ends the command

A read command returns the range and the current setting, for example:

Function	Command	Response
Brightness	(BRT?)	(0-22, 10)
Lamp hours	(LMP?)	(0-9999, 421)

A write request example: (AAA####) where

- ( starts the command
- AAA denotes the command
- #### denotes the value to be written (leading zeros not necessary)
- ) ends the command

Some commands have ranges, while others are absolute. If a number greater than the maximum range is received, it is automatically set to the maximum number for that function. If a command is received that is not understood, a "?" is

returned. With absolute settings, "0" is off, 1-9999 is on.

The one exception is the Power command, where 0 is off and 1 is on.

Function	Command	Response
Brightness	(BRT10)	Sets the brightness to 10
Power	(PWR0)	Turns power off
Power	(PWR1)	Turns power on
Power	(PWR9999)	?

## Supported commands

---

Function	Command	Range	Default
Aspect Ratio	ARZ	0-4 0 = Native 1 = 16:9 2 = 4:3 3 = Letterbox 4 = Natural Wide	1
Auto Chime Enable	ACE	0-1	1
Auto Power	APO	0-1	0
Auto Source	ASC	0-1	0
Blank	BLK	0-1	0
Blank Screen	BSC	0-2 0 = black 1 = blue 2 = white	0
Blue Color Offset	BCO	1-63	32
Blue Gain	BCG	1-63	32
Brightness	BRT	2-254	128
Ceiling	CEL	0-1	0
Chroma Detail	CDE	0-20	0
Color	CLR	2-254	128
Color Space	CSM	0-7 0 = RGB 3 = REC601 2 = REC709 7 = Auto	7
Color Temp	TMP	0-2 0 = 9300 1 = 8200 2 = 6500	2
Contrast	CON	4-252	128
CCS	CCS	0-1	0
Display Messages	DMG	0-1	1
Factory Reset (Write only)	RST	0-1	n/a
Gamma Table	GTB	0-5 0 = CRT 1 = Film 2 = Video 3 = Bright Room 1 4 = Bright Room 2 5 = PC	3
Green Color Offset	GCO	1-63	32



Green Gain	GCG	1-63	32
High Power Enable	HPE	0-1	0
Horizontal Position	HPS	n/a	n/a
Keystone (Vertical)	DKC	53-203	128
Keystone (Horizontal)	DKH	63-193	128
Lamp Hours (Read only)	LMP	0-32767	0
Lamp Reset	LMR	0-32767	0
Luma Detail	LDE	0-20	0
Menu	MNU	0-1	0
Menu Navigation	NAV	0-4 0 = up 1 = down 4 = select	n/a
Language	LAN	0-11 0 = English 1 = French 2 = German 3 = Spanish 4 = Chinese Traditional 5 = Japanese 6 = Korean 7 = Portuguese 8 = Russian 9 = Norwegian 10 = Chinese Simplified 11 = Italian	0
NTSC 2:2 Pulldown Enable	NPE	0-1	0
Noise Reduction Enable	NRE	0-2 0 = Off 1 = Auto 2 = Manual	0
Noise Reduction Level	NRL	0-10	5
Overscan	OVS	127 = Crop 128 = Off 129 = Zoom	128
Phase	MSS	0-31	n/a
Power	PWR	0-1	0
Power Save	PSV	0-1	1
Presets	PST	0-2 0 = User 1 1 = User 2 2 = User 3	0
Rear Project	REA	0-1	0
Red Color Offset	RCO	1-63	32

Red Gain	RCG	1-63	32
Skintone Bypass Enable	SBE	0-1	0
Source	SRC	0-7 0 = Video 1, MI 1 = Video 2, VESA 2 = Video 3, Component 1 3 = Video 4, S-Video 1 4 = Video 5, S-Video 2 5 = Video 6, Component 2 6 = Video 7, Composite 7 = Video 8, D5	2
Startup Logo	DSU	0-1	1
Tint	TNT	2-254	128
Tracking	MTS	n/a	n/a
Translucent OSD	TOE	0-1	1
TrueLife Enable	TLE	0-1	0
Vertical Position	VPS	n/a	n/a
Video Standard	VSU	0-3 0 = Auto 1 = NTSC 2 = PAL 3 = SECAM	0

---

## **LIMITED WARRANTY**

Knöll Systems, Inc. ("Knöll") warrants that each HD282 ("the Product") sold hereunder will conform to and function in accordance with the written specifications of Knöll. Said limited warranty shall apply only to the first person or entity that purchases the Product for personal or business use and not for the purpose of distribution or resale. Said warranty shall continue for a period of two (2) years from the date of such purchase. The standard limited warranty excludes the lamps in projectors after 90 days or 500 hours and the accessories after one year. Knöll does not warrant that the Product will meet the specific requirements of the first person or entity that purchases the Product for personal or business use. Knöll' liability for the breach of the foregoing limited warranty is limited to the repair or replacement of the Product or refund of the purchase price of the Product, at Knöll' sole option. Replacement Product may be re-furbished in "like-new" condition, at Knöll' sole discretion. To exercise the Purchaser's rights under the foregoing warranty, the Product must be returned at the Purchaser's sole cost and expense, to Knöll or to any authorized Knöll service center provided, and the Product must be accompanied by a written letter explaining the problem and which includes (i) proof of date of purchase; (ii) the dealer's name; and (iii) the model and serial number of the Product. When sending your unit in for repair, please ship your unit in its original packing material or a Knöll approved ATA Shipping Case, or have a professional packaging company pack the unit. Please insure your shipment for its full value. A return authorization number, issued by the Knöll customer service department, must also be clearly displayed on the outside of the shipping carton containing the Product.

Note: Remanufactured Products are exempt from the foregoing Limited Warranty. Please refer to the Remanufactured Product Warranty for applicable warranty information.

### **WARRANTY LIMITATION AND EXCLUSION**

Knöll shall have no further obligation under the foregoing limited warranty if the Product has been damaged due to abuse, misuse, neglect, accident, unusual physical or electrical stress, unauthorized modifications, tampering, alterations, or service other than by Knöll or its authorized agents, causes other than from ordinary use or failure to properly use the Product in the application for which said Product is intended.

### **DISCLAIMER OF UNSTATED WARRANTIES**

THE WARRANTY PRINTED ABOVE IS THE ONLY WARRANTY APPLICABLE TO THIS PURCHASE. ALL OTHER WARRANTIES, EXPRESS OR IMPLIED, INCLUDING, BUT NOT LIMITED TO, THE IMPLIED WARRANTIES OF MERCHANTABILITY AND FITNESS FOR A PARTICULAR PURPOSE ARE DISCLAIMED. THERE ARE NO WARRANTIES THAT EXTEND BEYOND THE FACE HEREOF AND THE FOREGOING WARRANTY SHALL NOT BE EXTENDED, ALTERED OR VARIED EXCEPT BY WRITTEN INSTRUMENT SIGNED BY KNÖLL. SOME STATES DO NOT ALLOW LIMITATIONS ON HOW LONG AN IMPLIED WARRANTY MAY LAST, SO SUCH LIMITATIONS MAY NOT APPLY TO YOU.

### **LIMITATION OF LIABILITY**

IT IS UNDERSTOOD AND AGREED THAT KNÖLL' LIABILITY WHETHER IN CONTRACT, IN TORT, UNDER ANY WARRANTY, IN NEGLIGENCE OR OTHERWISE SHALL NOT EXCEED THE RETURN OF THE AMOUNT OF THE PURCHASE PRICE PAID BY PURCHASER AND UNDER NO CIRCUMSTANCES SHALL KNÖLL BE LIABLE FOR SPECIAL, INDIRECT, INCIDENTAL OR CONSEQUENTIAL DAMAGES OR LOST PROFITS, LOST REVENUES OR LOST SAVINGS. THE PRICE STATED FOR THE PRODUCT IS A CONSIDERATION IN LIMITING KNÖLL' LIABILITY. NO ACTION, REGARDLESS OF FORM, ARISING OUT OF THE AGREEMENT TO PURCHASE THE PRODUCT MAY BE BROUGHT BY PURCHASER MORE THAN ONE YEAR AFTER THE CAUSE OF ACTION HAS ACCRUED. SOME STATES DO NOT ALLOW THE EXCLUSION OR LIMITATION OF INCIDENTAL OR CONSEQUENTIAL DAMAGES SO THE ABOVE LIMITATION OR EXCLUSION MAY NOT APPLY TO YOU. THIS LIMITED WARRANTY GIVES YOU SPECIFIC LEGAL RIGHTS, AND YOU MAY ALSO HAVE OTHER RIGHT WHICH VARIES FROM STATE TO STATE.