

JVC®

HD-ILA™
Powered by **D-ILA**

Projection Television Users Guide

For Models:
HD-52G787
HD-56G787
HD-61G787
HD-52G887
HD-56G887
HD-61G887
HD-70G887



Illustration of HD-52G887 and RM-C18G

Important Note:





In the spaces below, enter the model and serial number of your television (located at the rear of the television cabinet). Staple your sales receipt or invoice to the inside cover of this guide. Keep this user's guide in a convenient place for future reference. Keep the carton and original packaging for future use.

Model Number: _____

Serial Number: _____

LCT2063-001D-A
1206TNH-II-IM

Important Safety Precautions

	CAUTION RISK OF ELECTRIC SHOCK DO NOT OPEN	
CAUTION: To reduce the risk of electric shock. Do not remove cover (or back). No user serviceable parts inside. Refer servicing to qualified service personnel.		
	The lightning flash with arrowhead symbol, within an equilateral triangle is intended to alert the user to the presence of uninsulated "dangerous voltage" within the product's enclosure that may be of sufficient magnitude to constitute a risk of electric shock to persons.	
	The exclamation point within an equilateral triangle is intended to alert the user to the presence of important operating and maintenance (servicing) instructions in the literature accompanying the appliance.	

WARNING: TO PREVENT FIRE OR SHOCK HAZARDS, DO NOT EXPOSE THIS TV SET TO RAIN OR MOISTURE.

CAUTION: TO INSURE PERSONAL SAFETY, OBSERVE THE FOLLOWING RULES REGARDING THE USE OF THIS UNIT.

1. Operate only from the power source specified on the unit.
2. Avoid damaging the AC plug and power cord.
3. Avoid Improper installation and never position the unit where good ventilation is unattainable.
4. Do not allow objects or liquid into the cabinet openings.
5. In the event of trouble, unplug the unit and call a service technician. Do not attempt to repair it yourself or remove the rear cover.

Changes or modifications not approved by JVC could void the warranty.

- * When you don't use this TV set for a long period of time, be sure to disconnect both the power plug from the AC outlet and antenna for your safety.
- * To prevent electric shock do not use this polarized plug with an extension cord, receptacle or other outlet unless the blades can be fully inserted to prevent blade exposure.

NOTICE (for USA)



This product has a High Intensity Discharge (HID) lamp that contains a small amount of mercury. It also contains lead in some components. Disposal of these materials may be regulated in your community due to environmental considerations. For disposal or recycling information, please contact your local authorities, or the Electronics Industries Alliance: <http://www.eiae.org>



- As an “ENERGY STAR®” partner, JVC has determined that this product or product model meets the “ENERGY STAR®” guidelines for energy efficiency.

IMPORTANT SAFETY INSTRUCTIONS

- 1) Read these instructions.
- 2) Keep these instructions.
- 3) Heed all warnings.
- 4) Follow all instructions.
- 5) Do not use this apparatus near water.
- 6) Clean only with dry cloth.
- 7) Do not block any ventilation openings. Install in accordance with the manufacturer's instructions.
- 8) Do not install near any heat sources such as radiators, heat registers, stoves, or other apparatus (including amplifiers) that produce heat.
- 9) Do not defeat the safety purpose of the polarized or grounding-type plug. A polarized plug has two blades with one wider than the other. A grounding type plug has two blades and a third grounding prong. The wide blade or the third prong are provided for your safety. If the provided plug does not fit into your outlet, consult an electrician for replacement of the obsolete outlet.
- 10) Protect the power cord from being walked on or pinched particularly at plugs, convenience receptacles, and the point where they exit from the apparatus.
- 11) Only use attachments/accessories specified by the manufacturer.
- 12) Use only with a cart, stand, tripod, bracket, or table specified by the manufacturer, or sold with the apparatus. When a cart is used, use caution when moving the cart/apparatus combination to avoid injury from tip-over.



- 13) Unplug this apparatus during lightning storms or when unused for long periods of time.
- 14) Refer all servicing to qualified service personnel. Servicing is required when the apparatus has been damaged in any way, such as power-supply cord or plug is damaged, liquid has been spilled or objects have fallen into the apparatus, the apparatus has been exposed to rain or moisture, does not operate normally, or has been dropped.
- 15) Apparatus shall not be exposed to dripping or splashing and no objects filled with liquids, such as vases, shall be placed on the apparatus.

- 16) Avoid improper installation and never position the unit where good ventilation is impossible. When installing this TV, distance recommendations must be maintained between the set and the wall, as well as inside a tightly enclosed area or piece of furniture. Keep to the minimum distance guidelines shown for safe operation.

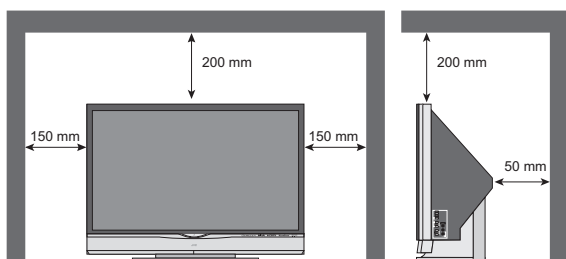

17) Cautions for installation

- Do not tilt the TV towards the left or right, or towards the back.
 - Install the TV in a corner on the floor so as to keep cords out of the way.
 - The TV will generate a slight amount of heat during operation. Ensure that sufficient space is available around the TV to allow satisfactory cooling.
- 18) Make enough room for inserting and removing the power plug. Place the TV as close to the outlet as possible. The main power supply for this TV is controlled by inserting or removing the power plug.

FCC Notice:

Note: This equipment has been tested and found to comply with the limits for a Class B digital device, pursuant to Part 15 of the FCC Rules. These limits are designed to provide reasonable protection against harmful interference in a residential installation. This equipment generates, uses and can radiate radio frequency energy and, if not installed and used in accordance with the instructions, may cause harmful interference to radio communications. However, there is no guarantee that interference will not occur in a particular installation. If this equipment does cause harmful interference to radio or television reception, which can be determined by turning the equipment off and on, the user is encouraged to try to correct the interference by one or more of the following measures:

- Reorient or relocate the receiving antenna.
- Increase the separation between the equipment and receiver.
- Connect the equipment into an outlet on a circuit different from that to which the receiver is connected.
- Consult the dealer or an experienced radio/TV technician for help.

CAUTION - These television models, HD-56G787, HD-56G887, HD-61G787 and HD-61G887 are for use only with JVC Model RK-CPRM7 stand. HD-52G787 and HD-52G887 are for use only with JVC Model RK-CPRS7 stand. HD-56G787 and HD-61G787 are for use only with JVC Model RK-CPTM7 stand. HD-70G887 is for use only with JVC Model RK-CAAL7 stand. Use with other stands is capable of resulting in instability causing possible injury.

Warnings

We have an important note for customers who subscribe to basic cable services (do not have a separate cable box) and plan to use their JVC TV remote control to select channels.

Once you run the Auto Tuner Setup (which detects and programs all the channels your TV is receiving through the RF input), every channel number available from your cable company will appear in your television's Channel Summary and they will all be marked as available for scanning. Even though every channel is detected and appears as available, you will only be able to view those that you specifically subscribe to from your cable company. This will likely mean there are blank channels between those channels you wish to scan or "surf".

We apologize for any inconvenience this may cause but it is important to note that this is not a malfunction of your television. If you want to sequentially scan those channels you subscribe to without blank ones in between, you can contact your cable company for their cable box and remote.

Caring for the Cabinet

Normally, light dusting with a soft, non-scratching duster will keep your TV clean.

If you wish to wipe down the television, first unplug it. Then wipe gently with a soft cloth, slightly moistened with water. You can add a few drops of mild liquid detergent to the water to help remove spots of oily dirt.

- DO NOT allow liquid to enter the TV through the ventilation slots.
- DO NOT use strong or abrasive cleaners on the TV.
- DO NOT spray liquids or cleaners directly on the TV's surface.
- DO NOT rub or scrub the TV harshly. Wipe the set gently with a soft cloth.

Caring for the Screen

The screen is treated with an electrostatic-proof coating. When it gets dirty, wipe it gently with a soft cloth. If the screen is very dirty, wipe it down with a cloth dipped in a diluted kitchen cleaner and thoroughly wrung-out. Then wipe immediately after with a clean, dry cloth.

Do not apply alcohol, organic solvents (like acetone), acidic or alkaline cleansers to the screen. These will remove the coating layer and cause discolorations.

Do not push or hit the screen. This could cause scratches on the screen surface and image distortions.

Warnings

Thank you for purchasing a JVC HDTV-ready projection television which uses the high-quality HD-ILA projection system. This is one of the highest quality and most technologically advanced televisions available today. It is recommended that you read this instruction manual before using your television in order to learn about its many features. Cautions related to the safe use of the device and important information which will help you to be able to use this device for a long time is in the Appendix. Once again, thank you for purchasing this television and please enjoy using it.

In order to use the television for a long time

This television uses a lamp to project the picture onto the screen. Before using this television, please read the safety cautions and information about this television which are summarized below.

1. When the power is turned on, the warming up commences

This television uses a lamp to project the picture onto the screen. Once the lamp has warmed up, you can enjoy the pictures at their full brightness. What happens when the power is turned on is explained below. Immediately after the power is turned on, since the lamp has not had time to warm up, the picture is displayed only dimly on the screen. As the lamp warms up, the picture becomes brighter. It takes approximately one minute for the lamp to warm up to its normal operating temperature. There are 2 LED indicators on the front panel of the television that can be used as a guide. When the POWER button is pressed, the LAMP LED indicator blinks in orange for approximately 1 minute at approximately every 2 seconds, and then goes out.

Note: It is impossible to turn the power off during this period. After 1 or more minutes have passed, you can turn off the power.

2. Cooling the inside of the television and the lamp

Cooling is also performed while the television is being shut down.

When the POWER button is pressed to turn off the power, the following operations are performed. When the television is turned off, the picture on the screen disappears. Once the screen is dark, cooling is performed for approximately 90 seconds. When the cooling is being performed, the LAMP LED indicator on the front panel blinks in orange at approximately every 3 seconds. **The television can not be operated while the cooling is being performed.** After the cooling has been performed for 90 seconds, the power is turned off. **Do not remove the electrical plug until after the cooling process has completed.** If the electrical plug is removed before the cooling process has completed, the internal circuits and lamp may overheat leading to the life of the lamp being shortened and the possibility of malfunctions.

Do not block the ventilation holes.

Do not block the ventilation holes while the power is turned on. Do not block the air intake holes behind the speaker grills.

3. The lamp is a consumable item

Replace the lamp when it has blown or when the picture becomes dark. The lamp is a user replaceable item. The lamp must be recycled. For a detailed explanation on how to recycle the lamp, refer to the Appendix and the instructions that are included with the replacement lamp kit. The life of the lamp changes depending on the atmospheric temperature and altitude in which the TV is being used.

Warnings

4. The television requires a lot of electrical power

It is recommended that the television is connected directly to the wall socket, and not to another device. When connecting the television to a wall socket that is being used by another device, or when using an extension cord, be careful not to exceed the electrical capacity of the socket.

Do not turn the power on and off repeatedly in a short amount of time.

It subjects the television and the lamp to stress and may lead to malfunctions and the life of the lamp being shortened.

5. The screen is made of plastic

Handle the screen very carefully as it can scratch easily. Do not rub, hit or press on it with any hard objects. When the screen is dirty, gently wipe it with a soft cloth. Refer to the Appendix for details on how to clean the screen.

6. Caution! Warm air from the air ducts

This unit has an air duct for cooling. The duct will blow warm air while the television is operating. When placing the television, make sure not to locate it too close to wallpaper. The warm air could cause the color of the wallpaper to change. Also, take care to keep children and pets away from the warm air ducts. Long exposure to the warm air from the ducts could cause a minor burn.

7. Caution! Moving this television

When lifting this television, Do not hold by the screen frame. Holding the screen frame could cause it to detach, causing the television to fall.

8. Do not replace the lamp immediately after use

The lamp becomes extremely hot during use. If the lamp is touched immediately after use before it has a chance to cool down, there is a danger of burns. Be careful when handling the lamp.

9. Do not touch the lamp glass

If the lamp is used when there is dirt from fingers on the lamp glass, there is a possibility of the lamp breaking. Be careful not to touch the lamp glass.

10. ILA element characteristics

Do not project still pictures or pictures that have still segments for a long period of time. The still parts of the picture may remain on the screen. This is a characteristic of ILA elements and not a malfunction. The picture will disappear over time.

11. Condensation

When a heater is turned on or the television is moved from a cold place to a hot place, droplets of water may form on the lamp and screen. This is called condensation. If the television is used while this condensation is still present, the picture may seem distorted, and the inside of the screen may become dirty. In this case, wait until the condensation has gone before using the television.

12. Do not open the rear cabinet of this television

This television has a DIGITAL-IN terminal. Opening up the rear cabinet will violate the copyright of the program or software shown on the television. Please do not open the rear cabinet.

13. Usable Time

Do not keep the TV on for more than 24 hours consecutively. There is a possibility of the life of the lamp being shortened.

Table of Contents

Important Safety Precautions . . .	2	Button Functions	62
Warnings	5	Multi Screen Function	62
Quick Setup	9	Split	62
Unpacking your TV	9	Index	63
TV Models	10	Freeze	63
TV Remote Control	12	Swap	63
Getting Started	13	Select	63
The Remote Control	13	Menu	63
Connecting Your Devices	14	OK	63
Interactive Plug In Menu	24	Back	63
Programming your remote	27	Power	64
Onscreen Menus	31	Number Buttons	64
Using the Guide	31	Tune	64
Onscreen Menu System	32	Input	64
Initial Setup	34	TheaterPro	64
Auto Tuner Setup	34	Return+/TV	65
Channel Summary	35	Sound	65
Channel Label	36	Video Status	66
V-Chip	37	Natural Cinema	66
Set Lock Code	43	Sleep Timer	67
Language	44	ML/MTS	67
Closed Caption	45	Muting	67
Auto Shut Off	47	Display	68
XDS ID	47	C.C.	68
Noise Muting	48	Channel +/-	68
Front Panel Lock	48	Volume +/-	68
V1 Smart Input	49	Favorite	69
Video Input Label	50	Aspect	70
Position Adjustment	51	Aspect Ratios	70
Power Indicator	51	TV/CATV Slide Switch	72
Digital-In	52	VCR/DVD Slide Switch	72
Digital-In1 Audio	52	VCR Buttons	72
Digital Setup	53	DVD Buttons	72
Picture Adjust	55	Light	72
Picture Settings	55	D/A (Digital/Analog)	73
Color Temperature	55	Sub Channel	73
Color Management	56	Guide	73
Dynamic Gamma	56	OSD Information	74
Smart Picture	56	Weak Signal	74
Digital VNR	57	No Program	74
MPEG NR	57	Invalid Signal	74
Reset	57	Lamp Replacement	75
Sound Adjust	58	Troubleshooting	80
Sound Settings	58	Specifications	82
Turn On Volume	58	Warranty	84
Volume Limit	58	Authorized Service Center	85
Reset	58	Notes	86
Clock/Timers	59		
Set Clock	59		
On/Off Timer	60		
Lamp Timer Reset	61		

Unpacking your TV

Thank you for your purchase of a JVC Color Television. Before you begin setting up your new television, please check to make sure you have all of the following items. In addition to this guide, your television box should include:

Television x 1

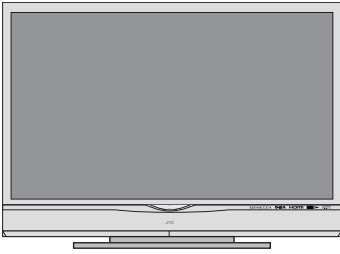

Remote Control x 1



AA
Batteries x 2



Note: Your television and/or remote control may differ from the examples illustrated here.

We recommend that before you start using your new television, you read your entire User's Guide so you can learn about your new television's many great features. If you're anxious to start using your television right away, a quick setup guide follows on the next few pages.

Quick Setup

TV Models

Before you connect your television to another device, please refer to the proper diagrams for your specific TV and remote. These will help assist you in understanding how to connect your television to another device, as well as use the remote to set up your television.

Rear Panel Diagram

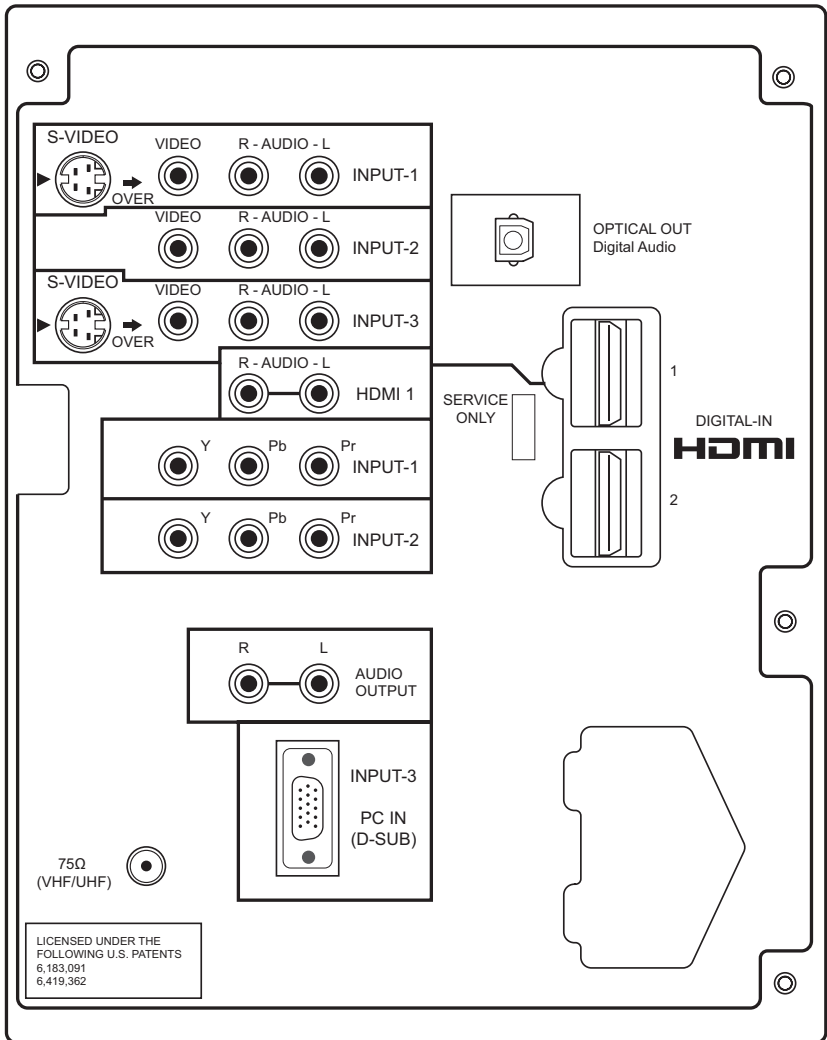

Note:

The terminal labeled "SERVICE ONLY", is exclusively used to update the software version.

Front Panel Diagram

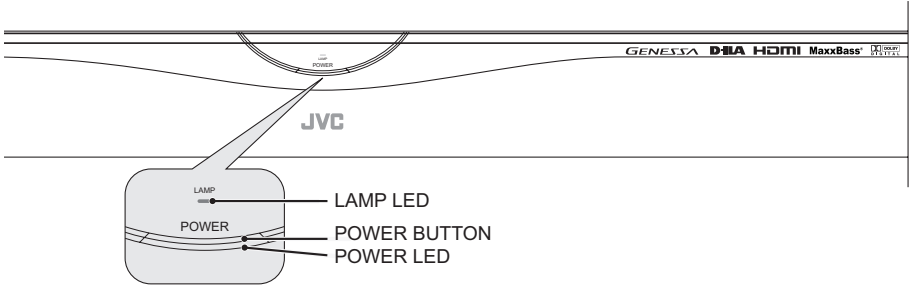

- For information on the LED, see page 79.

Side Panel Diagram

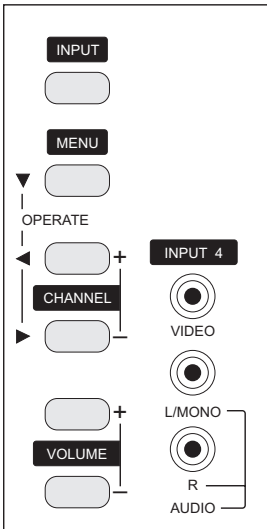

Quick Setup

Remote Control

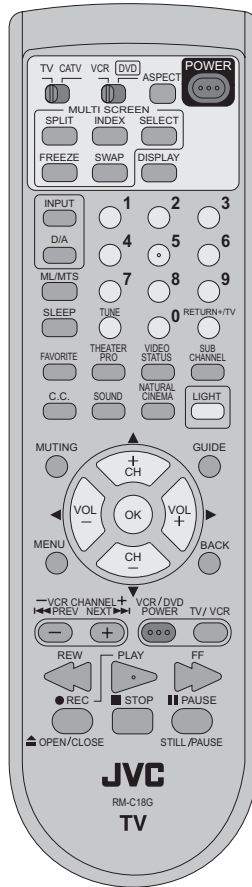

RM-C18G

- For information on remote control buttons, see pages 62 - 73.
- SUB CHANNEL and GUIDE buttons are for digital channels. If your TV is connected to an ATSC antenna or Digital Cable, you can use these buttons.

Getting Started

These quick setup pages will provide you, in three easy steps, with the basic information you need to begin using your new television right away. If you have questions, or for more detailed information on any of these steps, please consult other sections of this manual.

Step 1 – The Remote Control

Before you can operate your remote control, you first need to install the batteries (included).

Slide the cover on the back of the remote down towards the bottom of the remote control. Insert two batteries (included) carefully noting the “+” and “-” markings, placing the “-” end in the unit first. Slide the cover back into place.

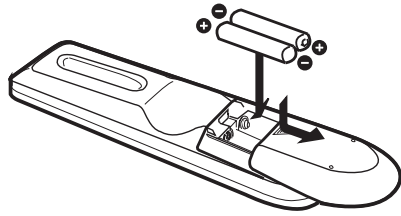

When you change the batteries, try to complete the task within three minutes. If you take longer than three minutes, the remote control codes for your VCR, DVD, and/or cable box/satellite receiver may have to be reset. See pages 27 - 30.

Key Feature Buttons

The four key feature buttons at the center of the remote can be used for basic operation of the television. The top and bottom buttons will scan forward and back through the available channels. To move rapidly through the channels using JVC's **Hyperscan** feature, press and hold CH+ or CH-. The channels will zip by at a rate of five channels per second. The right and left buttons will turn the volume up or down. These buttons are also marked with four arrows and are used with JVC's onscreen menu system. To use the onscreen menus, press the MENU button.

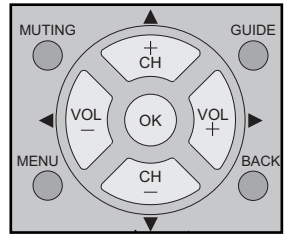

Basic Operation

Turn the television on and off by pressing the POWER button at the top right corner of the remote. The POWER LED will light blue. If this is the first time you are turning on the TV, the interactive plug-in menu appears.

- Make sure the TV/CATV switch is set to TV. Move the switch to CATV only if you need to operate a cable box.
- Slide the VCR/DVD selector switch to VCR to control a VCR. Slide to DVD to control a DVD player. Please see pages 27 - 30 for instructions on programming your remote control to operate a cable box, VCR or DVD player.



Note:

- If the lamp replacement message appears when you turn the television ON, see page 76.

Quick Setup

Step 2 – Connecting Your Devices

To make these connections, you will use plugs like the ones illustrated below.

Coaxial Cables



Used to connect an external antenna or cable TV system to your TV.

S-Video Cable



Used to make video connections with S-Video VCRs, Camcorders and DVD players.

Component Cables Composite Cables Audio Cables



Used to connect audio/video devices like VCRs, DVD players, stereo amplifiers, game consoles, etc.

Notes:

- These connections are examples.
- After you are finished connecting your devices, plug the power cord into the nearest power outlet and turn on the TV.
- If you follow these diagrams and the television does not work properly, contact your local cable operator.
- To connect a DVD player, see VCR Connection.
- If you have a satellite television system, refer to the satellite TV manual.

No VCR Connection

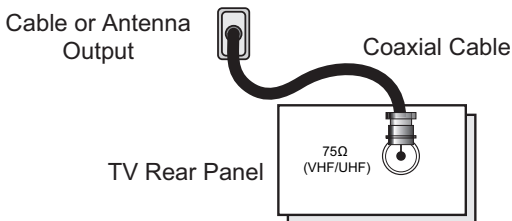

VCR Connection

Notes:

- Green, blue and red are the most common colors for DVD cables. Some models may vary colors. Please consult the user's manual for your DVD player for more information.
- Be careful not to confuse the red DVD cable with the red audio cable. It is best to complete one set of connections (DVD or audio output) before starting the other to avoid accidentally switching the cables.
- You may also connect the DVD player to Input 1.

Diagram #1

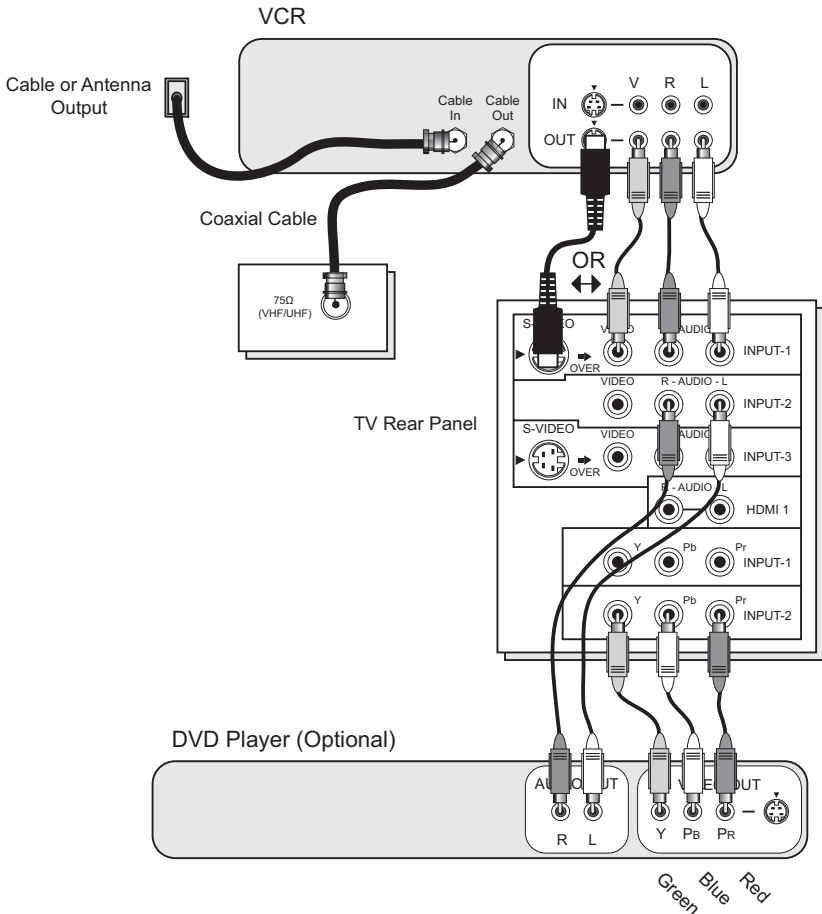

Note:

- If this connection setup does not work for you, try the connection setup on page 16.

Quick Setup

Diagram #2

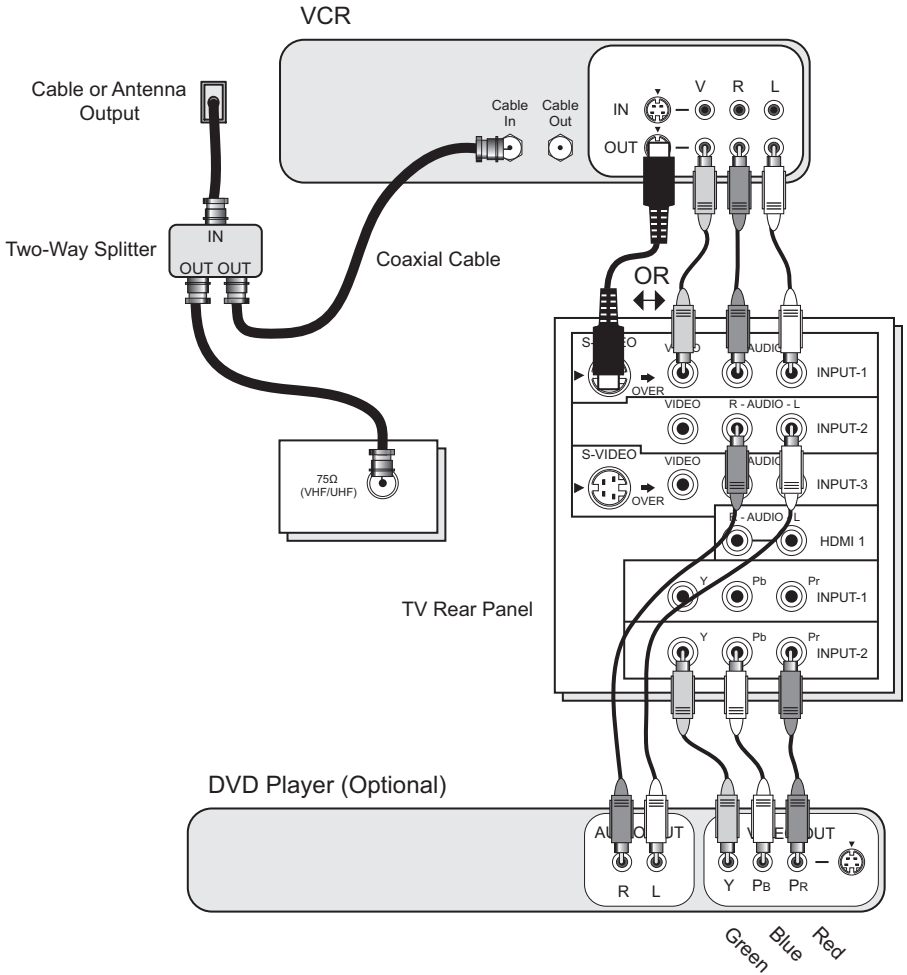

Connecting to a Camcorder

You may connect a camcorder, game console or other equipment to your television by using the side input jacks (Input 4) located on the side of the television. You can also connect these using the television's rear input jacks, using the same instructions.

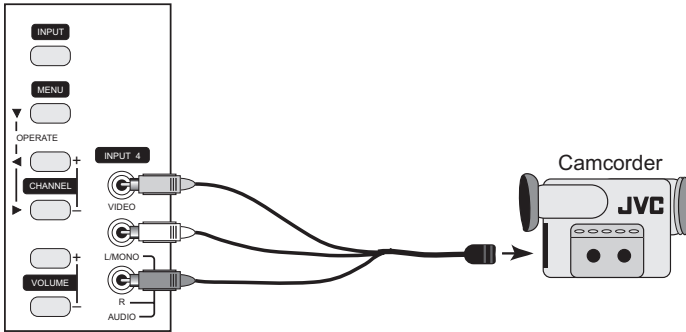

- 1) Connect a yellow composite cable from the camcorder VIDEO OUT, into the VIDEO IN on the side of the TV.
- 2) Connect a white cable from the camcorder LEFT AUDIO OUT, into the LEFT AUDIO IN on the side of the TV.
- 3) Connect a red cable from the camcorder RIGHT AUDIO OUT, into the RIGHT AUDIO IN on the side of the TV.

Note:

- If your camcorder is a mono sound model it will have only one AUDIO OUT. Connect it to the L/MONO on the side of the TV.

Quick Setup

Connecting to an External Amplifier

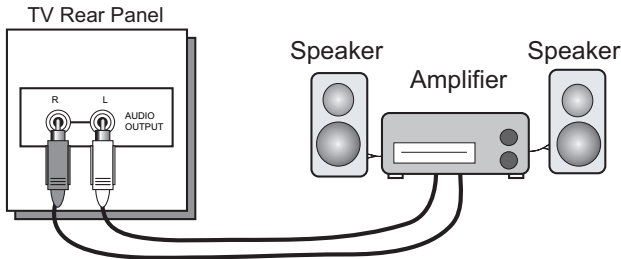

- 1) Connect a white cable from the LEFT AUDIO OUTPUT on the back of the TV to the LEFT AUDIO INPUT on the amplifier.
- 2) Connect a red cable from the RIGHT AUDIO OUTPUT on the back of the TV to the RIGHT AUDIO INPUT on the amplifier.

Notes:

- Refer to your amplifier's manual for more information.
- You can use AUDIO OUTPUT for your home theater system.
- You can not output audio using the AUDIO OUTPUT under the following conditions:
 - 1) When you have digital sound from an HDMI device connected to the HDMI 1 or HDMI 2 connection on the back of your TV. (See page 20).
 - 2) When you have analog sound from a DVI device connected to the AUDIO IN "HDMI 1" connection. (See page 19).

Connecting to an amplifier using your optical output

You can connect an amplifier that has an optical digital input terminal by using an optical digital cable from the optical output. The signal that is output can be PCM or Dolby Digital.

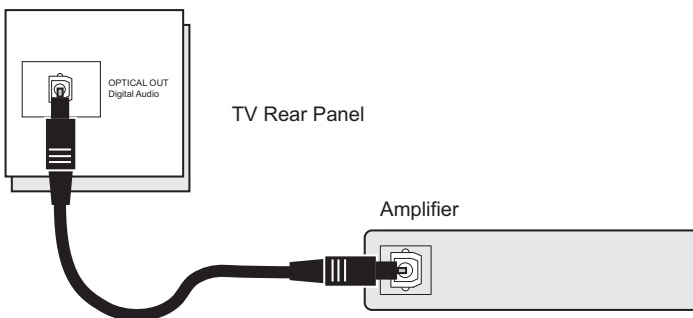

- 1) Connect the optical cable from the back of the TV to the back of the amplifier.

Notes:

- This terminal can only output digital audio.
- In order to use the optical output connection, select PCM or Dolby Digital on Digital Sound Menu. See page 54.
- Refer to your owners manual on using your amplifier.

Connecting to a Digital TV Receiver

By connecting a Digital TV Receiver, high definition pictures can be displayed on your TV in their digital form.

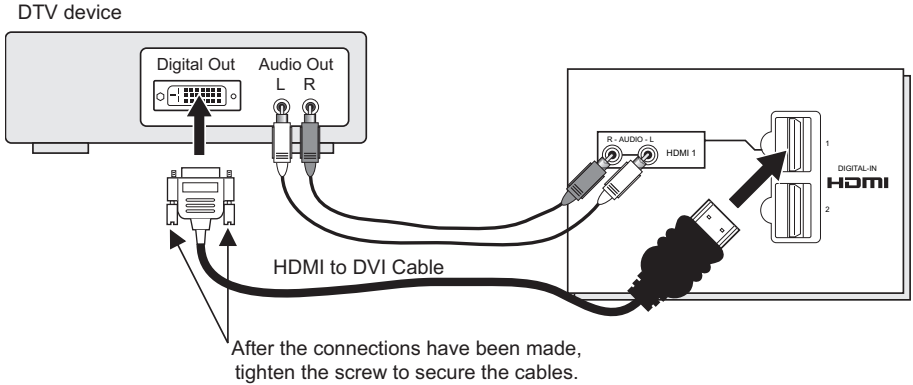

- 1) Connect the HDMI to DVI Cable from the DIGITAL OUT on the back of your DTV decoder, to the HDMI1 DIGITAL-IN on the back of your television.
 - 2) Connect a red cable from the "R AUDIO OUT" on the back of your DTV Device, to the HDMI 1 "R AUDIO" input terminal.
 - 3) Connect a white cable from the "L AUDIO OUT" on the back of your DTV Device, to the HDMI 1 "L AUDIO" input terminal.
- Personal computer compatibility cannot be guaranteed.
 - Use a HDMI to DVI cable (commercially available) in order to digitally connect the television with a DTV decoder.

Notes:

- If 480p signals (640x480 or 720x480) are displayed on the screen, the horizontal balance may be slightly shifted. Access the "DIGITAL-IN" in the initial setup menu to adjust it. (Refer to page 52.)
- When you do the above connection, set DIGITAL-IN1 AUDIO in the Initial Setup menu to ANALOG. See "DIGITAL-IN1 AUDIO", page 52.
- The Analog Audio input can only be used with the HDMI 1 input.
- When setting the "DIGITAL AUDIO – ANALOG / DIGITAL" menu setting on the TV, please note that this setting only effects the HDMI 1 jack and that if you use a DVI to HDMI adapter this connection must be made to the HDMI 1 along with analog audio cables.

Quick Setup

Connecting to an HDMI Compatible Device

By connecting an HDMI compatible device, high definition pictures can be displayed on your TV in their digital form. Some HDMI devices can include DVD players, D-VHS or any HDMI compatible devices.

HDMI (High Definition Multimedia Interface) is the first industry supported, uncompressed, all digital audio/video interface. HDMI provides and interface between any audio/video source, such as a set-top box, DVD player, A/V receiver or an audio and/or video monitor, such as a digital television (DTV).

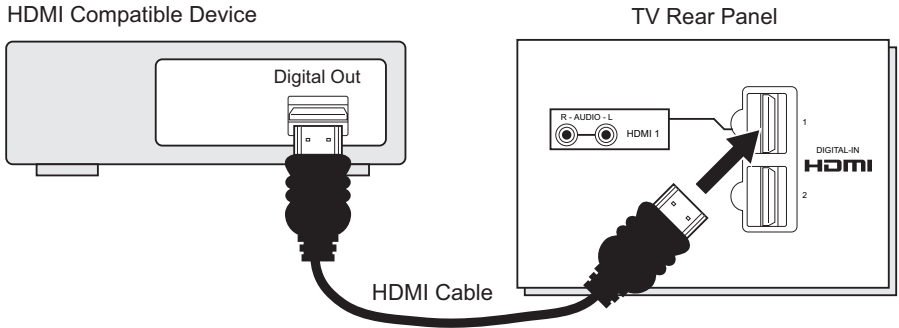

- 1) Connect the HDMI Cable from the DIGITAL OUT on the back of your DTV or HDMI device, to the HDMI1 DIGITAL-IN on the back of your television.

Notes:

- When you do the above connection, set DIGITAL-IN1 AUDIO in the Initial Setup menu to DIGITAL. See "DIGITAL-IN1 AUDIO", page 52.
- Some decoders may not respond depending on the equipment that you have connected when it is connected to the HDMI.
- If the HDMI output device signal is changed (for example, 480i/60Hz is changed to 480p/60Hz), the screen may turn green and there may be some distortion for a short time until the signal becomes stable.
- When you have an HDMI device connected to the HDMI 1 connection on the back of your TV, your TV detects it, and blocks the analog audio signal coming into the "HDMI 1" jacks. Therefore, you can not hear any analog sound from the other device connected to the "HDMI 1" jacks, while you are viewing the images from the HDMI device.

Connecting to an AV Receiver using your television's V1 Smart Input

By connecting your AV Receiver to your television's V1 Smart Input, you can watch picture sources from many different devices, without having to change or use the other input connections on your TV. This allows you to free up the other input connections so you can connect more devices to your television.

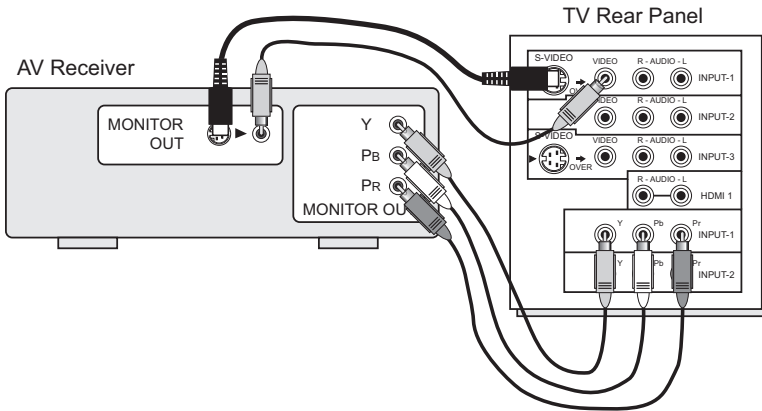

- 1) Connect an S-Video Cable from the AV Receiver's MONITOR OUT, to the S-Video INPUT-1 on the back of your television.
- 2) Connect a Yellow Composite Cable from the AV Receiver's MONITOR OUT, into the VIDEO INPUT-1 on the back of your television.
- 3) Connect a Green Component Cable from the AV Receiver's Y MONITOR OUT, into the Y VIDEO INPUT-1 on the back of your television.
- 4) Connect a Blue Component Cable from the AV Receiver's PB MONITOR OUT, into the Pb VIDEO INPUT-1 on the back of your television.
- 5) Connect a Red Component Cable from the AV Receiver's PR MONITOR OUT, into the Pr VIDEO INPUT-1 on the back of your television.

Note:

- Please refer to your AV Receiver instruction manual for more information on connecting your speakers and other devices like a DVD player.
- Use your AV Receiver's remote to switch to the different devices you have connected.
- Some AV Receivers may not respond when the V1 Smart Input function is turned on, see page 49.
- If you have video connections for each input device connected to your AV Receiver, you should not connect them using both S-Video and Composite connection at the same time when you are using V1 Input as the V1 Smart Input. In this case we recommend using the S-Video connection.

Quick Setup

Connecting to the computer

This TV can be used as a computer screen. Use a commercially available D-SUB cable to connect the TV's PC INPUT terminal to the computer's analog RGB output terminal. If you want to listen to the sound from the computer, use a commercially available RCA cable to connect the INPUT-3 audio input terminal to the computer's audio output terminal.

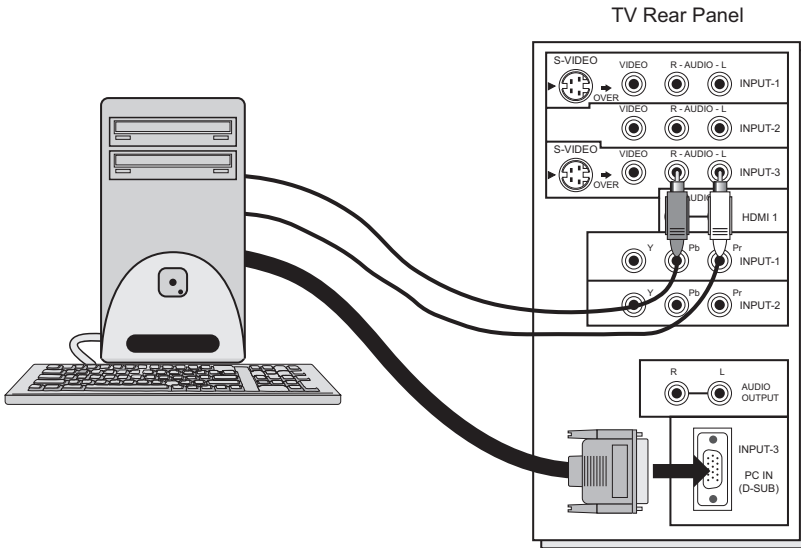

Notes:

- Refer to your computer manual for a detailed explanation of the connections concerning your computer.
- Make sure that the connectors are facing the correct way when connecting.
- After connecting, tighten the two screws to fix the connectors in place.

Looking at the images from a computer

After starting the computer, press the INPUT button to choose INPUT-3. You can listen to the sound when the sound from the computer is connected to the INPUT-3 AUDIO input terminal.

Notes:

- When the sound from the computer is connected to INPUT-3 by choosing external input INPUT-3, the sound from the computer can be listened to, but the images from the computer cannot be seen.

Table of signals for each type of computer

Resolution	Vertical Frequency (Hz)	Horizontal Frequency (kHz)
640 x 480 (VGA)	60.0	31.5
1024 x 768 (XGA)	60.0	48.4

- Only the above formats are supported.
- Even with the above formats at 60 Hz, some problems may be experienced depending on the quality of the synchronous signal. (Depending on the quality, some pictures may not be displayed correctly).
- Apple Macintosh* computers are not supported.

When a picture is not displayed

With some computers, some problems can be solved by changing the settings. Check the computer's refresh rate and set it to 60Hz. Computers that cannot set the refresh rate to 60 Hz, can not be used with this TV. Refer to the computer's instruction manual.

*Apple Macintosh is a registered trademark of Apple Computer, Inc.

Note:

- If you are inputting a PC signal that is invalid, "Invalid Signal" will appear on the TV screen. It appears when the input is PC and it is a single screen.

Quick Setup

Step 3 – The Interactive Plug In Menu

When you turn your television on for the first time the interactive plug-in menu will appear. The plug-in menu helps you to get your TV ready to use by letting you set your preferences for:

- The language in which you want the onscreen menus to appear.
- Setting the TV's clock to the correct time so your timer functions will work properly. You can choose "AUTO" or "MANUAL" for setting the clock.
- The auto tuner setup of which channels you wish to receive.

We recommend you complete the interactive plug-in items before you start using your television.

Notes:

- The interactive plug-in menu setting does not appear if your TV has been turned on before. In this case use the onscreen menus to perform these settings. See pages 45, 59 and 34.
- If you press the Menu button while setting up the interactive plug-in menu, it will skip over it.

Language

After the "JVC INTERACTIVE PLUG IN MENU" has been displayed, the TV automatically switches to the LANGUAGE settings. You can choose to view your onscreen menus in three languages: English, French (Français) or Spanish (Español).

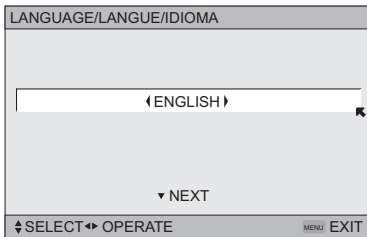

To choose a language:
(English, Français or Español)



To NEXT (To set clock)

(To be continued...)

Auto Clock Set

Before you use any of your TV's timer functions, you must first set the clock. You may precisely set your clock using the XDS time signal broadcast by most public analog broadcasting stations. If you do not have this in your area, you will have to set the clock manually. See manual clock set below. To set the clock using the XDS signal:

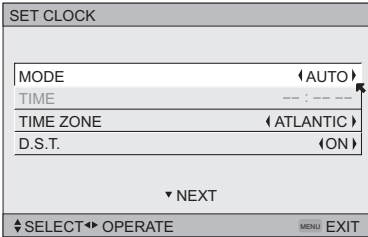

- ◀▶ To choose AUTO
- ▼ To TIME ZONE
- ◀▶ To select your time zone: (Atlantic, Eastern, Central, Mountain, Pacific, Alaska or Hawaii)
- ▼ To move to D.S.T. (Daylight Savings Time)
- ◀▶ To turn D.S.T. ON or OFF
- ▼ To NEXT (To Auto Tuner Setup)

Notes:

- D.S.T. can be used when it is set to ON in the SET CLOCK menu.
- Only when the MODE is set to AUTO, the Daylight Saving Time feature automatically adjusts your TV's clock for Daylight Saving.
- The real time and D.S.T. may not be set correctly depending on the broadcasting signal and receiving conditions. In this case, set your clock manually and turn D.S.T. to OFF.
- You will have to reset the clock after a power interruption. You must set the clock before operating any timer functions.

Manual Clock Set

To set your clock manually (without using the XDS signal), choose MANUAL. If you choose AUTO, see auto clock set above.

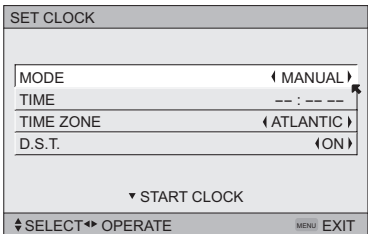

- ◀▶ To choose MANUAL
- ▼ To TIME
- ◀▶ To set the hour
- ▼ To minute
- ◀▶ To set the minute
- ▼ To TIME ZONE
- ◀▶ To select your time zone: (Atlantic, Eastern, Central, Mountain, Pacific, Alaska or Hawaii)
- ▼ To move to D.S.T. (Daylight Savings Time)
- ◀▶ To turn D.S.T. ON or OFF
- ▼ To START CLOCK

Note:

- You will have to reset the clock after a power interruption. You must set the clock before operating any timer functions.

(To be continued...)

Quick Setup

Auto Tuner Setup

In auto tuner setup, the TV automatically scans through all available channels, memorizing the active ones and skipping over blank ones or channels with weak signals. This means when you scan (using the CHANNEL +/- buttons) you will receive only clear, active channels.

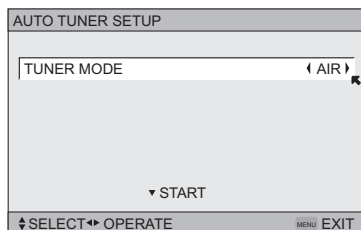

◀▶ To choose CABLE or AIR (or SKIP when you skip Analog Auto Tuner Setup)

▼ To START

After Analog Auto Tuner Setup is finished, Digital Auto Tuner Setup starts.

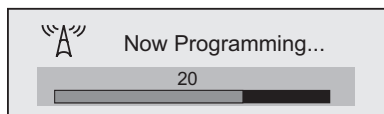

When the setup is finished, "THANK YOU ! SETUP IS NOW COMPLETE" is displayed. Your quick setup is now complete. You can now begin watching your television, or you can continue on in this guide for more information on programming your remote control, or using the JVC onscreen menu system to customize your television viewing experience.

Notes:

- If you want to cancel the Auto Tuner Setup, press the MENU button.
- Noise muting will not work during Auto Tuner Setup.
- If you choose SKIP, it finished without doing the Auto Tuner Setup.

Cable Box and Satellite Users: After your auto tuner setup is complete, you may, (depending on the type of hookup), have only 1 channel, usually 3 or 4 in the auto tuner memory. This is normal.

Programming your remote control

You can program your remote to operate your cable box, satellite receiver, VCR or DVD player by using the instructions and codes listed below. If the equipment does not respond to any of the codes listed below or to the code search function, use the remote control supplied by the manufacturer.

Cable Box or Satellite Codes

The remote control is programmed with cable box and satellite codes for power on/off, channel up/down, and 10 key operation.

- 1) Find the cable box or satellite brand from the list of codes shown below.
 - 2) Slide the 2-way selector switch to "CATV".
 - 3) Press and hold down the DISPLAY button, then enter the first code number listed with the 10 key pad.
 - 4) Release the DISPLAY button, and confirm the operation of the cable box/satellite receiver.
- If your cable or satellite box does not respond to the first code, try the others listed. If it does not respond to any code, try the search codes function, on page 30.

Cable Box	Codes	Cable Box	Codes	Digital Satellite Systems	Codes
ABC	024	Puser	032		
Archer	032, 025	RCA	061, 070		
Cableview	051, 032	Realistic	032	Eachostar (Dish Network)	100, 113, 114, 115
Citizen	022, 051	Regal	058, 064, 040, 041, 042, 045, 068	Express VU	100, 113
Curtis	058, 059			G.E.	106
Diamond	024, 032, 025	Regency	034	G.I.	108, 120, 121, 122
Eagle	029				
Eastern	034	Rembrandt	037, 032, 051, 038		
GC Brand	032, 051	Samsung	051	Gradiente	112
Gemini	022, 043	Scientific Atlanta	057, 058, 059	Hitachi	104, 111
General Instrument/Jerrold	065, 024, 025, 026, 027, 020, 021, 022, 057, 023, 072, 074	SLMark	051, 047	HNS (Hughes)	104
		Sprucer	051, 056	Magnavox	102, 103
		Stargate	032, 051	Panasonic	105
Hamlin	040, 041, 042, 045, 058, 064	Telecaption	067	Philips	102, 103, 116
Hitachi	049, 024	Televue	047, 051	Primestar	108
Macom	049, 050, 051, 054	Texscan	044	Proscan	106, 109, 110
		Tocom	035, 036, 066, 074	RCA	106, 109, 110
Magnavox	033	Toshiba	050, 048	Sony	107
Memorex	030			Star Choice	104, 108
Movietime	032, 051	Unika	032, 025	Toshiba	101, 104, 117, 118, 119
Oak	039, 037, 048	Universal	022, 032		
Philips	028, 029, 030, 052, 053, 031, 069	Videoway	052	Uniden	102, 103
Paragon	063	Viewstar	029, 030		
Zenith/Drake Satellite	028, 029, 030, 052, 053, 031, 069	Zenith	063, 046		
		Zenith/Drake Satellite	046		
Pioneer	047, 062				
Pulsar	051, 032				

Quick Setup

VCR Codes

The remote control is programmed with VCR codes for power on/off, play, stop, fast-forward, rewind, pause, record, channel up/down operation.

- 1) Find the VCR brand from the list of codes shown below.
 - 2) Slide the first 2-way selector switch to "TV" and the other 2-way selector switch to "VCR".
 - 3) Press and hold down the DISPLAY button, then enter the first code number listed with the 10 key pad.
 - 4) Release the DISPLAY button, and confirm the operation of the VCR.
- If your VCR does not respond to the first code, try the others listed. If it does not respond to any of the codes, try the search codes function on page 30.
 - After you program your remote, some VCR buttons may not work properly. If so, use the VCR's remote.
 - To record, hold down the REC button on the remote and press PLAY.

VCR	Codes	VCR	Codes	VCR	Codes
Admiral	035	Marantz	003, 004, 005	Samsung	037, 060, 062, 033, 089
Aiwa	027, 032, 095	Marta	064	Samtron	089
Akai	029, 072, 073, 074	Memorex	024, 067	Sansui	003, 026, 020, 052
Audio Dynamic	003, 005	MGA	038, 040, 047, 048, 041, 042	Sanyo	063, 067, 091, 071
Bell & Howell	063, 071	Minolta	058, 045, 093	Scott	059, 060, 062, 067, 038, 040, 047, 048, 026, 020
Broksonic	020, 026, 094	Mitsubishi	038, 040, 047, 048, 041, 042, 078, 090	Sears	063, 064, 065, 066, 058
Canon	023, 025	Multitech	047, 027, 062	Sharp	035, 036, 080, 088
CCE	043	NEC	003, 004, 005, 000	Shintom	075
Citizen	064	Olympic	024, 023	Signature 2000	027, 035
Craig	063, 029, 064	Optimus	028, 021, 035, 064	Singer	075
Curtis Mathes	045, 024, 027, 093	Orion	026, 020	Sony	028, 029, 030, 053, 054, 055
Daewoo	043, 059, 024, 092	Panasonic	023, 024, 021, 022	SV 2000	027
DBX	003, 004, 005	Penney	024, 058, 045, 063, 003, 004, 005, 093	Sylvania	031, 023, 024, 027
Dimensia	045, 093	Pentax	058, 005, 045, 093	Symphonic	027, 081
Emerson	043, 026, 077, 061, 025, 042, 020, 076	Philco	031, 024, 027, 023, 026, 020, 043	Tashiro	064
Fisher	063, 066, 067, 065, 071, 091	Philips	031, 023, 024, 086	Tatung	003, 004, 005
Funai	027, 026, 020, 000	Pioneer	023	Teac	003, 004, 027, 005
G.E.	033, 045, 024	Proscan	045, 058, 023, 024, 031, 046, 059, 060, 093, 033, 087	Technics	021, 022, 023, 024
Go Video	037, 051, 049, 050, 089	Quasar	021, 022, 023, 024	Teknika	024, 027, 070
Goldstar	064	Radio Shack	033, 024, 063, 036, 067, 040, 027	Thomson	033, 096
Gradiente	083, 084, 081, 000, 001	RCA	033, 045, 058, 023, 024, 031, 046, 059, 060, 083, 084, 085, 087, 093, 096	Toshiba	059, 046, 079
Hitachi	023, 045, 058, 093, 027, 081	Realistic	024, 063, 036, 067, 040, 027	Vector Research	005
Instant Replay	024, 023			Wards	035, 036, 067, 044, 064
Jensen	003			Yamaha	063, 003, 004, 005
JVC	003, 004, 005, 000, 001, 002, 006, 007			Zenith	044, 082, 064, 094
Kenwood	003, 004, 064, 005				
LG	064				
LXI	027, 064, 058, 065, 066, 063, 067				
Magnavox	031, 023, 024, 086				

DVD Codes

The remote control is programmed with DVD codes for power on/off, play, stop, fast-forward, rewind, previous/next chapter, tray open/close, and still/pause operation.

- 1) Find the DVD player brand from the list of codes shown below.
 - 2) Slide the first 2-way selector switch to "TV" and the other 2-way selector switch to "DVD".
 - 3) Press and hold down the DISPLAY button, then enter the first code number listed with the 10 key pad.
 - 4) Release the DISPLAY button, and confirm the operation of the DVD player.
- If your DVD player does not respond to the first code, try the others listed. If it does not respond to any of the codes, try the search codes function on page 30.
 - After you program your remote, some DVD buttons may not work properly. If so, use the DVD player's remote.

DVD Player	Codes	DVD Player	Codes	DVD Player	Codes
Aiwa	043	Mintek	057	Sharp	028
Apex	040, 054, 055	Mitsubishi	025	Sylvania	038
Bose	058	Next Base	056	SMC	048
Denon	020, 037	Onkyo	041, 052	Sony	024, 045, 046, 047
Funai	038	Oritron	044	Technics	020
Go-Video	032	Panasonic	020	Thomson	021
Harman Kardon	053	Philips	023, 036	Toshiba	023
Hitachi	031	Pioneer	022	Venturer	051
JVC	000	Polk Audio	036	Vialta	050
Kenwood	035, 020	Raite	033	Wave	042
KLH	051	RCA	021, 026	Yamaha	020, 049
Konka	039	Sampo	034	Zenith	027, 032
Koss	050	Samsung	030		

Quick Setup

Search Codes

Cable/Satellite Search Codes Function

- 1) Slide the first 2-Way Mode Selector switch to CATV.
- 2) Press the POWER and RETURN+/TV buttons. Hold for at least three seconds and release.
- 3) Press the POWER button on the remote, and see if the cable or satellite box responds.
- 4) If there was a response, press RETURN+/TV. The codes are now set. If there was no response, repeat Step 3. If you repeat Step 3 a total of 80 times without a response, use the remote control that came with your equipment.
- 5) Press RETURN+/TV to exit.



VCR/DVD Search Codes Function

- 1) Slide the first 2-way selector switch to "TV" and the other 2-way selector switch to "VCR" or "DVD".
- 2) Press the VCR or DVD POWER and RETURN+/TV buttons. Hold for at least three seconds and release.
- 3) Press the VCR or DVD POWER button, and see if the VCR or DVD responds.
- 4) If there was a response, press RETURN+/TV. The codes are now set. If there was no response, repeat Step 3. If you repeat Step 3 a total of 80 times for the VCR (40 times for the DVD player), and there is no response, use the remote control that came with your equipment.
- 5) Press RETURN+/TV to exit.

Onscreen Menus

Using the Guide

Certain symbols are used throughout this guide to help you learn about the features of your new television. The ones you will see most frequently are:

- ▲▼ Up and Down arrows mean press the CH+ or CH- buttons. Pressing the CH+ or CH- buttons let you:
 - Move vertically in a main menu screen
 - Move through a submenu screen
 - Move to the next letter, number, or other choice in a submenu
 - Back up to correct an error
 - Scan through TV channels (when not in a menu screen)
- ◀▶ Left and right arrows mean press the VOLUME+ or VOLUME- buttons to move left or right to:
 - Select a highlighted menu item
 - Select an item in a submenu
 - Select numbers in certain menu options
 - Turn the volume up or down (when not in a menu screen)
-  The “press button” icon means you should press the button named on your remote control. (Button names appear in SMALL CAPITAL LETTERS.)
-  The “helping arrow” icon points to the highlighted or selected item in a menu.

To bring up the onscreen menu, press the MENU button on the remote control. The item that appears in green is the one currently selected. If you use the Menu button on the TV's side panel instead of the remote, an additional menu screen showing VIDEO STATUS and ASPECT will appear between INITIAL SETUP and PICTURE ADJUST. The “interactive plug-in menu” will appear the first time the TV is plugged in.

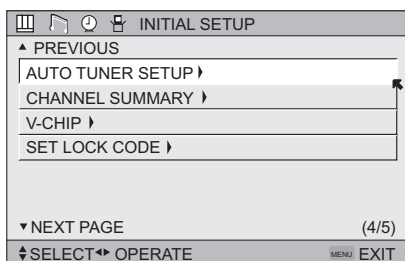

Note:

- Menus shown in this book are illustrations, not exact replications of the television's onscreen displays.

Onscreen Menus

The Onscreen Menu System

Your television comes with JVC's onscreen menu system. The onscreen menus let you make adjustments to your television's operation simply and quickly. Examples of the onscreen menus are shown on the next page. Detailed explanations on using each menu follow later in this guide. For information about the interactive plug-in Menu, see pages 24 - 26.

The Onscreen Menu System

To open the onscreen menu system, press the MENU button on the remote control. You navigate within the onscreen menus by using the four directional arrow buttons on the remote control. (These buttons are also the CH +/- and VOL +/- buttons. Channel and volume functions will not operate when the onscreen menu is active).

The selected feature and option on a menu screen are highlighted in a different color.

**Selected Option
(Green)**



**Selected Option
(Blue)**

To move to a different feature use the ▲ ▼ arrows to move up or down the list. When you press the up arrow at the top of the list or the down arrow at the bottom, the next menu screen will appear. Use the arrows ◀ ▶ to select an option from the highlighted feature. Pressing MENU on the remote control will close the onscreen menu system and return you to normal television viewing.

Each menu and its features will be discussed in the following pages of this guide.

Notes:

- If you do not press any buttons for about a minute, the onscreen menu will automatically shut off.
- Button names in this guide are shown in SMALL CAPITAL LETTERS.
- Menus may appear in different sizes onscreen depending on the aspect ratio selected.
- Some menu items may not appear in menu screens when certain aspect ratios or inputs are selected.

Onscreen Menus



Press the Menu button

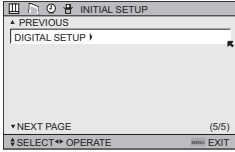

INITIAL SETUP 05

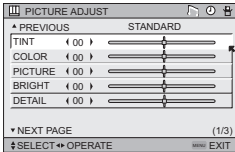

PICTURE ADJUST 01

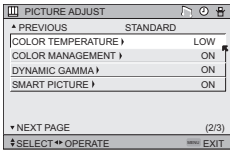

PICTURE ADJUST 02

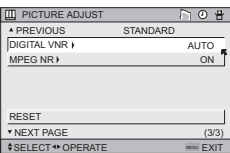

PICTURE ADJUST 03

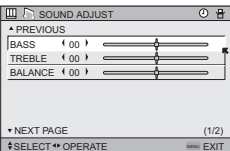

SOUND ADJUST 01

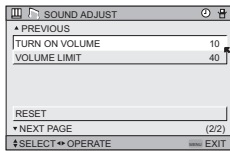

SOUND ADJUST 02

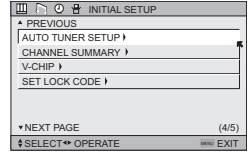

INITIAL SETUP 04

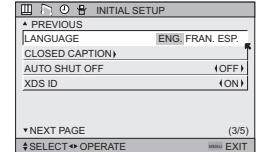

INITIAL SETUP 03

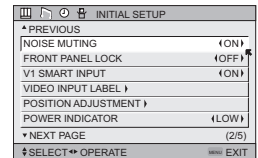

INITIAL SETUP 02

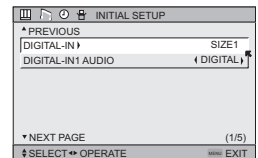

INITIAL SETUP 01

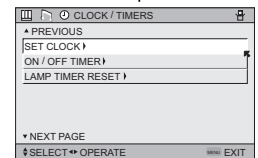





CLOCK / TIMERS

- The DIGITAL-IN menu can only be displayed when a 480p picture signal is input to the digital-in terminal and the picture is being displayed on the screen.
- When the Menu button on the TV side panel is pressed, the FRONT PANEL CONTROL menu between INITIAL SETUP 05 and PICTURE ADJUST 01 will appear.

Onscreen Menus

Auto Tuner Setup

The auto tuner setup function is described on page 26 as the interactive plug-in menu. If you need to run the auto tuner setup again, follow the steps below.

-  Press the MENU button
-  To AUTO TUNER SETUP
-  To operate
-  To choose CABLE or AIR
-  Press the Ok button to start

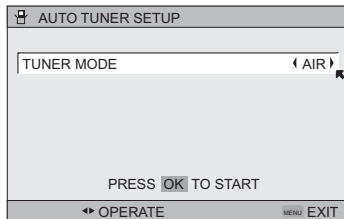

The auto tuner is finished when the message **PROGRAMMING OVER!** appears onscreen.

Note:

- Auto Tuner Setup in Digital Cable will take approximately 14 minutes.

Onscreen Menus

Channel Summary

Channel summary allows you to customize the line-up of channels received by your TV. Regarding analog channels, you can add or delete channels from the line-up or prevent any unauthorized viewers from watching any or all 181 channels. Regarding digital channels, the only channels that will appear are the ones that are broadcasting.



Press the MENU button



To CHANNEL SUMMARY



To operate

The Channel summary screen will now be displayed with the channels set to scan marked with an "√". Regarding analog channels, you can delete channels from the scan by removing the "√". If any channels were missed during auto tuner setup and you wish to add them, you may be placing an "√" next to the channel number.

- Digital channels can not be added to the channel summary if the auto tuner setup did not find them.



To the SCAN column



Press the Ok button to include or delete from scan



Press the MENU button when finished

Analog Channels

CHANNEL SUMMARY							
CHNO.	SCAN	ID	🔒	CHNO.	SCAN	ID	🔒
01				06	✓	HBO	
02	✓	MTV		07	✓	L	
03				08			
04	✓	A&E		09	✓		
05	✓	E!		10			

◀▶ SELECT (OK) OPERATE MENU EXIT

Digital Channels

Channel Summary Digital					
CH No.	Scan	Station Name	🔒		
D3-1	✓	CH-1			
D3-2	✓	CH-2			
D3-3	✓	CH-3			
D22-1	✓	CH-1			

Select (OK) Operate BACK (O) Back MENU (O) Exit

Note:

- The number of a digital channel may change, depending on the time of some broadcastings. If this channel existed and now had disappeared, the lock channel or scanned channel by the channel summary for that channel will be cancelled.

Onscreen Menus

How to set the channel label. *(This is only for analog broadcasting.)*



Press the MENU button



To CHANNEL SUMMARY



To operate



To the ID column



Press the Ok button to enter



To select the character you want



To move to the next space

...continue to follow these directions for all four spaces



Press the Ok button to finish

Your characters are now set



Press the MENU button when finished

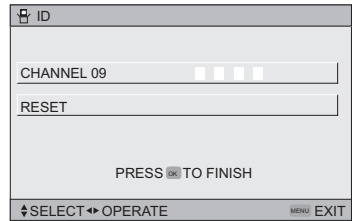

If you want to reset the characters you set:



Press the MENU button



To CHANNEL SUMMARY



To operate



To the ID column



Press the Ok button to enter



To select RESET



Press the Ok button to finish

Your characters are now reset

Notes:

- You can use characters for: Alphabet, numbers, marks and spaces.
- It is possible to set the maximum of 40 channel labels.
- If you try to set more than the 40 maximum, the message "MEMORY OVERFLOW" will appear.

You can block access to a channel by activating the channel lock.



Press the MENU button



To CHANNEL SUMMARY



To operate



To the Lock Column ()



Press the ZERO button to lock or unlock that channel



Press the MENU button when finished

Onscreen Menus

Channel Guard Message

When a viewer attempts to watch a guarded channel, the following message appears:

To watch a channel that you have locked, enter the Lock Code using the 10 key pad.

If the wrong code is entered, the message "INVALID LOCK CODE!" will flash on the screen.

The channel cannot be accessed until the correct code is entered.

THIS CHANNEL IS LOCKED BY
CHANNEL GUARD.
PLEASE ENTER LOCK CODE BY
10 KEY PAD TO UNLOCK IT.

NO. ----

Notes:

- Once a channel has been unlocked, it will remain unlocked until the television is turned off.
- See also "Set Lock Code", page 43.

V-Chip

Your TV is equipped with V-Chip technology which enables you to block channels or content that you feel to be inappropriate for children, based on US and Canada rating guidelines.

V-Chip has no effect on video signals from DVD discs or Camcorder connection.

Note: Some programs, and movies are broadcast without a ratings signal. Even if you set up V-CHIP ratings limits, these programs will not be blocked. See page 38 for information on how to block unrated programs.

Note (for Canadian viewers): The V-Chip function is based on specifications designed for the United States and therefore may not work properly in Canada.

You can customize the V-Chip settings of your television to match your personal tastes. The V-Chip menu below is the starting point for your V-Chip settings

You can use US V-Chip settings (for programming broadcast from the United States), Canadian V-Chip settings (for programming broadcast from Canada), and movie ratings. You may use any or all of the settings (US V-Chip, Canada V-Chip, Movie ratings). Descriptions for setting each of the three V-Chip formats appear in the next six pages along with descriptions of the rating categories.

To access the rating categories:



Press the MENU button



To V-CHIP



To operate (Lock icon  will appear)



Press ZERO to access the V-Chip menu



To turn V-Chip ON or OFF (V-Chip must be turned ON for rating settings to operate)



To move to SET US TV RATINGS, SET MOVIE RATINGS, or SET CANADIAN RATINGS (see following pages for descriptions of each item)

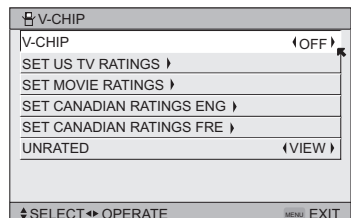

Onscreen Menus

Unrated Programs

Unrated programming refers to any programming which does not contain a rating signal. Programming on television stations which do not broadcast rating signals will be placed in the "Unrated Programming" category.

Examples of Unrated programs:

- Emergency Bulletins
- News
- Public Service Announcements
- Sports
- Some Commercials
- Locally Originated Programming
- Political Programs
- Religious Programs
- Weather

Note:

- TV programs or movies that do not have rating signals will be blocked if the unrated category is set to BLOCK.

Directions to Block Unrated Programs

You can block programs that are not rated.



Press the MENU button



To V-CHIP



To operate (The lock icon  appears)



Press ZERO to access V-Chip setup options



To UNRATED



To VIEW or BLOCK



Press MENU when done

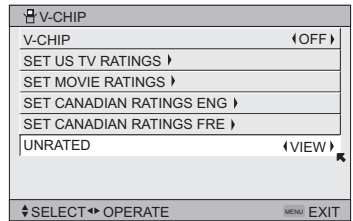

Onscreen Menus

US V-Chip Ratings

U.S. PARENTAL RATING SYSTEMS

Programs with the following ratings are appropriate for children.

TV Y is Appropriate for All Children

Programs are created for very young viewers and should be suitable for all ages, including children ages 2 - 6.

TV Y7 is for Older Children

Most parents would find such programs suitable for children 7 and above. These programs may contain some mild fantasy violence or comedic violence, which children should be able to discern from reality.

Programs with the following ratings are designed for the entire audience.

TV G stands for General Audience

Most parents would find these programs suitable for all age groups. They contain little or no violence, no strong language, and little or no sexual dialog or situations.

TV PG Parental Guidance Suggested

May contain some, but not much, strong language, limited violence, and some suggestive sexual dialog or situations. It is recommended that parents watch these programs first, or with their children.

TV 14 Parents Strongly Cautioned

Programs contain some material that may be unsuitable for children under the age of 14 including possible intense violence, sexual situations, strong coarse language, or intensely suggestive dialog. Parents are cautioned against unattended viewing by children under 14.

TV MA Mature Audiences Only

These programs are specifically for adults and may be unsuitable for anyone under 17 years of age. TV MA programs may have extensive V, S, L, or D.









Viewing Guidelines

In addition to the ratings categories explained above, information on specific kinds of content are also supplied with the V-Chip rating. These types of content may also be blocked. The content types are:

- **V/FV** is for VIOLENCE/FANTASY VIOLENCE
- **S** stands for SEXUAL CONTENT
- **L** stands for strong LANGUAGE
- **D** stands for suggestive DIALOG



Onscreen Menus

Setting US V-Chip Ratings

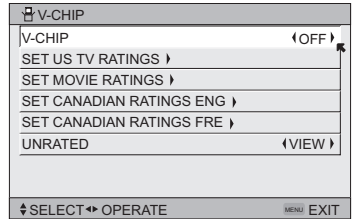



-  Press the MENU button
-  To V-CHIP
-  To operate (lock icon  appears)
-  Press ZERO to access the V-Chip menu
-  To turn V-Chip ON or OFF
-  To move to SET US TV RATINGS
-  To operate



Directions to set US V-Chip Ratings

Line up the cursor in the column (TV PG, TV G, etc.) with the content row (V/FV, S, etc.) and press the  or  to move the cursor to the correct location. Press Ok to turn the locking feature on or off. An item is locked if the  icon appears instead of a “—”.

For example. To block viewing of all TV 14 shows, move the cursor to the top row of that column and add a lock icon. Once you've put a lock on the top row, everything in that column is automatically locked.

-   To the TV 14 Column
-  Press the Ok button to lock
-  Press the MENU button when finished

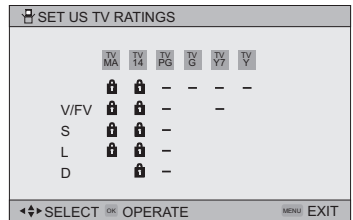

Note:

- If you want to change the setup, move the cursor to the top column and change the lock icon to “—” by pressing OK again. You may then select individual categories to block.

Onscreen Menus

Movies Ratings

NR – Not Rated

This is a film which has no rating. In many cases these films were imported from countries which do not use the MPAA ratings system. Other NR films may be from amateur producers who didn't intend to have their film widely released.

NR (Not Rated) Programming may contain all types of programming including children's programming, foreign programs, or adult material.

G – General Audience

In the opinion of the review board, these films contain nothing in the way of sexual content, violence, or language that would be unsuitable for audiences of any age.

PG – Parental Guidance

Parental Guidance means the movie may contain some contents such as mild violence, some brief nudity, and strong language. The contents are not deemed intense.

PG-13 – Parents Strongly Cautioned

Parents with children under 13 are cautioned that the content of movies with this rating may include more explicit sexual, language, and violence content than movies rated PG.

R – Restricted

These films contain material that is explicit in nature and is not recommended for unsupervised children under the age of 17.

NC-17 – No One Under 17

These movies contain content which most parents would feel is too adult for their children to view. Content can consist of strong language, nudity, violence, and suggestive or explicit subject matter.

X – No One under 18

Inappropriate material for anyone under 18.

Directions to set Movie (MPAA) Ratings



Press the MENU button



To V-CHIP



To operate (Lock icon  appears)



Press ZERO to access V-Chip setup options



To SET MOVIE RATINGS



To enter movies menu

For example: To block viewing of programming rated NC-17 shows, move the cursor to the NC-17 column and add a lock icon. Once you've put a lock on the NC-17 column, X column is automatically locked.



To the NC-17 Column



Press the Ok button to lock



Press the MENU button to finish

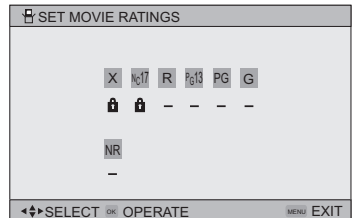

- If you want to change the setup, move the cursor to the column and change the lock icon to “—” by pressing Ok again.

Onscreen Menus

Canadian V-Chip Ratings

E – Exempt

Exempt programming includes: news, sports, documentaries and other information programming, talk shows, music videos, and variety programming.

C – Programming Intended for Children

Violence Guidelines: There will be no realistic scenes of violence. Depictions of aggressive behavior will be infrequent and limited to portrayals that are clearly imaginary, comedic or unrealistic in nature.

C8+ – Programming Intended for Children 8 and Over

Violence

Guidelines: Any realistic depictions of violence will be infrequent, discreet, of low intensity and will show the consequences of the acts. There will be no offensive language, nudity or sexual content.

G – General Audience

Programming will contain little violence and will be sensitive to themes which could affect younger children.

PG – Parental Guidance

Programming intended for a general audience, but which may not be suitable for younger children. Parents may consider some content not appropriate for children aged 8-13.

14+ – 14 Years and Older

Parents are strongly cautioned to exercise discretion in permitting viewing by pre-teens and early teens. Programming may contain mature themes and scenes of intense violence.

18+ – Adult

Material intended for mature audiences only.

Directions to set Canadian V-Chip Ratings



Press the MENU button



To V-CHIP



To operate (lock icon  appears)



Press ZERO to access V-Chip setup options



To SET CANADIAN RATINGS ENG (for English)



To enter ratings menu

For example: To block viewing of programming rated 14+ shows, move the cursor to the 14+ column and add a lock icon. Once you've put a lock on the 14+ column, 18+ column is automatically locked.



To the 14+ Column



Press the Ok button to lock



Press the MENU button to finish

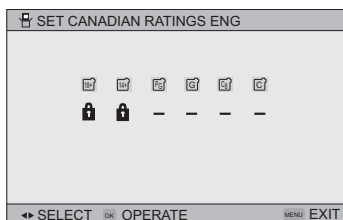

Notes:

- If you want to change the setup, move the cursor to the column and change the lock icon to “—” by pressing Ok again.
- For instructions on “SET CANADIAN RATINGS FRE (in French)”, please see page 42 in the French side of this user’s guide.

Onscreen Menus

Set Lock Code

Channel guard and V-Chip settings are protected by a four-digit lock code. Your TV comes preset with a lock code of "0000". You may change the code to any four-digit number you wish. To change the lock code, follow the steps below.



Press the MENU button



To SET LOCK CODE



To operate (lock icon  appears)



Press ZERO to access the lock code

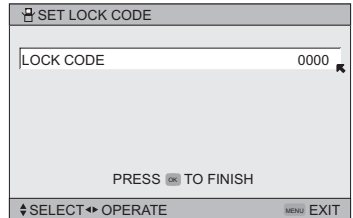

The first digit will be highlighted



To select the number



To move to the next digit

Continue to follow these directions for all four numbers



Press the OK button to finish (your lock code is now set)



Press the Menu button when finished

When a viewer attempts to watch a blocked channel, this message appears:

THIS PROGRAMMING EXCEEDS
YOUR RATING LIMITS.
PLEASE ENTER LOCK CODE BY
10 KEY PAD TO UNLOCK IT.
NO. - - - -

The channel will remain blocked until the correct lock code is entered (see above for information on setting your lock code).

Notes:

- After a power interruption you must reset the lock code.
- Write your lock code number down and keep it hidden from potential viewers.
- If you forget the lock code, a new code may be set using the steps listed above.

Onscreen Menus

Language

The language function is described on page 24 as the interactive plug-in menu. If you need to choose the language again, follow the steps below.



Press the Menu button



To LANGUAGE



To choose a language: ENG. (English),
FRAN. (French) or ESP. (Spanish)



Press the MENU button when finished

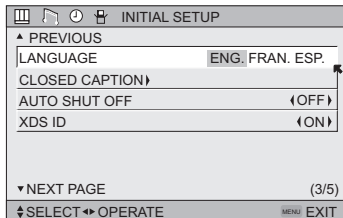

Onscreen Menus

Closed Caption

Many broadcasts now include an onscreen display of dialog called closed captions. Some broadcasts may also include displays of additional information in text form. Your television can access and display this information using the closed caption feature. To activate the closed caption feature, follow the steps below. There are three methods. When you are watching analog channels, you can perform Analog Setting of closed caption. When you are watching digital channels, you can perform Digital Auto Setting or Digital Manual Setting.

Analog Setting



Press the MENU button



To CLOSED CAPTION



To enter



To MODE



To select CAPTION or TEXT in MODE



To CAPTION or TEXT



To select a caption (CC1 to CC4) or text channel (T1 to T4)



Press the Ok button to save



Press the MENU button when finished

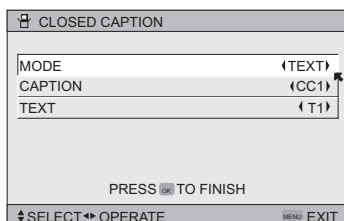

Digital Auto Setting



Press the MENU button



To CLOSED CAPTION



To enter



To Type



To select Auto, Advanced or Basic

Auto: Shows closed caption a priority for digital channels over analog channels. It is set automatically.

Advanced: Shows only the digital closed caption.

Basic: Shows only the analog closed caption.



To Service



To select 1, 2, 3, 4, 5 or 6



To Appearance



To enter



To select Auto



To Set



Press the Ok button to save

The font/type and color are set automatically.



Press the MENU button when finished

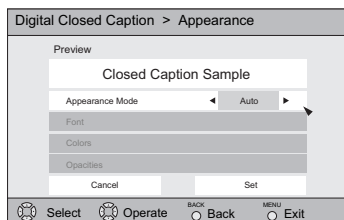
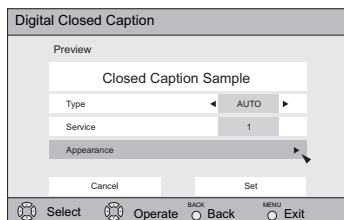

Note:

- If you want to cancel the settings, select cancel.

Onscreen Menus

Digital Manual Setting



Press the MENU button



To CLOSED CAPTION



To enter



To Type



To select Auto, Advanced or Basic



To Service



To select 1, 2, 3, 4, 5 or 6



To Appearance



To enter



To select Manual



To Font



To enter



To select Font Size or Font Style



To select the setting you like

Font Size: Auto, Standard, Large or Small

Font Style: Auto, Serif Mono, Serif, Sanserif mono, Sanserif, Casual, Curative or Small Capital



To Set



Press the Ok button to save



To Colors



To enter



To select Text, Edge or Background



To select the setting you like

Auto, White, Black, Red, Green, Blue, Yellow, Magenta or Cyan



To Set



Press the Ok button to save



To Opacities



To enter



To select Text/Edge or Background



To select Auto, Transparent, Translucent, Solid or Flashing



To Set



Press the Ok button to save



Press the MENU button when finished

Notes:

- Closed caption subtitles are usually found on closed caption channel CC1. Some programs may include additional text information which is usually found on text channel T1. The other channels are available for future use.
- Closed captioning may not work correctly if the signal being received is weak or if you are playing a video tape.
- Most broadcasts containing closed captioning will display a notice at the start of the program.
- To select the mode, press the C.C. button. See page 68.
- When ZOOM aspects like PANORAMA or CINEMA are selected, Digital Closed Captions may be cut off or distorted.

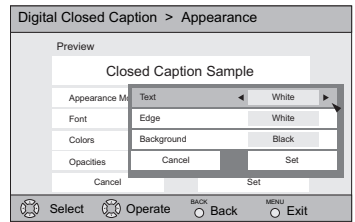
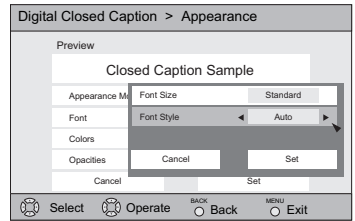
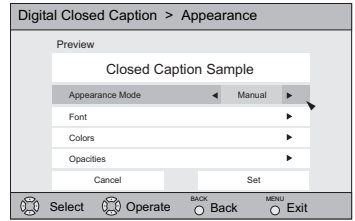

All fonts used for digital closed caption and digital menus are licensed from Monotype Imaging Inc.

Onscreen Menus

Auto Shut Off

This function automatically shuts off your TV when there is no signal from the channel the TV is on.



Press the MENU button



To AUTO SHUT OFF
To turn ON or OFF



Press the MENU button when finished

- If the channel that you have on does not receive a signal for more than one minute, the blinking text "NOT RECEIVING A SIGNAL AUTO SHUT OFF IN 9 MIN." appears on the screen, and starts the countdown. If no signal is being received within 10 minutes, the TV shuts itself off.

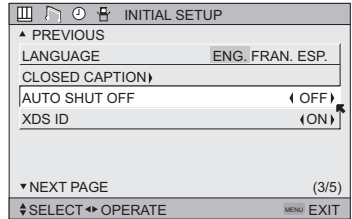

XDS ID

XDS ID Display provides a channel's call letters, the network's name, and even a program name. The XDS ID information is provided by the broadcaster.



Press the MENU button



To XDS ID
To turn ON or OFF



Press the MENU button when finished

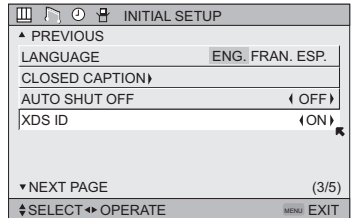

Onscreen Menu

Noise Muting

This feature inserts a blank gray screen over channels which are not broadcasting or are too weak to be received clearly.



Press the MENU button



To NOISE MUTING



To turn noise muting ON or OFF



Press the MENU button when finished

Notes:

- Noise muting will not work during auto tuner setup or when you operate channel summary.
- Noise muting will not work when the digital TV is displayed.

INITIAL SETUP	
▲ PREVIOUS	
NOISE MUTING	(ON) ←
FRONT PANEL LOCK	(OFF) ←
V1 SMART INPUT	(ON) ←
VIDEO INPUT LABEL ▶	
POSITION ADJUSTMENT ▶	
POWER INDICATOR	(LOW) ←
▼ NEXT PAGE	(2/5)
⚡ SELECT ↔ OPERATE	MENU EXIT

Front Panel Lock

This allows you to lock the keys on the side of the TV, so that a child may not accidentally change your viewing preferences.



Press the MENU button



To FRONT PANEL LOCK



To turn ON or OFF



Press the MENU button when finished

INITIAL SETUP	
▲ PREVIOUS	
NOISE MUTING	(ON) ←
FRONT PANEL LOCK	(OFF) ←
V1 SMART INPUT	(ON) ←
VIDEO INPUT LABEL ▶	
POSITION ADJUSTMENT ▶	
POWER INDICATOR	(LOW) ←
▼ NEXT PAGE	(2/5)
⚡ SELECT ↔ OPERATE	MENU EXIT

You can turn off this feature in the following ways:

- Unplug the power cord, and plug it back in. Do this if your batteries die, or you lose your remote control.
- Use the remote control.
- Press the MENU button on the side of the TV for more than 3 seconds. In this case, the OSD for FRONT PANEL LOCK will appear.

Note:

- To turn ON/OFF the TV, press the power button for more than 3 seconds. This feature will remain ON.

Onscreen Menus

V1 Smart Input

This feature is used if you have connected an AV Receiver to your television. By turning this feature on, your television can automatically detect the signal source from your components that are connected to your AV Receiver.



Press the MENU button



To V1 SMART INPUT
To turn ON or OFF



Press the MENU button when finished

Notes:

- If you do not have an AV Receiver connected to your television, turn this feature OFF.
- Some AV Receivers may not work with this function.

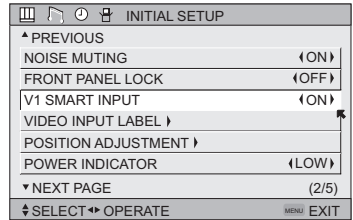

Onscreen Menus

Video Input Label

This function is used to label video input connections for the onscreen displays.



Press the MENU button



To VIDEO INPUT LABEL



To enter



To select the desired video input



To select the desired preset input label (see chart below)



Press the OK button to save



Press the MENU button when finished

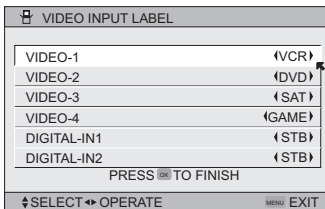
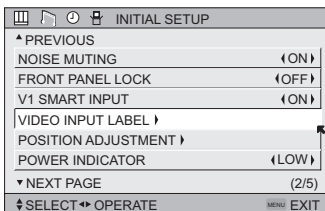

Preset Labels	Select when...
VCR	You have a VCR connected to the video input
DVD	You have a DVD connected to the video input
PVR	You have a Personal Video Recorder connected to the video input
D-VHS	You have a Digital VCR connected to the video input
STB	You have a Set-top Box connected to the video input
SAT	You have a Satellite Receiver connected to the video input
AMP	You have an Amplifier connected to the video input
GAME	You have a Video Game connected to the video input
CAM	You have a Video Camera connected to the video input
DISC	You have a Video Disc player connected to the video input

Onscreen Menus

Position Adjustment

Position adjustment allows you to adjust the position of the picture on the screen vertically when the aspect is set to panorama or cinema.



Press the MENU button



To POSITION ADJUSTMENT



To enter



To adjust the position



Press the MENU button to finish

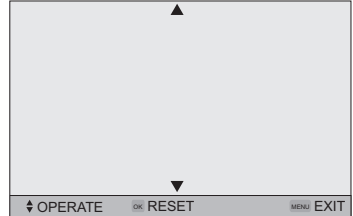

Notes:

- To reset the adjustment to the center, press the Ok button.
- When the arrow disappears, while you are adjusting the position, the position is at its maximum limit.
- If you select regular size, slim size and full size with aspect or Multi Screen, position adjustment option is not seen.
- When you change the screen size, perform the position adjustment again.
- Position adjustment allows you to adjust the screen position vertically and horizontally when the aspect is set Panorama Zoom or Cinema Zoom for 1080i and 720p signals, or when PC mode is set.

Power Indicator

Power indicator allows you to adjust the brightness of the power indicator



Press the MENU button



To POWER INDICATOR



To adjust POWER INDICATOR LOW, HIGH or OFF

Notes :

- When OFF is selected :
The LED disappears if you have a TV signal.
The LED is lit as "LOW" when there is no TV signal.
- When the On Timer turns ON, the LED is lit as "LOW" when you turn the power off.
- If you set a timer on the TV, the power indicator will light even if the TV is on stand by.

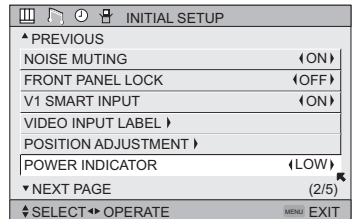

Onscreen Menus

Digital-In

The DIGITAL-IN option can only be displayed in the INITIAL SETUP menu when an HDMI480p picture signal is being input to the DIGITAL-IN terminal. This option adjusts the position when an HDMI or DVI 480p picture signal is being displayed on the screen. There are two types of HDMI480p picture signals: 640x480 and 720x480. If the displayed picture is slightly shifted, the position can be adjusted by selecting either SIZE1 or SIZE2.



Press the MENU button



To DIGITAL-IN



To enter



To select AUTO, SIZE1 or SIZE2



Press the MENU button to finish

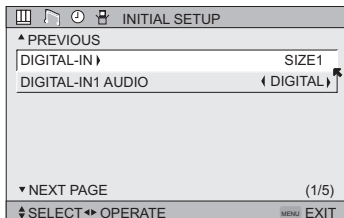

Notes:

- The DIGITAL-IN menu can only be displayed when a HDMI or DVI 480p picture signal is input to the Digital-In terminal and the picture is being displayed on the screen.
- You can select AUTO only when the signal is 480p for HDMI. When you select AUTO, the television will select "SIZE1" or "SIZE2" automatically.

Digital-in1 Audio

This feature is used if you have a DTV or HDMI compatible component connected to your TV.



Press the MENU button



To DIGITAL-IN1 AUDIO



To select ANALOG, DIGITAL or AUTO



Press the Menu button when finished

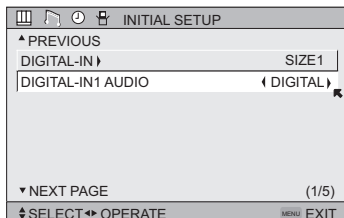

Notes:

- If your DTV or HDMI component is capable of digital audio and video, choose DIGITAL. If your DTV or HDMI component is capable of analog audio and digital video, choose ANALOG.
- Refer to your DTV or HDMI component's instruction manual for more information.
- When you select AUTO, the television will select "ANALOG" or "DIGITAL" automatically, depending on the audio input from the HDMI.
- When you select DIGITAL, select PCM on Digital Sound menu. See page 54.
- When your input is DIGITAL-IN2, DIGITAL-IN AUDIO cannot be selected.

Onscreen Menus

Digital Setup

Use this function when you are receiving a digital broadcast.



Press the MENU button



To DIGITAL SETUP



To enter

The onscreen will appear

Notes:

- Software Update will only appear when the USB memory is inserted into the USB connector.
- If you are watching an analog channel, you can still access the digital setup menu at anytime, while you are doing this, the background screen will turn blank. In this case, the tuner will switch to digital, since you are accessing the digital setup menu.

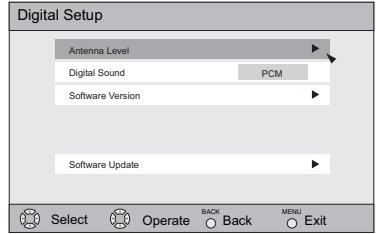

Antenna Level

Confirms the present antenna level.



Press the MENU button



To DIGITAL SETUP



To enter



To Antenna Level



To enter

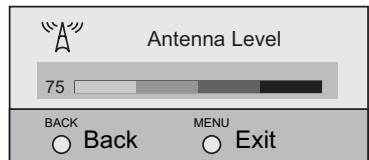

Onscreen Menus

Digital Sound

You can select the optical digital sound output, either PCM or Dolby Digital when your TV is connected to an amplifier that has Dolby Digital decoder. If you select Dolby Digital, you can enjoy listening in 5.1ch sound when watching digital broadcasts.



Press the MENU button



To DIGITAL SETUP



To enter



To Digital Sound



To select PCM or DOLBY DIGITAL



Press the MENU button when finished

Notes:

- If your amplifier does not have Dolby Digital decoder, select PCM. If you don't select PCM, it cannot output the sound from the speakers.
- For connecting an amplifier using the optical output, see page 18.



Manufactured under license from Dolby Laboratories. "Dolby", and the double-D symbol are trademarks of Dolby Laboratories.

Software Version

You can confirm the Software Version.



Press the MENU button



To DIGITAL SETUP



To enter



To Software Version



To enter



Select close when you are finished confirming your software version



Press the MENU button when finished

Software Update

At first, connect the USB memory into the USB connector. This function will appear only when the USB memory is inserted into the USB connector.



Press the MENU button



To DIGITAL SETUP



To enter



To Software Update



To enter



Checks the card if it needs an update or not



Press the MENU button when finished

Onscreen Menus

Picture Settings

These settings allow you to change and adjust the way the picture appears on your television.

TINT

Tint allows you to adjust the levels of red and green in your TV picture.

COLOR

The color function lets you make all the colors in the TV picture appear either more vivid or subtle.

PICTURE

Picture allows you to adjust the levels of black and white on the TV screen, giving you a darker or brighter picture overall.

BRIGHT

You can adjust the overall brightness of the TV picture with the Bright control.

DETAIL

The Detail feature adjusts the level of fine detail displayed in the picture.

Adjust the Picture Settings



Press the MENU button



To TINT, COLOR, PICTURE, BRIGHT or
DETAIL



To enter

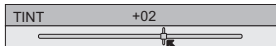

To adjust the setting



To move to the next setting



Press the MENU button when finished

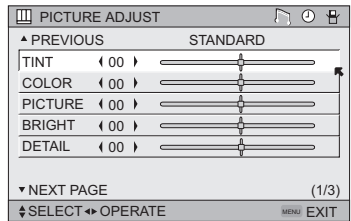

Color Temperature

You can decide how strong or dull the colors appear on the TV screen.



Press the MENU button



To COLOR TEMPERATURE



To enter



To set LOW or HIGH



Press the MENU button when finished



Onscreen Menus

Color Management

This TV supports the COLOR MANAGEMENT function to ensure dull colors are compensated to produce natural hues.



Press the MENU button



To COLOR MANAGEMENT



To enter



To select the mode "ON" or "OFF"



Press the MENU button when finished



Dynamic Gamma

JVC's Dynamic Gamma Circuitry (DGC) makes it easier to see dark areas when a picture has many dark areas, and makes it easier to see the bright areas when a picture has many bright areas. DGC is turned on, DGC analyzes and adjusts the total level of picture brightness balance, especially in dark areas where the level of grayscale is often lost, turning completely to black DGC automatically enhances the detail in these dark areas providing a more dynamic image with finer detail, so the optimum picture settings are automatically set for each picture. Normally use with DGC on.



Press the MENU button



To DYNAMIC GAMMA



To enter



To turn ON or OFF



Press the MENU button when finished

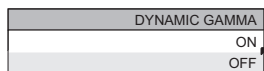

Smart Picture

Smart Picture detects the APL (Average Picture Level) and adjusts the contrast suitable for what you are watching.



Press the MENU button



To SMART PICTURE



To enter



To select the mode "ON" or "OFF"



Press the MENU button when finished

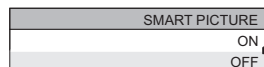

Note:

- When you have "DYNAMIC" selected in the "VIDEO STATUS", Smart Picture is not selected.

Onscreen Menus

Digital VNR

This function can be selected to change the effect of Digital VNR (Video Noise Reduction).



Press the MENU button



To DIGITAL VNR



To enter



To select the effect you like

AUTO: adjusts the effect of VNR automatically

MIN: adjusts the effect of VNR to minimum

MAX: adjusts the effect of VNR to Maximum

OFF: turns the effect of VNR off

DIGITAL VNR	
	AUTO
	MIN
	MAX
	OFF



Press the MENU button when finished

Note:

- If it is in PC, Digital VNR will not be displayed.

MPEG NR

This function effects the block noise removal and mosquito NR (Noise Reduction) simultaneously.



Press the MENU button



To MPEG NR



To enter



To select ON or OFF

MPEG NR	
	ON
	OFF



Press the MENU button when finished

Note:

- When you are receiving digital channels, block noise removal will have no effect.

Reset

Reset resets all picture adjustments (tint, color, picture, bright, detail, color temperature, dig. noise clear, Color Management, Dynamic Gamma and Smart Picture) at once to the default settings.



Press the MENU button



To RESET



To enter

The onscreen menu disappears for a moment, and then the settings are reset to the default setting for all the picture adjustments.



Press the MENU button when finished

PICTURE ADJUST	
▲ PREVIOUS	STANDARD
DIGITAL VNR ▼	AUTO
MPEG NR ▼	ON
RESET	
▼ NEXT PAGE	(3/3)
⬇ SELECT ⬆ OPERATE	MENU EXIT

Onscreen Menus

Sound Settings

These settings allow you to change and adjust the sound on your television.

BASS – You can increase or decrease the level of low-frequency sound in the TV's audio with the bass adjustment.

TREBLE – Use treble to adjust the level of high-frequency sound in your TV's audio.

BALANCE – Adjust the level of sound between the TV's left and right speakers with the balance setting.

Adjust the Sound Settings



Press the MENU button



To BASS, TREBLE or BALANCE



To adjust the setting



To move to the next setting



Press the MENU button when finished

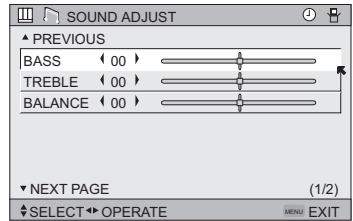

Note:

- You can reset the sound adjustments (BASS, TREBLE and BALANCE) you set at once as the default setting when you select reset. See page 57.
- You can adjust BALANCE only when A.H.S.+ is off. See page 65.

Turn On Volume

Turn On Volume allows you to set the volume level when you turn the TV on.



Press the MENU button



To TURN ON VOLUME



To set

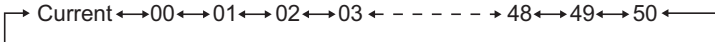

Press the MENU button to finish

Volume Limit

Volume Limit allows you to set the maximum volume level.



Press the MENU button



To VOLUME LIMIT



To set the maximum volume level

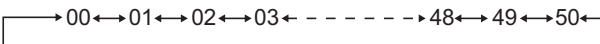

Press the MENU button to finish

Reset

Reset resets all Sound Adjustments (Bass, Treble, Balance, Turn On Volume and Volume Limit) at once to the default settings. See page 57 on how to use reset.

Onscreen Menus

Set Clock

The set clock function is described on page 25 as the interactive plug-in menu. You can choose to set the clock automatically or manually. If you need to set the clock again, follow the steps below.



Press the MENU button



To SET CLOCK



To enter

When you set the clock automatically, choose **AUTO** by pressing the ◀ or ▶ arrows.



To TIME ZONE



To select your time zone

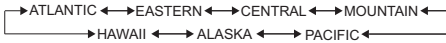

To D.S.T. (daylight savings time)



To turn D.S.T. ON or OFF



Press Ok to finish



Press the MENU button when finished

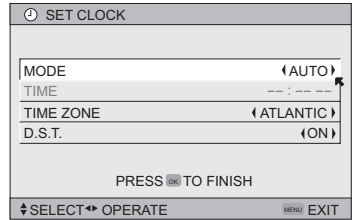

When you set the clock manually, choose **MANUAL** by pressing the ◀ or ▶ arrows.



To move to the hours



To set the hours



To move to minutes



To set the minutes



To TIME ZONE



To select your time zone:

(Atlantic, Eastern, Central, Mountain, Pacific, Alaska or Hawaii)



To D.S.T. (daylight savings time)



To turn D.S.T. ON or OFF



Press Ok to start clock

THANK YOU !!



Press the MENU button when finished

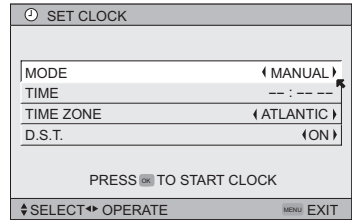

Notes:

- D.S.T. can be used when it is set to ON in the SET CLOCK menu.
- Only when the MODE is set to AUTO, the Daylight Saving Time feature automatically adjusts your TV's clock for Daylight Saving.
- The real time and D.S.T. may not be set correctly depending on the broadcasting signal and receiving conditions. In this case, set your clock manually and turn D.S.T. to OFF.
- You will have to reset the clock after a power interruption. You must set the clock before operating any timer functions.

Onscreen Menus

On/Off Timer

The on/off timer lets you program your television to turn itself on or off. You can use it as an alarm to wake up, to help you remember important programs, or as a decoy when you're not home.



Press the MENU button



To ON/OFF TIMER



To enter (begins with ON TIME)



To set the hour (AM/PM) you want the TV to turn on



To move to minutes



To set the minutes



To accept ON TIME and move to OFF TIME (the time the TV will turn off). Set the OFF TIME the same way as ON TIME



To accept OFF TIME and move to CHANNEL



To select channel



To ON VOLUME



To set the volume level



To move to MODE



Choose ONCE or EVERYDAY



To ON/OFF TIMER



Choose YES to accept the timer setting, choose NO if you don't wish to accept



Press the OK button to finish



Press the MENU button to exit the menu

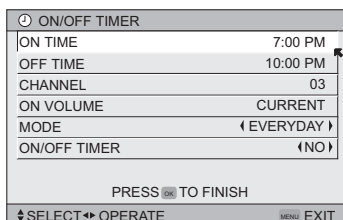

Notes:

- The on/off time cannot be set to locked or guarded channels.
- In order for the on/off timer to work, the clock must be set.
- After a power interruption, the timer settings must be reset.
- The digital channel is set only set to the marked channel in channel summary.
- The blocked channel cannot be set.

Lamp Timer Reset

The lamp replacement message will appear when you need to change the lamp. After you replace the lamp, you need to reset the timer which is built into your television.



Press the MENU button



To LAMP TIMER RESET



To Enter

The following message will appear.

PRESS OK TO RESET THE LAMP
TIMER.



Press the OK button while the above message appears on the television screen.

THE LAMP TIMER IS RESET
SUCCESSFULLY.

The lamp timer has now been reset.

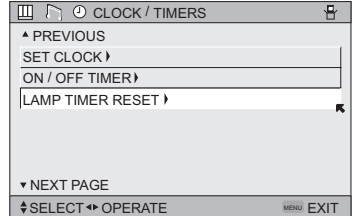

Notes:

- You can use the Lamp Timer Reset only after replacing the lamp.
- See Page 75 for instructions on lamp replacement.

Button Functions

Multi Screen Function

Your television has two kinds of screen: SPLIT (2 channels) and INDEX (12 channels).

Note: After you press any multiscreen buttons, if you press the menu button, only the picture adjust screen will appear.

Split

Activate the split-screen option by pressing SPLIT on the remote control. The channel (or input) you were watching before pressing SPLIT will appear on the left, the new channel will appear on the right. The sound will continue to come from the main screen channel (or input). To turn split-screen off and return to normal television viewing, press SPLIT again or press the BACK button.

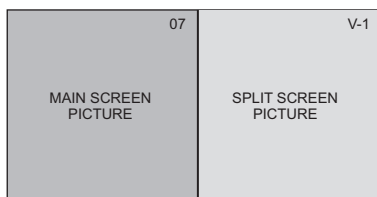

Notes:

- If the signal that you are watching is coming from the HDMI input, you cannot enter the SWAP or INDEX mode.
- Main Screen and Split Screen will not display the same channel or input at the same time.
- Split screen will not display digital channel.
- You can enter the SPLIT mode when the screen is in NORMAL or INDEX mode.
- Split-screen functions will not work with locked channels or channels blocked by V-Chip ratings limits. A gray screen will display instead.
- With split screen, the picture from the component terminal and DIGITAL-IN terminal will not be displayed.
- The aspect of MAIN CHANNEL PICTURE becomes 16:9 when you input the picture of 480p, 720p and 1080i from the component terminal and DIGITAL-IN terminal.
- After you press the SELECT button, and select SPLIT SCREEN when you press the OK button, select normal screen. If you don't operate, the MAIN CHANNEL SCREEN will be automatically selected about 8 seconds later.
- Aspect does not work in Split mode.
- When it is PC output, Main and Split screen will not be displayed.
- When you are in PC mode, SPLIT, INDEX or FREEZE can not be used.
- When you press the Menu button in Split mode, it appears only as Picture Adjust menu.

Button Functions

Index

This allows you to quickly look at up to 12 channels at a time so that you can decide which one to watch.

1	2	3	4
5	6	7	8
9	10	11	12

Notes:

- Only analog channel input signal will be displayed.
- You can watch the channel added in channel summary. See page 35.

Freeze

Pressing the FREEZE button causes the screen to change to the split-screen display with the still picture displayed on the right. In order to return to the normal display, press the FREEZE button once again.

Swap

You can exchange the channel (or input) displayed in the split screen window for the main screen image by pressing the SWAP button.

Note:

- It will only work in SPLIT mode.

Select

With SELECT, you can select the picture (channel) while viewing SPLIT screen. When you press SELECT button, the channel number on the top will be highlighted. Each press of SELECT will shift the channel.

Menu

The MENU button allows you to access JVC's onscreen menu system. Press MENU to activate the onscreen menu system.

- See individual topics like "Sound Adjust" for specific information on using menus.

OK

This button confirms your selection when you are in one of the onscreen menus.

Back

This button allows you to go back in the menu to change a selection or correct a mistake.

Button Functions

Power

Turns the TV on or off.



Press the POWER button

Note:

- After turning the power on, you can not turn the power off for about one minute.

Number Buttons - 10Key Pad

Use the number buttons on the remote control to move directly to a specific channel. For example, to move to channel 12:



0 (Zero)



1 (One)



2 (Two)

Tune

Lets you decide the input channel and select it. After you press the number buttons on the remote, press the TUNE button. For example, to move to channel 12:



1 (One)



2 (Two)



Press the TUNE button

Input

Selects the signal input source for the television: VIDEO-1, 2, 3, 4, DIGITAL-IN1 or DIGITAL-IN2 for video devices like VCRs, DVD players or camcorders.



Press the INPUT button

By every press of the INPUT button, you can change the input mode.

Notes:

- When you return to TV mode, press the RETURN +/TV button or direct 10 key pad or CHANNEL +/- button.
- You can also access by pressing the INPUT button on the side of the TV instead of the remote control.
- If you have a PC connected to the TV, select VIDEO-3.

TheaterPro D6500K

The TheaterPro D6500K color temperature technology function makes sure that the video you watch is set to the standard color temperature, so that what you see is as true to what the film to video editors intended it to be.



Press the THEATERPRO button

Button Functions

Return +/-TV

The RETURN+/TV button has three functions:

Return - Returns to the channel viewed just before the channel currently onscreen.

Return+ - Lets you program a specific channel to return to while scanning through the channels using the CH+ and CH- buttons.

TV - Returns to the TV mode.



Press the RETURN+/TV and hold for three seconds

RETURN CHANNEL
PROGRAMMED!

The channel currently active has been programmed as your return+ channel. Now scan through the channels using the CHANNEL+/- buttons.



Press the RETURN+/TV

You will return to your programmed channel.

- To cancel your return+ channel, press and hold the RETURN+ button for three seconds. The message "RETURN CHANNEL CANCELLED!" will appear.
- Return+ works only with the Channel+/- buttons. Pressing any number key will cancel return+.

Sound

By pressing the SOUND button, you can change the A.H.S.+ (Advanced Hyper Surround plus) mode, A.T.C. (Advanced Tone Correction), SMART SOUND and MaxxBass on or off.

A.H.S.+ - Adds a more spacious surround sound. Music gives basic effect and movie for more effect.

A.T.C. - Reproduces distinctive sounds with tone correction.

SMART SOUND - Decreases high sound levels, giving a regulated sound level.

MaxxBass - Emphasizes the bass sound.



Press the SOUND button



To select A.H.S.+, A.T.C., SMART SOUND or MaxxBass



To choose the setting



Press the MENU when finished

SOUND EFFECT	
A.H.S.+	MOVIE MUSIC OFF
A.T.C.	ON OFF
SMART SOUND	ON OFF
MaxxBass	HIGH LOW OFF
SELECT OPERATE MENU EXIT	

MaxxBass is a registered trademark of Waves Audio Ltd. in the USA, Japan and other countries.

Notes:

- Smart Sound may become an unnatural effect, depending on the signal source.
- You can adjust BALANCE only when A.H.S.+ is off.

Button Functions

Video Status

The VIDEO STATUS button gives you a choice of four TV picture display settings, including a display of your own preferences.

Standard - Resets the picture display to the factory settings.

Dynamic - Gives a vivid picture with better contrast when viewing in a brightly lit room.

Theater - Gives a rich, film-like look to video when viewing in a dimly lit room.

Game - Used for when you are playing video games connected to your TV.

VIDEO STATUS
STANDARD
DYNAMIC
THEATER
GAME



Press the VIDEO STATUS button

By every press of the VIDEO STATUS button, you change the mode.

Note:

- You can also change the mode by pressing the ▲▼ buttons.
- Each mode is memorized for each input connected to the TV.
- You can also access the FRONT PANEL CONTROL screen by using the MENU button on the side of the TV instead of the remote control. It appears between INITIAL SETUP and PICTURE ADJUST screen, and it has VIDEO STATUS and ASPECT menus. Choose VIDEO STATUS by pressing MENU ▼ on the side panel and choose a mode by using the CHANNEL +/- buttons (◀ OPERATE ▶).
- There are four video status settings: Dynamic, Standard, Theater and Game. Each video status setting has a separate memory for HD (1080i/720p) and SD (480p/480i) video signal. Each video status can be chosen along with your favorite picture settings (Tint, Color, Picture, Bright, Detail, etc.)
 - When an HD signal is displayed: Your HD settings are recalled for the video status you are using.
 - When an SD signal is displayed: Your SD settings are recalled for the video status you are using.
 - This function considers PC input as an HD signal and PIP and SPLIT screens as an SD signal.

Natural Cinema

Natural cinema corrects the problem of blurred edges which may occur when viewing a program originally shot on film (such as motion pictures) or animation. If you notice blurring at the edges of these programs, press NATURAL CINEMA and set it to AUTO. Natural Cinema helps correct conversion errors that occur when film, which is shot at 24 frames-per-second, is broadcast at the television rate of 30 frames-per-second.



Press the NATURAL CINEMA button

NATURAL CINEMA
AUTO
ON
OFF

Notes:

- The natural cinema mode is automatically set to "AUTO" in the following cases:
 - Turning on or off
 - Changing the channel or input mode
 - Using multi-screen functions
- If you are in PC mode, Natural Cinema can not be used.

Button Functions

Sleep Timer

The Sleep Timer can turn the TV off for you after you fall asleep. Program it to work in intervals of 15 minutes, for a total time of up to 180 minutes.



Press the SLEEP button



Sleep Timer Message

60 seconds before the automatic shutoff, this message will appear:

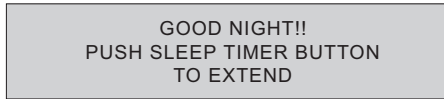

You then have 60 seconds to press the SLEEP button to delay the shut off for another 15 minutes.

ML/MTS

MTS technology allows several audio signals to be broadcast in analog at once, giving you a choice in what you wish to hear with a TV program. In addition to mono or stereo sound, an MTS broadcast may also include a second audio program (SAP).



Press the ML/MTS button

By every press of the ML/MTS button, you change the mode

	MTS
ON AIR	STEREO
ON AIR	SAP
	MONO

Notes:

- When you are receiving a digital broadcast, if there are other languages, you can change the language by pressing the ML/MTS button.
- Keep the TV in stereo mode to get the best sound quality. The sound will work in stereo mode even if a certain broadcast is in mono sound only.
- Choose the mono setting to reduce excessive noise on a certain channel or broadcast.
- Selecting SAP will allow you to hear an alternative soundtrack, if one is available.
- MTS unavailable if your television's Input source is in VIDEO-1, 2, 3, 4, DIGITAL-IN1 or DIGITAL-IN2 mode, as described on page 64.
- ML/MTS will not work when you are using the Digital-In.
- You can also change the mode by pressing the ▲▼ buttons.

Muting

The MUTING button instantly turns the volume down completely when you press it. Press MUTING and the volume level will instantly go to zero. To restore the volume to its previous level, press MUTING again.

Button Functions

Display

The display screen shows the current status of timers, inputs and XDS ID.



Press the DISPLAY button

The screen to the right shows the following information:

- The current channel or AV input (Channel 05)
- The current time (12:20 pm)
- Sleep timer status/minutes remaining (The Sleep Timer is off)
- On/off timer status (Set to turn on everyday at 7:00 PM, off at 10:00 PM)
- Each Press of the DISPLAY button changes the display mode:

05	KL VX	PBS	
	JAZZ	FESTIVAL	
	NOW		12:20 PM
	SLEEP	TIMER	OFF
	ON/OFF	TIMER	EVERYDAY
	ON	TIME	7:00 PM
	OFF	TIME	10:00 PM

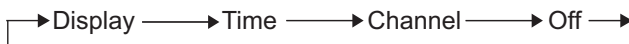

Display - Full screen shown above

Time - Shows the current time only

Channel - Shows the current channel

Off - Turns display off

Notes:

- You may also turn off the display at any step by pressing MENU.
- If the clock, sleep timer or on/off timer are not set, the display screen will show: "CLOCK NOT SET", "SLEEP TIMER OFF", and "ON/OFF TIMER OFF" respectively.

C.C. (Closed Caption)

Use the C.C. (Closed Caption) button to select the mode of closed caption.



Press the C.C. button

Notes:

- SMART CAPTION will appear when you press the MUTE button, only on channels where the broadcast contains closed captioning.
- When you select ON, it will be the mode selected in the Closed Caption Menu.
- See page 45 when you set the caption/text mode.
- You can also change the mode by pressing the ▲▼ buttons.
- If you are in PC mode, C.C. can not be used.

CLOSED CAPTION	OFF
SMART CAPTION	ON

Channel +/-

Use these buttons to move up or down all the available channels your TV is able to receive.

Volume +/-

Use these buttons to raise or lower the TV's volume level. The maximum is the level you set in Volume Limit. See page 58.

Button Functions

Favorite

The Favorite button allows you to select your favorite channels easily. First, you must register the channels that you like. See how to register below.



Press the FAVORITE button
The favorite channel list will appear.



To select the channel you want to watch



Press the Ok button
It will change to the channel you have selected.

FAVORITE	
▲ PREVIOUS	
101	CBS
102	FOX
D103	PBS2
<	>
D107	HBO
8	ABC
▼ NEXT	

Register the favorite channel



Press the channel number you want to register
The channel program will change.



Press the FAVORITE button for three seconds
The channel will be registered in the favorite channel list.

Notes:

- Both analog and digital channels can be registered. The digital channels have a "D" in front of the channel number.
- The maximum number of channels you can register is 24.
- If you have registered the maximum number of channels, and try to register more channels, the oldest channel you registered will be deleted.
- Sub channels can not be registered.
- The newest channel you registered will appear at the top of the list.

Delete the favorite channel



Press the FAVORITE button
The favorite channel list will appear.



To select the channel you want to delete



To enter



Press the Ok button
The channel was deleted.



Press the FAVORITE button when finished

Note:

- Before pressing the FAVORITE button when you are finished, press the ◀▶ button again, and you can return to the deleted channel.

Button Functions

Aspect

This feature will help you adjust the picture you are watching to give you the best possible picture quality.

Aspect Ratios

PANORAMA - With this ratio a normal 4:3 aspect picture is stretched to fit the dimensions of the 16:9 aspect screen.

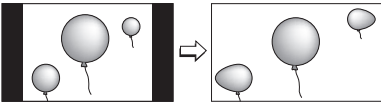

CINEMA - This ratio "zooms in" on the center part of a 4:3 aspect picture, blowing it up to fill the 16:9 screen.



FULL - This is the ratio to use when watching 16:9 High-Definition broadcasts.

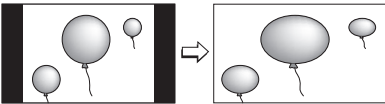

PANORAMA ZOOM - This ratio stretches the High-Definition 16:9 aspect image to eliminate the black side bars.

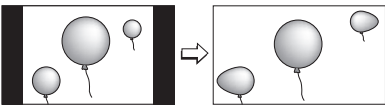

CINEMA ZOOM - This ratio stretches the High-Definition 16:9 aspect image to eliminate the black surrounding bars.



REGULAR - The regular ratio is used when you want to watch a 4:3 broadcast or recorded program without modifying the original picture to fit the dimensions of your 16:9 screen. The 4:3 picture will fill the screen from top to bottom, while black bars will appear to fill up the remaining space along the picture's sides. The 4:3 picture will be centered within the boundaries of the 16:9 screen.

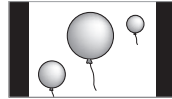

SLIM - This aspect mode shrinks the screen of 16:9 to 4:3. There are some programming that is already stretched by mistake at broadcasting companies, so this mode corrects it. Black side bars will appear.

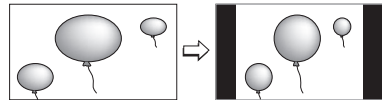

Aspect Ratios in PC Mode

REGULAR - This is the original aspect mode.

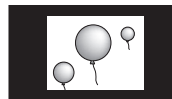

FULL - This aspect mode stretches the image to fit the dimensions of the 16:9 aspect screen.

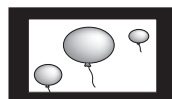

Button Functions

Aspect Ratios (Continued)



Press the ASPECT button

- By pressing the ASPECT button, you can change the size.

When you change the aspect ratios, it is different from their broadcast or recorded program.

SD (480i, 480p)
NTSC, 480i, 480p

ASPECT
PANORAMA
CINEMA
FULL
REGULAR

HD (1080i, 720p)
ATSC (1080i, 720p)

ASPECT
PANORAMA ZOOM
CINEMA ZOOM
FULL

ATSC (480i, 480p)

ASPECT
PANORAMA ZOOM
CINEMA ZOOM
FULL
SLIM

PC

ASPECT
FULL
REGULAR

Notes:

- You can also choose the size by pressing the ▲▼ buttons.
- When you change the aspect ratio or signal, reset the picture position to center.
- You can also access the FRONT PANEL CONTROL screen by using the MENU button on the side of the TV instead of the remote control. It appears between INITIAL SETUP and PICTURE ADJUST screen, and it has VIDEO STATUS and ASPECT menus. Choose ASPECT by pressing Menu ▼ on the side panel and choose a mode by using the CHANNEL +/- buttons (◀ OPERATE ▶).
- "SLIM" can only be displayed when the signal is ATSC (480i or 480p).
- If the television receives a 16:9 signal from your HDMI device, the aspect mode will turn to FULL automatically. If the television receives a 4:3 signal from your HDMI device when you are in FULL aspect mode, it will return to REGULAR aspect mode. If you change the aspect mode after the television changed it to FULL automatically, the television will change to the aspect mode you chose.

Button Functions

TV/CATV Slide Switch

Use either the television's own tuner or a cable box to select channels. Set this switch to **TV** to operate the television's built-in tuner. Move the switch to **CATV** to operate a cable box.

Note:

- See page 27 for information on programming your remote for cable box operation.

VCR/DVD Slide Switch

You can control a VCR or DVD player with the buttons on the lower part of the remote control. Move the slide switch to **VCR** or **DVD** to operate.

Notes:

- The remote is preset with the code 000 to control JVC-brand VCR's. For any other manufacturer's brand VCR, please see the code chart and instructions on page 28.
- The remote is preset with the code 000 to control JVC-brand DVD players. For any other manufacturer's brand DVD player, please see the code chart and instructions on page 29.

VCR Buttons

You can use this remote control to operate the basic functions of your VCR. These functions include: play, record, rewind, fast-forward, stop, pause, channel scan, TV/VCR, power on and power off.

Move the selector switch to **VCR** to operate.

- The remote is preset with the code 000 to control JVC-brand VCR's. For any other manufacturer's brand VCR, please see the code chart and instructions on page 28.

DVD Buttons

You can also use this remote control to operate the basic functions of your DVD player. These functions include: play, rewind, fast-forward, stop, still/pause, previous/next, tray open/close, power on and power off.

Move the selector switch to **DVD** to operate.

- The remote is preset with the code 000 to control JVC-brand DVD players. For any other manufacturer's brand DVD player, please see the code chart and instructions on page 29.

Light

Your remote control includes illuminated buttons for key features like CHANNEL +/- and VOLUME +/- . Press the LIGHT button to turn the illumination on for 5 seconds.

Button Functions

D/A (Digital/Analog)

The D/A button changes the analog and digital channel. Each time you press the D/A button, you can switch back and forth the analog and digital channels. Digital channels have a "D" in front of the channel number.



Press the D/A button

To watch digital channels

For example, to move to channel D23:



Press 2 (Two)



Press 3 (Three)



Press the TUNE button

Sub Channel

The main channel sometimes has minor channels (Sub Channels). By using the SUB CHANNEL button, you can select a sub channel easily.

For example, to move to sub channel 123-45:



Press 1, 2 and 3 in order



Press the SUB CHANNEL button



Press 4 and 5 in order



Press the TUNE button

Note:

- If there are more than 2 major channels, select the digital channel by using the ▲▼ buttons and then press the Ok button.

Guide

You can view the program from the GUIDE.

Notes:

- The GUIDE function will only work when you are receiving digital programming only.
- The GUIDE will not show the correct time and date if you have not performed the set clock function on your television. See page 59.

OSD Information

Weak Signal

This OSD warning appears when the digital channel that you have selected is too weak to receive or no signal is being detected for that channel.

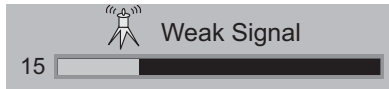

No Program

If the TV channel you selected, or were watching is not receiving a signal, "NO PROGRAM" appears on the television screen. It appears when that channel is not receiving a signal and you have the Noise Muting function OFF and you have a single screen. It moves automatically every two seconds to prevent the screen from burn-in.

Note:

- Even if "NO PROGRAM" appears on the screen, your timer functions and auto shut off functions that you set, are still active.

Invalid Signal

If you are inputting a PC signal that is invalid, "Invalid Signal" will appear on the TV screen. It appears when the input is PC and it is a single screen.

Lamp Replacement

Changing the Lamp

WARNING!

It is very important that you **NEVER TOUCH THE GLASS SURFACE OF THE NEW LAMP**. Touching the glass surface will deposit oils from your hand onto the lamp surface. When the lamp heats up to its operating temperature, the oil will cause a difference in temperature on the lamp surface that will likely cause the lamp to break.

Replace the lamp with part number TS-CL110U only! The television is designed to work specifically with this lamp. Using a different lamp, or a third-party manufacturer's lamp could cause a malfunction and or damage to the television.

This television uses a 110-Watt high-pressure mercury lamp to project images onto the television screen. When the lamp nears the end of its operating life, you may notice the picture becoming dark. When the picture begins to darken, or the lamp burns out, it is time to replace the lamp. The following instructions will tell you how to safely replace the lamp.

WARNING!

Under operating conditions, THE LAMP WILL GET EXTREMELY HOT AND WILL CAUSE SEVERE BURNS IF TOUCHED.

Before attempting to replace the lamp, make sure the television has completely run through its cooling cycle. Turn the power off and wait until the LAMP LED blinks very slowly and turns off completely. Unplug the TV. If you feel any warmth as you place your hand near the lamp, **DO NOT TOUCH IT**. Wait until the lamp has completely cooled before attempting to replace it. After turning the power off, wait at least 1 hour or more.

NEVER attempt to replace the lamp with the television plugged into a wall outlet. Attempting to replace the lamp with the TV plugged in could lead to a severe electrical shock.

Do not keep the TV on for more than 24 hours consecutively. There is the possibility of the life of the lamp being shortened.

The life of the lamp changes depending on the atmospheric temperature and altitude in which the TV is being used.

Please read these instructions fully before attempting to replace the lamp. If you feel unsure about replacing the lamp yourself, call a service technician.

Lamp Replacement

Replacement Lamp Kit

Before replacing the lamp, you will need to purchase a replacement kit, part number TS-CL110U. To purchase this kit, consult your dealer or call 1-800-252-5722, or go to www.jvc.com.

The replacement kit will include the following:

1 High-Pressure Mercury Lamp

1 Instruction Manual

Because the lamp contains a small amount of mercury, it cannot be disposed of with normal trash.

Lamp Message

LAMP NEEDS TO BE REPLACED.
REFER TO OWNER'S MANUAL FOR
REPLACEMENT INSTRUCTIONS.

AFTER REPLACING THE LAMP,
PLEASE RESET TIMER IN THE TV
MENU.

PRESS OK, IF YOU DO NOT WANT
TO SEE THIS MESSAGE AGAIN.

If this message appears when you turn the TV on, you need to replace the lamp. See page 77 on how to replace the lamp.

Note:

- This message will appear every time you turn on the TV when the lamp needs to be replaced. Press the OK button to make the message disappear, or replace the lamp.

Lamp Replacement

How to Replace the Lamp

Please read these instructions fully before attempting to replace the lamp. If you feel unsure about replacing the lamp yourself, call a service technician. Please observe all safety warnings.

1) Turn off the television.

Press the POWER button on the remote control or TV front panel. Wait until the picture has closed and the LAMP LED on the front panel has stopped blinking indicating the lamp cool down is complete.

Warning: The cool-down process cools the lamp from its operating temperature. This does not mean that the lamp will now be cool enough to handle safely. We strongly recommend you wait at least one hour before proceeding.

2) Unplug the television.

Disconnect the power cord from the AC outlet. Make sure that the LAMP LED light has stopped blinking before you unplug the set. Never attempt to replace the lamp with the television plugged in.

3) Remove the lamp cover.

The lamp is located behind the lamp cover below the left side of the television. To access the lamp you will need to remove the lamp cover. First, remove the screw located on the lamp cover using a Philips head type screwdriver (cross-head type). Once the screw has been removed, gently pull the knob towards you and the panel will come away from the television. Set it aside.

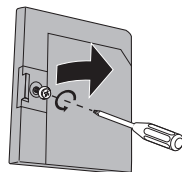

WARNING: DO NOT attempt to remove the assembly until the lamp has fully cooled. If you feel any heat near the lamp, STOP and wait until the lamp has FULLY COOLED.

NEVER attempt to remove the lamp with the television plugged into an outlet.

DO NOT DROP the used lamp. The inside of the lamp is under pressure. Dropping or other hard shock could cause the lamp to shatter.

ALWAYS recycle the used lamp. Because the lamp contains a small amount of mercury, it cannot be thrown away with regular trash. Follow the recycling instructions included with the Lamp Replacement Kit.

4) Remove the lamp unit.

Using a Philips head type screwdriver (cross-head type), loosen the two screws fastening the lamp unit. When the screws have been loosened, remove the lamp by raising the handle and gently sliding the unit straight towards you. Place it carefully in the recycling packaging.

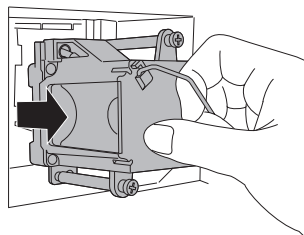
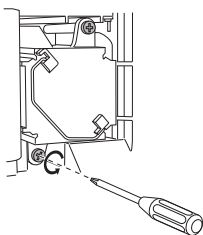

Lamp Replacement

5) Install the new lamp unit.

Holding the handle attached to the new lamp unit, slide and push the new lamp straight into the television and back into the lamp housing area. **Do not forget to re-tighten the two screws.**

Note: If the lamp does not sit securely in the TV (flat in the lamp housing area), it won't turn on. Make sure the lamp sits securely and flat in the housing area.

WARNING!

Remember it is very important that **YOU DO NOT TOUCH THE LAMP SURFACE.** Please read the warnings on page 75 again.

Also, replace the lamp with part number TS-CL110U only! The television is designed to work specifically with this lamp. Lamps other than TS-CL110U may cause malfunctions and/or other damage to the television.



NOTICE (for USA)

This product has a High Intensity Discharge (HID) lamp that contains a small amount of mercury. It also contains lead in some components. Disposal of these materials may be regulated in your community due to environmental considerations. For disposal or recycling information, please contact your local authorities, or the Electronics Industries Alliance: <http://www.eiae.org>

To purchase a replacement lamp kit, please call 1-800-252-5722.

6) Re-install the lamp cover.

Insert the lamp cover in the right concave and close the lamp cover. Because the lamp cover has a role to help prevent the danger of an electrical shock, tighten the screw using your fingers.

Note:

- After installing the new lamp unit, do not forget to reset the lamp timer. See page 61.

Lamp Replacement

Warning LED Messages

While the power is on, and there is a problem with the TV, the TV changes to warning mode and informs you of the problem using the LED as follows. Then, the power turns off automatically and performs the cooling for approximately 90 seconds.

The LAMP LED blinks

Condition: It may be a malfunction of the internal electrical circuits.

To correct: Keep the TV off for a while and then turn the power on again. If the TV goes into warning mode, unplug the TV after the cooling has completed and consult your dealer.

The POWER LED and LAMP LED blink alternately

Condition: The inside temperature rises abnormally or the fan may be blocked.

To correct: Keep the TV off for a while and then turn the power on again. If the TV goes into warning mode, unplug the TV after the cool down as completed and consult your dealer.

The POWER LED and LAMP LED blink rapidly simultaneously

Condition: The lamp unit has been installed on a slant and is not flat, or it is not fully inserted into the lamp housing. Or it may be a lamp malfunction.

To correct:

- If this condition occurs soon after replacing the lamp: Reinstall the new lamp unit. Repeat the lamp installation steps, taking care to observe all warnings. Make sure the lamp sits FLAT inside the unit when you reinstall it.
- If this condition occurs except for replacing the lamp: Keep the TV off for a while and then turn the power on again. If the TV goes into warning mode, unplug the TV after the cool down as completed and consult your dealer.

Troubleshooting

PROBLEMS	CHECK
There is no power	<ul style="list-style-type: none"> • See if the power cord became unplugged. • Check for a blown fuse or circuit breaker or a power outage. • It is possible the fan is stuck or the inside temperature is rising abnormally. Consult your dealer.
There is no picture or sound	<ul style="list-style-type: none"> • The antenna could be disconnected. • The input mode could be set improperly. See page 64. • The tuner (Auto Tuner Setup) could be set improperly. See page 34. • The TV station may be having difficulties. Check to see if other stations are working. • Use the HDMI cable with HDMI logo HDMI. See page 20. • You can not output audio using the AUDIO OUTPUT under the following conditions: <ol style="list-style-type: none"> 1) When you have digital sound from an HDMI device connected to the HDMI 1 or HDMI 2 connection on the back of your TV. (See page 20). 2) When you have analog sound from a DVI device connected to the AUDIO IN "HDMI 1" connection. (See page 19). • When you have an HDMI device connected to the HDMI 1 connection on the back of your TV, your TV detects it, and blocks the analog audio signal coming into the "HDMI 1" jacks. Therefore, you can not hear any analog sound from the other device connected to the "HDMI 1" jacks, while you are viewing the images from the HDMI device. (See page 20).
Remote control is not operating properly or at all	<ul style="list-style-type: none"> • Check to see that the batteries are still working and properly installed. • Make sure the remote has a clear sight path to the TV. • Check that the TV/CATV switch is in the proper position. • You may be too far from the TV. You must be within 23 feet (7 meters).
You cannot select a certain channel	<ul style="list-style-type: none"> • Make sure the channels have been programmed. See "Channel Summary", page 35. • Check to see if the channel is locked. See "Channel Summary - Lock" page 36.
The power turns off by itself	<ul style="list-style-type: none"> • Make sure the set did not become unplugged. • Perhaps the On/Off Timer is set. See page 60. • Check to see if the Sleep Timer was set. See page 67.
It does not operate correctly	<ul style="list-style-type: none"> • This television is operated by a microprocessor. It is possible that external noise or interference is causing the problem. If the television does not function correctly, remove the electrical plug from the wall outlet and wait a while before inserting it into the wall outlet again and operating the television.
The clock is wrong	<ul style="list-style-type: none"> • The power was interrupted and the clock was not reset. See page 59.
The color quality is poor	<ul style="list-style-type: none"> • Tint and Color may be improperly adjusted. See page 55. • The Video Status mode may be turned to the wrong setting. See page 66.
There are lines across the picture	<ul style="list-style-type: none"> • There could be interference from another electrical appliance, such as a computer, another TV or VCR. Move any such appliances further away from the TV.
The picture is spotted	<ul style="list-style-type: none"> • There could be interference from a high-wattage appliance, like a hairdryer or vacuum, operating nearby. Move the antenna away from the appliance or change to a coaxial cable connection which is less prone to interference.
There are double pictures (ghosts)	<ul style="list-style-type: none"> • A building or passing airplane can reflect the original signal and produce a second, slightly delayed one. Adjust your antenna position.
Picture is snowy (image noise)	<ul style="list-style-type: none"> • Your antenna may be damaged, disconnected or turned. Check the antenna connection. If the antenna is damaged, replace it.
Screen is 80% black	<ul style="list-style-type: none"> • The Closed Caption Text mode is on. Turn it off in the Closed Caption Menu, page 45.
Stereo or bilingual programs can't be heard	<ul style="list-style-type: none"> • Make sure the MTS settings are correct. See page 67.
The POWER LED and LAMP LED are blinking alternately.	<ul style="list-style-type: none"> • It may be a malfunction that the fan is locked or the temperature has increased.
The POWER LED and LAMP LED are blinking rapidly simultaneously.	<ul style="list-style-type: none"> • The lamp may not have been installed correctly, or it may be due to a malfunction. • The lamp door may not be closed correctly.
The LAMP LED continues blinking	<ul style="list-style-type: none"> • It may be a malfunction of the internal electrical circuits.

Troubleshooting

PROBLEMS	CHECK
Static electricity	• It is normal to feel static electricity if you brush or touch the screen.
You hear occasional crackling sounds	• It is normal for the TV to make crackling sounds when first turned on or off. Unless the sound or picture become abnormal, this is fine.

The following are not malfunctions.

- The television may make a creaking sound if the temperature of the room or the temperature inside the television changes. If there is no problem with the screen or sound, then there is no need to worry.
- The lamp may make a noise when it blows, but this is not dangerous.
- The lamp may make a noise when the power is turned on and a picture is displayed on the screen. This noise is caused when the mercury inside the lamp is heated, and is not a malfunction.
- The still parts of a picture may remain on the screen. This is a characteristic of HD-ILA elements and not a malfunction. The picture will disappear over time.
- The operation of this television is not guaranteed below 0°C. If the power is turned on while the temperature is below 0°C, the picture may be disturbed. Use the television when the temperature is 0°C or higher.
- Although the HD-ILA element is manufactured with high-precision technology, please understand that some pixels may be lost or permanently displayed.
- There is a cooling fan built-in to the television. Please understand that this fan will make some noise when the television is on and while cooling.
- Although the picture may be temporarily disturbed and noise may be seen on the screen if the power is turned on immediately after it has been turned off. This is not a malfunction.

Specifications

Model	HD-52G887 HD-52G787	HD-56G887 HD-56G787
Type	HD-ILA Device Projection	
Reception Format	NTSC, BTSC System (Multi-Channel Sound) ATSC Terrestrial, Digital Cable	
Reception Range	VHF 2 to 13, UHF 14 to 69 at ATSC, CATV 135 Sub, Mid, Super, Hyper and Ultra bands at Digital Cable	
	VHF 2 to 13, UHF 14 to 69 CATV 125 Sub, Mid, Super, Hyper and Ultra bands (181 channel frequency synthesizer system) at Analog • Reception of channel A-5 ("95" of the TV set's on-screen cable channel numbers) is not recommended for your TV set.	
Power Source	AC 120V, 60 Hz	
Power Consumption	205W	
Projection Source	110W High-Pressure Mercury Lamp	
Screen Size	52 inch / 132 cm measured diagonally, 16:9 ratio	56 inch / 142.2 cm measured diagonally, 16:9 ratio
Speakers	10 cm round X 2	
Audio Output	Full Range - 10W + 10W	
Antenna Terminal (VHF/UHF, ATSC/DIGITAL CABLE IN)	75 ohms (VHF/UHF)(F-type connector)	
Input 1, 2, 3, 4 Terminal	S (Input 1, 3) Y: 1 Vp-p positive, 75 ohms (negative sync provided) C: 0.286 Vp-p (burst signal), 75 ohms Video: 1 Vp-p, 75 ohms Audio: 500 mVrms (-4dBs) high impedance	
Input 1, 2 Terminal (component terminal)	1080i / 720p / 480p / 480i Y: 1 Vp-p positive, 75 ohms (negative sync provided) Pb/Pr: 0.7 Vp-p 75 ohms	
DIGITAL-IN (HDMI input terminal)	HDMI Jack x 2 • Personal computer compatibility cannot be guaranteed. Video: 1080i / 720p / 480p / 480i / VGA Audio: 2ch PCM, 32 / 44.1 / 48 KHz 16 / 20 / 24 bit	
Audio Output Jacks (FIX)	FIX : 500mVrms (-4dBs) Low impedance (1000 Hz when modulated 100%)	
Optical Output Digital Audio	Digital Out (optical) x 1	
PC Input Jack	Analog RGB D-SUB (15 pin) x 1 • PC signal is available. Refer to page 23 for details on the signals which can be input.	
Dimensions (inch) W X H X D (cm)	48 1/2 x 35 7/8 x 16 3/8 122.9 x 91.1 x 41.5	52 x 38 1/8 x 17 3/8 131.8 x 96.8 x 43.9
Weight (lbs / kg)	84 / 38	90 / 41
Accessories	Remote control unit x 1 / AA batteries X 2	

Specifications subject to change without notice.

- The open source software is embedded in this product. For more information, please go to: http://software.jvc.com/opensource/Inx/DP/05_AtscQam/download.html

Specifications

Model	HD-61G887 HD-61G787	HD-70G887
Type	HD-ILA Device Projection	
Reception Format	NTSC, BTSC System (Multi-Channel Sound) ATSC Terrestrial, Digital Cable	
Reception Range	VHF 2 to 13, UHF 14 to 69 at ATSC, CATV 135 Sub, Mid, Super, Hyper and Ultra bands at Digital Cable	
	VHF 2 to 13, UHF 14 to 69 CATV 125 Sub, Mid, Super, Hyper and Ultra bands (181 channel frequency synthesizer system) at Analog • Reception of channel A-5 ("95" of the TV set's on-screen cable channel numbers) is not recommended for your TV set.	
Power Source	AC 120V, 60 Hz	
Power Consumption	205W	
Projection Source	110W High-Pressure Mercury Lamp	
Screen Size	61 inch / 154.9 cm measured diagonally, 16:9 ratio	70 inch / 177.8 cm measured diagonally, 16:9 ratio
Speakers	10 cm round X 2	
Audio Output	Full Range - 10W + 10W	
Antenna Terminal (VHF/UHF, ATSC/DIGITAL CABLE IN)	75 ohms (VHF/UHF)(F-type connector)	
Input 1, 2, 3, 4 Terminal	S (Input 1, 3) Y: 1 Vp-p positive, 75 ohms (negative sync provided) C: 0.286 Vp-p (burst signal), 75 ohms Video: 1 Vp-p, 75 ohms Audio: 500 mVrms (-4dBs) high impedance	
Input 1, 2 Terminal (component terminal)	1080i / 720p / 480p / 480i Y: 1 Vp-p positive, 75 ohms (negative sync provided) Pb/Pr: 0.7 Vp-p 75 ohms	
DIGITAL-IN (HDMI input terminal)	HDMI Jack x 2 • Personal computer compatibility cannot be guaranteed. Video: 1080i / 720p / 480p / 480i / VGA Audio: 2ch PCM, 32 / 44.1 / 48 KHz 16 / 20 / 24 bit	
Audio Output Jacks (FIX)	FIX : 500mVrms (-4dBs) Low impedance (1000 Hz when modulated 100%)	
Optical Output Digital Audio	Digital Out (optical) x 1	
PC Input Jack	Analog RGB D-SUB (15 pin) x 1 • PC signal is available. Refer to page 23 for details on the signals which can be input.	
Dimensions (inch) W X H X D (cm)	57 3/8 x 41 1/8 x 18 5/8 145.6 x 104.2 x 47	64 1/8 x 46 x 20 1/2 162.6 x 116.7 x 51.9
Weight (lbs / kg)	95 / 43	154 / 70
Accessories	Remote control unit x 1 / AA batteries X 2	

Specifications subject to change without notice.

- The open source software is embedded in this product. For more information, please go to: http://software.jvc.com/opensource/Inx/DP/05_AtscQam/download.html



LIMITED WARRANTY

COLOR TV 1-1

For Canadian model televisions, see separate sheets for Canadian Warranty information.

JVC COMPANY OF AMERICA (JVC) warrants this product and all parts thereof, except as set forth below ONLY TO THE ORIGINAL RETAIL PURCHASER to be FREE FROM DEFECTIVE MATERIALS AND WORKMANSHIP from the date of original purchase for the period shown below. ("The Warranty Period")
FOR DIRECT-VIEW COLOR TELEVISION, PICTURE TUBE is covered for Two(2)years.

Parts	1 YEAR	Labor	1 YEAR
-------	---------------	-------	---------------

THIS LIMITED WARRANTY IS VALID ONLY IN THE FIFTY (50) UNITED STATES, THE DISTRICT OF COLUMBIA AND IN THE COMMONWEALTH OF PUERTO RICO.

WHAT WE WILL DO:

If this product is found to be defective within the warranty period, JVC will repair or replace defective parts with new or rebuilt equivalents at no charge to the original owner. Such repair and replacement services shall be rendered by JVC during normal business hours at JVC authorized service centers. Parts used for replacement are warranted only for the remainder of the Warranty Period. All products may be brought to a JVC authorized service center on a carry-in basis. Color televisions with a screen size of 27" or greater qualify for in-home service. In such cases, a technician will come to your home and either repair the TV there or remove and return it if it cannot be repaired in your home.

WHAT YOU MUST DO FOR WARRANTY SERVICE:

Please do not return your product to the retailer
Instead, return your product to the JVC authorized service center nearest you. If shipping the product to the service center, please be sure to package it carefully, preferably in the original packaging, and include a brief description of the problem(s). Please call 1-800-252-5722 to locate the nearest JVC authorized service center. Service locations can also be obtained from our website <http://www.jvc.com>. If your product qualifies for in-home service, the service representative will require clear access to the product.

If you have any questions concerning your JVC Product, please contact our Customer Care Center at 800-252-5722

WHAT IS NOT COVERED:

- This limited warranty provided by JVC does not cover:
1. Products which have been subject to abuse, accident, alteration, modification, tampering, negligence, misuse, faulty installation, lack of reasonable care, or if repaired or serviced by anyone other than a service facility authorized by JVC to render such service, or if affixed to any attachment not provided with the products, or if the model or serial number has been altered, tampered with, defaced or removed;
 2. Initial installation, installation and removal from cabinets or mounting systems.
 3. Operational adjustments covered in the Owner's Manual, normal maintenance, video and audio head cleaning;
 4. Damage that occurs in shipment, due to act of God, and cosmetic damage;
 5. Signal reception problems and failures due to line power surge;
 6. Video Pick-up Tubes/CCD Image Sensors are covered for 90 days from the date of purchase;
 7. Accessories;
 8. Batteries (except that Rechargeable Batteries are covered for 90 days from the date of purchase);
 9. Products used for commercial purposes, including, but not limited to rental.

There are no express warranties except as listed above.

THE DURATION OF ANY IMPLIED WARRANTIES, INCLUDING THE IMPLIED WARRANTY OF MERCHANTABILITY, IS LIMITED TO THE DURATION OF THE EXPRESS WARRANTY HEREIN.

JVC SHALL NOT BE LIABLE FOR ANY LOSS OF USE OF THE PRODUCT, INCONVENIENCE, OR ANY OTHER DAMAGES, WHETHER DIRECT, INCIDENTAL OR CONSEQUENTIAL (INCLUDING, WITHOUT LIMITATION, DAMAGE TO TAPES, RECORDS OR DISCS) RESULTING FROM THE USE OF THIS PRODUCT, OR ARISING OUT OF ANY BREACH OF THIS WARRANTY. ALL EXPRESS AND IMPLIED WARRANTIES, INCLUDING THE WARRANTIES OF MERCHANTABILITY AND FITNESS FOR PARTICULAR PURPOSE, ARE LIMITED TO THE WARRANTY PERIOD SET FORTH ABOVE.

Some states do not allow the exclusion of incidental or consequential damages or limitations on how long an implied warranty lasts, so these limitations or exclusions may not apply to you. This warranty gives you specific legal rights and you may also have other rights which vary from state to state.

JVC COMPANY OF AMERICA
DIVISION OF JVC AMERICAS CORP. <http://www.jvc.com>

1700 Valley Road
Wayne, NJ 07470

REFURBISHED PRODUCTS CARRY A SEPARATE WARRANTY, THIS WARRANTY DOES NOT APPLY. FOR DETAIL OF REFURBISHED PRODUCT WARRANTY, PLEASE REFER TO THE REFURBISHED PRODUCT WARRANTY INFORMATION PACKAGED WITH EACH REFURBISHED PRODUCT.

For customer use:

Enter below the Model No. and Serial No. which is located either on the rear, bottom or side of the cabinet. Retain this information for future reference.

Model No. : _____	Serial No. : _____
Purchase date : _____	Name of dealer : _____

TO OUR VALUED CUSTOMER ———

THANK YOU FOR PURCHASING THIS JVC PRODUCT.
WE WANT TO HELP YOU ACHIEVE A PERFECT EXPERIENCE.

**NEED HELP ON HOW TO HOOK UP?
NEED ASSISTANCE ON HOW TO OPERATE?
NEED TO LOCATE A JVC SERVICE CENTER?
LIKE TO PURCHASE ACCESSORIES?**

JVC[®] IS HERE TO HELP!
TOLL FREE: 1(800)252-5722
<http://www.jvc.com>

Remember to retain your Bill of Sale for Warranty Service.

————— **Do not attempt to service the product yourself** —————

Caution

To prevent electrical shock, do not open the cabinet.
There are no user serviceable parts inside.
Please refer to qualified service personnel for repairs.

—————

Notes

JVC COMPANY OF AMERICA
Division of JVC Americas Corp.
1700 Valley Road
Wayne, New Jersey, 07470



JVC CANADA, INC.
21 Finchdene Square
Scarborough, Ontario
Canada, M1X 1A7