

myprojectorlamps.com

**The most trusted, dependable name
in projector lamp sales.**



<http://www.myprojectorlamps.com>



<http://www.myprojectorlamps.ca>



<http://www.myprojectorlamps.eu>

The following projector manual has not been modified or altered in any way.

JVC[®]

The Perfect Experience / —

DLA-HD750/DLA-HD350
Full HD D-ILA Home Theater Front Projector

D-ILA[®]





The remarkable performance of JVC's D-ILA front projectors transforms ordinary home cinema into an extraordinary experience!



For those who demand the best and will accept no less than vivid, life-like home cinema entertainment, JVC is proud to introduce two new D-ILA front projectors. Promising exceptional contrast, immaculate color rendition, and remarkably clear images, the DLA-HD750 and DLA-HD350 models look good too — sporting a stylish yet highly functional, glossy black cabinet design. Seeing is believing, so be the first to experience the breathtaking picture quality that these new D-ILA front projectors have to offer and watch your world of home cinema come alive.



©2008 Warner Bros. Entertainment Inc. All Rights Reserved. BATMAN and all related characters and elements are trademarks of and © DC Comics.

Own THE DARK KNIGHT on Blu-ray and DVD 12/9/08

D-ILA®



DLA-HD750/HD350

Full HD D-ILA Home Theater Front Projector

◆ The industry's highest* native contrast ratio of 50,000:1!

Changing the structural design of the optical section from a conventional L-shape to a straight configuration helped to reduce light leakage and by combining this new structure with a highly efficient lamp, a brightness of 900 lumens** was realized. What's more, integrating JVC's proprietary D-ILA device with the wire-grid optical engine provided very high contrast. And, by equipping the newly developed lens with a fixed aperture to help eliminate unnecessary light that reduces contrast levels, it was possible for the DLA-HD750 to achieve the industry's highest native contrast ratio of 50,000:1*.

Thanks to enhanced brightness created by the extended white peak as well as the wider dynamic range for a deeper black, images are vivid and full of depth, making them perfectly suited for all types of content, including movies, music video as well as live concert and sports programs.

* As of September 2008; native contrast of 50,000:1 for home theater projector class (JVC survey).
Native contrast ratio of 30,000:1 for the DLA-HD350.
** 1,000 lumens for the DLA-HD350.

Conventional projector



DLA-HD750

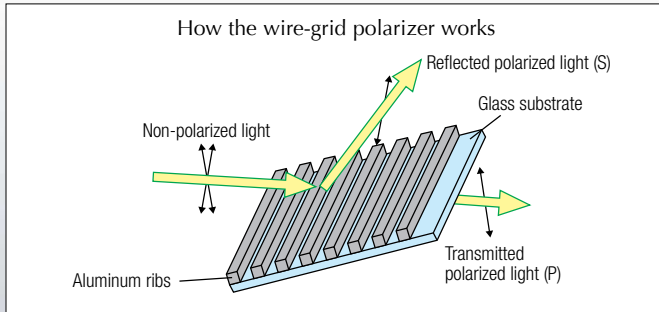
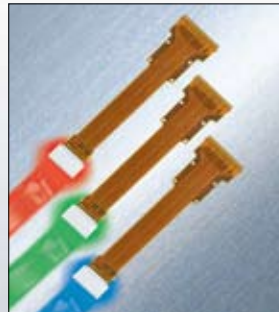

Conventional projector with dynamic iris

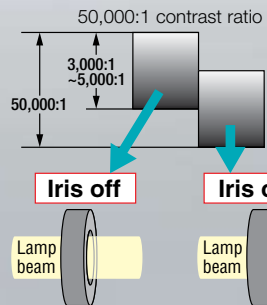

The dynamic iris is opened for bright scenes to make peak values brighter while at the same time making black level lighter than it should be.

The dynamic iris is closed for dark scenes to make black level appear darker while at the same time making peak values darker.

DLA-HD750

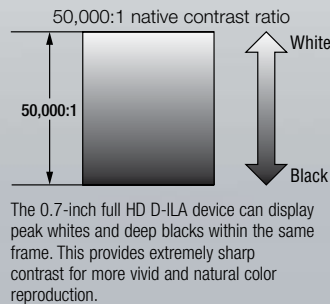

◆ High-performance 2x motorized zoom lens

The newly developed high-performance 2x zoom lens with motorized focus features a large diameter, all-glass lens system with 17 elements in 15 groups that includes 2 ED lenses to project a full HD image with exceptional depth. And to display the deepest black possible, this new high-precision lens is also equipped with a 16-step* lens aperture that allows adjustment of brightness according to user preferences and usage environment. What's more, the high-precision lens also reduces chromatic aberration and color bleeding significantly.

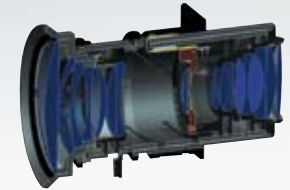

* 3-step for the DLA-HD350.

◆ 6 Point Custom Color Management (DLA-HD750)

The DLA-HD750 features Color Management that interpolates colors individually by R, G, B, C, Y, or M, in three separate axes of color phase, chroma saturation, and brightness. Up to three customized color settings can be stored for future use.



Custom color setup performed via on-screen menu

Before adjustment



After adjustment



◆ Customized gamma control on-screen

Manual adjustment of gamma curve is possible via an on-screen display, allowing the viewer to adjust projector luminance levels by either increasing contrast in scenes that are too dark or dimming washed-out scenes to ensure precise brightness levels suited to individual preferences. Up to three settings can be adjusted and stored for future use.



Custom gamma setup performed via on-screen menu

◆ Advanced video processor

Both projectors incorporate the HQV Reon-VX video processor developed by Silicon Optix. To ensure excellent image reproduction, this processor features precision I/P conversion and scaling with full 10-bit 4:4:4 signal processing as well as an HQV noise reduction function to block mosquito noise.



◆ THX Certified Display (DLA-HD750)



The DLA-HD750 is a THX Certified front projector. With a strict focus on image quality and signal processing performance, THX certification promises that the HD750 is capable of presenting a wide range of video content at maximum resolution with the correct color and luminance levels. In addition, THX certification includes a battery of signal processing tests that challenge the projector's scaling, motion conversion and de-interlacing capabilities. This in-depth analysis and testing ensures that the HD750 will provide exceptional high definition and standard definition performance.

◆ Flexible and easy set-up

Setting up is easier than ever before as the $\pm 80\%$ vertical and $\pm 34\%$ horizontal lens shift function is now electrically operated, allowing the projected picture to be moved horizontally or vertically effortlessly via the remote controller. What's more, the 2x motorized zoom lens — with throw distances of 9.8 feet (3.0 meters) to 20 feet (6.1 meters) for the 100-inch display — makes tedious zoom or focus adjustment easy thanks to its high-performance motor.

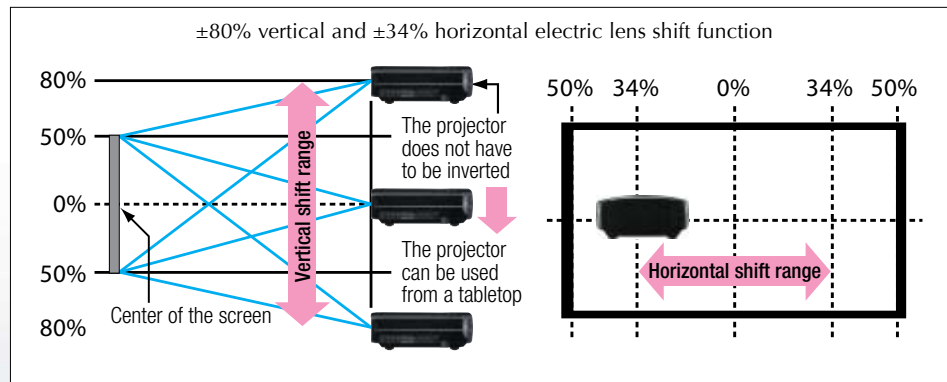

The vertical and horizontal lens shift function cannot be set to the maximum values simultaneously.

Also featured is a unique automatic lens cover that opens and closes with power on/off to protect against dust. So, even if the projector is installed up on the ceiling, you're assured of easy, trouble-free operation via the remote control.



Lens cover closed



Lens cover open

◆ Illuminated remote control

All of the buttons on this full featured remote control light up, making it easy to operate even in a dark room.



◆ Terminal for trigger functions (DLA-HD750)

The DLA-HD750 features a terminal that can be used for two trigger functions. Screen trigger will automatically move the screen up and down with power on/off control while the Anamorphic Lens trigger will automatically move the anamorphic lens to stretch the screen to the 2.35:1 aspect ratio with V-stretch mode on/off.

◆ HDMI interface

Both projectors feature two HDMI (v.1.3) interfaces with CEC compatibility.



◆ Quiet operation

Thanks to the enhanced efficiency of the cooling system, fan noise has been reduced to 19dB*, enabling the viewer to better concentrate on what's being shown on the screen even in a very quiet room.

* When lamp mode set to standard mode.





DLA-HD750

A high-end model achieving the industry's highest* 50,000:1 native contrast ratio for "exceptional true black" reproduction



- Achieves industry's highest 50,000:1 native contrast ratio*
- Achieves a brightness of 900 lumens with a highly efficient lamp
- THX Certified Display model, a certification of excellence
- Color Management function to reproduce the color scheme of choice
- User-adjustable gamma control allows customized calibration for your room environment
- High-performance 2x zoom lens with motorized focus featuring a large diameter all-glass lens system with 17 elements in 15 groups including 2 ED lenses
- 16-step lens aperture for brightness adjustment
- Wide electronic lens shift function of $\pm 80\%$ vertical and $\pm 34\%$ horizontal adjustments
- V-stretch mode, together with an optional anamorphic lens (sold separately), allows for the display of 2.35:1 formatted movies without top and bottom black bars
- Digital Keystone enables easy adjustment of distorted images
- A trigger terminal for activating one of two functions

* As of September 2008; Native contrast ratio of 50,000:1 for home theater projector class (JVC internal survey).

DLA-HD350

A model boasting a native contrast ratio of 30,000:1 for high-resolution picture



- Amazing 30,000:1 native contrast ratio
- Achieves a brightness of 1,000 lumens that allows vivid image reproduction even under indirect lighting environment
- User-adjustable gamma control allows customized calibration for your room environment
- High-performance 2x zoom lens with motorized focus featuring a large diameter all-glass lens system with 17 elements in 15 groups including 2 ED lenses
- 3-step lens aperture for brightness adjustment
- Wide electronic lens shift function of $\pm 80\%$ vertical and $\pm 34\%$ horizontal adjustments
- V-stretch mode, together with an optional anamorphic lens (sold separately), allows for the display of 2.35:1 formatted movies without top and bottom black bars
- Digital Keystone enables easy adjustment of distorted images

Projection Distance Chart

Display size (16:9) Inches and (mm)			Throw distance			
Width	Height	Diagonal	Minimum		Maximum	
			Feet - Inch	Meters	Feet - Inch	Meters
52 1/4	29 3/8 (747)	60 (1523)	5 - 10	1.78	12 - 0	3.66
60	33 3/4 (857)	68 7/8 (1749)	6 - 8 1/4	2.05	13 - 9 1/2	4.20
70	39 3/8 (1000)	80 3/8 (2040)	7 - 10	2.39	16 - 1 1/4	4.91
80	45 (1143)	91 3/4 (2332)	8 - 11 3/4	2.74	18 - 5	5.61
90	50 5/8 (1286)	103 1/4 (2623)	10 - 1 1/2	3.08	20 - 8 3/4	6.32
100	56 1/4 (1429)	114 3/4 (2915)	11 - 3 1/4	3.43	23 - 1 1/2	7.02
110	61 7/8 (1572)	126 1/4 (3206)	12 - 5	3.78	25 - 4 1/4	7.73
120	67 1/2 (1715)	137 3/4 (3498)	13 - 6 3/4	4.13	27 - 8 1/4	8.44
130	73 1/8 (1857)	149 1/8 (3789)	14 - 8 1/2	4.49	30 - 1/4	9.15
140	78 3/4 (2000)	160 5/8 (4081)	15 - 10 1/2	4.84	32 - 4	9.86
150	84 3/8 (2143)	172 1/8 (4372)	17 - 1/2	5.19	34 - 8	10.57
160	90 (2286)	183 5/8 (4663)	18 - 2 1/2	5.55	37 - 1/4	11.28
170	95 5/8 (2429)	195 1/8 (4955)	19 - 4 1/2	5.91	39 - 4 1/4	11.99
174 1/4	98 (2490)	200 (5079)	19 - 10 1/2	6.06	40 - 4 1/4	12.30

*Projection distances are design specifications, so there is ±5% variation.

Specifications

	DLA-HD350	DLA-HD750
Device	0.7inch D-ILA x3	
Resolution	1920 x 1080 pixels	
Lens	2x motorized zoom & focus f=21.4mm - 42.8mm F=3.2 - 4	
Lens shift	±80% Vertical / ±34% Horizontal (motorized)	
Projection size	60 - 200 inches	
Light source lamp	200W UHP	
Brightness	1,000lm	900lm
Contrast ratio	Native: 30,000:1	Native: 50,000:1
Terminals	HDMI (v.1.3) x2 Component x1 (RCA) S-Video x1 (mini DIN) Composite x1 (RCA) RS-232C (D-sub 9-pin)	HDMI (v.1.3) x2 Component x1 (RCA) S-Video x1 (mini DIN) Composite x1 (RCA) PC x1 (D-Sub 15-pin) Trigger x1 (mini jack) RS-232C (D-sub 9-pin)
Video input signal	480i/p, 576i/p, 720p 60/50, 1080i 60/50, 1080p 60/50/24	
PC input signal	Digital Analog	VGA/SVGA/XGA/WXGA+WXGA+/SXGA+WSXGA+WUXGA VGA/SVGA/XGA/WXGA/WXGA+/SXGA/SXGA+WSXGA+
Noise level	19dB (Normal mode)	
Power requirement	AC 110V-240V, 50/60 Hz	
Power consumption	280W (Stand-by mode:1W)	
Dimensions (W x H x D)	14.37" x 6.58" x 18.82"	
Weight	24.25 lbs.	

External dimensions

Top

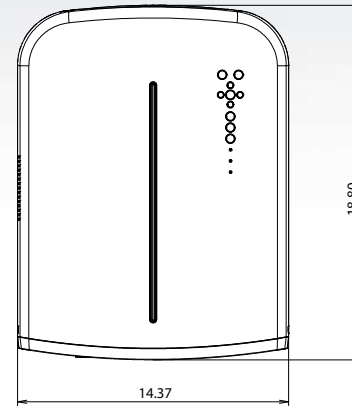

Bottom

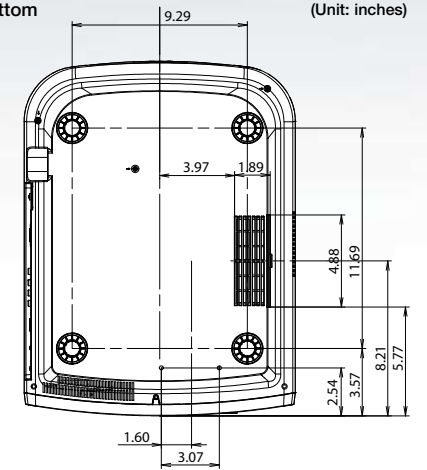

Front

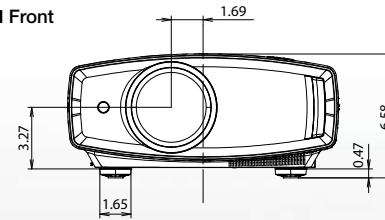

Side (left)

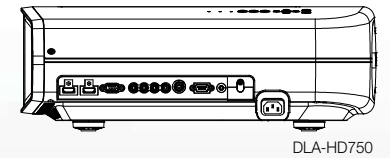

DLA-HD750

Side (right)

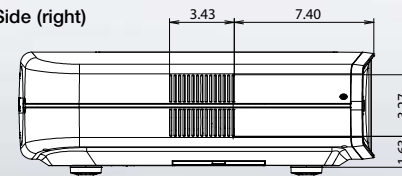

Side (left)

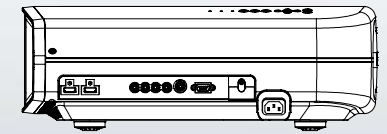

DLA-HD350

Terminals on the side (DLA-HD750)



Terminals on the side (DLA-HD350)



Optional Accessory



User-replaceable Lamp
BHL5010-S



- The projector is equipped with a high-pressure mercury lamp, which may break, emitting a loud noise.
- Please note that, depending on how the projector is used, there can be considerable difference between individual lamps regarding how many hours they will operate before requiring replacement.
- The projector lamp requires periodic replacement and is not covered by warranty (which is 2 years parts and labor, 90 days for the lamp).
- Please be aware that, because the D-ILA device is manufactured using highly advanced technologies, 0.01% or fewer of the pixels may be non-performing (always on or off).

Design and specifications are subject to change without notice. All pictures on this brochure are simulated. THX and the THX logo are trademarks of THX Ltd. which may be registered in some jurisdictions. HDMI, the HDMI logo and High-Definition Multimedia Interface are trademarks or registered trademarks of HDMI Licensing LLC.

All other brand or product names may be trademarks and/or registered trademarks of their respective owners. Any rights not expressly granted herein are reserved.

Copyright © 2008, Victor Company of Japan, Limited (JVC). All Rights Reserved.

JVC[®]

DISTRIBUTED BY

JVC
JAZZ
Festival

www.jvc.com

Printed in the U.S.A.