

myprojectorlamps.com

**The most trusted, dependable name
in projector lamp sales.**



<http://www.myprojectorlamps.com>



<http://www.myprojectorlamps.ca>



<http://www.myprojectorlamps.eu>

The following projector manual has not been modified or altered in any way.

X2 MULTI-USE PERFORMANCE

USER'S GUIDE



InFocus®

Declaration of Conformity

Manufacturer: InFocus Corporation, 27700B SW Parkway Ave. Wilsonville, Oregon 97070 USA

European Office: Strawinskylaan 585, 1077 XX Amsterdam, The Netherlands

We declare under our sole responsibility that this projector conform to the following directives and norms:

EMC Directive 89/336/EEC, Amended by 93/68/EEC

EMC: EN 55022

EN 55024

EN 61000-3-2

EN 61000-3-3

Low Voltage Directive 73/23/EEC, Amended by 93/68/EEC

Safety: EN 60950: 2000

February, 2004

Trademarks

Apple, Macintosh, and PowerBook are trademarks or registered trademarks of Apple Computer, Inc. IBM is a trademark or registered trademark of International Business Machines, Inc. Microsoft, PowerPoint, and Windows are trademarks or registered trademarks of Microsoft Corporation. Adobe and Acrobat are trademarks or registered trademarks of Adobe Systems Incorporated. InFocus, ProjectorManager, ProjectorNet, LiteShow, and LP are trademarks or registered trademarks of InFocus Corporation.

This User's Guide applies to model X2.

FCC Warning

Note: This equipment has been tested and found to comply with the limits for a Class B digital device, pursuant to part 15 of the FCC Rules. These limits are designed to provide reasonable protection against harmful interference in a residential installation. This equipment generates, uses and can radiate radio frequency energy and, if not installed and used in accordance with the instructions, may cause harmful interference to radio communications. However, there is no guarantee that interference will not occur in a particular installation. If this equipment does cause harmful interference to radio or television reception, which can be determined by turning the equipment off and on, the user is encouraged to try to correct the interference by one or more of the following measures:

--Reorient or relocate the receiving antenna.

--Increase the separation between the equipment and receiver.

--Connect the equipment into an outlet on a circuit different from that to which the receiver is connected.

--Consult the dealer or an experienced radio/TV technician for help.

Canada

This Class B digital apparatus complies with Canadian ICES-003.

Cet appareil numérique de la classe B est conforme à la norme NMB-003 du Canada.

Agency Approvals

UL, CUL, NOM, IRAM, GOST, C-tick

Other specific Country Approvals may apply. Please see product certification label.

InFocus reserves the right to alter product offerings and specifications at any time without notice.

Table of Contents

| | |
|--|----|
| Introduction | 5 |
| Positioning the projector | 7 |
| Projector and Device Connector Guide | 8 |
| Computer connections | 8 |
| Video connections | 8 |
| Connecting a computer source | 11 |
| Required computer connections | 11 |
| Optional computer connections | 11 |
| Displaying a computer source image | 12 |
| Adjusting the image | 13 |
| Using the projector with Windows 98 for the first time | 14 |
| Connecting a video device | 16 |
| Video device connections | 17 |
| Composite video connection | 17 |
| S-video connection | 17 |
| VGA connection | 18 |
| Displaying video | 19 |
| Adjusting the image | 19 |
| Shutting down the projector | 21 |
| Troubleshooting your setup | 21 |
| Using the remote control | 29 |
| Using the audio | 30 |
| Using the keypad buttons | 31 |
| Optimizing computer images | 32 |
| Presentation features | 32 |
| Optimizing video images | 33 |
| Customizing the projector | 33 |
| Using the menus | 34 |
| Picture menu | 35 |
| Settings menu | 38 |
| Maintenance | 41 |
| Cleaning the Lens | 41 |
| Replacing the Projection Lamp | 41 |
| Cleaning the Lamp Housing Screens | 43 |
| Using the security lock | 43 |
| Appendix | 44 |
| Projected Image Size | 44 |
| Red LED Behavior and Projector Errors | 44 |

If you are experienced in setting up projection systems, use the *Quick Setup* card that is included with the projector. For complete details on connecting and operating the projector, refer to this User's Guide. Electronic versions of this User's Guide in multiple languages are available on the included CD. The most current versions can be found on our website.

The website also has technical specifications (an interactive image size calculator, laptop activation commands, connector pin outs, a glossary, the product data sheet), a web store to buy accessories, and a page for online registration.

Important Operating Considerations for Safety

- Place the projector in a horizontal position no greater than 15 degrees off axis.
- Locate the projector in a well-ventilated area without any obstructions to intake or exhaust vents. Do not place the projector on a tablecloth or other soft covering that may block the vents.
- Locate the projector at least 4' (1.2 m) away from any heating or cooling vents.
- Use only InFocus-approved ceiling mounts.
- Use only the power cord provided. A surge-protected power strip is recommended.
- Refer to this manual for proper startup and shutdown procedures.
- In the unlikely event of the lamp rupturing, discard any edible items placed in the surrounding area and thoroughly clean the area along all sides of the projector. Wash hands after cleaning the area and handling the ruptured lamp. This product has a lamp which contains a very small amount of mercury. Dispose of it as required by local, state or federal ordinances and regulations. For more information see www.eiae.org.

Follow these instructions to help ensure image quality and lamp life over the life of the projector. Failure to follow these instructions may affect the warranty. For complete details of the warranty, see the Warranty section at the end of this User's Guide.

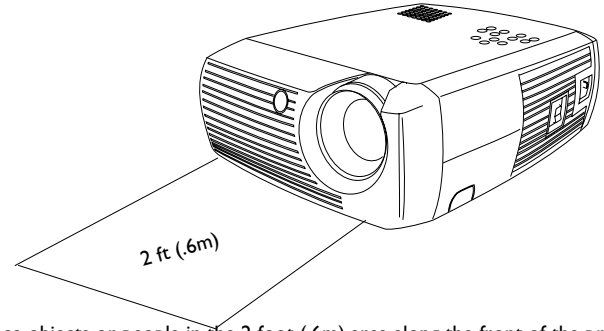

Do not place objects or people in the 2 foot (.6m) area along the front of the projector. For ceiling mount applications, this area should be 5 feet (1.5m).

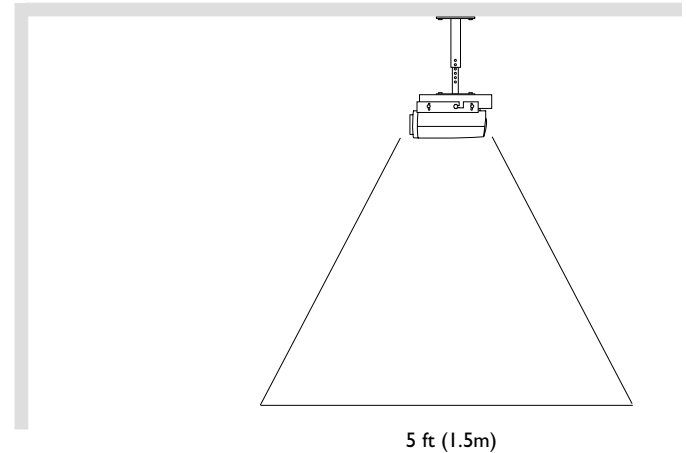

Introduction

Your new digital projector is simple to connect, easy to use, and straightforward to maintain. It is a versatile projector that is flexible enough for business presentations and home video viewing too. It has native SVGA 800x600 resolution and is compatible with a wide variety of computers and video devices, including:

- Most standard VCRs, DVD players (progressive and interlaced), progressive DVD, HDTV sources, TV and satellite tuners, camcorders, video games, and laser disc players.
- IBM-compatible computers, including laptops, up to 1024x768 resolution.
- Apple® Macintosh® and PowerBook® computers up to 1024x768 resolution.

Product specifications

To read the latest specifications on your multimedia projector, be sure to visit our website, as specifications are subject to change. Web address information is located on the back inside cover of this User's Guide.

Accessories

The standard accessories that came with your projector can be found on the included packing list. Optional accessories are listed in the Accessories catalog that came with the projector and can also be found on our website. See the inside back cover for the Web address.

Online Registration

Register your projector on our website to receive product updates, announcements, and registration incentives. See the inside back cover for the Web address.

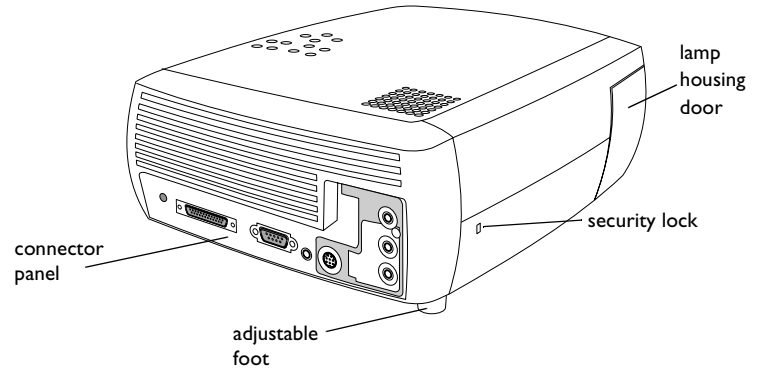
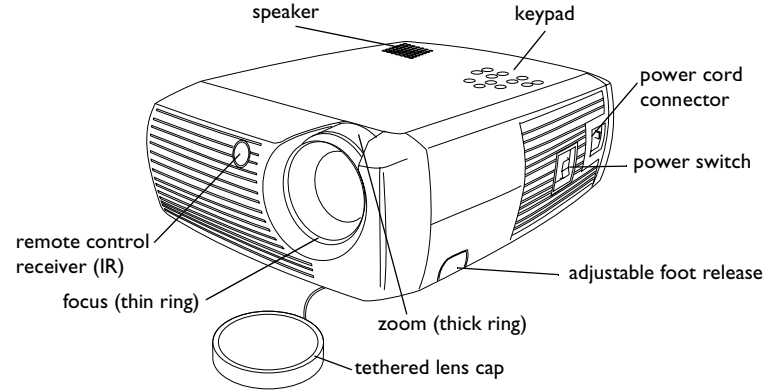

Connector Panel

The projector provides both computer and video connection options, including:

- M1 for computer and video
- S-video
- Composite RCA audio/video

The projector also provides the following connectors:

- Monitor out
- Audio out
- 12 volt DC output (see below)

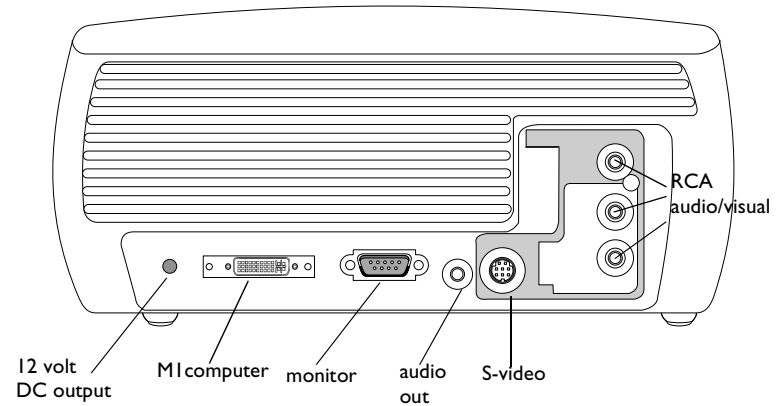

12 volt DC output

The 3.5mm mini-jack trigger provides a 12 volt DC output. It provides a constant output while the projector is on. It has numerous uses. For example, if you connect your projection screen to the 12 volt DC output with the cable that came with your screen, when you turn on the projector the screen will move down; when you turn the projector off, the screen will return to the storage position. To use the 12 volt DC output, you must first remove the safety plug and turn Screen Trigger on in the System menu (see page 38).

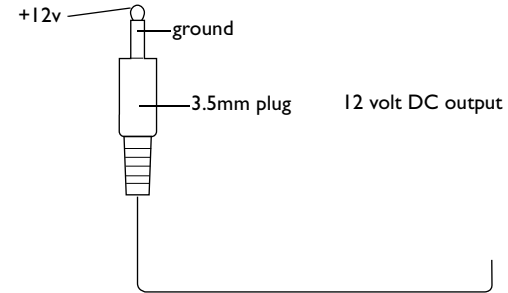

to, for example, screen relay (see screen manufacturer for details)

Wireless Projection

You can use the projector's M1 connector along with the InFocus® LiteShow® wireless adapter and software for cable-free digital projection. Contact an authorized InFocus dealer or visit the website listed on the back inside cover of this User's Guide for more information.

InFocus. LiteShow.
Wireless Freedom for Your Projector.™



Positioning the projector

To determine where to position the projector, consider the size and shape of your screen, the location of your power outlets, and the distance between the projector and the rest of your equipment. Here are some general guidelines:

- Position the projector on a flat surface at a right angle to the screen. The projector must be at least 4.9 feet (1.49m) from the projection screen.
- Position the projector within 10 feet (3m) of your power source and within 6 feet (1.8m) of your video device (unless you purchase extension cables). To ensure adequate cable access, do not place the projector within 6 inches (.15m) of a wall or other object.
- If you are installing the projector on the ceiling, refer to the installation guide that comes with the Ceiling Mount Kit for more information. To turn the image upside down, see “Ceiling” on page 38. We recommend using an authorized ceiling mount.
- Position the projector the desired distance from the screen. The distance from the lens of the projector to the screen, the zoom setting, and the video format determine the size of the projected image. The top illustration to the right shows three projected image sizes. For more information about image sizes at different distances, see “Projected Image Size” on page 44.
- The image exits the projector at a given angle. This image offset is 112.2% when the projector is in 4:3 mode (default mode). This means that if you have an image 10' high, the bottom of the image will be 1.22' above the center of the lens.
- This image offset is 132.9% when the projector is in 16:9 mode. This means that if you have an image 10' high, the bottom of the image will be 3.29' above the center of the lens.
- See “Connecting a video device” on page 16 for additional information on 16:9 and 4:3 modes.

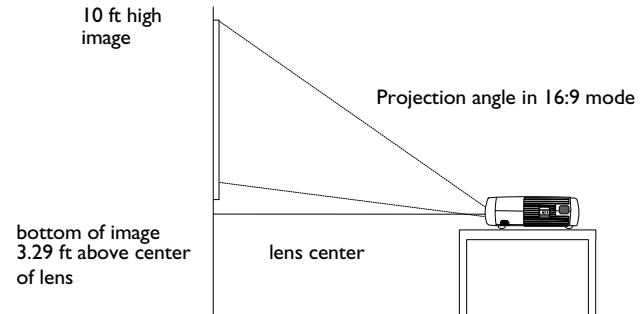
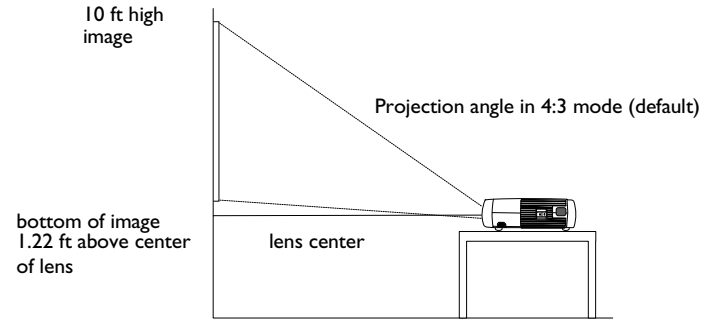
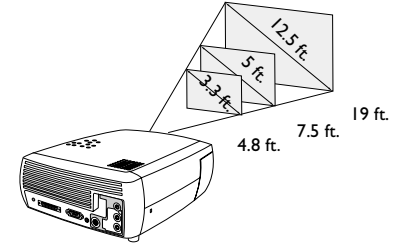

Projector and Device Connector Guide

The following illustration and table should help you find the connectors to use and obtain the best resolution possible from your input devices, such as computers, standard VCRs, DVD players (progressive and interlaced), HDTV sources (1080i, 1035i, and 720p HDTV formats), TV and satellite tuners, camcorders, video games (progressive and interlaced), and laser disc players.

Computer connections

Computer connections involve attaching the VGA and USB ends of the provided computer cable to a computer and connecting the other end (M1) to the **Computer In** input on the projector. The USB part of the computer cable allows you to advance slides in a PowerPoint™ presentation via a remote control. See page 11 for computer/projector setup information.

Video connections

The first step for connecting video is deciding what type of output connector you want to connect to the projector. If there is more than one output on your video device, select the one with the highest quality. Your options are S-video (higher quality) and Composite video (lesser quality).

If you are connecting the projector to HDTV sources, the projector's M1 computer connector, labeled **Computer In**, should be used. Keep in mind that HDTV and progressive sources should only be handled through the projector's computer connector. You can also use an M1 to Component adapter (available as an optional accessory) to connect a progressive source's component connectors to the projector. The S-video port does not function with progressive sources.

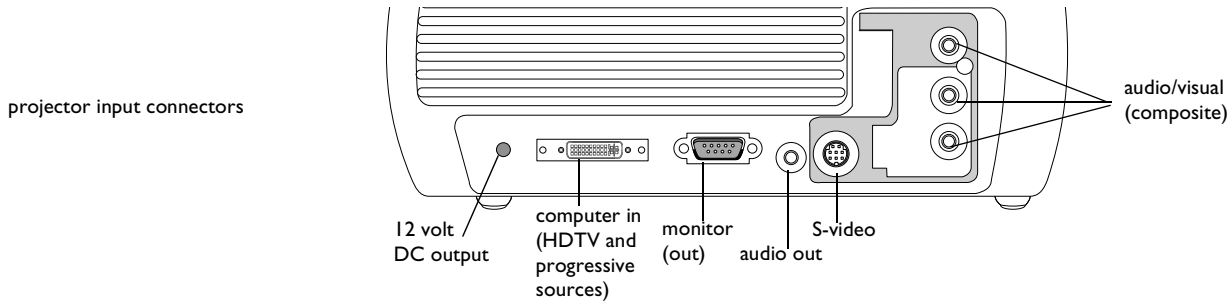

| Video Device | Video Compatibility | If Your Device Connector Is | Attach to Adapter or Labeled Connector on Projector | For Setup Instructions, see | Comments |
|--|------------------------------|-----------------------------|---|---|---|
| Standard Broadcast TV (not HDTV) via: cable, digital cable, satellite TV, DVD, or VCR | NTSC, PAL, and SECAM formats | Composite video or S-video | Composite video or S-video | Composite video connection on page 17. S-video connection on page 17 | Not for progressive (i.e. HDTV) sources. See page 10. |
| Standard Video Camera | NTSC, PAL, and SECAM formats | Composite video or S-video | Composite video or S-video | Composite video connection on page 17. S-video connection on page 17 | Not for progressive (i.e. HDTV) sources. See page 10. |
| Standard Video Game | NTSC, PAL, and SECAM formats | Composite video or S-video | Composite video or S-video | Composite video connection on page 17. S-video connection on page 17 | Not for progressive (i.e. HDTV) sources. See page 10. |

| Video Device | Video Compatibility | If Your Device Connector Is | Attach to Adapter or Labeled Connector on Projector | For Setup Instructions, see | Comments |
|----------------------------------|-------------------------------|-----------------------------|---|---|-------------------------|
| HDTV (High Definition TV) | 1080i, 720p | VGA Component video | Computer In Computer In via optional MI to Component adapter | VGA connection on page 18 MI to Component adapter on page 18 | Not for Component 480i. |
| Progressive DVD | 1080i, 720p Component 480p | VGA Component video | Computer In Computer In via optional MI to Component adapter | VGA connection on page 18 MI to Component adapter on page 18 | Not for Component 480i. |
| Progressive Video Game | 1080i, 720p Component 480p | VGA Component video | Computer In Computer In via optional MI to Component adapter | VGA connection on page 18 MI to Component adapter on page 18 | Not for Component 480i. |

Connecting a computer source

Required computer connections

Connect one end of the provided computer cable (see page 16 for connecting video devices) to the blue M1 **Computer In** connector on the projector. Connect the other ends (USB and VESA) to the USB and VGA ports on your computer. If you are using a desktop computer, you will need to disconnect the monitor cable from the computer's video port first.

This connection allows you to advance slides in a PowerPoint presentation using the remote. USB drivers must be installed to use the USB feature. For more information, see page 15.

Connect the black power cord to the **Power** connector on the side of the projector and to your electrical outlet.

NOTE: Always use the power cord that shipped with the projector.

Optional computer connections

To have sound with your presentation, connect an audio cable (not included) to your computer and to the red and/or white **Audio In** connectors on the projector.

If you are using a desktop computer and want to see the image on your computer screen as well as on the projection screen, connect the computer's monitor cable to the **Monitor Out** connector on the projector.

connect computer cable

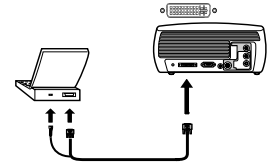
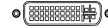

connect power cable

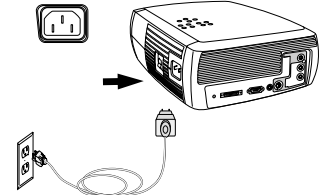

connect audio cable

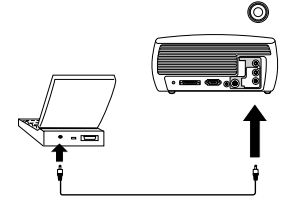

connect monitor cable

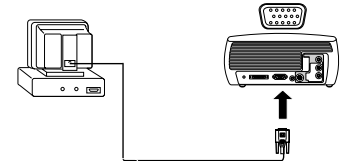

Displaying a computer source image

Remove the lens cap.

remove lens cap

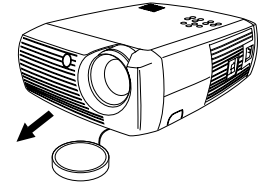

Toggle the **Power** switch on the side of the projector to the On position.

toggle Power switch

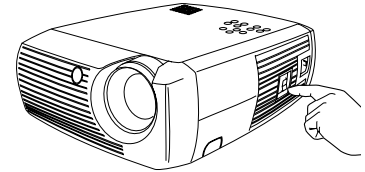

The LED flashes green and the fans start to run. When the lamp comes on, the start up screen displays and the LED is steady green. It can take a minute for the image to achieve full brightness.

? No start up screen? Get help on page 21.

Turn on your computer.

turn on computer



computer



The computer's image should appear on the projection screen. If it doesn't, press the **Computer** button on the projector's keypad.

If your computer has Windows 98 as its operating system, see "Using the projector with Windows 98 for the first time" on page 14 regarding the driver setup process.

Make sure your laptop's external video port is active.

activate laptop's external port

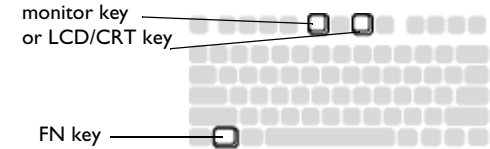

Many laptops do not automatically turn on their external video port when a projector is connected. Usually a key combination like FN + F8 or CRT/LCD key turns the external display on and off. Locate a function key labeled CRT/LCD or a function key with a monitor symbol. Press FN and the labeled function key simultaneously. **Refer to your laptop's documentation to learn your laptop's key combination.**

? No laptop image? Try pressing the **Auto Image** button on the keypad. Get help on page 22.

Adjusting the image

If necessary, adjust the height of the projector by pressing the release button to extend the foot.

If necessary, rotate the leveling foot located at the rear of the projector.

Avoid placing your hands near the hot exhaust vent in front of the projector.

Position the projector the desired distance from the screen at a 90 degree angle to the screen.

See page 44 for a table listing screen sizes and distances.

Adjust the zoom or focus.

If the image is not square, adjust the keystone using the buttons on the keypad.

Press the top **Keystone** button to reduce the upper part of the image, and press the bottom **Keystone** button to reduce the lower part.

Adjust the Contrast or Brightness in the Picture menu.

See page 35 for help with these menu adjustments.

adjust height



elevator
foot

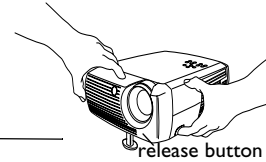

release button

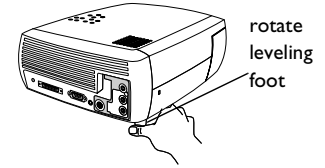

rotate
leveling
foot

adjust distance

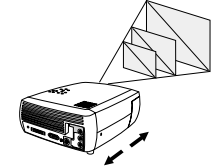

adjust zoom or focus

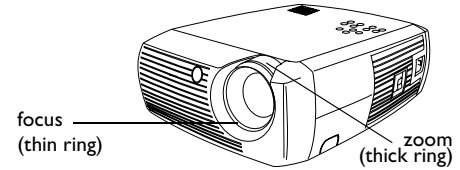

focus
(thin ring)

zoom
(thick ring)

adjust keystone



keystone

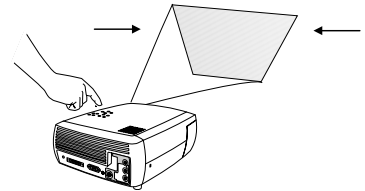

adjust Picture menu



menu

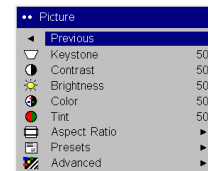

Using the projector with Windows 98 for the first time

The first time you connect a computer running Windows 98 to the projector, the computer recognizes the projector as “new hardware” and the Add New Hardware Wizard appears. Follow these instructions to use the Wizard to load the correct driver (which was installed with your Windows operating system).

If you are running Windows 2000 or Windows ME, skip these steps and go to “Adjusting the image” on page 13.

a Click **Next** to begin searching for the driver.

b Make sure “Search for the best driver” is selected, then click **Next**.

c Uncheck any checked boxes, then click **Next**. Windows automatically locates the driver. If this driver has been removed, reload the driver using your Windows operating system CD.

d When Windows finds the driver, you are ready to install it. Click **Next**.

a



b

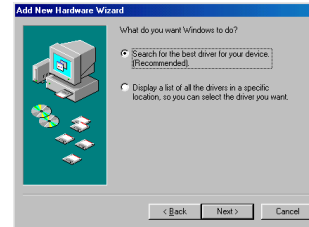

c



d



Skip this page if you did not connect a USB mouse cable

For Windows 98:

- If you connected the USB cable, the Add New Hardware Wizard appears again. Drivers must be installed to use the USB functionality.
- **The Wizard launches three times.**

The first time it detects a USB Composite Device.

The second time a USB Human Interface Device (for the keyboard).

The third time it detects a USB Human Interface Device (for the mouse).

For Windows 2000, Windows ME, and Windows XP:

- The USB drivers are automatically installed.

Connecting a video device

You can connect video devices such as VCRs, DVD players, camcorders, digital cameras, video game consoles, HDTV receivers, and TV tuners to the projector. There is also an audio input via the red and white A/V connectors. You can connect the audio directly to the projector to get sound from the built-in speaker, or you can connect the audio to your stereo system via the Audio Out connector.

You can connect the projector to most video devices that can output video. You cannot directly connect the coaxial cable that enters your house from a cable or satellite company, the signal must pass through a tuner first. Examples of tuners are digital cable boxes, VCRs, digital video recorders, and satellite TV boxes. Basically, any device that can change channels is considered a tuner.

Before connecting your projector, you should decide which aspect ratio you want to use. The projector's Aspect Ratio setting is accessed through the projector's Picture Menu. See page 35 for more information.

What is Aspect Ratio?

Aspect ratio is the ratio of the image width to image height. TV screens are usually 4:3, which is the default for this projector. HDTV and most DVDs are 16:9. If you're projecting onto a screen, the size/shape of the screen may determine which aspect ratio to use. If you are projecting onto a blank wall, you don't have the screen size restriction. What you plan to project will also help you choose between 4:3 and 16:9. Most TV shows are 4:3, while most movies are 16:9.

If you have a 16:9 screen then you should select an aspect ratio of 16:9 for anamorphic movies or HDTV, and Native for 4:3 content. If you have a 4:3 screen you should still use 16:9 for anamorphic movies or HDTV, but you also have the option of using either 4:3 (to fill the screen) or Native (for direct pixel mapping) for 4:3 content. Keep in mind that anamorphic movies only appear correctly if the DVD player is set to output to a 16:9 television.

4:3 screen

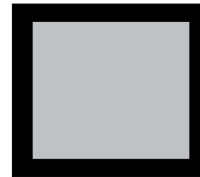
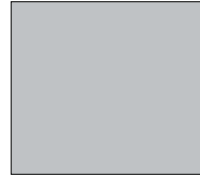

16:9 screen

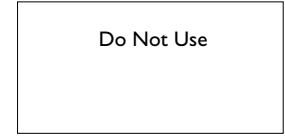

4:3 mode



16:9 mode

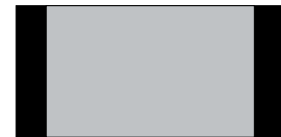

Native mode (NTSC only)

Video device connections

Composite video connection

Plug the provided A/V cable's yellow connector into the video-out connector on the video device. Plug the other yellow connector into the yellow **Video 2** connector on the projector.

Plug a white connector into the left audio out connector on the video device and plug a red connector into the right audio out connector on the video device. Plug the remaining white connector into the white **audio in** connector on the projector, and plug the remaining red connector into the red **audio in** connector on the projector.

Keep in mind that video output from composite connections are not as high quality as S-video.

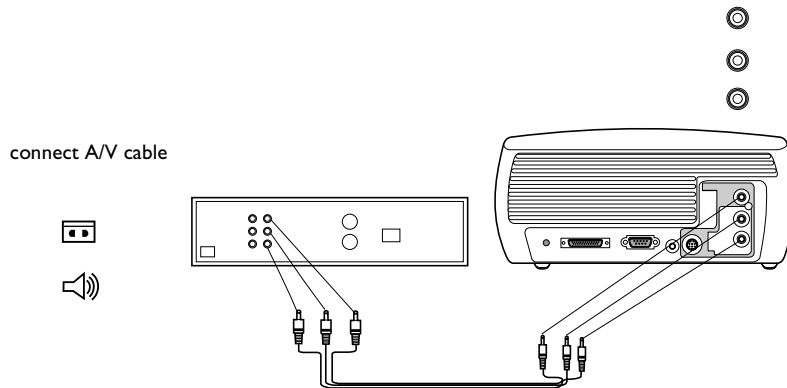

S-video connection

If your video device uses a round, seven-prong S-video connector, plug an S-video cable (available as an optional accessory) into the S-video connector on your video device and into the **S-video** connector on the projector. Use the A/V cable's red and white audio connectors as described directly above (the yellow connectors on the A/V cable are not used).

Keep in mind that S-video delivers higher quality video output than composite.

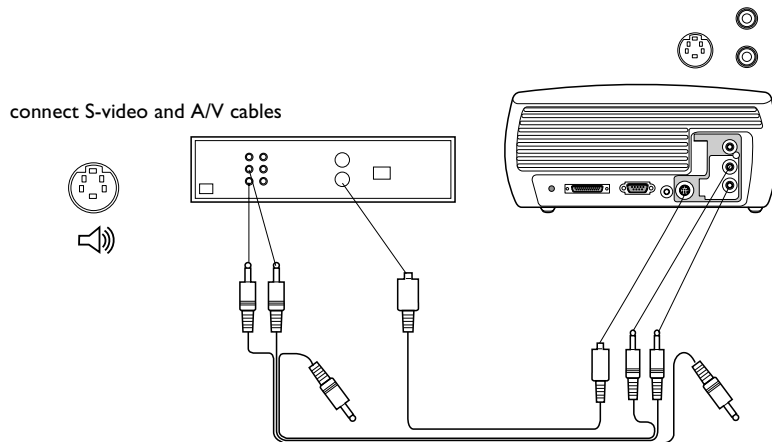

VGA connection

If your video device has a 15-pin VGA output, plug one end of the included computer cable into the VGA connector on your video source. This connector may be labeled "To Monitor" on the video source. Plug the M1 computer end of the cable into the **Computer In** connector on the projector. Do not plug the USB end of this cable into the video device.

Use the A/V cable's red and white audio connectors as described on the previous page (the yellow connectors on the A/V cable are not used).

connect computer and
A/V cables

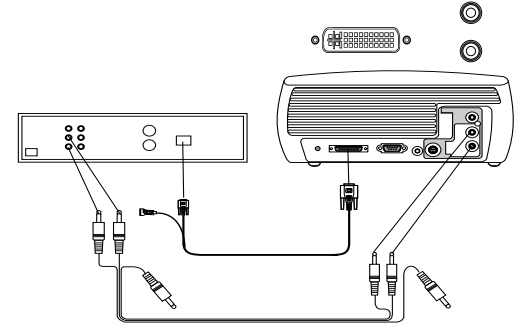

M1 to Component adapter

To connect a progressive scan DVD or HD source, use an M1 to Component adapter (available as an optional accessory). Connect one end of a component cable (not provided) into the adapter. Connect the M1 end of the adapter into the Computer 1 connector on the projector.

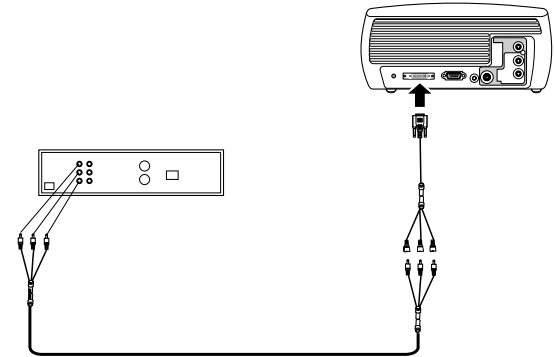

Connect the power cord to the **Power** connector on the side of the projector and to your electrical outlet.

NOTE: Always use the power cord that shipped with the projector.

connect power cable

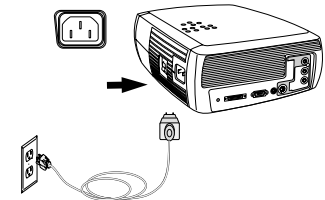

Displaying video

Remove the lens cap.

remove lens cap

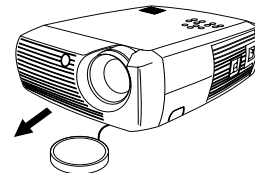

Toggle the **Power** switch on the side of the projector to the **On** position.

toggle Power switch

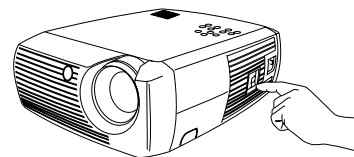

The LED flashes green and the fans start to run. When the lamp comes on, the start-up screen is displayed and the LED is steady green. It can take a minute for the image to achieve full brightness.

? No start up screen? Get help on page 22.

Plug in and turn on your video device.

turn on video device

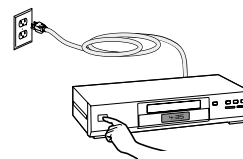

The video device's image should appear on the projection screen. If it doesn't, press the **Video** button on the keypad.

? No image? Try pressing the **Source** or **Auto Image** Get help on page 22.

Adjusting the image

Adjust the height of the projector by pressing the release button to extend the foot.

adjust height



elevator
foot

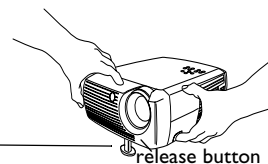

release button

Rotate the leveling foot at the rear of the projector, if necessary.

rotate
leveling
foot

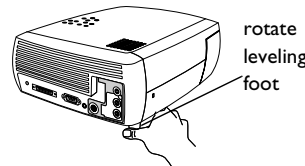

Position the projector the desired distance from the screen at a 90 degree angle to the screen.

adjust distance

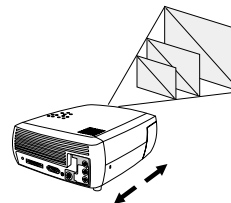

See page 44 for a table listing screen sizes and distances to the screen.

Adjust the zoom and focus.

If the image is not square, adjust the keystone using the buttons on the keypad. Press the top **Keystone** button to reduce the upper part of the image, and press the bottom **Keystone** button to reduce the lower part.

Adjust the volume on the keypad or remote.

Adjust the Contrast, Brightness, Color, Tint, or Aspect Ratio in the Picture menu. See page 35 for help with the menus and these adjustments.

For Aspect Ratio, keep in mind that DVD players must be configured for 16:9 in order to view the highest quality image. For more information regarding Aspect Ratio, see page 16.

adjust zoom and focus

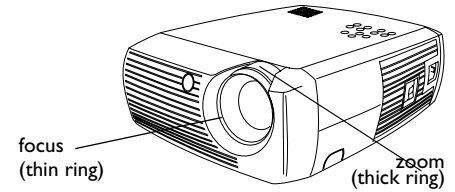

adjust keystone

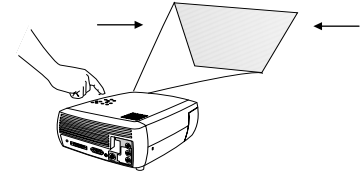

adjust volume

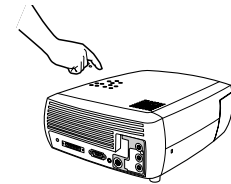

adjust Picture menu options including Aspect Ratio

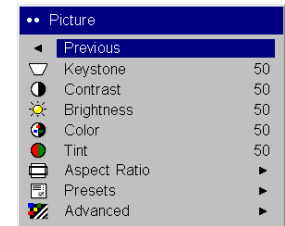

Shutting down the projector

The projector automatically displays a black screen after no active source is detected for 30 minutes. This black screen helps preserve the life of the projector. The image returns when an active source is detected or a remote or keypad button is pressed.

Screen Save

You can make the black screen appear after a preset number of minutes by turning on the Screen Save feature in the **Settings>System** menu. See page 38.

Power Save

The projector also has a Power Save feature that automatically turns the lamp off after no active sources are detected and no user interaction with the projector is performed for 20 minutes. By default, this feature is off. See page 38.

Turning off the projector

You can turn the projector off simply by toggling the power switch to the off position.

You can also press the remote's **Power** button to place the projector in the Off state while it is running. When the **Power** button is pressed twice (once to start the power-down process and a second time to verify that you want to power the projector off), the lamp turns off and the LED blinks green for one (1) minute while the fans continue to run to cool the lamp. While the LED is blinking green, the projector does not accept any keypad and remote control input.

When the lamp has cooled, the LED lights solid green and the fans slow down to minimal speed. To turn off the projector, toggle the power switch to the off position.

NOTE: Once the projector has been toggled off, you must wait for one (1) minute before turning the projector on again. This allows the lamp to properly cool. However, if the remote was used to power the projector to the Off state you do not need to wait one minute to turn it on again.

Troubleshooting your setup



If your image appears correctly on the screen, skip to the next section. If it does not, troubleshoot the setup.

The LED on top of the projector indicates the state of the projector and can help you troubleshoot.

Table 1: LED behavior and meaning

| LED color/behavior | Meaning |
|--|---|
| solid green | The power switch has been toggled on and the software has initialized or the projector has been powered off via the remote. |
| blinking green | The power switch has been toggled on and the software is initializing, or the projector is powering down and the fans are running to cool the lamp. |
| blinking red see page 44 for more information | A fan or lamp failure has occurred. Make sure the vents aren't blocked (see page 27). Turn off the projector and wait one minute, then turn the projector on again. If the projector has been working exceeded its lamp life (page 41), replace the lamp and reset the lamp timer. Contact Technical Support if the problem persists. |
| solid red | An unidentifiable error: please contact Technical Support. |

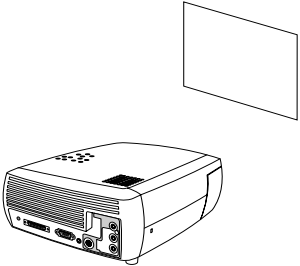
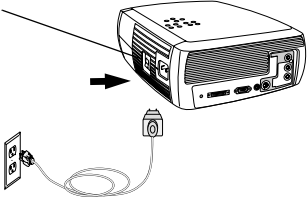
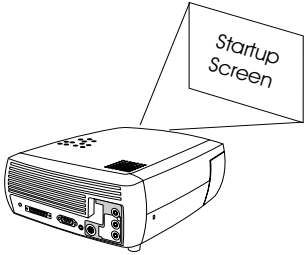
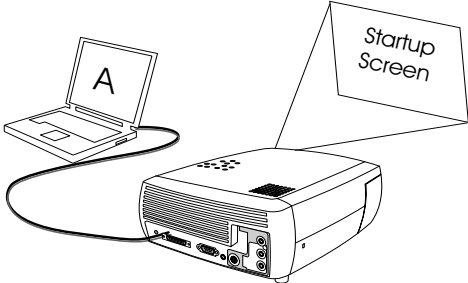
The following tables show common problems. In some cases, more than one possible solution is provided. Try the solutions in the order they are presented. When the problem is solved, you can skip the additional solutions.

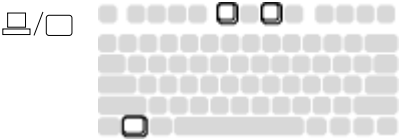
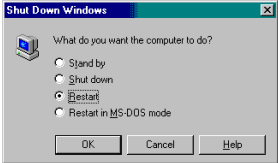
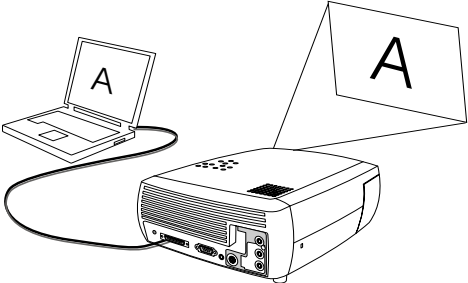
| Problem | Solution | Result |
|--|---|---|
| <p data-bbox="53 169 260 192">no start up screen</p>  | <p data-bbox="664 164 1098 244"> plug power cord in projector's left side remove lens cap toggle power switch </p> <p data-bbox="730 265 909 307">toggle power switch on side</p>  | <p data-bbox="1187 169 1347 192">correct image</p>  |
| <p data-bbox="53 588 371 611">only start up screen appears</p>  | <p data-bbox="664 580 1008 640"> press the Computer button  activate laptop's external port </p>  <p data-bbox="682 839 838 862">restart laptop</p>  | <p data-bbox="1187 588 1489 611">computer image projected</p>  |

no computer image, just the words “Signal out of range”

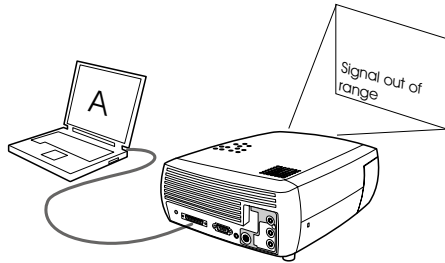

press the **Auto Image** button on keypad
adjust computer refresh rate in **Control Panel>Display>Settings>Advanced>Adapter**
(location varies by operating system)

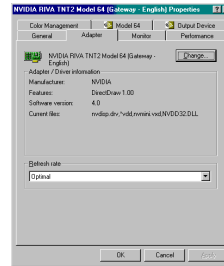

you may also need to set a different resolution on your computer, as shown in the following problem, “image fuzzy or cropped”

computer image projected

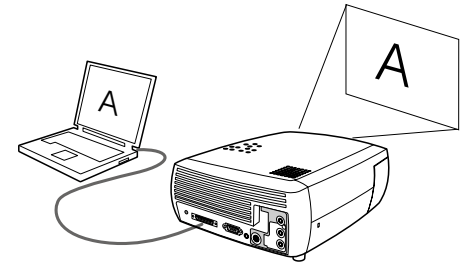

Only my laptop’s background appears, not the Desktop icons

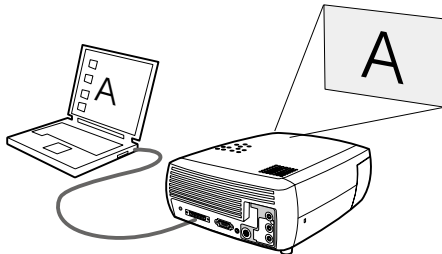



Disable “Extend my Windows Desktop” in **Control Panel>Display>Settings>Display 2**
(location varies by operating system)

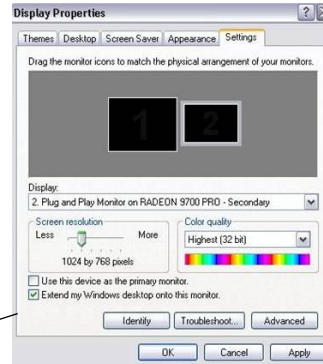



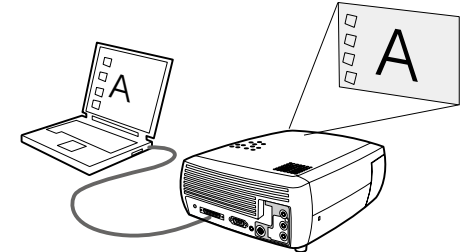

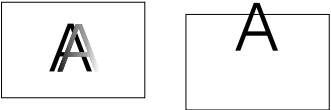
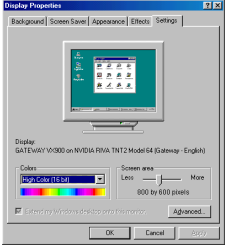
Uncheck this option, then click Apply

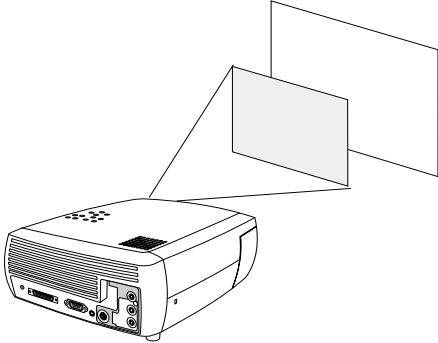
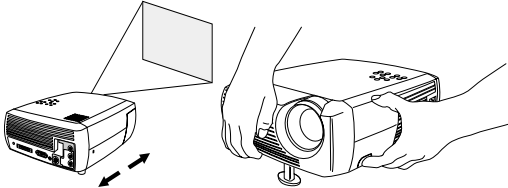
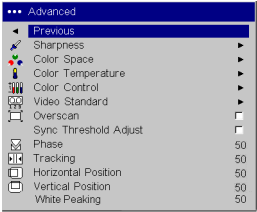
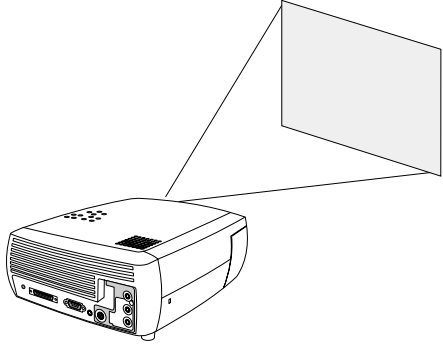

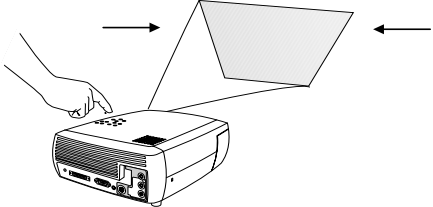

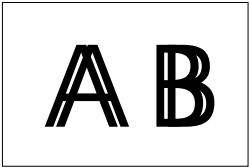
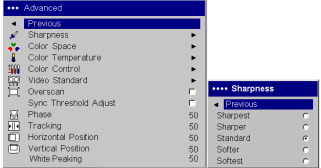

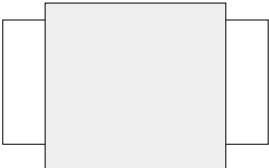
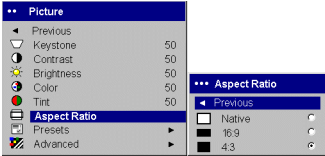

Background and Desktop projected

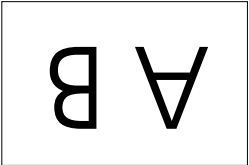
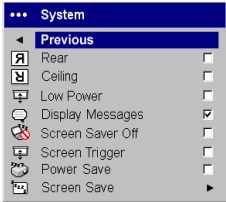

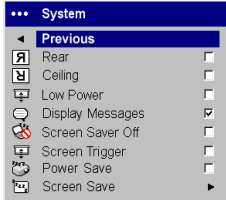
| Problem | Solution | Result |
|---|---|--|
| <p data-bbox="48 118 319 143">image fuzzy or cropped</p>  | <p data-bbox="661 118 1124 256">set your computer's display resolution to the native resolution of the projector (Start>Settings>Control Panel>Display>Settings tab) select 800x600</p> <p data-bbox="666 345 850 483">For a laptop, disable laptop monitor or turn-on dual-display mode</p>  | <p data-bbox="1183 118 1512 143">image clear and not cropped</p>  |
| <p data-bbox="48 652 388 677">image not centered on screen</p>  | <p data-bbox="661 615 1147 640">move projector, adjust zoom, adjust height</p>  <p data-bbox="652 881 878 984">adjust horizontal or vertical position in Picture>Advanced menu</p>  | <p data-bbox="1183 655 1347 680">correct image</p>  |

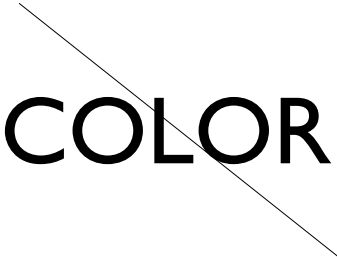
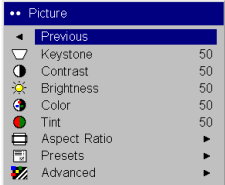
| Problem | Solution | Result |
|---|---|--|
| <p>image not square</p>  | <p>adjust Keystone on keypad</p>  | <p>square image</p>  |
| <p>image not sharp</p>  | <p>adjust Sharpness (video sources only) in the Picture>Advanced menu</p>  | <p>correct image</p>  |
| <p>image does not fit 4:3 or 16:9 screen</p>  | <p>change aspect ratio to 4:3 or 16:9 in Picture>Aspect ratio menu</p>  | <p>correct image</p>  |

| Problem | Solution | Result |
|---|--|--|
| <p>image upside down</p>  | <p>turn off ceiling in Settings>System menu</p>  | <p>correct image</p>  |
| <p>image reversed left to right</p>  | <p>turn off rear in Settings>System menu</p>  | <p>correct image</p>  |
| <p>projected colors don't match source</p>  | <p>adjust color, tint, color temperature, brightness, contrast in the menus</p>  | <p>correct image</p>  |

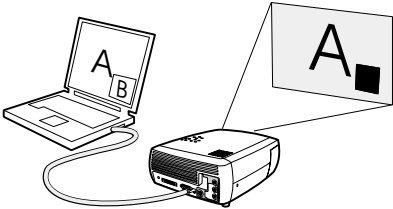
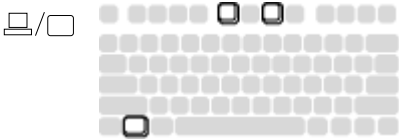
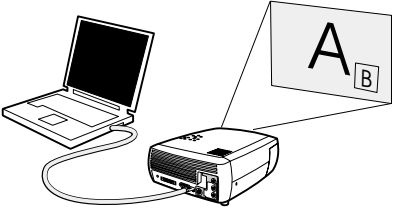
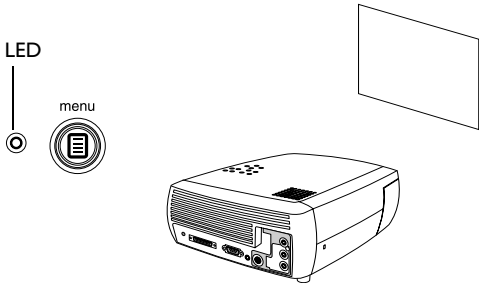
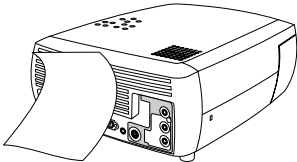
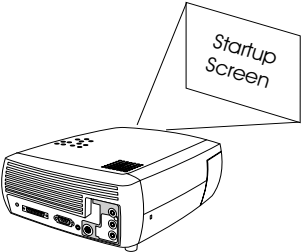
| Problem | Solution | Result |
|---|--|--|
| <p data-bbox="53 115 512 169">The video embedded in my PowerPoint presentation does not play on the screen</p>  | <p data-bbox="661 115 1124 169">turn off the internal LCD display on your laptop</p>  | <p data-bbox="1187 123 1548 150">Embedded video plays correctly</p>  |
| <p data-bbox="53 529 472 555">lamp won't turn on, LED blinking red</p>  | <p data-bbox="661 471 1152 548">make sure vents aren't blocked, turn off the projector and allow it to cool for one minute</p>  | <p data-bbox="1187 529 1347 555">lamp turns on</p>  |

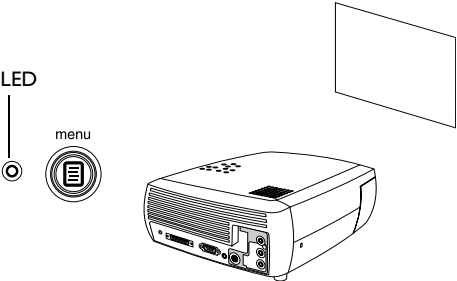
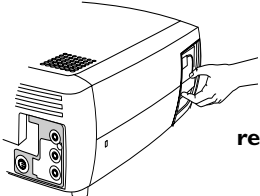
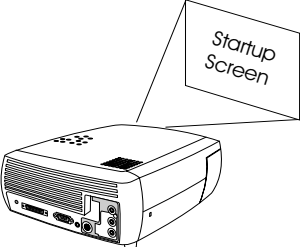
| Problem | Solution | Result |
|---|---|--|
| <p data-bbox="53 123 631 176">“Change lamp” message appears at startup or lamp won’t turn on and LED blinking red</p>  <p data-bbox="118 261 215 392">LED menu</p> | <p data-bbox="666 208 1079 234">lamp must be replaced (see page 41)</p>  <p data-bbox="996 392 1142 415">replace lamp</p> | <p data-bbox="1187 117 1350 140">lamp turns on</p>  <p data-bbox="1454 238 1531 300">Startup Screen</p> |

Still need assistance?

If you need assistance, visit our website or call us. See the inside of the back cover for support contact information. This product is backed by a limited warranty. An extended warranty plan may be purchased from your dealer. When sending the projector in for repair, we recommend shipping the unit in its original packing material, or having a professional packaging company pack the unit. Please insure your shipment for its full value.

Using the remote control

The remote uses two (2) provided AA batteries. They are easily installed by sliding the cover off the remote's back, aligning the + and - ends of the batteries, sliding them into place, and then replacing the cover.

Caution: When replacing the batteries, be aware that using batteries other than the type provided with the projector may risk severe damage to the remote. When disposing of the batteries, be sure to do so in an environmentally proper manner.

To operate, point the remote at the projection screen or at the projector (not at the computer). The range of optimum operation is about 15 feet (4.5m).

Pressing the remote's **Power** button when the projector's Power toggle switch is in the Off position does not cause the projector to power up. You need to put the projector's Power toggle switch in the On position to let the remote power on the projector.

When the projector is running, you can press the remote's **Power** button to place the projector in the Off state (see page 21 for shutdown info) and power it off.

Press the remote's **Menu** button to open the projector's menu system. Use the arrow buttons to navigate, and the **Select** button to select features and adjust values in the menus. See page 34 for more info on the menus.

The remote also has **Volume** and **Mute** buttons to control the sound, and **Video** and **Computer** buttons to switch between sources.

Two presentation-specific features are also provided. Use the **Blank** button to display a blank screen instead of the current slide (you can choose which color is displayed, see page 39); use the **Effect** button to invoke a user-definable action, such as freeze, or change your aspect ratio for viewing DVDs (see page 39 to learn to program this button).

Previous and **Next** buttons allow you to navigate through your PowerPoint presentation while in Slide Show mode. Connect the USB connector on the provided computer cable to your computer to use these buttons. When you do this for the first time, the Add New Hardware wizard may appear. See page 15 for details on loading the correct USB drivers.

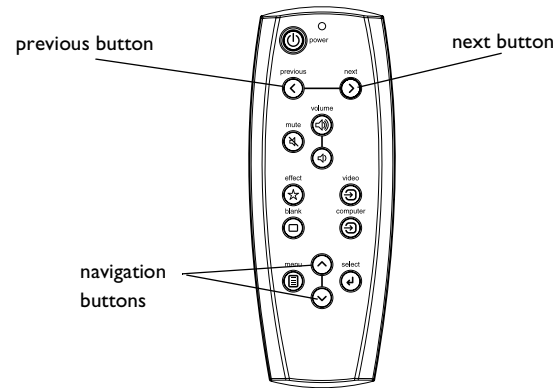

Troubleshooting the remote

- Make sure the batteries are installed in the proper orientation and are not dead.
- Make sure you're pointing the remote at the projector or the screen, not the computer, and are within the remote range of 15 feet (4.5m). For best results, point the remote at the screen.
- If you are trying to advance PowerPoint slides, make sure the USB cable is connected. If using a USB cable, make sure the correct drivers are installed.

Using the audio

Using the projector's speakers

To use the projector's speaker, connect your source to the **Audio In** connectors (**L** and/or **R**) on the projector's composite connectors.

To adjust the volume, press the **Volume** buttons on the keypad or remote.

To mute the sound, press the **Mute** button on the remote.

Troubleshooting Audio

If you aren't hearing the audio, check the following:

- Make sure the audio cable is connected.
- Make sure mute is not active (press the **Mute** button on the remote).
- Make sure the volume is turned up enough. Press the **Volume** button on the keypad or remote.
- Make sure the correct source is active.
- Adjust the audio source.
- If playing a video, make sure the playback has not been paused.

Connecting external speakers

The projector can be attached to external speakers that have their own power source by plugging a speaker cable (not included) into the projector's **Audio Out** connector.

connect audio cable

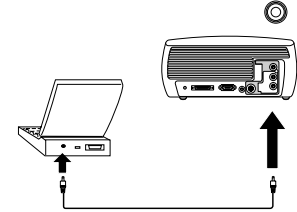

adjust volume

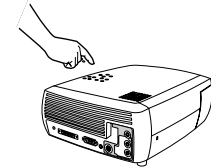
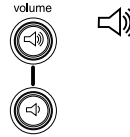

external speakers
with own power source

speaker
cable

audio out

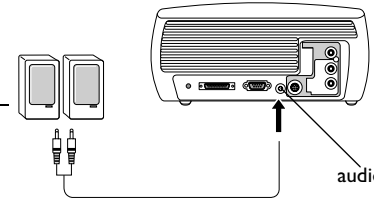

Using the keypad buttons

Most buttons are described in detail in other sections, but here is an overview of their functions:

Menu—opens the on-screen menus (page 34).

Select—confirms choices made in the menus (page 34).

Up/Down arrows—navigates to and adjusts settings in the menus (page 34).

Auto Image—resets the projector to the source.

Presets—cycles through the available preset settings (page 36).

Keystone—adjusts squareness of the image (page 13).

Volume—adjusts sound (page 30).

Video and **Computer**—changes the active source.

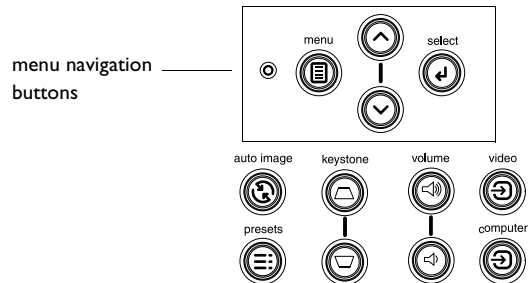

Optimizing computer images

After your computer is connected properly and the computer's image is on the screen, you can optimize the image using the onscreen menus. For general information on using the menus, see page 34.

- Adjust the Keystone, Contrast, or Brightness in the Picture menu (page 35).
- Change the Aspect Ratio. Choose the option that best fits your input source (page 35).
- Adjust the Color Temperature in the Advanced menu (page 37).
- Adjust the Phase, Tracking, or Horizontal or Vertical position in the Advanced menu (page 37).
- Once you have optimized the image for a particular source, you can save the settings using Presets. This allows you to quickly recall these settings later (page 36).

Presentation features

Several features are provided to make giving presentations easier. Here is an overview, details are found in the menu section.

- The Effect button on the remote allows you to assign various features to the button. The default effect is About, which displays information about the projector and current source. You can select among Blank, Mute, Aspect Ratio, Source, Auto Image, Freeze, and About. See page 39 for details. The freeze effect allows you to freeze the displayed image. This is useful if you want to make changes on your computer without your audience seeing them.
- The Blank button on the remote allows you to display a blank screen instead of the active source. You can determine the color of this screen (page 39).
- The Startup Logo option lets you change the default start up screen to a blank or default screen (page 39).
- Two options, Power Save and Screen Save, are provided to automatically shut down the projector after several minutes of inactivity or display a black screen. This helps preserve lamp life (page 38).

Optimizing video images

After your video device is connected properly and the image is on the screen, you can optimize the image using the onscreen menus. For general information on using the menus, see page 34.

- Adjust the Keystone, Contrast, Brightness, Color, or Tint in the Picture menu (page 35).
- Change the Aspect Ratio. Choose the option that best fits your input source (page 35).
- The remote's Effect button allows you to assign various features to the button. The default effect is About, which displays information about the projector and current source. You can select among Blank, Mute, Aspect Ratio, Source, Auto Image, Freeze, and About. See page 39 for details.
- Select a Sharpness setting (page 37).
- Use the Color Control to adjust the color gain (page 37).
- Adjust the Color Temperature. Select a listed warmth value (page 37).
- Turn on Overscan to remove noise on the edges of the image.

Customizing the projector

You can customize the projector for your specific setup and needs. See page 38 to page 40 for details on these features.

- For rear projection, turn rear mode on in the **Settings>System** menu.
- For ceiling mounted projection, turn ceiling mode on in the **Settings>System** menu.
- Specify which source the projector checks first for active video during power-up.
- Specify the function of the Effect button on the remote.
- Turn the projector's display messages on and off.
- Turn on power saving features.
- Specify blank screen colors and start up logos.
- Specify the language viewed on the menus.
- Save settings for the active source as a preset.

Using the menus

To open the menus, press the **Menu** button on the keypad or remote. (The menus automatically close after 60 seconds if no buttons are pressed.) The Main menu appears. Use the arrow buttons to move up and down to highlight the desired submenu, then press the **Select** button.

To change a menu setting, highlight it, press **Select**, then use the up and down arrow buttons to adjust the value, select an option using radio buttons, or turn the feature on or off using check boxes. Press **Select** to confirm your changes. Use the arrows to navigate to another setting. When your adjustments are complete, navigate to Previous or Exit, then press **Select** to go to the previous menu; press the **Menu** button at any time to close the menus.

Dots appear before the menu name. The number of dots indicate menu's level, ranging from one (the Main menu) to four (the most nested menus).

The menus are grouped by usage:

- The Picture menu provides image adjustments.
- The Settings menu provides set-up type adjustments that are not changed often.
- The About menu provides a read-only display of information about the projector and source.

Certain menu items may not be visible or may be grayed depending upon a particular source being connected. For example, Sharpness is only available for video sources and is not visible when a computer source is active. Menu options are grayed out only if the source is selected but no signal is present. For example, if the projector is set to a video source but the source, such as a DVD player, is turned off video menu options are grayed out.

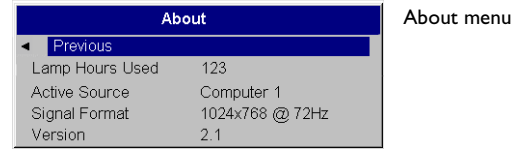
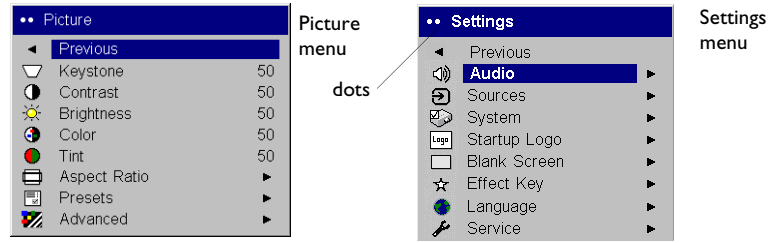
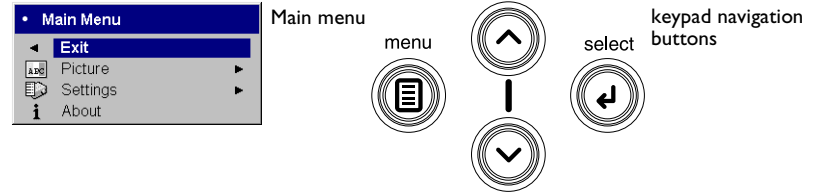

Picture menu

To adjust the following settings, highlight the setting, press **Select**, use the up and down arrows to adjust the values, then press **Select** to confirm the changes.

Keystone: adjusts the image vertically and makes a squarer image. You can also adjust keystone from the keypad.

Contrast: controls the degree of difference between the lightest and darkest parts of the picture and changes the amount of black and white in the image.

Brightness: changes the intensity of the image.

Color: adjusts a video image from black and white to fully saturated color. The color setting applies to video sources only.

Tint: adjusts the red-green color balance in the image of NTSC video images. The tint setting applies to NTSC video sources only.

Aspect Ratio: Aspect ratio is the ratio of the image width to image height. TV screens are usually 4:3. HDTV and most DVDs are 16:9. The default is 4:3.

Select Native to see the unmodified input with no resizing by the projector. Select 16:9 to watch enhanced widescreen DVDs.

For more information regarding Aspect Ratio, see page 16.

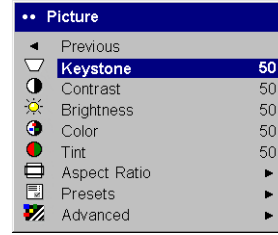

Picture menu

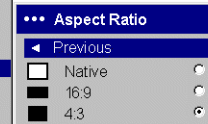
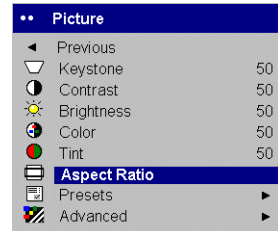
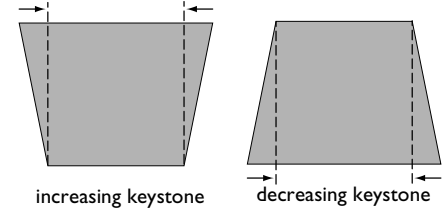

Aspect ratio

Presets: Presets are provided that optimize the projector for displaying computer presentations, photographs, film images, and video images. Film input is material originally captured on a film camera, like a movie; video input is material originally captured on a video camera, like a TV show or sporting event. You can use the preset as a starting point, then further customize the settings for each source. The settings you customize are saved in the preset for each source. To restore the factory default settings, choose Factory Reset in the **Settings>Service** menu (page 40).

There is also a user-definable preset. To set a preset for the current source, adjust the image, select Save User in the Presets menu, then select Yes. You can recall these settings in the future by selecting the User 1 preset.

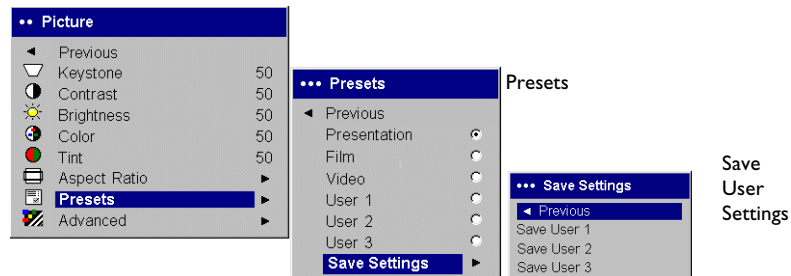

Advanced menu

Sharpness: (video sources only) changes the clarity of the edges of a video image. Select a sharpness setting.

Color Space: This option applies to computer and component video sources. It allows you to select a color space that has been specifically tuned for the input signal. When Auto is selected, the projector automatically determines the standard. To choose a different setting, turn off Auto, then choose RGB for computer sources, choose either SMPTE240, REC709 or REC601 for component video sources.

Color Temperature: changes the intensity of the colors. Select a listed relative warmth value.

Color Control: allows you to individually adjust the gain (relative warmth of the color) and the offset (the amount of black in the color) of the red, green, and blue colors.

Video Standard: when it is set to Auto, the projector attempts to automatically pick the video standard based on the input signal it receives. (The video standard options may vary depending on your region of the world.) If the projector is unable to detect the correct standard, the colors may not look right or the image may appear “torn.” If this happens, manually select a video standard by selecting NTSC, PAL, or SECAM from the Video Standard menu.

Overscan: (video sources only) removes noise around the video image.

Sync Threshold Adjust: If a hardware device, such as a DVD player, is not syncing properly with the projector, select this option to help it to sync when connected to the projector.

The following four (4) options are for computer sources only.

Phase: adjusts the horizontal phase of a computer source.

Tracking: adjusts the vertical scan of a computer source.

Horizontal/Vertical Position: adjusts the position of a computer source.

White Peaking: increases the brightness of whites that are near 100%.

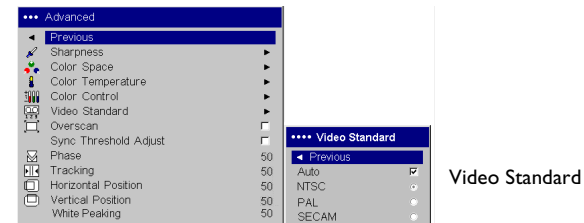
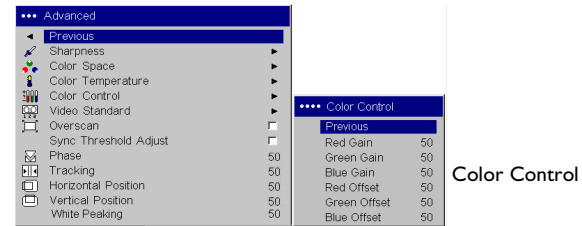
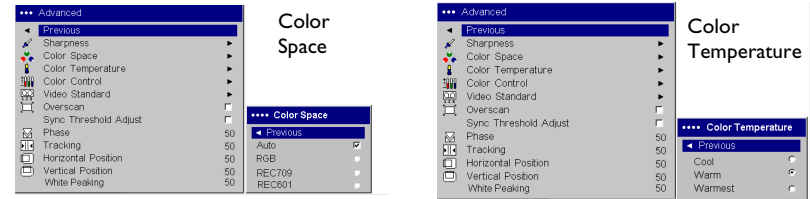
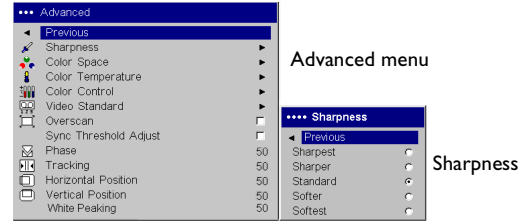

Settings menu

Audio: allows adjustments to Volume of the internal speaker and allows a chime to play when starting the projector. Adjustments can also be made from the projector's keypad and the remote.

Sources: Power-up Source determines which source the projector checks first for active video during power-up. When the **Autosource** feature is On, the projector automatically finds the active source, checking the selected Power-up Source first. The source options are Computer 1 for a computer, progressive DVD, or HDTV source, and Video 1 (for S-video connections), and Video 2 (for composite video connections) for video sources. When this feature is Off, the projector defaults to the source selected in Power-up Source. To display another source, you must manually select one by pressing the **Computer** or **Video** button on the remote or keypad.

System>Rear: reverses the image so you can project from behind a translucent screen. **Ceiling:** turns the image upside down for ceiling-mounted projection. **Low Power:** toggles between on and off. Turn it on to lower the light output of the lamp. This also lowers the fan speed, making the projector quieter. **Display Messages:** displays status messages (such as "Searching" or "Mute") in the lower-left corner of the screen. **Screen Saver Off:** prevents your computer from going into Screen Save mode. **Screen Trigger** turns on the 12 volt DC output switch on the connector panel. **Power Save:** automatically turns the lamp off after no signals are detected for 20 minutes. After 10 additional minutes with no signal, the projector powers down. If an active signal is received before the projector powers down, the image will be displayed. After an additional 10 minutes with no signal, the projector powers down and can be toggled off. If an active signal is received before the projector powers down, the image will be displayed. When Power Save is enabled, Screen Save is disabled. **Screen Save** automatically blanks the screen with a black color after no signals are detected for a preset number of minutes. The image returns when an active source is detected or a remote or keypad button is pressed.

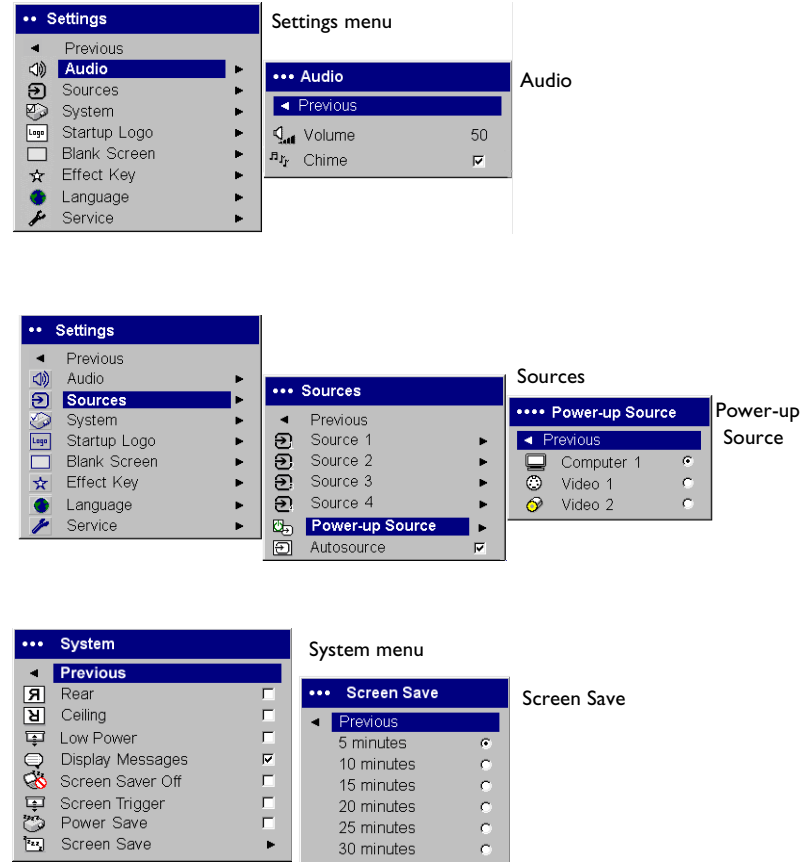

Startup Logo: allows you to display a blank screen instead of the default screen at startup, and when no source is detected.

Blank Screen: determines what color is displayed when you press the Blank button on the remote.

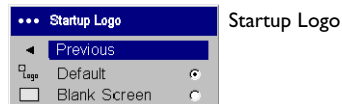

Startup Logo

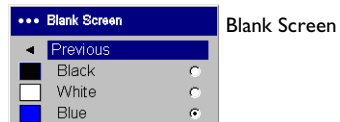

Blank Screen

Effect Key: allows you to assign a different function to the Effect button on the remote, allowing you to quickly and easily use the effect. Highlight an effect and press **Select** to choose a different one.

- **Blank:** displays an empty screen.
- **Mute:** turns off all sound.
- **Aspect Ratio:** toggles among 4:3, 16:9, and Native (see page 16 and page 35). Set as the Effect Key, it can allow you to switch the Aspect Ratio for DVDs.
- **Source:** cycles through available sources.
- **Auto Image:** resets the projector to the source (page 31).
- **Freeze:** pauses the projected image.
- **About:** the default effect. It opens a window with projector and source information.

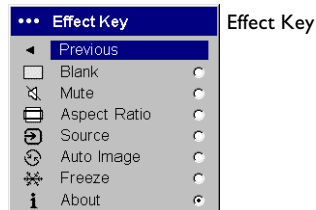

Effect Key

Language: allows you to select a language for the onscreen display.



Language menu

Service: To use these features, highlight them and press **Select**.

Factory Reset: restores all settings to their default.

Lamp Reset: resets the lamp hours used counter in the About menu to zero. Do this only after changing the lamp.

Service Code: only used by authorized service personnel.

About: provides information about the projector and the active source. Showing the About box is the default action assigned to the Effect button.

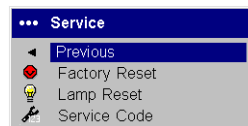

Service menu

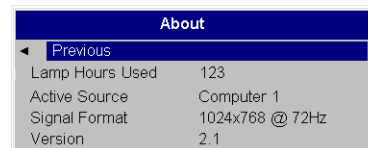

About menu

Maintenance

Cleaning the Lens

- 1 Apply a non-abrasive camera lens cleaner to a soft, dry cloth.
 - Avoid using an excessive amount of cleaner, and don't apply the cleaner directly to the lens. Abrasive cleaners, solvents or other harsh chemicals might scratch the lens.
- 2 Lightly wipe the cleaning cloth over the lens in a circular motion. If you don't intend to use the projector immediately, replace the lens cap.

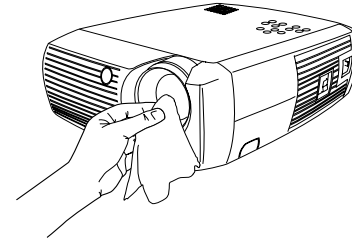

Replacing the Projection Lamp

The lamp hours used timer in the About menu counts the number of hours the lamp has been in use. Twenty hours before the lamp life expires, the message "Change lamp" appears on the screen at startup. If the maximum lamp time is exceeded, the lamp will not light. In this case, after replacing the lamp you must reset the lamp hours by simultaneously pressing both **Volume** buttons on the keypad and holding them for 10 seconds.

NOTE: You can order new lamp housings from your dealer. See the Packing list for information. Use only a replacement lamp with the same type and rating as the original lamp.

- 1 Turn off the projector and unplug the power cord.
- 2 Wait 30 minutes to allow the projector to cool thoroughly.
- 3 Turn the projector on its side so that the lamp door is facing you. Using a flat-blade screwdriver, gently pry the lamp door from the projector by placing the screwdriver blade into the space between the top of the lamp door and the projector.

A screenshot of a computer's 'About' menu. The 'Lamp Hours Used' is highlighted with a blue bar. A line points from the text 'Lamp hours used' to this bar.

| About | |
|-----------------|-----------------|
| ◀ Previous | |
| Lamp Hours Used | 123 |
| Active Source | Computer 1 |
| Signal Format | 1024x768 @ 72Hz |
| Version | 2.1 |

Lamp hours used

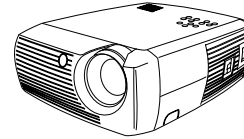

turn off and unplug projector



wait 30 minutes

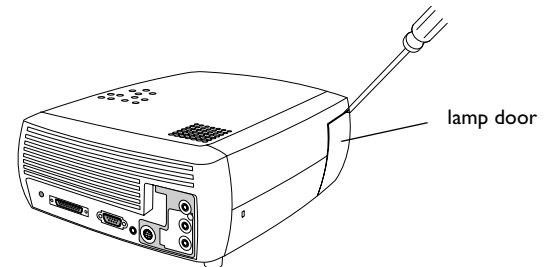

lamp door

- 4 Loosen the two captive screws that attach the lamp housing to the projector.
- 5 Detach the lamp connector from the projector by depressing the locking tab on the connector and lightly pulling it free.

WARNING:

To avoid burns, allow the projector to cool for at least 30 minutes before you replace the lamp.

Do not drop the lamp housing or touch the glass bulb! The glass may shatter and cause injury.

Be extremely careful when removing the lamp housing. In the unlikely event that the bulb ruptures, small glass fragments may be generated. The lamp housing is designed to contain these fragments, but use caution when removing the lamp housing. Before replacing the lamp, clean the lamp compartment and dispose of cleaning materials. Wash hands after lamp replacement. This product has a lamp which contains a very small amount of mercury. Dispose of it as required by local, state or federal ordinances and regulations. For more information see www.eiae.org.

- 6 Carefully remove the lamp housing. Dispose of the lamp in an environmentally proper manner.
- 7 Install the new lamp housing and tighten the screws.
- 8 Re-attach the lamp connector to the projector. The locking tab should engage when the connector is fully plugged in.
- 9 Replace the lamp door.
- 10 Plug in the power cord and toggle the **Power** switch to turn the projector back on.
- 11 To reset the lamp hour timer, navigate to the **Settings>Service** menu and select **Lamp Reset**. See page 40 for details.

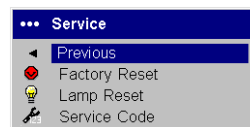
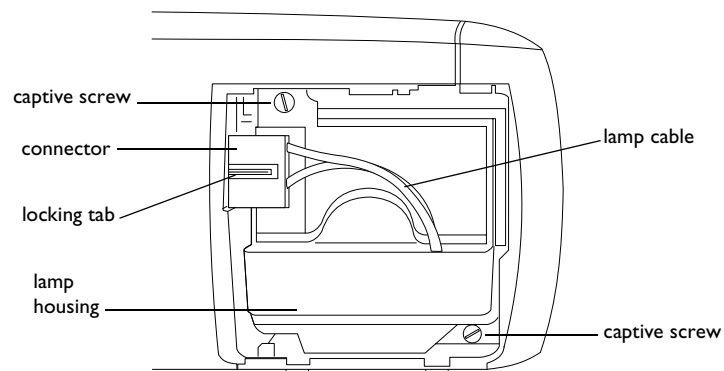
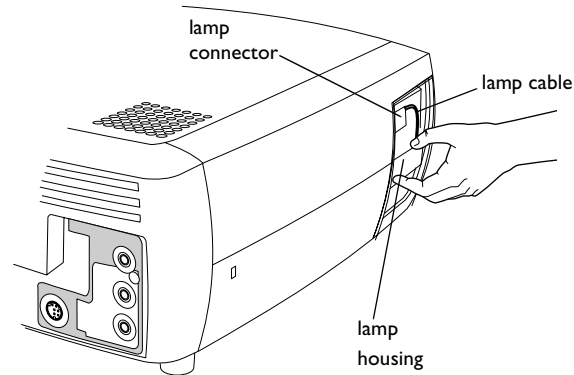

Service menu

Cleaning the Lamp Housing Screens

In dirty or dusty environments, the two dust filter screens in the lamp housing can become clogged, causing high temperatures and premature lamp failure. Routine maintenance to remove dust from the screens lowers the lamp operating temperature and prolongs lamp life. To maximize lamp life you should clean the screen every 250 hours.

- 1 Remove the lamp housing.
- 2 Examine the dust filter screens on the lamp housing. If necessary, use a vacuum cleaner set on low power to clean the screens. Be careful not to disturb any internal components when cleaning the screens.
- 3 Replace the lamp housing and lamp door.

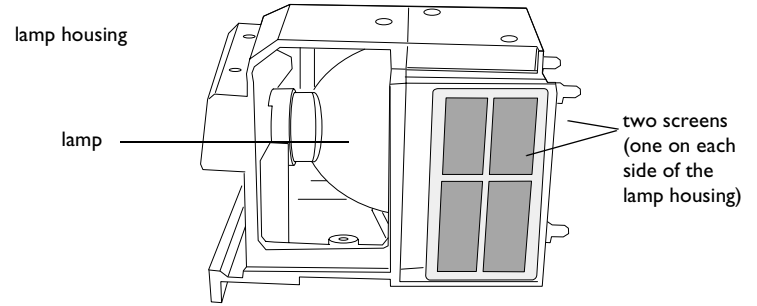

Using the security lock

The projector has a security lock for use with a PC Guardian Cable Lock System. Refer to the information that came with the lock for instructions on how to use it.

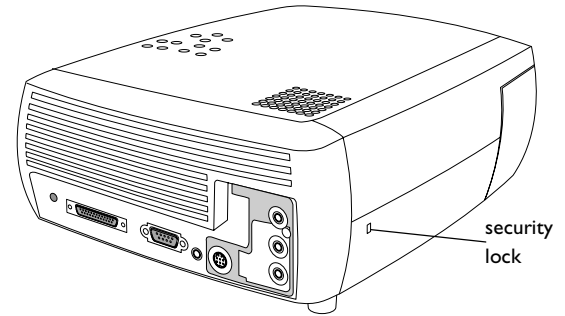

Appendix

Projected Image Size

NOTE: Visit our website for an interactive image size calculator.

Table 2:

Range of distance to the screen for a given screen size for the projector

| Diagonal Screen Size (inches/m) | Image Width (inches/m) | Distance to screen | |
|---------------------------------------|---------------------------|---------------------------------|---------------------------------|
| | | Maximum distance (feet/m) | Minimum Distance (feet/m) |
| 40/1 | 32/0.8 | 5.8/1.8 | 4.8/1.5 |
| 50/1.3 | 40/1 | 7.8/2.4 | 6.5/2.0 |
| 60/1.5 | 48/1.2 | 8.8/2.7 | 7.5/2.3 |
| 100/2.5 | 80/2 | 14.6/4.5 | 12.4/3.8 |
| 150/3.8 | 120/3.1 | 22.6/6.9 | 19.03/5.8 |
| 200/5.1 | 160/4.1 | 30.5/9.3 | 25.2/7.7 |

Red LED Behavior and Projector Errors

If the projector is not functioning properly and the LED is blinking red, consult **Table 3** to determine a possible cause. There are two-second pauses between the blinking cycles. Visit our website for more details on the red LED error codes.

Table 3:

| Red LED Behavior | Explanation |
|------------------|--|
| One (1) blink | The lamp won't strike after five (5) attempts. Check the lamp and lamp door installations for loose connections. |
| Two (2) blinks | The lamp counter hours have exceeded lamp life hours. Replace the lamp and reset the lamp hours counter. |
| Three (3) blinks | The projector has shut down. Check to see if the lamp door is open. If the lamp door is closed, toggle off the projector and wait one minute, then toggle the projector on again. If the lamp does not strike after one minute, replace the lamp. Contact Technical Support (see page 28) for repair if replacing the lamp does not solve the problem. |
| Four (4) blinks | The fan has failed. Contact Technical Support (see page 28) for repair or replacing the fan. |
| Five (5) blinks | The projector is overheating. Check for a blocked air vent or clogged lamp housing screen (previous page). Contact Technical Support for repair if clearing the vents/ screens does not solve the problem. |

INDEX

Numerics

16x9 vs 4x3 screen aspect 16
800x600 resolution 5

A

About 39, 40
Advance menu 37
advancing slides 11
Aspect Ratio 39
Aspect ratio 35
aspect ratio 16
Audio 38
Audio In connector 11, 17, 30
audio input 16
Audio Out 16
Autosource 38

B

Blank button 32
Blank Screen 39
blinking green 21
blinking red 21
Brightness 35

C

cable box 16
Color 35
Color Control 37
Color Space 37
Color Temperature 37
compatibility
 IBM-compatible 5
 Macintosh 5
 video devices 5
Computer In connector 11
connecting
 video device 16
connector panel 6
connectors on projector 9, 10
contacting InFocus 28
Contrast 35
customer service contact information 28
customizing the projector 33

D

Display Messages 38
Drivers
 USB 15
 Windows 98 15
DVDs 35

E

Effect button 32, 33
Effect Key 39

F

Factory Reset 40
focus 13, 20

H

HDTV 8, 35
Horizontal 37

I

IBM-compatible computers 5
image
 size 7
image optimization 32
image size
 projected 44

K

keypad buttons
 projector 31
keystone adjustment 13, 20

L

Lamp Housing Screens
 cleaning 43
lamp replacement 41
Lamp Reset 40
Language 40
LED 21
 blinking green 21
 solid green 21
LED Behavior
 red 44
LED behavior 21
leveling foot 19
Low Power 38

M

M1 to Component adapter 18
Macintosh computers
 compatibility 5
maintaining the projector 41
Menu button 34
menu usage 34
Monitor Out connector 11
Mute button 30

O

optimizing images 32
optimizing video 33
Overscan 37

P

Phase 37
Picture menu 35
Power connector 11
power cord 11, 18
Power Save 21, 38
Power switch 12
Power-up Source 38
presentation
 features 32
Presets 36
projection distance 7
projector
 connecting video devices 16
 connector panel 6
 customization 33
 keypad buttons 31
 maintenance 41
 positioning 7
 setting up 7

troubleshooting problems 21
turning off 21

R

Rear 38
Red LED behavior 44
registering your projector 5
remote control
 advancing slides 11, 29
 Effect key 29
 laser pointer 29
 Previous/Next buttons 29
 usage 29
replacing the lamp 41

S

Screen Aspect 16
Screen Save 21, 38
Screen Saver Off 38
Screen Trigger 38
security lock 43
Service 40
Service Code 40
Settings menu 38
sharpness 37
solid green 21
solid red 21
Sources 38
Startup Logo 39
S-video connector 17
Sync Threshold Adjust 37
System 38

T

Tint 35
Tracking 37
troubleshooting 21
turning off
 projector 21
TV tuner 16

U

USB, connecting 11

V

Vertical 37
video optimizing 33
Video Standard 37
volume adjustment 20
Volume button 30

W

warranty 28
Windows 2000 15
Windows 98 14
Windows ME 15
Windows XP 15

Z

zoom 13, 20

Limited Warranty

Subject to the Limitations, Exclusions and Disclaimers hereof, InFocus Corporation (“InFocus”) warrants that the Projector, Lamps and Accessories (hereinafter collectively or individually referred to as “Product” as appropriate) purchased from InFocus, an InFocus distributor, or an InFocus reseller will conform to InFocus’ specifications and be free from defects in material or workmanship for the respective Limited Warranty period provided below. InFocus does not warrant that the Product will meet the specific requirements of the end-user customer.

If the Product while subject to this Limited Warranty, is defective in material or workmanship during the warranty period, then InFocus, at its option, will REPAIR or REPLACE the Product.

All exchanged parts and Products replaced under this Limited Warranty will become property of InFocus. InFocus’ sole obligation is to supply (or pay for) all labor necessary to repair the Product found to be defective within the Limited Warranty period and to repair or replace defective parts with new parts or, at the option of InFocus, serviceable used parts that are equivalent or superior to new parts performance. Limited Warranty periods are as follows:

- **Projector Product Limited Warranty Period (Excluding Lamps): One (1) Year** from date of purchase.
- **Lamp Product Limited Warranty Periods:** The original installed lamp shall have a **90-day or 500 hour** Limited Warranty Period from date of Projector proof of purchase, whichever comes first. Replacement Lamps purchased at the time of Projector Product purchase will have a 90-day or 500 hours usage Limited Warranty Period from the date of installation, whichever comes first. Replacement lamps purchased after the time of Projector Product purchase shall have a 90-day or 500 hours usage Limited Warranty Period from the date of replacement lamp purchase, whichever comes first.
- **Accessory Product Limited Warranty Period: One (1) Year** from date of purchase.

WARRANTY LIMITATION AND EXCLUSION

THIS WARRANTY SETS FORTH INFOCUS’ MAXIMUM LIABILITY FOR ITS PRODUCT. THIS WARRANTY EXTENDS ONLY TO PRODUCTS PURCHASED FROM INFOCUS OR AN INFOCUS AUTHORIZED RESELLER. InFocus shall have no further obligation under the foregoing Limited Warranty if the Product has been damaged due to abuse, misuse, neglect, smoke exposure (cigarette or otherwise), accident, unusual physical or electrical stress, unauthorized modifications (including use of an unauthorized mount), tampering, alterations, or service other than by InFocus or its authorized agents, causes other than from ordinary use or failure to properly use the Product in the application for which said Product was intended.

This Limited Warranty excludes Product cleaning, repair, or replacement of plastics due to cosmetic damage and damage as a result of normal wear. Product repair outside of the terms of the Limited Warranty will be on a time and materials basis. Prolonged Product “demonstration” causes unusual Product wear and is not considered normal use under the terms of this Limited Warranty.

The Accessory Product Limited Warranty covers the accessory item only and excludes normal wear. The Lamp Product Limited Warranty excludes expected lamp degradation.

Remanufactured Products and Software Products are exempt from the foregoing Limited Warranty. Please refer to the appropriate Remanufactured Product Limited Warranty or Software Product Limited Warranty for applicable Warranty information.

DISCLAIMER OF UNSTATED WARRANTIES

THE WARRANTY PRINTED ABOVE IS THE ONLY WARRANTY APPLICABLE TO THIS PRODUCT. ALL OTHER WARRANTIES, EXPRESS OR IMPLIED, INCLUDING, BUT NOT LIMITED TO, THE IMPLIED WARRANTIES OF MERCHANTABILITY AND FITNESS FOR PARTICULAR PURPOSE ARE DISCLAIMED. THERE ARE NO WARRANTIES THAT EXTEND BEYOND THE DISCRPTION ON THE FACE HEREOF AND THE FOREGOING WARRANTY SHALL NOT BE EXTENDED, ALTERED OR VARIED EXCEPT BY WRITTEN INSTRUMENT SIGNED BY INFOCUS. SOME JURISDICTIONS DO NOT ALLOW LIMITATIONS ON HOW LONG

AN IMPLIED WARRANTY MAY LAST, SO SUCH LIMITATIONS MAY NOT APPLY TO YOU.

Limited Warranty Period

The Limited Warranty periods hereof commence on the date of purchase by the end-user customer. These Limited Warranty provisions shall apply only to the end-user purchaser (first person or entity that purchased a new Product for personal or business use and not for the purpose of distribution or resale). SOME JURISDICTIONS MAY GRANT YOU CONSUMER RIGHTS WITH MINIMUM WARRANTY DURATION THAT DIFFER FROM THE DURATIONS PROVIDED HEREIN, AND INFOCUS WILL HONOR ALL SUCH CONSUMER RIGHTS.

To Be Eligible For Limited Warranty Coverage

Any person exercising a claim under this Limited Warranty must establish to the satisfaction of InFocus both the date of purchase and that the Product was purchased new. The sales receipt or invoice, showing the date of purchase of the Product is the proof of the date of purchase.

To Obtain Warranty Service

During the Limited Warranty period, to exercise this Limited Warranty, the purchaser must first contact 1) InFocus customer support at www.infofocus.com/contactsupport, 2) a service facility authorized by InFocus or 3) the place of original purchase.

For Warranty service, the purchaser will be advised to return or deliver the defective Product freight and all fees prepaid, to an InFocus Service Center or to a service facility authorized by InFocus. When returning Product to InFocus, a Return Material Authorization Number (RMA #) is required and must be clearly displayed on the outside of the shipping carton or a similar package affording an equal degree of protection. InFocus or the service facility authorized by InFocus will return the repaired/replaced Product freight prepaid to the purchaser.

Products returned for Warranty service must be accompanied by a written letter that: (i) explains the problem; (ii) provides proof of date of purchase; (iii) provides the dealer's name; and (iv) provides the model and serial number of the Product. Upon request of InFocus Corporation or an autho-

rized repair center for InFocus, proof of legal import must accompany the warranty repair Product, otherwise the Product must be returned to the place of original purchase, to the manufacturer (Purchaser must bear all tax, duty and freight), or the Purchaser must bear charges for the warranty repair.

No repair or replacement of Product or part thereof shall extend the Limited Warranty period as to the entire Product. Warranty on the repair part and workmanship shall only be effective for a period of ninety (90) days following the repair or replacement of that part or the remaining period of the Product Limited Warranty whichever is greater.

LIMITATION OF LIABILITY

IT IS UNDERSTOOD AND AGREED THAT INFOCUS' LIABILITY WHETHER IN CONTRACT, IN TORT, UNDER ANY WARRANTY, IN NEGLIGENCE OR OTHERWISE SHALL NOT EXCEED THE RETURN OF THE AMOUNT OF THE PURCHASE PRICE PAID BY PURCHASER AND UNDER NO CIRCUMSTANCES SHALL INFOCUS BE LIABLE FOR SPECIAL, INDIRECT, INCIDENTAL OR CONSEQUENTIAL DAMAGES OR LOST PROFITS, LOST REVENUES OR LOST SAVINGS. THE PRICE STATED FOR THE PRODUCTS IS A CONSIDERATION IN LIMITING INFOCUS' LIABILITY.

Limitation on Bringing Action - No action, regardless of form, arising out of the agreement to purchase the Product may be brought by purchaser more than one year after the cause of action has accrued.

Governing Law - Any action, regardless of form, arising out of the agreement to purchase the Product is governed by Oregon law.

Mandatory Arbitration - Any action, regardless of form, arising out of the agreement to purchase the Product is subject to mandatory arbitration.

SOME JURISDICTIONS DO NOT ALLOW THE EXCLUSION OR LIMITATION OF INCIDENTAL OR CONSEQUENTIAL DAMAGES SO THE ABOVE LIMITATION OR EXCLUSION MAY NOT APPLY TO YOU. THIS LIMITED WARRANTY GIVES YOU SPECIFIC LEGAL RIGHTS, AND YOU MAY ALSO HAVE OTHER RIGHTS, DEPENDING ON JURISDICTION.