

myprojectorlamps.com

**The most trusted, dependable name
in projector lamp sales.**



<http://www.myprojectorlamps.com>



<http://www.myprojectorlamps.ca>



<http://www.myprojectorlamps.eu>

The following projector manual has not been modified or altered in any way.

IN20 SERIES

InFocus

Reference Guide



Declaration of Conformity

Manufacturer: InFocus Corporation, 27700B SW Parkway Ave. Wilsonville, Oregon 97070 USA

European Office: Strawinskylaan 585, 1077 XX Amsterdam, The Netherlands

We declare under our sole responsibility that this projector conform to the following directives and norms:

EMC Directive 89/336/EEC, Amended by 93/68/EEC

EMC: EN 55022

EN 55024

EN 61000-3-2

EN 61000-3-3

Low Voltage Directive 73/23/EEC, Amended by 93/68/EEC

Safety: IEC 60950-1: 1st Edition

March, 2006

Trademarks

Apple, Macintosh, and PowerBook are trademarks or registered trademarks of Apple Computer, Inc. IBM is a trademark or registered trademark of International Business Machines, Inc. Microsoft, PowerPoint, and Windows are trademarks or registered trademarks of Microsoft Corporation. Adobe and Acrobat are trademarks or registered trademarks of Adobe Systems Incorporated. InFocus, In Focus, and INFOCUS (stylized) are either registered trademarks or trademarks of InFocus Corporation in the United States and other countries.

FCC Warning

Note: This equipment has been tested and found to comply with the limits for a Class B digital device, pursuant to part 15 of the FCC Rules. These limits are designed to provide reasonable protection against harmful interference in a residential installation. This equipment generates, uses and can radiate radio frequency energy and, if not installed and used in accordance with the instructions, may cause harmful interference to radio communications. However, there is no guarantee that interference will not occur in a particular installation. If this equipment does cause harmful interference to radio or television reception, which can be determined by turning the equipment off and on, the user is encouraged to try to correct the interference by one or more of the following measures:

--Reorient or relocate the receiving antenna.

--Increase the separation between the equipment and receiver.

--Connect the equipment into an outlet on a circuit different from that to which the receiver is connected.

--Consult the dealer or an experienced radio/TV technician for help.

Canada

This Class B digital apparatus complies with Canadian ICES-003.

Cet appareil numérique de la classe B est conforme à la norme NMB-003 du Canada.

Agency Approvals

UL, cUL, TUV

Other specific Country Approvals may apply. Please see product certification label.

This document applies to: IN24, W240, IN26, and W260.

InFocus reserves the right to alter product offerings and specifications at any time without notice.

Table of Contents

Introduction	3
Positioning the projector	5
Projector and device connector guide	6
Connecting a computer source	9
Required computer connections	9
Optional computer connections	9
Displaying an image	10
Adjusting the image	11
Connecting a video device	12
Video device connections	13
Composite video connection	13
S-video connection	13
VESA connection	13
Component video connection	13
Shutting down the projector	14
Troubleshooting your setup	14
Using the remote control	22
Using the audio	23
Using the keypad buttons	24
Optimizing computer images	25
Presentation features	25
Optimizing video images	26
Customizing the projector	26
Using the menus	27
Picture menu	28
Advanced menu	29
Settings menu	31
Maintenance	35
Cleaning the lens	35
Replacing the projection lamp	35
Using the security lock	37

Important Operating Considerations for Safety

- Place the projector in a horizontal position no greater than 15 degrees off axis.
- Locate the projector in a well-ventilated area without any obstructions to intake or exhaust vents. Do not place the projector on a tablecloth or other soft covering that may block the vents.
- Locate the projector at least 4' (1.2 m) away from any heating or cooling vents.
- Use only InFocus-approved ceiling mounts.
- Use only the power cord provided. A surge-protected power strip is recommended.
- Refer to this guide for proper startup and shutdown procedures.
- This product has a lamp which contains a very small amount of mercury. Wash hands after cleaning the area and handling the ruptured lamp. Dispose of it as required by local, state or federal ordinances and regulations. For more information see www.eiae.org.
- In the unlikely event of a lamp rupture, particles may exit through the projector side vents. When the projector is turned on, keep people, food, and drinks out of the "keep out" area under and around the projector, as indicated by the "X" areas below.

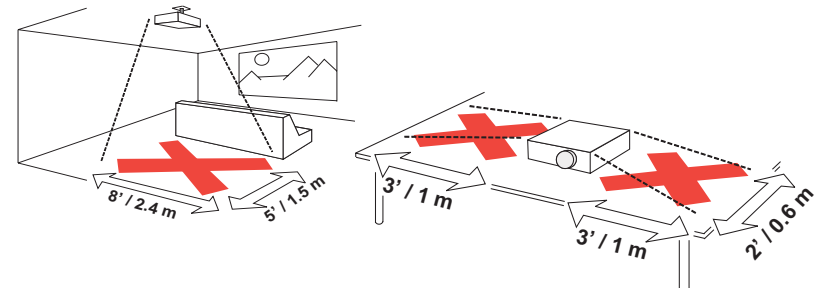

Follow these instructions to help ensure image quality and lamp life over the life of the projector. Failure to follow these instructions may affect the warranty. For complete details of the warranty, see the Warranty booklet.

Introduction

Your new digital projector is simple to connect, easy to use, and straightforward to maintain. It is a versatile projector that is flexible enough for business presentations and home video viewing too. The IN24 has native SVGA 800x600 resolution while the IN26 has native XGA 1024x768 resolution. This guide applies to both products. They are compatible with a wide variety of computers and video devices, including:

- IBM-compatible computers, including laptops, up to 1024x768 resolution for the IN24 and 1400x 1050 for the IN26.
- Apple® Macintosh® and PowerBook® computers up to 1024x768 resolution for the IN24 and 1400x 1050 for the IN26.
- Most standard VCRs, DVD players (progressive and interlaced), progressive DVD, HDTV sources, TV and satellite tuners, camcorders, video games, and laser disc players.

Product specifications

To read the latest specifications on your multimedia projector, be sure to visit our website at www.infocus.com, as specifications are subject to change.

Accessories

The standard accessories that came with your projector are listed in the included user's guide. Optional accessories can be found on our website at www.infocus.com or at your retailer or dealer.

Online Registration

Register your projector on our website at www.infocus.com/register to activate your warranty and receive product updates, announcements, and registration incentives.

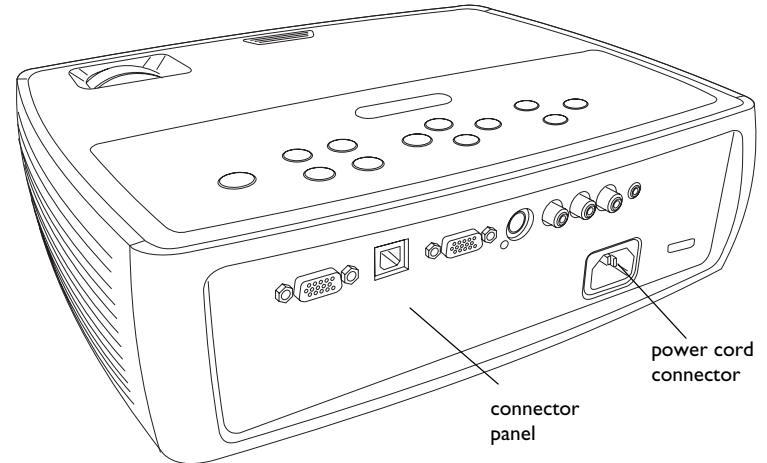
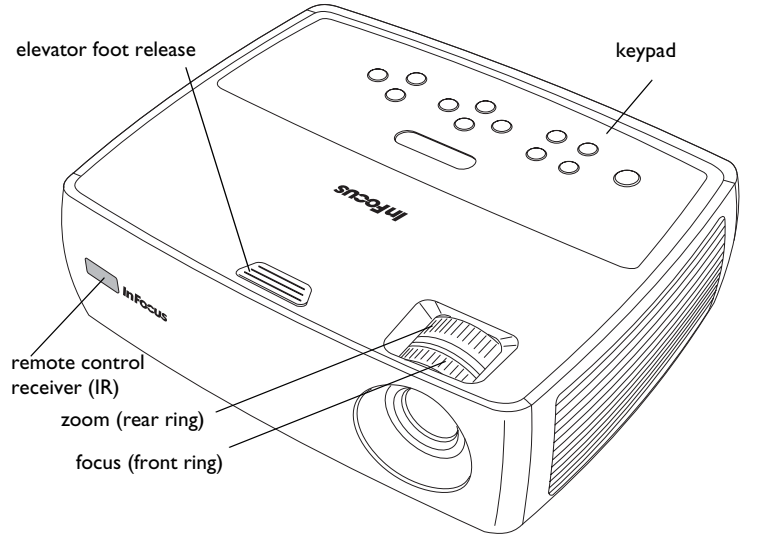

Connector Panel

The projector provides both computer and video connection options, including:

- VESA computer
- S-video
- Composite RCA audio/video

The projector also provides the following connectors:

- Monitor out, to provide an image on your desktop computer as well as on the projection screen
- Audio out, to provide sound for external speakers
- USB, to provide mouse control (used with an optional remote control only)

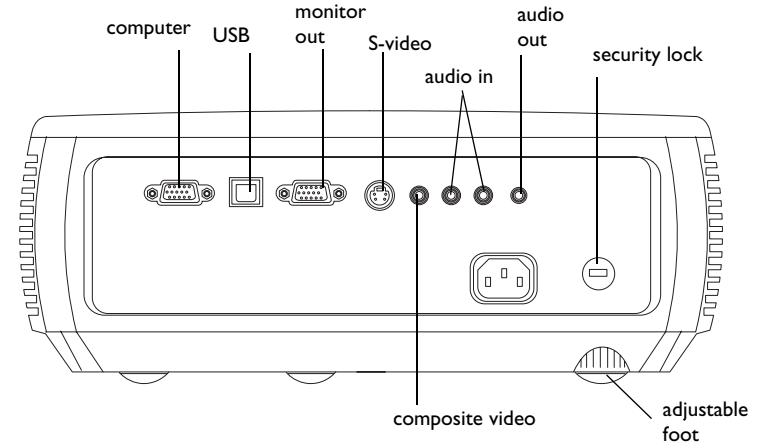

Positioning the projector

To determine where to position the projector, consider the size and shape of your screen, the location of your power outlets, and the distance between the projector and the rest of your equipment. Here are some general guidelines:

- Position the projector on a flat surface at a right angle to the screen. The projector must be at least 4.9 feet (1.5m) from the projection screen.
- Position the projector within 10 feet (3m) of your power source and within 6 feet (1.8m) of your video device (unless you purchase extension cables). To ensure adequate cable access, do not place the projector within 6 inches (.15m) of a wall or other object.
- If you are installing the projector on the ceiling, refer to the installation guide that comes with the Ceiling Mount Kit for more information. To turn the image upside down, see “Ceiling” on page 31. We recommend using an InFocus authorized ceiling mount.
- Position the projector the desired distance from the screen. The distance from the lens of the projector to the screen, the zoom setting, and the video format determine the size of the projected image.
- The image exits the projector at a given angle. This image offset is 112.2%. This means that if you have an image 10' high, the bottom of the image will be 1.12' above the center of the lens.

Table 1:

Range of distance to the screen for a given screen size

Diagonal Screen Size (inches/m)	Distance to screen	
	Maximum distance (feet/m)	Minimum Distance (feet/m)
60/1.5	8.5/2.5	7.9/2.4
80/2	11.3/3.4	10.6/3.2
92/2.3	13.0/3.9	12.2/3.7
150/3.8	21.2/6.4	19.8/6.0

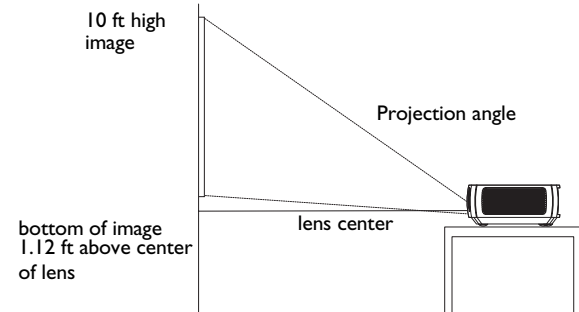

Projector and device connector guide

The following illustration and table should help you find the connectors to use and obtain the best resolution possible from your input devices, such as computers, standard VCRs, DVD players (progressive and interlaced), HDTV sources (1080i and 720p HDTV formats), TV and satellite tuners, camcorders, video games (progressive and interlaced), and laser disc players.

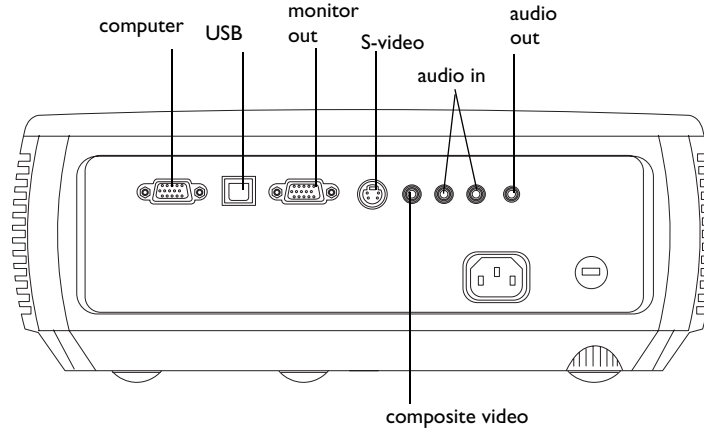

Video Device	Video Compatibility	If Your Device Connector Is	Attach to Adapter or Labeled Connector on Projector	For Setup Instructions, see	Comments
Standard Broadcast TV (not HDTV) via: cable, digital cable, satellite TV, DVD, or VCR	NTSC, PAL, and SECAM formats	Composite video or S-video	Video 2 or S-video 1	Composite video connection on page 13. S-video connection on page 13	Not for progressive (i.e. HDTV) sources. See page 8.
Standard Video Camera	NTSC, PAL, and SECAM formats	Composite video or S-video	Video 2 or S-video 1	Composite video connection on page 13. S-video connection on page 13	Not for progressive (i.e. HDTV) sources. See page 8.
Standard Video Game	NTSC, PAL, and SECAM formats	Composite video or S-video	Video 2 or S-video 1	Composite video connection on page 13. S-video connection on page 13	Not for progressive (i.e. HDTV) sources. See page 8.

Video Device	Video Compatibility	If Your Device Connector Is	Attach to Adapter or Labeled Connector on Projector	For Setup Instructions, see	Comments
HDTV (High Definition TV)	1080i, 720p Component 480i	VGA Component video	Computer In Computer In via optional VESA to Component adapter	VESA connection on page 13 Component video connection on page 13	
Progressive DVD	1080i, 720p Component 480p and 480i	VGA Component video	Computer In Computer In via optional VESA to Component adapter	VESA connection on page 13 Component video connection on page 13	
Progressive Video Game	1080i, 720p Component 480p and 480i	VGA Component video	Computer In Computer In via optional VESA to Component adapter	VESA connection on page 13 Component video connection on page 13	

Connecting a computer source

Required computer connections

Connect one end of the provided computer cable to the **Computer In** connector on the projector and the other to the VESA connector on your computer. If you are using a desktop computer, you will need to disconnect the monitor cable from the computer's video port first (you can connect this monitor cable to the **Monitor Out** connector on the projector, see below).

Connect the black power cord to the **Power** connector on the back of the projector and to your electrical outlet.

NOTE: Always use the power cord that shipped with the projector.

Optional computer connections

To get sound from the projector, connect an audio cable (optional cable, not included) to your computer and to the red and/or white **Audio In** connectors on the projector. You may also need an adapter.

If you are using a desktop computer and want to see the image on your computer screen as well as on the projection screen, connect the computer's monitor cable to the **Monitor Out** connector on the projector.

To advance slides in a PowerPoint presentation using an optional remote control, plug the USB cable into the USB mouse connector on your computer and the **USB** connector on the projector.

connect computer cable

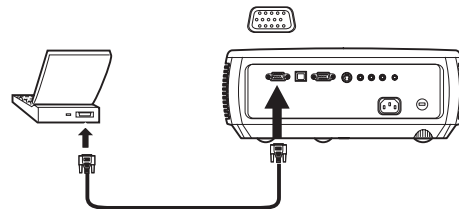

connect audio cable

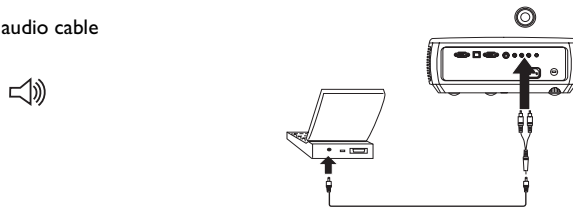

connect monitor cable

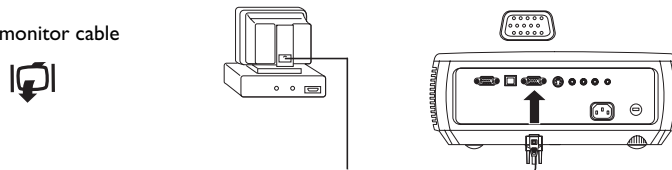

connect USB cable

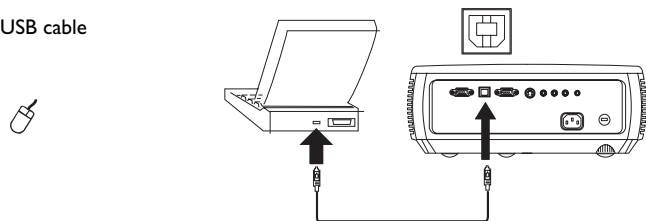

Displaying an image

Press the **Power** button.

The Power light on the Status Indicator Panel (page 14) blinks green and the fans start to run. When the lamp comes on, the start up screen displays and the Power light is steady green. It can take a minute for the image to achieve full brightness.

? No start up screen? Get help on page 14.

Turn on your computer or video device.

The image should appear on the projection screen. If it doesn't, press the **Source** button on the projector's keypad or remote.

If using a laptop, make sure it's external video port is active.

Many laptops do not automatically turn on their external video port when a projector is connected. Usually a key combination like FN + F8 or CRT/LCD key turns the external display on and off. Locate a function key labeled CRT/LCD or a function key with a monitor symbol. Press FN and the labeled function key simultaneously. **Refer to your laptop's documentation to learn your laptop's key combination.**

? No laptop image? Try pressing the **Auto Image** button on the keypad. Get help on page 15.

press Power button

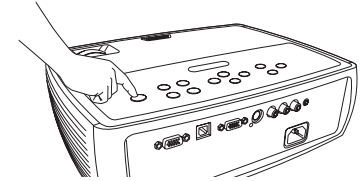

turn on computer or video device

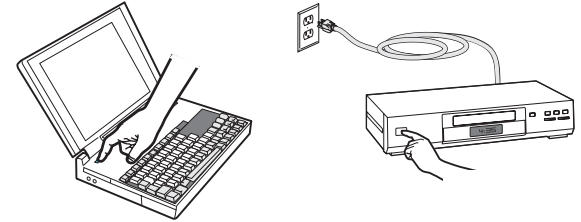

activate laptop's external port

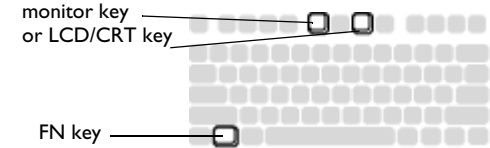

Adjusting the image

If necessary, adjust the height of the projector by pressing the elevator foot release button to extend the foot.

If necessary, rotate the leveling foot located at the rear of the projector.

Avoid placing your hands near the hot exhaust vent at the side of the projector.

Position the projector the desired distance from the screen at a 90 degree angle to the screen.

See page 5 for a table listing screen sizes and distances.

Adjust the zoom or focus.

If the image is not square, first make sure that the projector is perpendicular to the screen. If the image is larger or smaller on the top or bottom edge of the screen, press the top **Keystone** button to reduce the upper part of the image, and press the bottom **Keystone** button to reduce the lower part.

If the left or right side of the screen is larger or smaller the other, you can turn the projector to the left or to the right a few degrees to square the image.

Adjust the Contrast or Brightness in the Picture menu. See page 28 for help with these menu adjustments.

For Aspect Ratio, keep in mind that DVD players must be configured for 16:9 in order to view the highest quality image. For more information regarding Aspect Ratio, see page 12.

adjust height

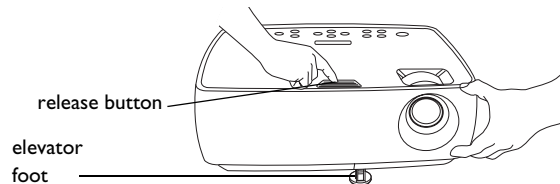

adjust distance

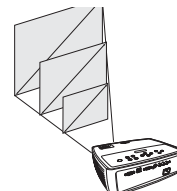

adjust zoom or focus

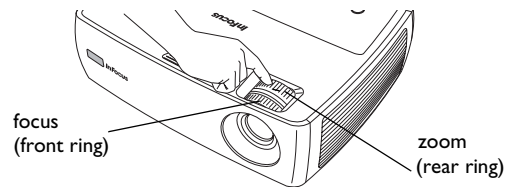

adjust keystone

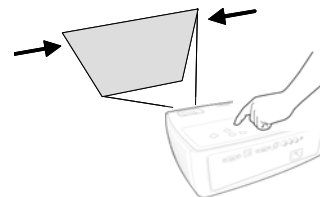

adjust Picture menu

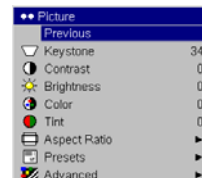

Connecting a video device

You can connect video devices such as VCRs, DVD players, camcorders, digital cameras, video game consoles, HDTV receivers, and TV tuners to the projector. There is also an audio input via the red and white A/V connectors. You can connect the audio directly to the projector to get sound from the built-in speaker, or you can bypass the projector's audio system and connect the audio directly from your source to a stereo or home theater system.

You can connect the projector to most video devices that can output video. You cannot directly connect the coaxial cable that enters your house from a cable or satellite company, the signal must pass through a tuner first. Examples of tuners are digital cable boxes, VCRs, digital video recorders, and satellite TV boxes. Basically, any device that can change channels is considered a tuner.

Before connecting your projector, you should decide which aspect ratio you want to use. The projector's Aspect Ratio setting is accessed through the projector's Picture Menu. See page 28 for more information.

What is Aspect Ratio?

Aspect ratio is the ratio of the image width to image height. TV screens are usually 4:3, which is the default for this projector. HDTV and most DVDs are 16:9. If you're projecting onto a screen, the size/shape of the screen may determine which aspect ratio to use. If you are projecting onto a blank wall, you don't have the screen size restriction. What you plan to project will also help you choose between 4:3 and 16:9. Most TV shows are 4:3, while most movies are 16:9.

If you have a 16:9 screen then you should select an aspect ratio of 16:9 for anamorphic movies or HDTV, and Native for 4:3 content. If you have a 4:3 screen you should still use 16:9 for anamorphic movies or HDTV, but you also have the option of using either 4:3 (to fill the screen) or Native (for direct pixel mapping) for 4:3 content. Keep in mind that anamorphic movies only appear correctly if the DVD player is set to output to a 16:9 television.

4:3 screen

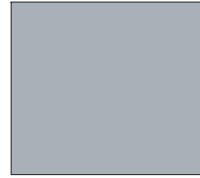

16:9 screen



4:3 mode



16:9 mode



Native mode (NTSC only)

Video device connections

No video cables are provided with the projector. You can order cables from InFocus or provide your own.

Composite video connection

Plug the A/V cable's yellow connector into the video-out connector on the video device. Plug the other yellow connector into the yellow **Video 2** connector on the projector.

Plug a white connector into the left audio out connector on the video device and plug a red connector into the right audio out connector on the video device. Plug the remaining white connector into the white **audio in** connector on the projector, and plug the remaining red connector into the red **audio in** connector on the projector.

Keep in mind that video output from composite connections is not as high quality as S-video.

S-video connection

If your video device uses a round, four-prong S-video connector, plug an S-video cable into the S-video connector on your video device and into the **S-video 1** connector on the projector. Use the A/V cable's red and white audio connectors as described directly above (the yellow connectors on the A/V cable are not used).

Keep in mind that S-video delivers higher quality video output than composite.

VESA connection

If your video device has a 15-pin VGA output, plug one end of the included computer cable into the VGA connector on your video source. This connector may be labeled "To Monitor" on the video source. Plug the computer cable into the **Computer In** connector on the projector.

Component video connection

If your HD video device has component connectors, an optional Component to VESA adapter can be used. Plug the component cable into the video device. Plug the other end of the component cable into the adapter and plug the adapter into the **Computer in** connector. Component offers the highest quality video output.

Shutting down the projector

The projector automatically displays a black screen after no active source is detected for 30 minutes. This black screen helps preserve the life of the projector. The image returns when an active source is detected or a remote or keypad button is pressed.

Screen Save

You can make the black screen appear after a preset number of minutes by turning on the Screen Save feature in the **Settings>System** menu. See page 31.

Power Save

The projector also has a Power Save feature that automatically turns the lamp off after no active sources are detected and no user interaction with the projector is performed for 20 minutes. By default, this feature is off. See page 31.

Turning off the projector

To turn the projector off, press the **Power** button on the remote or keypad two times (the second time verifies the shut-down request). The lamp turns off and the Power light on the Status Indicator Panel blinks green for one (1) minute while the fans continue to run to cool the lamp. While the light is blinking green, the projector does not accept any keypad and remote control input. When the lamp has cooled, the Power light is solid green.

Troubleshooting your setup

If your image appears correctly on the screen, skip to the next section. If it does not, troubleshoot the setup.

The Status Indicator Panel on top of the projector indicates the state of the projector and can help you troubleshoot.

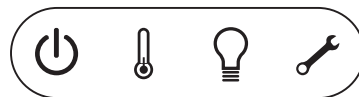





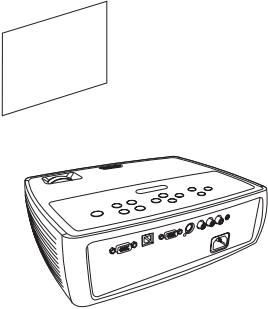
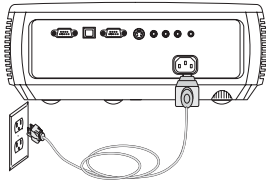
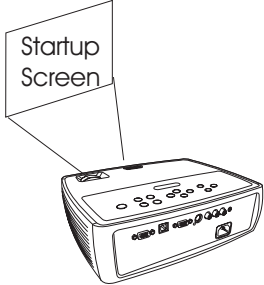
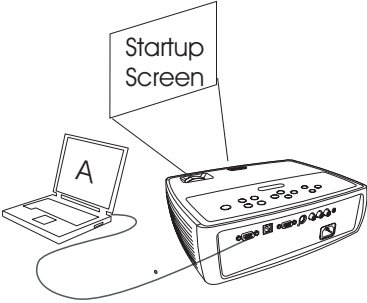

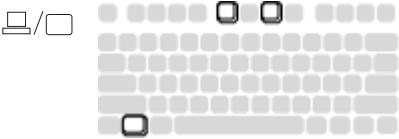
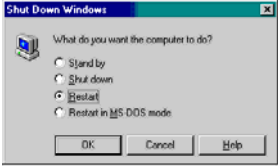
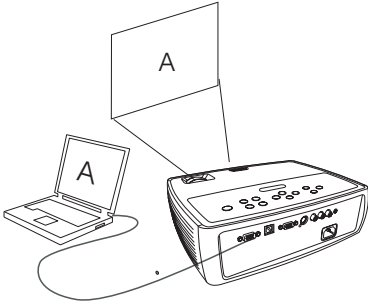
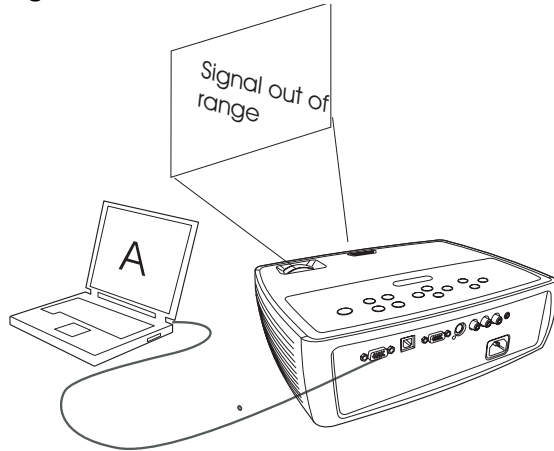

Table 2: Status indicator light behavior and meaning

Status Indicator Panel icons	Meaning
Power, solid green 	The power button has been pressed and the software has initialized or the projector has been powered off.
Power, blinking green 	The power button has been pressed and the software is initializing, or the projector is powering down and the fans are running to cool the lamp.
Thermometer 	The projector is too hot. Make sure the vents aren't blocked (see page 20). Turn off the projector and wait one minute, then turn the projector on again. Contact Technical Support if the problem persists.
Lamp 	Turn off the projector and wait one minute, then turn the projector on again. If the lamp light turns on again, replace the lamp and reset the lamp timer.
Wrench/Service 	Turn off the projector and wait one minute, then turn the projector on again. If the service lamp turns on again, service is required. Visit www.infocus.com/service to contact Service.

Problem	Solution	Result
<p data-bbox="48 158 260 181">no start up screen</p> 	<p data-bbox="663 158 1055 215">plug power cord into the projector press power button</p> 	<p data-bbox="1187 158 1347 181">correct image</p> 
<p data-bbox="48 577 371 600">only start up screen appears</p> 	<p data-bbox="663 569 1006 626">press the Source button  activate laptop's external port</p>  <p data-bbox="680 827 836 850">restart laptop</p> 	<p data-bbox="1187 580 1489 603">computer image projected</p> 

no computer image, just the words “Signal out of range”



press the Auto Image button on keypad
adjust computer refresh rate in Control Panel>Display>Settings>Advanced>Adapter (location varies by operating system)

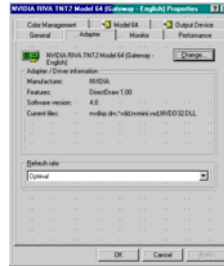

you may also need to set a different resolution on your computer, as shown in the following problem, “image fuzzy or cropped”

computer image projected

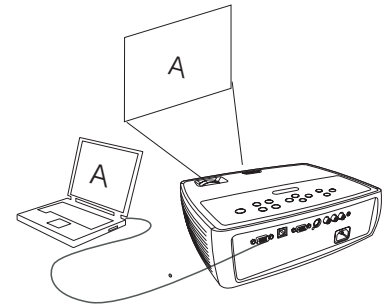

Only my laptop's background appears, not the Desktop icons

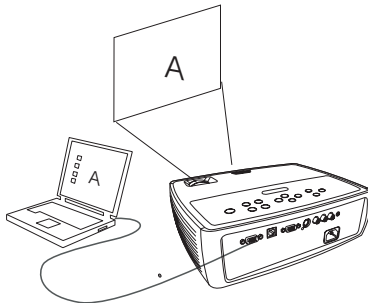

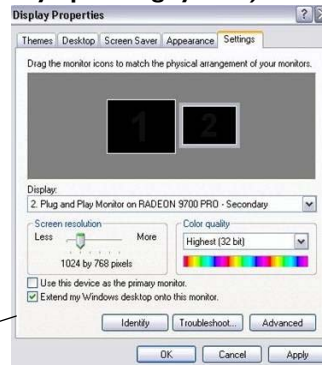

Disable “Extend my Windows Desktop” in Control Panel>Display>Settings>Display 2 (location varies by operating system)





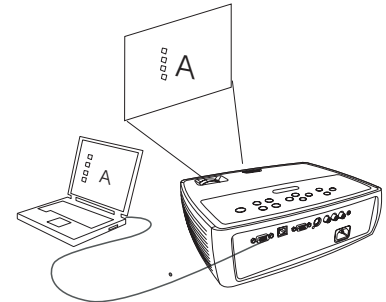

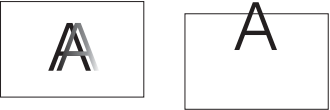
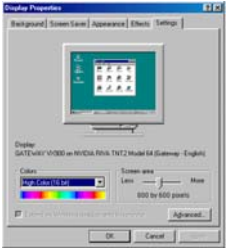

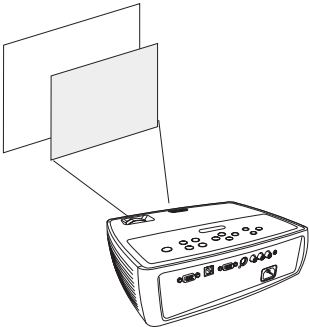
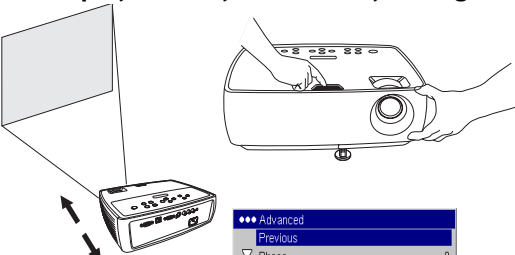
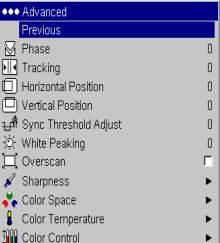
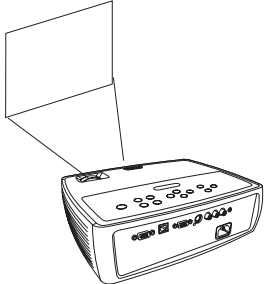

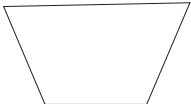
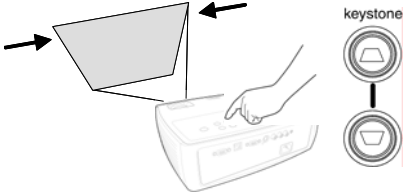

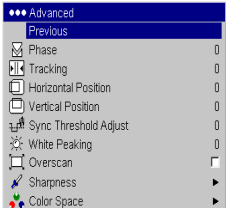

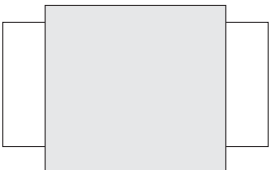
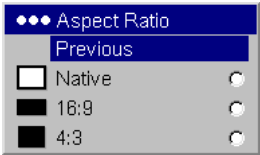
Uncheck this option, then click Apply

Background and Desktop projected

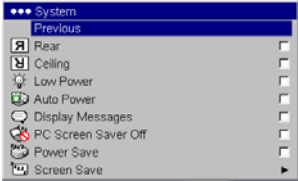

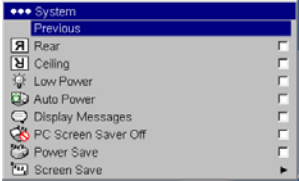
Problem	Solution	Result
<p>image fuzzy or cropped</p> 	<p>set your computer's display resolution to the native resolution of the projector (Start>Settings>Control Panel>Display>Settings tab) select 800x600 for IN24 and 1024x768 for IN26</p> <p>For a laptop, disable laptop monitor or turn-on dual-display mode</p> 	<p>image clear and not cropped</p> 
<p>image not centered on screen</p> 	<p>move projector, adjust zoom, adjust height</p>  <p>adjust horizontal or vertical position in Picture>Advanced menu</p> 	<p>correct image</p> 

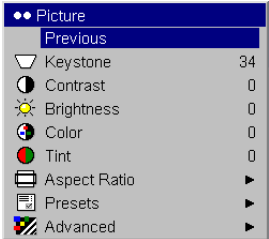
Problem	Solution	Result
<p>image not square</p> 	<p>adjust Keystone on keypad</p> 	<p>square image</p> 
<p>image not sharp</p> 	<p>adjust Sharpness in the Picture>Advanced menu</p> 	<p>correct image</p> 
<p>image does not fit 4:3 or 16:9 screen</p> 	<p>change aspect ratio to 4:3 or 16:9 in Picture>Aspect ratio menu</p> 	<p>correct image</p> 

Problem	Solution	Result
<p>image upside down</p> 	<p>turn off ceiling in Settings>System menu</p> 	<p>correct image</p> 
<p>image reversed left to right</p> 	<p>turn off rear in Settings>System menu</p> 	<p>correct image</p> 
<p>projected colors don't match source</p> 	<p>adjust color, tint, color temperature, brightness, contrast, color space in the menus</p> 	<p>correct image</p> 

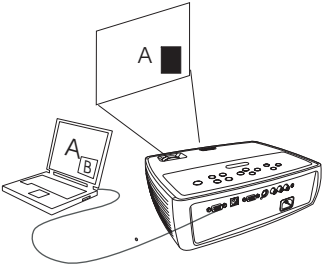
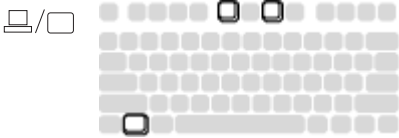
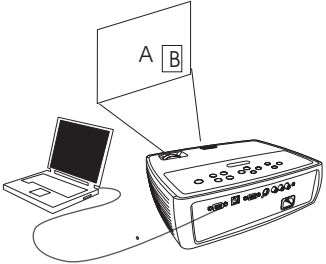
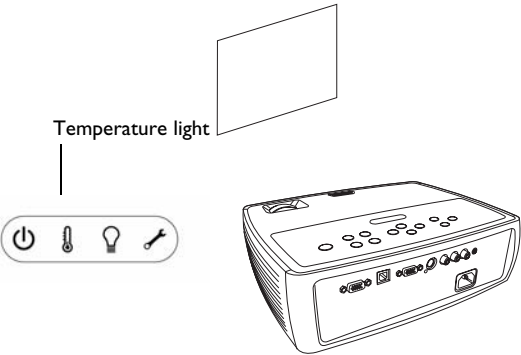
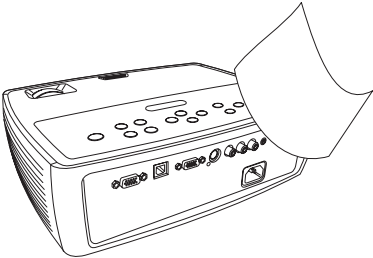
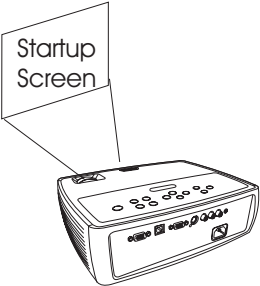
Problem	Solution	Result
<p data-bbox="53 112 512 166">The video embedded in my PowerPoint presentation does not play on the screen</p> 	<p data-bbox="664 112 1124 166">turn off the internal LCD display on your laptop</p> 	<p data-bbox="1187 120 1550 150">Embedded video plays correctly</p> 
<p data-bbox="53 525 548 555">lamp won't turn on, Temperature light is on</p> 	<p data-bbox="664 468 1152 549">make sure vents aren't blocked, turn off the projector and allow it to cool for one minute</p> 	<p data-bbox="1187 525 1348 555">lamp turns on</p> 

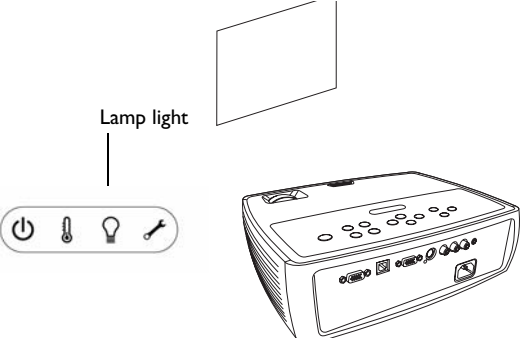
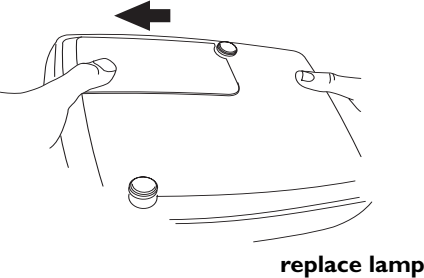
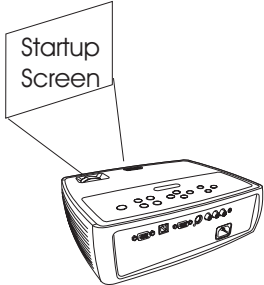
Problem	Solution	Result
<p data-bbox="53 123 614 173">“Change lamp” message appears at startup, lamp won’t turn on, Lamp light is turned on</p> 	<p data-bbox="666 133 1078 158">lamp must be replaced (see page 35)</p> 	<p data-bbox="1189 115 1347 141">lamp turns on</p> 

Still need assistance?

If you need assistance, visit our website at www.infocus.com/service or call us. Check out our HOW TO section there for additional information on using this projector for home theater or gaming applications. See the user’s guide for support contact information.

This product is backed by a limited warranty. An extended warranty plan may be purchased from your dealer. When sending the projector in for repair, we recommend shipping the unit in its original packing material, or having a professional packaging company pack the unit. Please insure your shipment for its full value.

Using the remote control

The remote uses two (2) provided AA batteries. They are easily installed by sliding the cover off the remote's back, aligning the + and - ends of the batteries, sliding them into place, and then replacing the cover.

Caution: When replacing the batteries, be aware that using batteries other than the type provided with the projector may risk severe damage to the remote. When disposing of the batteries, be sure to do so in an environmentally proper manner.

To operate, point the remote at the front of the projector (not at the computer). The range of optimum operation is about 15 feet (4.5m).

Press the remote's **Power** button to turn the projector on and off (see page 14 for shutdown info).

Press the remote's **Menu** button to open the projector's menu system. Use the arrow buttons to navigate, and the **Select** button to select features and adjust values in the menus. See page 27 for more info on the menus.

The remote also has a **Source** button to switch between sources.

Troubleshooting the remote

- Make sure the batteries are installed in the proper orientation and are not dead.
- Make sure you're pointing the remote at the projector or the screen, not the computer, and are within the remote range of 15 feet (4.5m). For best results, point the remote at the projector.

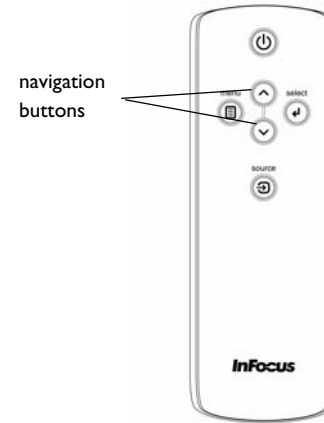

Using the audio

Using the projector's speaker

To use the projector's speaker, connect your source to the **Audio In** connectors (**L** and/or **R**) on the projector's composite connectors.

To adjust the volume, press the **Volume** buttons on the keypad.

Troubleshooting Audio

If you aren't hearing the audio, check the following:

- Make sure the audio cable is connected.
- Make sure the volume is turned up enough. Press the **Volume** button on the keypad or remote.
- Make sure the correct source is active.
- Make sure that you are connected to an "audio out" connector on the source as opposed to a "line-in" or "microphone" connector.
- Adjust the audio source.
- If playing a video, make sure the playback has not been paused.

Connecting external speakers

The projector can be attached to external amplified speakers by connecting a 3.5mm stereo audio cable from the **Audio Out** connector on the projector to the amplified speakers. Alternatively, you can bypass the projector's audio system and connect the audio directly from your source to a stereo or home theater system.

connect audio cable

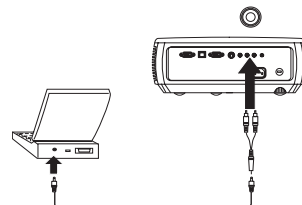

adjust volume

volume

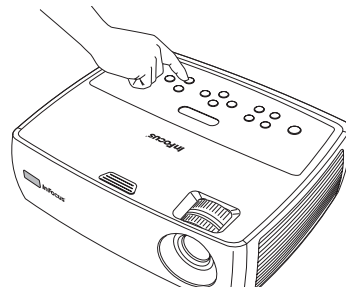

external speakers
with own power source

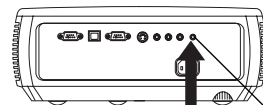
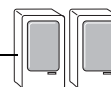

audio out

speaker
cable



Using the keypad buttons

Most buttons are described in detail in other sections, but here is an overview of their functions:

Power—turns the projector on and off (page 10).

Auto Image—resets the projector to the source.

Presets—cycles through the available preset settings (page 29).

Keystone—adjusts squareness of the image (page 11).

Menu—opens the on-screen menus (page 27).

Select—confirms choices made in the menus (page 27).

Up/Down arrows—navigates to and adjusts settings in the menus (page 27).

Volume—adjusts sound (page 23).

Source—changes the active source.

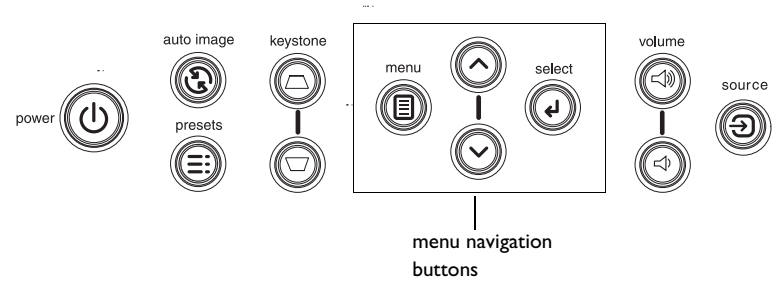

Optimizing computer images

After your computer is connected properly and the computer's image is on the screen, you can optimize the image using the onscreen menus. For general information on using the menus, see page 27.

- Adjust the Keystone, Contrast, or Brightness in the Picture menu (page 28).
- Change the Aspect Ratio. Choose the option that best fits your input source (page 28).
- Adjust the Color Temperature in the Advanced menu (page 30).
- Adjust the Phase, Tracking, or Horizontal or Vertical position in the Advanced menu (page 29).
- Once you have optimized the image for a particular source, you can save the settings using Presets. This allows you to quickly recall these settings later (page 29).

Presentation features

Several features are provided to make giving presentations easier. Here is an overview, details are found in the menu section.

- The Custom key, available on several optional remotes only, allows you to assign various features to the button. The default effect is Source Info, which displays information about the projector and current source. See page 32 for details.
- The Startup Logo option lets you change the default start up screen to a blank or default screen (page 32).
- Two options, Power Save and Screen Save, are provided to automatically shut down the projector after several minutes of inactivity or display a black screen. This helps preserve lamp life (page 31).

Optimizing video images

After your video device is connected properly and the image is on the screen, you can optimize the image using the onscreen menus. For general information on using the menus, see page 27.

- Adjust the Keystone, Contrast, Brightness, Color, or Tint in the Picture menu (page 28).
- Change the Aspect Ratio. Choose the option that best fits your input source (page 28).
- Select a Sharpness setting (page 30).
- Use the Color Control to adjust the color gain (page 30).
- Adjust the Color Temperature. Select a listed warmth value (page 30).
- Turn on Overscan to remove noise on the edges of the image.

Customizing the projector

You can customize the projector for your specific setup and needs. See page 31 to page 33 for details on these features.

- For rear projection, turn rear mode on in the **Settings>System** menu.
- For ceiling mounted projection, turn ceiling mode on in the **Settings>System** menu.
- Specify which source the projector checks first for active video during power-up.
- Specify the function of the Custom key on the optional remote.
- Turn the projector's display messages on and off.
- Turn on power saving features.
- Specify blank screen colors and start up logos.
- Specify the language viewed on the menus.
- Save settings for the active source as a preset.

Using the menus

To open the menus, press the **Menu** button on the keypad or remote. (The menus automatically close after 60 seconds if no buttons are pressed.) The Main menu appears. Use the arrow buttons to move up and down to highlight the desired submenu, then press the **Select** button.

To change a menu setting, highlight it, press **Select**, then use the up and down arrow buttons to adjust the value, select an option using radio buttons, or turn the feature on or off using check boxes. Press **Select** to confirm your changes. Use the arrows to navigate to another setting. When your adjustments are complete, navigate to Previous or Exit, then press **Select** to go to the previous menu; press the **Menu** button at any time to close the menus.

Dots appears before the menu name. The number of dots indicate menu's level, ranging from one (the Main menu) to four (the most nested menus).

The menus are grouped by usage:

- The Picture menu provides image adjustments.
- The Settings menu provides set-up type adjustments that are not changed often.
- The Source Info menu provides a read-only display of information about the projector and source.

Certain menu items may not be visible or may be grayed depending upon a particular source being connected. For example, Sharpness is only available for video sources and is not visible when a computer source is active. Menu options are grayed out only if the source is selected but no signal is present. For example, if the projector is set to a video source but the source, such as a DVD player, is turned off video menu options are grayed out.

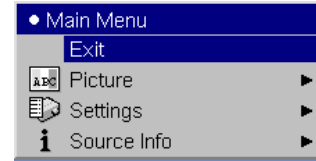

Main menu

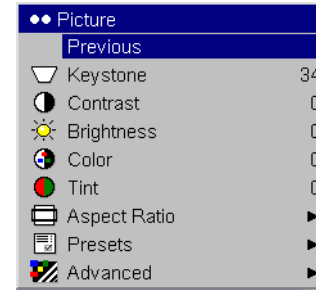
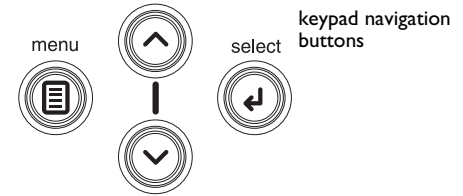

Picture menu

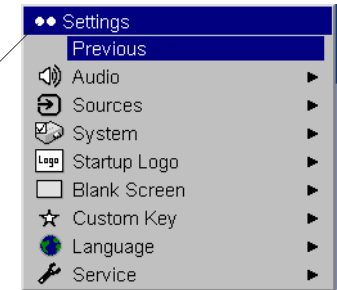

Settings menu



Source Info menu

Picture menu

To adjust the following settings, highlight the setting, press **Select**, use the up and down arrows to adjust the values, then press **Select** to confirm the changes.

Keystone: adjusts the image vertically and makes a squarer image. You can also adjust keystone from the keypad.

Contrast: controls the degree of difference between the lightest and darkest parts of the picture and changes the amount of black and white in the image.

Brightness: changes the intensity of the image.

Color: adjusts a video image from black and white to fully saturated color. The color setting applies to video sources only.

Tint: adjusts the red-green color balance in the image of NTSC video images. The tint setting applies to NTSC video sources only.

Aspect Ratio: Aspect ratio is the ratio of the image width to image height. TV screens are usually 4:3. HDTV and most DVDs are 16:9. The default is 4:3.

Select Native to see the unmodified input with no resizing by the projector. Select 16:9 to watch enhanced widescreen DVDs.

For more information regarding Aspect Ratio, see page 12.

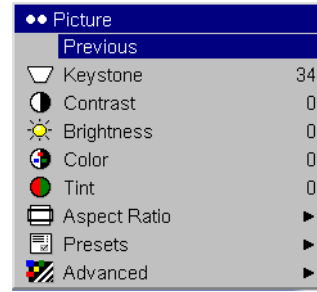

Picture menu

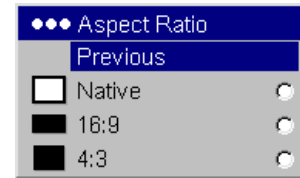
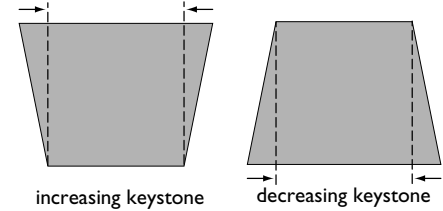

Aspect ratio

Presets: Presets are provided that optimize the projector for displaying computer presentations, film images, and video images. Film input is material originally captured on a film camera, like a movie; video input is material originally captured on a video camera, like a TV show or sporting event.

There are also user-definable presets. To set a preset for the current source, adjust the image, select Save Settings in the Presets menu, then select Save User 1 (or 2 or 3). You can recall these settings in the future by selecting the User 1 preset. If you select User Presets then further adjust the image, Presets Off will automatically be selected in the Preset menu to indicate changes have been made.

To restore the factory default settings, choose Factory Reset in the **Settings>Service** menu (page 33).

Advanced menu

The following four (4) options are for progressive and computer sources.

Phase: adjusts the horizontal phase of a computer source.

Tracking: adjusts the vertical scan of a computer source.

Horizontal/Vertical Position: adjusts the position of a computer source.

Sync Threshold Adjust: (progressive signals only) If a hardware device, such as a DVD player, is not syncing properly with the projector, select this option to help it to sync when connected to the projector.

White Peaking: (video sources only) increases the brightness of whites that are near 100%.

Overscan: removes noise around the video image.

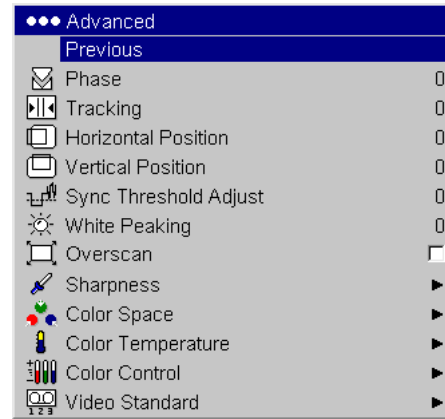
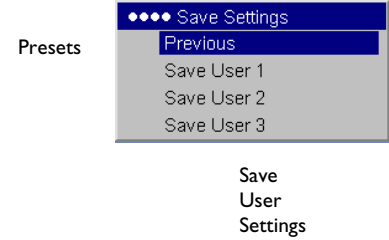
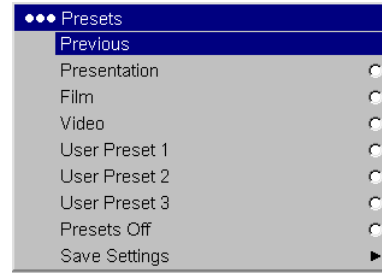

Advanced menu

Sharpness: (video sources only) changes the clarity of the edges of a video image. Select a sharpness setting.

Color Space: This option applies to computer and component video sources. It allows you to select a color space that has been specifically tuned for the input signal. When Auto is selected, the projector automatically determines the standard. To choose a different setting, turn off Auto, then choose RGB for computer sources, choose either REC709 or REC601 for component video sources.

Color Temperature: changes the intensity of the colors. Select a listed relative warmth value.

Color Control: allows you to individually adjust the gain (relative warmth of the color) and the offset (the amount of black in the color) of the red, green, and blue colors. Note that offset adjustments are only available for computer sources.

Video Standard: when it is set to Auto, the projector attempts to automatically pick the video standard based on the input signal it receives. (The video standard options may vary depending on your region of the world.) If the projector is unable to detect the correct standard, the colors may not look right or the image may appear “torn.” If this happens, manually select a video standard by selecting NTSC, PAL, or SECAM from the Video Standard menu.

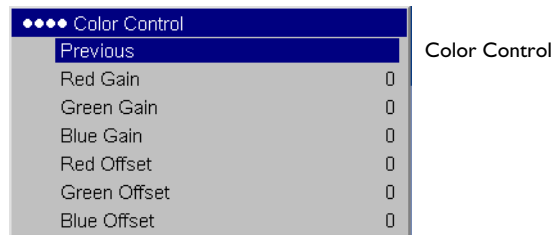
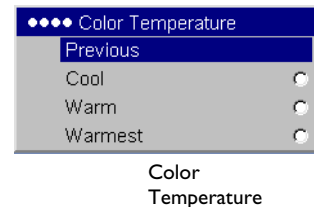
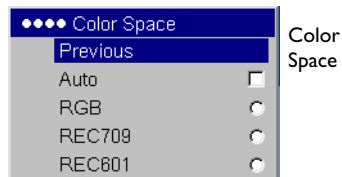
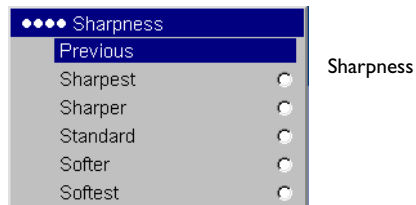

Settings menu

Audio: allows adjustments to Volume of the internal speaker and allows a chime to play when starting the projector. Volume adjustments can also be made from the projector's keypad.

Sources: **Power-up Source** determines which source the projector checks first for active video during power-up. When the **Autosource** feature is On, the projector automatically finds the active source, checking the selected Power-up Source first. The source options are Computer for a computer, progressive DVD, or HDTV source, and S-video and Composite for video sources. When this feature is Off, the projector defaults to the source selected in Power-up Source. To display another source, you must manually select one by pressing the **Source** button on the remote or keypad.

System>Rear: reverses the image so you can project from behind a translucent screen. **Ceiling:** turns the image upside down for ceiling-mounted projection. **Low Power:** toggles between on and off. Turn it on to lower the light output of the lamp. This also lowers the fan speed, making the projector quieter. **Auto Power:** When Auto Power is checked, the projector automatically starts up after the projector is powered on. This allows control of ceiling mounted projectors with a wall power switch. **Display Messages:** displays status messages (such as "Searching") in the lower-left corner of the screen. **PC Screen Saver Off:** prevents your computer from going into Screen Save mode. The projector must be connected to the PC via a USB cable for this feature to work. **Power Save:** automatically turns the lamp off after no signals are detected for 20 minutes. After 10 additional minutes with no signal, the projector powers down. If an active signal is received before the projector powers down, the image will be displayed. After an additional 10 minutes with no signal, the projector powers down and can be toggled off. If an active signal is received before the projector powers down, the image will be displayed. When Power Save is enabled, Screen Save is disabled. **Screen Save** automatically blanks the screen with a black color after no signals are detected for a preset number of minutes. The image returns when an active source is detected or a remote or keypad button is pressed.

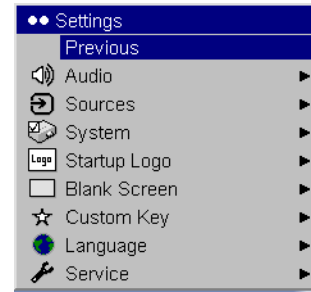

Settings menu

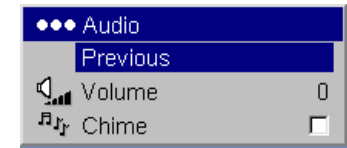

Audio

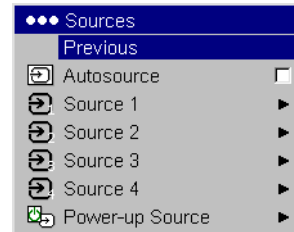

Sources

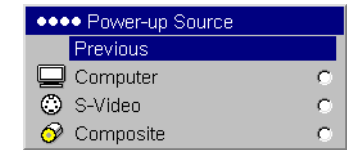

Power-up Source

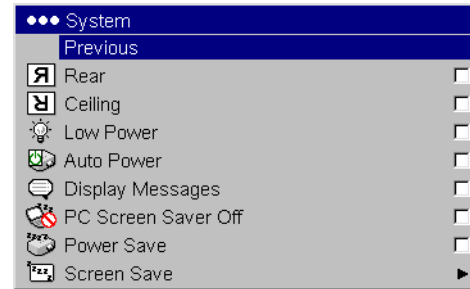

System menu

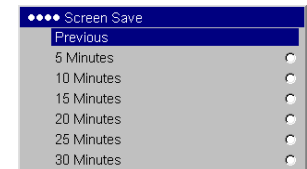

Screen Save

Startup Logo: allows you to display a blank screen instead of the default screen at startup, and when no source is detected.

Blank Screen: determines what color is displayed when you press the Blank button on the remote.



Startup Logo

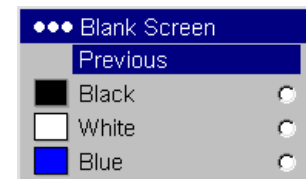

Blank Screen

Custom Key (for use with optional remote only): allows you to assign a different function to the Custom button on an optional remote, allowing you to quickly and easily use the effect. Highlight an effect and press **Select** to choose a different one.

- **Blank:** displays an empty screen.
- **Mute:** turns off all sound.
- **Aspect Ratio:** toggles among 4:3, 16:9, and Native (see page 12 and page 28).
- **Source:** cycles through available sources.
- **Auto Image:** resets the projector to the source (page 24).
- **Freeze:** pauses the projected image.
- **Source Info:** the default effect. It opens a window with projector and source information.
- **Service Info:** opens a window with projector and source information.

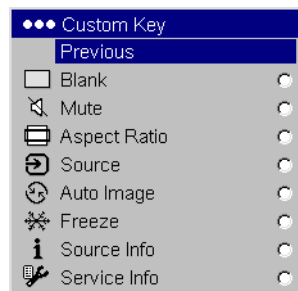

Custom Key

Language: allows you to select a language for the onscreen display.



Language menu

Service: To use these features, highlight them and press **Select**.

Factory Reset restores all settings to their default. **Reset Lamp Hours** resets the lamp hours used counter in the Service Info menu to zero. Do this only after changing the lamp. **PIN** functionality, see the next section. **Test Pattern** allows you to display certain patterns to adjust the image. This feature only works with an optional remote. To display test patterns, click the Test Pattern check box, exit the menus, then press the **Blank** button on the remote. To select the patterns, use the up/down arrows on the remote or keypad. To exit the test patterns, press the **Blank** button again.

Service Code: only used by authorized service personnel. **Service Info:** provides information about the projector and lamp.

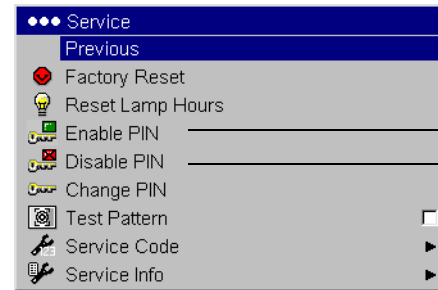

Service menu

appears only when PIN is disabled

appears only when PIN is enabled



Service Info menu

PIN feature

The PIN (personal identification number) feature allows you to password protect your projector. Once you enable the PIN feature, you must enter the PIN before you can project an image.

To use this feature, you must register your projector at www.infocus.com/register and follow the instructions there to get a default PIN. The PIN consists of a sequence of 5 navigation button presses. The navigation buttons are menu, select, up arrow and down arrow. Once you have this PIN, select Enable PIN in the Service menu. The Enter PIN dialog box appears.

Use the navigation buttons on the remote or keypad to enter the correct button press sequence. After pressing the first button, a dot appears in the current PIN slot and the highlighted cursor moves to the right one slot. When all 5 numbers are entered correctly, press the **Select** button on the remote or keypad to select OK. If the message “Incorrect PIN” appears, verify the code and re-enter it. If you mis-enter a number, you must enter 5 numbers and press the **Select** button in order to access the “Incorrect PIN” message and re-enter the code.

To enter the PIN at projector startup:

Power up the projector. The “Enter PIN” dialog box appears after the startup screen. Enter the PIN. Use the navigation buttons on the remote or keypad to enter the correct button press sequence. See the description above for instructions. If you lose or forget your PIN, go to www.infocus.com/pin.

To change the PIN:

Select “Change PIN” in the Service menu. Enter the existing PIN. Enter the new PIN. You can navigate between OK and Cancel by pressing the up and down buttons on the keypad. Select OK or Cancel by pressing the **Select** button. Verify the new PIN.

To reset the PIN back to the default:

Power up the projector. After the “Enter PIN” dialog box appears, press and hold the **Select** button down for 10 seconds. Enter the default PIN to use the projector. If you lose or forget your default PIN, go to www.infocus.com/pin.



Maintenance

Cleaning the lens

- 1 Apply a non-abrasive camera lens cleaner to a soft, dry cloth.
 - Avoid using an excessive amount of cleaner, and don't apply the cleaner directly to the lens. Abrasive cleaners, solvents or other harsh chemicals might scratch the lens.
- 2 Lightly wipe the cleaning cloth over the lens in a circular motion.

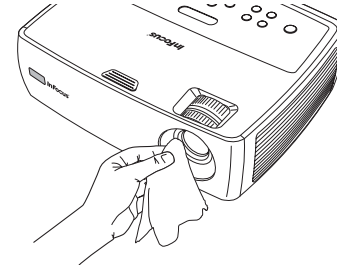

Replacing the projection lamp

The lamp hours used timer in the Service Info menu counts the number of hours the lamp has been in use. Twenty hours before the lamp life expires, the message “Change lamp” appears on the screen at startup.

NOTE: You can order new lamp housings from www.infocus.com (in select areas), your retailer or your dealer. Use only a replacement lamp with the same type and rating as the original lamp.

- 1 Turn off the projector and unplug the power cord.
- 2 Wait 60 minutes to allow the projector to cool thoroughly.
- 3 Turn the projector upside down on a soft cloth so that the lamp door is facing you.
- 4 Slide the lamp door off.

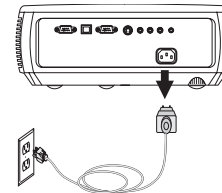
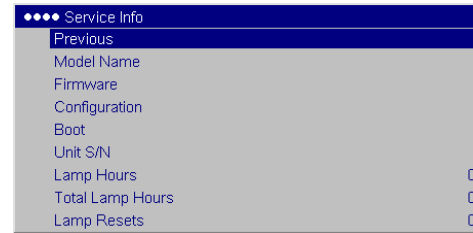

turn off and unplug projector



wait 60 minutes

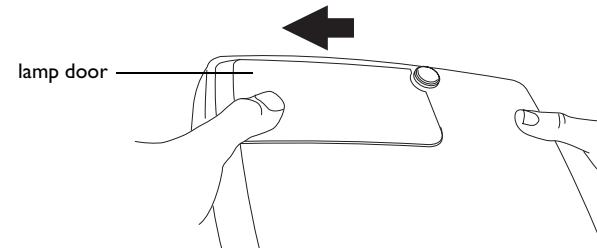

WARNING:

Be extremely careful when removing the lamp housing. In the unlikely event that the bulb ruptures, small glass fragments may be generated. The lamp housing is designed to contain these fragments, but use caution when removing the lamp housing. Before replacing the lamp, clean the lamp compartment and dispose of cleaning materials. Wash hands after lamp replacement. This product has a lamp which contains a very small amount of mercury. Dispose of it as required by local, state or federal ordinances and regulations. For more information see www.eiae.org.

- Detach the lamp connector from the projector by depressing the locking tab on the connector and lightly pulling it free.
- Loosen the captive screw that attaches the lamp housing to the projector. Carefully remove the lamp housing. Dispose of the lamp in an environmentally proper manner.
- Install the new lamp housing and tighten the screw.
- Re-attach the lamp connector to the projector. The locking tab should engage when the connector is fully plugged in.
- Replace the lamp door by sliding it into place. Be sure the lamp connector wires are not in the way.
- Plug in the power cord and press the **Power** button to turn the projector back on.
- To reset the lamp hour timer, navigate to the **Settings>Service** menu and select **Reset Lamp Hours**. See page 33 for details.

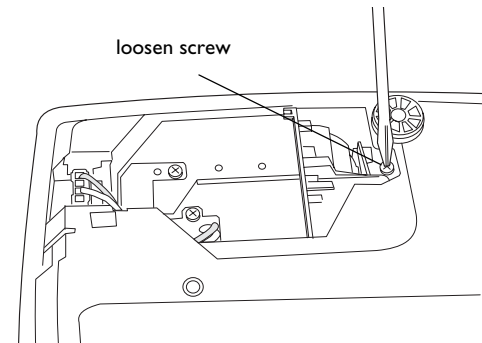
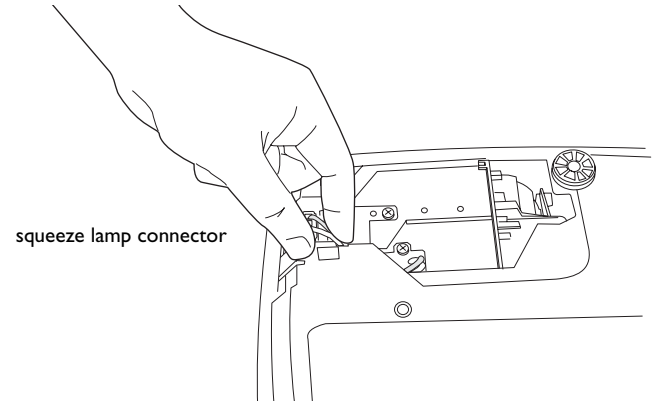

Service menu

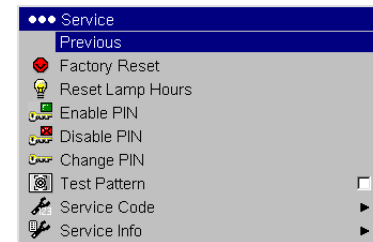

Using the security lock

The projector has a security lock for use with a PC Guardian Cable Lock System. Refer to the information that came with the lock for instructions on how to use it.

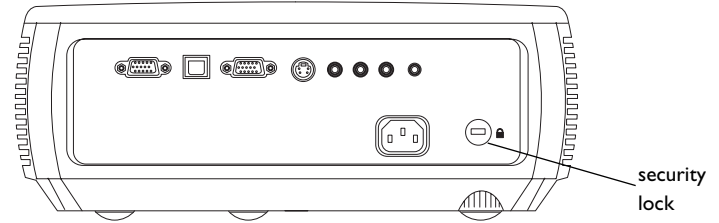

INDEX

Numerics

16x9 vs 4x3 12

A

Advanced menu 29

Aspect Ratio 12, 28, 32

Audio In connector 9, 13, 23

audio input 12

Audio menu 31

Autosource 31

B

Blank Screen 32

Brightness 28

C

cable box 12

cleaning the lens 35

Color 28

Color Control 30

Color Space 30

Color Temperature 30

compatibility

 IBM-compatible 3

 Macintosh 3

 video devices 3

Computer In connector 9

connecting

 computer 9

 computer monitor 9

 external speakers 23

 video device 12

connector panel 4

connectors on projector 7, 8

contacting InFocus 21

Contrast 28

Custom key 25, 32

customer service contact information 21

customizing the projector 26

D

Display Messages 31

DVDs 28

F

Factory Reset 33

focus 11

H

HDTV 6, 28
Horizontal 29

I

IBM-compatible computers 3
image
 optimization 25
 size 5

K

keypad buttons 24
keystone, adjusting 11

L

lamp hours, resetting 36
lamp replacement 35
Language 33
laptop video port activation 10
LEDs 14
Low Power 31

M

Macintosh computers 3
maintaining the projector 35
Menu button 27
menu usage 27
Monitor Out connector 9

O

optimizing images 25
optimizing video 26
Overscan 29

P

password-protecting the projector 34
PC Screen Saver Off 31
personal identification number 34
Phase 29
Picture menu 28
PIN 34
positioning the projector 5
Power connector 9
power cord 9
Power Save 14, 31
Power-up Source 31
presentation features 25
Presets 29
projection distance 5
projector
 connecting computers 9
 connecting video devices 12
 connector panel 4
 customization 26
 image size 5
 keypad buttons 24
 language 33
 maintenance 35
 menus 27
 offset 5
 password-protecting 34
 PIN 34
 positioning 5
 registering 3
 reset 33
 resolution 3
 safety considerations 2

- security lock 37
- setting up 5
- shutting down 14
- Status Indicator Panel 14
- troubleshooting problems 14

R

- Rear 31
- registering your projector 3
- remote control 22
- replacing the lamp 35
- resetting the projector 33
- resolution 3

S

- Screen Aspect 12
- Screen Save 14, 31
- security lock 37
- Service 33
- Service Code 33
- Settings menu 31
- sharpness 30
- shutting down the projector 14
- Sources 31
- speakers, connecting external 23
- Startup Logo 32
- Status Indicator Panel 14
- S-video connector 13
- System 31

T

- Tint 28
- Tracking 29
- troubleshooting 14
- TV tuner 12

U

- USB 4, 9

V

- Vertical 29
- video devices, connecting 13
- video optimizing 26
- Video Standard 30
- Volume button 23

W

- warranty 21

Z

- zoom 11