

***myprojectorlamps.com***

**The most trusted, dependable name  
in projector lamp sales.**



<http://www.myprojectorlamps.com>



<http://www.myprojectorlamps.ca>



<http://www.myprojectorlamps.eu>

The following projector manual has not been modified or altered in any way.

# SP8600 ( SERIES )



Regulatory models: H8300

**InFocus**  
Bright Ideas Made Brilliant

## Declaration of Conformity

Manufacturer: InFocus Corporation, 27500 SW Parkway Ave. Wilsonville, Oregon 97070 USA

We declare under our sole responsibility that this projector conforms to the following directives and norms:

EMC Directive 2004/108/EC

EuP Directive 2005/32/EC

EMC: EN 55022

EN 55024

EN 61000-3-2

EN 61000-3-3

Low Voltage Directive 2006/95/EC

Safety: IEC 60950-1:2005, MOD

## Trademarks

Apple, Macintosh, and PowerBook are trademarks or registered trademarks of Apple Computer, Inc. IBM is a trademark or registered trademark of International Business Machines, Inc. Microsoft, PowerPoint, and Windows are trademarks or registered trademarks of Microsoft Corporation. Adobe and Acrobat are trademarks or registered trademarks of Adobe Systems Incorporated. DLP® and the DLP logo are registered trademarks of Texas Instruments and BrilliantColor™ is a trademark of Texas Instruments. InFocus, In Focus, and INFOCUS (stylized) are either registered trademarks or trademarks of InFocus Corporation in the United States and other countries.

## FCC Warning

This device complies with part 15 of the FCC Rules. Operation is subject to the following two conditions: (1) This device may not cause harmful interferences, and (2) this device must accept any interference received, including interference that may cause undesired operation.

**NOTE:** This equipment has been tested and found to comply with the limits for a Class B digital device, pursuant to part 15 of the FCC Rules. These limits are designed to provide reasonable protection against harmful interference in a residential installation. This equipment generates, uses and can radiate radio frequency energy and, if not installed and used in accordance with the instructions, may cause harmful interference to radio communications. However, there is no guarantee that interference will not occur in a particular installation. If this equipment does cause harmful interference to radio or television reception, which can be determined by turning the equipment off and on, the user is encouraged to try to correct the interference by one or more of the following measures:

--Reorient or relocate the receiving antenna.

--Increase the separation between the equipment and receiver.

--Connect the equipment into an outlet on a circuit different from that to which the receiver is connected.

--Consult the dealer or an experienced radio/TV technician for help.

Changes or modifications not expressly approved by InFocus Corporation may void authority to operate the equipment.

## Canada

This Class B digital apparatus complies with Canadian ICES-003.

Cet appareil numérique de la classe B est conforme à la norme NMB-003 du Canada.

## Agency Approvals

UL, cUL

Other specific Country Approvals may apply. Please see product certification label.

This document applies to regulatory model H8300.

Input ratings: AC 100-240V, 4.3-1.6A, 50-60Hz

InFocus reserves the right to alter product offerings and specifications at any time without notice.

## Table of Contents

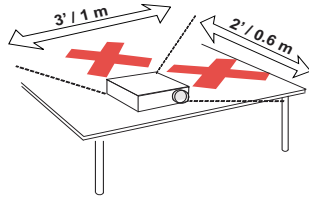
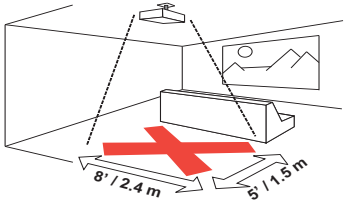
Introduction	5
Positioning the projector	7
Ceiling Mount	8
Cable management	9
Connecting power	10
Connecting a computer source	10
Displaying an image	11
Adjusting the image	12
Connecting a video device	13
Video device connections	13
Shutting down the projector	15
Troubleshooting your setup	15
Using the remote control	23
Using the keypad buttons	24
Optimizing computer images	24
Presentation features	24
Optimizing video images	25
Customizing the projector	25
Using the menus	26
Basic Picture menu	27
Advanced Picture menu	28
Setup menu	29
Status and Service menu	31
Help	31
Maintenance	32
Cleaning the lens	32
Replacing the projection lamp	33
Using the security lock	34
Appendix	35
SplitScreen Compatibility	35
RS-232 commands	36
Index	44



## Important Operating Considerations for Safety

- Refer to this guide for proper startup and shutdown procedures.
- Follow all warnings and cautions in this manual and on the projector.
- Place the projector in a horizontal position no greater than 8 degrees off axis.
- Locate the projector at least 4' (1.2m) away from any heating or cooling vents.
- Do not block ventilation openings. Locate the projector in a well-ventilated area without obstructions to intake or exhaust vents. Do not place the projector on a tablecloth or other soft covering that may block the vents.
- Do not place the projector in direct sunlight, humid, greasy or dusty places or in places where the projector may come into contact with smoke or steam.
- Do not touch the exhaust vents. This area will become hot while the projector is being used. Be sure children are kept away from this area.
- Do not look directly into the lens while the projector is being used. Be especially careful that children do not stare directly into the lens.
- Do not push objects of any kind into this projector through its venting as object may touch dangerous voltage that could result in a fire or electrical shock.
- Do not drop the projector.
- Do not spill liquid on the projector. Spilled liquid may damage the projector.
- Do not place any object on the projector.
- Do not stand or step on the projector.
- Use the power cord provided. Connect the power cord to a receptacle with a protective safety (earth) ground terminal. The AC power cord has a three-pin grounding-type power plug. This plug will only fit a grounding-type power outlet. This is a safety feature. Do not remove the grounding pin on the power plug.
- A surge-protected power strip is recommended. Do not overload wall outlets.
- When disconnecting the power cord, hold the plug, not the cord. Unplug the projector from the wall outlet, if the projector is unused for an extended time.
- Wash hands after handling the cables supplied with this product.
- The projector remote control uses batteries. Make sure the batteries' polarity (+/-) is aligned correctly. Dispose of used batteries in accordance with local disposal laws.
- Use an InFocus approved ceiling mount kit for proper fitting, ventilation and installation. The projector warranty does not cover any damage caused by use of non-approved ceiling mount kits or by installing in an improper location.
- When the projector is ceiling mounted, wear protective eyewear to prevent eye injury before opening lamp door.
- The projector must be installed by a qualified professional in order to ensure proper operation and reduce the risk of hazards or injury. It is not recommended you install the projector yourself.
- Refer all service to qualified service personnel. Servicing your own projector can be dangerous to you and will void the warranty.
- Only use replacement parts specified by InFocus. Unauthorized substitutions may result in fire, electrical shock, or injury, and may void the warranty.
- Only genuine InFocus lamps are tested for use in this projector. Use of non InFocus lamps may cause electrical shock and fire, and may void the projector warranty.
- Hg – Lamp contains mercury. Manage in accordance with local disposal laws. See [www.lamprecycle.org](http://www.lamprecycle.org).
- The projector uses a high-pressure mercury glass lamp. The lamp may fail prematurely, or it may rupture with a popping sound if jolted, scratched, or handled while hot. The risk of lamp failure or rupture also increases as the lamp age increases; please replace the lamp when you see the "Replace Lamp" message.

- In the unlikely event of a lamp rupture, particles may exit through the projector vents. Keep people, food, and drinks out of the "keep out" area under and around the projector, as indicated by the "X" areas below.



Unplug this projector from the wall outlet and refer servicing to qualified service personnel under the following conditions:

- When the power cord or plug is damaged or frayed
- If liquid has been spilled into the projector
- If the projector has been exposed to rain or water
- If the projector does not operate normally by following the operating instructions. Adjust only those controls that are covered by the operating instructions as improper adjustment of other controls may result in damage and may require extensive work to restore the projector to normal operation
- If the projector has been dropped
- When the projector exhibits a distinct change in performance, this indicates a need for service.

Follow these instructions to help ensure image quality and lamp life over the life of the projector. Failure to follow these instructions may affect the warranty. For complete details of the warranty, see the Warranty Booklet.

# Introduction

Your new digital projector is simple to connect, easy to use, and straightforward to maintain. It is a versatile projector that is flexible enough for home video viewing and business presentations, too. The SP8602 has native 1920x1080 (1080p) resolution. Your projector is compatible with a wide variety of computers and video devices.

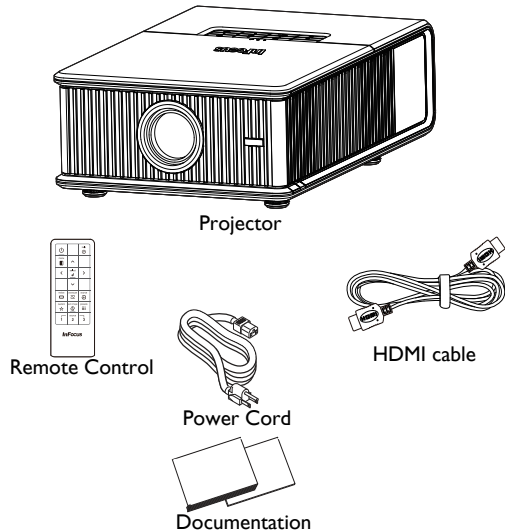
## Product specifications

To read the latest specifications on your multimedia projector, be sure to visit our support website at [www.infocus.com/support](http://www.infocus.com/support), as specifications are subject to change.

## Online registration

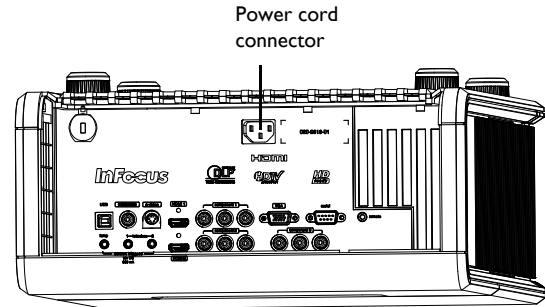
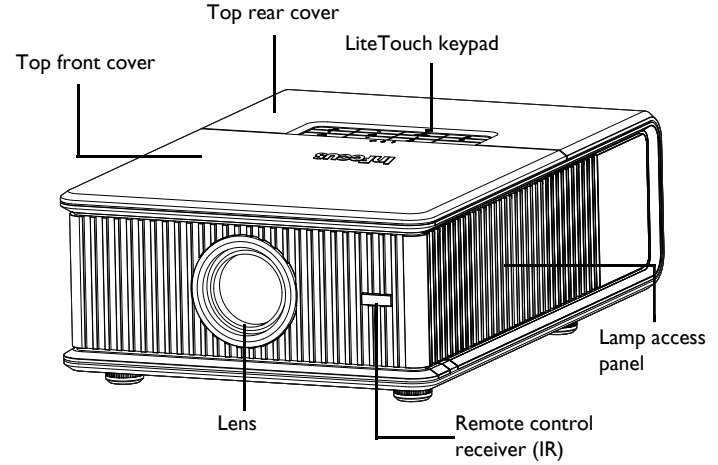
Register your projector on our website at [www.infocus.com/register](http://www.infocus.com/register) to activate your warranty and receive product updates, announcements, and registration incentives.

## Included Items



## Optional Accessories

Optional accessories include optional top covers in a variety of finishes, the Commander-2 remote, ceiling mount, and LiteShow II. These items and other accessories can be found on our website at [www.infocus.com](http://www.infocus.com) or at your local dealer.



## Connector panel

The projector provides both computer and video connection options, including:

- VGA computer
- HDMI (2)
- S-video
- Composite video
- Component video (3)
- USB port

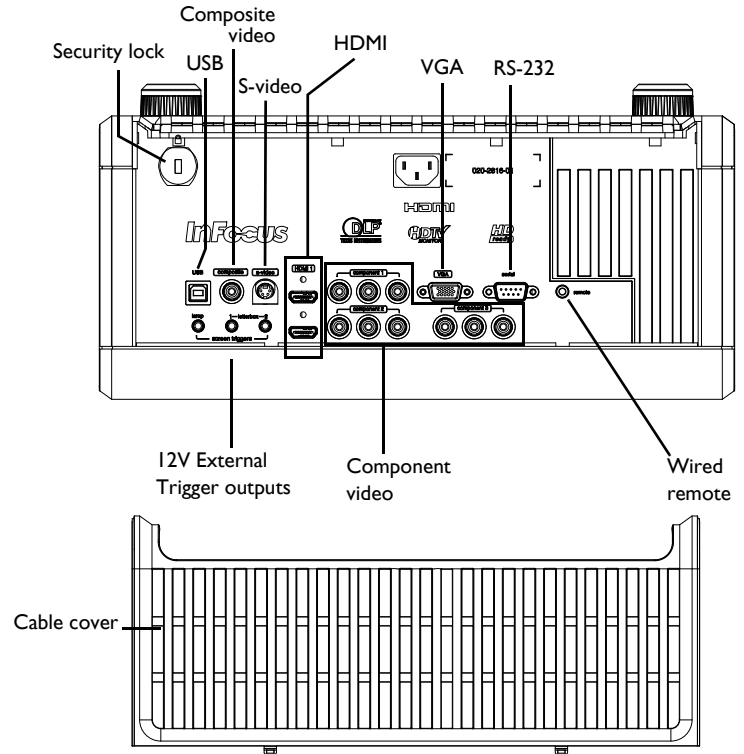
The projector also provides the following connectors:

- 12V screen trigger outputs (3)
- Wired remote jack (for use with optional Commander 2 remote)
- RS-232 connector for serial control. Command control codes are in the Appendix and on our support website at [www.infocus.com/support](http://www.infocus.com/support).

### 12V External Trigger outputs

The three 3.5mm mini-jack 12 volt, 0.25 amp DC outputs are screen/lens triggers:

- The “Lamp” trigger turns on when the lamp is lighted. If you connect your projection screen to this output using the cable that came with your screen, the screen will move down when the lamp is turned on and the screen will return to its storage position, when the lamp is turned off.
- The Letterbox “1” and “2” triggers are active when the projector is placed in letterbox mode and are utilized for variable masking and anamorphic lens control. (These triggers are off when SplitScreen is active.)



## Positioning the projector

To determine where to position the projector, consider the size and shape of your screen, the location of your power outlets, and the distance between the projector and the rest of your equipment. Here are some general guidelines:

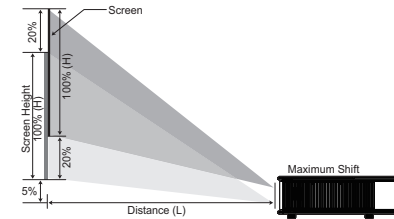
- Position the projector on a flat surface at a right angle to the screen. The projector must be at least 4.9' (1.5m) from the projection screen.
- Position the projector within 10' (3m) of your power source and within 6' (1.8m) of your video device (unless you purchase extension cables). To ensure adequate cable access, do not place the projector within 6" (.15m) of a wall or other object.
- Position the projector to the desired distance from the screen. The distance from the lens of the projector to the screen, the zoom setting, and the video format determine the size of the projected image.
- If the image is square but not centered on the screen or viewing area, adjust it by using the lens shift dials. Use the Horizontal dial to shift the lens left or right. Use the Vertical dial to shift the lens up or down.

**NOTE:** As the lens is shifted away from the lens centerline, the horizontal shift range is reduced. To adjust lens shift efficiently we suggest you follow these steps:

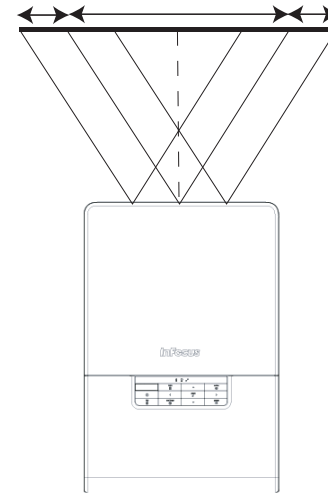
- 1 Use vertical lens shift to move the image closer to the lens centerline than the final vertical position.
- 2 Use horizontal lens shift to determine the center horizontal position, then move image to the center horizontal position.
- 3 Use vertical lens shift to move the image away from the lens centerline to the final vertical position.
- 4 Use horizontal lens shift to move the image to the final horizontal position.
- 5 If lens shift is unable to move the image far enough, move the projector (preferable) or tilt the projector and then use vertical and horizontal

keystone to re-position the image.

- The vertical image offset range is 105%~130% for the SP8602 (default for is 105%). The default horizontal image offset is +/-15%, however at maximum vertical image offset, there is no horizontal lens shift.



### Horizontal Offset +/-15%



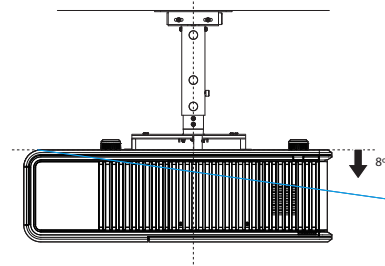
*Range of distance to the screen for a given screen size*

Diagonal Screen Size (inches/m)	Distance to screen	
	Minimum distance (feet/m)	Maximum Distance (feet/m)
60/1.524	6.50/1.98	10.01/3.05
80/2.032	8.73/2.66	13.42/4.09
90/2.286	9.84/3.00	15.12/4.61
150/3.810	16.54/5.04	25.3/7.71

## Ceiling Mount

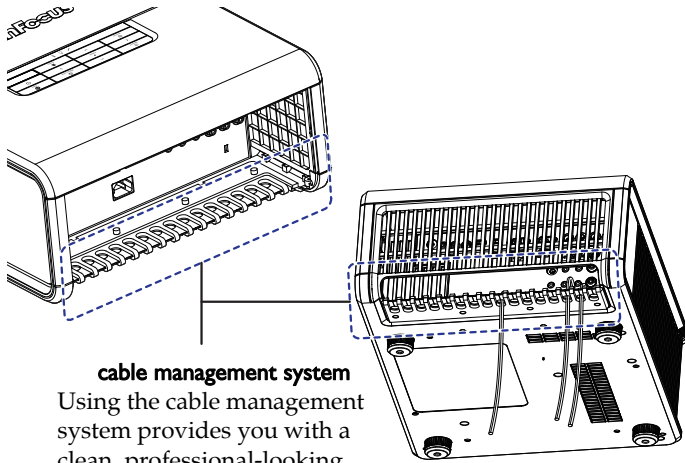
If you wish to install the projector on the ceiling:

- The projector must be installed by a qualified professional in order to ensure proper operation and reduce the risk of hazards or injury. It is not recommended you install the projector yourself.
- We strongly recommend using InFocus approved ceiling mounts for proper fitting, ventilation and installation. Refer to the installation guide that comes with the InFocus Ceiling Mount Kit (p/n SP-CEIL-INSTALL) for more information. The warranty does not cover any damage caused by use of non-approved ceiling mount kits or by installing in an improper location.
- The ceiling must be strong enough to support the projector and the installation must be in accordance with any local building codes. Consult your dealer for more information.
- Maximum supported physical pitch is +/-8°.
- Maximum supported physical horizontal roll is +/-8°.
- Keep all adjacent surfaces 3" (76mm) from sides, front and rear and .87" (22mm) from the bottom of projector to preserve required airflow around the projector.



## Cable management

The integrated cable management system allows you to keep the cables organized. To use the cable management system, thread the cables into the slots as shown in the illustration.



### **cable management system**

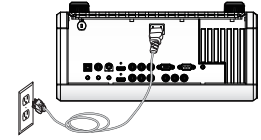
Using the cable management system provides you with a clean, professional-looking installation.

## Connecting power

Connect the black power cord to the **Power** connector on the rear of the projector and to your electrical outlet. The Power light on the Status Indicator Panel (page 15) turns amber.

**NOTE:** Always use the power cord that shipped with the projector.

Connect power cord



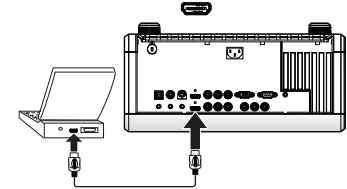
## Connecting a computer source

### HDMI 1.3 connection

HDMI is a standard, uncompressed, all-digital audio/video interface. HDMI provides an interface between sources, such as set-top boxes, DVD players, and receivers and your projector. Plug an HDMI cable into the video out connector on the video device and into either the **HDMI 1** or **HDMI 2** connector on the projector.

To take advantage of HDMI 1.3 Deep Color (30 bit) you must have a 1.3-compatible source.

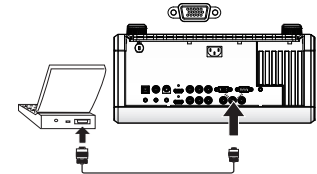
Connect HDMI cable



### VGA connection

Connect one end of the provided computer cable to the **VGA** connector on the projector and the other to the VGA connector on your computer. If you are using a desktop computer, you will need to disconnect the monitor cable from the computer's video port first.

Connect computer cable





## Displaying an image

Touch the **Power** button on the keypad or the remote.

The Power button blinks green and the fans start to run. When the lamp turns on, the start up screen will display and the Power button will become solid green. It can take a minute for the image to achieve full brightness.

**No start up screen?** Get help on page 16.

Turn on your computer or video device.

The image should appear on the projection screen. If it doesn't, press the **Source** button on the projector's keypad or remote.

**If you are using a VGA cable to connect your computer to the projector:**

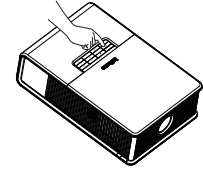
If using a laptop, make sure its external video port is active.

Many laptops do not automatically turn on their external video port when a projector is connected. Usually a key combination like Fn + F8 or CRT/LCD key turns the external display on and off. Locate a function key labeled CRT/LCD or a function key with a monitor symbol. Press Fn and the labeled function key simultaneously.

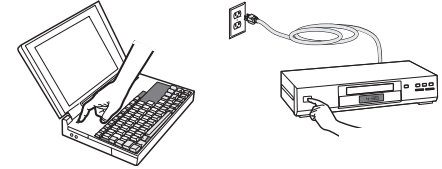
Refer to your laptop's documentation for more information about your laptop's key combination or go to the InFocus website at: <http://www.infocus.com/Support/LaptopActivation.aspx>.

**No laptop image?** Try pressing the **Auto Image** button on the keypad or remote.

Press Power button



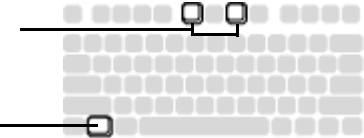
Turn on computer or video device



Activate laptop's external port



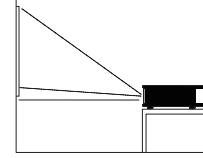
Monitor key or  
LCD/CRT key



## Adjusting the image

Position the projector to the desired distance from the screen at a 90 degree angle to the screen. See page 8 for a table listing of screen sizes and distances.

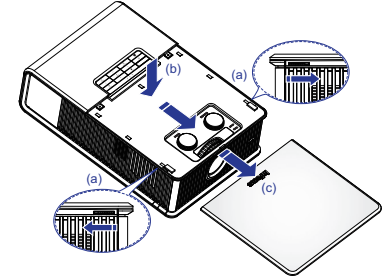
Adjust distance



Remove the projector top cover

- Slide the tabs on the side toward the rear of the projector to unlock the projector top cover.
- Slide the top toward the front of the projector to unhook it from the projector body.
- Lift off.

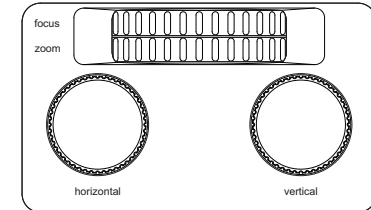
Remove cover



Adjust the zoom or focus.

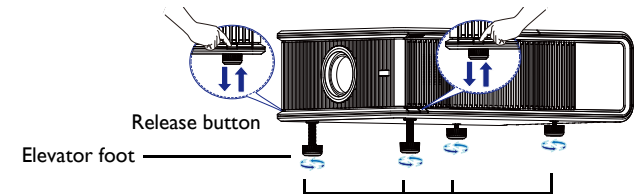
If the image is square but not centered on the screen or viewing area, adjust it by using the lens shift dials. See page 7 for details.

Adjust zoom, focus and lens shift



Rotate the elevator feet for granular adjustment of the projector's height. Avoid placing your hands near the hot exhaust vent at the side of the projector.

Adjust height



Adjust the Contrast or Brightness in the Basic Picture menu. See page 27 for help with these menu adjustments.

## Connecting a video device

You can connect video devices such as VCRs, DVD players, camcorders, digital cameras, video game consoles, HDTV receivers, and TV tuners to the projector.

You can connect the projector to most video devices that can output video. You cannot directly connect the coaxial cable that enters your house from a cable or satellite company; the signal must pass through a tuner first. Examples of tuners are digital cable boxes, VCRs, digital video recorders, and satellite TV boxes. Basically, any device that can change channels is considered a tuner.

Although the aspect ratio is automatically selected by the projector based on the signal input, you can change the aspect ratio, if desired. The projector's Aspect Ratio setting is accessed through the Resize button on the remote or through the projector's Basic Picture Menu. See page 27 for more information.

## Video device connections

You can order cables from InFocus or use your own.

### Composite video connection

Plug the composite video cable's yellow connector into the video out connector on the video device. Plug the other yellow connector into the yellow **Composite** connector on the projector.

Keep in mind that video output from composite connections is not as high quality as S-video.

### HDMI 1.3 connection

HDMI is a standard, uncompressed, all-digital audio/video interface. HDMI provides an interface between sources, such as set-top boxes, DVD players, and receivers and your projector. Plug an HDMI cable into the video out connector on the video device and into either the **HDMI 1** or **HDMI 2** connector on the projector.

To take advantage of HDMI 1.3 Deep Color (30 bit) you must have a 1.3-compatible source.

### S-video connection

If your video device uses a round, four-prong S-video connector, plug an S-video cable into the S-video connector on your video device and into the **S-video** connector on the projector.

Keep in mind that S-video delivers higher quality video output than composite.

### VGA connection

If your video device has a 15-pin VGA output, plug one end of the included computer cable into the VGA connector on your video source. This connector may be labeled "To Monitor" on the video source. Plug the computer cable into the **VGA** connector on the projector.

### Component video connection

Plug the component cable into the video device. Plug the other end of the component cable into the **Component 1**, **Component 2** or **Component 3** connectors.

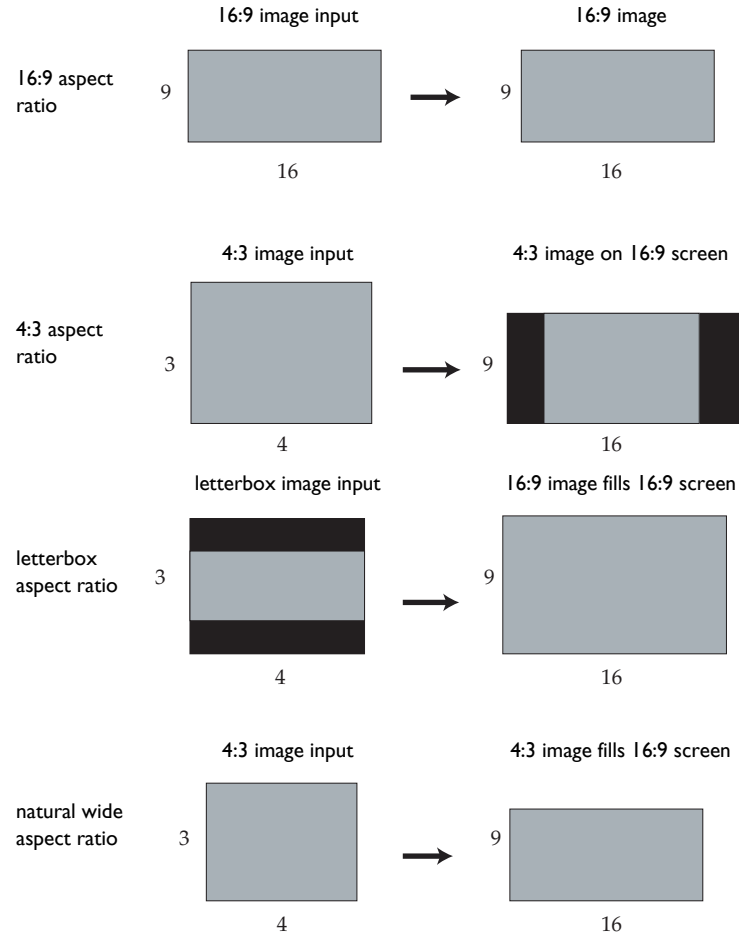
In addition, a Component to VGA adapter can be used in conjunction with the VGA connectors. Plug the component cable into the video device. Plug the other end of the component cable into the adapter and plug the adapter into the **VGA** connector.

Component offers the highest quality analog video output.

## What is Aspect Ratio?

Aspect ratio is the ratio of the image width to image height. HDTV and most DVDs are 16:9, which is the default for this projector. When in 4:3 mode the projector places black bars on both sides of the image. Native mode centers the image and turns off the internal scaler so that any resolution larger than the native projector resolution is cropped on the edges. Letterbox expands the image to fill the screen. Natural Wide stretches a 4:3 image to fill the entire 16:9 screen. The center two-thirds of the image is unchanged; the edges of the image are stretched.

What you plan to project will also help you choose between 4:3 and 16:9. For example, most TV shows are 4:3, while most movies are 16:9. If you have a 16:9 screen, then you should select an aspect ratio of 16:9 for anamorphic movies and HDTV, and Native for 4:3 content. If you have a 4:3 screen you should still use 16:9 for anamorphic movies or HDTV, but you also have the option of using 4:3, Native, or Natural Wide for 4:3 content. Force Wide can also be enabled to automatically resize less common aspect ratios to 16:10.



# Shutting down the projector

## Screen Save Time

You can make the black screen appear after a preset number of minutes by turning on the Screen Save Time feature in the Setup menu. See page 29.

## Auto Off Time

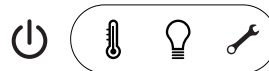
The projector has an Auto Off Time feature that automatically turns the projector off if no active sources are detected and no user interaction with the projector is performed for 30 minutes. By default, this feature is off. You can change the length of time, see page 29.

## Turning off the projector





To turn the projector off, press the **Power** button on the remote or keypad. The lamp turns off and the LED blinks amber for 10 seconds while the fans continue to run to cool the lamp. When the lamp has cooled, the LED lights amber and the fans stop. Unplug the power cable to completely power off the projector.

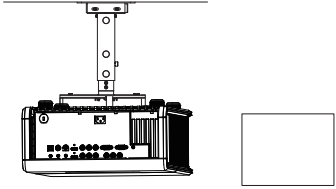
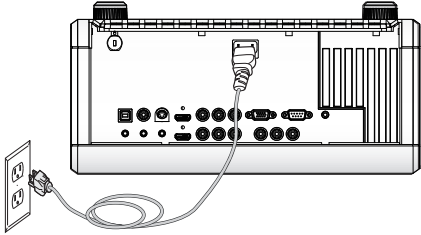
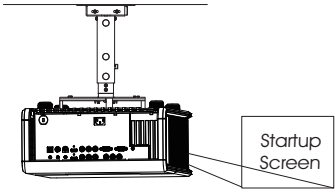
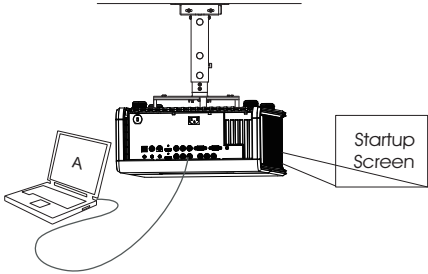

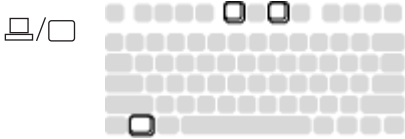

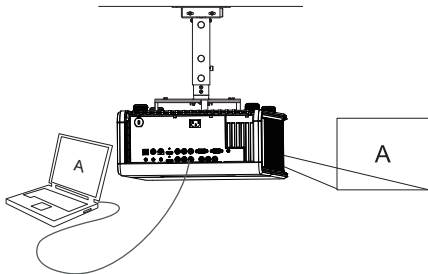
# Troubleshooting your setup

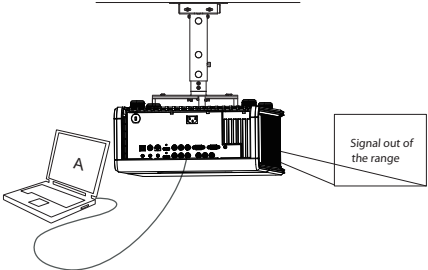

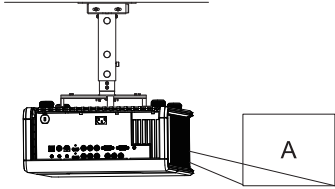
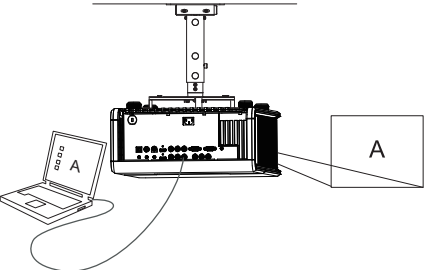
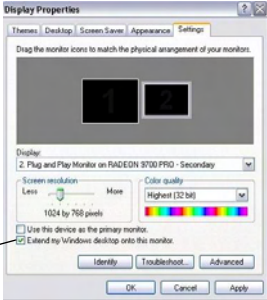
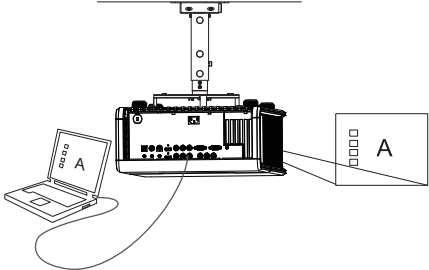
The Status Indicator Panel on top of the projector indicates the state of the projector and is a helpful when troubleshooting.

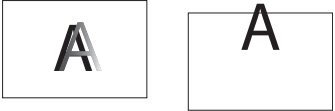


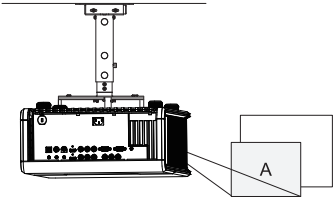
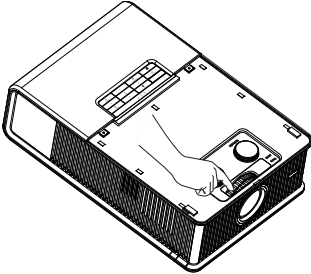
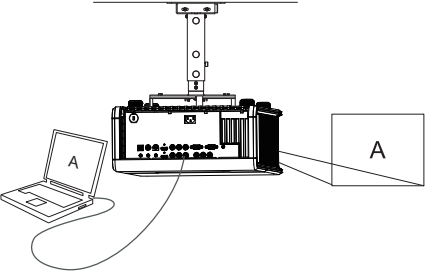


**Table 1: Status indicator light behavior and meaning**

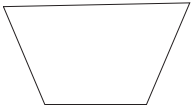





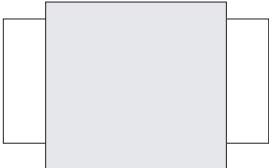


Icon	Meaning
Power, solid amber 	The projector is plugged in.
Power, blinking green	The power button has been pressed and the software is initializing.
Power, solid green	The projector is on and initialized.
Power, blinking amber	The power button has been pressed to turn the projector off and the fans are running to cool the projector.
Temperature 	The projector is too hot. Make sure the vents aren't blocked (see page 21). Turn the projector off and wait one minute, then turn the projector on again. Contact Technical Support if the problem persists. Visit <a href="http://www.infocus.com/support">www.infocus.com/support</a> to contact service.
Lamp 	Turn the projector off and wait one minute, then turn the projector on again. If the lamp light turns on again, replace the lamp and reset the lamp timer (page 34).
Wrench/Service 	Turn the projector off and wait one minute, then turn the projector on again. If the service lamp turns on again, service is required. Visit <a href="http://www.infocus.com/support">www.infocus.com/support</a> to contact service.








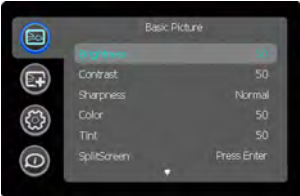

Problem	Solution	Result
<p data-bbox="48 127 244 152">No start up screen</p> 	<p data-bbox="661 127 1130 181">Plug power cord into the projector, then press power button</p> 	<p data-bbox="1183 127 1334 152">Correct image</p> 
<p data-bbox="48 491 340 516">Only start up screen appears</p> 	<p data-bbox="661 512 987 560">Press the Source button  Activate the laptop's external port</p>  <p data-bbox="670 766 808 792">Restart laptop</p> 	<p data-bbox="1183 486 1459 512">Computer image projected</p> 

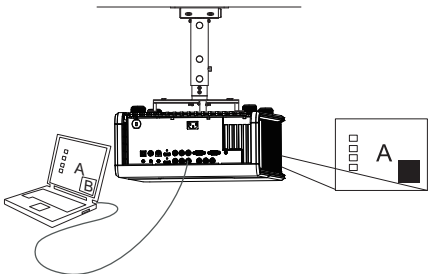
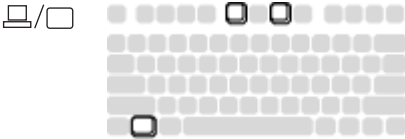
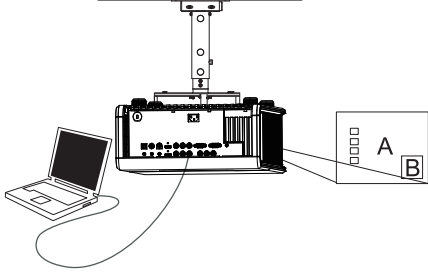
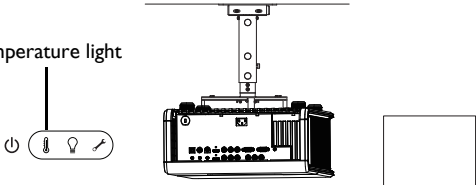
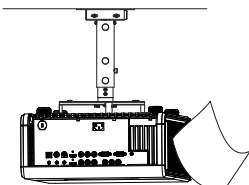
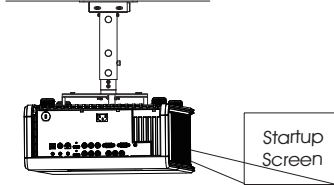
Problem	Solution	Result
<p data-bbox="48 135 541 189"><b>No computer image, just the words “Signal out of range”</b></p> 	<p data-bbox="604 135 1152 230"><b>Press the Auto Image button on the keypad or on the remote. To adjust computer refresh rate, go to Control Panel &gt; Display &gt; Settings &gt; Advanced &gt; Adapter (location varies by operating system).</b></p>  <p data-bbox="604 498 1152 569"><b>You may also need to set a different resolution on your computer, as shown in the following problem, “image fuzzy or cropped”</b></p>	<p data-bbox="1183 135 1451 161"><b>Computer image projected</b></p> 
<p data-bbox="48 586 505 640"><b>Only my laptop’s background appears, not the Desktop icons</b></p> 	<p data-bbox="604 586 1152 663"><b>Windows - Disable “Extend my Windows Desktop” in Control Panel &gt; Display &gt; Settings &gt; Display 2 (location varies by operating system)</b></p>  <p data-bbox="614 896 739 976"><b>Uncheck this option, then click Apply</b></p>	<p data-bbox="1183 586 1534 613"><b>Background and Desktop projected</b></p> 

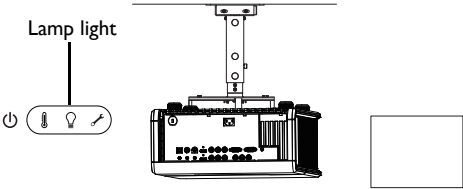
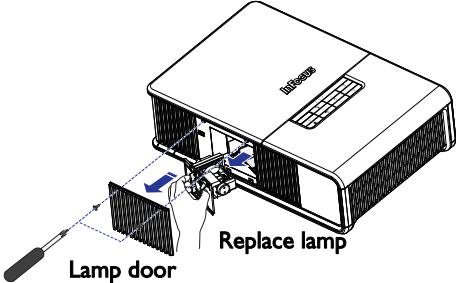
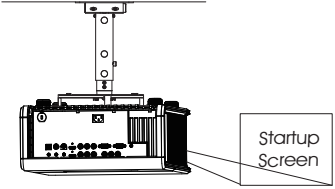
Problem	Solution	Result
<p data-bbox="48 89 284 115">Image fuzzy or cropped</p> 	<p data-bbox="604 89 1142 173">Set your computer's display resolution to the native resolution of the projector (Start &gt; Settings &gt; Control Panel &gt; Display &gt; Settings tab)</p> <p data-bbox="656 311 817 445">For a laptop, disable laptop monitor or turn-on dual-display mode</p> 	<p data-bbox="1182 89 1465 115">Image clear and not cropped</p> 
<p data-bbox="48 540 348 567">Image not centered on screen</p> 	<p data-bbox="604 540 1025 567">Move projector, adjust zoom and lens shift</p> 	<p data-bbox="1182 540 1326 567">Correct image</p> 



Problem	Solution	Result
<p><b>Image not square</b></p> 	<p><b>Adjust Keystone in the Basic Picture menu</b></p> 	<p><b>Square image</b></p> 
<p><b>Image not sharp</b></p> 	<p><b>Adjust Sharpness in the Basic Picture menu</b></p> 	<p><b>Correct image</b></p> 
<p><b>Image does not fit 4:3 or 16:9 screen</b></p> 	<p><b>Change aspect ratio to 4:3 or 16:9 in Basic Picture&gt;Aspect Ratio menu</b></p> 	<p><b>Correct image</b></p> 

Problem	Solution	Result
<p>Image upside down</p> 	<p>Turn off Ceiling Mount in Setup menu</p> 	<p>Correct image</p> 
<p>Image reversed left to right</p> 	<p>Turn off Rear Project in Setup menu</p> 	<p>Correct image</p> 
<p>Projected colors don't match source</p> 	<p>Adjust color, tint, brightness, contrast in the Basic Picture menu and/or color space in the Advanced Picture menu</p> 	<p>Correct image</p> 

Problem	Solution	Result
<p>The video embedded in my PowerPoint presentation does not play on the screen</p> 	<p>Turn off the internal LCD display on your laptop</p> 	<p>Embedded video plays correctly</p> 
<p>Lamp won't turn on, Temperature light is on</p> 	<p>Make sure vents aren't blocked, turn the projector off and allow it to cool for one minute.</p> 	<p>Lamp turns on</p> 

Problem	Solution	Result
<p data-bbox="48 101 531 153">“Replace lamp” message appears at startup, lamp won’t turn on, Lamp light is turned on</p> 	<p data-bbox="604 112 968 138">Lamp must be replaced (see page 33)</p> 	<p data-bbox="1183 92 1326 119">Lamp turns on</p> 

**Still need assistance?**

If you need assistance, visit our support website at [www.infocus.com/support](http://www.infocus.com/support) or call us. Check out the How To section for additional information on using this projector for home theater or gaming applications.

This product is backed by a limited warranty. An extended warranty plan may be purchased from your dealer. When sending the projector in for repair, we recommend shipping the unit in its original packing material, or having a professional packaging company pack the unit. Please insure your shipment for its full value.

# Using the remote control

The remote uses two (2) provided AA batteries. You can install the batteries by removing the cover from the remote's back, aligning the + and - ends of the batteries, sliding them into place, and then replacing the cover.

## Caution:

- When replacing the batteries, be aware that using batteries other than the type provided with the projector may risk severe damage to the remote. When disposing of the batteries, be sure to do so in an environmentally proper manner.
- If the remote control gets wet, wipe it dry immediately.
- Avoid excessive heat and humidity.
- Ensure the batteries' polarity (+/-) is aligned correctly.
- Do not mix new and old batteries together, or different types of batteries together.
- Replace the batteries as soon as they run out.
- Remove batteries from the remote control when storing or not in use for a prolonged period.

To operate, point the remote at the front of the projector (not at the computer). The range of optimum operation is about 30' (9m).

Press the remote's **Power** button to turn the projector on and off (see page 15 for shutdown information).

Press the remote's **Menu** button to open the projector's menu system. Use the arrow buttons to navigate, and the **Select** button to select features and adjust values in the menus. See page 26 for more information on the menus.

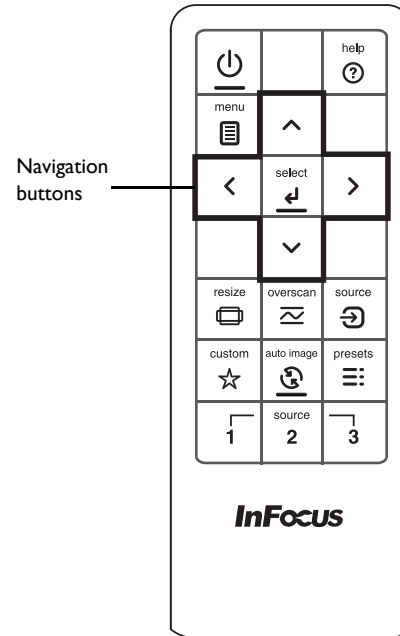
The remote also has the following buttons:

- **Help** accesses the projector's help feature (see page 31).
- **Resize** switches between aspect ratios (see page 27).
- **Overscan** removes noise at the edge of a video image.
- **Source** switches between sources.
- **Custom** can be assigned to a special function, like Blank Screen or Freeze (see page 29).

- **Auto Image** resynchronizes the projector to the source.
- **Presets** selects between different stored settings (see page 27).
- **Source 1, 2, 3** switches between user assigned sources.

## Troubleshooting the remote

- Make sure the batteries are installed in the proper orientation and are not dead.
- Make sure you're pointing the remote at the projector or the screen, not the computer, and are within the remote range of 30' (9m). For best results, point the remote at the projector.



## Using the keypad buttons

Most buttons are described in detail in other sections, but here is an overview of their functions:

**Power**—turns the projector on and off (page 10).

**Auto Image**—resynchronize the projector to the source.

**Presets**—cycles through the available preset settings (page 27).

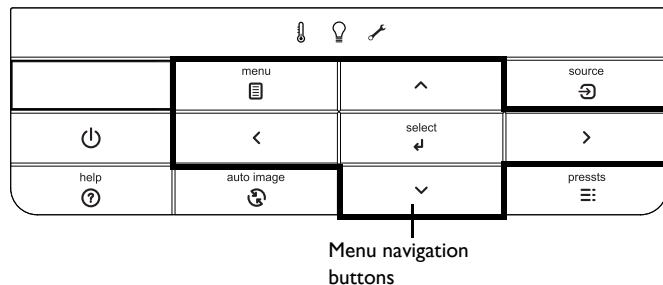
**Menu**—opens the onscreen menus (page 26).

**Select**—confirms choices made in the menus (page 26).

**Up/Down/Left/Right arrows**—navigates to and adjusts settings in the menus (page 26).

**Source**—changes the active source (page 10).

**Help**—button to access the projector's help feature (page 31)



## Optimizing computer images

After the projector is running and the image is on the screen, you can optimize the image using the onscreen menus. For general information on using the menus, see page 26.

- Adjust the Keystone, Contrast, or Brightness in the Basic Picture menu (page 27).
- Change the Aspect Ratio. Choose the option that best fits your input source (page 27).
- Adjust the Color Temperature in the Advanced Picture menu (page 28).
- Adjust the Phase, Tracking, or Horizontal or Vertical position in the Advanced Picture menu (page 28).
- Once you have optimized the image for a particular source, you can save the settings using Presets. This allows you to quickly recall these settings later (page 27).

## Presentation features

Several features are provided to make giving presentations easier. Here is an overview, details are found in the menu section.

- The Custom key allows you to assign various features to the button. The default effect is Source Info, which displays information about the projector and current source. See page 29 for details.
- The Search Screen option lets you change the appearance of the blank screen and start up screen (page 30).
- Two options, Auto Off and Screen Save Time, are provided to automatically shut down the projector after several minutes of inactivity or display a black screen. This helps preserve lamp life (page 29).

## Optimizing video images

After your video device is connected properly and the image is on the screen, you can optimize the image using the onscreen menus. For general information on using the menus, see page 26.

- Adjust the Keystone, Contrast, Brightness, Color, Tint or Sharpness in the Basic Picture menu (page 27).
- Change the Aspect Ratio. Choose the option that best fits your input source (page 27).
- Adjust the Color Temperature. Select a listed warmth value (page 28).
- Turn on Overscan to remove noise on the edges of the image (page 28).

## Customizing the projector

You can customize the projector for your specific setup and needs. See page 29 to page 30 for details on these features.

- For rear projection, turn Rear Project on in the **Setup** menu.
- For ceiling mounted projection, turn Ceiling Mount on in the **Setup** menu.
- Specify which source the projector checks first for active video during power-up.
- Specify the function of the Custom key on the remote.
- Turn the projector's display messages on and off.
- Turn on power saving features.
- Specify appearance of blank screen and startup screen.
- Specify the language viewed on the menus.

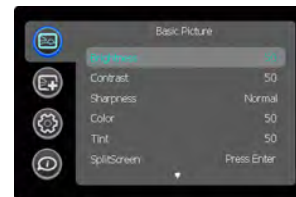
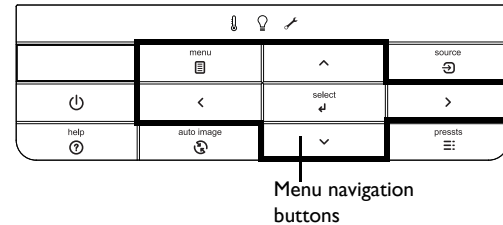
# Using the menus

To open the menus, press the **Menu** button on the keypad or remote. (The menus automatically close after 60 seconds if no buttons are pressed.) Use the arrow buttons to move up and down to highlight the desired menu, then press the **Select** button.

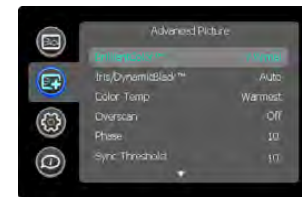
To change a menu setting, highlight it, press **Select**, then use the arrow buttons to adjust the value or select an option or turn the feature on or off. Press **Select** to confirm your changes. Use the arrow buttons to navigate to another setting. When your adjustments are complete, press **Menu** to access a different menu; press the **Menu** button at any time to navigate to the higher-level menu and ultimately close the menus.

The menus are grouped by usage:

- The Basic Picture menu provides common image adjustments.
- The Advanced Picture menu provides more complex image adjustments.
- The Setup menu provides set-up type adjustments that are not changed often.
- The Status and Service menu provides information about the projector and source.



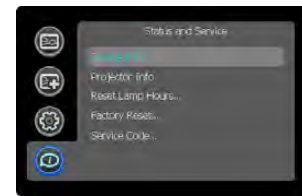
Basic Picture menu



Advanced Picture menu



Setup menu



Status and Service menu



## Basic Picture menu

To adjust the following settings, highlight the setting, press **Select**, use the arrow buttons to adjust the values, then press **Select** to confirm the changes.

**Brightness:** Changes the intensity of the image.

**Contrast:** Controls the degree of difference between the lightest and darkest parts of the picture and changes the amount of black and white in the image.

**Sharpness:** Changes the clarity of the edges of a video image. Select a sharpness setting.

**Color:** Adjusts a video image from black and white to fully saturated color. The color setting applies to video sources only.

**Tint:** Adjusts the red-green color balance in the image of NTSC video images. The tint setting applies to NTSC video sources only.

**SplitScreen:** Allows two distinct sources to be displayed simultaneously. Switch primary sources, make picture adjustments and choose one of multiple display options: either two side by side horizontal or vertical source regions, or a small secondary source image displayed on top of the primary source in one of four placement options. For display options, see page 35.

**Auto Image:** Forces the projector to reacquire and lock to the input signal. This is useful when signal quality is marginal.

**Aspect Ratio:** Aspect ratio is the ratio of the image width to image height. TV screens are usually 4:3. HDTV and most DVDs are 16:9.

Select Auto to have the projector choose the ratio. Choose Native to see the unmodified input with no resizing by the projector. Select 16:9 to watch enhanced widescreen DVDs.

For more information regarding Aspect Ratio, see page 14.

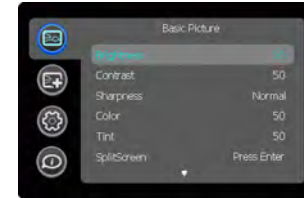
**Apply Preset....:** Presets are provided that optimize the projector for displaying computer presentations and video images under certain conditions.

There is also a user-definable preset. To set this preset, adjust the image and select Save User in the Presets menu. You can recall these settings in the future by selecting the User preset.

**Horz/Vert Keystone:** Adjusts the image horizontally and vertically and makes a squarer image.

**Digital Zoom:** Changes the size of projector's display area. If the display area has been resized by this setting, it can be moved by changing the **Horz Shift** and **Vert Shift** settings.

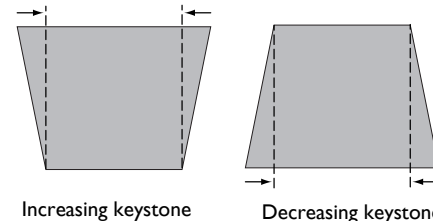
**Horz Shift/Vert Shift:** Moves the display area horizontally or vertically if its size has been changed by the **Digital Zoom** setting..



Basic Picture menu



Aspect ratio



## Advanced Picture menu

**BrilliantColor™** : Produces an expanded onscreen color spectrum that delivers enhanced color saturation for bright, true-to-life images. Choose Normal Look for most video sources and Bright Look for most computer sources.

**Iris/DynamicBlack**: Select Auto to constantly adjust the aperture based on the amount of black in the current scene, or select a percentage for a fixed aperture size (100% is maximum size).

**Color Temperature**: Changes the intensity of the colors. Select a listed relative warmth value.

**Force Wide**: When this is off, the analog locking algorithms choose the standard mode resolution (4:3) as the preferred default resolution. When this is on, the analog locking algorithms choose wide mode resolution (16:10) as the preferred default resolution.

**Overscan**: Removes noise around the video image.

**Phase**: Adjusts the horizontal phase of a computer source.

**Sync Threshold**: (progressive signals only) If a hardware device, such as a DVD player, is not syncing properly with the projector, select this option to help it to sync when connected to the projector.

**Tracking**: Adjusts the vertical scan of a computer source.

**Color Space**: This option applies to computer and component video sources. It allows you to select a color space that has been specifically tuned for the input signal. When Auto is selected, the projector automatically determines the standard. To choose a different setting, turn off Auto, then choose RGB for computer sources or choose either REC709 or REC601 for component video sources.

**Noise Reduction**: Reduces temporal and/or spatial noise in the image.

**Flesh Tone Correction**: Controls the amount of flesh tone correction applied to the image.

**Set Black Level...:** Analyzes the current input image and calculates an offset value which is then added to the analog to digital converter black level value. This ensures optimum black level for each analog source.

**Detect Film**: Controls film mode detection, and determines whether the original source of the input video was film or video.

**Gamma**: Select the appropriate gamma from among Video, Film, Bright, and CRT.

**Color Gamut**: Sets the color gamut of the input signal.

**Color Gain**: Adjusts the gain of the red, green, or blue channel of the image.

**Color Offset**: Adjusts the offset of the red, green, or blue channel of the image.

**Horizontal/Vertical Position**: Adjusts the position of a computer source.

**Horizontal/Vertical Pincushion**: Correct optical pincushion distortion.



Advanced Picture menu

## Setup menu

**Language:** Allows you to select a language for the onscreen display.

**Key Click:** Turns the key click sound on or off. When this setting is on, pressing keys on the keypad causes the projector's speaker to play a "click" sound.

**Custom Key:** Allows you to assign a different function to the Custom button, allowing you to quickly and easily use the effect. Highlight an effect and press **Select** to choose a different one.

- **Source Info:** The default action. Shows the Source Info menu.
- **Projector Info:** Shows the Projector Info menu.
- **Aspect Ratio:** Sets the ratio of image width to image height (see page 14 and page 27).
- **Auto Image:** Resynchronizes the projector to the source (page 24).
- **Overscan:** Removes noise around the image.
- **Blank Screen:** Displays an empty screen.
- **Freeze Screen:** Pauses the projected image.
- **Source:** Cycles through available sources.
- **Closed Caption:** Enables or disables Closed Captioning.
- **SplitScreen:** Enables or disables SplitScreen. Before using this for the first time, configure SplitScreen sources and layouts using the SplitScreen menu (page 27)

**Source Key Enable:** Enables or disables Source Keys on the optional Commander-2 remote.

**AC Power On:** When this feature is on, the projector automatically turns on when electrical power is connected. This allows control of ceiling mounted projectors with a wall power switch.

**Auto Off Time:** Automatically turns the projector off after no signals are detected for a preset number of minutes. If an active signal is received before the projector powers down, the image will be displayed.

**Screen Save Time:** Automatically blanks the screen with a black color after no signals are detected for a preset number of minutes. The image returns when an active source is detected or a remote or keypad button is pressed.

**Sleep Timer:** Allows the projector to automatically power off after it has been on for a specified amount of time.

**Always-On Functions:** Allows you to control which projector functions will work even when the projector is in standby (powered off but connected to AC Power). Press Up or Down to highlight the function you want to change, then press select or left and right to change the function to either Yes or No. Press menu when done. Note that some functions must always have the same value; in this case when you change one value, other values in the submenu may also change automatically.

**Lamp High Power:** Toggles between on and off. Turn it on to raise the light output of the lamp. This also raises the fan speed, making the projector louder. Default is off.

**Power Sounds:** Controls whether the projector makes a sound when powered on and off.

**Auto Source:** When this feature is On, the projector automatically finds the active source, checking the selected Power-up Source first. When this feature is Off, the projector defaults to the source selected in Power-up Source. To display another source, you must manually select one by pressing the **Source** button on the remote or keypad.

**Power-up Source:** Determines which source the projector checks first for active video during power-up.

**HDMI DDC:** When this feature is set to On, the projector will support and older DVD player for HDMI port.

**Fast Color Refresh:** Changes the color wheel speed from 4x to 6x.

**Video Standard:** When this feature is set to Auto, the projector attempts to automatically pick the video standard based on the input signal it receives. (The video standard options may vary depending on your region of the world.) If the projector is unable to detect the correct standard, the colors may not look right or the image may appear "torn." If this happens, manually select a video standard by selecting NTSC, PAL, or SECAM from the Video Standard menu.

**Closed Captions:** Controls closed caption display while audio is not muted. If this setting is not off, and audio is not muted, and the source is NTSC and

contains captions on the selected channel, then the projector must display caption text overlaid on the image.

**Ceiling Mount:** Turns the image upside down for ceiling-mounted projection.

**Rear Project:** Reverses the image so you can project from behind a translucent screen.

**Prevent PC Screen Saver:** Prevents your computer from going into Screen Save mode. The projector must be connected to the PC via a USB cable for this feature to work.

**Search Screen:** Allows you to display one of the following options instead of the default screen at startup, and when no source is detected. Options include the factory logo screen, a custom Snapshot, or a blue, black or white screen.

**Take Snapshot...:** Captures the current image and allows it to be used as the search screen image.

**Disable Snapshot:** Allows the user to disable the snapshot capability.

**Show Messages:** Displays status messages (such as “Searching”) in the lower-left corner of the screen.

**Menu Offset:** Allows you to change the position of the On Screen Display items.

**Menu Transparency:** Allows you to change how much of the projected image behind the menu you can see. As the value increases, more of the image behind the menu is visible.

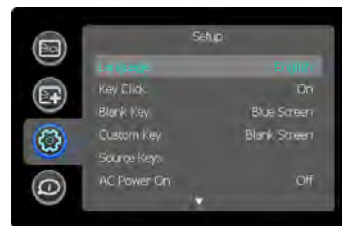
**Magnify Controls:** Allows you to change the function of the arrow buttons when the menu is not shown. By default, the arrow buttons allow you to advance slides while in PowerPoint’s SlideShow mode. To make the arrow buttons also adjust magnify settings, choose Magnify Controls to turn magnify controls on. Now when the menu is not shown, you can press the Select button to switch between the magnification settings (Magnify Level, Magnify Horizontal Position and Magnify Vertical Position), then press Select again to turn off magnify controls and use the arrow buttons to advance slides.

**Keypad Enable:** Enables or disables keypad.

**Glow Ring:** Controls the brightness level of the glow ring status indicator.

**Serial Port, Baud Rate:** Selects the serial port and baud rate.

**Serial Port Echo:** Controls whether the serial port echoes characters.



Setup menu

## Status and Service menu

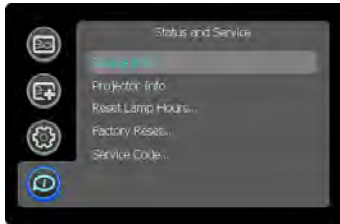
**Source Info:** Displays current source settings (read-only).

**Projector Info:** Displays current projector settings (read-only).

**Reset Lamp Hours:** Resets the lamp hours used counter in the Projector Info menu to zero. Do this only after changing the lamp.

**Factory Reset:** Restores all settings to their default.

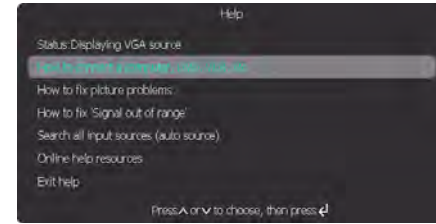
**Service Code:** Only used by authorized service personnel.



Status and Service menu

## Help

Press **Help** (on the keypad or remote) at any time to get interactive help for solving common, picture, sound, and cabling problems.



**NOTE:** The projector can be re-programmed to display a custom (non-interactive) screen when Help is pressed. To do this: Create your custom screen on a computer and display it on the projector, then use the Take Snapshot command in the Setup menu. When you see the Snapshot Successful message, hold down the Help button until the message is removed.

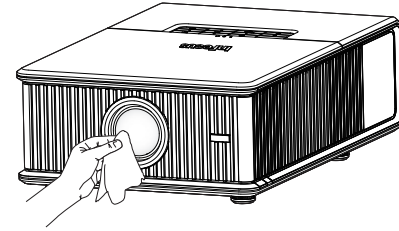
# Maintenance

## Cleaning the lens

- 1 Turn the projector off and unplug the power cord.
- 2 Apply a non-abrasive camera lens cleaner to a soft, dry cloth.
  - Avoid using an excessive amount of cleaner, and don't apply the cleaner directly to the lens. Abrasive cleaners, solvents or other harsh chemicals might scratch the lens.
- 3 Lightly wipe the cleaning cloth over the lens in a circular motion.

### WARNINGS:

- Turn the projector off and unplug power cord before cleaning any part of the projector.
- Do not open any cover on the projector, except the lamp cover or projector top cover.
- Do not attempt to service this product yourself as opening and removing covers may expose you to dangerous voltage and other hazards. Refer all servicing to qualified service personnel.



## Replacing the projection lamp

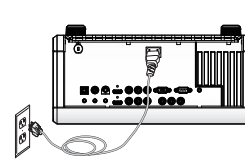
The lamp hours timer in the Projector Info menu counts the number of hours the lamp has been in use. Twenty hours before the lamp life expires, the message “Replace lamp” appears on the screen at startup.

- **NOTE:** Be sure to use the InFocus lamp module designed for this projector. You can order new lamps from [www.infocus.com](http://www.infocus.com) (in select areas), your retailer or your dealer. **Only genuine InFocus lamps are tested for use in this projector.** Use of non InFocus lamps may cause electrical shock and fire, and may void the projector warranty. InFocus is not liable for the performance, safety or certification of any other lamps.

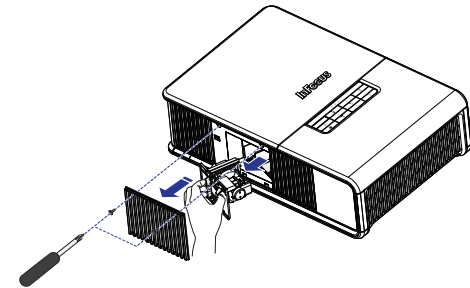
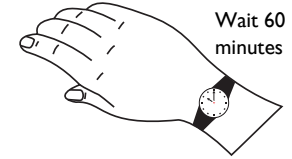
### WARNINGS:

- The projector uses a high-pressure mercury glass lamp. The lamp may fail prematurely, or it may rupture with a popping sound if jolted, scratched, or handled while hot. The risk of lamp failure or rupture also increases as the lamp age increases; please replace the lamp when you see the “Replace Lamp” message.
- To avoid burns, allow the projector to cool for at least 60 minutes before you replace the lamp.
- Unplug the power cord before replacing the lamp.
- Do not drop the lamp module. The glass may shatter and cause injury.
- Do not touch the glass surface of the lamp module. Fingerprints can obscure projection sharpness and may cause the glass to shatter.
- Be extremely careful when removing the lamp housing. In the unlikely event that the lamp ruptures, small glass fragments may be generated. The lamp module is designed to contain most of these fragments, but use caution when removing it.
- Before replacing a ruptured lamp, clean the lamp compartment and dispose of cleaning materials. Wash hands after lamp replacement.
- When replacing the lamp while the projector is ceiling-mounted, wear protective eyewear to prevent eye injury.
- Hg – Lamp contains mercury. Manage in accordance with local disposal laws. See [www.lamprecycle.org](http://www.lamprecycle.org).

- 1 Turn the projector off and unplug the power cord.
- 2 Wait 60 minutes to allow the projector to cool thoroughly.
- 3 Remove the lamp door by removing the screws on the side of the lamp door, and lifting the door off.



Turn off and  
unplug projector

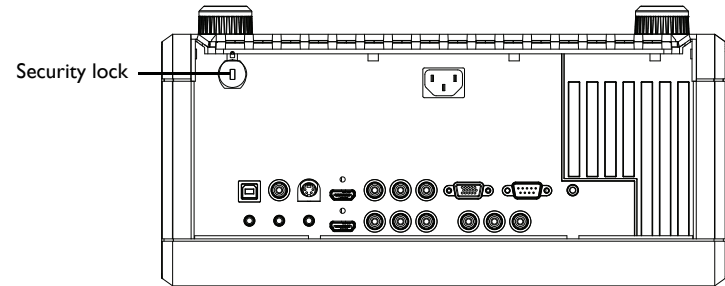


- 4 Loosen the captive screws that attach the lamp housing to the projector.
- 5 Using the handle, carefully remove the lamp housing. Dispose of the lamp in an environmentally proper manner in accordance with local disposal laws.
- 6 Install the new lamp housing, pressing the lamp into place.
- 7 Tighten the captive screws.
- 8 Replace the lamp door and tighten both screws.
- 9 Plug in the power cord and press the **Power** button to turn the projector back on.
- 10 To reset the lamp hour timer, navigate to the **Status and Service** menu and select **Reset Lamp Hours**. See page 31 for details.



## Using the security lock

The projector has a security lock for use with a Cable Lock System. Refer to the information that came with the lock for instructions on how to use it.





# Appendix

## SplitScreen Compatibility

Splitscreen allows two distinct sources to be displayed simultaneously. Switch primary sources, make picture adjustments and choose one of multiple display options: either two side by side horizontal or vertical source regions, or a small secondary source image displayed on top of the primary source in one of four placement options. Lets you show two different sources at the same time. See page 27 for details. The following source combinations are supported:

*Table 2:*

	HDMI 1	HDMI 2	VGA/ Component 4	Component 1	Component 2	Component 3	S-video	Composite
HDMI 1		X			X	X		
HDMI 2	X		X	X			X	X
VGA/Component 4		X			X	X		
Component 1		X			X	X		
Component 2	X		X	X			X	X
Component 3	X		X	X			X	X
S-video		X			X	X		
Composite		X			X	X		

## RS-232 commands

**IMPORTANT:** When formatting commands sent from a control system or computer, enclose commands in parentheses "(" and ")". When entering custom commands into Scheduled Tasks in the projector's web interface, enclose commands in less than/greater than symbols "<" and ">" instead.

### Communication Configuration

Visit our website for additional RS-232 settings and information.

To control this projector via RS-232, connect a null modem cable and set the control system serial port settings to match the following communication configuration:

RS-232 Port Settings	
Setting	Value
Bits per second	115,200
Data bits	8
Parity	None
Stop bits	1
Flow control	None
Emulation	VT100

### Command Format

All commands consist of 3 alpha characters followed by a request, all enclosed in parentheses. The request can be a read request (indicated by a "?") or a write request (indicated by 1 to 4 ASCII digits).

A read request example:

(AAA?) where  
(starts the command  
AAA denotes the command  
? denotes the read request  
) ends the command

A read command returns the range and the current setting, for example:

Read Command Examples		
Function	Command	Response
Brightness	(BRT?)	(96-160,128)
Volume	(VOL?)	(0-32, 0)
Lamp Hours	(LMP?)	(0-32766, 42)

A write request example:

(AAA####) where  
(starts the command  
AAA denotes the command  
#### denotes the value to be written  
(leading zeros not necessary)  
) ends the command

Some commands have ranges, while others are absolute. If a number greater than the maximum range is received, it is automatically set to the maximum number for that function. If a command is received that is not understood, a "?" is returned. With absolute settings, "0" is off, 1-9999 is on. The one exception is the Power command, where 0 is off and 1 is on.

To assure the projector can process a command, wait 3 seconds before entering the next command.

Read Command Examples		
Function	Command	Response
Brightness	(BRT140)	Sets the brightness to 140
Power	(PWR0)	Turns power on
Power	(PWR1)	Turns power off

### Error Conditions

Not all commands are supported for all projectors. If an unsupported command is issued, the command will be ignored. If a command is received that is not understood, a '?' character will be returned indicating the command was not understood.

### Limitations

The projector cannot respond to commands coming in at a high-rate. Therefore, a delay must occur between commands to ensure that the command gets properly executed. To assure the projector can process a command, wait 3 seconds before entering the next command.

The Step column refers to increasing or decreasing the menu bar position since the On-screen Display is not an exact match of values. For example, Step 2 changes the data by 2 through the CLI (Command Line Interface). The menu bar is up (or down) by 1.

Function	Command	Min	Max	Default	Step
About (Source Info) 0: n/a 1: enable	ABT at W	0	1	n/a	
Advance to next Computer Source	CAD+ at RW	0	2	0: DVI D.1: VGA1 D.2: VGA2	
Aspect Ratio 0: Native 1: 16:9 2: 4:3	ARZ at RW	0	2	2	
Aspect Ratio Advance Command	ARZ+ at RW	0	6	2	
Aspect Ratio of Current Source	QAR at R				
Auto Image 0: n/a 1: enable	AIM at W 0	0	1	n/a	
Auto Power 0: disable 1: enable	APO at RW	0	1	0	
Auto Source 0: disable 1: enable	ASC at RW	0	1	1	
Auto Off Time Setting	AOT at RW	0	6	0	
Blank 0: off 1: on	BLK at RW	0	1	0	

Blank Screen 0: black 1: blue 2: white	BSC at RW	0	2	0	
Blank Screen Style Setting	BSS at RW	0	6	0	
Blue Gain	BCG at RW	0	100	50	I
Brightness	BRT at RW	0	100	0	I
BrilliantColor™ Setting	BCL at RW	0	1	0	
Ceiling 0: disable 1: enable	CEL at RW	0	2	2	I
CLI Version Setting	CLV at R	string: "2.0"			
Closed Captions (Non-Muted) Setting	CLC	0	3	0	
Closed Captions (Non-Muted) Advanced	CLC+ at RW	0	3	0	
Color	CLR at RW	0	100	50	I
Color Gamut Setting	CGA	0	4	0	

Color Space 0: Auto 1: RGB 2: REC709 3: REC601 4: RGB Video	CSM at RW	0	4	0	
Color Temp 0: 9300K 1: 6500K 2: 7200K 3: User	TMP at RW	0	3	2 (computer 2,3) 0 (other)	
Color Wheel Index Setting	CWI at RW	0	719	458	
Color Wheel Ramp Mode Setting	CRM at RW	0	4	0	
Configuration Data	CVS at R	n/a	n/a	n/a	
Contrast	CON at RW	0	100	50	
Clear System EPROM Command	CEE at RW				
Current Color Space	QCS at R				
Current Source Name	QAS at R				
Current Source Resolution	RES at R				
Current Source Signal	QST at R				
Current Source Value	QSF at R				

Current Sub-Source Setting	CRS at R	n/a	n/a	n/a	
Custom Key (Effect) 6: freeze 8: Source Info 10: Projector Info 14: Overscan 17: SplitScreen	EFK at RW	0	16	6	
Detect Film Setting	TTO	0	1	0	
Display Messages 0: disable 1: enable	DMG at RW	0	1	0	
Disable Snapshot Setting	DCP at RW	0	1	0	
DynamicBlack™ Setting	DYB at RW	0	4	0	
Error Condition Setting 1: Lamp wont' strike after 5 attempts, 2: Reserved 3: Lamp went out unexpectedly 4: Fan Failure 5: Over temperature 6: Low voltage	ERR at R	0	6	1	
Factory Reset 0: not reset 1: reset	RST at W	0	1	0	

Fast Color Refresh Setting	FCR	0	1	0	
Flash Update Command	FMR at RW	0	1	0	
Flesh Tone Correction Setting	FTC	0	100	0	
Firmware Version	FVS at R	2			
Freeze 0: disable 1: enable	FRZ at RW	0	1	0	
Gamma Setting	GTB at RW	0	8	2	
Glow Ring Setting	GLO at RW	0	1	1	
Green Gain	GCG at RW	0	100	50	1
HDMI DDC Settings	EE0 at RW	0	1	0	
HDMI DDC Settings	EE1 at RW	0	1	0	
Help Command	HLP at RW	0	1	0	
Horizontal Keystone	DKH at RW	0	100	50	1
Horizontal Position	HPS at RW	0	100	50	1
Horizontal Refresh Frequency	QHR at R				
IRIS Setting	IRS at RW	0	100	50	
Key Click Setting	KCL at RW	0	1	1	

Keypad Enable Setting	KPE at RW	0	1	0	
Keycode Entry Setting	KEY at W				
Keypad Navigation Type Setting	KNT at R	2	4		
Lamp High Power Setting	HPE	0	1	0	
Lamp Low Power Setting	IPM at RW	0	1	0	
Language 0: English 1: French 2: German 3: Italian 5: Korean 6: Norwegian 7: Portuguese 8: Russian 9: Simplified Chinese 10: Spanish 11: Traditional Chinese 12: Swedish 13: Dutch 14: Polish 15: Turkish 16: Danish 17: Finnish	LAN at RW	0	17	0	
Lamp Hours	LMP at R	0	32766	0	1
Lamp Hours in Low Power Mode	LME at R	58			

Lamp Hours in High Power Mode	LMO at R	150			
Lamp Life Setting	LIF at R				
Lamp Hour Reset 0: not reset 1: reset	LRT at W	0	1	0	
Lamp Resets (Total number)	LMR at R	0	32766	0	
Lamp Total On Time (All Bulbs)	LMT at R	0	83646	0	
Language Initial Value Setting	LIV at RW	0	17	0	
Magnify Controls Setting	MGC at RW	0	1	0	
Magnify Horizontal Position Settings	MGH at RW	-80	80	0	
Magnify Level Setting	MGL at RW	0	25	0	
Magnify Vertical Position Settings	MGV at RW	-60	60	0	
Menu 0: disable 1: enable	MNU at RW	0	1	0	
Menu Lockout Setting	MNL at RW	0	15	0	
Menu Navigation 0: up 1: down 4: select	NAV at W	0	4	n/a	

Menu Offset Setting	OFF at RW	0	100	0	
Menu Transparency Setting	TOE at RW	5	15	10	
Motion Smoothing		0	4	0	
Native Resolution	NRS at R				
NND (PC Screen Saver Off) 0: disable 1: enable	NND at RW	0	1	1	
Noise Reduction Setting	NRL	0	100	0	
Overscan 0: disable 1: enable	OVS at W	0	1	0	
Phase	MSS at RW	0	100	0	1
Picture-in-Picture Layout Setting	SSC	0	7	0	
Picture-in-Picture Size Setting	SSZ	0	2	0	
Picture-in-Picture Source Advance Commands	SSL+	0	7	0	
Picture-in-Picture Source Setting	SSL	0	7	0	
Picture-in-Picture Swap Command	SSS				
Picture Player Control Settings	LAS	0	1	0	

Pixel Clock Frequency	QPC at R				
Power 0: disable 1: enable	PWR at RW	0	1	0	
Power-up Source 0: VGA 1: HDMI 1 2: HDMI 2 3: Component 1 4: Component 2 5: Component 3 6: S-video 7: Composite	DSC at RW	0	5	0	
Power Setting	PWR at RW	0	1	0	
Power Sounds Setting	ACE at RW				
Presets 0: user 1 1: user 2 2: user 3 3: Presets Off 5: presentation 7: video 10: bright 11: whiteboard	PST at RW	0	13	0	
Print Text Command	PRN				
Rear 0: disable 1: enable	REA at RW	0	1	0	
Red Gain	RCG at RW	0	100	50	1

Save User Presets 1 0: not saved 1: saved	US1 at W	0	1	n/a	
Save User Presets 2 0: not saved 1: saved	US2 at W	0	1	n/a	
Save User Presets 3 0: not saved 1: saved	US3 at W	0	1	n/a	
SCART Type Setting	SCA	0	1	0	
Screen Save 0: 5 minutes 1: 10 minutes 2: 15 minutes 3: 20 minutes 4: 25 minutes 5: 30 minutes	SSV at RW	0	6	0	
Search Screen	DSU at RW	0	4	0	
Serial Port Baud Rate Setting	BR! at RW	0	8	7	
Serial Port Echo Setting	EC1 at RW	0	1	0	
Set Black Level Command	BLC				
Sharpness 5: Sharpest 6: Sharper 7: Standard 8: Softer 9: Softest	SHP at RW	0	2	1	

Sleep Time Setting	SLT	0	3	0	
Source 0: VGA 1: HDMI1 2: HDMI 2 3: Component 1 4: Component 2 5: Component 3 6: S-video 7: Composite	SRC at RW	0	5	0	
Source Name Setting	SN0 SN1 SN2 SN3 SN4 SN5				
Source Advance	CAD at RW	0	2	0: DVI D.1: VGA1 D.2: VGA2	
Source Advance - All Command	SRC at RW	0	5	0	
Source Advance - Video Command	VAD at RW	3	5	3:HDMI 4: S-video 5: composite	
Source Advance to Next Source	VAD+ at RW	3	5	3:HDMI 4: S-video 5: composite	
Source 1-4 Commands	SRn at RW				
SplitScreen Enable 0: off 1: on	SSC at RW	0	1	0	



SplitScreen Second Source 0:off 1: VGA 2: HDMI I 3: HDMI 2 4: Component 1 5: Component 2 6: Component 3 7: S-video 8: Composite	SSL at RW	0	6	0	
SplitScreen Second Source Location 0:right 1: bottom 2: left 3: top 4: bottom right 5: bottom left 6: top left 7: top right	SSY at RW	0	7	0	
SplitScreen Second Source Size 0: small 1: medium 2: large	SSZ at RW	0	2	2	
SplitScreen Swap 0: n/a 1: enable	SSS at W	0	1	n/a	
Standby Power Save	SPS at RW	0	1	1	
Startup Logo 0: blank screen 1: default 2: captured	SHP at RW	5	9		

Sync Threshold Setting	STH at RW	0	100	0	
System State Setting	SYS at R				
Take Snapshot Command	CAP at RW	0	1	0	
Test Pattern Select Setting	TPS at RW	0	14	0	
Tint	TNT at RW	0	100	50	1
Tracking	MTS at RW	-20	+20	0	1
Vertical Keystone	DKV at RW	0	100	50	1
Vertical Position	VPS at RW	0	100	50	1
Vertical Refresh Frequency	QVR at R				
Video Standard	VSU at RW	0	5	0	
Red Offset Green Offset Blue Offset	RCO at RW GCO at RW BCO at RW	0	100	50	

# INDEX

## Numerics

16x9 vs 4x3 13

## A

Aspect Ratio 13, 14

## C

Cable box 13

Computer In connector 10

Connecting

    Computer 10

    Video device 13

Connecting a computer source 10

Contacting InFocus 22

Customer service contact information 22

## D

Digital Zoom 27

## F

Focus 12

## H

Help 31

## K

Keypad buttons 24

Keystone 19

## L

Laptop video port activation 11

## M

Menu usage 26

## O

Optimizing computer image 24

Optimizing video images 25

## P

Position the projector 7

Power connector 10

Power cord 10

Presentation features 24

## Projector

    Connecting video devices 13

    Keypad buttons 24

    Menus 26

    Positioning 7

    Setting up 7

    Shutting down 15

    Troubleshooting problems 15

projector

    Connecting computers 10

## R

Remote control 23

## S

Screen Aspect 13

Screen Save 15

Shutting down the projector 15

S-video connector 13

## T

TV tuner 13

## W

Warranty 22

## Z

Zoom 12