

myprojectorlamps.com

**The most trusted, dependable name
in projector lamp sales.**



<http://www.myprojectorlamps.com>



<http://www.myprojectorlamps.ca>



<http://www.myprojectorlamps.eu>

The following projector manual has not been modified or altered in any way.

ScreenPlay™
4800



User's Guide

[English • Français • Deutsch • Español • Italiano • Norsk]

ScreenPlay™
by InFocus®

ENGLISH

Declaration of Conformity

Manufacturer: InFocus Corporation, 27700B SW Parkway Ave. Wilsonville, Oregon 97070 USA

European Office: Strawinskylaan 585, 1077 XX Amsterdam, The Netherlands

We declare under our sole responsibility that the ScreenPlay 4800 projector conforms to the following directives and norms:

EMC Directive 89/336/EEC, Amended by 93/68/EEC

EMC: EN 55022

EN 55024

EN 61000-3-2

EN 61000-3-3

Low Voltage Directive 73/23/EEC, Amended by 93/68/EEC

Safety: EN 60950: 2000

June, 2003

Trademarks

Apple, Macintosh, and PowerBook are trademarks or registered trademarks of Apple Computer, Inc. IBM is a trademark or registered trademark of International Business Machines, Inc. Microsoft, PowerPoint, and Windows are trademarks or registered trademarks of Microsoft Corporation. Digital Light Processing is a trademark or registered trademark of Texas Instruments. InFocus and ScreenPlay are trademarks or registered trademarks of InFocus Corporation.

FCC Warning

Note: This equipment has been tested and found to comply with the limits for a Class B digital device, pursuant to part 15 of the FCC Rules. These limits are designed to provide reasonable protection against harmful interference in a residential installation. This equipment generates, uses and can radiate radio frequency energy and, if not installed and used in accordance with the instructions, may cause harmful interference to radio communications. However, there is no guarantee that interference will not occur in a particular installation. If this equipment does cause harmful interference to radio or television reception, which can be determined by turning the equipment off and on, the user is encouraged to try to correct the interference by one or more of the following measures:

--Reorient or relocate the receiving antenna.

--Increase the separation between the equipment and receiver.

--Connect the equipment into an outlet on a circuit different from that to which the receiver is connected.

--Consult the dealer or an experienced radio/TV technician for help.

Canada

This Class B digital apparatus complies with Canadian ICES-003.

Cet appareil numérique de la classe B est conforme à la norme NMB-003 du Canada.

Agency Approvals

UL, c-UL, TÜV, GOST, C-Tick

Table of Contents

Introduction	4
Positioning the projector	5
Connecting a computer source	6
Required computer connections	6
Optional computer connections	6
Displaying a computer source image	7
Adjusting the image	8
Using the projector with Windows 98 for the first time	9
Connecting a video device	11
Projector and Device Connector Guide	12
Computer connections	12
Video connections	12
Video device connections	15
Composite video connection	15
S-video connection	15
Component video connection	16
VGA connection	16
Displaying video	17
Adjusting the image	17
Shutting down the projector	19
Troubleshooting your setup	19
Using the remote control	27
Using the audio	28
Using the keypad buttons	28
Optimizing computer images	29
Presentation features	29
Optimizing video images	30
Customizing the projector	30
Using the menus	31
Picture menu	32
Settings menu	35
Maintenance	37
Cleaning the Lens	37
Replacing the Projection Lamp	37
Cleaning the Lamp Housing Screens	39
Using the security lock	39
Appendix	40
Specifications	40
Accessories	40
Projected image size	41
Red LED Behavior and Projector Errors	41

If you are experienced in setting up projection systems, use the *Quick Setup* card that was included. For complete details on connecting and operating the projector, refer to this User's Guide.

Important Operating Considerations

Do not place the projector on a tablecloth or other soft coverings that may block the front or back vents. Do not use a non-approved ceiling mount. In the unlikely event of the bulb rupturing, thoroughly clean the area in front of the projector and discard any edible items that may have been placed in that area.

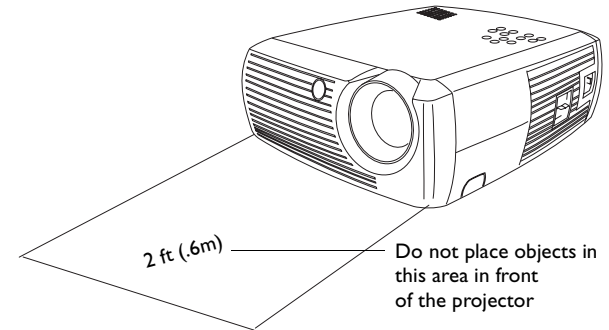

Introduction

Your new digital projector is easy to use and maintain. It is an exceptional projector for both business presentations and home entertainment. The digital projector is compatible with a wide variety of computers and video devices, including:

- Most standard VCRs, DVD players (progressive and interlaced), HDTV sources (1080i, 1035i, and 720P HDTV formats), TV and satellite tuners, camcorders, video games, and laser disc players.
- IBM-compatible computers and laptops, up to 1024x768 resolution.
- Apple® Macintosh® and PowerBook® computers up to 1024x768 resolution.

The projector has native SVGA 800x600 resolution and comes with the following standard accessories.

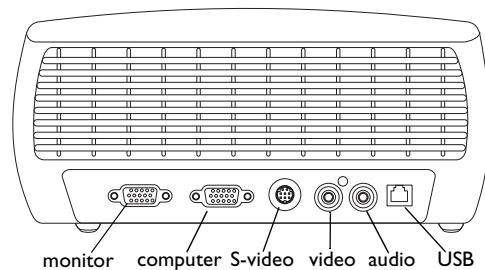
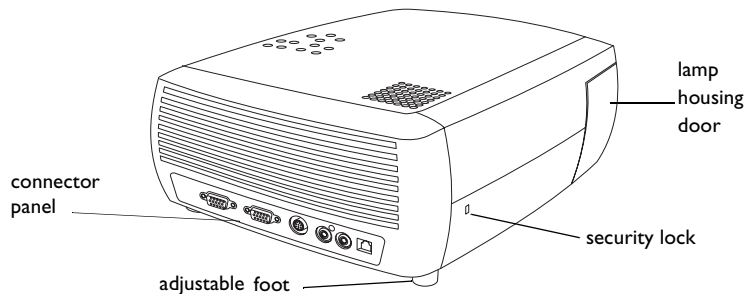
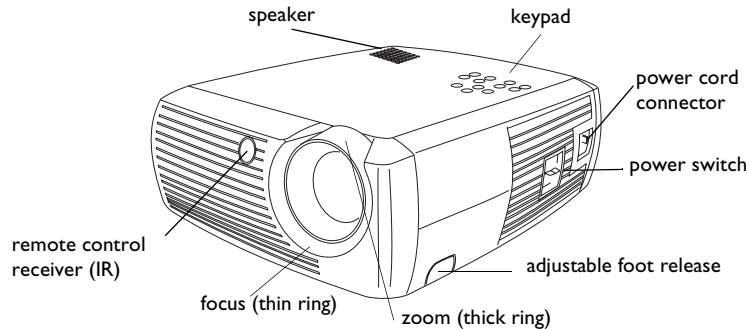
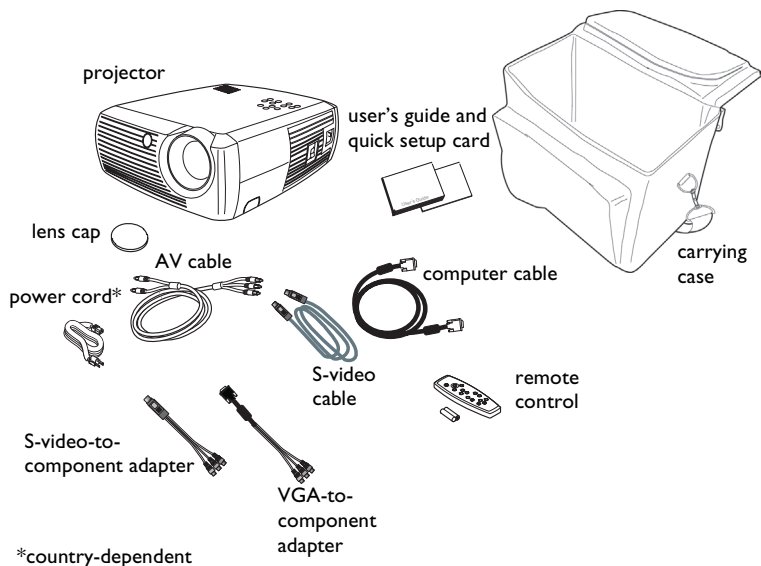

Positioning the projector

To determine where to position the projector, consider the size and shape of your screen, the location of your power outlets, and the distance between the projector and the rest of your equipment. Here are some general guidelines:

- Position the projector on a flat surface at a right angle to the screen. The projector must be at least 4.9 feet (1.49m) from the projection screen.
- Position the projector within 10 feet (3m) of your power source and within 6 feet (1.8m) of your video device (unless you purchase extension cables). To ensure adequate cable access, do not place the projector within 6 inches (.15m) of a wall or other object.
- Position the projector the desired distance from the screen. The distance from the lens of the projector to the screen, the zoom setting, and the video format determine the size of the projected image. The top illustration to the right shows three projected image sizes. For more information about image sizes at different distances, see “Projected image size” on page 41.
- The image exits the projector at a given angle. This image offset is 132.9% when the projector is in 16:9 mode (default). This means that if you have an image 10' high, the bottom of the image will be 3.29' above the center of the lens.
- The image offset is 112.2% when the projector is in 4:3 mode. This means that if you have an image 10' high, the bottom of the image will be 1.22' above the center of the lens.
- See “Connecting a video device” on page 11 for additional information on 16:9 and 4:3 modes.

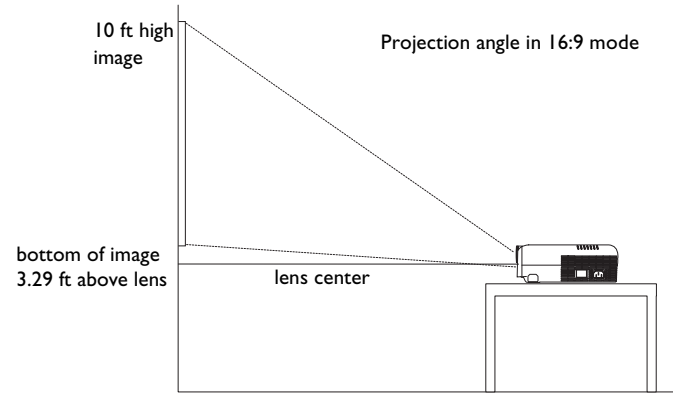
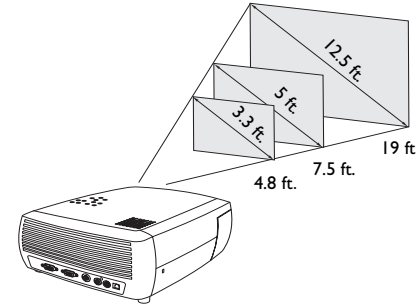

Connecting a computer source

Required computer connections

Connect one end of the computer cable (see page 11 for connecting video devices) to the dark blue **Computer In** connector on the projector. Connect the other end to the video port on your computer. If you are using a desktop computer, you will need to disconnect the monitor cable from the computer's video port first.

Connect the black power cord to the **Power** connector on the side of the projector and to your electrical outlet.

NOTE: Always use the power cord that shipped with the projector.

connect computer cable

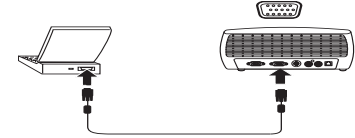

connect power cable

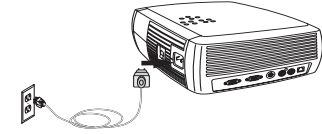

Optional computer connections

To have sound with your presentation, connect an audio cable (not included with this projector) to your computer and to the **Audio In** connector on the projector. Visit www.infocus.com/accessories to view optional cables..

If you are using a desktop computer and want to see the image on your computer screen as well as on the projection screen, connect the computer's monitor cable to the **Monitor Out** connector on the projector.

connect audio cable

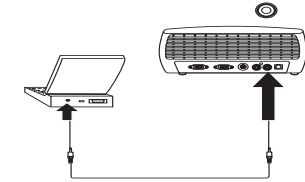

connect monitor cable

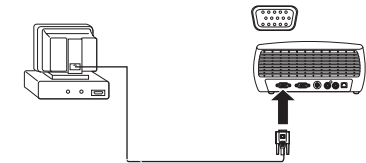

You can use your computer's mouse with an optional remote control to operate the navigation buttons during a presentation. The remote included with this projector does not allow this function. Connect the projector to the computer via a USB cable (not included). USB drivers must be installed to use the USB feature. For more information, see page 10. Visit www.infocus.com/accessories to view optional remote controls.

connect USB cable

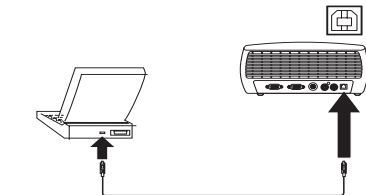

Displaying a computer source image

Remove the lens cap.

remove lens cap

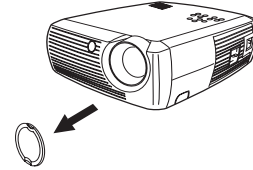

Toggle the **Power** switch on the side of the projector to the On position.

The LED flashes green and the fans start to run. When the lamp comes on, the start up screen displays and the LED is steady green. It can take a minute for the image to achieve full brightness.

toggle Power switch

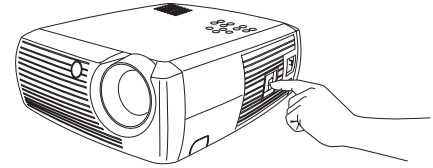

? **No start up screen?** Get help on page 20.

Turn on your computer.

The computer's image should appear on the projection screen. If it doesn't, press the **Computer** button on the projector's keypad.

turn on computer



computer

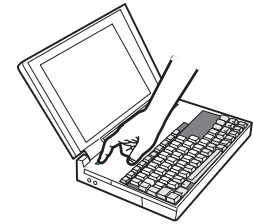

If your computer has Windows 98 as its operating system, see "Using the projector with Windows 98 for the first time" on page 9 regarding the driver setup process.

Make sure your laptop's external video port is active.

Many laptops do not automatically turn on their external video port when a projector is connected. Usually a key combination like FN + F5 is used to turn the external display on and off. Refer to your laptop's documentation to learn your laptop's key combination.

activate laptop's external port

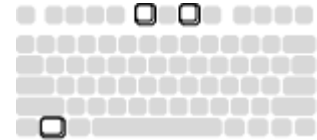

? **No laptop image?** Try pressing the **Auto Image** button on the keypad. Get help on page 21.

Adjusting the image

Adjust the height of the projector, if necessary, by pressing the release button to extend the foot.

Rotate the leveling foot located at the rear of the projector, if necessary.

Avoid placing your hands near the hot exhaust vent in front of the projector.

Position the projector the desired distance from the screen at a 90 degree angle to the screen.

See page 41 for a table listing screen sizes and distances.

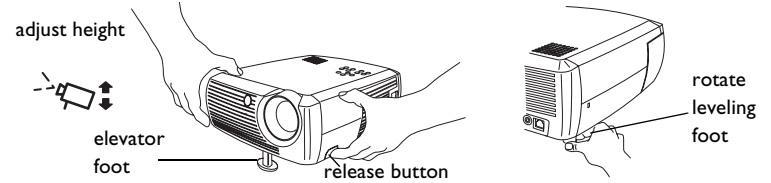

adjust distance

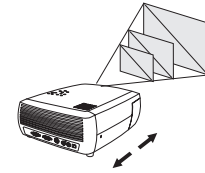

Adjust the zoom or focus.

adjust zoom or focus

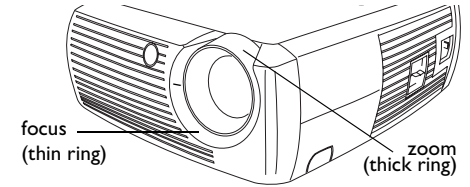

If the image is not square, adjust the keystone using the buttons on the keypad.

Press the top **Keystone** button to reduce the upper part of the image, and press the bottom **Keystone** button to reduce the lower part.

adjust keystone

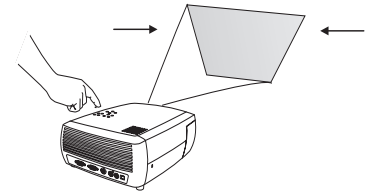

Adjust the Contrast or Brightness in the Picture menu.

See page 32 for help with these menu adjustments.

adjust Picture menu

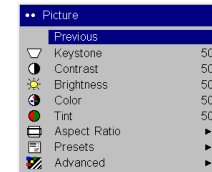

Using the projector with Windows 98 for the first time

The first time you connect a computer running Windows 98 to the projector, the computer recognizes the projector as “new hardware” and the Add New Hardware Wizard appears. Follow these instructions to use the Wizard to load the correct driver (which was installed with your Windows operating system).

If you are running Windows 2000 or Windows ME, skip these steps and go to “Adjusting the image” on page 8.

a Click **Next** to begin searching for the driver.

b Make sure “Search for the best driver” is selected, then click **Next**.

c Uncheck any checked boxes, then click **Next**. Windows automatically locates the driver. If this driver has been removed, reload the driver using your Windows operating system CD.

d When Windows finds the driver, you are ready to install it. Click **Next**.

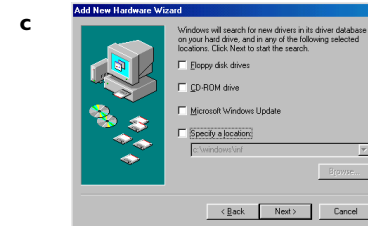
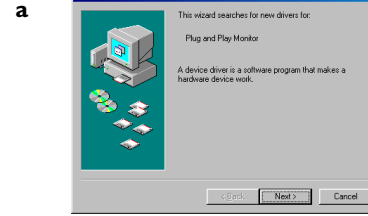

Skip this page if you did not connect a USB mouse cable

For Windows 98:

- If you connected the USB cable, the Add New Hardware Wizard appears again. Drivers must be installed to use the USB functionality.
- **The Wizard launches three times.**

The first time it detects a USB Composite Device.

The second time a USB Human Interface Device (for the keyboard) is detected.

The third time it detects a USB Human Interface Device (for the mouse).

For Windows 2000, Windows ME, and Windows XP:

- The USB drivers are automatically installed.

Connecting a video device

You can connect video devices such as VCRs, DVD players, camcorders, digital cameras, video game consoles, HDTV receivers, and TV tuners to the projector. There is also an audio input. You can connect the audio directly to the projector to get sound from the built-in speaker, or you can connect the audio to your stereo system.

Before connecting your projector, you should decide which aspect ratio you want to use. The projector's Aspect Ratio setting is accessed through the projector's Menu. See page 32 for more information.

Aspect ratio is the ratio of the image width to image height. TV screens are usually 4:3. HDTV and most DVDs are 16:9, which is the default for this projector. If you're projecting onto a screen, the size/shape of the screen may answer this question for you. If you are projecting onto a blank wall, you don't have the screen size restriction. What you plan to project will also help you choose between 4:3 and 16:9. Most regular TV shows are 4:3, while most movies are 16:9.

If you have a 16:9 screen then you should select an aspect ratio of 16:9 for anamorphic movies or HDTV, and Native for 4:3 content. If you have a 4:3 screen you should still use 16:9 for anamorphic movies or HDTV, but you also have the option of using either 4:3 (to fill the screen) or Native (for direct pixel mapping) for 4:3 content. Keep in mind that anamorphic movies only appear correctly if the DVD player is set to output to a 16:9 television.

You can connect the projector to most video devices that can output video. You cannot directly connect the coaxial cable that enters your house from a cable or satellite company, the signal must pass through a tuner first. Examples of tuners are digital cable boxes, VCRs, digital video recorders, and satellite TV boxes. Basically, any device that can change channels is considered a tuner.

4:3 screen

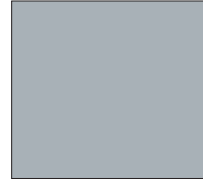

16:9 screen



4:3 mode



16:9 mode

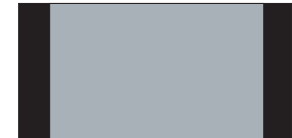

Native mode (NTSC only)

Projector and Device Connector Guide

The following should help you find the connectors that you want to use to obtain the best resolution possible from your input devices, such as computers, standard VCRs, DVD players (progressive and interlaced), HDTV sources (1080i, 1035i, and 720P HDTV formats), TV and satellite tuners, camcorders, video games (progressive and interlaced), and laser disc players.

Computer connections

Computer connections involve attaching the computer cable included with the projector from a computer to the Computer In input. Optional connections include attaching the AV cable from computer to projector, connecting the computer monitor to the projector, and connecting a USB cable (not-included) from the computer to the projector to control the mouse through the remote. See page 6 for computer/projector setup information.

Video connections

The first step for connecting video is deciding what type of output connector you want to connect to the projector. If there is more than one output, select the one with the highest quality. The best quality ranking, with **1** being the highest and **3** being the lowest, is:

- 1** Component video
- 2** S-video
- 3** Composite video

If you are connecting the projector to HDTV sources, the projector's computer (VGA) connector, labeled **Video In**, should be used. Keep in mind that HDTV and progressive sources should only be handled through the projector's VGA connector. The S-video port does not function with progressive sources, even with the Component to S-video adapter. With progressive sources, the Component to VESA adapter must be used.

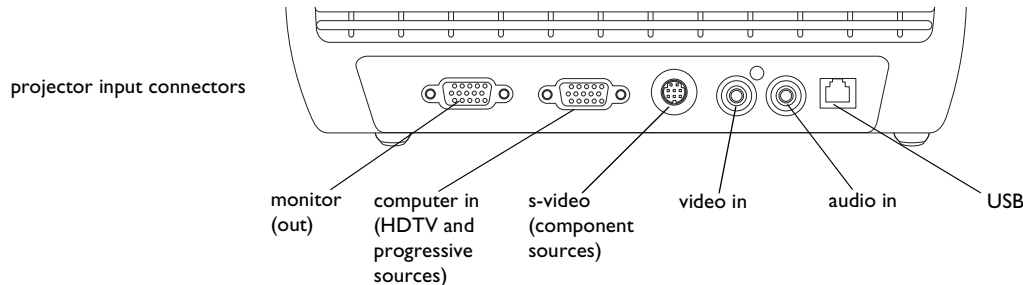

Video Device	Video Compatibility	If Your Device Connector Is	Attach to this Labeled Connector on Projector	Comments	For Setup Instructions, see
Standard Broadcast TV (not HDTV) via: cable, digital cable, satellite TV, DVD, or VCR	NTSC, PAL, and SECAM formats Component 480i	Composite video or S-video Component Video	Composite video or S-video S-video via the Component to S-video adapter	Not for progressive (i.e. HDTV) sources. See next page.	Composite video connection on page 15. S-video connection on page 15 Component video connection on page 16
Standard Video Camera	NTSC, PAL, and SECAM formats Component 480i	Composite video or S-video Component Video	Composite video or S-video S-video via the Component to S-video adapter	Not for progressive (i.e. HDTV) sources. See next page.	Composite video connection on page 15. S-video connection on page 15 Component video connection on page 16
Standard Video Game	NTSC, PAL, and SECAM formats Component 480i	Composite video or S-video Component Video	Composite video or S-video S-video via the Component to S-video adapter	Not for progressive (i.e. HDTV) sources. See next page.	Composite video connection on page 15. S-video connection on page 15 Component video connection on page 16

Video Device	Video Compatibility	If Your Device Connector Is	Attach to this Labeled Connector on Projector	Comments	For Setup Instructions, see
HDTV (High Definition TV)	1080i, 720p	VGA	Computer In	Not for Component 480i	VGA connection on page 16
EDTV (Enhanced Definition TV)	Component 480p	Component video	Computer In (via the Component to VESA adapter)	Not for Component 480i	Component video connection on page 16
Progressive DVD	1080i, 720p	VGA	Computer In		VGA connection on page 16
	Component 480p	Component video	Computer In (via the Component to VESA adapter)	Not for Component 480i	Component video connection on page 16
Progressive Video Game	1080i, 720p	VGA	Computer In		VGA connection on page 16
	Component 480p	Component video	Computer In (via the Component to VESA adapter)	Not for Component 480i	Component video connection on page 16

Video device connections

Composite video connection

Plug the AV cable's yellow connector into the video-out connector on your video device. Plug the cable's other yellow connector into the yellow **Video In** connector on the projector. Plug the AV cable's blue connector into the blue **Audio In** connector on the projector. Plug the AV cable's white connector into the left white out connector on the video device. Plug the AV cable's red connector into the right audio out connector on the video device.

Keep in mind that video output from composite connections are not as high quality as S-video or component.

connect AV cable

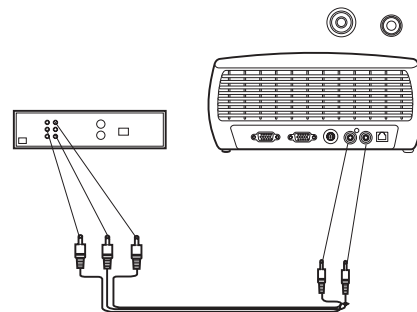

S-video connection

If your video device uses a round, four-prong S-video connector, plug an S-video cable into the S-video connector on your video device and into the **S-video** connector on the projector. Also, plug the red and white AV cable connectors into your video device's audio out connectors, and the blue audio connector into your projector's **Audio In** connector.

Keep in mind that S-video delivers higher quality video output than composite, but not as high quality video output as component.

connect S-video

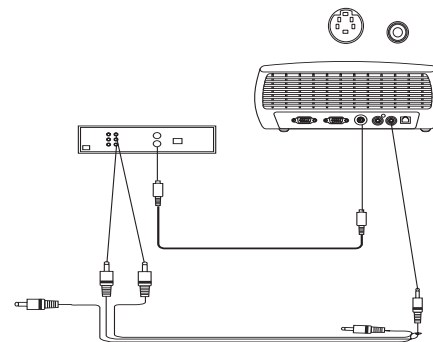

Component video connection

If your video device has component connectors, use the Component to S-video adapter. For HD and progressive sources use the Component to VESA adapter along with a Component cable (not included).

Plug the Component cable into the video device. Plug the other end of the Component cable into one of the two adapter's and plug the adapter into the projector's **S-video** (for S-video) or **Computer in** (for VESA) connector.

Component connection offers the highest quality video output.

connect component cables via Component to S-video adapter

or
via Component to VESA adapter

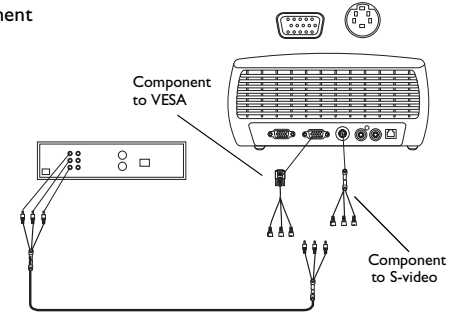

VGA connection

If your video device has a 15-pin VGA output, plug one end of the computer cable to the VGA connector on your video source. This connector may be labeled "To Monitor" on the video source. Plug the other end of the cable into the **Computer In** connector on the projector.

For audio, connect the white and red AV cable connectors into your video device. Plug the blue connector into the projector's **Audio In** connector.

connect VGA cable and
AV cable

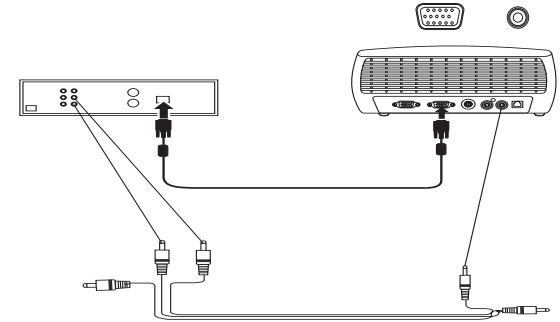

Connect the power cord to the **Power** connector on the side of the projector and to your electrical outlet.

NOTE: Always use the power cord that shipped with the projector.

connect power cable

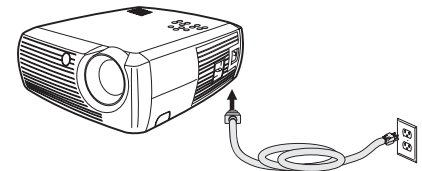

Displaying video

Remove the lens cap.

remove lens cap

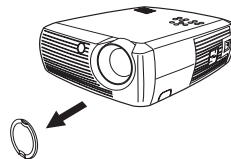

Toggle the **Power** switch on the side of the projector to the **On** position.

toggle Power switch

The LED flashes green and the fans start to run. When the lamp comes on, the start-up screen is displayed and the LED is steady green. It can take a minute for the image to achieve full brightness.

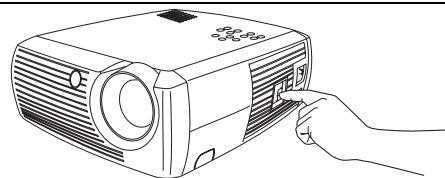

? **No start up screen?** Get help on page 20.

Plug in and turn on your video device.

turn on video device

The video device's image should appear on the projection screen. If it doesn't, press the **Video** button on the keypad.

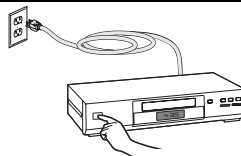

? **No image?** Get help on page 21.

Adjusting the image

Adjust the height of the projector by pressing the release button to extend the foot.

adjust height

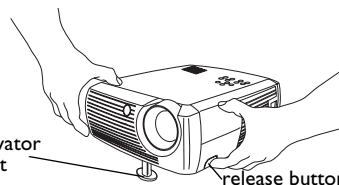

Rotate the leveling foot at the rear of the projector, if necessary.

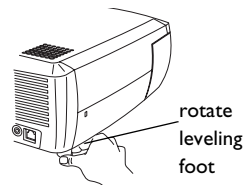

Position the projector the desired distance from the screen at a 90 degree angle to the screen.

adjust distance

See page 41 for a table listing screen sizes and distances to the screen.

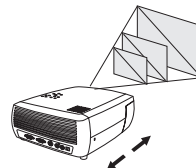

Adjust the zoom and focus.

adjust zoom and focus

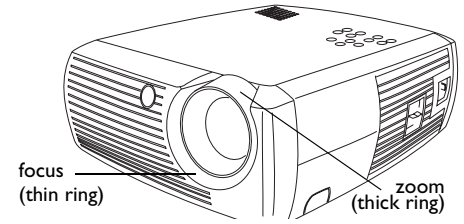

If the image is not square, adjust the keystone using the buttons on the keypad. Press the top **Keystone** button to reduce the upper part of the image, and press the bottom **Keystone** button to reduce the lower part.

adjust keystone

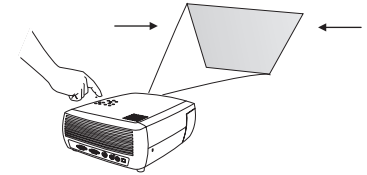

Adjust the volume on the keypad.

adjust volume

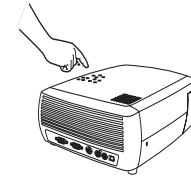

Adjust the Contrast, Brightness, Color, Tint, or Aspect Ratio in the Picture menu. See page 32 for help with the menus and these adjustments.

For Aspect Ratio, keep in mind that DVD players must be configured for 16:9 in order to view the highest quality image. For more information regarding Aspect Ratio, see page 11.

adjust Picture menu options including Aspect Ratio

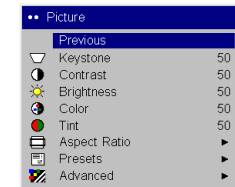

Shutting down the projector

The projector automatically displays a black screen after no active source is detected for 30 minutes. This black screen helps preserve the life of the projector. The image returns when an active source is detected or a remote or keypad button is pressed.

Power Save

The projector also has a Power Save feature that automatically turns the lamp off after no active sources are detected and no user interaction with the projector is performed for 20 minutes. By default, this feature is off. See page 35.

Turning off the projector

You can turn the projector off simply by toggling the power switch to the off position.

You can also press the remote's Power button to place the projector in the Off state while it is running. When the Power button is pressed twice (once to start the power-down process and a second time to verify that you want to power the projector off), the lamp turns off and the LED blinks green for one (1) minute while the fans continue to run to cool the lamp. While the LED is blinking green, the projector does not accept any keypad and remote control input.

When the lamp has cooled, the LED lights solid green and the fans slow down to minimal speed. To turn off the projector, toggle the power switch to the off position.

NOTE: Once the projector has been toggled off, you must wait for one (1) minute before turning the projector on again. This allows the lamp to properly cool. However, if the remote was used to power the projector to the Off state you do not need to wait one minute to turn it on again.

Troubleshooting your setup



If your image appears correctly on the screen, skip to the next section. If it does not, troubleshoot the setup.

The LED on top of the projector indicates the state of the projector and can help you troubleshoot.

Table 1: LED behavior and meaning

LED color/behavior	Meaning
solid green	The power switch has been toggled on and the software has initialized or the projector has been powered off via the remote.
blinking green	The power switch has been toggled on and the software is initializing, or the projector is powering down and the fans are running to cool the lamp.
blinking red see page 41 for more information	A fan or lamp failure has occurred. Make sure the vents aren't blocked (see page 25). Turn off the projector and wait one minute, then turn the projector on again. If the projector has been working for up to 4,000 hours or more (page 37), replace the lamp and reset the lamp timer. Contact Technical Support if the problem persists.
solid red	An unidentifiable error: please contact Technical Support.

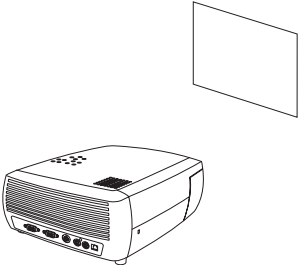
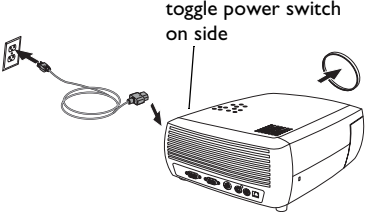
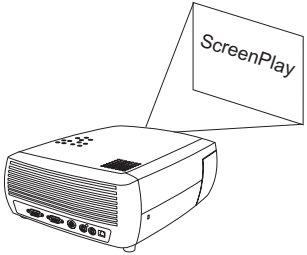
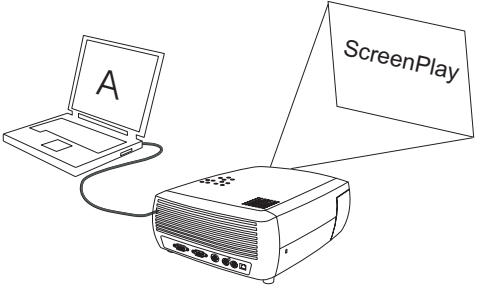
The following tables show common problems. In some cases, more than one possible solution is provided. Try the solutions in the order they are presented. When the problem is solved, you can skip the additional solutions.

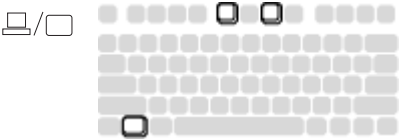
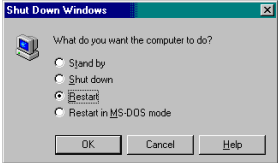
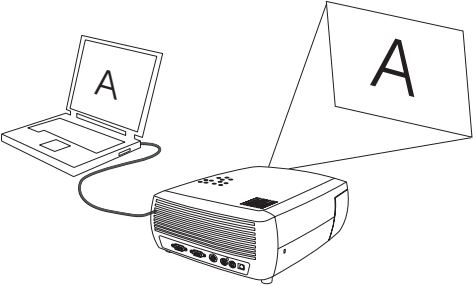
Problem	Solution	Result
<p data-bbox="53 169 260 192">no start up screen</p> 	<p data-bbox="664 161 1097 244">plug power cord in projector's left side remove lens cap toggle power switch</p> 	<p data-bbox="1187 169 1347 192">correct image</p> 
<p data-bbox="53 588 371 611">only start up screen appears</p> 	<p data-bbox="664 580 1008 640">press the Computer button  activate laptop's external port</p>  <p data-bbox="682 839 838 862">restart laptop</p> 	<p data-bbox="1187 588 1489 611">computer image projected</p> 

Problem

no computer image, just the words “Signal out of range”

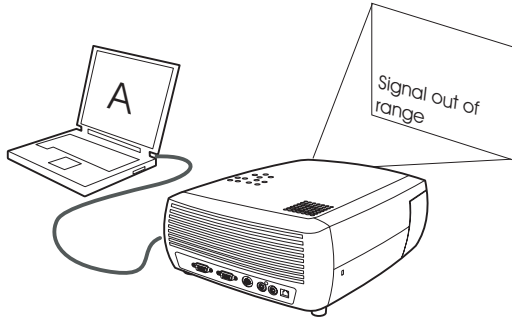

Solution

press the **Auto Image** button on keypad

auto image



adjust computer refresh rate in **Control Panel>Display>Settings>Advanced>Adapter**
(location varies by operating system)

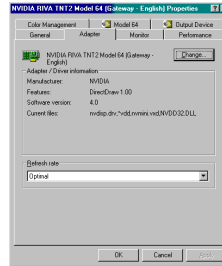







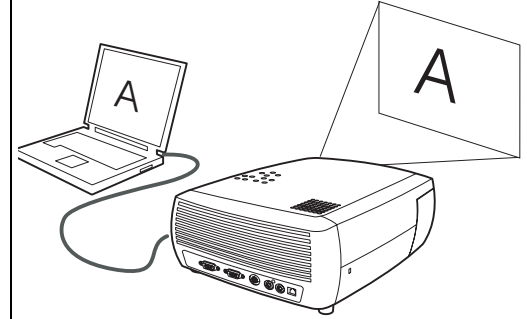

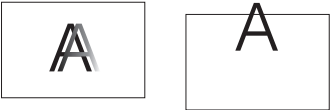
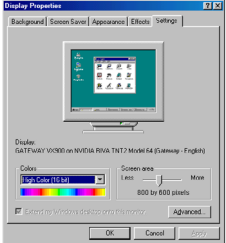

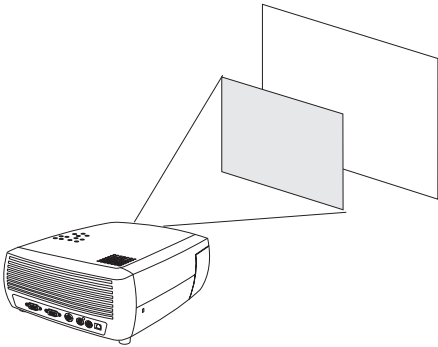
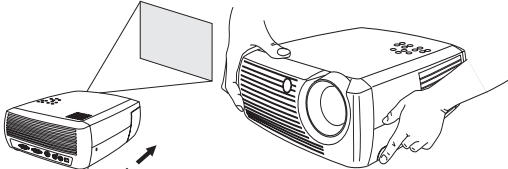
you may also need to set a different resolution on your computer, as shown in the following problem, “image fuzzy or cropped”

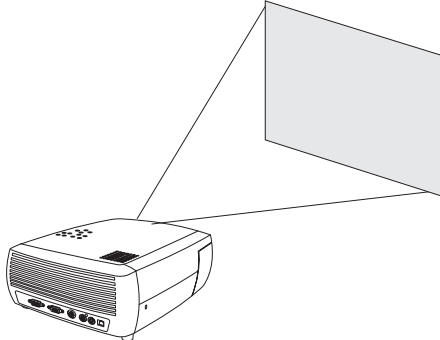



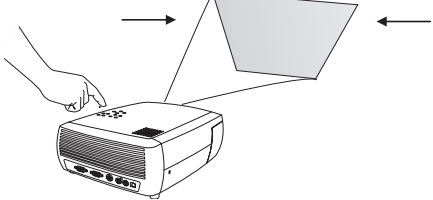

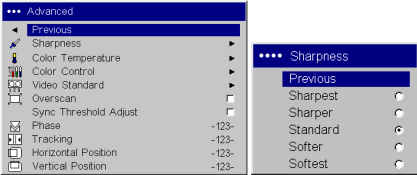
Result

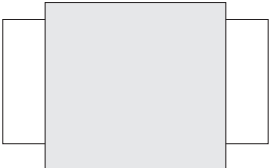
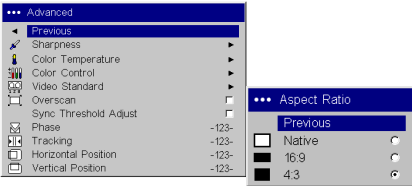
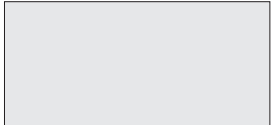
computer image projected

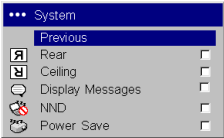

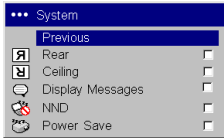
Problem	Solution	Result
<p data-bbox="48 115 319 142">image fuzzy or cropped</p> 	<p data-bbox="661 115 1124 253">set your computer's display resolution to the native resolution of the projector (Start>Settings>Control Panel>Display>Settings tab) select 800x600</p> <p data-bbox="666 345 852 479">For a laptop, disable laptop monitor or turn-on dual-display mode</p> 	<p data-bbox="1182 115 1512 142">image clear and not cropped</p> 
<p data-bbox="48 621 388 647">image not centered on screen</p> 	<p data-bbox="661 615 1147 641">move projector, adjust zoom, adjust height</p>  <p data-bbox="652 879 878 982">adjust horizontal or vertical position in Picture>Advanced menu</p> 	<p data-bbox="1182 624 1347 650">correct image</p> 

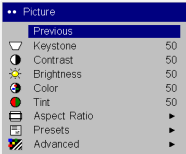
Problem	Solution	Result
<p>image not square</p> 	<p>adjust Keystone on keypad</p> 	<p>square image</p> 
<p>image not sharp</p> 	<p>adjust Sharpness (video sources only) in the Picture>Advanced menu</p> 	<p>correct image</p> 
<p>image does not fit 4:3 or 16:9 screen</p> 	<p>change aspect ratio to 4:3 or 16:9 in Picture>Aspect ratio menu</p> 	<p>correct image</p> 

Problem	Solution	Result
<p>image upside down</p> 	<p>turn off ceiling in Settings>System menu</p> 	<p>correct image</p> 
<p>image reversed left to right</p> 	<p>turn off rear in Settings>System menu</p> 	<p>correct image</p> 
<p>projected colors don't match source</p> 	<p>adjust color, tint, color temperature, brightness, contrast in the menus</p> 	<p>correct image</p> 

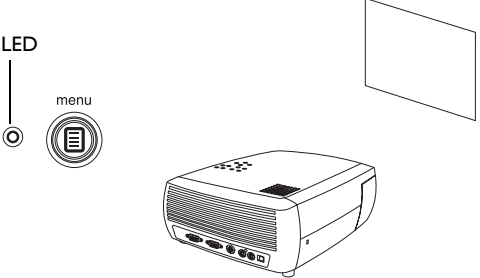
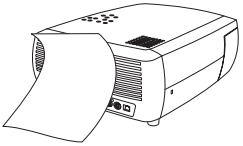
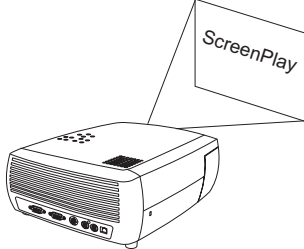
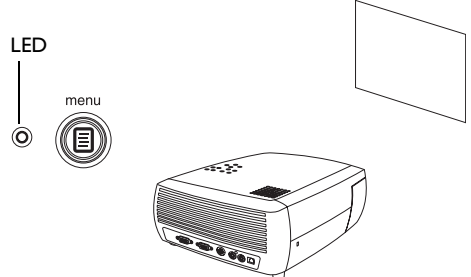
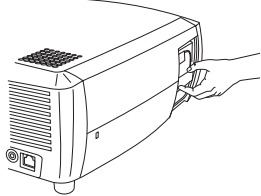
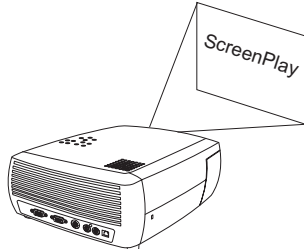
Problem	Solution	Result												
<p data-bbox="53 146 470 169">lamp won't turn on, LED blinking red</p> 	<p data-bbox="666 118 1156 169">make sure vents aren't blocked, turn off the projector and allow it to cool for a minute</p> 	<p data-bbox="1190 146 1347 169">lamp turns on</p> 												
<p data-bbox="53 505 630 556">"Change lamp" message appears at startup or lamp won't turn on and LED blinking red</p> 	<p data-bbox="666 505 1112 556">if lamp hours up to 4,000, lamp must be replaced (see page 37)</p> <p data-bbox="659 648 859 700">check lamp hours Main>About</p> <table border="1" data-bbox="920 625 1163 717"> <thead> <tr> <th colspan="2">About</th> </tr> </thead> <tbody> <tr> <td>Previous</td> <td></td> </tr> <tr> <td>Lamp Hours Used</td> <td>123</td> </tr> <tr> <td>Active Source</td> <td>Computer</td> </tr> <tr> <td>Signal Format</td> <td>1024x768 @ 72Hz</td> </tr> <tr> <td>Version</td> <td>2.1</td> </tr> </tbody> </table> <p data-bbox="928 792 1076 815">replace lamp</p> 	About		Previous		Lamp Hours Used	123	Active Source	Computer	Signal Format	1024x768 @ 72Hz	Version	2.1	<p data-bbox="1190 505 1347 528">lamp turns on</p> 
About														
Previous														
Lamp Hours Used	123													
Active Source	Computer													
Signal Format	1024x768 @ 72Hz													
Version	2.1													

Still need assistance?

If you need assistance, call InFocus Customer Service directly at **1-800-799-9911**. Support is free between 6 a.m. and 6 p.m. PST, Monday through Friday. Support is available in North America after hours and weekends for a fee at 1-888-592-6800.

Or, send us an e-mail at **techsupport@infocus.com**.

In Europe, call InFocus in The Netherlands at **+31 (0)20 579 2820**.

In Asia, call InFocus in Singapore at **(65) 6334-9005**.

This product is backed by a limited two-year warranty (page 45). An extended warranty plan may be purchased from your dealer. When sending your projector in for repair, we recommend shipping the unit in its original packing material, or having a professional packaging company pack the unit for shipping. Please insure your shipment for its full value.

Regarding this projector

When sending your projector in for repair, we recommend shipping the unit in its original packing material, or having a professional packaging company pack the unit for shipping. Please insure your shipment for its full value.

Using the remote control

The remote uses two (2) provided AAA batteries. They are easily installed by sliding the cover off the remote's back, aligning the + and - ends of the batteries, sliding them into place, and then replacing the cover.

To operate, point the remote at the projection screen or at the projector (not at the video device or computer). The range of optimum operation is 0 to 30 feet (9.14m).

Press the remote's **Menu** button to open the projector's menu system. Use the arrow buttons to navigate, and the **Select** button to select features and adjust values in the menus. See page 31 for more info on the menus.

The remote also has:

- **Power** button to turn the projector on and off (see page 19 for shut-down info)
- backlight button to light the remote's buttons in the dark
- **Brightness** and **Contrast** buttons to adjust the image
- **Blank** button to display a blank screen instead of the current image (to change the color of the screen, see page 36)
- **Source** buttons to switch among sources (to assign a particular source to a source button, see page 35) and a source toggle
- **Resize** button to change the Aspect Ratio (see page 32)
- **Auto Image** button to resynch the projector to the source
- **Preset** button to restore stored settings (see page 33)
- **Overscan** button to remove noise in a video image (page 34)

Troubleshooting the remote

- Make sure the batteries are installed in the proper orientation and are not dead.
- Make sure you're pointing the remote at the projector or the screen, not at the video device or the computer, and are within the remote range of 30 feet (9.14m).

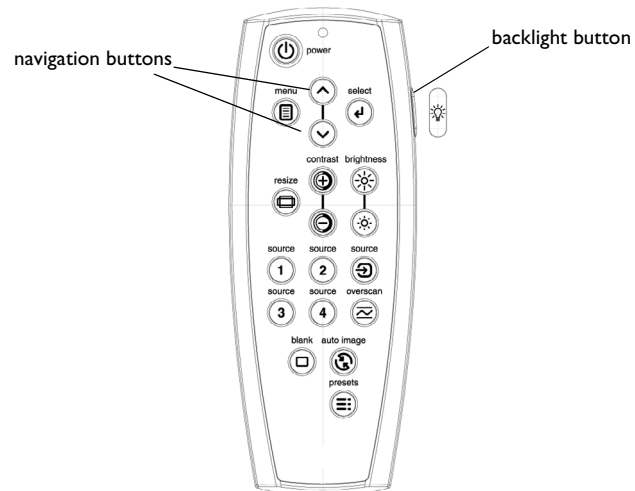

Using the audio

To use the projector's speaker, connect your source to the **Audio In** connector on the projector.

To adjust the volume, press the **Volume** buttons on the keypad.

Troubleshooting Audio

If you aren't hearing the audio, check the following:

- Make sure the optional audio cable is connected. Visit www.infocus.com/accessories to view optional cables.
- Make sure the volume is turned up enough. Press the **Volume** button on the keypad.
- Make sure the correct source is active.
- Adjust the audio source.
- If playing a video, make sure the playback has not been paused.

connect optional audio cable

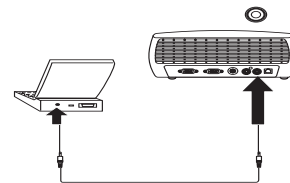

adjust volume

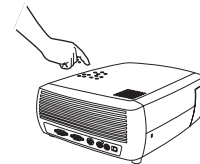

Using the keypad buttons

Most buttons are described in detail in other sections, but here is an overview of their functions:

Menu—opens the on-screen menus (page 31).

Select—confirms choices made in the menus (page 31).

Up/Down arrows—navigates to and adjusts settings in the menus (page 31).

Auto Image—synchs the projector to the source.

Presets—cycles through the available preset settings (page 33).

Keystone—adjusts squareness of the image (page 8).

Volume—adjusts sound (page 28).

Video and **Computer**—changes the active source.

menu navigation buttons

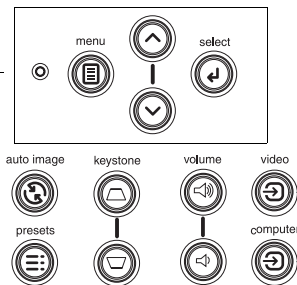

Optimizing computer images

After your computer is connected properly and the computer's image is on the screen, you can optimize the image using the onscreen menus. For general information on using the menus, see page 31.

- Adjust the Keystone, Contrast, or Brightness in the Picture menu (page 32).
- Change the Aspect Ratio. Choose the option that best fits your input source (page 32).
- Adjust the Color Temperature in the Advanced menu (page 34).
- Adjust the phase, Tracking, or Horizontal or Vertical position in the Advanced menu (page 34).
- Once you have optimized the image for a particular source, you can save the settings using Presets. This allows you to quickly recall these settings later (page 33).

Presentation features

Several features are provided to make giving presentations easier. Here is an overview, details are found in the menu section.

- The Blank button on the remote allows you to display a blank screen instead of the active source. You can determine the color of this screen (page 36).
- The Startup Logo option lets you change the default start up screen to a blank or default screen (page 36).
- Power Save is provided to automatically shut down the projector after several minutes of inactivity. This helps preserve lamp life (page 35).

Optimizing video images

After your video device is connected properly and the image is on the screen, you can optimize the image using the onscreen menus. For general information on using the menus, see page 31.

- Adjust the Keystone, Contrast, Brightness, Color, or Tint in the Picture menu (page 32).
- Change the Aspect Ratio. Choose the option that best fits your input source (page 32).
- Select a Sharpness setting (page 34).
- Use the Color Control to adjust the color gain (page 34).
- Adjust the Color Temperature. Select a listed warmth value (page 34).
- Turn on Overscan to remove noise on the edges of the image.

Customizing the projector

You can customize the projector for your specific setup and needs. See page 35 to page 37 for details on these features.

- For rear projection, turn rear mode on in the **Settings>System** menu.
- For ceiling mounted projection, turn ceiling mode on in the **Settings>System** menu.
- Specify which source the projector checks first for active video during power-up.
- Turn the projector's display messages on and off.
- Turn on power saving features.
- Specify blank screen colors and start up logos.
- Specify the language viewed on the menus.
- Save settings for the active source as a preset.

Using the menus

To open the menus, press the **Menu** button on the keypad or remote. (The menus automatically close after 60 seconds if no buttons are pressed.) The Main menu appears. Use the arrow buttons to move up and down to highlight the desired submenu, then press the **Select** button.

To change a menu setting, highlight it, press **Select**, then use the up and down arrow buttons to adjust the value, select an option using radio buttons, or turn the feature on or off using check boxes. Press **Select** to confirm your changes. Use the arrows to navigate to another setting. When your adjustments are complete, navigate to and press **Previous** to go to the preceding menu; press the **Menu** button at any time to close the menus.

Dots appear before the menu name. The number of dots indicate menu's level, ranging from one (the Main menu) to four (the most nested menus).

The menus are grouped by usage:

- The Picture menu provides image adjustments.
- The Settings menu provides set-up type adjustments that are not changed often.
- The About menu provides a read-only display of information about the projector and source.

Certain menu items may not be visible or may be grayed depending upon a particular source being connected. For example, Sharpness is only available for video sources and is not visible when a computer source is active. Menu options are grayed out only if the source is selected but no signal is present. For example, if the projector is set to a video source but the source, such as a DVD player, is turned off video menu options are grayed out.

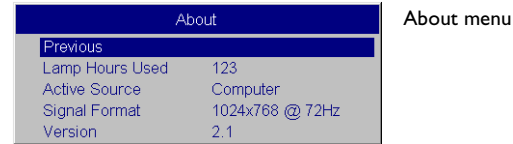
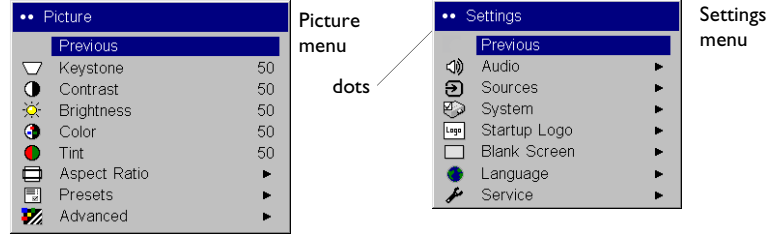
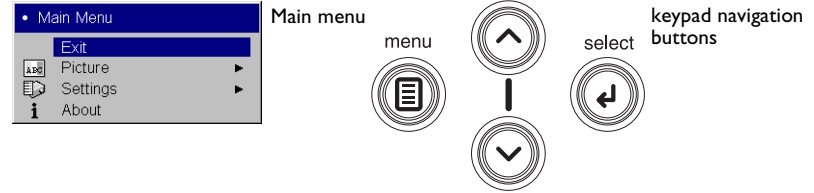

Picture menu

To adjust the following settings, highlight the setting, press **Select**, use the up and down arrows to adjust the values, then press **Select** to confirm the changes.

Keystone: adjusts the image vertically and makes a squarer image. You can also adjust keystone from the keypad.

Contrast: controls the degree of difference between the lightest and darkest parts of the picture and changes the amount of black and white in the image.

Brightness: changes the intensity of the image.

Color: adjusts a video image from black and white to fully saturated color. The color setting applies to video sources only.

Tint: adjusts the red-green color balance in the image of NTSC video images. The tint setting applies to NTSC video sources only.

Aspect Ratio: Aspect ratio is the ratio of the image width to image height. TV screens are usually 4:3. HDTV and most DVDs are 16:9. The default is 16:9.

Select Native to see the unmodified input with no resizing by the projector. Select 16:9 to watch enhanced widescreen DVDs.

For more information regarding Aspect Ratio, see page 11.

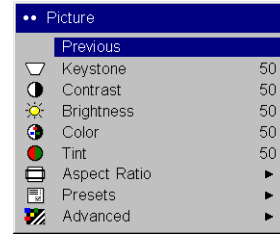

Picture menu

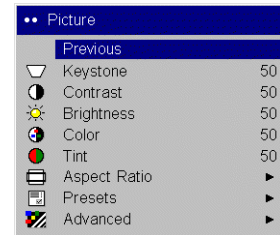
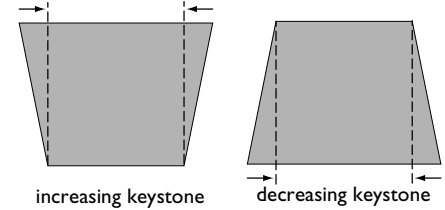

Aspect ratio

Presets: Presets present you with intensity configurations optimized for the input source. You can select a preset configuration that has been specifically tuned for either Presentation, Photography, Film, and Video (Film input is material originally captured on a film camera, like a movie; video input is material originally captured on a video camera, like a TV show or sporting event.) Your viewing preferences may vary. Cycle through the preset intensity configurations and pick the one you like the best.

Presets are user-definable. You can use the preset as a starting point, then further customize the settings for each source. The settings you customize are saved in the preset for each source. To restore the factory default settings, choose Factory Reset in the **Settings>Service** menu (page 36).

To set a preset for the current source, adjust the image, select Save User in the Presets menu, then select Yes. You can recall these settings in the future by selecting the User 1 preset.

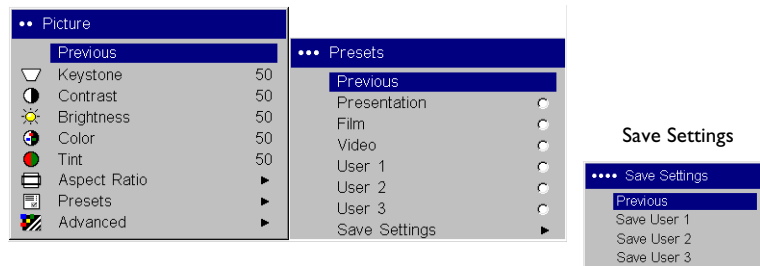

Presets

Advanced menu

Sharpness: (video sources only) changes the clarity of the edges of a video image. Select a sharpness setting.

Color Temperature: changes the intensity of the colors. Select a listed relative warmth value.

Color Control: allows you to individually adjust the gain for the red, green, and blue colors.

Video Standard: when it is set to Auto, the projector attempts to automatically pick the video standard based on the input signal it receives. (The video standard options may vary depending on your region of the world.) If the projector is unable to detect the correct standard, the colors may not look right or the image may appear “torn.” If this happens, manually select a video standard by selecting NTSC, PAL, or SECAM from the Video Standard menu.

Overscan: (video sources only) removes noise around the video image.

Sync Threshold Adjust: If a hardware device, such as a DVD player, is not syncing properly with the projector, select this option to help it to sync when connected to the projector.

The following four (4) options are for computer sources only.

Phase: adjusts the horizontal phase of a computer source.

Tracking: adjusts the vertical scan of a computer source.

Horizontal/Vertical Position: adjusts the position of a computer source.

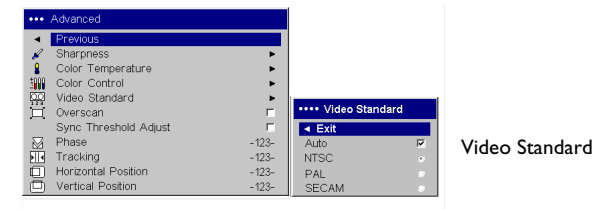
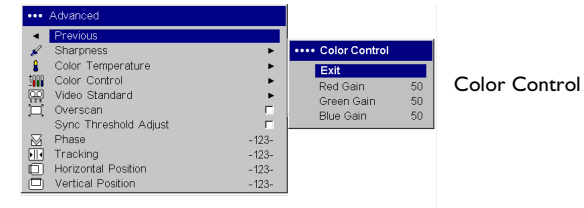
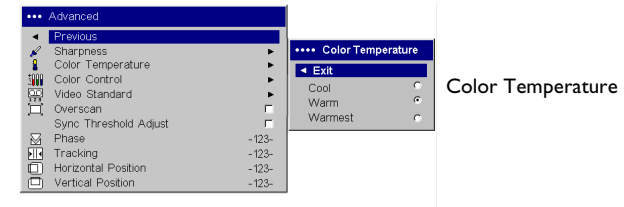
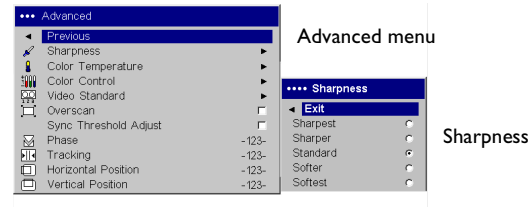

Settings menu

Audio: allows adjustments to Volume of the internal speaker. Adjustments can also be made from the projector's keypad.

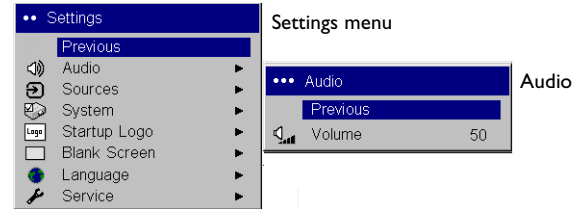

Sources: when the Auto Source feature is on, the **Source Enable** feature indicates which sources the projector attempts to lock onto. You can use the Source Enable feature to eliminate certain sources from this search, which will speed the search. By default, the check boxes for all sources are checked. Uncheck a source's box to eliminate it from the search.

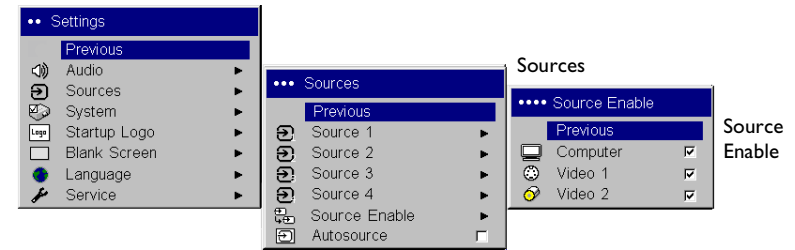

System: **Rear** reverses the image so you can project from behind a translucent screen. **Ceiling** turns the image upside down for ceiling-mounted projection. **Display Messages** displays status messages (such as "Searching" or "Mute") in the lower-left corner of the screen. **NND** prevents your notebook computer from going into Screen Save mode if the USB cable is connected. **Power Save** automatically turns the lamp off after no signals are detected for 20 minutes. After an additional 10 minutes with no signal, the projector powers down and can be toggled off. If an active signal is received before the projector powers down, the image will be displayed.

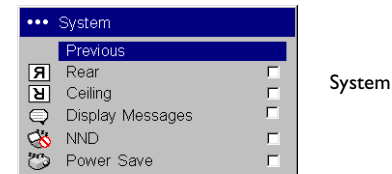

Startup Logo: allows you to display a blank screen instead of the default screen at startup, and when no source is detected.

Blank Screen: determines what color is displayed when you press the Blank button on the remote.

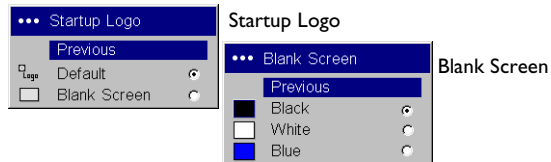

Language: allows you to select a language for the onscreen display.

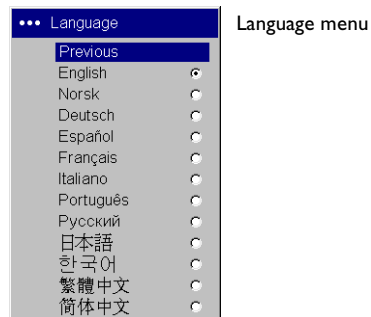

Service: To use these features, highlight them and press **Select**.

Factory Reset: restores all settings to their default.

Service Code: only used by authorized service personnel.

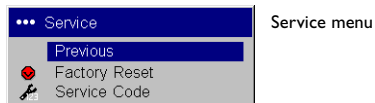

About: provides information about the projector and the active source. Showing the About box is the default action assigned to the Effect button.

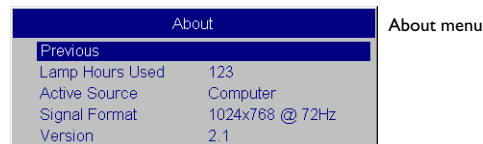

Maintenance

Cleaning the Lens

- 1 Apply a non-abrasive camera lens cleaner to a soft, dry cloth.
 - Avoid using an excessive amount of cleaner, and don't apply the cleaner directly to the lens. Abrasive cleaners, solvents or other harsh chemicals might scratch the lens.
- 2 Lightly wipe the cleaning cloth over the lens in a circular motion. If you don't intend to use the projector immediately, replace the lens cap.

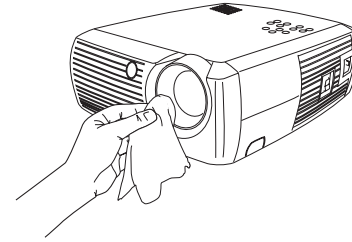

Replacing the Projection Lamp

The lamp hours used timer in the About menu counts the number of hours the lamp has been in use. After approximately 3,980 hours, the message “Change lamp” appears on the screen at startup. If the maximum lamp time of up to 4,000 hours is exceeded, the lamp will not light. In this case, after replacing the lamp you must reset the lamp hours by simultaneously pressing both **Volume** buttons on the projector's keypad and holding them for 10 seconds.

NOTE: You can order new lamp housings from your dealer. See “Accessories” on page 40 for information. Use only a replacement lamp with the same type and rating as the original lamp.

- 1 Turn off the projector and unplug the power cord.
- 2 Wait 30 minutes to allow the projector to cool thoroughly.
- 3 Turn the projector on its side so that the lamp door is facing you. Using a flat-blade screwdriver, gently pry the lamp door from the projector by placing the screwdriver blade into the space between the top of the lamp door and the projector.

About	
Previous	
Lamp Hours Used	123
Active Source	Computer
Signal Format	1024x768 @ 72Hz
Version	2.1

Lamp hours used

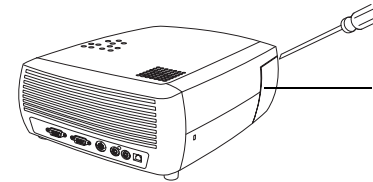
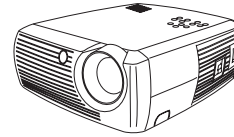

- Loosen the two captive screws that attach the lamp housing to the projector.
- Detach the lamp connector from the projector by depressing the locking tab on the connector and lightly pulling it free.

WARNING:

To avoid burns, allow the projector to cool for at least 30 minutes before you replace the lamp.

Do not drop the lamp housing or touch the glass bulb! The glass may shatter and cause injury.

Be extremely careful when removing the lamp housing. In the unlikely event that the bulb ruptures, small glass fragments may be generated. The lamp housing is designed to contain these fragments, but use caution when removing the lamp housing.

- Carefully remove the lamp housing. Dispose of the lamp in an environmentally proper manner.
- Install the new lamp housing and tighten the screws.
- Re-attach the lamp connector to the projector. The locking tab should engage when the connector is fully plugged in.
- Replace the lamp door.
- Plug in the power cord and toggle the **Power** switch to turn the projector back on.

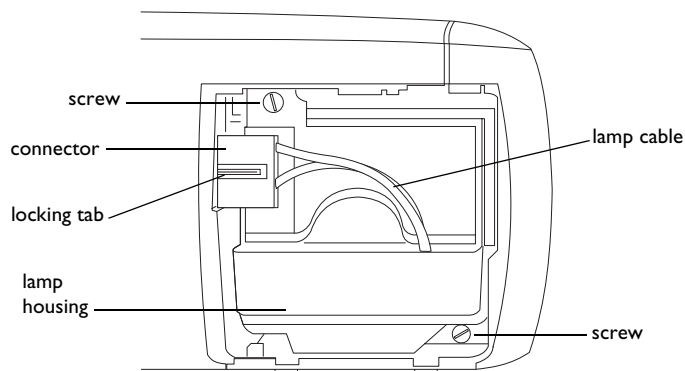
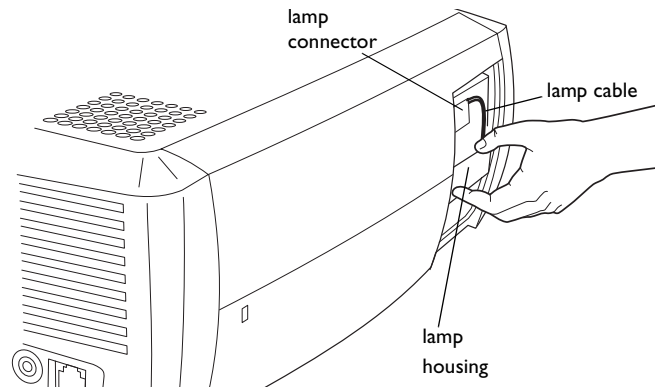

Cleaning the Lamp Housing Screens

In dirty or dusty environments, the two dust filter screens in the lamp housing can become clogged, causing high temperatures and premature lamp failure. Routine maintenance to remove dust from the screens lowers the lamp operating temperature and prolongs lamp life. To maximize lamp life you should clean the screen every 250 hours.

- 1 Remove the lamp housing.
- 2 Examine the dust filter screens on the lamp housing. If necessary, use a vacuum cleaner set on low power to clean the screens. Be careful not to disturb any internal components when cleaning the screens.
- 3 Replace the lamp housing and lamp door.

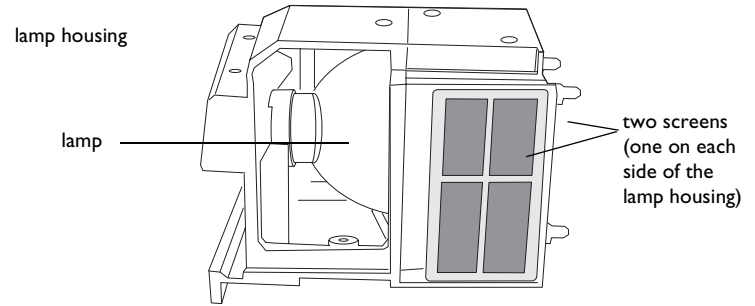

Using the security lock

The projector has a security lock for use with a PC Guardian Cable Lock System. If you have a PC Guardian Cable Lock System, refer to the information that came with the lock for instructions on how to use it.

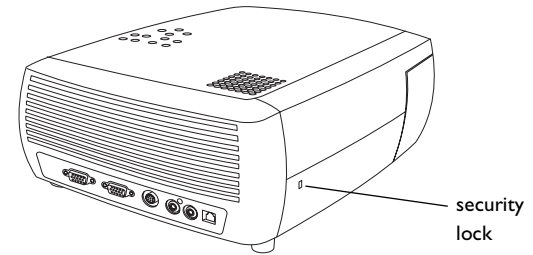

Appendix

Specifications

Temperature	50 to 104° F (10 to 40° C) at sea level
Operating	50 to 95° F (10 to 35° C) at 10,000 feet
Non-operating	-4 to 140° F (-20 to 60° C)
Altitude	0 to 10,000 feet (3,048 meters)
Operating	0 to 10,000 feet (3,048 meters)
Non-operating	0 to 20,000 feet (6,096 meters)
Humidity	10% to 95% relative humidity, non-condensing
Operating	10% to 95% relative humidity, non-condensing
Non-operating	10% to 90% relative humidity, non-condensing
Dimensions	12.5 x 9.8 x 4.49" (318 x 249 x 114 mm)
Weight	6.8 lbs. (3.1 kg) unpacked
Optics	4.9 - 32.8 feet (1.5 - 10 m)
Focus Range	
Lamp type	150 - W DC SHP lamp
Input Power Requirements	100-120/200-240 3/2A 50/60Hz

Accessories

Standard Accessories (ship with the projector)	Part Number
---	-------------

Shipping Box (with packaging)	110-0731-xx
Soft Carrying Case	110-0580-xx
Computer Cable 6 ft (1.8 m)	210-0175-01
S-video to Component Adapter	210-0206-xx
VGA to Component Adapter	210-0261-xx
AV Cable	301379B
S-video Cable	210-0125-10
Power Cable (country-dependent)	210-0023-xx
Remote and Batteries	590-0567-xx
Projection Lamp Housing (included in projector)	SP-LAMP-009
Lens Cap	505-1523-xx
Quick Setup Card	009-0821-xx
User's Guide	010-0474-xx
Safety Card	009-0659-xx

NOTE: Use only approved accessories.

Projected image size

Table 2:

Range of distance to the screen for a given screen size for the projector

Diagonal Screen Size (inches/m)	Image Width (inches/m)	Distance to screen	
		Maximum distance (feet/m)	Minimum Distance (feet/m)
40/1	32/0.8	5.8/1.8	4.8/1.5
50/1.3	40/1	7.8/2.4	6.5/2.0
60/1.5	48/1.2	8.8/2.7	7.5/2.3
100/2.5	80/2	14.6/4.5	12.4/3.8
150/3.8	120/3.1	22.6/6.9	19.03/5.8
200/5.1	160/4.1	30.5/9.3	25.2/7.7

Red LED Behavior and Projector Errors

If the projector is not functioning properly and the LED is blinking red, consult **Table 3** to determine a possible cause. There are two-second pauses between the blinking cycles.

Table 3:

Red LED Behavior	Explanation
One (1) blink	The lamp won't strike after five (5) attempts. Check the lamp and lamp door installations for loose connections.
Two (2) blinks	The lamp counter hours have exceeded lamp life hours. Replace the lamp and reset the lamp hours counter.
Three (3) blinks	The projector has shut down. Check to see if the lamp door is open. If the lamp door is closed, toggle off the projector and wait one minute, then toggle the projector on again. If the lamp does not strike after one minute, replace the lamp.
Four (4) blinks	The fan has failed.
Five (5) blinks	The projector is overheating. Check for a blocked air vent.

Numerics

16x9 vs 4x3 screen aspect 11

800x600 resolution 4

A

About 36

Accessories

 standard 40

accessories, ordering 40

Advance menu 34

altitude limits 40

Aspect ratio 32

aspect ratio 11

Audio 35

Audio In connector 6, 15, 28

B

Blank button 29

Blank Screen 36

blinking green 19

blinking red 19

Brightness 32

C

cable box 11

cables

 ordering 40

Ceiling 35

Color 32

Color Control 34

Color Space 34

Color Temperature 34

compatibility

 IBM-compatible 4

 Macintosh 4

 video devices 4

component cable connector 16

Computer In connector 6

connecting

 video device 11

connectors on projector 13, 14

Contrast 32

Customer Service 26

customizing the projector 30

D

Display Messages 35

Drivers

 USB 10

 Windows 98 10

DVDs 32

E

e-mail

 technical support 26

F

Factory Reset 36

focus 8, 18

H

HDTV 4, 12, 32

Horizontal 34

I

IBM-compatible computers 4

image

 size 5

image optimization 29

image size

 projected 41

K

keypad buttons

 projector 28

keystone adjustment 8, 18

L

lamp

 ordering 40

Lamp Housing Screens

 cleaning 39

lamp replacement 37

Language 36

LED 19

 blinking green 19

 solid green 19

LED Behavior

 red 41

LED behavior 19

lens

 cap 40

leveling foot 17

M

Macintosh computers

 compatibility 4

maintaining the projector 37

Menu button 31

menu usage 31

Monitor Out connector 6

mouse, using your 6

N

NND 35

O

optimizing images 29

optimizing video 30

Overscan 34

P

Phase 34

phone numbers

 technical support 26

Picture menu 32

Power connector 6

power cord 6, 16

Power Save 19

Power switch 7

presentation

 features 29

Presets 33

projection distance 5

projector

 connecting video devices 11

 customization 30

 keypad buttons 28

 maintenance 37

 positioning 5

 returning for service 26

 setting up 5

 troubleshooting problems 19

 turning off 19

 warranty 26

R

Rear 35

Red LED behavior 41

replacing the lamp 37

S

Screen Aspect 11

security lock 39

Service 36

Service Code 36

Settings menu 35

sharpness 34

solid green 19

solid red 19

Specifications 40

Startup Logo 36

S-video connector 15

System 35

T

technical support

 e-mail 26

 phone numbers 26

temperature limits 40

Tint 32

Tracking 34
troubleshooting 19
turning off
 projector 19

TV tuner 11

U

USB 6

USB, using your mouse 6

V

vents 3

Vertical 34

Video In connector 15

video optimizing 30

Video Standard 34

volume adjustment 18

Volume button 28

W

Windows 2000 10

Windows 98 9

Windows ME 10

Windows XP 10

Z

zoom 8, 18

Limited Warranty

Subject to the Limitations, Exclusions and Disclaimers hereof, InFocus Corporation (“InFocus”) warrants that the Projector, Lamps and Accessories (hereinafter collectively or individually referred to as “Product” as appropriate) purchased from InFocus, an InFocus distributor, or an InFocus reseller will conform to InFocus’ specifications and be free from defects in material or workmanship for the respective Limited Warranty period provided below. InFocus does not warrant that the Product will meet the specific requirements of the end-user customer.

If the Product while subject to this Limited Warranty, is defective in material or workmanship during the warranty period, then InFocus, at its option, will REPAIR or REPLACE the Product.

All exchanged parts and Products replaced under this Limited Warranty will become property of InFocus. InFocus’ sole obligation is to supply (or pay for) all labor necessary to repair the Product found to be defective within the Limited Warranty period and to repair or replace defective parts with new parts or, at the option of InFocus, serviceable used parts that are equivalent or superior to new parts performance. Limited Warranty periods are as follows:

- **Projector Product Limited Warranty Period (Excluding Lamps):** **Two (2) years** from date of purchase.
- **Lamp Product Limited Warranty Periods:** From the date of Projector Product purchase, the original installed lamp shall have a **90-day or 500 hours** usage Limited Warranty Period, whichever comes first, and replacement Lamps purchased at the time of Projector Product purchase will have a **500 hours** usage Limited Warranty period.
- **Accessory Product Limited Warranty Period:** one (1) year from date of purchase.

WARRANTY LIMITATION AND EXCLUSION

THIS WARRANTY SETS FORTH INFOCUS’ MAXIMUM LIABILITY FOR ITS PRODUCT. THIS WARRANTY EXTENDS ONLY TO PRODUCTS PURCHASED FROM INFOCUS OR AN INFOCUS AUTHORIZED RESELLER. InFocus shall have no further obligation under the foregoing Limited War-

ranty if the Product has been damaged due to abuse, misuse, neglect, smoke exposure (cigarette or otherwise), accident, unusual physical or electrical stress, unauthorized modifications (including use of an unauthorized mount), tampering, alterations, or service other than by InFocus or its authorized agents, causes other than from ordinary use or failure to properly use the Product in the application for which said Product was intended.

This Limited Warranty excludes Product cleaning, repair, or replacement of plastics due to cosmetic damage and damage as a result of normal wear. Product repair outside of the terms of the Limited Warranty will be on a time and materials basis. Prolonged Product “demonstration” causes unusual Product wear and is not considered normal use under the terms of this Limited Warranty.

The Accessory Product Limited Warranty covers the accessory item only and excludes normal wear. The Lamp Product Limited Warranty excludes expected lamp degradation.

Remanufactured Products and Software Products are exempt from the foregoing Limited Warranty. Please refer to the appropriate Remanufactured Product Limited Warranty or Software Product Limited Warranty for applicable Warranty information.

DISCLAIMER OF UNSTATED WARRANTIES

THE WARRANTY PRINTED ABOVE IS THE ONLY WARRANTY APPLICABLE TO THIS PRODUCT. ALL OTHER WARRANTIES, EXPRESS OR IMPLIED, INCLUDING, BUT NOT LIMITED TO, THE IMPLIED WARRANTIES OF MERCHANTABILITY AND FITNESS FOR PARTICULAR PURPOSE ARE DISCLAIMED. THERE ARE NO WARRANTIES THAT EXTEND BEYOND THE DESCRIPTION ON THE FACE HEREOF AND THE FOREGOING WARRANTY SHALL NOT BE EXTENDED, ALTERED OR VARIED EXCEPT BY WRITTEN INSTRUMENT SIGNED BY INFOCUS. SOME JURISDICTIONS DO NOT ALLOW LIMITATIONS ON HOW LONG AN IMPLIED WARRANTY MAY LAST, SO SUCH LIMITATIONS MAY NOT APPLY TO YOU.

Limited Warranty Period

The Limited Warranty periods hereof commence on the date of purchase by the end-user customer. These Limited Warranty provisions shall apply only to the end-user purchaser (first person or entity that purchased a new Product for personal or business use and not for the purpose of distribution or resale). SOME JURISDICTIONS MAY GRANT YOU CONSUMER RIGHTS WITH MINIMUM WARRANTY DURATION THAT DIFFER FROM THE DURATIONS PROVIDED HEREIN, AND INFOCUS WILL HONOR ALL SUCH CONSUMER RIGHTS.

To Be Eligible For Limited Warranty Coverage

Any person exercising a claim under this Limited Warranty must establish to the satisfaction of InFocus both the date of purchase and that the Product was purchased new. The sales receipt or invoice, showing the date of purchase of the Product is the proof of the date of purchase.

To Obtain Warranty Service

During the Limited Warranty period, to exercise this Limited Warranty, the purchaser must first contact 1) InFocus, 2) a service facility authorized by InFocus or 3) the place of original purchase.

InFocus Customer Service – 1-800-799-9911 or techsupport@infocus.com

For Warranty service, the purchaser will be advised to return or deliver the defective Product freight and all fees prepaid, to an InFocus Service Center or to a service facility authorized by InFocus. When returning Product to InFocus, a Return Material Authorization Number (RMA); is required and must be clearly displayed on the outside of the shipping carton or a similar package affording an equal degree of protection. InFocus or the service facility authorized by InFocus will return the repaired/replaced Product freight prepaid to the purchaser.

Products returned for Warranty service must be accompanied by a written letter that: (i) explains the problem; (ii) provides proof of date of purchase; (II) provides the dealer's name; and (I) provides the model and serial number of the Product.

Upon request of InFocus Corporation or an authorized repair center for InFocus, proof of legal import must accompany the warranty repair Product, otherwise the Product must be returned to the place of original purchase, to the manufacturer (Purchaser must bear all tax, duty and freight), or the Purchaser must bear charges for the warranty repair.

No repair or replacement of Product or part thereof shall extend the Limited Warranty period as to the entire Product. Warranty on the repair part and workmanship shall only be effective for a period of ninety (90) days following the repair or replacement of that part or the remaining period of the Product Limited Warranty whichever is greater.

LIMITATION OF LIABILITY

IT IS UNDERSTOOD AND AGREED THAT INFOCUS' LIABILITY WHETHER IN CONTRACT, IN TORT, UNDER ANY WARRANTY, IN NEGLIGENCE OR OTHERWISE SHALL NOT EXCEED THE RETURN OF THE AMOUNT OF THE PURCHASE PRICE PAID BY PURCHASER AND UNDER NO CIRCUMSTANCES SHALL INFOCUS BE LIABLE FOR SPECIAL, INDIRECT, INCIDENTAL OR CONSEQUENTIAL DAMAGES OR LOST PROFITS, LOST REVENUES OR LOST SAVINGS. THE PRICE STATED FOR THE PRODUCTS IS A CONSIDERATION IN LIMITING INFOCUS' LIABILITY.

Limitation on Bringing Action - No action, regardless of form, arising out of the agreement to purchase the Product may be brought by purchaser more than one year after the cause of action has accrued.

Governing Law - Any action, regardless of form, arising out of the agreement to purchase the Product is governed by Oregon law.

Mandatory Arbitration – Any action, regardless of form, arising out of the agreement to purchase the Product is subject to mandatory arbitration.

SOME JURISDICTIONS DO NOT ALLOW THE EXCLUSION OR LIMITATION OF INCIDENTAL OR CONSEQUENTIAL DAMAGES SO THE ABOVE LIMITATION OR EXCLUSION MAY NOT APPLY TO YOU. THIS LIMITED WARRANTY GIVES YOU SPECIFIC LEGAL RIGHTS, AND YOU MAY ALSO HAVE OTHER RIGHTS, DEPENDING ON JURISDICTION.



ScreenPlay™ 4800



010-0474-01

InFocus®
CORPORATION

InFocus Corporation

In the Americas:

27700B SW Parkway Avenue
Wilsonville, Oregon 97070-9215
1-800-294-6400 • 503-685-8888
Fax: 503-685-8887
<http://www.infocus.com>

In Europe:

InFocus International B.V.
Strawinskylaan 585
1077 XX Amsterdam
The Netherlands
Phone: (31) 20 5792000
Fax: (31) 20 5792999

In Asia:

238A Thomson Road
#18-01/04 Novena Square
Singapore 307684
Telephone: (65) 6334-9005
Fax: (65) 6333-4525

