

myprojectorlamps.com

**The most trusted, dependable name
in projector lamp sales.**



<http://www.myprojectorlamps.com>



<http://www.myprojectorlamps.ca>



<http://www.myprojectorlamps.eu>

The following projector manual has not been modified or altered in any way.

LP®840/LP®850/LP®860 INSTALLATION & INTEGRATION PROJECTOR.

USER'S GUIDE



InFocus®



WARNING: The power cord and cables associated with this product contain lead, a chemical known to the state of California to cause birth defects or other reproductive harm. ***Wash hands after handling.***

WARNING: This product has a lamp which contains a very small amount of mercury. Dispose of it as required by local, state, or federal ordinances and regulations. For more information, see www.eiae.org

This entire user's guide is available on the enclosed CD as an Adobe Acrobat pdf file in the following languages: Dutch, English, French, German, Italian, Norwegian, Portuguese, Spanish, Russian, Japanese, Korean, Traditional Chinese, Simplified Chinese. Before using this projector, please read these instructions.

Deze handleiding is in zijn geheel beschikbaar op de bijgevoegde cd in de vorm van een pdf-bestand (Adobe Acrobat), en wel in de volgende talen: Engels, Frans, Duits, Italiaans, Noors, Portugees, Spaans, Nederlands, Russisch, Japans, Koreaans, traditioneel Chinees, vereenvoudigd Chinees. Lees onderstaande instructies voordat u deze projector gebruikt.

Le mode d'emploi complet est disponible sur le CD joint sous forme de fichier pdf d'Adobe Acrobat dans les langues suivantes : hollandais, anglais, français, allemand, italien, norvégien, portugais, espagnol, russe, japonais, coréen, chinois traditionnel, chinois simplifié. Avant d'utiliser ce projecteur, veuillez lire ces instructions.

Die vollständige Benutzeranleitung ist auf der im Lieferumfang enthaltenen CD als Adobe Acrobat PDF-Datei in den folgenden Sprachen verfügbar: Niederländisch, Englisch, Französisch, Deutsch, Italienisch, Norwegisch, Portugiesisch, Spanisch, Russisch, Japanisch, Koreanisch, Traditionelles Chinesisch und Vereinfachtes Chinesisch. Bitte lesen Sie diese Anweisungen vor der Verwendung des Projektors.

La presente guida è disponibile sul CD allegato, come file Adobe Acrobat pdf, nelle seguenti lingue: olandese, inglese, francese, tedesco, italiano, norvegese, portoghese, spagnolo, russo, giapponese, coreano, cinese tradizionale e cinese semplificato. Prima di usare questo proiettore, leggere le seguenti istruzioni.

Hele denne brukerhåndboken finnes på den vedlagte CD-en som en Adobe Acrobat pdf-fil på følgende språk: Nederlandsk, engelsk, fransk, tysk, italiensk, norsk, portugisisk, spansk, russisk, japansk, koreansk, tradisjonell og forenklet kinesisk. Les disse anvisningene før projektoren tas i bruk.

Este guia do usuário completo está disponível no CD anexo, como um arquivo pdf do Adobe Acrobat nos seguintes idiomas: holandês, inglês, francês, alemão, italiano, norueguês, português, espanhol, russo, japonês, coreano, chinês tradicional, chinês simplificado. Antes de utilizar este projetor, leia estas instruções.

Este manual de uso está disponible en su totalidad en el CD incluido, como archivo pdf de Adobe Acrobat, en los siguientes idiomas: holandés, inglés, francés, alemán, italiano, noruego, portugués, español, ruso, japonés, coreano, chino tradicional, chino simplificado. Antes de usar el proyector, lea estas instrucciones.

Данное руководство пользователя в полном объеме представлено на прилагаемом компакт-диске в виде pdf-файла Adobe Acrobat на следующих языках: английском, голландском, французском, немецком, итальянском, норвежском, португальском, испанском, русском, японском, корейском, традиционном и упрощенном китайском. Перед использованием проектора, прочитайте данные инструкции.

このユーザーズガイドは、プロジェクトに付属しているCDにAdobe AcrobatのPDFファイル形式として収録されています。次の言語のユーザーズガイドをご利用いただけます。オランダ語、英語、フランス語、ドイツ語、イタリア語、ノルウェー語、ポルトガル語、スペイン語、ロシア語、日本語、韓国語、簡体中国語、繁体中国語。このプロジェクトを使用する前に、ユーザーズガイドを必ずお読みください。

동봉된 CD에는 Adobe Acrobat PDF 파일 형식의 사용 설명서가: 네덜란드어, 영어, 프랑스어, 독일어, 이탈리아어, 노르웨이어, 포르투갈어, 스페인어, 러시아어, 일본어, 한국어, 중국어(번체 및 간체)로 제공됩니다. 프로젝터를 사용하기 전에 다음 지침을 읽으십시오.

附带的CD上有Adobe Acrobat pdf格式的整本《使用者指南》，包括下列各种语言版本：荷兰文、英文、法文、德文、意大利文、挪威文、葡萄牙文、西班牙文、俄文、日文、韩文、繁体中文、简体中文。请在使用投影机之前先阅读这些说明。

所附的光碟片上，有Adobe Acrobat (PDF) 格式的這本《使用者手冊》；所提供的不同語言版本包括：荷蘭文、英文、法文、德文、意大利文、挪威文、葡萄牙文、西班牙文、俄文、日文、韓文、繁體中文，以及簡體中文。開始使用本投影機之前，請先詳細閱讀這些說明。

Declaration of Conformity

Manufacturer: InFocus Corporation, 27700B SW Parkway Ave. Wilsonville, Oregon 97070 USA

European Office: Strawinskylaan 585, 1077 XX Amsterdam, The Netherlands

We declare under our sole responsibility that this projector conform to the following directives and norms:

EMC Directive 89/336/EEC, Amended by 93/68/EEC

EMC: EN 55022

EN 55024

EN 61000-3-2

EN 61000-3-3

Low Voltage Directive 73/23/EEC, Amended by 93/68/EEC

Safety: EN 60950: 2000

October, 2003

Trademarks

Apple, Macintosh, and PowerBook are trademarks or registered trademarks of Apple Computer, Inc. IBM is a trademark or registered trademark of International Business Machines, Inc. Microsoft, PowerPoint, and Windows are trademarks or registered trademarks of Microsoft Corporation. Adobe and Acrobat are trademarks or registered trademarks of Adobe Systems Incorporated. InFocus, ProjectorManager, ProjectorNet, and LP are trademarks or registered trademarks of InFocus Corporation.

FCC Warning

This equipment has been tested and found to comply with the limits for a Class A digital device, pursuant to part 15 of the FCC Rules. These limits are designed to provide reasonable protection against harmful interference when the equipment is operated in a commercial environment. This equipment generates, uses, and can radiate radio frequency energy and, if not installed and used in accordance with the instruction manual, may cause harmful interference to radio communications.

Operation of this equipment in a residential area is likely to cause harmful interference in which case the user will be required to correct the interference at his own expense.

EN 55022 Warning

This is a Class A product. In a domestic environment it may cause radio interference, in which case the user may be required to take adequate measures. The typical use is in a conference room, meeting room or auditorium.

Canada

This Class A digital apparatus complies with Canadian ICES-003.

Cet appareil numérique de la classe A est conforme à la norme NMB-003 du Canada.

Agency Approvals

UL, CUL, NOM, IRAM, GOST, C-tick

Other specific Country Approvals may apply, see please product certification label.

Remote Control Warning

Laser radiation class II product; wavelength 650nm; maximum output 1mW. Remote control complies with applicable requirements of 21 CFR 1040.10 and 1040.11. Remote control complies with applicable requirements of EN 60 825-1: 1994 +A11.

Do not look into laser beam emitted from the front of the remote control



Location of laser beam warning labels on remote

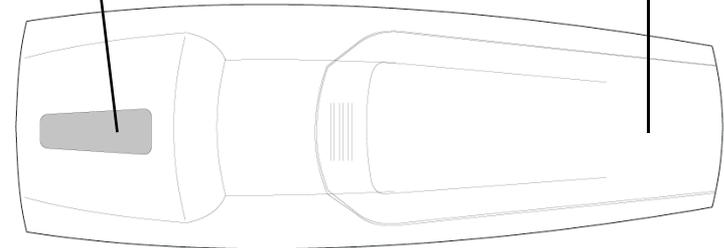

InFocus reserves the right to alter product offerings and specifications at any time without notice.

Table of Contents

Introduction	5
Positioning the projector	7
Connecting a computer	8
Required computer connections	8
Displaying a computer image	10
First-time projector use with Windows 98	11
Adjusting the image	13
Connecting a video device	14
Displaying a video image	16
Shutting down the projector	18
Troubleshooting your setup	18
Using the keypad buttons	26
Using the remote control	27
Using the audio	28
Optimizing computer images	29
Presentation features	29
Optimizing video images	30
Customizing the projector	30
Using the menus	31
Picture menu	32
Settings menu	35
Maintenance	39
Cleaning the lens	39
Changing the lens	39
Replacing the projection lamp	40
Cleaning the dust filter	42
Using the security lock	42
Appendix	43
Projected image size	43
LED Behavior	44
RS-232 commands	45

If you are experienced in setting up presentation systems, use the included *Quick Set Up* card. For complete details on connecting and operating the projector, refer to this User's Guide. Electronic versions of this User's Guide in multiple languages are available on the included CD and on our website.

The website also has technical specifications (an interactive image size calculator, laptop activation commands, connector pin outs, a glossary, the product data sheet), a web store to buy accessories, and a page for online registration. See the inside of the back cover for a list of all relevant web addresses.

Important Operating Considerations for Safety

- Place the projector in a horizontal position no greater than 15 degrees off axis.
- Locate the projector in a well-ventilated area without any obstructions to intake or exhaust vents. Do not place the projector on a tablecloth or other soft covering that may block the vents.
- Locate the projector at least 4' (1.2 m) away from any heating or cooling vents.
- Use only InFocus-approved ceiling mounts.
- Use only the power cord provided. A surge-protected power strip is recommended.
- Refer to this manual for proper startup and shutdown procedures.
- In the unlikely event of the lamp rupturing, discard any edible items placed in the surrounding area and thoroughly clean the area along all sides of the projector. Wash hands after cleaning the area and handling the ruptured lamp. This product has a lamp which contains a very small amount of mercury. Dispose of it as required by local, state or federal ordinances and regulations. For more information see www.eiae.org.

Follow these instructions to help ensure image quality and lamp life over the life of the projector. Failure to follow these instructions may affect the warranty. For complete details of the warranty, see the Warranty section at the end of this User's Guide.

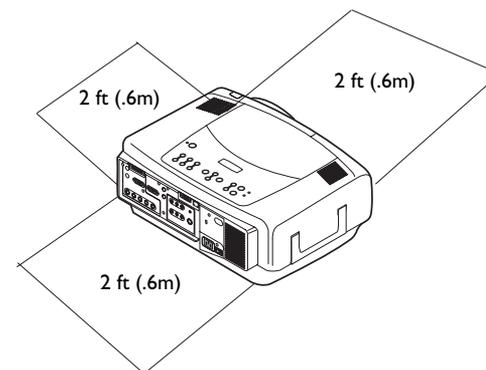

Do not place objects in the areas along the left, back and front sides of the projector. For ceiling mount applications, this area should be 5 feet (1.5m).

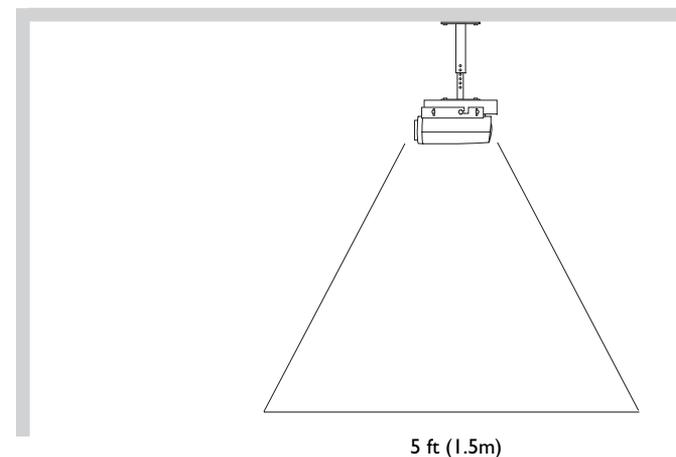

Introduction

Your new multimedia projector provides three computer, three video, and two audio inputs, one audio output, and RS-232 control. The LP840 and LP850 have XGA 1024x768 resolution while the LP860 has SXGA+ 1400x1050 resolution. Optional user-changeable short, fixed short, long and super long throw lenses make this a flexible product suitable for many different uses. The projector is easy to connect, easy to use, and easy to maintain.

Product specifications

To read the latest specifications on your multimedia projector, be sure to visit our website. Web address information is located on the back inside cover of this User's Guide.

Accessories

The standard accessories that came with your projector can be found on the packing list that came with your projector. Optional accessories are listed in the Accessories catalog that came with the projector and can also found on our website. See the inside back cover for the web address.

Online Registration

Register your projector on our website to receive product updates, announcements, and registration incentives. See the inside back cover for the web address.

Projector components and features: front

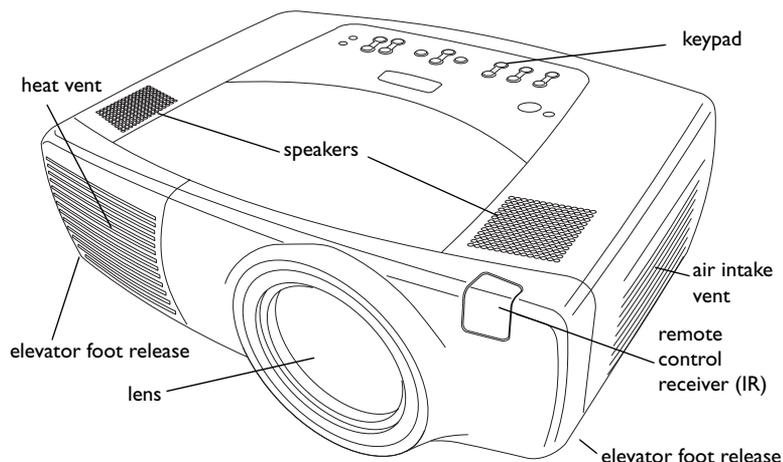

Projector components and features: back

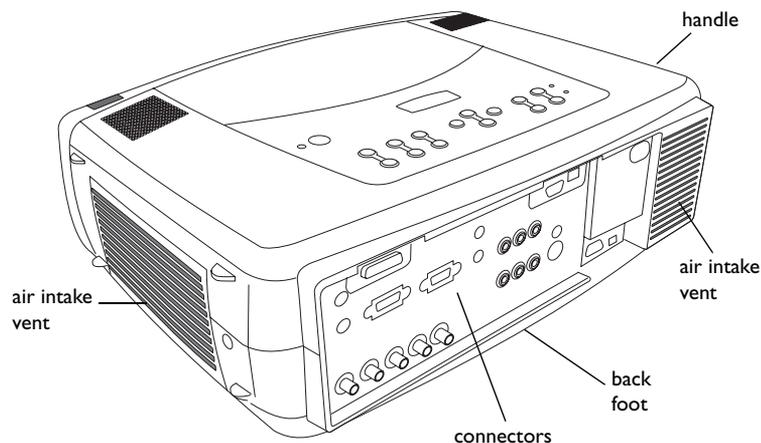

Connector Panel

The projector provides three computer and three video connection options:

- one M1-D (DVI with USB)
- one VESA computer
- one BNC (RGBHV and Pr, Pb, Y)
- one component RCA video (Pr, Pb, Y)
- one S-video
- one composite RCA video

The projector provides computer and video connectors for audio support:

- two composite RCA stereo audio (L, R)
- one audio out
- two audio ins for computer

The projector also provides the following connectors:

- one wired remote
- one monitor out
- RS-232 serial connector (for serial control)
- RJ-45 connector (for networked control via ProjectorNet software)

The RS-232 Command Line Interface (CLI) specifications and commands are available on our website. See the back inside cover of this User's Guide for website information.

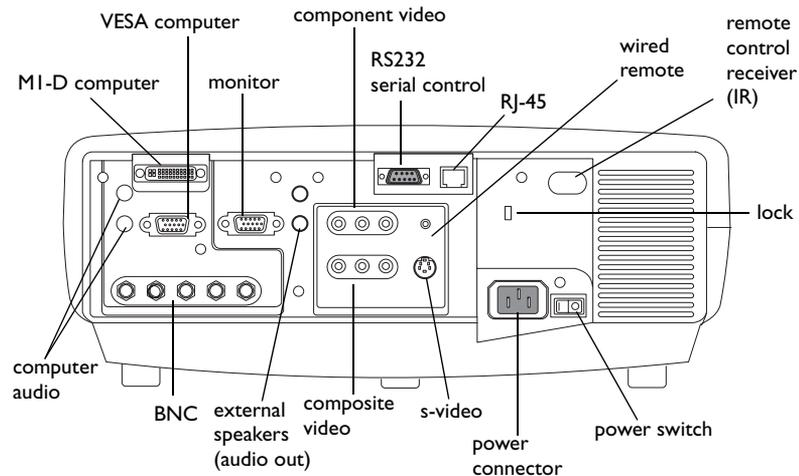

Positioning the projector

To determine where to position the projector, consider the size and shape of your screen, the location of your power outlets, and the distance between the projector and the rest of your equipment. Here are some general guidelines:

- Position the projector on a flat surface at a right angle to the screen. The projector (with the standard lens) must be at least 3 feet (0.9m) from the projection screen.
- Position the projector within 10 feet (3m) of your power source and within 6 feet (1.8m) of your video device (unless you purchase extension cables). To ensure adequate cable access, do not place the projector within 6 inches (.15m) of a wall or other object.
- If you are installing the projector on the ceiling, refer to the installation guide that comes with the Ceiling Mount Kit for more information. To turn the image upside down, see “Ceiling” on page 35. We recommend using an authorized ceiling mount. The Ceiling Mount Kit is sold separately; see the Accessories catalog that came with this projector or visit our website for more information.
- Position the projector the desired distance from the screen. The distance from the lens of the projector to the screen, the zoom setting, and the video format determine the size of the projected image. For information about image sizes at different distances, see “Projected image size” on page 43.
- For the standard lens that comes with the projector, the image exits at a given angle. However, the lens shift feature makes the image offset variable. The image offset is 100% at a 10:0 ratio when the projector is in 4:3 mode (default mode). This means that if you have an image 10’ high, all 10’ will appear above the center of the lens.
- The image offset is 50% when the lens shift is at a 1:1 ratio. This means that if you have an image 10’ high, the bottom of the image will be 5’ below the center of the lens.
- For information about the optional lenses image offsets, see “Projected image size” on page 43.

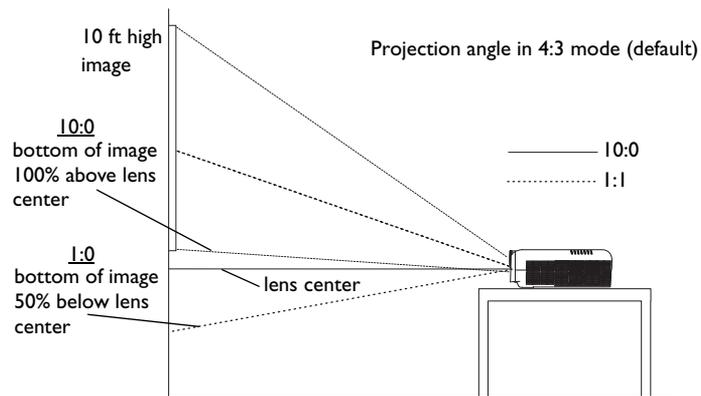

Connecting a computer

Required computer connections

Connect one end of the VESA computer cable to the **Computer 2** connector on the projector. Connect the other end to the video port on your computer. If you are using a desktop computer, you first need to disconnect the monitor cable from the computer's video port.

Connect the black power cable to the connector on the back of the projector and to your electrical outlet.

NOTE: Always use the power cable that shipped with the projector.

Optional computer connections

To control your computer's mouse using the projector's remote control, connect the USB and DVI cables to the USB and DVI ports on your computer, and connect the other end to the **Computer 1** (M1-D) connector on the projector. USB drivers must be installed to use the USB feature. For more information, see page 12.

If your projector cannot receive the remote's signal due to IR interference, you can connect directly to the projector via a remote cable. To do so, plug the remote cable into the wired remote connector on the projector. Plug the other end into the connector on the remote,

To have sound with your presentation, connect the audio cable to your computer and to the corresponding computer **Audio In** connector on the projector.

connect computer cable

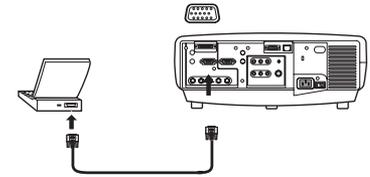

connect power cable

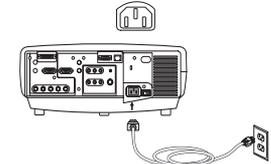

connect M1-D cable

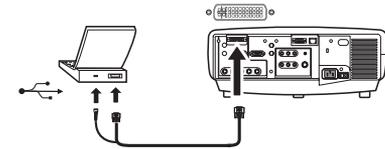

connect wired remote

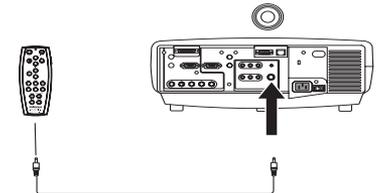

connect audio cable

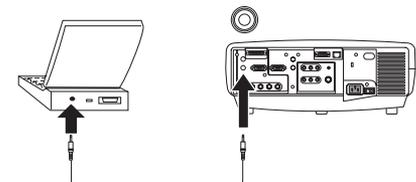

If you are using a desktop computer and want to see the image on your computer screen as well as on the projection screen, plug the monitor cable to the **Monitor out** connector on the projector.

connect monitor cable

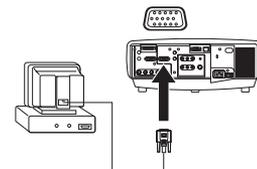

You can also connect to your computer using a BNC cable. Connect the BNC connectors on the BNC cable to the appropriate **Computer 3** connectors on the projector. Connect the other end to the video port on your computer. If you are using a desktop computer, you first need to disconnect the monitor cable from the computer's video port. When all 5 BNCs are connected, the projector handles separate synchs on H and V.

connect BNC cables

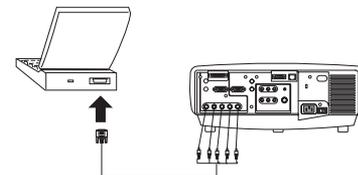
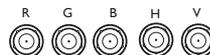

You can control the projector from an LCD control panel, touch screen, or other control device or computer by connecting an RS-232 cable to the projector's **Serial** connector. Specific RS-232 commands can be found in the Service and Support section of our website and in this User's Guide's Appendix.

connect RS-232 cable

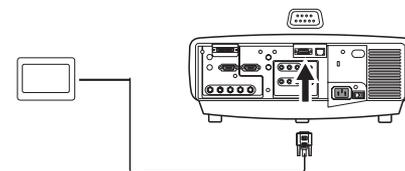

The projector can be managed by ProjectorNet networking software through its **Network** (RJ-45) connector. Contact an authorized dealer or visit our website for information on ProjectorNet.

connect CAT-5 cable

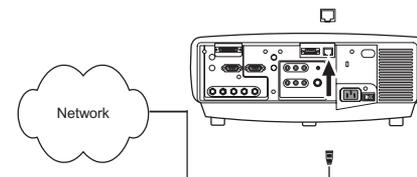

Displaying a computer image

Remove the lens cap.

remove lens cap

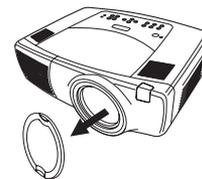

Press the power switch on the back of the projector to the on position, then press the **Power** button on the top of the projector or the remote.

The LED flashes green and the fans start to run. When the lamp comes on, the startup screen is displayed and the LED is steady green. It can take a minute for the image to achieve full brightness.

? No startup screen? Get help on page 19.

press Power switch



press Power button

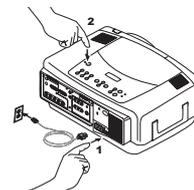

Turn on your computer.

The computer's image should appear on the projection screen. If it doesn't, press the **Computer** button on the projector's keypad.

turn on computer



computer

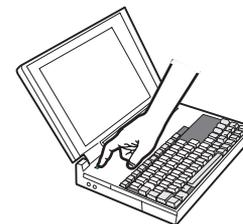

Make sure your laptop's external video port is active.

Many laptops do not automatically turn on their external video port when a projector is connected. Usually a key combination like FN + F5 is used to turn the external display on and off. Refer to your computer's documentation to learn your computer's key combination.

? No computer image? Try pressing the **Auto Image** button on the keypad. Get help on page 19.

activate laptop's external port

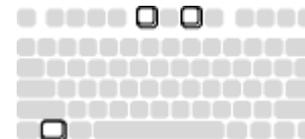

First-time projector use with Windows 98

The first time you connect a computer running Windows 98 to the projector, the computer recognizes the projector as “new hardware” and the Add New Hardware Wizard appears. Follow these instructions to use the Wizard to load the correct driver (which was installed with your Windows operating system).

If you are running Windows 2000, Windows ME, or Window XP, skip these steps and go to “Adjusting the image” on page 13.

- a Click Next to begin searching for the driver.
- b Make sure “Search for the best driver” is selected, then click Next.
- c Uncheck any checked boxes, then click Next. Windows automatically locates the driver. If this driver has been removed, reload the driver using your Windows operating system CD.
- d When Windows finds the driver, you are ready to install it. Click Next.

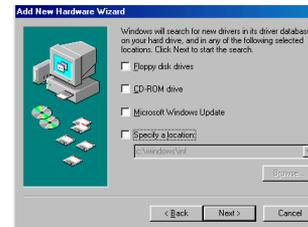

Skip this page if you did not connect a USB mouse cable

For Windows 98:

- If you connected the USB cable, the Add New Hardware Wizard appears again. Drivers must be installed to use the USB functionality.
- **The Wizard launches two times.**

The first time it detects a USB Human Interface Device (for the keyboard).

The second time it detects a USB Human Interface Device (for the mouse).

For Windows 2000, Windows ME, and Windows XP:

- The USB drivers are automatically installed.

Adjusting the image

Adjust the height of the projector, if necessary, by pressing the release buttons on each side of the projector's front to extend the elevator feet.

adjust height

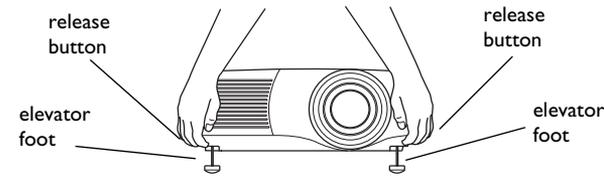

Position the projector the desired distance from the screen at a 90 degree angle (perpendicular) to the screen.

See page 43 for a table listing screen sizes and distances.

adjust distance

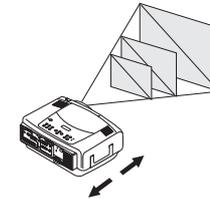

Adjust the zoom or focus by pressing the power **Zoom** or power **Focus** buttons on the keypad until the desired image size and focus are produced.

You can also adjust the zoom and focus via the menus. See page 32

adjust zoom and focus

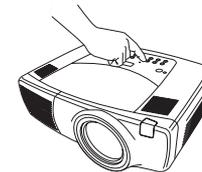
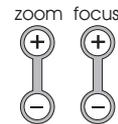

If the image is not on the screen or viewing area, adjust it by pressing the lens shift button on the keypad.

Press the upper **Lens Shift** button to shift the lens upward. Press the lower **Lens Shift** button to shift the lens downward.

You can also adjust the lens shift via the menus. See page 32.

adjust lens shift

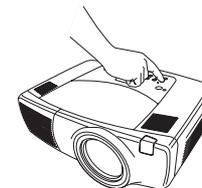

Adjust the Contrast or Brightness in the Picture menu.

See page 31 for help with the menus.

adjust Contrast or Brightness

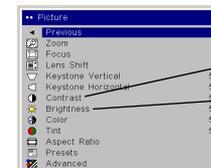

contrast

brightness

Connecting a video device

Standard video connections

Plug the audio/video (A/V) cable's yellow connector into the video-out connector on the video device. Plug the other yellow connector into the yellow **Video 3** connector on the projector. Plug a white connector into the left audio out connector on the video device and plug a red connector into the right audio out connector on the video device. Plug the remaining white connector into the left **audio in** connector on the projector, and plug the red connector into the right **audio in** connector on the projector.

connect A/V cable

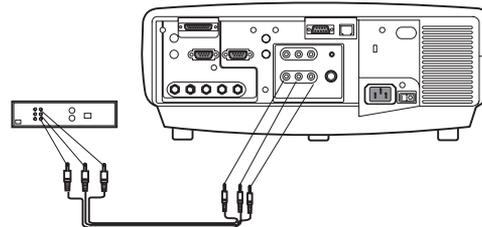

Connect the black power cable to the connector on the back of the projector and to your electrical outlet. **NOTE:** Always use the power cable that shipped with the projector.

connect power cable

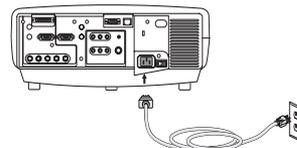

Optional video connections

If the video device uses a round, four-prong S-video connector, plug an S-video cable (sold separately) into the S-video connector on the video device and into the **Video 2** connector on the projector. Use the A/V cable's audio connectors as described directly above (the yellow connectors on the A/V cable are not used).

connect S-video and video cables

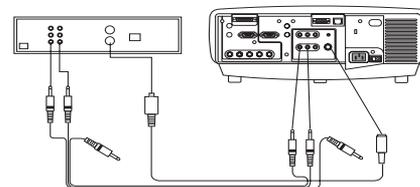

If the video device uses component cable connectors (sold separately), plug the cable's green connectors into the green component-out connector on the video device and into the **Video 1** green component connector (labeled "Y") on the projector. Plug the component cable's blue connectors into the blue component-out connector on the video device and into the blue component connector (labeled "Pb") on the projector. Plug the component cable's red connectors into the red component-out connector on the video device and into the red component connector (labeled "Pr") on the projector. Use the A/V cable's audio connectors as described above (the yellow connectors on the A/V cable are not used). **NOTE:** The component connectors can be used for HDTV sources (480i, 480p, 720p and 1080i formats).

connect component cables and video cables

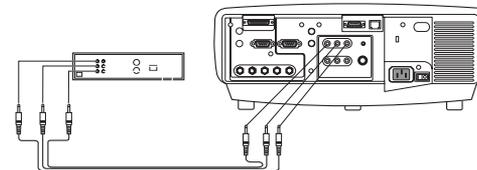

You can also connect to your video device using a BNC cable. Connect the BNC connectors of the BNC cable to the appropriate **Computer 3** connectors on the projector. Connect the other end to the video port on your video device. Use the A/V cable's audio connectors as described on the previous page (the yellow connectors on the A/V cable are not used).

When 4 BNCs are connected, the projector handles a composite synch on H.
When 3 BNCs are connected, the projector handles a composite synch on G.

NOTE: The BNC connectors can be used for HDTV sources (480i, 480p, 720p and 1080i formats).

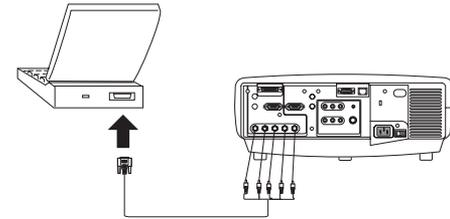
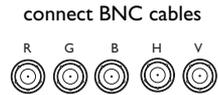

Displaying a video image

Remove the lens cap.

remove lens cap

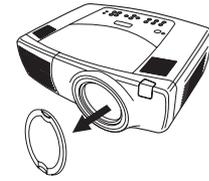

Press the power switch on the back of the projector to the on position, then press the **Power** button on the top of the projector.

press Power switch



press Power button

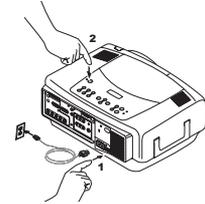

The LED flashes green and the fans start to run. When the lamp comes on, the startup screen is displayed and the LED is steady green. It can take a minute for the image to achieve full brightness.

? No startup screen? Get help on page 19.

Plug in and turn on the video device.

turn on video device

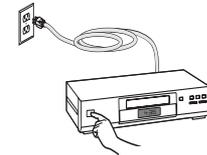

The video device's image should appear on the projection screen. If it doesn't, press the **Video** button on the keypad.

Adjust the height of the projector, if necessary, by pressing the release buttons on each side of the projector's front to extend the elevator feet.

adjust height

release button

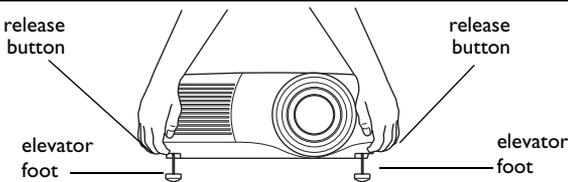

release button

elevator foot

elevator foot

Position the projector the desired distance from the screen at a 90 degree angle to the screen. See page 43 for a table listing screen sizes and distances to the screen.

adjust distance

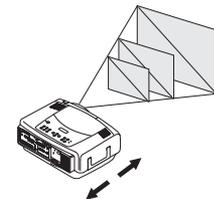

Adjust the zoom or focus by pressing the power **Zoom** or power **Focus** buttons on the keypad until the desired image size and focus are produced.

You can also adjust the zoom and focus via the menus. See page 32

adjust Zoom and Focus

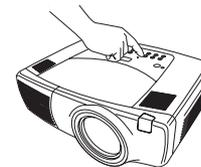
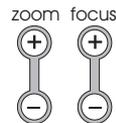

If the image is not on the screen or viewing area, adjust it by pressing the lens shift button on the keypad.

Press the upper **Lens Shift** button to shift the lens upward. Press the lower **Lens Shift** button to shift the lens downward

You can also adjust the lens shift via the menus. See page 32.

adjust Lens Shift

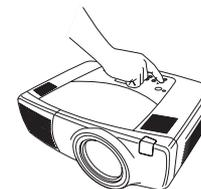

Adjust the volume on the keypad or remote.

adjust volume

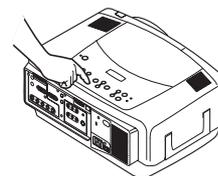

Adjust the **Contrast**, **Brightness**, **Color**, or **Tint** in the Picture menu.

See page 31 for help with the menus.

adjust Picture menu



contrast

brightness

color

tint

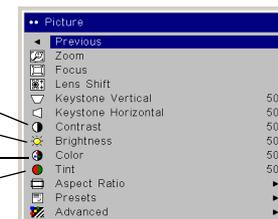

Shutting down the projector

The projector automatically blanks the screen after no active source is detected for 50 minutes. This blank screen helps preserve the life of the projector. The image returns when an active source is detected or a remote or keypad button is pressed.

Screen Save

You can make the blank screen appear after five minutes by turning on Screen Save in the **Settings>System** menu. See page 36.

Power Save

The projector also has a Power Save feature that automatically turns the lamp off after no signals are detected for 20 minutes. After 10 additional minutes with no signal, the projector powers down. If an active signal is received before the projector powers down, the image is displayed. You must press the Power button to display an image after 30 minutes have passed. When Power Save is enabled, Screen Save is disabled. See page 36.

Turning off the projector

To turn off the projector, press the **power** button and verify that you want to turn the projector off by pressing the power button again within 3 seconds. You can cancel the shutdown by not pressing the **power** button a second time. The lamp turns off and the LED blinks green for over 1 minute while the fans continue to run to cool the lamp. When the lamp has cooled, the LED lights green and the fans stop. Press the power switch on the back of the projector and unplug the power cable to completely power off the projector.

Troubleshooting your setup

If your image appears correctly on the screen, skip to the next section. If it does not, troubleshoot the setup. The LED on top of the projector indicates the state of the projector and can help you troubleshoot. See “LED Behavior” on page 44. for information on LED behavior and what it means.

The following tables show common problems. In some cases, more than one possible solution is provided. Try the solutions in the order they are presented. When the problem is solved, you can skip the additional solutions.

Source Troubleshooting

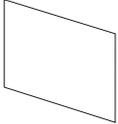
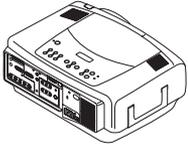
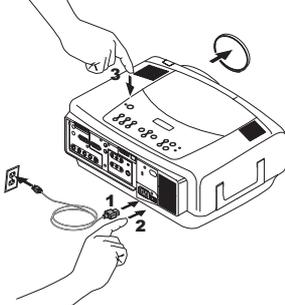
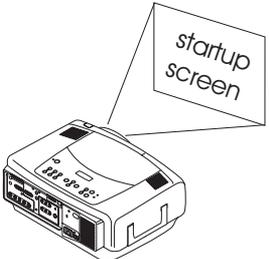
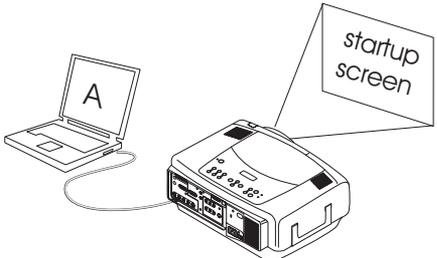
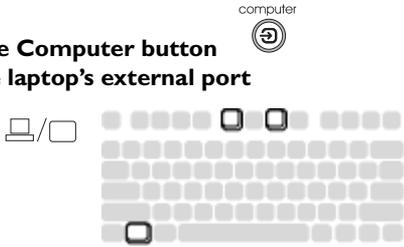
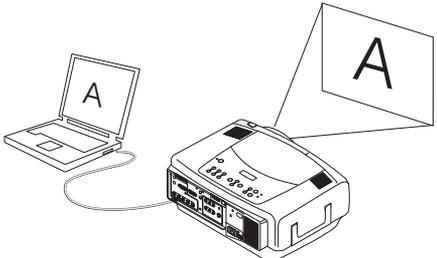
Problem	Solution	Result
<p data-bbox="25 191 231 215">No startup screen</p>  	<p data-bbox="640 156 1093 215">Plug power cable in, press power switch, press power button. Remove lens cap.</p> 	<p data-bbox="1164 191 1332 215">Correct image</p> 
<p data-bbox="25 556 341 579">Only startup screen appears</p> 	<p data-bbox="640 591 987 650">Press the Computer button Activate laptop's external port</p>  <p data-bbox="631 826 744 873">or restart laptop</p> 	<p data-bbox="1164 550 1475 573">Computer image projected</p> 

No computer image, just the words “Signal out of range”

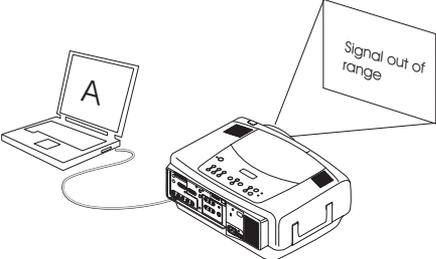

Adjust computer refresh rate in Control Panel>Display>Settings>Advanced>Adapter (location varies by operating system)

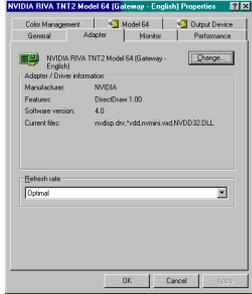

You may also need to set a different resolution on your computer, as shown in the following problem, “Image fuzzy or cropped”

Computer image projected

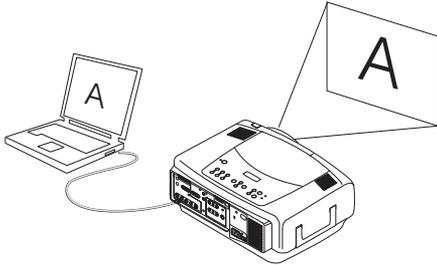
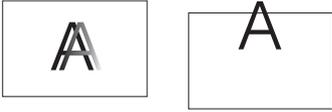

Image fuzzy or cropped



**Set your computer's display resolution to the native resolution of the projector
(Start>Settings>Control Panel>Display>Settings tab, select 1024x768 for LP840/850, 1400x1050 for LP860)**

**For a laptop,
disable laptop
monitor
or turn-on dual-
display mode**

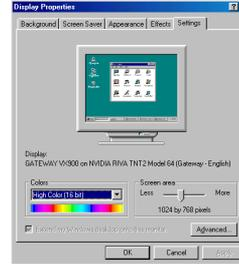
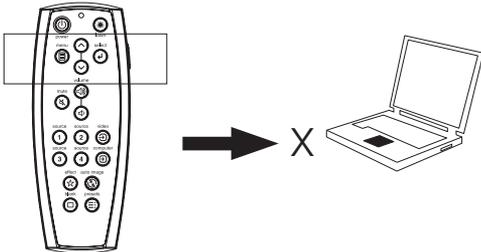

Image clear and not cropped



Remote control navigation buttons not working with my computer



Connect USB cable (page 8) then load USB drivers, if needed (page 11). Or, connect wired remote cable and reboot your computer (page 8).

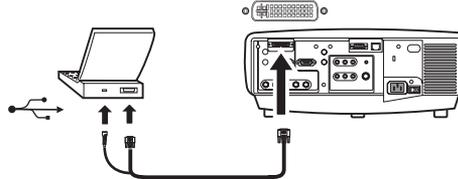

**Remote controls navigation buttons.
See page 27 for information on the remote**

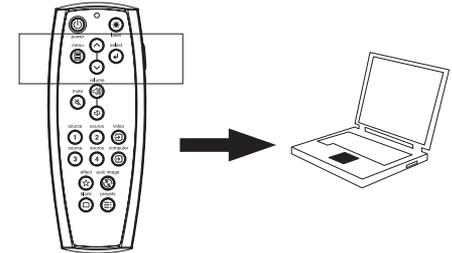

Projector troubleshooting

Problem	Solution	Result
<p>Image not square</p> 	<p>Adjust keystone the Picture menu</p> 	<p>Square image</p> 
<p>Image not sharp</p> 	<p>Adjust the focus on the keypad or Sharpness in the Picture>Advanced menu</p> 	<p>Correct image</p> 
<p>Image does not fit 16:9 screen</p> 	<p>Change aspect ratio to 16:9 in Picture>Aspect ratio menu</p> 	<p>Correct image</p> 

Image upside down



Turn on/off Ceiling in Settings>System menu

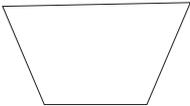
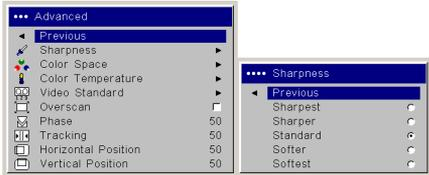
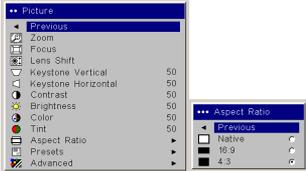

Correct image



Image reversed left to right



Turn on/off Rear in Settings>System menu



Correct image



Projected colors don't match source

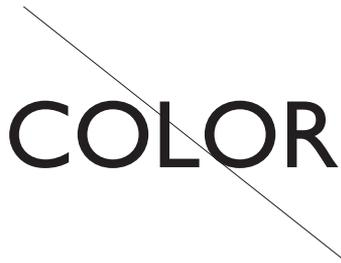

Adjust color, tint, color temperature, brightness, contrast in the menus

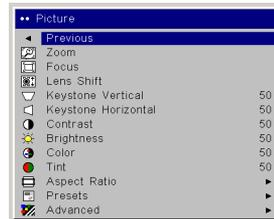

Correct image



Lamp won't turn on, Temp LED solid red (page 44)

solid red — ● temp
● lamp

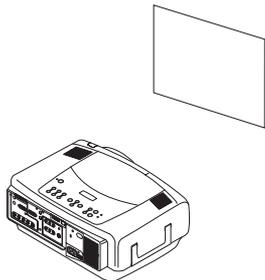

Make sure vents aren't blocked; allow projector to cool for one minute

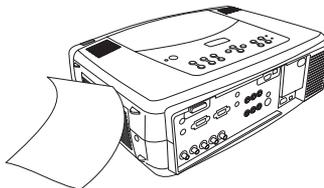

Unplug projector; wait one minute; plug in projector and turn it on: lamp lights

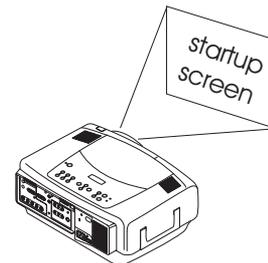

Lamp won't turn on, Lamp LED blinking red (page 44)

blinking red — ● temp
● lamp

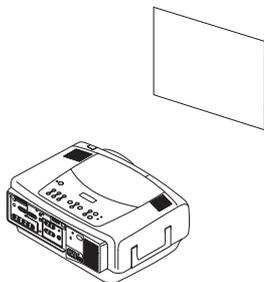

Lamp may need to be replaced (page 40)

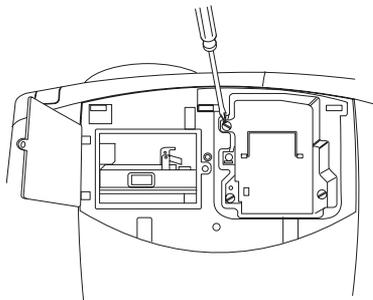

Lamp turns on

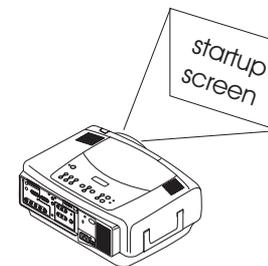
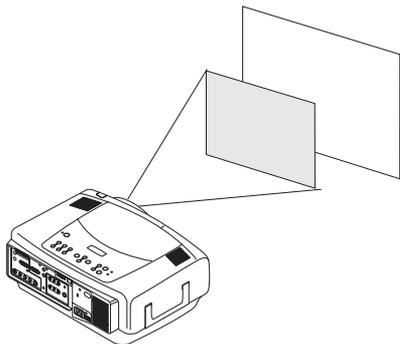
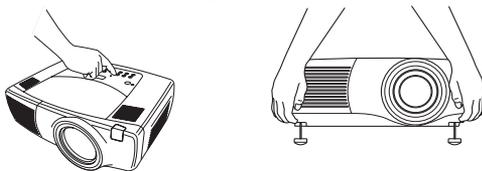

Image not centered on screen



Move projector, adjust zoom or lens shift on keypad, adjust height



Adjust horizontal or vertical position in Picture>Advanced menu

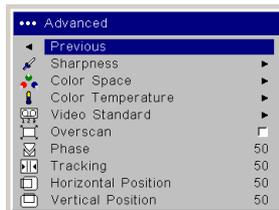

Correct image

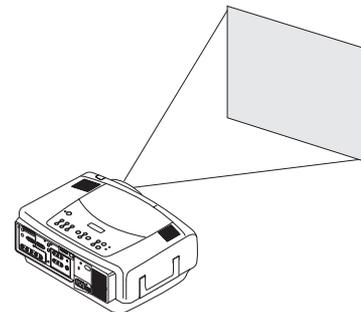

Still having problems?

If you need assistance, visit our website or call us. See the inside of the back cover for a list of all relevant web addresses.

This product is backed by a limited two-year warranty. An extended warranty plan may be purchased from your dealer. When sending the projector in for repair, we recommend shipping the unit in its original packing material, or having a professional packaging company pack the unit. Please insure your shipment for its full value.

Using the keypad buttons

Most buttons are described in detail in other sections, but here is an overview of their functions:

- power**—turns the projector on (page 10) and off (page 16).
- lens shift**—shifts the projected image up or down
- zoom**—moves the projected image closer or further away.
- focus**—adjusts the clarity.
- menu**—opens the on-screen menus (page 31).
- up/down arrows**—navigates to and adjusts settings in the menus (page 31).
- select**—confirms choices made in the menus (page 31).
- volume**—adjusts sound (page 28).
- video and computer**—changes the active source.
- temp**—alerts you to possible temperature-related problems (page 44).
- lamp**—alerts you to possible lamp-related problems (page 44).

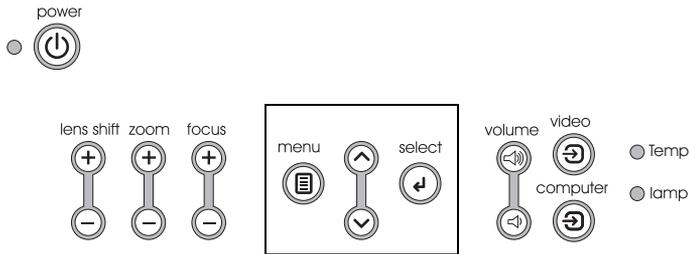

menu navigation buttons

Using the remote control

The remote uses two (2) provided AAA batteries. They are easily installed by sliding the cover off the remote's back, aligning the + and - ends of the batteries, sliding them into place, and then replacing the cover.

To operate, point the remote at the projection screen or at the projector (not at the computer). The range of optimum operation is about 30 feet (9.14m). For best results, aim the remote directly at the projector.

To use the laser pointer, press and hold the **Laser** button. The laser turns off when the button is released, or times out after two (2) minutes of continuous operation.

WARNING: Do not look into the laser beam emitted from the top of the remote control.

The remote contains four **Source** buttons that allow you to assign a particular input to a specific source. Simply press the numbered Source buttons to travel to whatever four sources you wish to have available.

Press the remote's **Menu** button to open the projector's menu system. Use the arrow buttons to navigate, and the **Select** button to select features and adjust values in the menus.

The remote also has a power button to turn the projector on and off, volume buttons and a mute button to control the sound, a backlight button to light the remote's buttons in the dark, and a video and computer button to switch between those two sources.

Two presentation-specific features are also provided. Use the blank button to display a blank screen instead of the current slide; use the effect button to invoke a user-definable action, such as freeze, PiP, or magnify.

The Auto Image button reacquires the computer image and the Presets button lets you customize the settings for each source. Up to three Preset settings can be customized and saved.

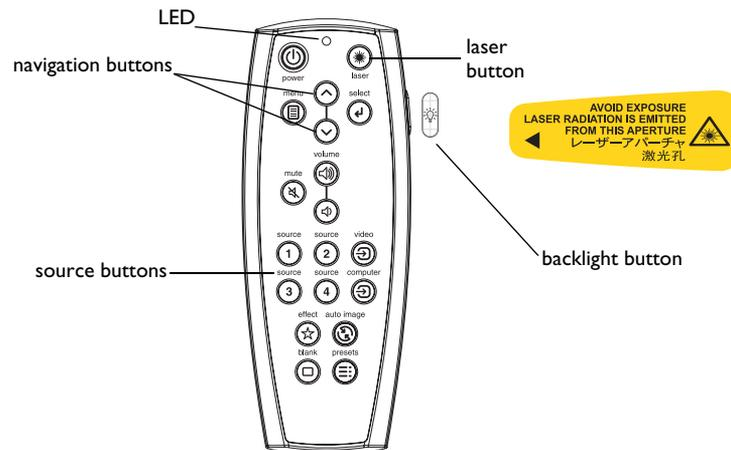

Troubleshooting the remote

- Make sure the batteries are installed in the proper orientation and are not dead. The LED at the top of the remote lights when any button is pressed when the battery power is adequate.
- Make sure you're pointing the remote at the projector, not the computer, and are within the remote range of 30 feet (9.14m).
- If you are trying to control your computer's mouse, make sure a mouse cable is connected. If using the USB cable that is part of the M1 cable, make sure the correct drivers are installed.

Using the audio

To play sound from the projector, connect your source to the Audio In connector on the projector.

To adjust the volume, use the buttons on the keypad or remote.

To adjust the balance, or loudness, use the Audio menu (see page 35).

To mute the sound, press the **Mute** button.

Troubleshooting audio

If there is no sound, check the following:

- Make sure the audio cable is connected.
- Make sure mute isn't active.
- Make sure the volume is turned up enough. Press the volume button on the keypad or remote.
- Make sure you are connected to the corresponding **audio in** for your source. **Computer 1** and **3** share a single audio input. **Computer 2** has its own audio input. **Video 1, 2** and **3** share a single stereo input.
- Adjust the audio source.
- If playing a video, make sure the playback has not been paused.

Connecting external speakers

The projector can be attached to external speakers that have their own power source by plugging a speaker cable into the projector's **Audio Out** connector.

connect audio cable

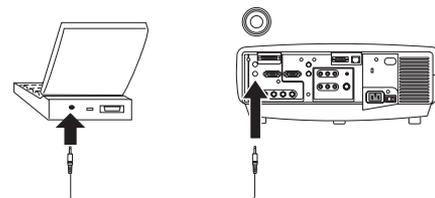

adjust volume
volume

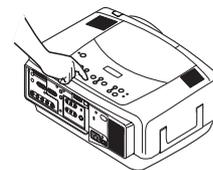

computer 1 and 3
corresponding audio

computer 2 and
corresponding audio

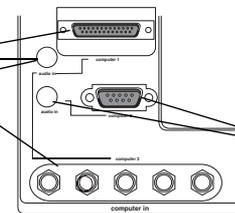

external speakers

audio out

speaker
cable

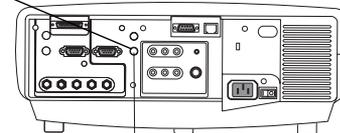
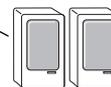

Optimizing computer images

After your computer is connected properly and the computer's image is on the screen, you can optimize the image using the onscreen menus. For general information on using the menus, see page 31.

- Adjust the Keystone, Contrast, or Brightness in the Picture menu.
- Change the Aspect Ratio. Aspect Ratio is the ratio of the image width to image height. TV screens are usually 1.33:1, also known as 4:3. HDTV and most DVDs are 1.78:1, or 16:9. Choose the option that best fits your input source. See page 32 for details.
- Adjust the Color Temperature in the Advanced menu.
- Adjust the Phase, Tracking, or Horizontal or Vertical position in the Advanced menu.
- Once you have optimized the image for a particular source, you can save the settings using Presets. This allows you to quickly recall these settings later. See page 33.

Presentation features

Several features are provided to make giving presentation easier. The following is an overview, details are found in the menu section on page 31.

- The remote's **Effect** button allows you to assign various features to the key. The default effect is Magnify. You can select from Blank, Mute, Aspect Ratio, Source, Auto Image, Freeze, Magnify, About, and PiP Source. See page 37 for details.
- The Freeze effect allows you to freeze the displayed image. This is useful if you want to make changes on your computer without your audience seeing them.
- The **Blank** button on the remote allows you to display a blank screen instead of the active source. See page 36.
- The PiP Source effect lets you change the video source in a smaller window on top of the computer image. See page 37.
- The Startup Logo menu option lets you change the default startup screen to a black, white, blue, or a custom logo screen via Logo Capture. See page 36.
- Two menu options, Power Save and Screen Save, are provided to automatically shut down the projector after several minutes of inactivity or display a blank screen. This helps preserve lamp life. See page 35 and page 36.
- A Low Power menu option is also available to help lower the projector's fan sound volume. See page 35.

Optimizing video images

After the video device is connected properly and the image is on the screen, you can optimize the image using the onscreen menus. For general information on using the menus, see page 31.

- Adjust the Keystone, Contrast, Brightness, Color, or Tint in the Picture menu. See page 32.
- Change the Aspect ratio. Aspect ratio is the ratio of the image width to image height. TV screens are usually 1.33:1, also known as 4:3. HDTV and most DVDs are 1.78:1, or 16:9. Choose the option that best fits your input source. See page 32.
- Select a Sharpness setting. See page 34.
- Adjust the Color Temperature. Select a listed value, or select User and individually adjust the intensity of the red, green, and blue color. See page 34.

Customizing the projector

You can customize the projector for your specific setup and needs. See page 35 to page 39 for details on these features.

- For rear projection, turn Rear mode on in the **Settings>System** menu.
- For ceiling mounted projection, turn Ceiling mode on in the **Settings>System** menu.
- Specify which source the projector checks first for an active signal during power-up.
- Specify the function of the Effect Key on the remote.
- Turn the projector's on-screen display messages on and off.
- Turn on power saving features.
- Specify blank screen colors and startup logos.
- Specify the menu language.
- Manage your projector via ProjectorNet software. See page 9 for more information.
- Control your projector using RS232 commands. See page 9.
- Customize the projector for your specific installation using optional long or short throw lenses. See the inside back cover of this User's Guide for ordering information.
- Gain control of your projector from your laptop with InFocus ProjectorManager™, a free application that turns any PC into an advanced projector remote control.

ProjectorManager can be downloaded from our website link found on the CD that came with your projector.

Using the menus

To open the menus, press the menu button on the keypad or remote. (The menus automatically close after 60 seconds if no buttons are pressed.) The Main menu appears. Use the arrow buttons to move up and down to highlight the desired submenu, then press the **Select** button.

To change a menu setting, highlight it, press **Select**, then use the up and down arrow buttons to adjust the value, select an option using radio buttons, or turn the feature on or off using check boxes. Press **Select** to confirm your changes. Use the arrows to navigate to another setting. When your adjustments are complete, navigate to Previous, then press **Select** to go to the previous menu; press the **Menu** button at any time to close the menus.

Dots appear before the menu name. The number of dots indicate the menu's level, ranging from one (the Main menu) to four (the most nested menus).

The menus are grouped by usage:

- The Picture menu provides image adjustments.
- The Settings menu provides set-up type adjustments that are not changed often.
- The About menu provides a read-only display of information about the projector and source.

Certain menu items may be grayed out until a particular source is connected. For example, Sharpness is only available for video sources and will be hidden when a computer source is active. Other menu items may be grayed out when they are not available. For example, Brightness is grayed out until an image is active.

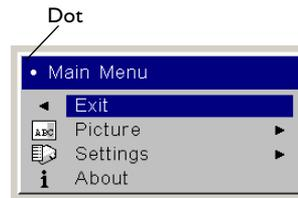

Main menu

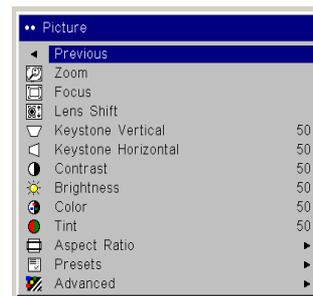
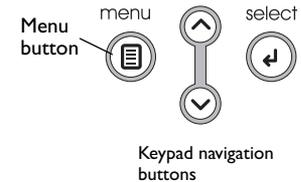

Picture menu

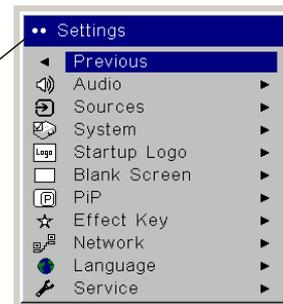

Settings menu

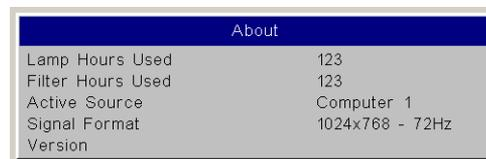

About menu

Picture menu

To adjust the following six settings, highlight the setting, press **Select**, use the up and down arrows to adjust the values, then press select to confirm the changes.

Zoom: allows you to adjust a lens to zoom in and out. Highlight Zoom, then press the up or down arrows on the keypad or remote.

Focus: allows you to adjust the lens focus for an image. Highlight Focus, then press the up or down arrows on the keypad or remote.

Lens Shift: allows you to mechanically shift the lens. Highlight Lens Shift, then press the up or down arrows on the keypad or remote.

Keystone Vertical: adjusts the image vertically and makes a squarer image by using an adjustable scale band.

Keystone Horizontal: adjusts the image horizontally and makes a squarer image by using an adjustable scale band.

Contrast: controls the degree of difference between the lightest and darkest parts of the picture and changes the amount of black and white in the image.

Brightness: changes the intensity of the image.

Color: (video sources only) adjusts a video image from black and white to fully saturated color.

Tint: adjusts the red-green color balance in the image.

Aspect Ratio: Aspect ratio is the ratio of the image width to image height. TV screens are usually 1.33:1, also known as 4:3. HDTV and most DVDs are 1.78:1, or 16:9. The default is 4:3, which displays the input resized up or down to fill the display area.

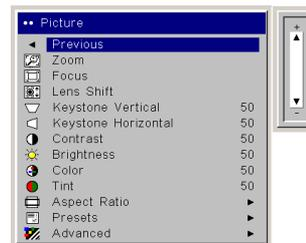

Keystone Vertical

increasing keystone

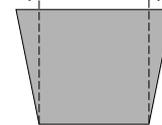

decreasing keystone

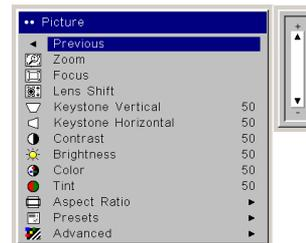
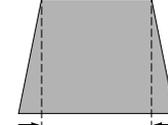

Keystone Horizontal

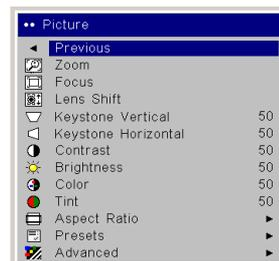
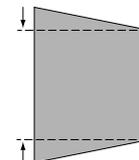

Aspect Ratio

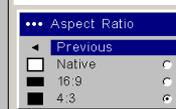

Presets: The provided Presets optimize the projector for displaying computer presentations, photographs, film images, and video images. (Film input is material originally captured on a film camera, like a movie; video input is material originally captured on a video camera, like a TV show or sporting event.) You can use the preset as a starting point, then further customize the settings for each source. The settings you customize are saved in the preset for each source. To restore the factory default settings, choose Factory Reset in the **Settings>Service** menu.

There are also three user-definable presets. To set a preset for the current source, adjust the image, then choose Save User 1, 2, or 3 in the **Save Settings** menu. You can recall these settings in the future by selecting the appropriate user presets.



Presets

Advanced settings

Sharpness: (video sources only) changes the clarity of the edges of a video image. Select a sharpness setting.

Color Space: This option applies to computer and component video sources. It allows you to select a color space that has been specifically tuned for the input signal. When Auto is selected, the projector automatically determines the standard. To choose a different setting, turn off Auto, then choose RGB for computer sources, choose either SMPTE240, REC709 or REC601 for component video sources.

Color Temperature: changes the intensity of the colors. Select a listed value, or select User and individually adjust the intensity of the red, green, and blue colors.

Video Standard: when set to Auto, the projector attempts to automatically pick the video standard based on the input signal it receives. (The video standard options may vary depending on your region of the world.) If the projector is unable to detect the correct standard, the colors may not look right or the image may appear “torn.” If this happens, manually select a video standard by selecting NTSC, PAL, or SECAM from the Video Standard menu.

Overscan: (video sources only) removes noise around the video image.

The following 4 options are for computer sources only.

Phase: adjusts the horizontal phase of a computer source.

Tracking: adjusts the vertical scan of a computer source.

Horizontal / Vertical Position: adjusts the position of a computer source.

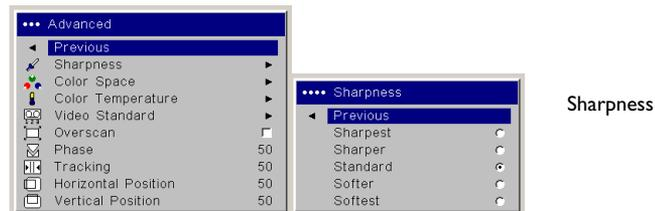

Sharpness

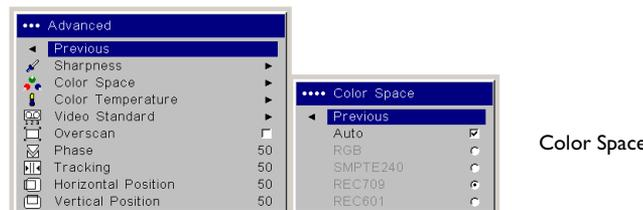

Color Space

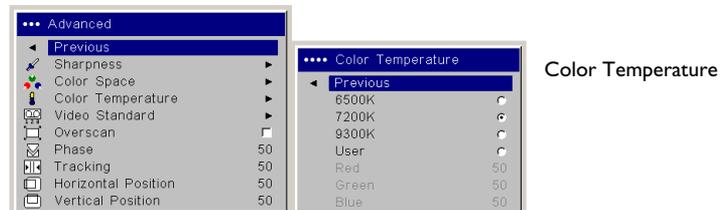

Color Temperature

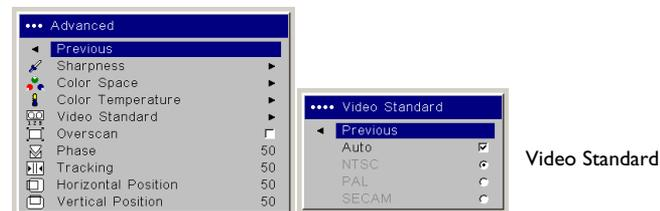

Video Standard

Settings menu

Audio: allows adjustments to the Balance and Volume. Also allows you to turn on and off the Internal speakers, and projector startup Chime.

Sources: allows you to assign a particular input to a specific source key when using the Integrator remote. Also allows selection of a default Startup Source and enables or disables Autosource.

Sources>Power-up Source: this determines which source the projector checks first for active signal during power-up.

Sources>Autosource: When Autosource is not checked, the projector defaults to the source selected in Powerup Source. If no source is found, a blank screen displays. When Autosource is checked, Powerup Source determines which source the projector defaults to at power-up. If no signal is present, the projector checks the sources in order until a source is found or until power down.

System>Rear: reverses the image so you can project from behind a translucent screen.

Ceiling: turns the image upside down for ceiling-mounted projection.

IR Receivers: turns individual IR receivers off or on to avoid environmental interference.

Auto Power: When Auto Power is checked, the projector automatically goes into the startup state after the projector is powered on. This allows control of ceiling mounted projectors with a wall power switch.

Display Messages: displays status messages (such as “Searching” or “Mute”) in the lower-left corner of the screen.

Low Power: toggles between on and off. Turn it on to lower the light output of the lamp. This also lowers the fan speed, making the projector quieter.

NND: prevents your notebook computer from going into Screen Save mode (functions only when the USB connector is plugged in).

Power Save: automatically turns the lamp off after no signals are detected for 20 minutes. After 10 additional minutes with no signal, the projector powers down. If an active signal is received before the projector powers down, the image will be displayed.

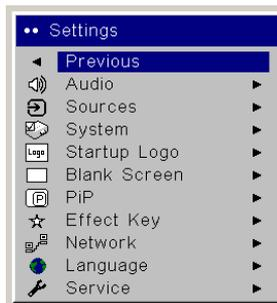

Settings menu

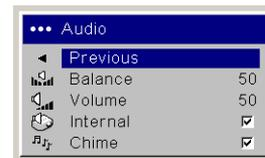

Audio

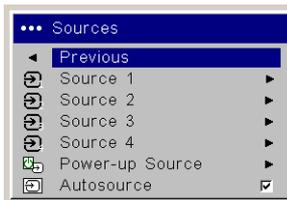

Sources



Powerup Source



System

IR Receivers



IR Receivers

Screen Save: automatically blanks the screen after no signals are detected for five minutes. The image returns when an active source is detected or a remote or keypad button is pressed. Screen Save is disabled when Power Save is enabled.

Startup Logo: allows you to display a blank Black, White, or Blue screen instead of the default screen at startup and when no source is detected. It also allows you to capture and display a custom startup screen.

To capture a custom logo, display the image you want to capture on your computer and select the Logo Capture option. From the **Logo Capture** menu, use the Capture Position X and Capture Position Y adjustments to frame the logo to be captured. Press Capture Start in the **Logo Capture** menu. The projector will let you know if the capture was a success or a failure.

The next time you start the projector, the custom logo you captured displays.

Blank Screen: determines what color is displayed when you press the **Blank** button on the remote.



Screen Save



Startup Logo

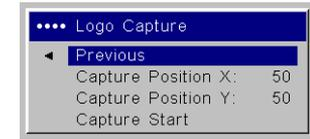

Logo Capture

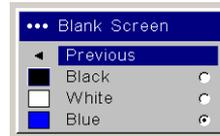

Blank Screen

PiP: (Picture in Picture) allows you to overlay a smaller window showing the video source on top of the larger computer source window. Only video sources 2 and 3 (composite and S-video) support PiP. You must have both a computer and video source connected to use PiP. You can't show a computer image in the smaller PiP window, only a video image. You can select a small, medium, or large window. You can also move the PiP window on the screen using the PiP Position X and Y options, or the Upper left, Upper Right, Lower Left, or Lower Right options in the menu. Press the up and down arrows to change the position.

Effect Key: allows you to assign a different function to the **Effect** button on the remote to quickly and easily use the effect. Only one effect can be enabled at a time. Highlight an effect and press **Select** to choose a different one.

Blank: shows an empty screen.

Mute: turns off all sound.

Aspect Ratio: sets the ratio of the image width to image height.

Source: cycles through the available sources.

Auto Image: causes computer sources to be reacquired.

Freeze: pauses the projected image.

Magnify: Is the default effect. It allows you to enlarge a section of the projected image.

About: displays the About menu.

PiP Source: changes the video source of Picture in Picture smaller window display on the projected screen.



PiP menu

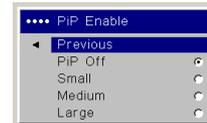

PiP Enable

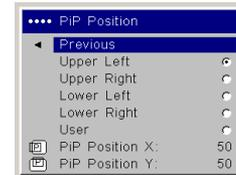

PiP Position

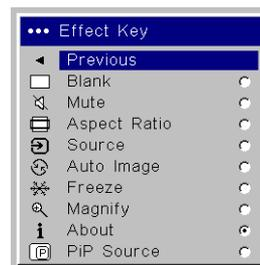

Effect Key

Network: The projector has an RJ45 Ethernet connector that supports network connections and TCP/IP protocols. This will allow for the control and management of the projector over a corporate network. The following fields are accessible when DHCP is not checked and available for manual entry of data.

IP Address: Identifies the projector on the network.

Subnet mask: Separates the network address part of the IP address.

Default gateway: The IP address of the local router.

DHCP: Select this to automatically obtain an IP address, Subnet mask, and Default gateway.

Network Info: Provides information on the network configuration.

The **Network Info** menu is informational and cannot be edited. It displays the current IP Address, Subnet Mask, Default Gateway, and the projector's MAC Address.

Language: allows you to select a language for the onscreen display of menus and messages.

Service: to use these features, highlight them and press **Select**.

Factory Reset: restores all settings (except Lamp Hours and Network settings) to their default after displaying a confirmation dialog box.

Lamp Reset: resets the lamp hours counter in the About menu to zero. Do this only after changing the lamp. It displays a confirmation dialog box.

Filter Reset: resets the filter counter in the About menu to zero. Do this only after cleaning the filter. It displays a confirmation dialog box.

Service Code: only used by authorized service personnel.



Network



Network Info



Language



Service menu

Maintenance

NOTE: When you are performing maintenance activities on your projector, keep in mind that you should only remove screws that are single-slot, or flathead, screws. Any other type of screw, such as a phillips or star should not be removed. These types of screws should only be removed by technical support experts.

Cleaning the lens

- 1 Apply a non-abrasive camera lens cleaner to a soft, dry cloth.
- Avoid using an excessive amount of cleaner, and don't apply the cleaner directly to the lens. Abrasive cleaners, solvents or other harsh chemicals might scratch the lens.
- 2 Lightly wipe the cleaning cloth over the lens in a circular motion. If you don't intend to use the projector immediately, replace the lens cap.

clean the lens
with a soft dry cloth
and non-abrasive
cleaner

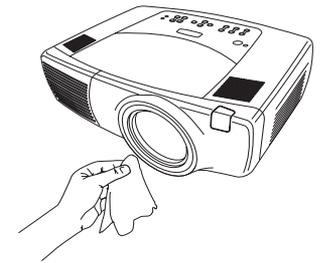

Changing the lens

Long throw and short throw lenses are available with your projector.

- 1 Turn off the projector and unplug the power cable.
- 2 Turn the projector upright with the lens facing upward and use a screwdriver to remove the two screws from the front bezel release holes on the bottom of the projector.
- 3 Lift off the front bezel.
- 4 Gently place a flathead screwdriver into the slot on the top of the projector (it is by the right speaker) and slide the small lever toward the right speaker. The cover that protects the lens and the lamp housing pops up.
- 5 Loosen the captive screw to the door that covers the lens housing.

turn off and unplug
the projector

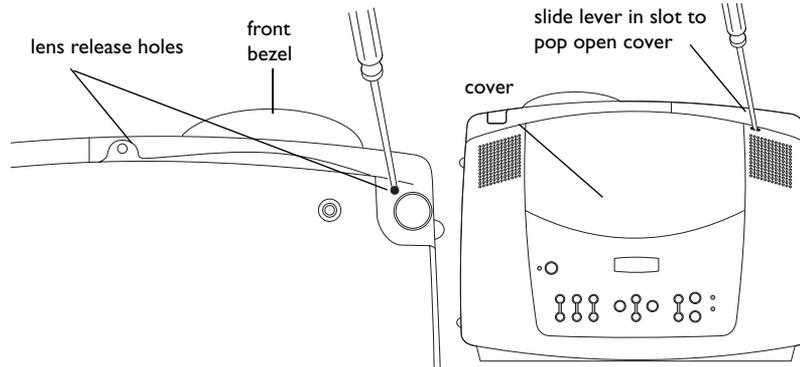
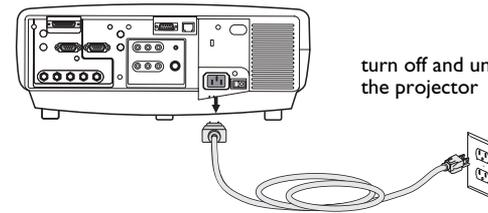

- 6 To remove a lens, push the lever inside the lens housing and turn the lens counterclockwise until it stops. Remove the lens.
- 7 To install a new lens, place it in the opening through the front of the projector, aligning the red dot (near the base of the lens) with the red dot on the projector. Turn clockwise until you feel the lens click into place.
- 8 Tighten the captive screw to the lens housing door. Place the front bezel back onto the projector and replace the two screws on the bottom of the projector. Replace the cover that protects the lens and the lamp housing on top of the projector.

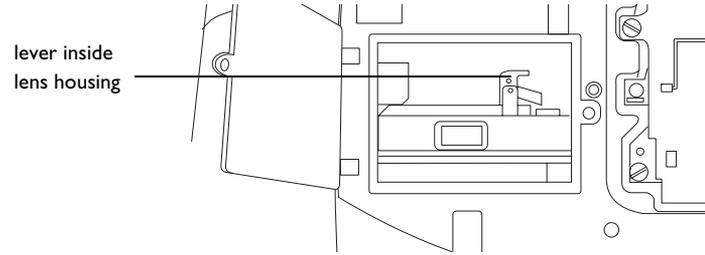

Replacing the projection lamp

The lamp hour timer in the About menu counts the number of hours the lamp has been in use. Twenty hours before the specified end of the lamp's life, the message "Change lamp" briefly appears on the projected screen. You can order new lamp modules from your dealer. See the Accessories catalog that came with the projector or visit our website for information.

About	
Lamp Hours Used	123
Filter Hours Used	123
Active Source	Computer 1
Signal Format	1024x768 - 72Hz
Version	

About menu

- 1 Turn off the projector and unplug the power cable.
- 2 Wait 60 minutes to allow the projector to cool thoroughly.
- 3 Gently place a flathead screwdriver into the slot on the top of the projector (it is by the right speaker) and slide the small lever toward the right speaker. The cover that protects the lamp housing and the lens pops up.

The lamp module is on the right.

- 4 Loosen the three captive screws on the lamp module.

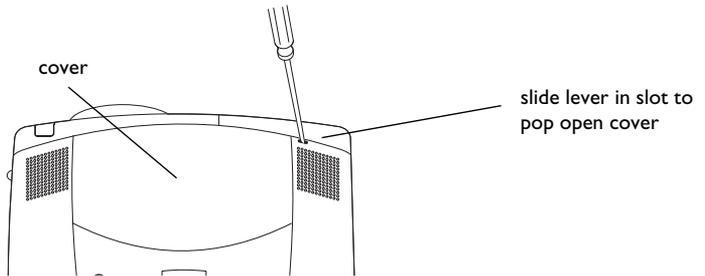
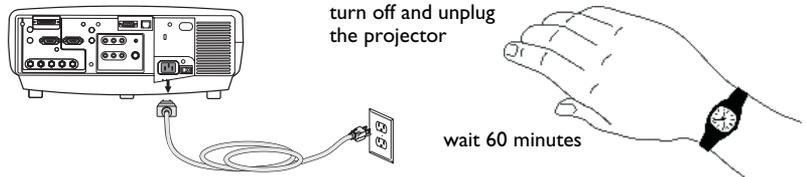

WARNINGS:

- To avoid burns, allow the projector to cool for at least 60 minutes before you replace the lamp.
- Do not drop the lamp module. The glass may shatter and cause injury. Do not touch the glass lamp screen. Fingerprints can obscure projection sharpness.
- Be extremely careful when removing the lamp housing. In the unlikely event that the bulb ruptures, small glass fragments may be generated. The lamp housing is designed to contain these fragments, but use caution when removing the lamp housing. Before replacing the lamp, clean the lamp compartment and dispose of cleaning materials. Wash hands after lamp replacement. This product has a lamp which contains a very small amount of mercury. Dispose of it as required by local, state or federal ordinances and regulations. For more information see www.eiae.org.

- 5 Carefully remove the lamp module by grasping and lifting the metal bail wire. Dispose of the lamp in an environmentally proper manner.
- 6 Install the new lamp module, making sure that it is properly seated, and tighten the three captive screws.
- 7 Replace the cover over the lamp module by inserting the tabs into the tab bays and pushing the rest of the cover down into place.
- 8 Plug in the power cable, press the power switch then press the **Power** button to turn the projector back on. Reset the lamp hour timer.

Resetting the lamp timer

If the lamp timer has reached the maximum number of hours for the projector lamp, the LED on the projector's keypad will show a lamp error (see "LED Behavior" on page 44). To reset the lamp timer, simultaneously press the decrease volume button and increase volume button on the keypad for 10 seconds. At that point the LED will turn green and you can power on the projector. You can also navigate to the **Settings>Service** menu and select **Lamp Reset** to reset the lamp timer.

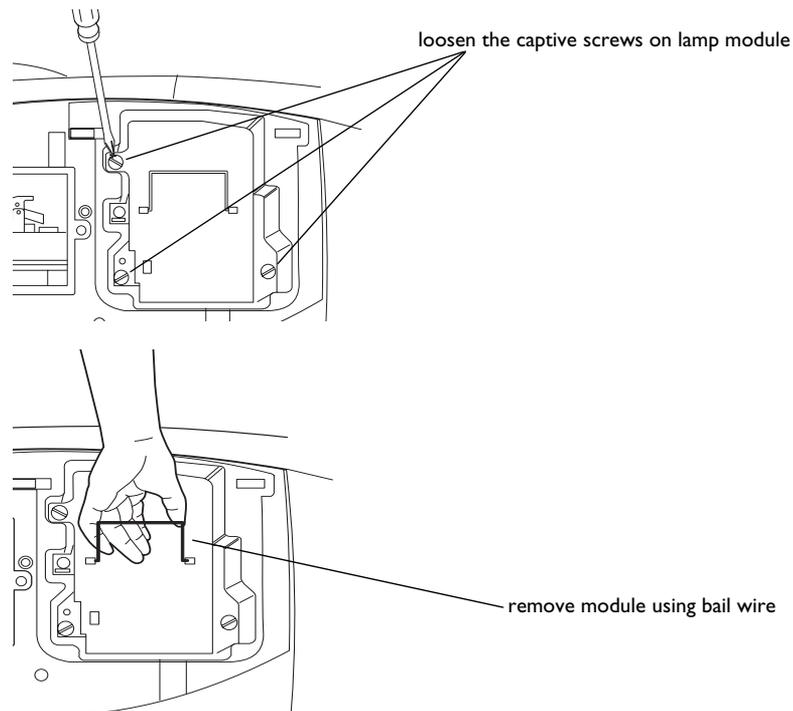

reset lamp time in Service menu

Cleaning the dust filter

- 1 Turn off the projector and unplug the power cable.
- 2 Wait 60 minutes to allow the projector to cool thoroughly.

WARNING: To avoid burns, allow the projector to cool for at least 60 minutes before you clean or replace the dust filter.

- 3 Remove the dust filter grill door on the side of the projector by pulling down on the two tabs at the grill's top.
- 4 Press the tab on the center of the dust filter and lift it off.
- 5 Clean the filter using a vacuum set on low power.
- 6 Replace the dust filter and the dust filter grill door.
- 7 Reset the filter hour timer.

Troubleshooting

If the Temp and Lamp LEDs indicate a problem with the filter, check the following:

- Use a soft cloth to wipe the mirrors on the dust filter grill.
- Remove the dust filter and use a soft cloth to wipe the window behind the dust filter.
- Replace the dust filter and the dust filter grill.

Using the security lock

The projector has a security lock for use with a cable lock system. See the Accessories catalog that came with the projector, or visit our website, for ordering information. Refer to the information that came with the lock for instructions on how to use it.

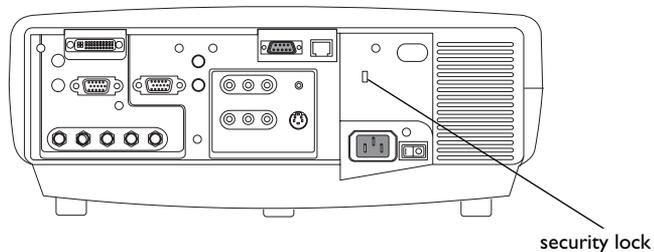
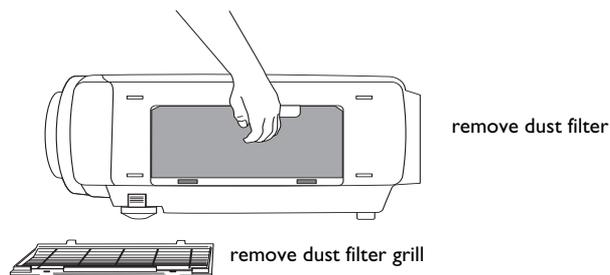
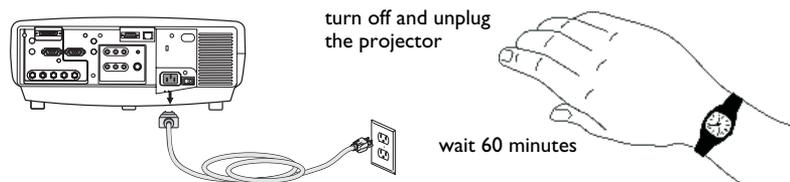

Appendix

Projected image size

NOTE: Visit the Service section of our website for interactive image size calculators for the standard and optional lenses.

Table 1: Projection sizes: Standard lens (1.5 - 2.2:1 throw ratio)

Distance (feet/m)	Minimum Image		Maximum Image	
	Diagonal Image (feet/m)	Image Width (feet/m)	Diagonal Image (feet/m)	Image Width (feet/m)
Min Distance 3/0.9	1.7/0.52	1.46/0.42	2.5/0.76	1.82/0.55
5/1.5	2.84/0.87	2.27/0.69	4.17/1.27	4.55/1.39
10/3.0	5.68/1.73	4.46/1.36	8.33/2.54	6.56/2.00
20/6.1	11.36/3.46	9.09/2.77	16.67/5.08	13.33/4.06
30/9.1	17.05/5.2	13.64/4.16	25.0/7.62	20.0/6.10
40/12.2	22.73/6.93	18.18/5.54	33.33/10.16	26.67/8.13
Max Distance 45.5/13.9	25.85/7.88	20.68/6.20	37.92/11.56	30.33/9.25

The image offset range for the standard lens is 10:1 (100%) to 1:1 (50%).

LED Behavior

LED color/behavior	Meaning
Power: blinking green Temp: N/A Lamp: N/A	The power switch has been toggled on and the software is initializing, or the projector is powering down and the fans are running to cool the lamp.
Power: blinking green (once) Temp: N/A Lamp: N/A	Power Save or Screen Save.
Power: solid green Temp: N/A Lamp: N/A	The power switch has been toggled on and the software has initialized or the projector has been powered off via the remote.
Power: solid green Temp: blinking red Lamp: blinking red	<p>If Temp and Lamp are flashing simultaneously, the filter hasn't been cleaned in 100 hrs.</p> <p>If Temp and Lamp are flashing simultaneously (twice), the cooling air filter may be dusty. Please see "Cleaning the dust filter" on page 42.</p> <p>If Temp and Lamp are flashing alternately, the projector is below temperature specifications. Please use the projector in an environment between 0°C/32°F to 35°C/95°F. Contact Technical Support if the problem persists.</p>

Power: solid red Temp: N/A Lamp: blinking red	<p>Lamp won't strike (blinks one time) Lamp has exceeded lamp hours limit (blinks two times) Lamp has failed (blinks three times) Lamp door is open (blinks four times)</p> <p>Turn off the projector and wait one minute, then turn the projector on again. If the projector has exceeded its lamp life limit, replace the lamp and reset the lamp timer. Please contact Technical Support if the problem persists.</p>
Power: solid red Temp: blinking red Lamp: N/A	Fan failure. Make sure the vents aren't blocked. Contact Technical Support if the problem persists.
Power: solid red Temp: solid red Lamp: N/A	The projector is overheating. Make sure the vents aren't blocked. Contact Technical Support if the problem persists.
Power: solid red Temp: N/A Lamp: N/A	Unidentified error. Please contact Technical Support.

RS-232 commands

Communication Configuration

Visit our website for additional RS-232 settings and information.

To control this projector via RS-232, connect a null modem cable and set the control system serial port settings to match the following communication configuration:

RS-232 Port Settings	
Setting	Value
Bits per second	19,200
Data bits	8
Parity	None
Stop bits	1
Flow control	None
Emulation	VT100

Command Format

All commands consist of 3 alpha characters followed by a request, all enclosed in parentheses. The request can be a read request (indicated by a "?") or a write request (indicated by 1 to 4 ASCII digits).

A read request example:

(AAA?) where

(starts the command

AAA denotes the command

? denotes the read request

) ends the command

A read command returns the range and the current setting, for example:

Read Command Examples		
Function	Command	Response
Brightness	(BRT?)	(96-160,128)
Volume	(VOL?)	(0-32, 0)
Lamp Hours	(LMP?)	(0-65534, 42)

A write request example:

(AAA####) where

(starts the command

AAA denotes the command

denotes the value to be written

(leading zeros not necessary)

) ends the command

Some commands have ranges, while others are absolute. If a number greater than the maximum range is received, it is automatically set to the maximum number for that function. If a command is received that is not understood, a "?" is returned. With absolute settings, "0" is off, 1-9999 is on. The one exception is the Power command, where 0 is off and 1 is on.

To assure the projector can process a command, wait 3 seconds before entering the next command.

Write Command Examples

Function	Command	Response
Brightness	(BRT 40)	Sets the brightness to 140
Power	(PWRO)	Turns power off
Power	(PWRI)	Turns power on

Error Conditions

Not all commands are supported for all projectors. If an unsupported command is issued, the command will be ignored. If a command is received that is not understood, a '?' character will be returned indicating the command was not understood.

Limitations

The projector cannot respond to commands coming in at a high-rate. Therefore, a delay must occur between commands to ensure that the command gets properly executed. To assure the projector can process a command, wait 3 seconds before entering the next command.

The Step column refers to increasing or decreasing the menu bar position since the On-screen Display is not an exact match of values. For example, Step 2 changes the data by 2 through the CLI (Command Line Interface). The menu bar is up (or down) by 1.

Function	Command	Min	Max	Default	Step
About 0: disable 1: enable	ABT at WW	0	1	n/a	
Aspect Ratio 0: Native 1: 16:9 2: 4:3	ARZ at RW	0	2	2	
Auto Image 0: disable 1: enable	AIM at WW	0	1	n/a	
Auto Power 0: disable 1: enable	APO at RW	0	1	0	
Auto Source 0: disable 1: enable	ASC at RW	0	1	1	
Balance	BAL at RW	0	100	50	1
Blank 0: off 1: on	BLK at RW	0	1	0	
Blank Screen 0: black 1: blue 2: white	BSC at RW	0	2	1	
Blue Gain	BCG at RW	0	100	50	2

Brightness	BRT at RW	96	160	128	1
Ceiling 0: disable 1: enable	CEL at RW	0	1	0	
Chime 0: disable 1: enable	ACE at RW	0	1	1	
Color	CLR at RW	65	191	128	1
Color Space 0: RGB 1: SMPTE240 2: REC709 3: REC601 7: Auto	CSM at RW	0	7	7	
Color Temp 0: 9300K 1: 6500K 2: 7200K 3: User	TMP at RW	0	3	2	
Contrast	CON at RW	96	160	128	1
Display Messages 0: disable 1: enable	DMG at RW	0	1	1	1

Effect 0: blank 1: mute 2: aspect ratio 3: source 4: auto image 5: freeze 6: zoom 7: about 8: PiP Source	EFK at RW	0	8	7	1
Factory Reset 0: not reset 1: reset	RST at W	0	1	n/a	
Filter Reset 0: not reset 1: reset	FRT at W	0	1	n/a	
Freeze 0: disable 1: enable	FRZ at RW	0	1	0	
Green Gain	GCG at RW	0	100	50	2
Horizontal Keystone	DKH at RW	78	178	128	1
Horizontal Position	HPS at RW	def: -50	def: +50	auto	1
Internal Sound Enable 0: disable 1: enable	INT at RW	0	1	1	
IR Receiver front 0: disable 1: enable	IRF at RW	0	1	1	

IR Receiver rear 0: disable 1: enable	IRR at RW	0	1	1	
IR Receiver top 0: disable 1: enable	IRT at RW	0	1	0	
Language 0 = English 1 = French 2 = German 3 = Spanish 4 = Traditional Chinese 5 = Japanese 6 = Korean 7 = Portuguese 8 = Russian 9 = Norwegian 10 = Simplified Chinese 11 = Italian	LAN at RW	0	11	0	1
Lamp Hours	LMP at R	0	32766	0	1
Lamp Lit 0: not lit 1: lit	LML at R	0	1		
Lamp Reset 0: not reset 1: reset	LRT at W	0	1	n/a	
Number of Lamp Resets 0: not reset 1: reset	LMR at R	0	32766	0	1

Lamp Total On Time (All Bulbs)	LMT at R	0	214748 3646		
Time In Hours Last Bulb1 Lasted	LB1 at R	0	32766	0	
Time In Hours Last Bulb2 Lasted	LB2 at R	0	32766	0	
Time In Hours Last Bulb3 Lasted	LB3 at R	0	32766	0	
Low Power 0: disable 1: enable	LPE at RW	0	1	0	
Magnify	MAG at RW	0	48	0	1
Magnify Enable 0: disable 1: enable	MGE at RW	0	1	n/a	
Magnify Position Horizontal	MPH at RW	128	896	512	1
Magnify Position Vertical	MPV at RW	96	672	384	1
Menu 0: disable 1: enable	MNU at RW	0	1	0	
Menu Navigation 0: up 1: down 4: select	NAV at W	0	4	n/a	
Motorized Focus Far	MFF at W	0	100	0	1

Motorized Focus Near	MFN at W	0	100	0	1
Motorized Vertical Down	MVD at W	0	100	0	1
Motorized Vertical Up	MVU at W	0	100	0	1
Motorized Zoom In	MZI at W	0	100	0	1
Motorized Zoom Out	MZO at W	0	100	0	1
Mute 0: disable 1: enable	MTE at RW	0	1	0	
NND 0: disable 1: enable	NND at RW	0	1	1	
Overscan 0: disable 1: enable	OVS at RW	0	1	0	
Phase	MSS at RW	0	31	16	1
PiP Input 3: video 2 4: video 3	PIN at RW	3	4	3	
PiP Position 0: upper left 1: upper right 2: lower left 3: lower right 4: user	PPO at RW	0	4	2	

PiP Size Selection 0: off 1: small 2: medium 3: large	PSS at RW	0	3	0	
Power 0: disable 1: enable	PWR at RW	0	1	0	
Power Save 0: disable 1: enable	PSV at RW	0	1	0	
Power-up Source 0: computer 1 1: computer 2 2: video 1 3: video 2 4: video 3 5: computer 3	DSC at RW	0	5	0	
Presets 0: presentation 1: photography 2: film 3: video 10: user 1 11: user 2 12: user 3	PST at RW	0	12	c: 0 v: 3	
Rear 0: disable 1: enable	REA at RW	0	1	0	
Red Gain	RCG at RW	0	100	50	2

Save User 1 0: not saved 1: saved	US1 at W	0	1	n/a	
Save User 2 0: not saved 1: saved	US2 at W	0	1	n/a	
Save User 3 0: not saved 1: saved	US3 at W	0	1	n/a	
Screen Save 0: 5 minutes 1: 10 minutes 2: 15 minutes 3: 20 minutes 4: 25 minutes 5: 30 minutes	SSV at RW	0	5	0	1
Sharpness 5 = Sharpest 6 = Sharper 7 = Standard 8 = Softer 9 = Softest	SHP at RW	5	9	7	1
Source 0: computer 1 1: computer 2 2: video 1 3: video 2 4: video 3 5: computer 3	SRC at RW	0	5	0	

Source 1 0: computer 1 1: computer 2 2: video 1 3: video 2 4: video 3 5: computer 3	SR1 at RW	0	5	0	
Source 2 0: computer 1 1: computer 2 2: video 1 3: video 2 4: video 3 5: computer 3	SR2 at RW	0	5	1	
Source 3 0: computer 1 1: computer 2 2: video 1 3: video 2 4: video 3 5: computer 4	SR3 at RW	0	5	2	
Source 4 0: computer 1 1: computer 2 2: video 1 3: video 2 4: video 3 5: computer 5	SR4 at RW	0	5	3	
Startup Logo 0: blank screen 1: default 2: captured	DSU at RW	0	2	1	

Tint	TNT at RW	114	142	128	1
Tracking	MTS at RW	def: -128	def: +128	auto	1
Unit Total Time On	ONL at R	0	214748 3646	0	
Vertical Keystone	DKC at RW	78	178	128	1
Vertical Position	VPS at RW	0	def: auto x 2	auto	1
Video Standard 0: Auto 1: NTSC 2: PAL 3: SECAM	VSU at RW	0	3	0	
Volume	VOL at RW	0	32	16	1

INDEX

Numerics

1024x768 resolution 5

A

About 37

Aspect Ratio 37

audio 28

Audio In connector 8, 14

Auto Image 37

Auto Power 35

Autosource 35

B

Blank 37

BNC 9, 15

BNC connectors 15

Brightness 13

C

Capture Position 36

Capture Start 36

changing the lens 39

cleaning the dust filter 42

cleaning the lens 39

Color 17

colors are incorrect 23

component cable connector 14

computer 9

computer connections

 optional 8

 required 8

computer image

 optimize 29

 troubleshooting 19

connector panel 6

contacting InFocus 25

Contrast 13, 17

custom logo startup screen 36

D

Default gateway 38

DHCP 38

Display Messages 35

displaying

 computer image 10

 PiP 37

 video image 16

Drivers 11

 USB 12

 Windows 98 12

dust filter, cleaning 42

E

Effect Key 37

elevator foot 13, 16

F

Factory Reset 38

Filter Reset 38

first time use

 driver installation 11

focus 13, 17

Freeze 37

fuzzy image 21

H

HDTV sources 14, 15

I
image
 display computer 10
 display video 16
 size 7
image does not fit screen 22
image not centered 25
image not sharp 22
image not square 22
image reversed 23
image size matrix 43
image upside down 23
Info
 network 38
IP Address 38
IR Receivers 35
L
lamp replacement 40
Lamp Reset 38
lamp won't turn on 24
Language 38
laptop
 connecting 8
 external video port 10
LED 18
 blinking red 24
 solid red 24
lens
 changing 39
 cleaning 39
Logo Capture 36
Low Power 35

M
Magnify 37
Main menu 31
menu system 31
Monitor connector 9
mouse, using your 8
Mute 37
N
Network 38
Network connector 9
Network Info 38
NND 35
no computer image 20
no startup screen 19
O
only startup screen appears 19
Overscan 34
P
Picture in Picture 37
Picture menu 32
PiP 37
Power button 16
power cable 8, 14
Power Save 35
Power-up Source 35
presentation features 29
projection distance 7
projector
 connector panel 6
 customizing 30
 positioning 7
 setting up 7
 shutdown 18
 troubleshooting problems 18
projector height 13, 16
projector positioning 13, 16

R
Rear 35
remote 8
remote control 27
 not working 21
replacing the lamp 40
RS-232
 cable 9
 connecting 6

S
security lock 42
Serial connection 9
serial connection 6
Service 38
Service Code 38
Settings menu 35
shutdown
 projector 18
solid red 44
Source 37
Source troubleshooting 19
Sources 35
Subnet mask 38
S-video connector 14

T
Tint 17
Troubleshooting 19
troubleshooting 18

U
USB, using your mouse 8

V
video 15
Video button 16
video connections
 optional 14
 standard 14
Video connector 14
video images
 optimizing 30
Video Standard 34
volume adjustment 17

W
warranty 25
Windows 2000 12
Windows 98 11
Windows ME, XP 12
wired 8
wired remote 8

X
XGA 5

Z
zoom 13, 17

Limited Warranty

Subject to the Limitations, Exclusions and Disclaimers hereof, InFocus Corporation (“InFocus”) warrants that the Projector, Lamps and Accessories (hereinafter collectively or individually referred to as “Product” as appropriate) purchased from InFocus, an InFocus distributor, or an InFocus reseller will conform to InFocus’ specifications and be free from defects in material or workmanship for the respective Limited Warranty period provided below. This warranty statement applies only to the specific InFocus product purchased. InFocus products are compatible with many systems, however the specific functional implementation by the customers of the product may vary. The suitability of a product for a specific purpose or application must be determined by the customer and is not warranted by InFocus Corporation. If the Product, while subject to this Limited Warranty, is defective in material or workmanship during the warranty period, then InFocus, at its option, will REPAIR or REPLACE the Product.

All exchanged parts and Products replaced under this Limited Warranty will become property of InFocus. InFocus’ sole obligation is to supply (or pay for) all labor necessary to repair the Product found to be defective within the Limited Warranty period and to repair or replace defective parts with new parts or, at the option of InFocus, serviceable used parts that are equivalent or superior to new parts performance. Limited Warranty periods are as follows:

- **Projector Product Limited Warranty Period (Excluding Lamps): Two (2) years** from date of proof of purchase.
- **Lamp Product Limited Warranty Periods:** The original installed lamp shall have a ninety (90) day Limited Warranty Period from date of Projector proof of purchase, and replacement Lamps will have a ninety (90) day limited warranty from date of lamp proof of purchase, and replacement lamps purchased at the time of Projector Product purchase will have a ninety (90) day limited warranty from date of first use.
- **Accessory Product Limited Warranty Period: ninety (90) days** from date of purchase.

WARRANTY LIMITATION AND EXCLUSION

THIS WARRANTY SETS FORTH INFOCUS’ MAXIMUM LIABILITY FOR ITS PRODUCT. THIS WARRANTY EXTENDS ONLY TO PRODUCTS PURCHASED FROM INFOCUS OR AN INFOCUS AUTHORIZED RESELLER. InFocus shall have

no further obligation under the foregoing Limited Warranty if the Product has been damaged due to abuse, improper ventilation, fire, water, disaster, mispackaging, shipping, lightning or other acts of nature, misuse, neglect, smoke exposure (cigarette or otherwise), accident, unusual physical or electrical stress and/or power surges, unauthorized modifications (including use of an unauthorized mount), tampering, alterations, service other than by InFocus or its authorized agents, or failure caused other than from ordinary use or failure to properly use the Product in the application for which said Product was intended. In addition, failure of the end-user to follow maintenance procedures as outlined in the product’s user guide where a schedule is specified for regular cleaning of certain parts (based on usage and environment), will not be covered under this Warranty. Finally, InFocus shall have no further obligation if the Product was subjected to operating conditions outside of the range specified in the user’s guide or in this Warranty. Normal operating conditions are defined as use not in excess of 16 hours continuously per day with a minimum 8 hour period of continuous rest in the powered off state. If a claimed defect cannot be identified or reproduced in service, you will be held responsible for the costs incurred. This Limited Warranty excludes Product cleaning, removal or installation of the Product, repair, or replacement of plastics due to cosmetic damage and damage as a result of normal wear. Product repair outside of the terms of the Limited Warranty will be on a time and materials basis. InFocus will not be liable for any rental costs incurred in the event of a failure. The Warranty does not apply to cartons, carrying cases, shipping cases, external cabinets, accessories used in connection with the product, or cosmetic parts, knobs, or batteries. The Warranty period for LCD engines is either 2 years from the date of purchase of the projector or 2500 hours of projector usage, whichever comes first. If the LCD engine requires replacement and the projector has exceeded 2500 hours, but is otherwise eligible for Warranty, this Warranty will cover the cost of labor, but not the cost of parts that require replacement.

The Accessory Product Limited Warranty covers the accessory item only and excludes normal wear. The Lamp Product Limited Warranty excludes expected lamp degradation and InFocus will not be liable for normal decrease in lamp output over time or as lamp is consumed under the Limited Warranty.

Remanufactured Products and Software Products are exempt from the foregoing Limited Warranty. Please refer to the appropriate Remanufactured Product Limited Warranty or Software Product Limited Warranty for applicable Warranty information.

DISCLAIMER OF UNSTATED WARRANTIES

THE WARRANTY PRINTED ABOVE IS THE ONLY WARRANTY APPLICABLE TO THIS PRODUCT. ALL OTHER WARRANTIES, EXPRESS OR IMPLIED, INCLUDING, BUT NOT LIMITED TO, THE IMPLIED WARRANTIES OF MERCHANTABILITY AND FITNESS FOR PARTICULAR PURPOSE ARE DISCLAIMED. THERE ARE NO WARRANTIES THAT EXTEND BEYOND THE DESCRIPTION ON THE FACE HEREOF AND THE FOREGOING WARRANTY SHALL NOT BE EXTENDED, ALTERED OR VARIED EXCEPT BY WRITTEN INSTRUMENT SIGNED BY INFOCUS. SOME JURISDICTIONS DO NOT ALLOW LIMITATIONS ON HOW LONG AN IMPLIED WARRANTY MAY LAST, SO SUCH LIMITATIONS MAY NOT APPLY TO YOU.

Limited Warranty Period

The Limited Warranty periods hereof commence on the date of proof of purchase by the end-user customer. These Limited Warranty provisions shall apply only to the end-user purchaser (first person or entity that purchased a new Product for personal or business use and not for the purpose of distribution or resale). SOME JURISDICTIONS MAY GRANT YOU CONSUMER RIGHTS WITH MINIMUM WARRANTY DURATION THAT DIFFER FROM THE DURATIONS PROVIDED HEREIN, AND INFOCUS WILL HONOR ALL SUCH CONSUMER RIGHTS UPON PROOF OF PURCHASE IN THAT JURISDICTION.

To Be Eligible For Limited Warranty Coverage

Any person exercising a claim under this Limited Warranty must establish to the satisfaction of InFocus both the date of purchase and that the Product was purchased new. The sales receipt or invoice, showing the date of purchase of the Product is the proof of the date of purchase.

To Obtain Warranty Service

During the Limited Warranty period, to exercise this Limited Warranty, the purchaser must first contact 1) InFocus, 2) a service facility authorized by InFocus or 3) the place of original purchase.

InFocus Customer Service in the Americas 1-800-799-9911 or 503-685-8888 or www.infocus.com/service, In Europe, Middle East, and Africa +31 (0) 20 579 2820, and in Asia Pacific +65 6353 9449.

For Warranty service, the purchaser will pay to return or deliver the defective Product and will pay all freight, duty, taxes, VAT, fees, incidental clearance and customs charges to ship the unit to an InFocus Service Center or to a service facility authorized

by InFocus. When returning Product to InFocus, a Return Material Authorization Number (RMA #) is required and must be clearly displayed on the outside of the shipping carton or a similar package affording an equal degree of protection. InFocus or the service facility authorized by InFocus will return the repaired/replaced Product freight prepaid to the purchaser.

Products returned for Warranty service must be accompanied by a written letter that: (i) explains the problem; (ii) provides proof of date of purchase; (iii) provides the dealer's name; and (iv) provides the model and serial number of the Product. Upon request of InFocus Corporation or an authorized repair center for InFocus, proof of legal import must accompany the warranty repair Product, otherwise the Product must be returned to the place of original purchase, to the manufacturer (Purchaser must bear all tax, duty and freight), or the Purchaser must bear charges for the warranty repair.

No repair or replacement of Product or part thereof shall extend the Limited Warranty period as to the entire Product. Warranty on the repair part and workmanship shall only be effective for a period of ninety (90) days following the repair or replacement of that part or the remaining period of the Product Limited Warranty whichever is greater. InFocus' or its authorized service center's policies shall apply and the Consumer will be charged accordingly for product returned to an InFocus Authorized Service Center after the expiration of the warranty period.

LIMITATION OF LIABILITY

IT IS UNDERSTOOD AND AGREED THAT INFOCUS' LIABILITY SHALL NOT EXCEED THE RETURN OF THE AMOUNT OF THE PURCHASE PRICE PAID BY PURCHASER Where applicable national law prohibits the exclusion or limitation of liability, InFocus excludes or limits its liability to the maximum extent permitted by national law.

Limitation on Bringing Action - No action, regardless of form, arising out of the agreement to purchase the Product may be brought by purchaser more than one year after the cause of action has accrued.

Governing Law - Any action, regardless of form, arising out of the agreement to purchase the Product is governed by the laws of the state of Oregon, USA.

Mandatory Arbitration - Any action, regardless of form, arising out of the agreement to purchase the Product is subject to mandatory arbitration. THIS WARRANTY DOES NOT AFFECT YOUR LEGAL RIGHTS UNDER APPLICABLE NATIONAL LAWS RELATING TO THE SALE OF CONSUMER PRODUCTS.

IF YOU NEED ASSISTANCE....

For all types of Service and Support information on InFocus products and services please go to our web site at www.infocus.com/service.

Many resources are available on our website.
Some examples are:

- Frequently Asked Questions about general projector usage and technical issues
- How To Guides with complete details on connecting specific types of equipment like home theater components, digital cameras and gaming consoles
- E-mail support
- Online product registration
- Product data sheets
- Optional accessories
- Technical specifications, interactive image size calculator, laptop activation commands and more!

InFocus®

LP®840/LP®850/LP®860 INSTALLATION & INTEGRATION PROJECTOR.

USER'S GUIDE



InFocus®

InFocus Corporation

27700B SW Parkway Avenue
Wilsonville, Oregon 97070-9215
1-800-294-6400 • 503-685-8888
Fax: 503-685-8887
<http://www.infocus.com>

In Europe:

InFocus International BV
Strawinskylaan 585
1077 XX Amsterdam
The Netherlands
Phone: +31 20 579 2000
Fax: +31 20 579 2999

In Asia:

InFocus Systems Asia Pte Ltd.
238A Thomson Road
#18-01/04 Novena Square
Singapore 307684
Telephone: (65) 6334-9005
Fax: (65) 6333-4525



010-0512-02