

myprojectorlamps.com

**The most trusted, dependable name
in projector lamp sales.**



<http://www.myprojectorlamps.com>



<http://www.myprojectorlamps.ca>



<http://www.myprojectorlamps.eu>

The following projector manual has not been modified or altered in any way.

USER'S GUIDE



InFocus®



Declaration of Conformity

Manufacturer: InFocus Corporation, 27700B SW Parkway Avenue, Wilsonville, Oregon 97070 USA

European Office: Strawinskylaan 585, 1077 XX Amsterdam, The Netherlands

We declare under our sole responsibility that this projector conforms to the following directives and norms:

EMC Directive 89/336/EEC, Amended by 93/68/EEC

EMC: EN 55022

EN 55024

EN 61000-3-2

EN 61000-3-3

Low Voltage Directive 73/23/EEC, Amended by 93/68/EEC

Safety: EN 60950: 2000

May, 2004

Trademarks

Microsoft, PowerPoint, Word, Excel and Windows are trademarks or registered trademarks of Microsoft Corporation. Adobe and Acrobat are trademarks or registered trademarks of Adobe Systems Incorporated. InFocus, LiteShow, LitePort, and LP are trademarks or registered trademarks of InFocus Corporation.

FCC Warning

This equipment has been tested and found to comply with the limits for a Class A digital device, pursuant to part 15 of the FCC Rules. These limits are designed to provide reasonable protection against harmful interference when the equipment is operated in a commercial environment. This equipment generates, uses, and can radiate radio frequency energy and, if not installed and used in accordance with the instruction manual, may cause harmful interference to radio communications. Operation of this equipment in a residential area is likely to cause harmful interference in which case the user will be required to correct the interference at his own expense.

EN 55022 Warning

This is a Class A product. In a domestic environment it may cause radio interference, in which case the user may be required to take adequate measures. The typical use is in a conference room, meeting room or auditorium.

Canada

This Class A digital apparatus complies with Canadian ICES-003.

Cet appareil numérique de la classe A est conforme à la norme NMB-003 du Canada.

Agency Approvals

UL, CUL, TUV, GOST

Other specific Country Approvals may apply, please see product certification label.

This user's guide applies to models LP600 and GEN205.

InFocus reserves the right to alter product offerings and specifications at any time.

Table of Contents

Introduction	5
Connecting a computer	7
Required computer connections	7
Displaying a computer image	9
First-time projector use with Windows 98	10
Adjusting the image	12
Connecting a video device	13
Displaying a video image	14
Shutting down the projector	16
Troubleshooting your setup	16
Using the keypad buttons	25
Using the remote control	26
Using the LitePort player	27
Using the audio	28
Optimizing computer images	29
Presentation features	29
Optimizing video images	29
Customizing the projector	29
Using the menus	30
Picture menu	31
Settings menu	34
Maintenance	39
Cleaning the lens	39
Using the security lock	39
Replacing the projection lamp	40
Cleaning the lamp filter screens	42
Appendix	43
Accessories	43
Red LED behavior and projector errors	44
Projected image size	44

If you are experienced in setting up presentation systems, use the included *Quick Set Up* card. For complete details on connecting and operating the projector, refer to this User's Guide. Electronic versions of this User's Guide in multiple languages are available on the included CD. The most current versions can be found on our website.

The website also has technical specifications (an interactive image size calculator, laptop activation commands, connector pin outs, a glossary, the product data sheet), a web store to buy accessories, and a page for online registration. See the inside of the back cover for a list of all relevant web addresses.

Important Operating Considerations for Safety

- Place the projector in a horizontal position no greater than 15 degrees off axis.
- Locate the projector in a well-ventilated area without any obstructions to intake or exhaust vents. Do not place the projector on a tablecloth or other soft covering that may block the vents.
- Locate the projector at least 4' (1.2 m) away from any heating or cooling vents.
- Use only InFocus-approved ceiling mounts.
- Use only the power cord provided. A surge-protected power strip is recommended.
- Refer to this manual for proper startup and shutdown procedures.
- In the unlikely event of the lamp rupturing, discard any edible items placed in the surrounding area and thoroughly clean the area along all sides of the projector. Wash hands after cleaning the area and handling the ruptured lamp. This product has a lamp which contains a very small amount of mercury. Dispose of it as required by local, state or federal ordinances and regulations. For more information see www.eiae.org.

Follow these instructions to help ensure image quality and lamp life over the life of the projector. Failure to follow these instructions may affect the warranty. For complete details of the warranty, see the Warranty section at the end of this user's guide.

Do not place objects or people in the 2 foot (.6m) area along the side of the projector. For ceiling mount applications, this area should be 5 feet (1.5m).

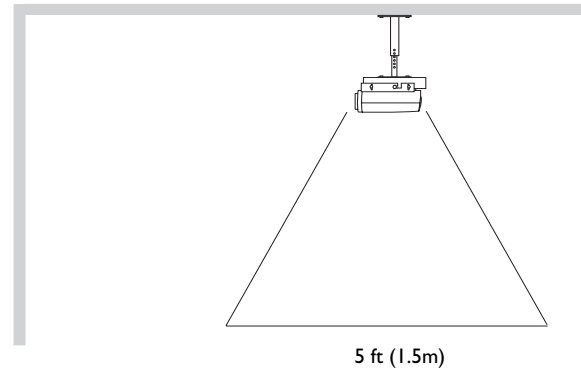
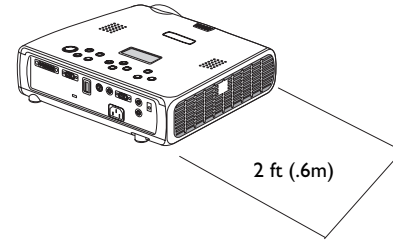

Introduction

Your new digital projector provides computer and video inputs and has XGA 1024x768 resolution. The projector is easy to connect, easy to use, and easy to maintain. An Interactive Display on the top of the projector gives you constant feedback on the status of the projector.

Online Registration

Register your projector on our website to receive product updates, announcements, and registration incentives. See the inside of the back cover for the web address.

Included items

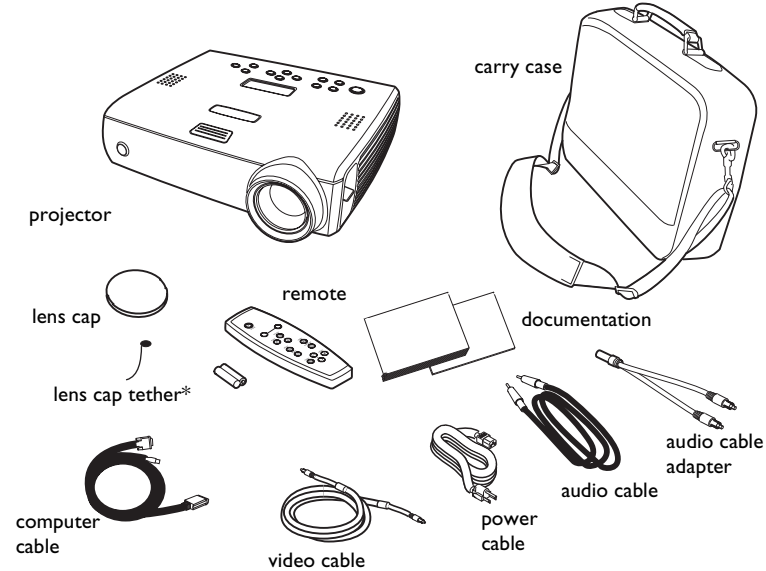

*The lens cap tether ships in the Documentation Pack. Attach it to the lens cap and the projector if desired.

Projector components and features

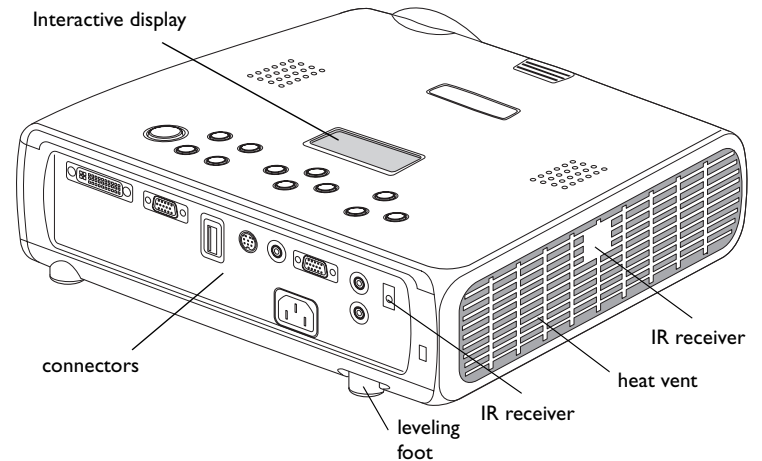
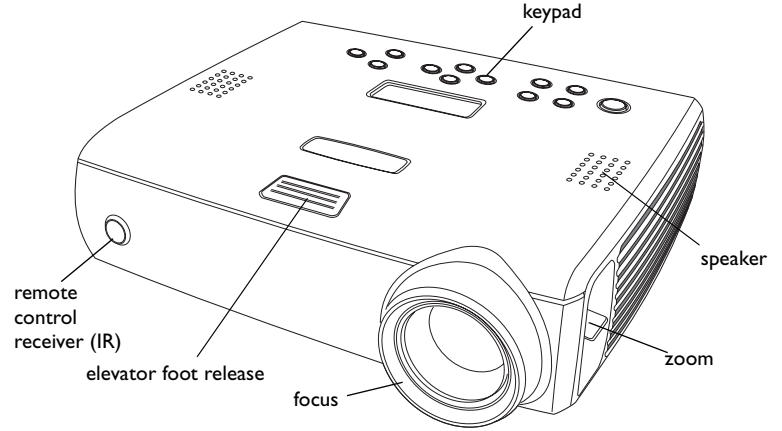

Connector Panel

The projector provides computer and video connectors:

- one M1-D/A (HD, DVI, and computer)
- one VESA (HD, HD component, and computer)
- one S-video
- one composite RCA video
- one audio in/one audio out

It also has an RS-232 serial connector for serial control. The Command Line Interface (CLI) specifications and commands are on our website.

The projector also has a LitePort™ USB connector (Type A) and player for JPEG (Joint Photographic Experts Group, .jpg, .jpe, or .jpeg) images. This allows you to display any JPEG image automatically, without a computer connected. Use your own JPEGs from your digital camera, or convert your files, such as Microsoft® PowerPoint™, Word™, or Excel™ files, into JPEGs using LitePort Utility software (included on the CD), which allows you to easily generate the highest quality JPEG images possible. Then transfer the JPEG images from your computer to the projector using a USB mass storage device and your images are ready to be displayed. (Please refer to the Service and Support section of our website for advanced specifications on the USB device and JPEG files.) You can use the remote control to select which JPEGs to view (page 27) or you can set up the LitePort player using the LitePort onscreen menu to select display preferences and automatically display and advance your JPEGs (page 36).

Wireless Projection

You can use the projector's M1 connector along with the InFocus® LiteShow® wireless adapter and software for cable-free digital projection. Contact an authorized InFocus dealer or visit the website listed on the back inside cover of this User's Guide for more information.

Connector panel

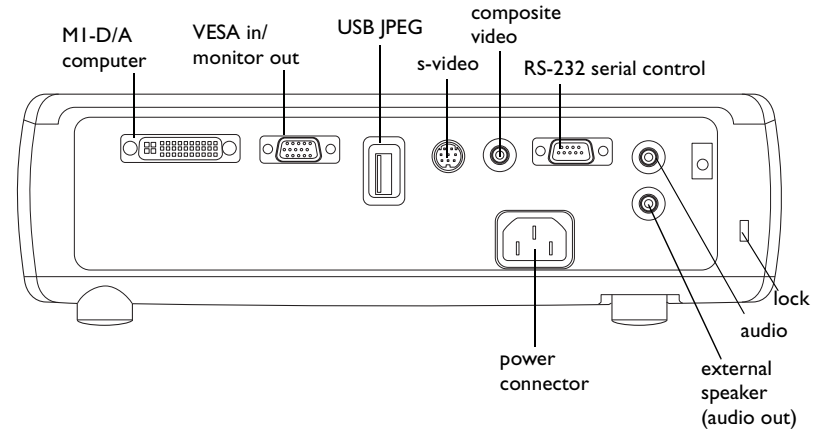

Connecting a computer

Required computer connections

Connect the black end of the computer cable to the **Computer I** connector on the projector. Connect the blue end to the video port on your computer. If you are using a desktop computer, you first need to disconnect the monitor cable from the computer's video port.

Some Macintosh® computers do not have a standard VESA-out video port. If the supplied computer cable will not connect to your computer, purchase the appropriate adapter from your Apple® reseller.

Connect the black power cable to the connector on the back of the projector and to your electrical outlet.

The Power LED on the projector's keypad turns solid green.

NOTE: Always use the power cable that shipped with the projector.

connect computer cable

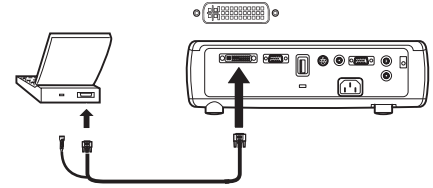

connect power cable

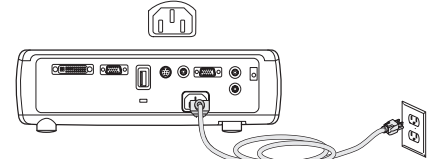

Optional computer connections

To advance slides in a PowerPoint™ presentation using the remote, plug the USB connector on the computer cable into the USB mouse connector on your computer. USB drivers must be installed to use the USB feature. For more information, see page 11.

connect computer cable

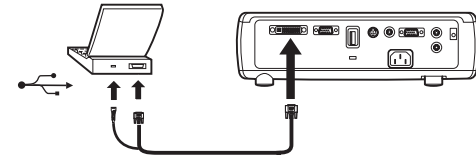

To have sound with your presentation, connect the audio cable to your computer and to the **Audio In** connector on the projector.

connect audio cable

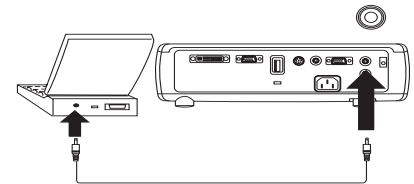

If you are using a desktop computer and want to see the image on your computer screen as well as on the projection screen, plug the monitor cable to the black **Computer 2** connector on the projector. This connector can be used as monitor out or VESA in. The default is VESA in, so you must change this option in the menu to use monitor out. See page 34 to switch between the two functions.

connect monitor cable

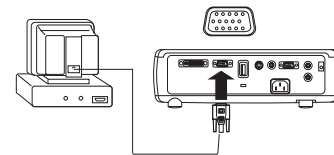

If you prefer connecting your projector to your computer with an optional VESA cable, connect one end of the cable to the VESA port on your computer, and connect the other end of the cable to the blue **Computer 2** connector on the projector.

connect VESA cable

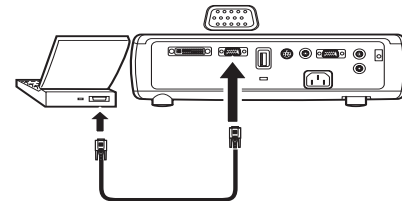

This connector can be used as monitor out or VESA in. The default is VESA in.

You can control the projector from an LCD control panel or computer by connecting an RS-232 cable to the projector's **Serial Control** connector. Specific RS-232 commands can be found in the Service and Support section of our website.

connect RS-232 cable

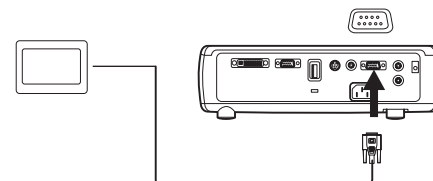

You can play JPEGs using the **LitePort** USB connector and LitePort player. You need a USB mass storage device to use this connector. See page 27 for details.

connect USB mass storage device

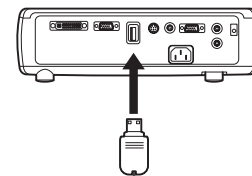

Displaying a computer image

Remove the lens cap.

remove lens cap

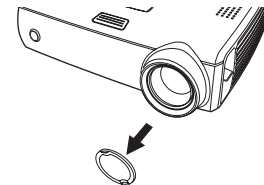

Press the **Power** button on the top of the projector or the remote.

The LED flashes green and the fans start to run. When the lamp comes on, the startup screen is displayed and the LED is steady green. It can take a minute for the image to achieve full brightness. The Interactive Display on the projector indicates the startup status.

press Power button

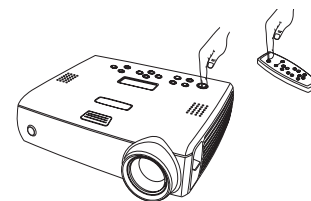

? No startup screen? Get help on page 17.

Turn on your computer.

The computer's image should appear on the projection screen. If it doesn't, press the **Source** button on the projector's keypad.

turn on computer



Make sure your laptop's external video port is active.

Many laptops do not automatically turn on their external video port when a projector is connected. Usually a key combination like FN + F8 or CRT/LCD key turns the external display on and off. Locate a function key labeled CRT/LCD or a function key with a monitor symbol. Press FN and the labeled function key simultaneously. **Refer to your laptop's documentation to learn your laptop's key combination.**

activate laptop's external port

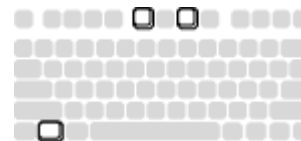

? No computer image? Try pressing the **Auto Image** button on the keypad. Get help on page 17.

First-time projector use with Windows 98

If you are running Windows 2000, Windows ME, or Window XP, skip these steps and go to “Adjusting the image” on page 12.

The first time you connect a computer running Windows 98 to the projector, the computer recognizes the projector as “new hardware” and the Add New Hardware Wizard appears. Follow these instructions to use the Wizard to load the correct driver (which was installed with your Windows operating system).

a Click **Next** to begin searching for the driver.

b Make sure “Search for the best driver” is selected, then click **Next**.

c Uncheck any checked boxes, then click **Next**. Windows automatically locates the driver. If this driver has been removed, reload the driver using your Windows operating system CD.

d When Windows finds the driver, you are ready to install it. Click **Next**.

a

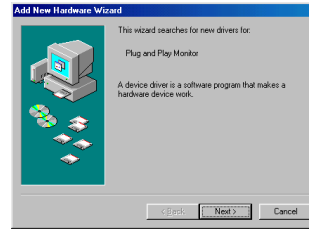

b

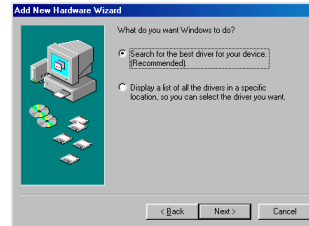

c



d

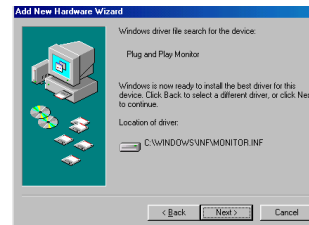

Skip this page if you did not connect the USB portion of the MI computer cable

For Windows 98:

- If you connected the USB cable, the Add New Hardware Wizard appears again. Drivers must be installed to use the USB functionality.
- **The Wizard launches two times.**

The first time it detects a USB Human Interface Device (for the keyboard).

The second time it detects a USB Human Interface Device (for the mouse).

For Windows 2000, Windows ME, and Windows XP:

- The USB drivers are automatically installed.

Adjusting the image

Adjust the height of the projector, if necessary, by pressing the release button to extend the elevator foot.

Rotate the leveling foot (located at the bottom back right corner), if necessary.

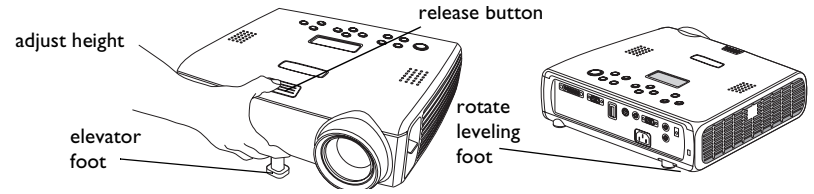

Position the projector the desired distance from the screen, so that the lens is perpendicular to the screen.

See page 44 for a table listing screen sizes and distances.

adjust distance

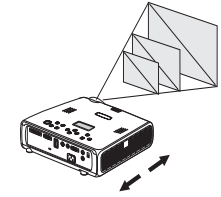

Adjust the zoom or focus rings by rotating them until the desired image size and focus are produced.

adjust zoom and focus

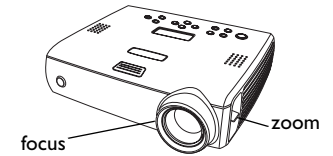

The projector has an Auto Keystone option that is turned on by default. But if the image is not square, adjust the vertical digital keystone by using the buttons on the keypad. Press the upper **Keystone** button to reduce the upper part of the image, and press the lower **Keystone** button to reduce the lower part.

You can also adjust the keystone via the menus, or turn off Auto Keystone. See page 31.

adjust keystone

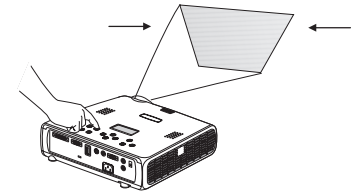

Adjust the Contrast or Brightness in the Picture menu.

See page 30 for help with the menus.

adjust Contrast or Brightness

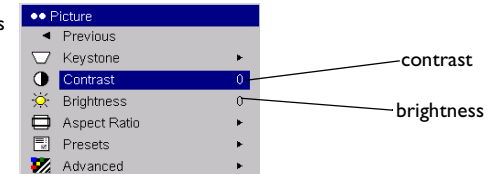

Connecting a video device

Standard video connections

Plug the video cable into the video-out connector on the video device. Plug the other yellow connector into the yellow **Video 2** connector on the projector.

Plug the white connector of the audio adapter into the left audio out connector on the video device and plug the red connector into the right audio out connector on the video device.

Plug the audio cable into the other end of the audio cable adapter and into the **audio in** connector on the projector.

connect video and audio cables

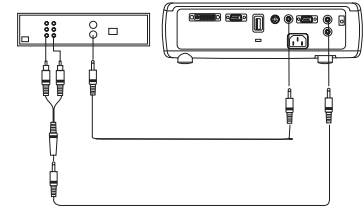

Connect the black power cable to the connector on the back of the projector and to your electrical outlet.

connect power cable

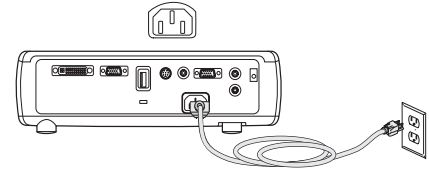

NOTE: Always use the power cable that shipped with the projector.

Optional video connections

If the video device uses a round, four-prong S-video connector, plug an S-video cable (sold separately) into the S-video connector on the video device and into the **S-Video 1** connector on the projector. Use the audio connectors as described directly above.

connect S-video and audio cables

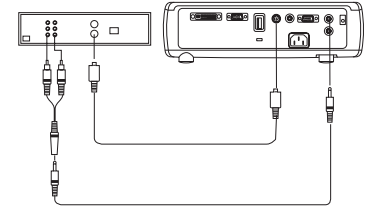

To connect a progressive scan EDTV or HD source, use the Component to M1 adapter (sold separately).

Displaying a video image

Remove the lens cap.

remove lens cap

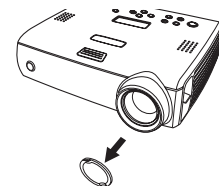

Press the **Power** button on the top of the projector or the remote. The LED flashes green and the fans start to run. When the lamp comes on, the startup screen is displayed and the LED is steady green. It can take a minute for the image to achieve full brightness. The Interactive Display on the projector indicates the startup status.

press Power button

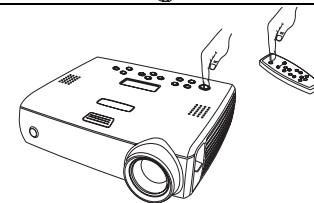

? **No startup screen?** Get help on page 16.

Plug in and turn on the video device.

The video device's image should appear on the projection screen. If it doesn't, press the **Source** button on the keypad.

turn on video device

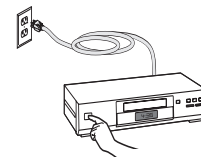

Adjust the height of the projector by pressing the release button to extend the elevator foot. Rotate the leveling foot, if necessary.

adjust height

release button

elevator foot

rotate leveling foot

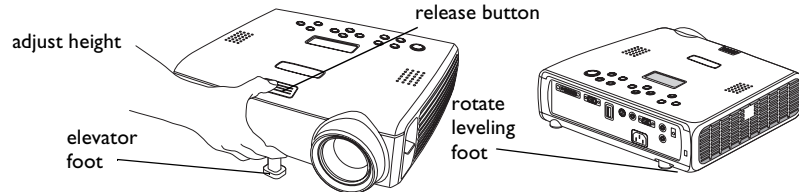

Position the projector the desired distance from the screen, so that the lens is perpendicular to the screen. See page 44 for a table listing screen sizes and distances to the screen.

adjust distance

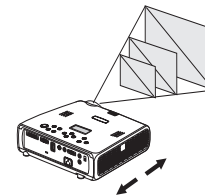

Adjust the zoom or focus rings by rotating them until the desired image size and focus are produced.

adjust zoom and focus

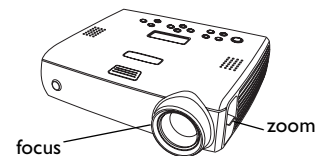

If the image is not square, adjust the vertical keystone using the buttons on the keypad.

Press the upper **Keystone** button to reduce the upper part of the image, and press the lower **Keystone** button to reduce the lower part.

You can also adjust the keystone via the menus, or set the projector to automatically adjust the keystone. See page 31.

adjust keystone

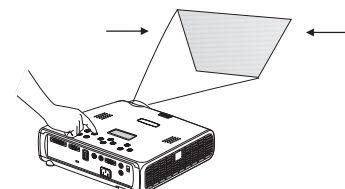

Adjust the volume on the keypad or remote.

adjust volume

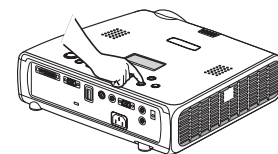

Adjust the **Contrast**, **Brightness**, **Color**, or **Tint** in the Picture menu.

See page 30 for help with the menus.

adjust Picture menu

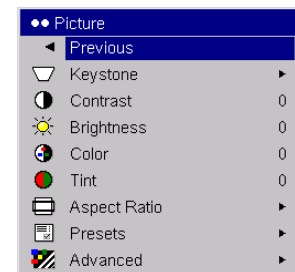

Shutting down the projector

The projector automatically blanks the screen after no active source is detected for 30 minutes. This blank screen helps preserve the life of the projector. The image returns when an active source is detected or a remote or keypad button is pressed. The Interactive Display on the projector indicates the shutdown status.

Screen Save

You can make the blank screen appear after five minutes by turning on Screen Save in the **Settings>System** menu. See page 35. There are six time options for the Screen Save feature. They range from five minutes to 30 minutes with five minute intervals.

Power Save

The projector also has a Power Save feature that automatically turns the lamp off after no signal is detected for 20 minutes. After 10 additional minutes with no signal, the projector powers down. If an active signal is received before the projector powers down, the image is displayed. You must press the **Power** button to display an image after 30 minutes have passed. When Power Save is enabled, Screen Save is disabled. See page 35.

Turning off the projector

To turn off the projector, press the **Power** button and verify that you want to turn the projector off by pressing the **Power** button again within 3 seconds. You can cancel the shutdown by not pressing the **Power** button a second time. The lamp turns off and the LED blinks green for 1 minute while the fans continue to run to cool the lamp. When the lamp has cooled, the LED lights green and the fans stop. Unplug the power cable to completely power off the projector.

Troubleshooting your setup



If your image appears correctly on the screen, skip to the next section (page 26). If it does not, troubleshoot the setup. The Interactive Display and LED on top of the projector indicate the state of the projector and can help you troubleshoot.

Table 1: LED behavior and meaning

LED color/behavior	Meaning
solid green	The projector is plugged in, or the projector has been powered on and the software has initialized. The projector has been turned off and the fans have stopped.
blinking green	The power button has been pressed and the software is initializing, or the projector is powering down and the fans are running to cool the lamp.
blinking red see page 44 for more information	A fan or lamp failure has occurred. Make sure the vents aren't blocked (see page 23). Turn off the projector and wait one minute, then turn the projector on again. If the Replace Lamp message appears, replace the lamp and reset the lamp timer. Contact Technical Support if the problem persists.
solid red	An unidentifiable error: please contact Technical Support.

The following tables show common problems. In some cases, more than one possible solution is provided. Try the solutions in the order they are presented. When the problem is solved, you can skip the additional solutions.

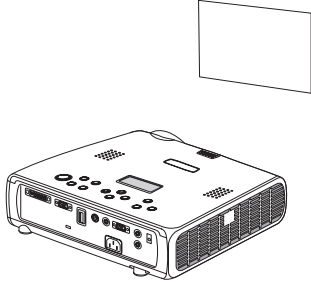
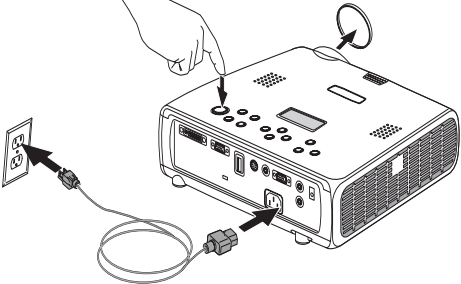
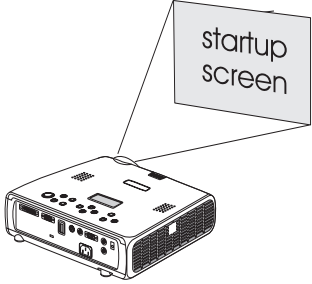
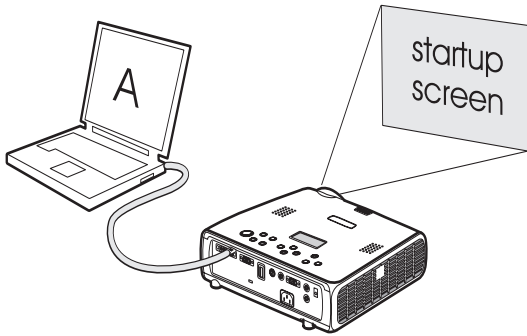
Source Troubleshooting

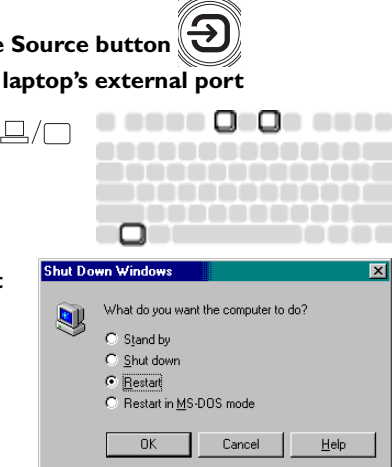
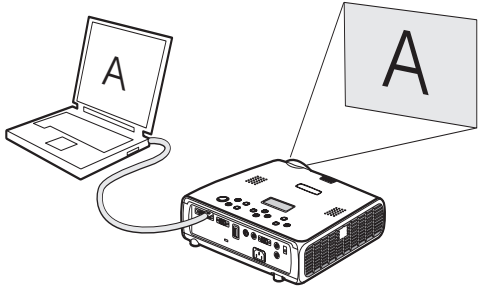
Problem	Solution	Result
<p data-bbox="48 158 260 181">No startup screen</p> 	<p data-bbox="663 158 1124 208">Plug power cable in, press Power button. Remove lens cap.</p> 	<p data-bbox="1187 158 1357 181">Correct image</p> 
<p data-bbox="48 548 374 571">Only startup screen appears</p> 	<p data-bbox="663 576 1010 640">Press the Source button  Activate laptop's external port</p> <p data-bbox="663 817 777 870">or restart laptop</p> 	<p data-bbox="1187 548 1496 571">Computer image projected</p> 

No computer image, just the words “Signal out of range”

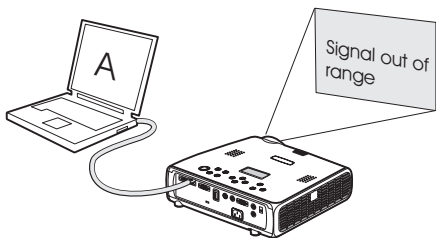

Adjust computer refresh rate in Control Panel>Display>Settings>Advanced>Adapter (location varies by operating system)

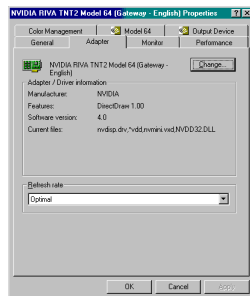

You may also need to set a different resolution on your computer, as shown in the following problem, “Image fuzzy or cropped”

Computer image projected

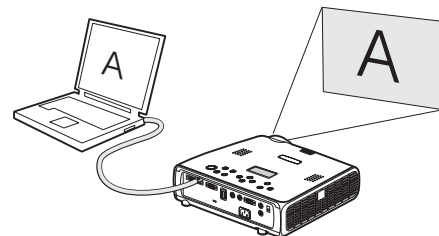

For PC: Image fuzzy or cropped

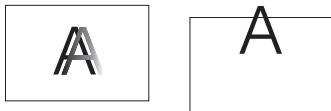

Set your computer’s display resolution to the native resolution of the projector (Start>Settings>Control Panel>Display>Settings tab, select 1024x768)

For a laptop, disable laptop monitor or turn-on dual-display mode

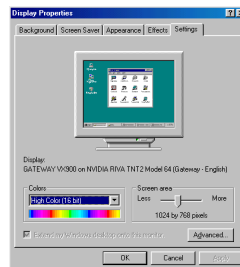
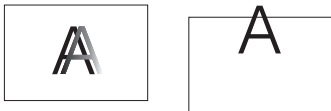

Image clear and not cropped



For Macintosh: Image fuzzy or cropped



**Set your computer's display resolution to the native resolution of the projector
(Apple menu>System Preferences>Displays, choose 1024x768)**

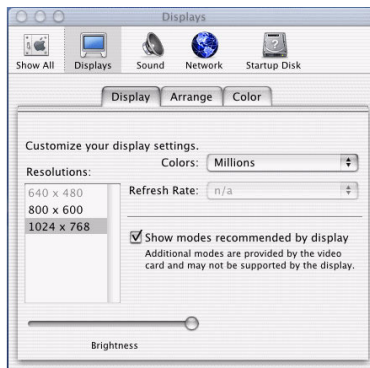
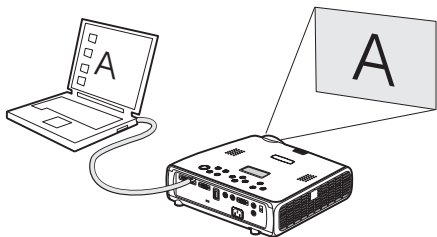

Image clear and not cropped



Only my laptop's background appears, not the Desktop icons



**Disable "Extend my Windows Desktop" in Control Panel>Display>Settings>Display 2
(location varies by operating system)**

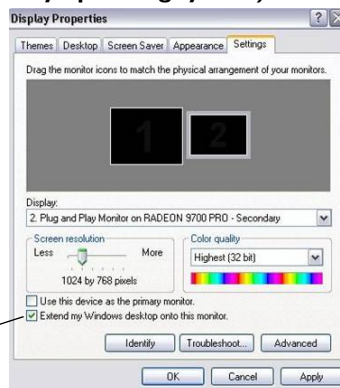

Uncheck this option, then click Apply

Background and Desktop projected

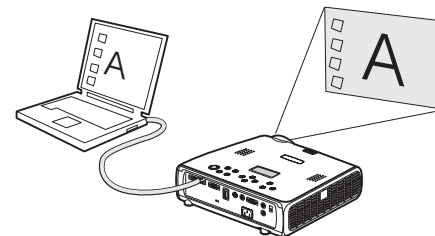

The video embedded in my PowerPoint presentation does not play on the screen

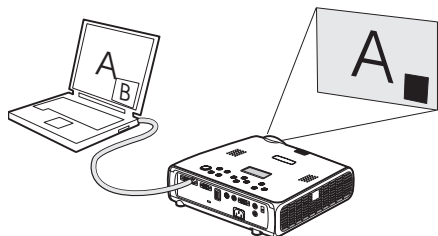

Turn off the internal LCD display on your laptop

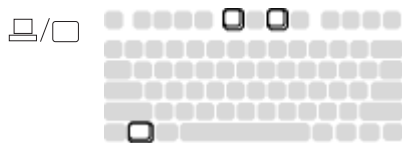

Embedded video plays correctly

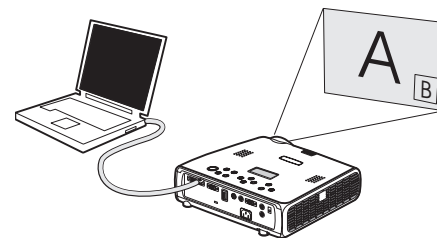

Remote control not advancing PowerPoint slides

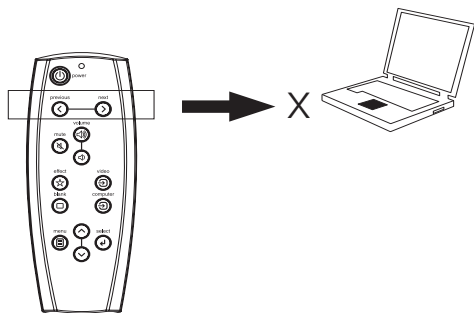

Connect USB cable (page 7) then load USB drivers, if needed (page 10).

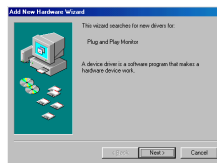
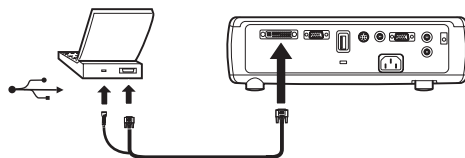

Remote advances slides
See page 26 for information on the remote

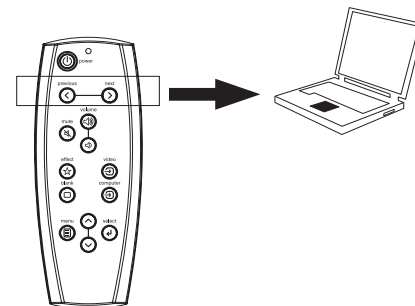

Projector troubleshooting







Problem	Solution	Result
<p data-bbox="53 158 251 181">Image not square</p> 	<p data-bbox="664 158 1157 181">Adjust keystone on keypad or Picture menu</p> 	<p data-bbox="1189 158 1345 181">Square image</p> 
<p data-bbox="53 422 239 445">Image not sharp</p> 	<p data-bbox="664 422 1124 474">Adjust the focus lens or Sharpness in the Picture>Advanced menu</p> 	<p data-bbox="1189 422 1355 445">Correct image</p> 
<p data-bbox="53 716 392 739">Image does not fit 16:9 screen</p> 	<p data-bbox="664 716 1003 768">Change aspect ratio to 16:9 in Picture>Aspect ratio menu</p> 	<p data-bbox="1189 716 1355 739">Correct image</p> 

Image upside down

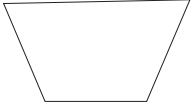
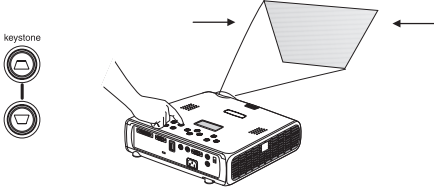

Turn off Auto Ceiling or Ceiling in Settings>System menu

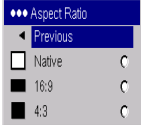
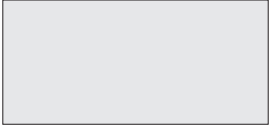
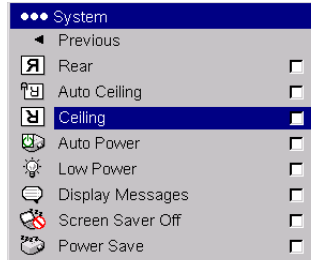

Correct image



Image reversed left to right



Turn off Rear in Settings>System menu

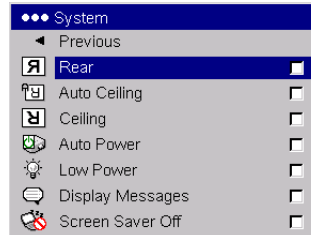

Correct image



Projected colors don't match source



Adjust color, tint, color temperature, brightness, contrast in the menus

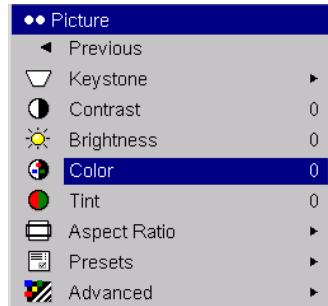

Correct image



Image not centered on screen

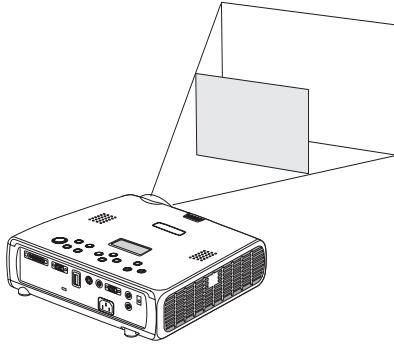

Move projector, adjust zoom, adjust height

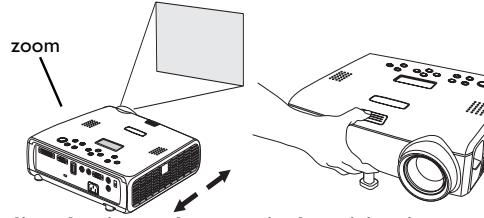

Adjust horizontal or vertical position in
Picture>Advanced menu

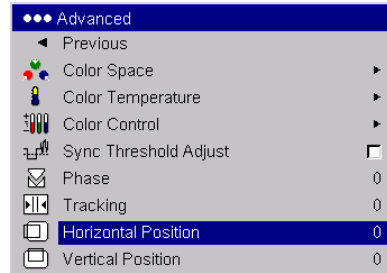

Correct image

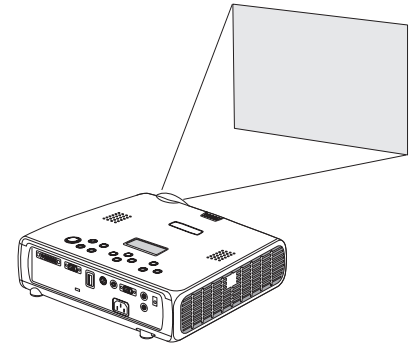

Lamp won't turn on, LED blinking red (page 16)

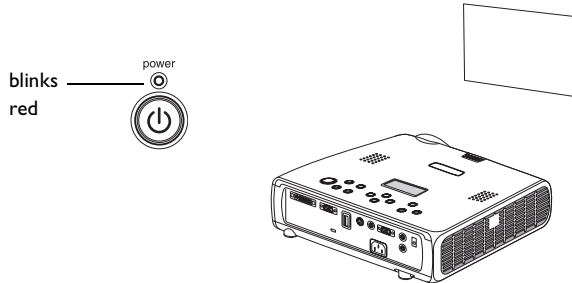

Make sure vents aren't blocked; allow projector to cool for one minute

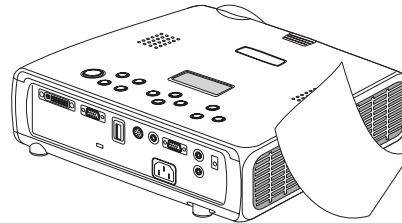

Unplug projector; wait one minute; plug in projector and turn it on: lamp lights

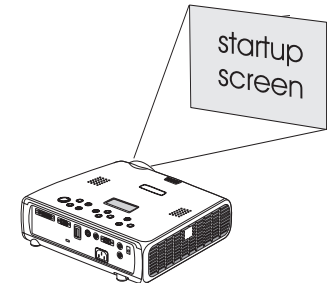

Lamp won't turn on, LED blinking red (page 16)

blinks
red

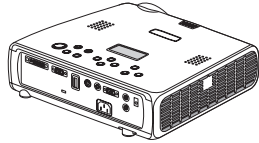

Lamp must be replaced (page 40)

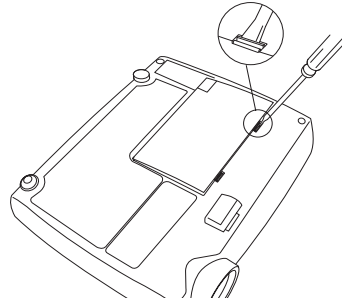

Lamp turns on

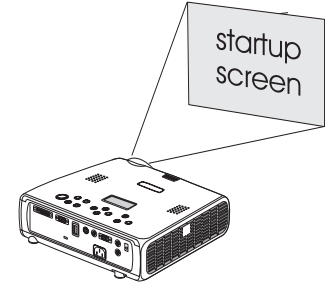

Still having problems?

If you need assistance, visit the Service and Support section of our website or call us. See the inside of the back cover for a list of all relevant web addresses.

This product is backed by a limited warranty. An extended warranty plan may be purchased from your dealer. When sending the projector in for repair, we recommend shipping the unit in its original packing material, or having a professional packaging company pack the unit. Please insure your shipment for its full value.

Using the keypad buttons

Most buttons are described in detail in other sections, but here is an overview of their functions:

power—turns the projector on (page 9) and off (page 16).

menu—opens the on-screen menus (page 30).

select—confirms choices made in the menus (page 30).

up/down arrows—navigates to and adjusts settings in the menus (page 30).

auto image—resets the projector to the source.

presets—cycles through the available preset settings (page 32).

keystone—vertical keystone adjusts the squareness of the image (page 12). You can also adjust the keystone via the menus. See page 31.

volume—adjusts sound (page 28).

source—changes the active source.

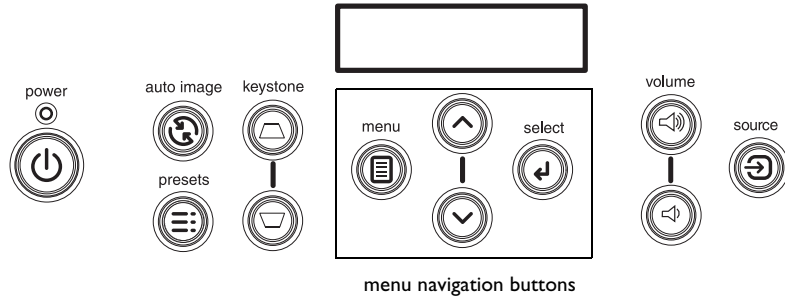

Using the remote control

The remote uses two (2) provided AA batteries. They are easily installed by sliding the cover off the remote's back, aligning the + and - ends of the batteries, sliding them into place, and then replacing the cover.

To operate, point the remote at the projection screen or at the projector (not at the computer). The range of optimum operation is about 30 feet (9.14m).

Previous and Next buttons allow you to navigate through your PowerPoint presentation while in Slide Show mode. Connect the USB connector on the computer cable to your computer to use these buttons. When you do this for the first time, the Add New Hardware wizard may appear. See page 10 for details on loading the correct USB drivers.

Press the remote's **Menu** button to open the projector's menu system. Use the arrow buttons to navigate, and the **Select** button to select features and adjust values in the menus. See page 30 for more info on the menus.

The remote also has a **Power** button to turn the projector on and off (see page 16 for shutdown info), **Volume** and **Mute** buttons to control the sound, and a **Source** button to switch between sources.

Two presentation-specific features are also provided. Use the **Blank** button to display a blank screen instead of the current slide (you can choose which color is displayed, see page 37); use the **Effect** button to invoke a user-definable action, such as freeze or aspect ratio (see page 38 to learn to program this button).

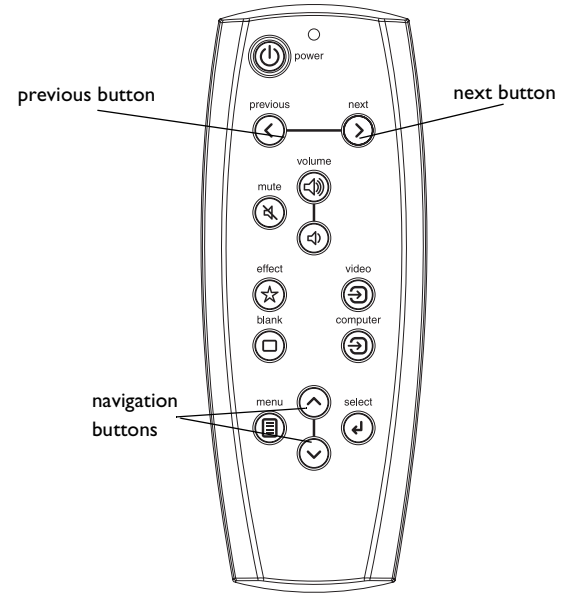

Troubleshooting the remote

- Make sure the batteries are installed in the proper orientation and are not dead. The LED at the top of the remote lights when any button is pressed when the battery power is adequate.
- Make sure you're pointing the remote at the projector, not the computer, and are within the remote range of 30 feet (9.14m).
- If you are trying to advance PowerPoint slides, make sure the USB portion of the M1 computer cable is connected and the correct drivers are installed.

Using the LitePort player

LitePort allows you to display any JPEG image automatically, without a computer connected. Use your own JPEGs from your digital camera, or convert your files, such as PowerPoint or Word files, into JPEGs using LitePort Utility software (included on the CD). LitePort Utility allows you to easily generate the highest quality JPEG images possible. (LitePort player is optimized to display images at 960x720 resolution, so for best results, create JPEGs at this resolution). Then transfer the JPEG images from your computer to the projector using a USB mass storage device and your images are ready to be displayed. You can use the remote control to select which JPEGs to view or you can set up the LitePort player using the LitePort onscreen menu to select display preferences and automatically display and advance your JPEGs. See page 36.

When active, the player can be in one of three modes:

- **Folder View mode**, which shows a thumbnail image representing each folder that contains a valid JPEG. The thumbnail for that folder is the first JPEG alphabetically in that folder. Folders are sorted alphabetically based on the name of the actual directory with no regard to the file system path to the folder.
- **File View mode**, which shows a thumbnail of the valid JPEGs in that folder.
- **Full Screen mode**, which shows the first JPEG in the selected folder.

The remote and keypad buttons interact with the player differently in each mode. When you insert a USB device in the LitePort connector, the player enters Full Screen mode if Auto Play is checked (the default setting) and the AutoPlay folder contains a JPEG or it enters Folder View if Auto Play is not checked. The AutoPlay folder is automatically created by LitePort Utility software. See its online help for details.

In Folder View mode, pressing the Next button (or the Down arrow) places the white selection box around the next folder, pressing the Previous button (or the Up arrow) places the selection box around the previous folder, pressing Select selects the current folder and enters File View mode. Nine folder thumbnails can be displayed on the screen at a time. If your USB drive contains more than 9 folders, you can navigate to them by navigating to the last

thumbnail on the screen and pressing Next or Down arrow. You are looped back to Folder 1 when you reach the end of the folder list.

Table 2: Folder View navigation

Folder 1	2	3
4	5	6
7	8	Folder 9 (press Next to access Folder 10)

In File View mode, pressing Next (or Down) places the selection box around the next JPEG file, pressing Previous (or Up) places the selection box around the previous JPEG, pressing Select selects the current JPEG and enters Full Screen mode, or, if the “return to folders” arrow is highlighted, returns to Folder View mode. Eight file thumbnails can be displayed on the screen at a time. If your folder contains more than 8 files, you can navigate to them by navigating to the last thumbnail on the screen and pressing Next. You are looped back to File 1 when you reach the end of the file list.

Table 3: File View navigation

Return to Folders arrow	File 1	2
3	4	5
6	7	File 8 (press Next to access File 9)

In Full Screen mode, pressing Next (or Down) advances to the next JPEG file, pressing Previous (or Up) goes to the previous JPEG file, pressing Select returns to File View mode. To rotate the JPEG 90 degrees clockwise, select LitePort Rotate in the Effect menu (see page 38) then press the Effect button. Press Select to return to File View mode.

Using the audio

To play sound from the projector, connect your source to the **Audio In** connector on the projector.

To adjust the volume, use the buttons on the keypad or remote.

To adjust the balance or turn off the projector's chime, use the Audio menu (see page 34).

To mute the sound, press the **Mute** button on the remote.

Troubleshooting audio

If there is no sound, check the following:

- Make sure the audio cable is connected.
- Make sure mute isn't active.
- Make sure the volume is turned up enough. Press the **Volume** button on the keypad or remote.
- Adjust the audio source.
- If playing a video, make sure the playback has not been paused.

connect audio cable

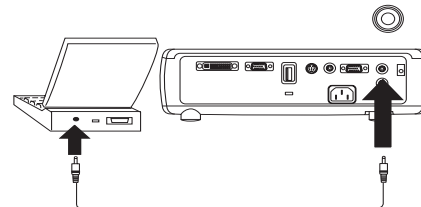

adjust volume

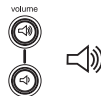

Connecting external speakers

The projector can be attached to external speakers that have their own power source by plugging a speaker cable into the projector's **Audio Out** connector.

external speakers

speaker cable

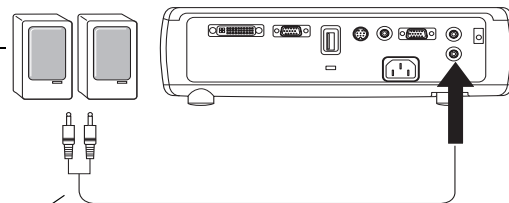

Optimizing computer images

After your computer is connected properly and the computer's image is on the screen, you can optimize the image using the onscreen menus. For general information on using the menus, see page 30.

- Adjust the Keystone, Contrast, or Brightness in the Picture menu.
- Change the Aspect Ratio. See page 31 for details.
- Adjust the Color Space, Temperature or Control in the Advanced menu.
- Adjust the Phase, Tracking, or Horizontal or Vertical position in the Advanced menu.
- Once you have optimized the image for a particular source, you can save the settings using Presets. This allows you to quickly recall these settings later. See page 32.

Presentation features

Several features are provided to make giving presentations easier. The following is an overview, details are found in the menu section on page 30.

- The remote's **Effect** button allows you to assign various features to the key. The default effect is About. You can select from Blank, Mute, Aspect Ratio, Source, Auto Image, Freeze, About, and LitePort Rotate. See page 38 for details.
- The Freeze effect allows you to freeze the displayed image. This is useful if you want to make changes on your computer without your audience seeing them.
- The **Blank** button on the remote allows you to display a blank screen instead of the active source. See page 37.
- The Startup Logo menu option lets you change the default startup screen to a black, white, or blue screen. See page 37.
- Two menu options, Power Save and Screen Save, are provided to automatically shut down the projector after several minutes of inactivity or display a blank screen. This helps preserve lamp life. See page 35.

Optimizing video images

After the video device is connected properly and the image is on the screen, you can optimize the image using the onscreen menus. For general information on using the menus, see page 30.

- Adjust the Keystone, Contrast, Brightness, Color, or Tint in the Picture menu. See page 31.
- Change the Aspect ratio. Aspect ratio is the ratio of the image width to image height. TV screens are usually 1.33:1, also known as 4:3. HDTV and most DVDs are 1.78:1, or 16:9. Choose the option that best fits your input source. See page 31.
- Select a Sharpness, Color Temperature, or Video Standard setting. See page 33.
- Adjust the Color Control or White Peaking settings. See page 33.

Customizing the projector

You can customize the projector for your specific setup and needs. See page 34 to page 39 for details on these features.

- For rear projection, turn Rear mode on in the **Settings>System** menu.
- For ceiling mounted projection, turn Ceiling mode on in the **Settings>System** menu.
- Turn on Automatic Keystone adjustments.
- Specify which source the projector checks first for active video during power-up.
- Specify the function of the Effect Key on the remote.
- Turn the projector's display messages on and off.
- Turn on power saving features.
- Specify blank screen colors and startup logos.
- Specify the menu language.
- Project wirelessly with LiteShow wireless adapter. See page 6.
- Control your projector using RS-232 commands. See page 8.

Using the menus

To open the menus, press the **Menu** button on the keypad or remote. (The menus automatically close after 60 seconds if no buttons are pressed.) The Main menu appears. Use the arrow buttons to move up and down to highlight the desired submenu, then press the **Select** button.

To change a menu setting, highlight it, press **Select**, then use the up and down arrow buttons to adjust the value, select an option using radio buttons, or turn the feature on or off using check boxes. Press **Select** to confirm your changes. Use the arrows to navigate to another setting. When your adjustments are complete, navigate to Exit, then press **Select** to go to the previous menu; press the **Menu** button at any time to close the menus.

Dots appear before the menu name. The number of dots indicate the menu's level, ranging from one (the Main menu) to four (the most nested menus).

The menus are grouped by usage:

- The Picture menu provides image adjustments.
- The Settings menu provides set-up type adjustments that are not changed often.
- The About menu provides a read-only display of information about the projector and source.

Certain menu items may be grayed out until a particular source is connected. For example, Sharpness is only available for video sources and will be hidden when a computer source is active. Other menu items may be grayed out when they are not available. For example, Brightness is grayed out until an image is active.

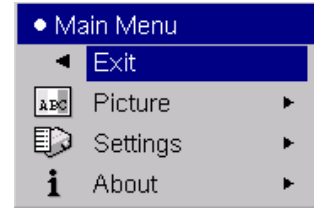

Main menu

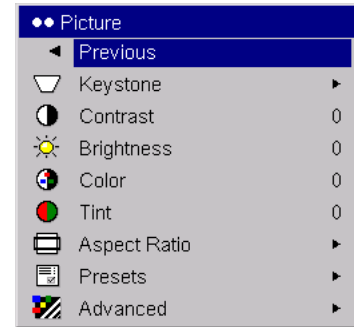
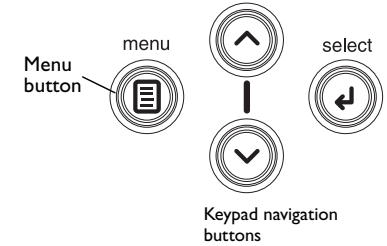

Picture menu

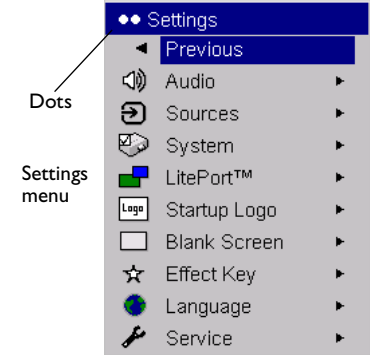

Settings menu

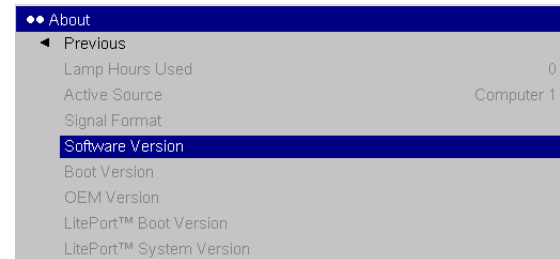

About menu

Picture menu

To adjust the following six settings, highlight the setting, press **Select**, use the up and down arrows to adjust the values, then press select to confirm the changes.

Keystone: adjusts the image vertically and makes a squarer image. You can also adjust keystone from the keypad. If you want the projector to automatically adjust the keystone, check the Auto Keystone check box. If you then manually adjust the keystone, Auto Keystone is turned off. When the projector is in Ceiling Mount mode, Auto Keystone is turned off. You can do a “one-time” automatic keystone adjustment by pressing both Keystone buttons on the keypad at the same time.

Contrast: controls the degree of difference between the lightest and darkest parts of the picture and changes the amount of black and white in the image.

Brightness: changes the intensity of the image.

Color: (video and component sources only) adjusts a video image from black and white to fully saturated color.

Tint: (NTSC video sources only) adjusts the red-green color balance in the image.

Aspect Ratio: Aspect ratio is the ratio of the image width to image height. TV screens are usually 1.33:1, also known as 4:3. HDTV and most DVDs are 1.78:1, or 16:9. The default is 4:3, which displays the input resized up or down to fill the display area.

The aspect ratio selection is saved for each source.

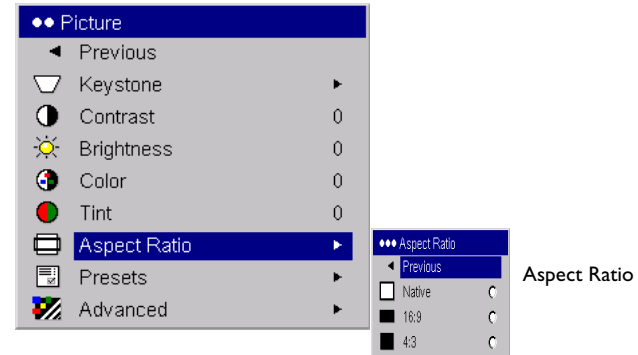
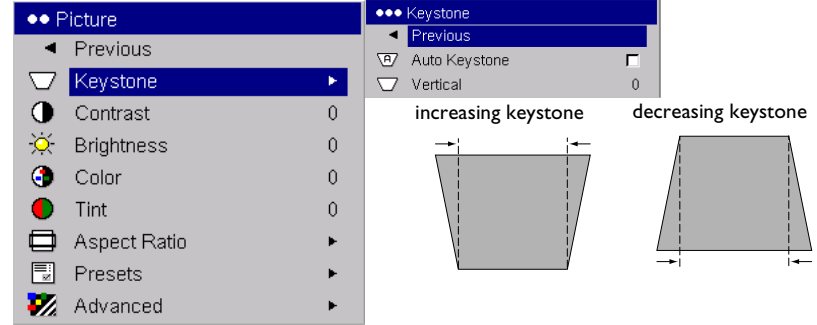

Presets: The provided Presets optimize the projector for displaying computer presentations, photographs, and film images. You can use the preset as a starting point, then further customize the settings for each source. To restore the factory default settings, choose Factory Reset in the **Settings>Service** menu.

There are also three user-definable presets. To set a preset for the current source, adjust the image, then choose Save User 1, 2, or 3. You can recall these settings in the future by selecting the appropriate user presets.

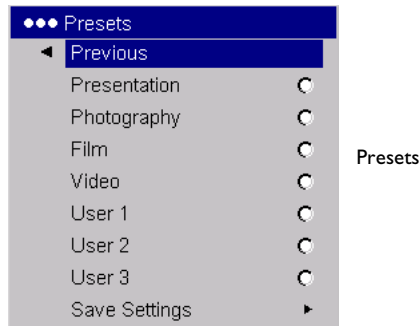

Advanced settings

Sharpness: (video sources only) changes the clarity of the edges of a video image. Select a sharpness setting.

Color Space: This option applies to computer sources. It allows you to select a color space that has been specifically tuned for the video input. When Auto is selected, the projector automatically determines the standard. To choose a different setting, turn off Auto, then choose RGB for computer sources, choose either REC709 or REC601 for component sources.

Color Temperature: changes the intensity of the colors. Select a listed value.

Color Control: allows you to individually modify each color. Highlight the color, press **Select**, then use the arrows to adjust the value.

Video Standard: (video sources only) When it is set to Auto, the projector attempts to pick the video standard automatically based on the input signal it receives. (The video standard options may vary depending on your region of the world.) If the projector is unable to detect the correct standard, the colors may not look right or the image may appear “torn.” If this happens, manually select a video standard by selecting NTSC, PAL, or SECAM from the Video Standard menu.

Overscan: (video sources only) removes noise around the video image.

Sync Threshold Adjust: (enhanced and high definition sources only) If a hardware device, such as a DVD player, is not syncing properly with the projector, select this option to help it sync.

The following 4 options are for computer and component sources only.

Phase: adjusts the horizontal phase of a computer source.

Tracking: adjusts the vertical scan of a computer source.

Horizontal/Vertical Position: adjusts the position of a computer source.

White Peaking: (video sources only) adjusts the white level processed in the image. It increases the brightness of whites that are near 100%.

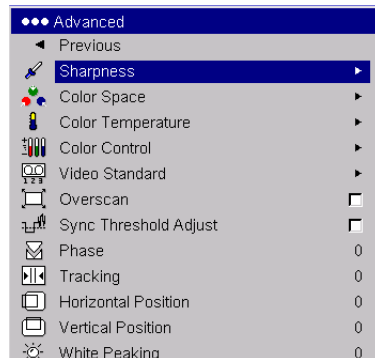

Advanced

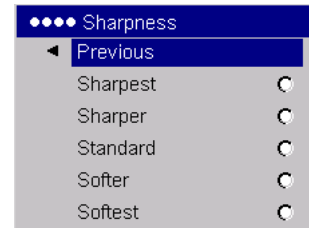

Sharpness

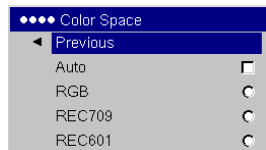

Color Space

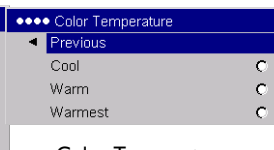

Color Temperature



Color Control



Video Standard

Settings menu

Audio: allows adjustments to the volume and balance, and turns the projector's startup Chime on and off.

Sources: allows you to assign a particular input to a specific source key when using the optional Integrator remote. Also allows selection of a default Power-up Source and enables or disables Autosource.

Sources>Power-up Source: this determines which source the projector checks first for active video during power-up.

Sources>Autosource: When Autosource is not checked, the projector defaults to the source selected in Power-up Source. If no source is found, a blank screen displays. When Autosource is checked, Power-up Source determines which source the projector defaults to at startup. If no signal is present, the projector checks the sources in order until a source is found or until power down.

Sources>Monitor Out Enable: Selects the Computer 2/monitor out connector to be a monitor loop through of the incoming Computer 1 signal when checked. When it is unchecked, this connector acts as a VESA input.

System>Rear: reverses the image so you can project from behind a translucent screen.

Auto Ceiling: automatically senses when the projector is inverted and turns the image upside down. This is On by default. When in Ceiling mode, Auto Keystone is turned off.

Ceiling: turns the image upside down for ceiling-mounted projection.

Auto Power: When Auto Power is checked, the projector automatically goes into the startup state after the projector is powered on. This allows control of ceiling mounted projectors with a wall power switch.

Low Power: Turn this on to lower the light output of the lamp. This also lowers the fan speed, making the projector quieter.

Display Messages: displays status messages (such as "Searching" or "Mute") in the lower-left corner of the screen.

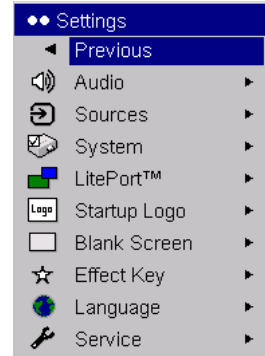

Settings



Audio

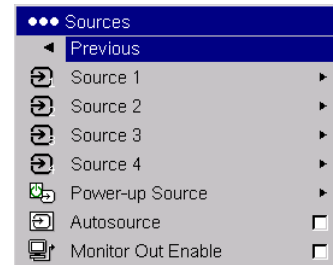

Sources

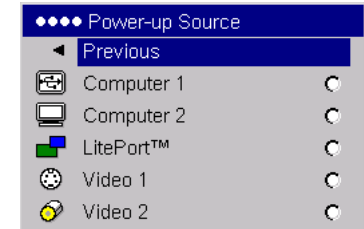

Power-up Source

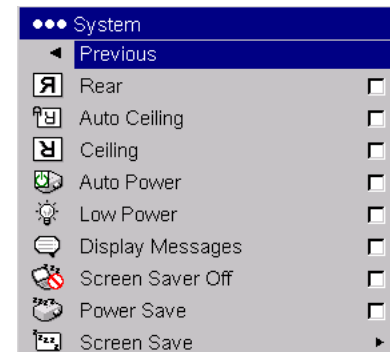

System

Screen Saver Off: prevents your computer from going into Screen Save mode.

Power Save: automatically turns the lamp off after no signals are detected for 20 minutes. After 10 additional minutes with no signal, the projector powers down. If an active signal is received before the projector powers down, the image will be displayed.

Screen Save: automatically blanks the screen with a black color after no signals are detected for a preset number of minutes. The image returns when an active source is detected or a remote or keypad button is pressed. Screen Save is disabled when Power Save is enabled.

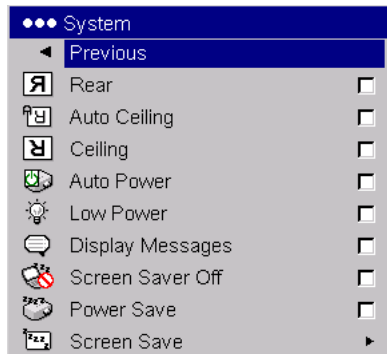

System

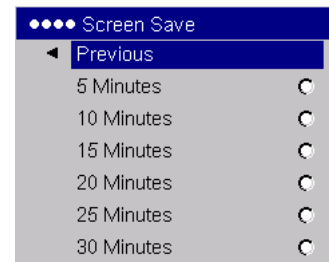

Screen Save

LitePort

This menu allows you to control the embedded LitePort player in your projector to display JPEGs stored on your USB mass storage device. You can also control the LitePort player with the remote or keypad. See page 27.

Auto Play: When this box is checked (the default), the projector automatically makes the LitePort player the active source and displays, in Full Screen mode, the first JPEG in the LitePort\AutoPlay folder on the USB drive. If no AutoPlay folder exists or the AutoPlay folder is empty, then no images will be displayed and Folder View mode is entered. When this box is unchecked, you must manually choose the LitePort source using the remote's computer button or the source button on the keypad. This will display Folder View mode. See page 27 for details on selecting images to display using the remote or keypad.

Play All: When this box is checked, the projector plays all the JPEGs in all the folders on the USB drive, starting with the current folder and continuing in alphanumeric folder order. If it is unchecked, only the JPEGs in the selected folder are displayed, and these JPEGs play on a continuous loop.

Fit to Screen: This causes the image to fill the entire screen. If the image has a different aspect ratio than the screen, the image will fit in width or height, depending upon which is larger. Any empty space will be filled with black.

Auto Advance: This option lets you automatically advance images and determine how long each image is displayed before advancing to the next image. Click the check box to turn it on, then highlight Seconds and use the Up/Down arrows on the keypad or remote to increase or decrease the display time. When playing images with this option, you can go back to the previous slide by pressing the Up arrow or ahead to the next slide quicker by pressing the Down arrow. Press the Select button to stop Auto Advance and return to File View mode.

Slide Transition: This allows you to customize your presentation with slide transitions. Select among None (no transition), Random, Wipe Down, Wipe Up, Wipe Right, Wipe Left, Split Horizontal In, Split Horizontal Out, Split Vertical In, Split Vertical Out, Horizontal Blinds, Vertical Blinds, Box In, and Box Out. For a demonstration of these transitions, go to the Slide Show>Slide Transition menu in PowerPoint.

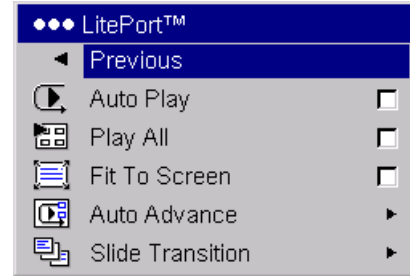

LitePort

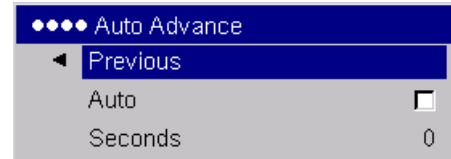

Auto Advance

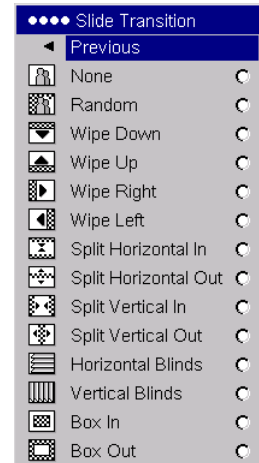

Slide Transition

Startup Logo: allows you to display a blank Black, White, or Blue screen instead of the default screen at startup and when no source is detected.

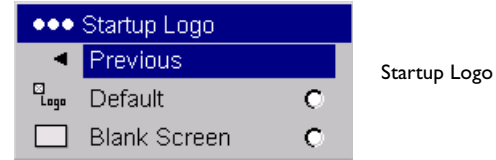

Blank Screen: determines what color is displayed when you press the **Blank** button on the remote.

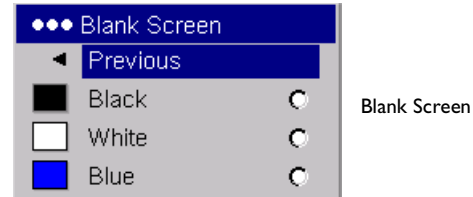

Effect Key: allows you to assign a different function to the **Effect** button on the remote to quickly and easily use the effect. Only one effect can be enabled at a time. Highlight an effect and press **Select** to choose a different one. The default effect is About.

Blank: shows an empty screen.

Mute: turns off all sound.

Aspect Ratio: sets the ratio of the image width to image height.

Source: cycles through the available sources.

Auto Image: causes computer sources to be reacquired.

Freeze: pauses the projected image.

About: displays the About menu.

LitePort Rotate: rotates an image clockwise that is displayed with LitePort.

Language: allows you to select a language for the onscreen display of menus and messages.

Service: to use these features, highlight them and press **Select**.

Factory Reset: restores all settings (except Lamp Hours) to their default after displaying a confirmation dialog box.

Lamp Reset: resets the lamp hours counter in the About menu to zero. Do this only after changing the lamp. It displays a confirmation dialog box.

Service Code: only used by authorized service personnel.

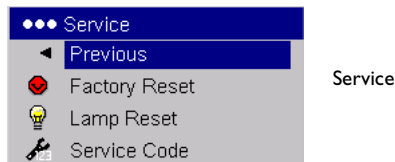
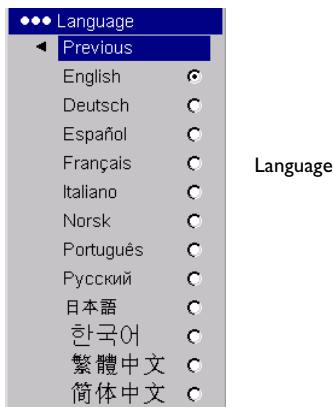

Maintenance

Cleaning the lens

- 1 Apply a non-abrasive camera lens cleaner to a soft, dry cloth.

Avoid using an excessive amount of cleaner, and don't apply the cleaner directly to the lens. Abrasive cleaners, solvents or other harsh chemicals might scratch the lens.

- 2 Lightly wipe the cleaning cloth over the lens in a circular motion. If you don't intend to use the projector immediately, replace the lens cap.

clean the lens
with a soft dry cloth
and non-abrasive
cleaner

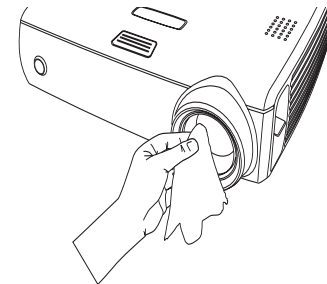

Using the security lock

The projector has a security lock for use with a cable lock system. See "Accessories" on page 43 for ordering information. Refer to the information that came with the lock for instructions on how to use it.

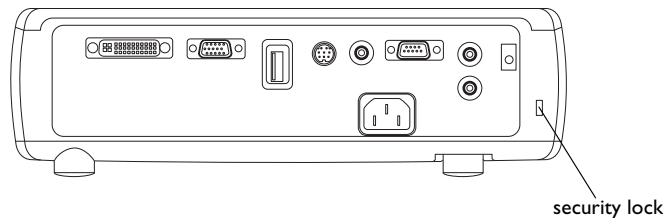

Replacing the projection lamp

The lamp hour timer in the About menu counts the number of hours the lamp has been in use. Fifty hours before the specified end of the lamp's life, the message "Replace lamp" briefly appears on the screen at each startup and in the Interactive Display. After 50 additional hours, the lamp will no longer light. You can order new lamp modules from your dealer. See "Accessories" on page 43 for information.

- 1 Turn off the projector and unplug the power cable.
- 2 Wait 60 minutes to allow the projector to cool thoroughly.
- 3 Turn the projector upside down and remove the lamp door by placing a flat-blade screwdriver into the space between the lamp door and the projector and gently prying the door off.

- 4 Loosen the captive screw on the lamp module.

WARNINGS:

- To avoid burns, allow the projector to cool for at least 60 minutes before you replace the lamp.
- Unplug the power cord before replacing the lamp.
- Do not drop the lamp module. The glass may shatter and cause injury.
- Do not touch the glass lamp screen. Fingerprints can obscure projection sharpness.

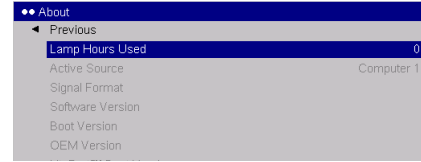

About menu

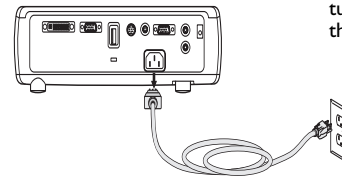

turn off and unplug the projector

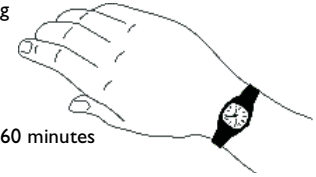

wait 60 minutes

pry the lamp door off

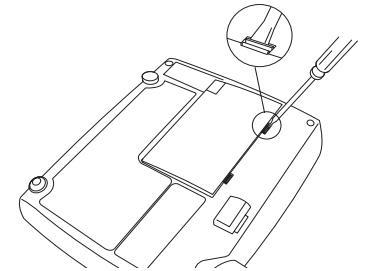

loosen the screw on lamp module

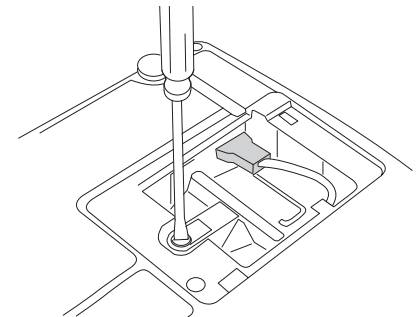

- Be extremely careful when removing the lamp housing. In the unlikely event that the lamp ruptures, small glass fragments may be generated. The lamp module is designed to contain most of these fragments, but use caution when removing it. Before replacing a ruptured lamp, clean the lamp compartment and dispose of cleaning materials. Wash hands after lamp replacement. This product has a lamp which contains a very small amount of mercury. Dispose of it as required by local, state or federal ordinances and regulations. For more information see www.eiae.org.

- 5 Detach the lamp connector from the projector by gently pulling the connector until it is disconnected from the projector.
- 6 Carefully remove the lamp module by grasping and lifting the metal bail wire. Dispose of the lamp in an environmentally proper manner.
- 7 Install the new lamp module, making sure that it is properly seated. Be careful not to touch the interior components of the projector.
- 8 Snap the bail wire back into its flat position against the lamp module.
- 9 Re-attach the lamp connector to the projector. Make sure the connector is fully inserted.
- 10 Tighten the screw on the lamp module.
- 11 Replace the lamp door.
- 12 Plug in the power cable then press the **Power** button to turn the projector back on, then reset the lamp hour timer.

Resetting the lamp timer

If the lamp timer has reached the maximum number of hours for the projector lamp, the LED on the projector's keypad will show a lamp error (see "LED behavior and meaning" on page 16). To reset the lamp timer, press the decrease volume button on the keypad and the increase volume button simultaneously for 10 seconds. You can also navigate to the **Settings>Service** menu and select **Lamp Reset** to reset the lamp timer.

disconnect lamp connector

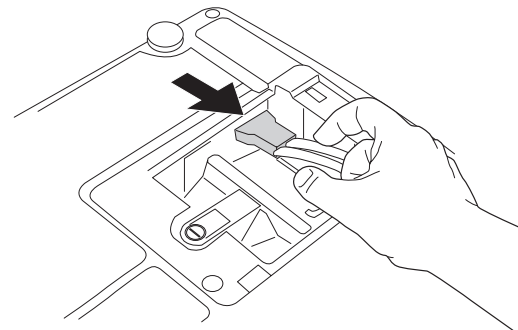

remove module using bail wire

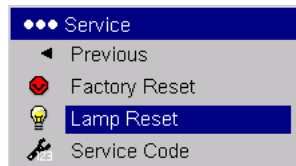
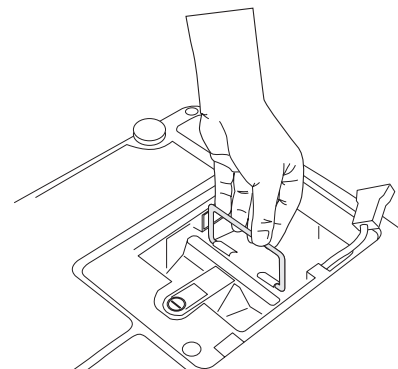

reset lamp time in Service menu

Cleaning the lamp filter screens

In dirty or dusty environments, the dust filter screens on the lamp module and lamp door and in the lamp compartment can become clogged, causing high temperatures inside the lamp module. These high temperatures can impact lamp performance and operating life. Routine maintenance to remove dust and dirt from the screens lowers the lamp operating temperature and prolongs lamp life. To maximize lamp life you will need to clean the screens every 250 hours. Lamp screen maintenance may need to occur more often than 250 hours depending on your installation/use environment.

- 1 Remove the lamp module. Refer to page 40 for instructions.
- 2 Examine the dust filter screens on each side of the lamp module. If necessary, use compressed or canned air to clean the screens. Then use a cotton swab dipped in isopropyl alcohol to lightly wipe each screen. After you've wiped each screen, blow away any remaining contaminants.
- 3 Before you replace the lamp, repeat the cleaning process on the screen in the lamp compartment in the projector.
- 4 Examine the dust filter screen on the lamp door. If necessary, use compressed or canned air to clean the screen.
- 5 Replace the lamp module and lamp door.

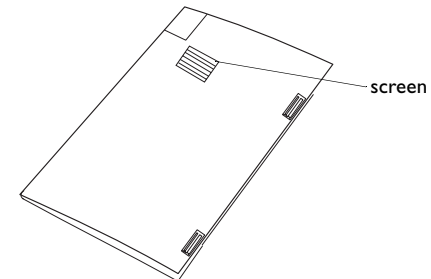
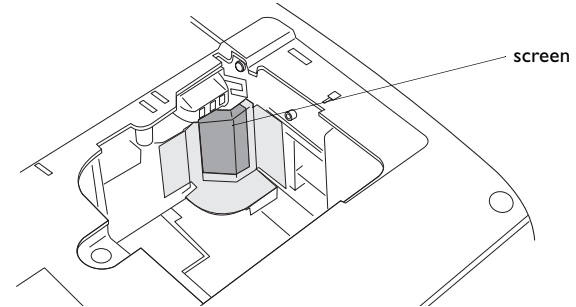
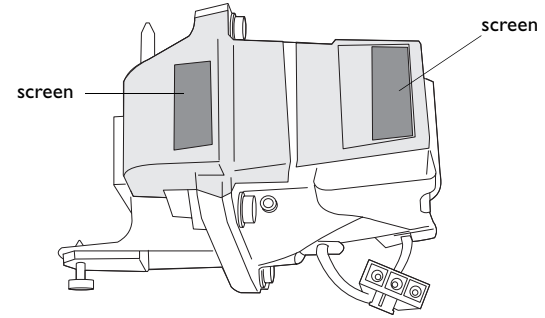

Appendix

Accessories

Standard Accessories (ship with the projector)

	Part Number
Carry Case	110-0819-xx
Computer Cable 6 ft (1.8 m)	SP-DVI-A
Video Cable 6 ft (1.8 m)	210-0176-xx
Audio Cable 6 ft (1.8 m)	210-0118-xx
Audio Cable Adapter	210-0177-xx
Power Cable*	516-0052-xx
Navigator Remote	590-0728-xx
Projection Lamp Module (included in projector)	SP-LAMP-019
Lens Cap	340-1347-xx
Lens Cap Tether	321-0192-xx
Quick Setup card	009-0911-xx
User's Guide with CD	010-0546-xx
Safety Card	009-0659-xx
Color-coded Cable Ties, 3 set	SP-CABLETIES
SCART Adapter*	301130

*country-dependent

Optional Accessories

Part Number

Shipping Case (ATA approved)	CA-ATA-020
Projector Mount	SP-CEIL-011
False Ceiling Plate for Projector Mount	SP-LTMT-PLT
Extension Arm for Projector Mount 26" - 47"	SP-LTMT-EXTP
Organizer Carry Case	CA-C230
DVI-D Cable 6 ft (1.8 m)	SP-DVI-D
MI to Component Adaptor	SP-MI-ADPT
LiteShow Wireless Connection	LP-LITESHOW
Audio/Video Cable, 30 ft (9m)	SP-AV30
Projector Cable Lock System	SP-LOCK-B
50" Diagonal Screen (portable)	A650
60" Diagonal Screen (portable)	HW-DLXSCRN
84" Diagonal Wall/Ceiling Mounted Screen	HW-WALLSCR84
Replacement Lamp Module	SP-LAMP-019
RF Presenter Remote Control	HW-PRESENTER-RF
IR Presenter Remote Control	HW-PRESENTER
IR Conductor + Remote Control	HW-CONDUCTOR+

NOTE: Use only approved accessories.

Red LED behavior and projector errors

If the projector is not functioning properly and the red LED is blinking, consult **Table 4** to determine a possible cause. There are two second pauses between the blinking cycles. Visit our website for more details on the red LED error codes. See the inside back cover for contact information.

Table 4:

Red LED Behavior	Explanation
One (1) blink	The lamp won't strike after five (5) attempts. Check the lamp and lamp door installations for loose connections.
Two (2) blinks	The lamp counter hours have exceeded lamp life hours. Replace the lamp and reset the lamp hours counter.
Three (3) blinks	The projector has shut down the lamp. Replace the lamp. Contact Technical Support for repair if replacing the lamp does not solve the problem.
Four (4) blinks	The fan has failed. Contact Technical Support for repair.
Five (5) blinks	The projector is overheating. Check for a blocked air vent. Contact Technical Support for repair if clearing the air vents does not solve the problem.

Projected image size

**Table 5:
Image sizes**

Distance to screen (feet/m)	Minimum Diagonal (feet/m)	Maximum Diagonal (feet/m)	Minimum Horizontal (feet/m)	Maximum Horizontal (feet/m)
5/1.5	2.75/0.83	3.4/1.02	2.2/0.66	2.73/0.82
10/3	5.5/1.65	6.8/2.04	4.4/1.32	5.46/1.64
15/4.6	8.25/2.53	10.2/3.13	6.6/2.03	8.2/2.51
20/6.1	11/3.36	13.6/4.15	8.8/2.69	10.93/3.33
30/9.1	16.5/5.01	20.4/6.19	13.22/4.01	16.39/4.97
32.8/10	18.0/5.5	22.3/6.8	14.45/4.41	17.92/5.46

NOTE: Visit our website for an interactive image size calculator.

INDEX

Numerics

1024x768 resolution 5

A

About menu 30, 38

Advanced setting 33

advancing PowerPoint slides 7

advancing PowerPoint slides with LitePort 27

Aspect Ratio 31, 38

audio 28

audio adapter 13

Audio In connector 7, 13

audio volume 15

audio, troubleshooting 28

Auto Advance 36

Auto Ceiling 34

Auto Image 38

Auto Play 36

Auto Power 34

Autosource 34

B

Blank screen 37, 38

blinking green 16

blinking red 16

Brightness 12

C

cables

 optional 43

 standard 43

Ceiling 34

cleaning the lamp filter screens 42

cleaning the lens 39

Color 15, 31

Color Control 33

Color Space 33

Color Temperature 33

colors are incorrect 22

Computer 2 connector 8

computer connections

 optional 7

 required 7

computer image

 optimize 29

 troubleshooting 17

connecting

 computer 7

 external speakers 28

 USB device 8

 video device 13

connector panel 6

contacting InFocus 24

Contrast 12, 15, 31

customer service contact information 24

D
Display Messages 34
displaying
 computer image 9
 JPEG image 27
 video image 14
displaying JPEG images with LitePort player 27
Drivers 10
 USB 11
 Windows 98 11

E
Effect Key 38
elevator foot 12

F
Factory Reset 38
first time use
 driver installation 10
Fit to Screen 36
focus 12, 15
Freeze 38
fuzzy image 18

I
image
 display computer 9
 display JPEG 27
 display video 14
image does not fit screen 21
image not centered 23
image not sharp 21
image not square 21
image reversed 22
image size matrix 44
image upside down 22
Interactive Display 5

K
keypad buttons 25
keystone 12, 31

L
lamp
 cleaning filter screens 42
lamp replacement 40
Lamp Reset 38
lamp screens, cleaning 42
lamp won't turn on 23, 24
Language 38
laptop
 connecting 7
 external video port 9

LED
 blinking green 16
 blinking red 23
 solid green 16
 solid red 24
LED behavior 16
lens cap tether 5

- lens, cleaning 39
- leveling foot 12
- LitePort
 - connector 6, 8
 - menu 36
 - player 6, 8, 27, 36
 - player modes 27
 - Rotate effect key 38
 - rotating images 38
- LitePort Utility software 6
- LiteShow 6
- lock, security 39
- Low Power 34

M

- Macintosh troubleshooting 19
- Main menu 30
- menu system 30
- Monitor connector 8
- Monitor Out Enable 34
- Mute 38

N

- no computer image 18
- no startup screen 17

O

- online registration 5
- only startup screen appears 17
- onscreen menus 30
- optional accessories 43
- Overscan 33

P

- Picture menu 31
- Play All 36
- Position 33
- power cable 7, 13
- Power Save 16, 35
- PowerPoint, advancing slides 7
- Power-up Source 34
- presentation features 29
- projected image sizes 44
- projector
 - adjusting the height 12, 14
 - connector panel 6
 - customizing 29
 - LitePort player 8, 27
 - optional accessories 43
 - positioning 12
 - shutdown 16
 - standard accessories 43
 - troubleshooting problems 16
 - USB connector 8

R

- Rear 34
- registering your projector 5
- remote control 26
 - advancing slides 26
 - Effect key 26
 - not working 20
 - Previous/Next buttons 26
- replacing the lamp 40
- Reset 38
- resetting the lamp timer 41
- resolution 5
- RS-232 6, 8

S

- safety considerations 4
- Screen Save 16, 35
- Screen Saver 35
- screens, cleaning 42
- security lock 39
- serial connection 8
- Service 38
- Settings menu 34
- Sharpness 33
- shutting down the projector 16
- Slide Transition 36
- solid green 16
- solid red 16
- Source troubleshooting 17
- Sources 34
- speakers, connecting 28
- standard accessories 43
- Startup Logo 37
- S-video connector 13
- Sync Threshold Adjust 33

T

- Tint 15, 31
- Tracking 33
- Troubleshooting 16, 17
- Turning off the projector 16

U

- USB drivers 11
- USB mass storage device 8
- USB, connecting 7
- using the keypad buttons 25

V

- VESA connector 8
- video connections
 - optional 13
 - standard 13
- Video connector 13
- video images, optimizing 29
- Video Standard 33

W

- White Peaking 33
- Windows 2000 11
- Windows 98 10
- Windows ME, XP 11
- wireless projection 6

X

- XGA 5

Z

- zoom 12, 15

Limited Warranty

Subject to the Limitations, Exclusions and Disclaimers hereof, InFocus Corporation (“InFocus”) warrants that the Projector, Lamps and Accessories (hereinafter collectively or individually referred to as “Product” as appropriate) purchased from InFocus, an InFocus distributor, or an InFocus reseller will conform to InFocus’ specifications and be free from defects in material or workmanship for the respective Limited Warranty period provided below. InFocus does not warrant that the Product will meet the specific requirements of the end-user customer.

If the Product while subject to this Limited Warranty, is defective in material or workmanship during the warranty period, then InFocus, at its option, will REPAIR or REPLACE the Product.

All exchanged parts and Products replaced under this Limited Warranty will become property of InFocus. InFocus’ sole obligation is to supply (or pay for) all labor necessary to repair the Product found to be defective within the Limited Warranty period and to repair or replace defective parts with new parts or, at the option of InFocus, serviceable used parts that are equivalent or superior to new parts performance. Limited Warranty periods are as follows:

- **Projector Product Limited Warranty Period (Excluding Lamps):** **Two (2) years** from date of purchase.
- **Lamp Product Limited Warranty Periods:** From the date of Projector Product purchase, the original installed lamp shall have a 90-day or 500 hours usage Limited Warranty Period, whichever comes first. Replacement Lamps purchased at the time of Projector Product purchase will have a 90-day or 500 hours usage Limited Warranty Period from the date of installation, whichever comes first. Replacement lamps purchased after the time of Projector Product purchase shall have a 90-day or 500 hours usage Limited Warranty Period from the date of replacement lamp purchase, whichever comes first.
- **Accessory Product Limited Warranty Period:** **one (1) year** from date of purchase.

WARRANTY LIMITATION AND EXCLUSION

THIS WARRANTY SETS FORTH INFOCUS’ MAXIMUM LIABILITY FOR ITS PRODUCT. THIS WARRANTY EXTENDS ONLY TO PRODUCTS PURCHASED FROM INFOCUS OR AN INFOCUS AUTHORIZED RESELLER. InFocus shall have no further obligation under the foregoing Limited Warranty if the Product has been damaged due to abuse, misuse, neglect, smoke exposure (cigarette or otherwise), accident, unusual physical or electrical stress, unauthorized modifications (including use of an unauthorized mount), tampering, alterations, or service other than by InFocus or its authorized agents, causes other than from ordinary use or failure to properly use the Product in the application for which said Product was intended. This Limited Warranty excludes Product cleaning, repair, or replacement of plastics due to cosmetic damage and damage as a result of normal wear. Product repair outside of the terms of the Limited Warranty will be on a time and materials basis. Prolonged Product “demonstration” causes unusual Product wear and is not considered normal use under the terms of this Limited Warranty.

The Accessory Product Limited Warranty covers the accessory item only and excludes normal wear. The Lamp Product Limited Warranty excludes expected lamp degradation.

Remanufactured Products and Software Products are exempt from the foregoing Limited Warranty. Please refer to the appropriate Remanufactured Product Limited Warranty or Software Product Limited Warranty for applicable Warranty information.

DISCLAIMER OF UNSTATED WARRANTIES

THE WARRANTY PRINTED ABOVE IS THE ONLY WARRANTY APPLICABLE TO THIS PRODUCT. ALL OTHER WARRANTIES, EXPRESS OR IMPLIED, INCLUDING, BUT NOT LIMITED TO, THE IMPLIED WARRANTIES OF MERCHANTABILITY AND FITNESS FOR PARTICULAR PURPOSE ARE DISCLAIMED. THERE ARE NO WARRANTIES THAT EXTEND BEYOND THE DESCRIPTION ON THE FACE HEREOF AND THE FOREGOING WARRANTY SHALL NOT BE EXTENDED, ALTERED OR VARIED EXCEPT BY WRITTEN INSTRUMENT SIGNED BY INFOCUS. SOME JURISDICTIONS DO NOT ALLOW LIMITATIONS ON HOW LONG AN IMPLIED WARRANTY MAY LAST, SO SUCH LIMITATIONS MAY NOT APPLY TO YOU.

Limited Warranty Period

The Limited Warranty periods hereof commence on the date of purchase by the end-user customer. These Limited Warranty provisions shall apply only to the end-user purchaser (first person or entity that purchased a new Product for personal or business use and not for the purpose of distribution or resale). SOME JURISDICTIONS MAY GRANT YOU CONSUMER RIGHTS WITH MINIMUM WARRANTY DURATION THAT DIFFER FROM THE DURATIONS PROVIDED HEREIN, AND INFOCUS WILL HONOR ALL SUCH CONSUMER RIGHTS.

To Be Eligible For Limited Warranty Coverage

Any person exercising a claim under this Limited Warranty must establish to the satisfaction of InFocus both the date of purchase and that the Product was purchased new. The sales receipt or invoice, showing the date of purchase of the Product is the proof of the date of purchase.

To Obtain Warranty Service

During the Limited Warranty period, to exercise this Limited Warranty, the purchaser must first contact 1) InFocus, 2) a service facility authorized by InFocus or 3) the place of original purchase. InFocus Customer Service – 1-503-685-8888 or visit www.infocus.com/service

For Warranty service, the purchaser will be advised to return or deliver the defective Product freight and all fees prepaid, to an InFocus Service Center or to a service facility authorized by InFocus. When returning Product to InFocus, a Service Request Number (SR #) is required and must be clearly displayed on the outside of the shipping carton or a similar package affording an equal degree of protection. InFocus or the service facility authorized by InFocus will return the repaired/replaced Product freight prepaid to the purchaser.

Products returned for Warranty service must be accompanied by a written letter that: (i) explains the problem; (ii) provides proof of date of purchase; (iii) provides the dealer's name; and (iv) provides the model and serial number of the Product. Upon request of InFocus Corporation or an authorized repair center for InFocus, proof of legal import must accompany the warranty repair Product, otherwise the Product must be returned to the place of original purchase, to the manufacturer (Purchaser must bear all tax, duty and freight), or the Purchaser must bear charges for the warranty repair.

No repair or replacement of Product or part thereof shall extend the Limited Warranty period as to the entire Product. Warranty on the repair part and workmanship shall only be effective for a period of ninety (90) days following the repair or replacement of that part or the remaining period of the Product Limited Warranty whichever is greater.

LIMITATION OF LIABILITY

IT IS UNDERSTOOD AND AGREED THAT INFOCUS' LIABILITY WHETHER IN CONTRACT, IN TORT, UNDER ANY WARRANTY, IN NEGLIGENCE OR OTHERWISE SHALL NOT EXCEED THE RETURN OF THE AMOUNT OF THE PURCHASE PRICE PAID BY PURCHASER AND UNDER NO CIRCUMSTANCES SHALL INFOCUS BE LIABLE FOR SPECIAL, INDIRECT, INCIDENTAL OR CONSEQUENTIAL DAMAGES OR LOST PROFITS, LOST REVENUES OR LOST SAVINGS. THE PRICE STATED FOR THE PRODUCTS IS A CONSIDERATION IN LIMITING INFOCUS' LIABILITY.

Limitation on Bringing Action - No action, regardless of form, arising out of the agreement to purchase the Product may be brought by purchaser more than one year after the cause of action has accrued.

Governing Law - Any action, regardless of form, arising out of the agreement to purchase the Product is governed by Oregon law.

Mandatory Arbitration – Any action, regardless of form, arising out of the agreement to purchase the Product is subject to mandatory arbitration. SOME JURISDICTIONS DO NOT ALLOW THE EXCLUSION OR LIMITATION OF INCIDENTAL OR CONSEQUENTIAL DAMAGES SO THE ABOVE LIMITATION OR EXCLUSION MAY NOT APPLY TO YOU. THIS LIMITED WARRANTY GIVES YOU SPECIFIC LEGAL RIGHTS, AND YOU MAY ALSO HAVE OTHER RIGHTS, DEPENDING ON JURISDICTION.

