

myprojectorlamps.com

**The most trusted, dependable name
in projector lamp sales.**



<http://www.myprojectorlamps.com>



<http://www.myprojectorlamps.ca>



<http://www.myprojectorlamps.eu>

The following projector manual has not been modified or altered in any way.

FCC Warning

This equipment has been tested and found to comply with the limits for a Class A digital device, pursuant to part 15 of the FCC Rules. These limits are designed to provide reasonable protection against harmful interference when the equipment is operated in a commercial environment. This equipment generates, uses, and can radiate radio frequency energy and, if not installed and used in accordance with the instruction manual, may cause harmful interference to radio communications. Operation of this equipment in a residential area is likely to cause harmful interference in which case the user will be required to correct the interference at his own expense.

Canada

This Class A digital apparatus complies with Canadian ICES-003.
Cet appareil numérique de la classe A est conforme à la norme NMB-003 du Canada.

Safety Certifications

UL, CUL, TÜV, NOM, IRAM

EN 55022 Warning

This is a Class A product. In a domestic environment it may cause radio interference, in which case the user may be required to take adequate measures. The typical use is in a conference room, meeting room or auditorium.

Declaration of Conformity

Manufacturer: InFocus Corporation

27700B SW Parkway Ave. Wilsonville, Oregon 97070 USA

European Office: Olympia 1, NL-1213 NS Hilversum, The Netherlands

We declare under our sole responsibility that the LP500 and LP530 projectors conform to the following directives and norms:

EMC Directive 89/336/EEC, Amended by 93/68/EEC

EMC: EN 55022

EN 55024

EN 61000-3-2

EN 61000-3-3

Low Voltage Directive 73/23/EEC, Amended by 93/68/EEC

Safety: EN 60950: 1992 + A1 + A2 + A3 + A4: 1997

June, 2001

Australian Certification C-tick mark

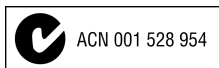

Trademarks

Apple, Macintosh, and PowerBook are trademarks or registered trademarks of Apple Computer, Inc. IBM and PS/2 are trademarks or registered trademarks of International Business Machines, Inc. Microsoft, PowerPoint, and Windows are trademarks or registered trademarks of Microsoft Corporation. Digital Light Processing is a trademark or registered trademark of Texas Instruments. InFocus and LP are trademarks or registered trademarks of InFocus Corporation.

TABLE OF CONTENTS

| | |
|---|------------|
| Safety Instructions | iii |
| Introduction | I |
| Image Resolution | 1 |
| Compatibility | 2 |
| Unpacking the Projector | 2 |
| Usage Guidelines | 5 |
| If You Need Assistance | 5 |
| Warranty | 6 |
| Setting up the Projector | 7 |
| Connecting a Computer | 9 |
| Connecting a Video Device | 10 |
| Using the optional enhanced connectivity module | 12 |
| Powering up the Projector | 14 |
| Turning Off the Projector | 18 |
| Using the Projector | 19 |
| Basic Image Adjustment | 19 |
| Adjusting the Projector | 19 |
| Using the Remote Control | 21 |
| Using the Keypad and Remote Buttons | 22 |
| Using the On-Screen Menus | 25 |
| Display Menu | 26 |
| Audio Menu | 28 |
| Image Menu | 29 |
| Color Management Menu | 32 |
| Control Menu | 33 |
| Advanced Menu | 34 |
| Language Menu | 35 |
| Status Menu | 36 |
| Projector Manager Software | 37 |
| Installing the Software | 37 |
| Using the Software | 38 |

| | |
|---|-----------|
| Maintenance & Troubleshooting | 45 |
| Cleaning the Lens | 45 |
| Replacing the Projection Lamp | 45 |
| Cleaning the Projection Lamp Filter Screens | 48 |
| Replacing the Batteries in the Remote Control | 49 |
| Using the Security Lock | 49 |
| Troubleshooting | 50 |
| | |
| Appendix | 55 |
| Specifications | 55 |
| Accessories | 56 |
| Portable and Laptop Activation Chart | 58 |
| Using Video Mirroring with a PowerBook Computer | 63 |
| Projected Image Size | 64 |
| | |
| Index | 65 |

SAFETY INSTRUCTIONS

Please read and follow all safety instructions provided BEFORE using your new projector. Failure to comply with safety instructions may result in fire, electrical shock, or personal injury and may damage or impair protection provided by equipment. Please save all safety instructions.

Safety Definitions:

- **Warning:** Statements identify conditions or practices that could result in personal injury.
- **Caution:** Statements identify conditions or practices that could result in damage to your equipment.

Safety Symbols:



Attention: For information about usage of a feature, please refer to the User's Guide.



Warning: Hot surface. Do not touch.



An arrow pointing to the lamp door on the projector.

Safety Terms:

- **Warning:** Don't look directly into the lens when the lamp is turned on.
- **Warning:** To replace the lamp, turn off the projector and unplug the power cord. To avoid burns, wait 30 minutes before opening the lamp door. Follow all instructions provided in this User's Guide.
- **Warning:** Please use the power cord provided. Connect the power cord to a receptacle with a protective safety (earth) ground terminal.
- **Warning:** Refer all service to qualified service personnel. Servicing your own projector will void the warranty. See the following page for the customer service contact information.
- **Caution:** Don't block ventilation openings.

- **Caution:** Don't set liquids on the projector. Spilled liquids may damage your projector.
- **Caution:** Don't place the projector on a hot surface or in direct sunlight.
- **Caution:** Do not drop the projector. Transport the projector in an InFocus-approved case; see page 56 for a list of cases.

Important Operating Considerations

Do not place the projector on a tablecloth or other soft covering that may block the vents. In the unlikely event of the bulb rupturing, thoroughly clean the area in front of the projector and discard any edible items placed in that area.

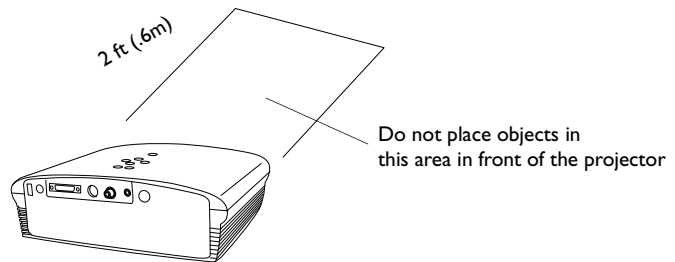

Customer Service

If you need assistance, call InFocus Customer Service directly at **1-800-799-9911**. Support is free between 6 a.m. and 6 p.m. PST, Monday through Friday. Support is available in North America after hours and weekends for a fee at 1-888-592-6800.

Or, send us an e-mail at techsupport@infocus.com.

In Europe, call InFocus in The Netherlands at **(31) 35-6474010**.

In Asia, call InFocus in Singapore at **(65) 353-9449**.

INTRODUCTION

The InFocus® LP500™ and LP530™ multimedia projectors are specifically designed for multipurpose use. They generate crisp, clear images using Digital Light Processing™ (DLP) technology. They are easy to connect, easy to use, easy to transport, and easy to maintain. The LP500 has native SVGA 800x600 resolution, the LP530 has XGA 1024x768 resolution. The user interfaces of the two products are identical except where noted; information in this user's guide applies to both products.

Image Resolution

LP500

The SVGA resolution of the LP500's projected image is 800x600. The projector is compatible with screen resolutions up to 1280x1024. If your computer's screen resolution is higher than 1280x1024, reset it to a lower resolution before you connect the projector.

LP530

The XGA resolution of the LP530's projected image is 1024x768. The projector is compatible with screen resolutions up to 1280x1024. If your computer's screen resolution is higher than 1280x1024, reset it to a lower resolution before you connect the projector.



NOTE: The LP500 automatically expands 640x480 images to 800x600. You can display these images at their native resolutions by turning off the Auto Resize feature. See "Resize" on page 29 for more information.



NOTE: The LP530 automatically expands 640x480 and 800x600 images to 1024x768. You can display these images at their native resolutions by turning off the Auto Resize feature. See "Resize" on page 29 for more information.



.....

NOTE: *The projector is compatible with 1080i and 720P HDTV formats.*

Compatibility

The projector is compatible with a wide variety of computers and video devices, including:

- IBM-compatible computers, including laptops, up to 1280x1024 resolution.
- Apple® Macintosh® and PowerBook® computers up to 1280x1024 resolution.
- Most standard VCRs, DVD players, HDTV sources, camcorders and laser disc players.

Unpacking the Projector

The projector comes with the items shown in Figure 1. Check to make sure all are included. **Contact your InFocus dealer immediately if anything is missing.**

If you are experienced in setting up presentation systems, use the *Quick Start* card that was included in the shipping box. For complete details on connecting and operating the projector, refer to this User's Guide. User's Guides are also available for download from our website at www.infocus.com.

A registration card is included in the box. Register to receive product updates, announcements, and special offers from InFocus. Or, register online at www.infocus.com/service/register and you will be automatically entered to win free merchandise.

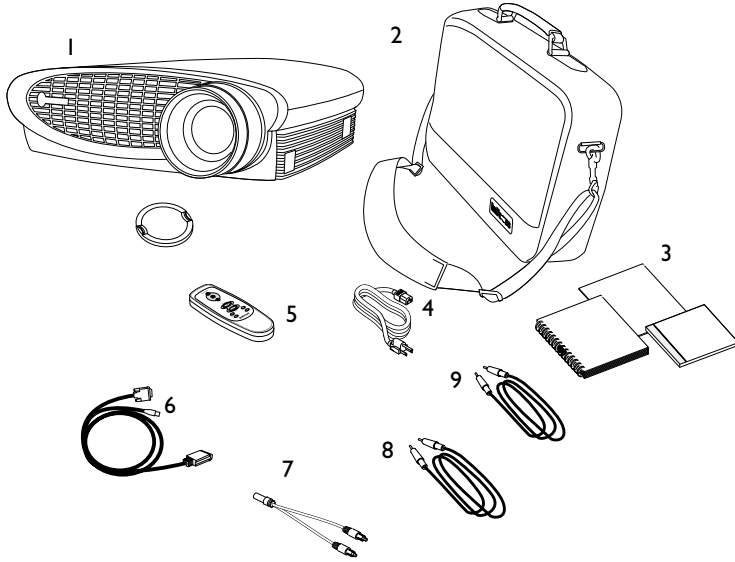

FIGURE I

Shipping box contents

- | | |
|---|--------------------------|
| 1. Projector + lens cap | 6. Computer cable |
| 2. Soft carry case | 7. Audio cable adapter |
| 3. User's Guide, quick start card and User Guide CD | 8. Audio cable |
| 4. Power cord | 9. Composite video cable |
| 5. Remote control | |

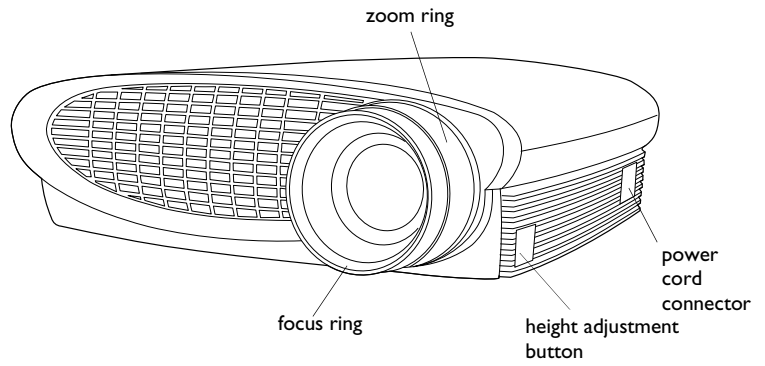

FIGURE 2

Front view of projector

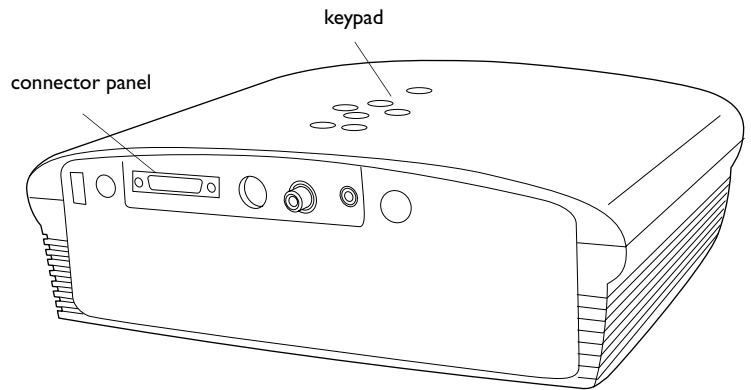

FIGURE 3

Back view of projector

Usage Guidelines

- Do not look directly into the projection lens when the lamp is turned on. The bright light may harm your eyes.
- Do not block the grills on the projector. Restricting the air flow can cause it to overheat and turn off. If this happens, you must wait a minute before attempting to turn it back on.
- Handle the projector as you would any product with glass components. Be especially careful not to drop it.
- Avoid leaving the projector in direct sunlight or extreme cold for extended periods of time. If this happens, allow it to reach room temperature before use.
- Transport the projector in a vendor-approved hard or soft case. Part numbers for these cases are listed on page 56.

If You Need Assistance

The first place to look for help is in this manual. Be sure to check the guidelines in “Troubleshooting” on page 50. Or, check the Service and Support section of our website at <http://www.infocus.com/service>. You’ll find a Technical Library, FAQs, and support contacts including a technical support e-mail form.

If those sources don’t answer your question, call your InFocus dealer. You can also call InFocus Technical Service directly at **1-800-799-9911**. Call between 6 a.m. and 6 p.m. PST, Monday through Friday. Service is available in North America after hours and on weekends for a fee at 1-888-592-6800.

In Europe, call InFocus in The Netherlands at **(31) 35-6474010**.

In Asia, call InFocus in Singapore at **(65) 353-9449**.

Or, send us an e-mail at techsupport@infocus.com

Our World Wide Web address is <http://www.infocus.com>.

Warranty

This product is backed by a limited two-year warranty. The details of the warranty are printed at the back of this manual. A longer term warranty can be purchased from your InFocus dealer. Refer to page 57 for the part number.

When sending your projector in for repair, InFocus recommends shipping the unit in its original packing material, or having a professional packaging company pack the unit for shipping. Do not ship your projector in the enclosed soft case. Please insure your shipment for its full value.

SETTING UP THE PROJECTOR

- 1 Place the projector on a flat surface.
 - The projector must be within 10 feet (3 m) of your power source and within 6 feet (1.8 m) of your computer.
 - If you want to project from behind a translucent screen, set up the projector behind your screen. See “Rear Project” on page 34 to reverse the image.
 - If you are installing the projector on the ceiling, refer to the installation guide that comes with the Ceiling Mount Kit for more information. To turn the image upside down, see “Ceiling Project” on page 34. The Ceiling Mount Kit is sold separately, see “Optional Accessories” on page 56.
- 2 Position the projector the desired distance from the screen.
 - The distance from the lens of the projector to the screen and the zoom setting determine the size of the projected image. Figure 4 shows three projected image sizes. For more information about image size, see “Projected Image Size” on page 64.

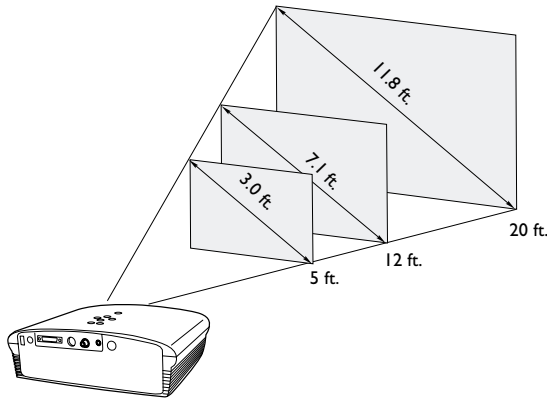

FIGURE 4

Projected image size at minimum zoom



NOTE: *The projector must be at least 5 feet (1.5 m) from the projection screen.*

- 3 Make sure the projector is unplugged and your computer is turned off.



NOTE: Before you continue, make sure the projector is unplugged and your equipment is turned off. If you're connecting a computer, make sure the distance between it and the projector is 6 feet or less.

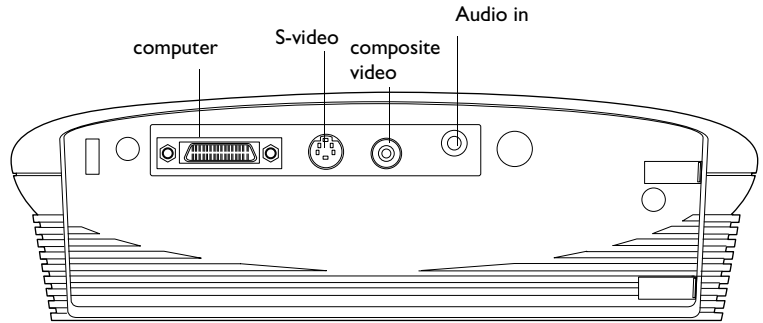

FIGURE 5
Connector panel



NOTE: The enhanced connectivity module is an optional accessory that provides RS-232, component video, VESA computer, M1 computer, and monitor loop through capabilities. See “Optional Accessories” on page 56 for ordering information.

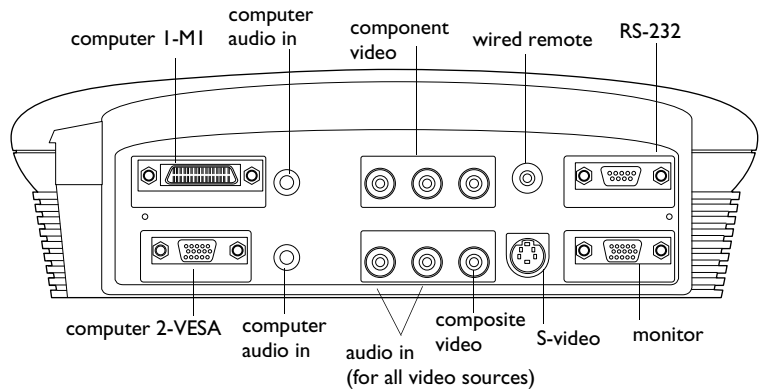

FIGURE 6
Connector panel on optional enhanced connectivity module

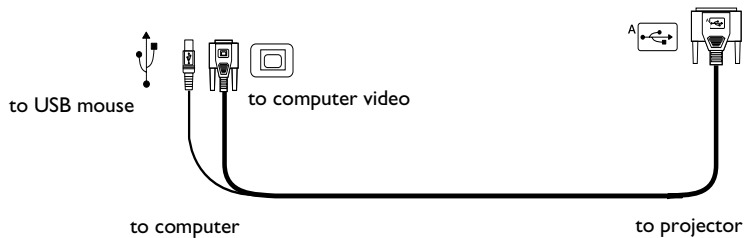

FIGURE 7
Computer cable

Connecting a Computer

The projector ships with an analog computer cable. If your computer has a digital output, you can order the optional digital computer cable. Using a digital source generates the highest quality and brightest image possible. See “Optional Accessories” on page 56.

- 1 Plug the end of the computer cable with one cable into the PC 1 connector on the projector.
- 2 Plug the blue end of the computer cable into the video connector on your computer.

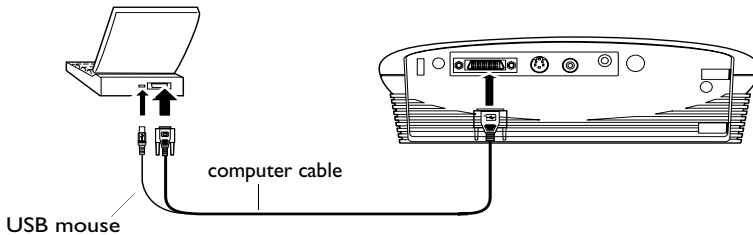

FIGURE 8

Connecting the projector to a computer

Do you want to advance slides in a PowerPoint™ presentation using the projector's remote?

- 1 Plug the USB cable into the USB mouse connector on your computer. To use the USB functionality, you must install the USB drivers. See page 16 for details.

Do you want to play your computer's audio on the projector?

- 1 Plug either end of the audio cable into the audio connector on your computer.
- 2 Plug the other end of the audio cable into the Audio In connector on the projector.

Now you're ready to power up the projector and your laptop. Skip to “Powering up the Projector” on page 14.



NOTE: Many laptop computers do not automatically turn on their external video port when a secondary display device such as a projector is connected. Refer to your computer manual for the command that activates the external video port. Activation commands for some laptop computers are listed in the Appendix of this manual on page 58 and in the Service section of our website.



NOTE: The USB functionality is supported for use with Windows 98, Windows ME, Windows 2000, and Apple OS 8.5 and higher only.





NOTE: You do not need to restart your computer after connecting a USB mouse to use it (it is hot-pluggable).



NOTE: HDTV sources are connected to the projector using the computer cable. See the previous pages for details.

Connecting a Video Device

- 1 If your video player uses a round, one-prong composite video connector, you'll need only the audio cable, audio adapter, and composite video cable that shipped with the projector.
 - If your video player uses a round, four-prong S-video connector, you'll need an S-video cable in addition to the audio cable and audio adapter. The S-video cable is sold separately. (See "Optional Accessories" on page 56.)
- 2 Plug the composite video cable's yellow connector into the "video-out" connector on your video player (Figure 9). This connector may be labeled "To Monitor."
- If you're using an S-video cable, connect it to the "S-video out" connector on the video player (Figure 10).
- 3 Plug the other yellow connector into the composite video connector  on the projector.
 - If you're using S-video, plug the other end of the cable into the "S-video" connector  on the projector (Figure 10).

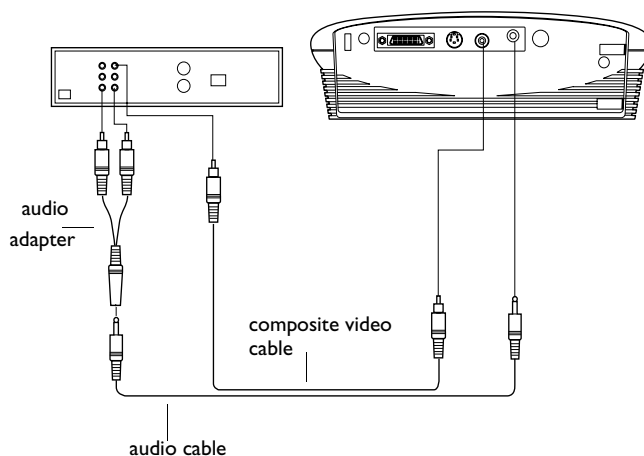

FIGURE 9

Connecting the projector to a video player using the standard video cable (with composite video connector) and the audio cable and adapter

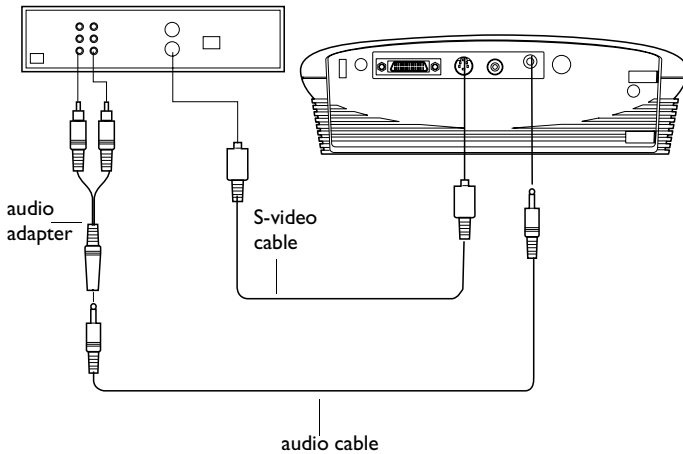

FIGURE 10

Connecting the projector to a video player using an S-video cable and the audio cable and adapter

- 4 Plug the audio adapter's white connector into the left "audio out" connector on your video player. Plug the adapter's red connector into the right "audio out" connector on the video player (Figure 9 and Figure 10).
- 5 Plug the audio adapter's other end into the audio cable.
- 6 Plug the audio cable into the "audio in" connector on the projector.

The projector is compatible with these major broadcast video standards: NTSC, NTSC 4.43, PAL, PAL-M, PAL-N, PAL-60, and SECAM. It automatically adjusts to optimize its performance for the incoming video.



NOTE: The audio adapter is provided so that the same audio cable used to connect a computer can be used with the adapter to connect a video device.



CAUTION: Your video player may also have a "Video Out" connector for a coaxial cable connection. **DO NOT** use this to connect to the projector.



NOTE: If you have turned Auto Source off (page 33), you may need to press the source button on the keypad more than once to display an active source. The sources switch in this order: PC 1-Analog, PC 1-Digital, PC 2-VESA, Video 3-Component, Video 1 S-Video, and Video 2-Composite.

Using the optional enhanced connectivity module

This module connects to the projector via the projector's computer connector. Slide the tabs in the module into the grooves on the back of the projector, then press the computer connector into the projector. To remove the module, press down on the textured lever on the top left of the module to release the latch, then slide the module off.

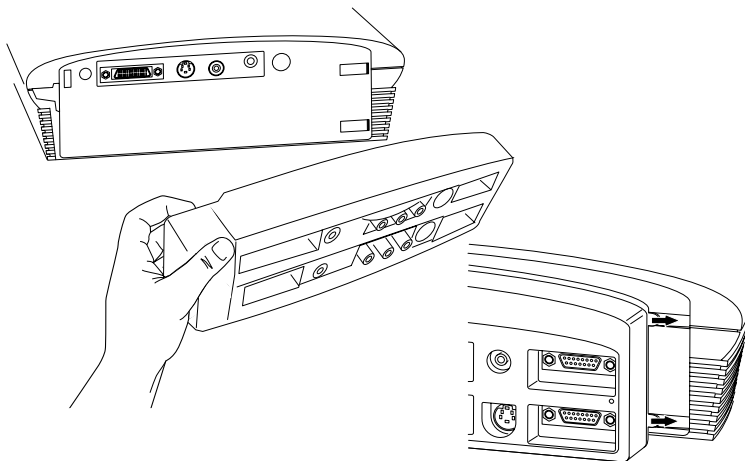

FIGURE 11

Connecting the optional connectivity module to the projector

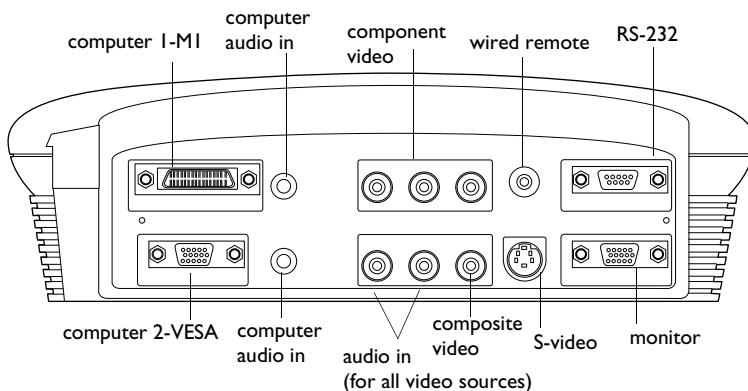

FIGURE 12

Connector panel on optional enhanced connectivity module

The module provides the following audio/video inputs:

| Source | Video | Audio |
|---------------------|--------------------------------------|------------------------------------|
| Computer 2 VESA | VESA Single-ended analog RGB (HD-15) | mini jack |
| Computer 1 M1-DA | M1-DA Single-ended analog or digital | mini jack |
| Component Video | Base-band component video (RCA) | Left and right line-level (2 RCAs) |
| Composite Video | Base-band composite video (RCA) | Left and right line-level (2 RCAs) |
| S-Video | S-video Y/C (4-pin circular) | Left and right line-level (2 RCAs) |

The module also provides wired remote input (used with an optional remote), monitor out (used to display images on your desktop computer's monitor as well as on the projection screen), and RS-232 input (to control the projector from an LCD control panel).



NOTE: Specific RS-232 commands can be found in the Service and Support section of our website at www.infocus.com.



NOTE: Always use the power cord that shipped with the projector.

Powering up the Projector

- 1 Remove the lens cap.
- 2 Plug the power cord into the side of the projector, then plug it into your electrical outlet. A surge-protected power strip is recommended.
 - The LED on the top of the projector (Figure 17 on page 22) lights green.
- 3 Turn on the lamp by pressing the green **power** button on the keypad or remote.
 - A tone sounds when you press the button, and the LED blinks green while the software initializes. When initialization is complete, the LED lights solid green and the InFocus startup screen appears.
- 4 If you connected a video player, turn it on.
 - The video image should display on the projection screen. If it doesn't, press the **source** button on the keypad or the **video** button on the remote to display your video image. You can select a default source to determine which source the projector examines first during power-up for active video; see "Default Source" on page 42.
 - Use the **volume** buttons to adjust the volume.
- 5 Turn on your computer.

For Windows 98:

- a The first time you connect a particular computer to the projector, the computer recognizes the projector as "new hardware" and the Add New Hardware Wizard appears. Follow these instructions to use the Wizard to load the correct driver (which was installed with your Windows operating system).



Click Next. Make sure “Search for the best driver” is selected, then click Next.

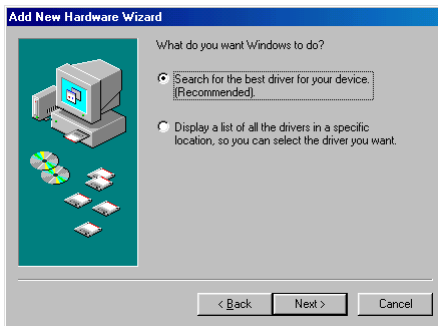

Uncheck any checked boxes, then click Next. Windows automatically locates the driver. If this driver has been removed, reload the driver using your Windows operating system CD.



When Windows finds the driver, you are ready to install it. Click Next.



NOTE: *The USB functionality is supported for use with Windows 98, Windows ME, Windows 2000, and Apple OS 8.5 and higher only. Windows NT is not supported.*

Click Finish when installation is complete.

- b** If you connected the USB cable (page 9), the Add New Hardware Wizard appears again. Drivers must be installed to use the USB functionality.

The Wizard is launched four times. The first time it detects a USB Composite Device, the second time a USB Human Interface Device (for the keyboard), the third time a USB Human Interface Device (for the mouse), and the last time an InFocus-specific driver used for Projector Manager, a software program included on the CD. The required drivers for the first 3 Wizards are located on your Windows operating system and on the Window operating system CD. If you do not want to use Projector Manager, you can simply cancel the final Wizard that asks for the InFocus LP500/530 driver.

If you want to install the Projector Manager driver, insert the InFocus CD into your CD-ROM drive. Make sure the “CD-ROM disk” checkbox is checked so the Wizard can locate the appropriate driver on the CD. (If you do not have the CD, you can download the driver from our website at www.infocus.com/service/software.) See page 37 for details on installing Projector Manager software.

For Windows 2000 and Windows ME:

- a The USB drivers are automatically installed. You only need to install an additional driver if you want to install the Projector Manager application. When the Add New Hardware Wizard appears asking for the InFocus LP500/530 driver, insert the InFocus CD into your CD-ROM drive. Make sure the “CD-ROM disk” checkbox is checked so the Wizard can locate the appropriate driver on the CD. (If you do not have the CD, you can download the driver from our website at www.infocus.com/service/software). See page 37 for details on installing Projector Manager software.

For a Macintosh computer running Mac OS X:

- a A Mac OS X driver and Control Panel will be available soon. The USB driver on the CD will not work in the Classic Mac OS environment provided in Mac OS X. You should boot OS 9.1 and follow the Mac OS 9.1 instructions.

For a Macintosh computer running Mac OS 9.1:

- a A dialog box appears stating that software is needed for the USB device. Click Cancel. We recommend installing Projector Manager software. See page 37 for details.
- 6 The computer image should display on the projection screen. If it doesn't, press the **source** button on the keypad or the **data** button on the remote to display your computer's image. Make sure your laptop's external video port is activated; see “Portable and Laptop Activation Chart” on page 58 for details.
- If necessary, make adjustments to the image using the projector's on-screen menus. To open the menus, press the **menu/select** button on the keypad or remote, then select the Display or Image sub-menu. For more information about the menus, see page 25.



.....

NOTE: *With some computers, the order in which you power up the equipment is very important. Most computers should be turned on last, after all other peripherals have been turned on. Refer to your computer's documentation to determine the correct order.*

Turning Off the Projector

If you want to turn off the projector for a short period of time, press the **standby** button on the keypad or remote. This blanks the screen for fifteen minutes, but keeps the projector running. (You can change the amount of time the projector stays in standby mode; see page 33 for details.) After 15 minutes, the lamp goes out. To exit standby mode, press the **standby** button again. (It may take several seconds for the projection lamp to reach full power and project the image again.) See page 24 for details on standby mode.



.....

NOTE: *Lamp life will be extended if you turn the power off, then wait 1 minute while the lamp cools before unplugging the projector. The Lamp LED will light green when the lamp has cooled.*

To turn off the projector, press the **power** button. The lamp turns off and the LED blinks orange for a minute while the fans continue to run to cool the lamp. When the lamp has cooled, the LED lights green and the fans stop. Unplug the power cord to completely power off the projector.

USING THE PROJECTOR

This section describes how to use and make adjustments to the projector. It also provides a reference to the keypad and remote buttons and the options available from the on-screen menus.

Basic Image Adjustment

- 1 Make sure you have powered up your equipment in the right order (page 14).
- 2 If the image doesn't display completely, zoom the image (page 19), adjust the height of the projector (page 20) or center the image by adjusting its horizontal or vertical position (page 31). Be sure the projector is at a 90 degree angle to the screen.
- 3 If the image is out of focus, rotate the focus lens (page 19).
- 4 If the colors don't look right, adjust the brightness, contrast, tint, or color (page 26).

Adjusting the Projector

To focus the image, rotate the focus ring (Figure 13) until the image is clear. To zoom the image, rotate the zoom ring. This adjusts the image size. You can also zoom in on part of the image, see page 24.

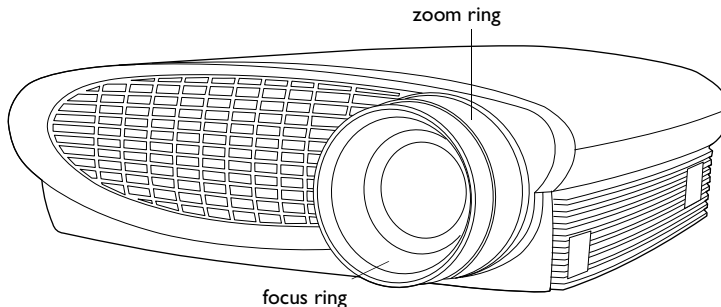

FIGURE 13

Focus ring and zoom ring



NOTE: To obtain the best overall focus quality, open the menu and focus on the text. This will ensure that the best overall image quality is achieved.

The projector is equipped with a self-locking, quick-release elevator foot and button.

To raise the projector:

- 1 Press and hold the elevator button (Figure 14).
- 2 Raise the projector to the height you want, then release the button to lock the elevator foot into position.

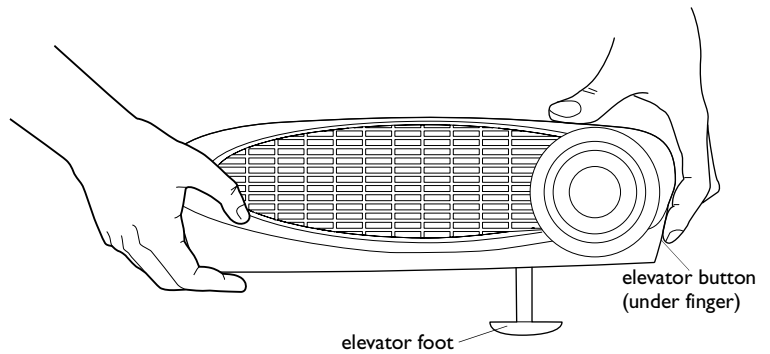

FIGURE 14

Adjusting the height of the projector

- 3 If necessary, turn the leveling knob to adjust the angle of the projected image.

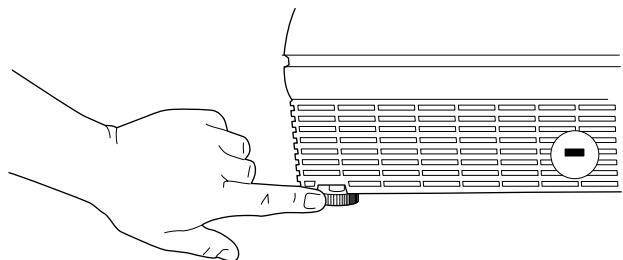

FIGURE 15

Turning the leveling knob

Using the Remote Control

To use the forward and backward buttons on the remote to advance slides in PowerPoint, you must connect the USB connector on the computer cable to the computer. See page 9 for details.

Point the remote control at the projection screen or at the front or back of the projector (not at the computer). The range for optimum operation is about 25 feet. If you point the remote at the projection screen, the distance to the screen and back to the projector must be less than or equal to 25 feet. For best results, point the remote directly at the projector.

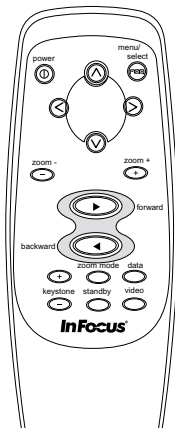

FIGURE 16

Remote control

Using the Keypad and Remote Buttons

While the menus are displayed, the volume, source, and standby buttons on the keypad act as menu navigation buttons. See “Using the On-Screen Menus” on page 25 for details.

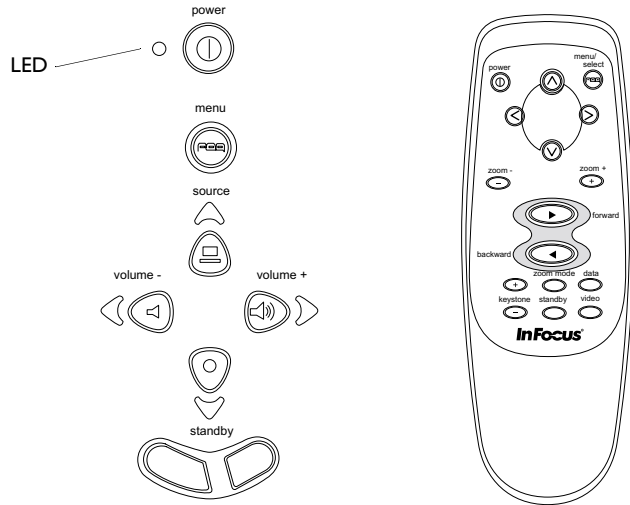

FIGURE 17

Keypad and remote buttons



NOTE: If you have turned Auto Source off (page 33), you may need to press the source button more than once to display an active source. The sources switch in this order: PC 1-Analog, PC 1-Digital, Video 1 S-Video, and Video 2-Composite.

Menu/select

Press the **menu/select** button to open the on-screen menus. Press **menu/select** again (while Exit is highlighted) to close the menus. (The menus automatically close after 30 seconds if no buttons are pressed.) When you close the menus, the projector saves any changes you made. For more information about the on-screen menus, see page 25.

Mouse buttons (keypad only)

Use the mouse buttons to zoom in and out on the image. See “Zoom mode” on page 24 for details.

Source (keypad only) **or Data and Video (remote only)**

When you have more than one source (computer and video) connected to the projector, select between them by pressing the **source** button on the keypad or the **data** or **video** button on the remote.

Keystone + - (remote only)

Use this feature to adjust the image vertically and make a squarer image.

- I Press the **keystone +** button to reduce the upper part of the image, and press the **keystone -** button to reduce the lower part. You can also adjust keystone from the Display menu (see page 26 for details on the menu).

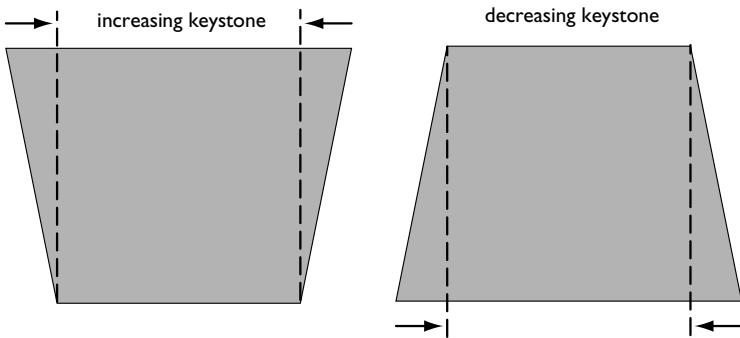

FIGURE 18

Adjusting the keystone

Forward/back buttons (remote only)

These buttons act like the page up and page down buttons on your computer's keyboard. You can use them to advance through a slide show in PowerPoint™ presentations. To use this feature, you must connect the USB mouse connector on the computer cable to your computer. See page 9 for details.

Up/down/left/right arrow buttons (remote only)

Use these buttons to navigate through and make adjustments to the on-screen menus. See "Using the On-Screen Menus" on page 25 for details.

Power button

This turns the lamp on and off. See page 14 for startup and shutdown details.

Zoom mode

This activates the zoom feature. When you press this button, the zoom icon appears in the lower right corner of the screen. Press the **zoom +** button to zoom in on part of the image, press the **zoom -** button to zoom out. When the image is zoomed, you can use the up/down/left/right arrow buttons to display a different part of the zoomed image (pan the image). Press **zoom mode** again to exit the mode and return the image to normal size.

You can also turn Zoom mode on using the Image menu and zoom and pan the image using the mouse buttons and arrows on the keypad. See page 30 for details.

Zoom +/-

This allows you to zoom in and out on a part of the image.

Standby

When you press **standby**, the display and audio turn off and a blank screen is displayed for 15 minutes. You can change the amount of time the projector stays in standby mode; see page 33 for details. The LED lights orange while the projector is in standby.

- If you press **standby** again within 15 minutes, the projector returns to normal operations immediately. The LED changes from orange to green.
- If you don't press **standby** again, the lamp turns off after 15 minutes. The LED blinks orange and the fans run while the projector cools down, then the projector shuts off and the LED lights solid green.

Volume (keypad only)

To increase the volume, press **volume +** . To decrease the volume, press **volume -** .

Using the On-Screen Menus

The projector has menus that allow you to make image adjustments and change a variety of settings. These adjustments aren't available directly from the keypad.

To open the on-screen menus, press the **menu/select** button on the keypad or remote. (The menus automatically close after 60 seconds if no buttons are pressed.) This displays the Main menu and changes the volume, source, and standby buttons on the keypad to menu navigation and adjustment buttons (the arrow LEDs around the buttons light green to indicate the change). Press the corresponding buttons to move the cursor up and down, or use the arrow buttons on the remote. The selected menu item is highlighted.

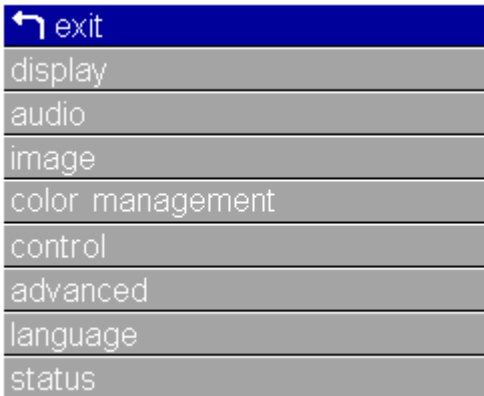

FIGURE 19

Main menu

To change a menu setting, use the up and down arrow buttons to move the cursor up and down to the item you want to change (the selected item is highlighted), then press **menu/select**. When an item is selected, its button appears depressed to provide a visual indication of selection. Use the left and right arrows to adjust the setting or turn it on and off. Press **menu/select** when you are done. Press the up and down arrows to move to another setting. When you have completed your adjustments, navigate to Exit, then press **menu/select**. You are returned to the top of the Main menu. Press **menu/select** again to exit the Main menu, or navigate to another submenu.



.....

NOTE: Some menu items may be grayed out (dimmed) at certain times. This indicates the item is not applicable to your setup or the item is not enabled until another selection is made.

Display Menu

To access the Display menu settings, press the **menu/select** button to display the Main menu, press the down arrow to highlight Display, then press **menu/select** again to access the Display menu.

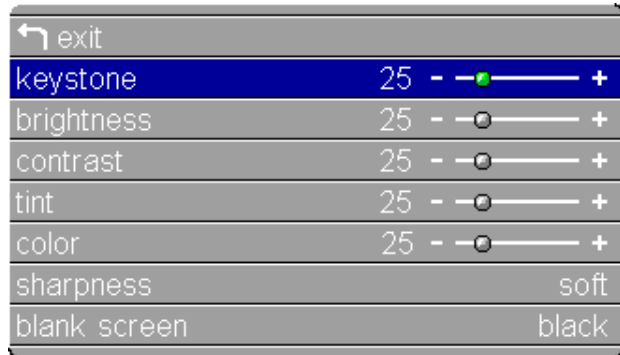

FIGURE 20

Display menu

Keystone

This option helps to keep the image square as the angle of projection is changed. Use this feature to adjust the image vertically and make a squarer image. See page 23 for details on keystone adjustments.

- I Press the down button to highlight Keystone, then press **menu/select**. Use the left and right arrows to adjust the keystone setting. Press **menu/select** to accept your changes.

Brightness

Adjusting the brightness changes the intensity of the image.

- I Use the up and down arrows to highlight Brightness, press **menu/select**, use the arrows to adjust the brightness, then press **menu/select** to accept your changes.

Contrast

The contrast controls the degree of difference between the lightest and darkest parts of the picture. Adjusting the contrast changes the amount of black and white in the image.

- Use the up and down arrows to highlight Contrast, press **menu/select**, use the arrows to adjust the contrast, then press **menu/select** to accept your changes.

Tint

The tint adjusts the red-green color balance in the projected image.

- Use the up and down arrows to highlight Tint, press **menu/select**, use the arrows to adjust the tint, then press **menu/select** to accept your changes.

Color

The color setting adjusts a video image from black and white to fully saturated color.

- Use the up and down arrows to highlight Color, press **menu/select**, use the arrows to adjust the color, then press **menu/select** to accept your changes.

Sharpness

This setting adjusts sharpness of a video image.

- Use the up and down arrows to highlight Sharpness, press **menu/select**, use the arrows to cycle through the options soft, med-soft, medium, med-hard, and hard, then press **menu/select** to accept your selection.

Blank screen

Blank Screen determines what color is displayed when there is no active source and when the projector is in standby.

- Use the up and down arrows to highlight Blank screen, press **menu/select**, use the arrows to cycle through the options blue, black, and white, then press **menu/select** to accept your selection.



NOTE: The color setting applies to video sources only. The tint setting applies to NTSC video sources only.

Audio Menu

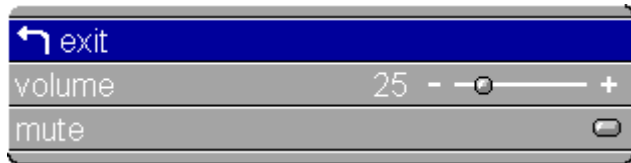

FIGURE 21

Display menu

Volume

You can also adjust the volume directly from the projector's keypad.

- 1 Use the up and down arrows to highlight Volume, press **menu/select**, use the arrows to adjust the volume, then press **menu/select** to accept your changes.

Mute

This mutes the sound.

- 1 Use the up and down arrows to highlight Mute, press **menu/select**, use the left or right arrow to turn mute on and off (a green dot indicates a feature is on), then press **menu/select** to accept your changes.

Image Menu

To access the Image menu settings, press the **menu/select** button to display the Main menu, press the down arrow to highlight Image, then press **menu/select** again to access the Image menu.

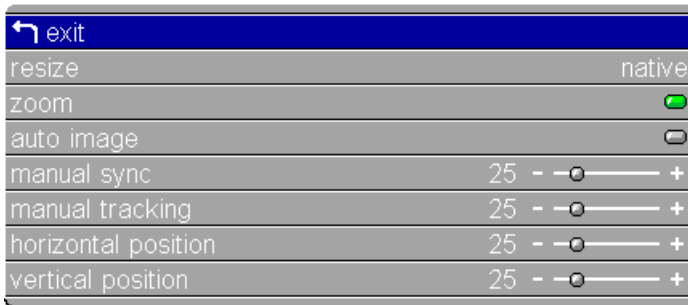

FIGURE 22

Image menu for computer sources

Resize

Resize allows you to select from among four different re-sizing options. The default is **Standard**, which resizes the image from its original version to fit a standard 4x3 aspect ratio screen. **Wide-screen Letterbox** preserves the 16x9 aspect ratio of the original theater version, but the image is placed in a 4x3 space, so black bars appear at the top and bottom of the image. **Enhanced Wide-screen** also preserves the aspect ratio of the original theater version and is designed to be used with content that is Enhanced for Widescreen TVs. This option yields more detail than Widescreen Letterbox. **Native** displays the image with no resizing.

Highlight **Resize**, press **menu/select**, use the left or right arrow buttons to cycle through the options, then press **menu/select** to select.

Zoom

This allows you to enter zoom mode without using the remote. Highlight **Zoom**, press **menu/select**, use the left or right arrow buttons to turn zoom mode on, then press **menu/select**. Exit the menus to use the zoom feature. The zoom icon appears in the lower right corner. Use the right mouse button to zoom in and use the left mouse button to zoom out. Use the keypad navigation buttons on the keypad to pan the zoomed image. To exit zoom mode, either turn the feature off in the Image menu or press the **zoom mode** button on the remote.

Auto Image

The projector automatically adjusts tracking, signal synchronization and vertical and horizontal position for most computers. If you want to adjust these features manually, you must turn off **Auto image** first.

Highlight **Auto image**, press **menu/select**, then press the left or right arrow buttons to turn this feature off and on.

Manual Sync

The projector adjusts signal synchronization automatically for most computers. But if the projected computer image looks fuzzy or streaked, try turning **Auto image** off then back on again. If the image still looks bad, try adjusting the signal synchronization manually:

- 1 Turn Auto Image off.
- 2 Highlight Manual sync, press **menu/select**, use the arrow buttons to adjust Manual sync until the image is sharp and free of streaks, then press **menu/select**.

Manual Tracking

The projector adjusts tracking automatically to match the video signal from your computer. However, if the display shows evenly spaced, fuzzy, vertical lines or if the projected image is too wide or too narrow for the screen, try turning **Auto Image** off then back on again. If the image is still bad, try adjusting the tracking manually:

- 1 Turn Auto image off.
- 2 Highlight Manual tracking, press **menu/select**, use the arrow buttons to adjust Manual tracking until the fuzzy vertical bars are gone, then press **menu/select**.



NOTE: The **Manual Sync**, **Manual Tracking**, **Horizontal Position** and **Vertical Position**

options are available only for analog computer sources. The projector sets these options automatically for digital computer and video sources, with no manual override.

Horizontal Position

Follow these steps to manually adjust the horizontal position:

- 1 Turn Auto image off.
- 2 Highlight Horizontal position, press **menu/select**, use the arrow buttons to adjust the Horizontal position, then press **menu/select**.

Positioning adjustments are saved when you turn off the projector.

Vertical Position

Follow these steps to manually adjust the vertical position.

- 1 Turn Auto image off.
- 2 Highlight Vertical position, press **menu/select**, use the arrow buttons to adjust the Vertical position, then press **menu/select**.

Positioning adjustments are saved when you turn off the projector.

Overscan (video sources only)

This option crops all the edges of the image to remove noise generated on the edges by your source. This option is available for video sources only.

Video Standard (video sources only)

When Video is set to Auto, the projector attempts to pick the video standard (NTSC, NTSC 4.43, PAL, PAL-M, PAL-N, PAL 60 or SECAM) automatically based on the input signal it receives. (The video standard options may vary depending on your region of the world.) If the projector is unable to detect the correct standard, the colors might not look right or the image might appear “torn.” If this happens, manually select a video standard.

Highlight **Video standard**, press **menu/select**, use the left or right arrows to cycle through the options, then press **menu/select** to select.

Color Management Menu

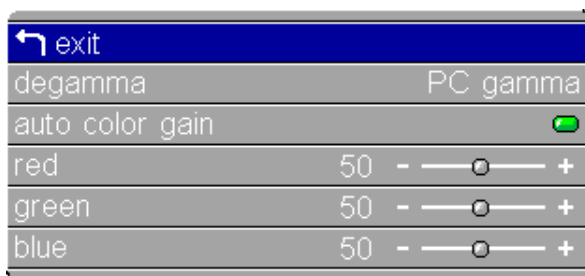

FIGURE 23

Color Management menu

Degamma

This allows you to select a gamma table that has been specifically tuned for either computer, video, or film input.

Highlight **Degamma**, press **menu/select**, use the left or right arrows to cycle through the options, then press **menu/select** to select.

Auto Color Gain

When this feature is On, the projector automatically sets the red, green, and blue color gains for each source. When it is off, you can manually adjust the color gains.

Red, Green, Blue

To manually adjust the color gains:

- 1 Turn Auto Color Gain off.
- 2 Highlight Red, Green, or Blue, press **menu/select**, use the arrow buttons to adjust the gain, then press **menu/select**.

The settings are saved for each source.

Control Menu

To access the Control menu settings, press the **menu/select** button to display the Main menu, press the down arrow to highlight Control, then press **menu/select** again to access the Control menu.

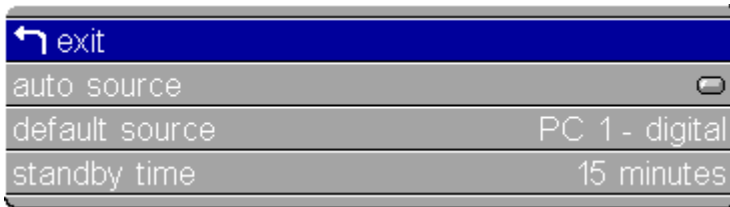

FIGURE 24

Control menu

Auto Source

When this feature is On, the projector automatically finds the active source, checking the default source first. When this feature is Off, the projector defaults to the source selected in Default Source. To display another source, you must manually select one by pressing the **source** button on the keypad or the **data** or **video** button on the remote.

Highlight **Auto source**, press **menu/select**, then press the left or right arrow buttons to turn this feature off and on.

Default Source

This determines which source the projector checks first for active video during power-up. Select among PC 1-Analog, PC 1-Digital, Video1 S-Video, and Video 2-Composite (also PC 2-VESA and Video 3-Component when using the optional connectivity module).

Highlight **Default source**, press **menu/select**, use the left or right arrows to cycle through the options, then press **menu/select** to select.

Standby Time

This option lets you select how long the lamp stays on and the blank screen is displayed when the projector enters standby mode before the projector turns off. Select among 1, 5, 10, 15 and 30 minutes and 1 and 2 hours by clicking the left or right arrow buttons and cycling through the options.

Advanced Menu

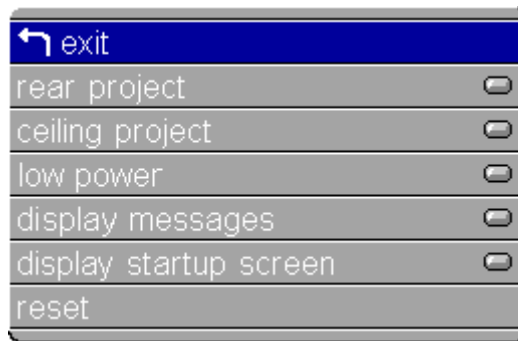

FIGURE 25

Advanced menu

Rear Project

When you turn **Rear Project** on, the projector reverses the image so you can project from behind a translucent screen.

Highlight **Rear Project**, press **menu/select**, then press the left or right arrow buttons to turn this feature off and on.

Ceiling Project

When you turn **Ceiling Project** on, the projector turns the image upside down for ceiling-mounted projection. Highlight Ceiling Project, press **menu/select**, then press the left or right arrow buttons to turn this feature off and on.

Low Power

This setting toggles between on and off. Turn it on to lower the light output of the lamp, thus extending its life. This also lowers the fan speed, making the projector quieter.

Display Messages

This setting toggles between On and Off. When this feature is On, status messages such as “No signal detected” or “Standby Active” appear in the lower-right corner of the screen.

Display Startup Screen

This setting toggles between On and Off. When this feature is On, the startup screen appears when the projector starts up and remains until an active source is detected. The startup screen contains contact information. When it is off, a plain black or blue screen is displayed instead of the startup screen.

Reset

Highlight Reset then press **menu/select** to reset the options in the menus (except Language, Video Standard, Ceiling and Rear Project, and Standby Time) to their original settings.

Language Menu



FIGURE 26

Language menu

You can display the on-screen menus in English, French, German, Spanish, Portuguese, Chinese, Japanese, or Korean.

- 1 Press the **menu/select** button to display the Main menu, press the arrow buttons to highlight Language, then press **menu/select** again to access the Language menu.
- 2 Press the arrow buttons to highlight the desired language, then press **menu/select**. Press **menu/select** to exit this menu and return to the Main menu.

Status Menu

This is a read-only menu for informational purposes. To display the Status menu, highlight Status from the Main menu, then press **menu/select**.

| | |
|---------------------|-----------------|
| ↩ exit | |
| lamp hours used | 39 |
| computer resolution | 1024x768 - 75Hz |
| source | PC 1 - analog |
| software version | 1013101310 |

FIGURE 27

Status menu

Lamp Hours Used

Indicates how many hours the current lamp has been in use. The counter starts at zero hours and counts each hour the lamp is in use. Replace the bulb when the brightness is no longer acceptable. See “Replacing the Projection Lamp” on page 45 for details.

Computer Resolution (computer sources only)

Shows your computer’s resolution setting. To change this, go to your computer’s Control Panel and adjust the resolution in the Display tab. See your computer’s user’s guide for details.

Video Format (video sources only)

Shows the video format being displayed.

Source

Indicates the active source, PC 1-Analog, PC 1-Digital, Video1 S-Video, and Video 2-Composite (also PC 2-VESA and Video 3-Component when using the optional connectivity module).

Software Version

Indicates the projector’s software version. This information is useful when contacting Technical Support.

PROJECTOR MANAGER SOFTWARE

This software is included on the Online CD. It allows you to adjust some projector settings directly from your computer, rather than from the projector's menus. The CD also contains a software driver that must be installed to use Projector Manager software.

Installing the Software

To install:

- 1 Connect the projector to your computer. Be sure to also connect the USB mouse connector. See page 9 for details.
- 2 Turn on the projector, then your computer.
- 3 Insert the Online CD into your computer's CD drive. The Registration page appears.
- 4 Click Register Later/Already Registered to advance to the next window, then choose your projector model from the pulldown menu.
- 5 Click the "Projector Manager" text to install the application. Follow the Installer's instructions to install Projector Manager software on your computer.
- 6 When installation is complete on a PC, click Exit to close the Online CD application. The Projector Manager icon is added to the computer's system tray. A green dot on the icon indicates a projector is connected to the computer, while a red dot indicates no projector is connected or there is an error. Double-click this icon to launch Projector Manager software.



NOTE: Projector Manager software requires Windows 98, Windows ME, or Windows 2000 or higher or Mac OS 9.1 and a USB port.



NOTE: When using a Mac, you must restart the computer after installation. The Projector Manager icon is added to the Control Strip, and is launched by clicking the icon and selecting "Configure Projector".

Using the Software

To launch the software, double-click the Projector Manager icon in the Control Panel or in the system tray. The Projector Manager software opens to the General menu.

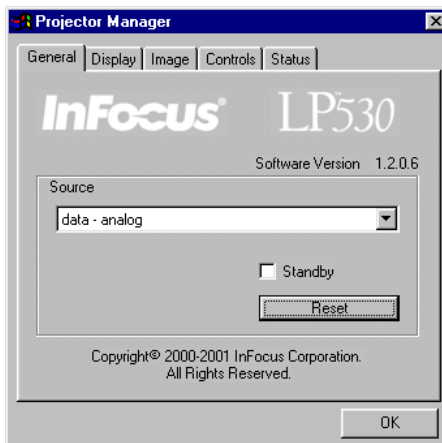

FIGURE 28

General menu

General menu

Choose the desired source from the Source pull-down menu to change the active source.

Click Standby to display a blank screen. You can select a black, blue, or white screen from the Display tab (see page 39).

Click Reset to reset the options in the menus (except Language, Video Standard, and Ceiling and Rear Project) to their original settings.

Display menu

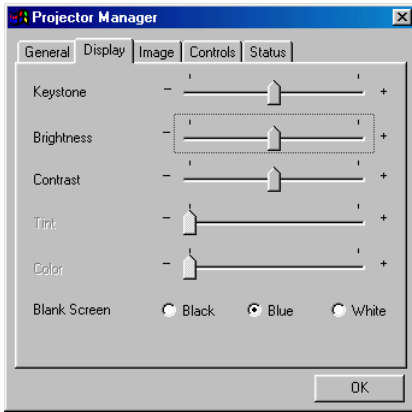

FIGURE 29

Display menu

Keystone

Use the slider bar to adjust the keystone setting. See page 23 for details on keystone.

Brightness, Contrast, Tint and Color

Use the slider bars to adjust Brightness, Contrast, Tint, and Color. See page 26 for a description of these settings.

Blank Screen

Blank Screen determines what color is displayed when there is no active source and when the projector is in standby. Click Blue, Black or White to specify the color.

Image menu

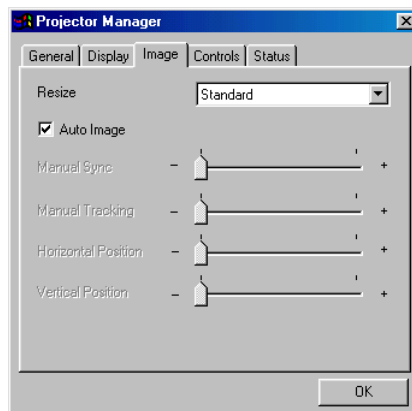

FIGURE 30

Image menu

Resize

Resize allows you to select from among four different re-sizing options. The default is **Standard**, which resizes the image from its original version to fit a standard 4x3 aspect ratio screen. **Widescreen Letterbox** preserves the 16x9 aspect ratio of the original theater version, but the image is placed in a 4x3 space, so black bars appear at the top and bottom of the image. **Enhanced Widescreen** also preserves the aspect ratio of the original theater version and is designed to be used with content that is Enhanced for Widescreen TVs. This option yields more detail than Widescreen Letterbox. **Native** displays the image with no resizing.

Auto Image

Click the check box to turn Auto Image on or off. The projector automatically adjusts tracking, signal synchronization and vertical and horizontal position for most computers. If you want to adjust these features manually, you must turn off **Auto Image** first.

Manual Sync

The projector adjusts signal synchronization automatically for most computers. But if the projected computer image looks fuzzy or streaked, try turning **Auto Image** off then back on again. If the image still looks bad, try adjusting the signal synchronization manually:

- 1 Turn Auto Image off.
- 2 Move the slider to adjust Manual sync until the image is sharp and free of streaks.

Manual Tracking

The projector adjusts tracking automatically to match the video signal from your computer. However, if the display shows evenly spaced, fuzzy, vertical lines or if the projected image is too wide or too narrow for the screen, try turning **Auto Image** off then back on again. If the image is still bad, try adjusting the tracking manually:

- 1 Turn Auto Image off.
- 2 Move the slider to adjust Manual tracking until the fuzzy vertical bars are gone.

Horizontal position

Follow these steps to manually adjust the horizontal position:

- 1 Turn Auto Image off.
- 2 Move the slider to adjust the Horizontal position.

Positioning adjustments are saved when you power off the projector.

Vertical position

Follow these steps to manually adjust the vertical position.

- 1 Turn Auto Image off.
- 2 Move the slider to adjust the Vertical position.



NOTE: The **Manual Sync**, **Manual Tracking**, **Horiz. Position** and **Vert. Position** options are available only for analog computer sources. The projector sets these options automatically for digital computer and video sources.

Controls menu

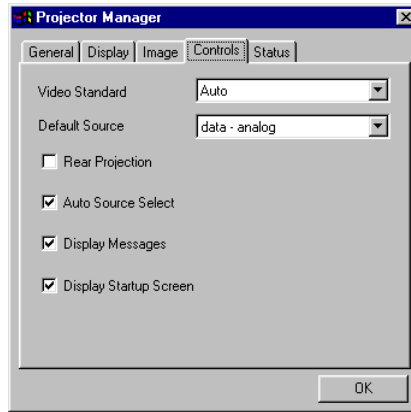

FIGURE 3 I

Controls menu



NOTE: *If you already know the video standard used in your geographical area, it's often best to manually select it.*

Video Standard

When Video standard is set to Auto, the projector attempts to pick the video standard (NTSC, PAL, PAL-M, PAL-N, or SECAM) automatically based on the input signal it receives. (The video standard options may vary depending on your region of the world.) If the projector is unable to detect the correct standard, the colors might not look right or the image might appear “torn.” If this happens, manually select a standard from the pull-down menu.

Default Source

This determines which source the projector checks first for active video during power-up. Select among Data-Analog, Data-Digital, Composite Video and S-Video from the pull-down menu.

Rear Projection

When you turn **Rear Projection** on, the projector reverses the image so you can project from behind a translucent screen. Click the check box to turn this feature on and off.

Auto Source Select

When this feature is Off, the projector defaults to the source selected in Default Source. To display another source, you must manually select one by pressing the **source** button on the keypad or the **data** or **video** button on the remote, or by using the Source option in Projector Manager. When this feature is On, the projector automatically finds the active source, checking the default source first. Click the check box to turn this feature on and off.

Display Messages

When this feature is On, status messages appear in the lower-right corner of the screen. Click the check box to turn this feature off and not see status messages.

Display Startup Screen

When this feature is On, the InFocus startup screen appears when the projector starts up and remains until an active source is detected. The startup screen contains information on contacting InFocus. Click the check box to turn this feature off and display a plain black, blue, or white screen instead of the startup screen.

Status menu

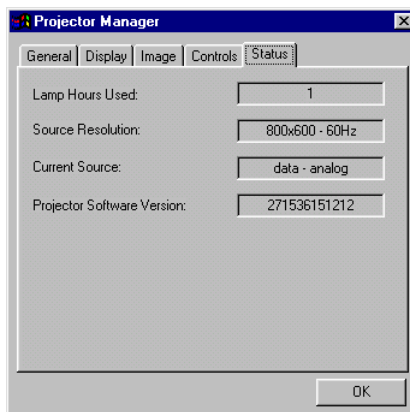

FIGURE 32

Status menu

Lamp Hours Used

Indicates how many hours the current lamp has been in use. The counter starts at zero hours and counts each hour the lamp is in use. Replace the bulb when the brightness is no longer acceptable. See “Replacing the Projection Lamp” on page 45 for details.

Source Resolution

Shows your computer’s resolution setting. To change this, go to your computer’s Control Panel and adjust the resolution in the Display tab. See your computer’s user’s guide for details.

Current Source

Indicates the active source, Data-Analog, Data-Digital, Composite Video and S-Video.

Projector Software Version

Indicates the projector’s software version. This information is useful when contacting Technical Support.

MAINTENANCE & TROUBLESHOOTING

This section describes how to:

- clean the lens
- replace the projection lamp
- clean the projection lamp filter screens
- replace the batteries in the remote
- use the security lock feature
- troubleshoot the projector

Cleaning the Lens

Follow these steps to clean the projection lens:

- 1 Apply a non-abrasive camera lens cleaner to a soft, dry cloth.
 - Avoid using an excessive amount of cleaner, and don't apply the cleaner directly to the lens.
 - Abrasive cleaners, solvents or other harsh chemicals might scratch the lens.
- 2 Lightly wipe the cleaning cloth over the lens in a circular motion.
- 3 If you don't intend to use the projector immediately, replace the lens cap.

Replacing the Projection Lamp

The lamp hour counter in the Status menu counts the number of hours the lamp has been in use. After 1,980 hours of use, the message "Change Lamp" temporarily appears on the screen when the projector is turned on. Change the lamp within the next 20 hours. After 2,000 hours, the lamp will not light. You can order new lamp modules from your InFocus dealer. See "Accessories" on page 56 for information.

Follow these steps to replace the projection lamp:

- 1 Turn off the projector and unplug the power cord.
- 2 Wait 30 minutes to allow the projector to cool thoroughly.



.....

WARNING: To avoid burns, allow the projector to cool for at least 30 minutes before you open the lamp module door. Never extract the lamp module while the projector is operating.



WARNING: Be extremely careful when removing the lamp module. In the unlikely event that the bulb ruptures, small glass fragments may be generated. The lamp module is designed to contain these fragments, but use caution when removing the lamp module.

- 3 Invert the projector on a soft flat surface, then push the ridge on the lamp door toward the back (Figure 33). The arrow on the lamp door should point to the unlock icon on the bottom of the projector. Lift the door up.

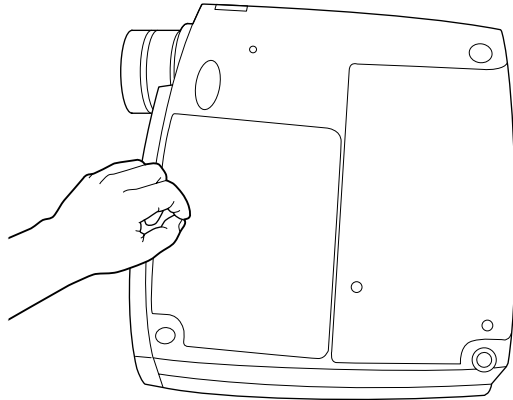

FIGURE 33

Removing the lamp door



CAUTION: Never operate the projector with the lamp door open or removed. This disrupts the air flow and causes the projector to overheat.

- 4 Loosen the two non-removable screws on the outside of the module (Figure 34).

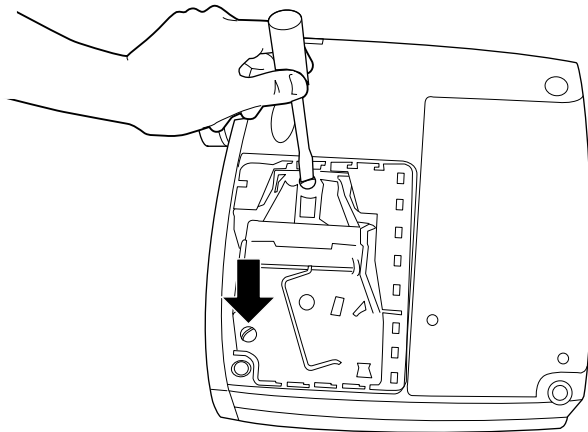

FIGURE 34

Loosening the screws on the lamp module

-
- 5 Lift and grasp the metal bail wire and lift the module out (Figure 35). Dispose of the lamp module in an environmentally proper manner.

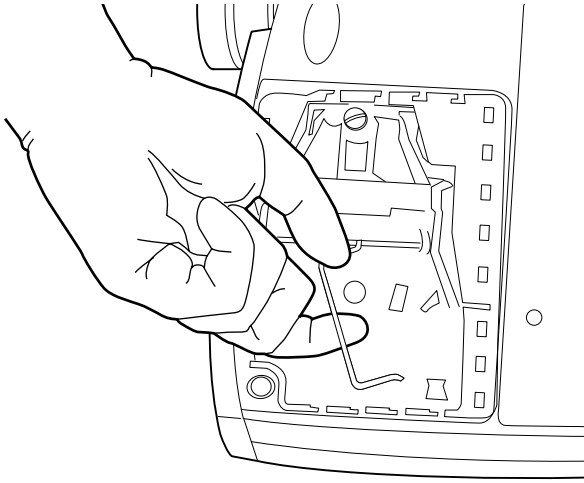

FIGURE 35

Removing the lamp module

- 6 Install the new lamp module, being sure to align the connectors properly.
- 7 Push the module in until it is flush with the bottom case of the projector.
- 8 Tighten the screws on the outside of the module.
- 9 Replace the lamp door by inserting the hooks on the lamp door into the slots on the projector and pressing the lamp door into place. The arrow on the lamp door should point to the lock icon on the bottom of the projector. If the lamp door does not fit properly or bulges out, remove the door and reseat the lamp module.
- 10 Plug in the power cord and press the green **power** button to turn the projector back on.
- 11 To reset the lamp hour counter in the Status window, press and hold the **volume -** button, then press the **source** button (while still holding down the **volume -** button) for 5 seconds. Verify that the counter was reset by viewing the counter in the Status window.



.....

WARNING: Do not drop the lamp module or touch the glass bulb! The glass may shatter and cause injury.

Cleaning the Projection Lamp Filter Screens

In dirty or dusty environments, the dust filter screens on the lamp module can become clogged, causing high temperatures inside the lamp module. These high temperatures can cause premature lamp failure. Routine maintenance to remove dust and dirt from the screens lowers the lamp operating temperature and prolongs lamp life. To maximize lamp life you may want to clean the screen every 250 hours.

- 1** Remove the lamp module. Refer to “Replacing the Projection Lamp” on page 45 for instructions.
- 2** Examine the dust filter screens on each side of the lamp module. If necessary, use compressed or canned air to clean the screens. Then use a cotton swab dipped in isopropyl alcohol to lightly wipe each screen. After you've wiped each screen, use the compressed or canned air to blow away remaining contaminants.

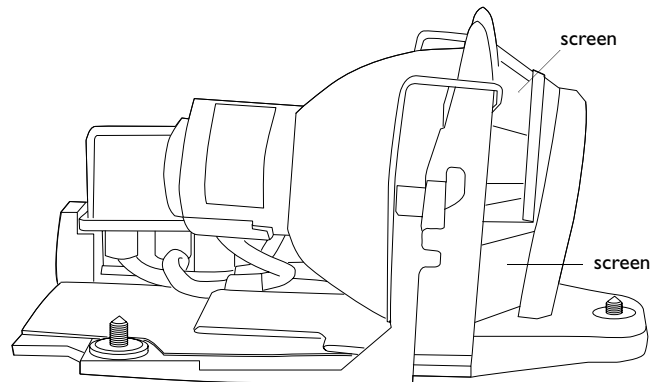

FIGURE 36

Lamp module screens

- 3** Before you replace the lamp, use the compressed or canned air to clean the lamp housing in the projector.
- 4** Replace the lamp and lamp door.

Replacing the Batteries in the Remote Control

The life of the batteries depends on how often and how long you use the remote. Symptoms of low battery charge include erratic responses when using the remote and a reduced range of operation.

Follow these steps to replace the batteries:

- 1 Turn the remote face down in your hand.
- 2 Push the tab on the battery door toward the top of the remote and lift the door off.
- 3 Remove the old batteries and dispose of them in an environmentally proper manner.
- 4 Install two new AAA alkaline batteries. Make sure you install each in the correct direction.
- 5 Insert the hooks on the battery door into the remote and press the tab to re-install the door.

Using the Security Lock

The projector has a security connector for use with a PC Guardian Cable Lock System (Figure 37). See “Optional Accessories” on page 56 for ordering information. Refer to the information that came with the lock for instructions on how to use it to secure the projector.

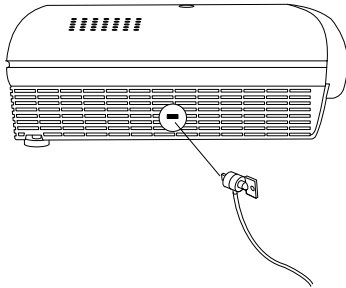

FIGURE 37

Installing the security lock

Troubleshooting

Problem: The projector is not running

- Make sure that the power cord is properly connected to a fully functional AC electrical outlet. Make sure that the power cord is also properly connected to the projector.
- If the projector is plugged into a power strip, make sure the power strip is turned on.
- Make sure the projector is turned on.

Problem: Projector is running, but nothing appears on projection screen

- Make sure you have removed the lens cap on the projection lens at the front of the projector.
- Check the projector's lamp to ensure that it is securely connected in the lamp module. Make sure the lamp door is installed. Make sure the lamp has not been in use for over 2,000 hours. The lamp automatically shuts off at 2,000 hours. See "Replacing the Projection Lamp" on page 45. A series of three fast blinking red LEDs indicates a lamp or fan failure.

Problem: Only the start-up screen displays

- Verify that the cables are connected correctly. See page 9 through page 10 for connection procedures.
- Make sure that the cables do not have any bent pins.
- Verify that the proper input source is connected. See "Source (keypad only) or Data and Video (remote only)" on page 22.
- You might need to turn everything off and power up the equipment again in the proper order. Refer to your computer's documentation to determine the correct order.
- Make sure your laptop's external video port is turned on. See the "Portable and Laptop Activation Chart" on page 58 or your computer's manual for details.
- Make sure your computer's video board is installed and configured correctly.

If you're using Windows 98:

- 1 Open "My Computer" icon, the Control Panel folder and then the Display icon.
- 2 Click the Settings tab.
- 3 Verify that the Desktop area is set to 1280x1024 or less.

Problem: Color or text not being projected

- You might need to adjust the brightness up or down until the text is visible. Refer to "Brightness" on page 26 for more information.

Problem: The screen resolution is not right

- Make sure the computer's video card is set for a resolution of no greater than 1280x1024.

Problem: Image isn't centered on the screen

- Move the projector to reposition the image.
- Reposition the image using the menu. Refer to "Horizontal Position" on page 31 and "Vertical Position" on page 31.
- Be sure the projector is at a 90 degree angle to the screen.

Problem: Image is too wide or narrow for screen

- Adjust the zoom or projector placement.
- Adjust the resolution of your video card if it's greater than 1280x1024.

Problem: Image is out of focus

- Turn the projection lens to focus the image.
- Make sure the projection screen is at least 5 feet (1.5 m) from the projector.
- Check the projection lens to see if it needs cleaning.

Problem: Image and menus are reversed left to right

- Rear projection mode is probably turned on. Turn Rear Projection off in the Controls menu. The image should immediately return to forward projection. See "Rear Project" on page 34.

Problem: the projector displays vertical lines, “bleeding” or spots

- Adjust the brightness. See “Brightness” on page 26.
- Check the projection lens to see if it needs cleaning.

Problem: no sound

- Adjust volume.
- Turn off “mute” in the menu. See page 28.
- Verify audio/input connections.
- Adjust audio source.

Problem: Image is “noisy” or streaked

Try these steps in this order.

- 1 Deactivate the screen saver on your computer.
 - 2 Turn **Auto Image** off and then back on again. See “Auto Image” on page 30.
 - 3 Turn **Auto Image** off and adjust the synchronization and tracking manually to find an optimal setting. See “Manual Sync” on page 30 and “Manual Tracking” on page 30.
- The problem could be with your computer’s video card. If possible, connect a different computer.

Problem: Projected colors don’t match the computer or video player’s colors

- Just as there are differences in the displays of different monitors, there are often differences between the computer image and the projected image. Adjust the brightness, tint and/or contrast from the Display menu. See “Brightness” on page 26, “Tint” on page 27 and “Contrast” on page 27.

Problem: Lamp seems to be getting dimmer

- The lamp begins to lose brightness when it has been in use for a long time. Replace the lamp as described in “Replacing the Projection Lamp” on page 45.

Problem: Lamp shuts off

- A minor power surge may cause the lamp to shut off. Unplug the projector, wait at least a minute, then plug it back in.
- Make sure the vents are not blocked.
- Make sure the lamp has not been in use for over 2000 hours. The lamp automatically shuts off after 2000 hours.

The most current troubleshooting information can be found in the Service and Support section of our website at <http://www.infocus.com/service>. You'll also find a Technical Library, FAQs, and support contacts including a technical support e-mail form.

Before calling your dealer or InFocus Technical Support for assistance, please have the following information available:

- the projector's serial number (located on the bottom label)
- the resolution of your computer.

Call InFocus Technical Support at **1-800-799-9911** between 6 a.m. and 6 p.m. PST, Monday through Friday. Service is available in North America after hours and on weekends for a fee at 1-888-592-6800.

In Europe, call InFocus in The Netherlands at **(31) 35-6474010** between 8 a.m. and 6 p.m. Central European Time.

In Asia, call **(65) 353-9449** between 9 a.m. and 6 p.m.

Or, send us an e-mail at techsupport@infocus.com

APPENDIX

Specifications

The projector must be operated and stored within the temperature and humidity ranges specified.

Temperature

| | |
|---------------|---|
| Operating | 50 to 104° F (10 to 40° C) at sea level 50 to 95° F (10 to 35° C) at 10,000 feet |
| Non-operating | -4 to 158° F (-20 to 70° C) |

Altitude

| | |
|---------------|---------------------------------|
| Operating | 0 to 10,000 feet (3,048 meters) |
| Non-operating | 0 to 20,000 feet (6,096 meters) |

Humidity

| | |
|-------------------------|--|
| Operating and non-oper. | 10% to 95% relative humidity, non-condensing |
|-------------------------|--|

Dimensions

10.25 x 3.34 x 11 inches (26 x 8.5 x 28 cm)
with module 10.25 x 3.34 x 12 inches (26 x 8.5 x 30.5 cm)

Weight

5.7 lbs. (2.6 kg) unpacked
with module 6.5 lbs. (2.9 kg)

Optics

| | |
|-------------|-----------------------|
| Focus Range | 5 - 16 feet (1.5-5 m) |
|-------------|-----------------------|

Lamp

| | |
|------|-------------------|
| Type | 270-watt SHP lamp |
|------|-------------------|

Input Power Requirements

100-120VAC 5A;50/60Hz
200-240VAC 3A; 50Hz

Accessories

Standard Accessories (ship with the projector)

| | Part Number |
|--|--------------|
| Quick Start card | 009-0581-xx |
| User's Guide | 010-0286-xx |
| Soft Case | 110-0423-xx |
| Shipping Box | 110-0421-xx |
| Analog Computer Cable 6 ft (1.8 m) | 210-0185-xx |
| Composite Video Cable 6 ft (1.8 m) | 210-0176-xx |
| Computer Audio Cable 6 ft (1.8 m) | 210-0118-xx |
| Audio Adapter (RCA to 3.5mm) | 210-0177-xx |
| Remote | 590-0409-xx |
| Projection Lamp Module (included in projector) | SP-LAMP-LP5E |
| Lens Cap | 505-0841-xx |
| Online CD-ROM | 010-0293-xx |



NOTE: Use only InFocus-approved accessories. Other products have not been tested with the projector.

Power Cords (one ships with projector, type depends on country)

| | |
|---------------------------|-------------|
| North American Power Cord | 210-0023-xx |
| Australian Power Cord | 210-0027-xx |
| UK Power Cord | 210-0028-xx |
| European Power Cord | 210-0029-xx |
| Danish Power Cord | 210-0030-xx |
| Swiss Power Cord | 210-0031-xx |



NOTE: You can purchase these items by contacting your dealer or InFocus Catalog Sales at 1-800-660-0024.

Optional Accessories

| | |
|--|------------|
| LP500/530 Enhanced Connectivity Module | HW-ECM |
| LP500/530 ATA Case | CA-ATA-005 |
| Deluxe Carry Case | CA-C132 |
| Deluxe Travel Case | CA-WHL-002 |
| Audio/Video Cable (30';9m) | SP-AV30 |
| Digital Computer Cable with USB | SP-DVI-D |

| | |
|---|------------------------------|
| 50' Mac Cable-Domestic | SP-MAC50-D |
| 50' Mac Cable-International | SP-MAC50-I |
| 15' VGA Extension Cable | SP-VGA15 |
| 50' VGA Cable-Domestic | SP-VGA50-D |
| 50' VGA Cable-International | SP-VGA50-I |
| USB Ranger 400 System | HW-USBRNGR4 HW-USBRNGR4-I |
| LP500/530 LM+ Ceiling Mount | SP-CEIL-LMP5 |
| Black LiteMount Pipe Tubing Extension | SP-LTMT-EXT |
| LiteMount False Ceiling Plate | SP-LTMT-PLT |
| Component Video Adapter Cable | 210-0206-xx |
| Appian Traveler (Digital/Analog CardBus PC Card) | SP-DVI-CARD |
| PC Guardian Projector Cable Lock | SP-LOCK |
| Executive Plus Remote | HW-EXPLUS |
| Executive Remote IR Receiver | HW-EXRCVR |
| Full-Feature LaserPro Remote Control | HW-LASERPRO |
| Remote Point RF Remote with Laser Pointer (US, Mexico, Canada, UK only) | HW-RF-POCKTPNT |
| GyroMouse Presenter RF Remote Control (US, Mexico, Canada, UK only) | HW-RF-GPRES |
| GyroMouse Pro RF Remote (US, Mexico, Canada, UK only) | HW-RF-GPRO |
| Remote Point RF Remote with LaserPointer (US and Canada only) | HW-RF-REMLSR |
| 1-in-2-out VGA Distribution Amplifier | HW-VGA2OUT |
| Deluxe Wheeled Projector and Computer Cart | HW-CART |
| Macintosh Adaptor | SP-MACADPT |
| 40" Portable Projection Screen | HW-PORTSCR40 |
| 50" Portable Projection Screen | HW-PORTSCR50 |
| 60" Deluxe Insta-Theatre Screen | HW-DLXSCRN |
| Portable Projector Stand | SP-STND |
| eBeam (Web Enabled Electronic Meeting Assistant) | HW-EBEAM |
| Projection Lamp Module | SP-LAMP-LP5E |
| 3 rd Year Extended Warranty (1 year extension) | EW-1YEAR |
| 4 th Year Extended Warranty (2 year extension) | EW-2YEAR |



NOTE: Visit our website at www.infocus.com for the most current activation chart. It is located in the Technical Library in the Service and Support section.



NOTE: Usually, pressing the key commands once activates the external video port, pressing it again activates both the external and internal ports, and pressing it a third time activates the internal port. Refer to your computer's documentation for details on your specific model.

Portable and Laptop Activation Chart

Many laptop computers do not automatically turn on their external video port when a projector is connected. Activation commands for some laptop computers are listed in the following table. (If your computer is not listed or the given command does not work, refer to the computer's documentation for the appropriate command.) On many laptops, the activation function key is labeled with an icon, for example  or the text CRT/LCD.

| Computer | Key command to activate port | Key command to de-activate port |
|-------------------------|--|--|
| Acer | Ctrl-Alt-Esc (for setup) | Ctrl-Alt-Esc (for setup) |
| AST* ** | FN-D or Ctrl-D Ctrl-FN-D FN-F5 type from A:/VGA/CRT FN-F12 | FN-D or Ctrl-D Ctrl-FN-D FN-F5 type from A:/VGA/CRT FN-F12 |
| AMS | FN-F2 | FN-F2 |
| AMT | setup screen | setup screen |
| AT&T | FN-F3 FN-F6 | FN-F3 FN-F6 |
| Advanced Logic Research | Ctrl-Alt-V | Ctrl-Alt-V |
| Altima | Shift-Ctrl-Alt-C setup VGA/ Conf.Simulscan | Shift-Ctrl-Alt-L setup VGA/ Conf.Simulscan |
| Ambra** | FN-F12 FN-F5 F2/Choose Option/F5 | FN-F12 FN-F5 F2/Choose Option/F5 |
| Amrel* ** | setup menu Shift-Ctrl-D | setup menu Shift-Ctrl-D |
| Apple | see Mac Portable and Mac PowerBook | |
| Aspen | automatic | automatic |
| Award | FN-F6 | FN-F6 |
| BCC* | automatic | reboot computer |

| Computer | Key command to activate port | Key command to de-activate port |
|------------------------|---|---|
| Bondwell | LCD or CRT options after bootup | reboot for LCD or CRT options to appear |
| Chaplet** | setup screen FN-F6 FN-F4 | setup screen FN-F6 FN-F4 |
| Chembook | FN-F6 | FN-F6 |
| Commax | Ctrl-Alt-#6 | Ctrl-Alt-#5 |
| Compaq* ** | Ctrl-Alt-< FN-F4 automatic mode/? (for setup option) | Ctrl-Alt-> FN-F4 automatic mode/? (for setup option) |
| Compuadd* ** | automatic Alt-F for screen setup option | automatic Alt-F for screen setup option |
| Data General | Ctrl-Alt-Command | Ctrl-Alt-Command |
| Data General Walkabout | 2 CRT/X at DOS prompt | reboot |
| Datavue | Ctrl-Shift-M | Ctrl-Shift-M |
| DEC** | FN-F5 FN-F4 | FN-F5 FN-F4 |
| Dell** | Ctrl-Alt-< Ctrl-Alt-F10 FN-F8 (CRT/LCD) FN-D FN-F12 | Ctrl-Alt-> Ctrl-Alt-F10 FN-F8 FN-D FN-F12 |
| Digital* | automatic FN-F2 | reboot FN-F2 |
| Dolch | dip switch to CRT | dip switch to LCD |
| Epson | dip switch to CRT | dip switch to LCD |
| Everex* | setup screen option | setup screen option |
| For-A | Ctrl-Alt-Shift-C | Ctrl-Shift-Alt-L |
| Fujitsu | FN-F10 | |

| Computer | Key command to activate port | Key command to de-activate port |
|-------------------------------|--|--|
| Gateway | FN-F3 FN-F1/FN-F1 again simultaneous | FN-F3 FN-F1 |
| Grid* ** | FN-F2, choose auto or simultaneous Ctrl-Alt-Tab | FN-F2 Ctrl-Alt-Tab |
| Hitachi | FN-F7 | FN-F7 |
| Honeywell | FN-F10 | FN-F10 |
| Hyundai | setup screen option | setup screen option |
| IBM 970* | automatic | warm reboot |
| IBM ThinkPad** | reboot, enter setup menu FN-F7, select choice from setup menu FN-F1, select choice FN-F5, select choice PS/2 SC select choice (CRT, LCD, etc.) | FN-F2 |
| Infotel | FN-F12 | FN-F12 |
| Kaypro | boot up, monitor plugged in | unplug monitor |
| Kris Tech | FN-F8 | FN-F8 |
| Leading Edge | FN-T | FN-T |
| Mac Portable 100 | no video port: not compatible | |
| Mac PowerBook | | |
| 140, 145, 150, 170 | no video port: requires a 3rd-party interface | |
| 160, 165, 180, 520, 540, 5300 | Control Panel folder, PowerBook Display folder; Activate Video Mirroring | warm reboot |
| 210, 230, 250, 270, 280, 2300 | requires Apple Docking Station or Mini Dock | |
| Magitronic | FN-F4 | FN-F4 |

| Computer | Key command to activate port | Key command to de-activate port |
|--------------------|--|--|
| Mastersport | FN-F2 | FN-F1 |
| Micro Express* | automatic | warm reboot |
| Micron | FN-F2 | FN-F2 |
| Microslate* | automatic | warm reboot |
| Mitsubishi | SW2 On-Off-Off-Off | SW2 Off-On-On-On |
| NCR | setup screen option | setup screen option |
| NEC* ** | setup screen option CRT at the DOS prompt FN-F3 | setup screen option LCD at the DOS prompt FN-F3 |
| Olivetti* | automatic FN-O/* | automatic FN-O/* |
| Packard Bell* ** | FN-F0 Ctrl-Alt-< | FN-F0 Ctrl-Alt-> |
| Panasonic | FN-F2 | FN-F2 |
| Prostar | Ctrl-Alt-S at bootup | Ctrl-Alt-S at bootup |
| Samsung* | setup screen option | setup screen option |
| Sanyo | setup screen option | setup screen option |
| Sharp | dip switch to CRT | dip switch to LCD |
| Sun SPARC-Dataview | Ctrl-Shift-M | Ctrl-Shift-M |
| Tandy** | Ctrl-Alt-Insert setup screen option | Ctrl-Alt-Insert setup screen option |
| Tangent | FN-F5 | FN-F5 |
| Texas Instruments* | setup screen option | setup screen option |
| Top-Link* ** | setup screen option FN-F6 | setup screen option FN-F6 |
| Toshiba* ** | Ctrl-Alt-End FN-End FN-F5 setup screen option | Ctrl-Alt-Home FN-Home FN-F5 setup screen option |
| Twinhead* | FN-F7 FN-F5 Automatic | FN-F7 FN-F5 Automatic |

| Computer | Key command to activate port | Key command to de-activate port |
|-----------------|-------------------------------------|--|
| WinBook | Ctrl-Alt-F10 | Ctrl-Alt-F10 |
| Wyse | software driven | software driven |
| Zenith** | FN-F10 | FN-F10 |
| | FN-F2 | FN-F2 |
| | FN-F1 | FN-F1 |
| Zeos** | Ctrl-Shift-D | Ctrl-Shift-D |
| | FN-F1 | FN-F1 |

* These manufacturers have models that automatically send video to the external CRT port when some type of display device is attached.

** These manufacturers offer more than one key command depending on the computer model.

Using Video Mirroring with a PowerBook Computer

When you turn video mirroring (called SimulScan in newer PowerBooks—see below) on, the projector displays the same information that appears on your PowerBook's built-in screen. When video mirroring is off, the projector acts like a separate display.

To turn on video mirroring for the first time:

- 1 Open the Monitors control panel; click on Monitor 2.
- 2 Set the number of colors you want.
- 3 Open the Control Strip, then click on the monitor icon.
- 4 Select "Turn Video Mirroring On."

Now you can turn video mirroring on and off from the Control Strip without having to open the Monitors control panel again.

When using video mirroring and high color graphics such as slide shows, the projected image occasionally might turn black and white. If this happens, perform the following steps:

- 1 Turn off video mirroring.
- 2 Open the Monitors control panel.
- 3 Move the white menu bar to Monitor 2 to set the projector as the primary monitor.
- 4 Restart the PowerBook.

Using SimulScan

Some newer PowerBooks display images on an external monitor or projector differently than previous ones. When using SimulScan, the projector displays the same information that appears on your PowerBook

To select SimulScan:

- 1 Open the Control Panel, then double-click Monitors and Sound.
- 2 In the Resolution list, choose the SimulScan mode, then click OK.
- 3 If this changes your display settings, a dialog box appears. Click OK to confirm the change.



Projected Image Size

NOTE: Use the graph and table to help you determine projected image sizes.

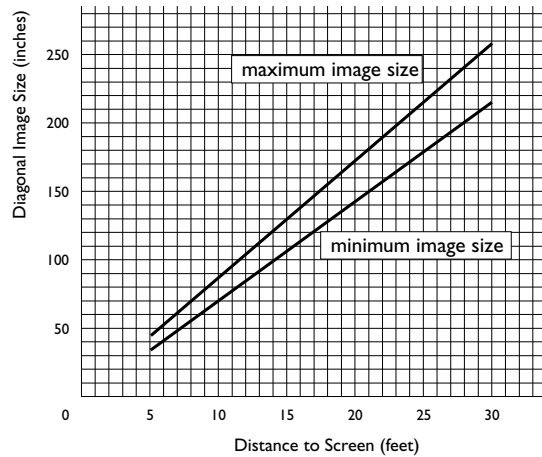

FIGURE 38

Projected image size



NOTE: Visit our website at www.infocus.com for an interactive image size calculator. It is located in the Technical Library in the Service and Support section.

*Table 1:
Range of distance to the screen for a given screen size*

| Diagonal Screen Size (inches) | Image Width (inches) | Distance to screen | |
|-------------------------------|----------------------|-------------------------|-------------------------|
| | | Maximum distance (feet) | Minimum Distance (feet) |
| 60 | 48 | 8.5 | 6.9 |
| 72 | 58 | 10.2 | 8.3 |
| 84 | 67 | 11.9 | 9.7 |
| 90 | 72 | 12.7 | 10.4 |
| 100 | 80 | 14.1 | 11.6 |
| 120 | 96 | 17.0 | 13.9 |
| 150 | 120 | 21.2 | 17.4 |

INDEX

A

- accessories, ordering 56
- activation commands for laptop computers 58
- Add New Hardware Wizard 14
- adjusting
 - brightness 26
 - color 27
 - color gain 32
 - contrast 27
 - height of the projector 20
 - keystone 26
 - tint 27
 - volume 24
- Advanced menu options
 - Ceiling Project 34
 - Display Messages 34
 - Display Startup Screen 35
 - Low Power 34
 - Rear projection 34
 - Reset 35
- altitude limits 55
- assistance. See Technical Support
- audio cable, connecting 9
- Audio menu options
 - Mute 28
 - Volume 28
- Auto color gain 32
- auto image 30
- auto source 33

B

- brightness, adjusting 26
- buttons on keypad
 - Menu/select 22
 - Power 23
 - Source 22
 - Standby 24
 - Volume 24

C

- cables
 - audio 9
 - composite video 10
 - computer cable 3, 8, 9
 - ordering 56
 - power 56
 - S-video 10
- cases, ordering 56
- ceiling projection 34
- centering the image 20, 31, 41
- cleaning the lamp filter screens 48
- cleaning the projection lens 45
- Color Management menu options
 - Auto color gain 32
 - Degamma 32
- color, adjusting 27
- colors
 - don't match monitor colors 52
 - not displayed 51
- compatibility
 - IBM-compatible 2
 - Macintosh 2
- component video 12
- composite video 10
- computers
 - compatible 2
 - connecting 9
- connecting
 - audio cable 9
 - computers 9
 - power cord 14
 - remote 9
 - USB mouse 9
 - video device 10
- connectivity, enhanced 12
- contrast, adjusting 27
- Control menu options
 - Auto source 33
 - Default Source 33
 - Standby Time 33

D

- Default Source 33
- Degamma 32
- Display menu options
 - Blank screen 27, 39
 - Brightness 26
 - Color 27
 - Contrast 27
 - Keystone 26
 - Sharpness 27
 - Tint 27
- Display Messages 34
- Display Startup Screen 35
- displaying on-screen menus 22
- drivers, installing 14

E

- elevator button/foot 20
- enhanced connectivity module 12

F

- focusing the image 19
- forward/back buttons 23
- fuzzy lines 30, 41

H

- HDTV 2, 10, 27
- height adjustment 20

I

- IBM-compatible computers 2
- image
 - adjusting 14, 19
 - centering 31, 41
 - colors don't match computer's 52
 - focusing 19
 - fuzzy lines 30, 41
 - has lines or spots 52
 - not centered 51
 - not displayed 50
 - out of focus 51
 - quality 51–52
 - resolution 1
 - reversed 34, 42, 51
 - size 7, 64
 - streaked 52
 - too wide or too narrow 51
 - zooming 19
- Image menu options
 - Auto Image 30
 - Horiz. Position 31, 41
 - Manual Sync 30, 41
 - Manual Tracking 30, 41
 - Overscan 31
 - Resize 29
 - Vert. Position 31, 41
 - Video Standard 31
 - Zoom 30
- installing drivers 14
- installing Projector Manager software 37

K

- keypad 22

L

- lamp
 - cleaning filter screens 48
 - ordering 56, 57
 - replacing 45
 - turns off unexpectedly 53
- lamp hour counter 36, 44, 45, 47
- Language menu 35
- language, selecting for menus 35
- laptop computers
 - activation sequence to allow secondary display 58
 - compatibility 9
 - connecting 9
- LED 22, 24
- lens
 - cap 56
 - cleaning 45
- low power mode 34
- LP500/530
 - cases 56
 - project from behind the screen 34
 - setting up 7
 - specifications 55
 - turning off 18
 - turning on 14

M

- M1-DA analog computer cable 3, 8
- Macintosh computers
 - compatibility 2
 - installing drivers 17
- menus. See on-screen menus
- monitor loop-through 12
- monitor, projected colors don't match 52
- mouse buttons 22
- mouse, connecting 9
- mute 28

N

- NTSC video 31, 42

O

- on-screen menus
 - changing language of 35
 - displaying 25
 - overscan 31
- ## P
- PAL video 31, 42
 - Power button 14, 23
 - power cord
 - connecting 14
 - ordering 56
 - power up sequence 17, 50
 - PowerPoint slides, advancing with the remote 9, 23
 - project from behind the screen 34, 42
 - project from the ceiling 34
 - Projector Manager software 37

R

- rear projection 34
- remote control
 - advancing PowerPoint slides with 9, 23
 - connecting 9
 - controlling the computer with 9
 - replacing the batteries 49
 - using 21, 22
- replacing projection lamp module 45
- re-positioning the image on the screen 31, 41
- resetting adjustments 35
- resetting the lamp hour counter 47
- resizing the image 29
- resolution 1
- RS-232 control 13

S

- safety guidelines iii
- SECAM video 42
- security lock 49, 57
- sharpness 27
- SimulScan, using with PowerBooks 63
- Source button 22
- specifications 55
- standby 18, 24
- standby time 33
- Status menu 36
- S-video, connecting 10

T

- Technical Support
 - in Europe 5
 - in USA 5
 - information to have on hand
 - before you call 53
- temperature limits 55
- test pattern 50
- text not visible 51
- tint, adjusting 27
- troubleshooting 50
- turning off the projector 18
- turning on the projector 14

U

- USB mouse
 - connecting 9
 - installing drivers 14

V

- vertical lines displayed 30, 41, 52
- VESA connector 12
- video mirroring on a PowerBook 63
- video resize 31
- video standards 31, 42
- Volume buttons 24
- volume, adjusting 24

W

- widescreen video 29, 40

Z

- Zoom mode 24
- zooming the image 19, 24, 30

LIMITED WARRANTY

ASK, InFocus, Proxima-Branded Products

InFocus Corporation (“InFocus”) warrants that the ASK, InFocus, and Proxima-branded product (“Product”) purchased from InFocus or an InFocus reseller will conform to the manufacturers specifications and be free from defects in material or workmanship for the Warranty period provided below. InFocus does not warrant that the Product will meet the specific requirements of the end-user customer. The Limited Warranty period commences on the date of purchase by the end-user customer. Said Limited Warranty shall apply only to the end-user purchaser (first person or entity that purchases a new Product for personal or business use and not for the purpose of distribution or resale). Any person exercising a claim under this Limited Warranty must establish to the satisfaction of InFocus both the date of purchase and that the Product was purchased new. The sales receipt or invoice, showing the date of purchase of the Product is the proof of the date of purchase.

From the date of such purchase, said Limited Warranty shall continue for a period of two (2) years (parts and labor) for Projector Products; for one (1) year (parts only) for customer replaceable and Accessory Products; and for ninety (90) days or 500 hours (parts only), whichever comes first, for Lamp Products (whether purchased in projectors or separately as replacements). During the Warranty period for the Product, Replacement lamps, which are purchased at the time of projector purchase, will have a 90-day or 500 hour Warranty, whichever comes first, from the date the spare lamp is put into use.

At the sole option of InFocus, the Product will either be repaired or replaced. All exchanged parts and Products replaced under this Warranty will become property of InFocus. InFocus’ sole obligation is to supply (or pay for) all labor necessary to repair the Product found to be defective within the Warranty period and to repair or replace defective parts with new parts or, at the option of InFocus, serviceable used parts that are equivalent or superior to new parts performance.

During the Warranty period, to exercise this Limited Warranty, the purchaser must first contact either InFocus, a service facility authorized by InFocus or the place of original purchase. For Warranty service, the purchaser will be advised to return or deliver the defective Product freight and all fees prepaid, to an InFocus Service Center or to a service facility authorized by InFocus. When returning Product to InFocus, a Return Material Authorization Number (RMA #) is required and must be clearly displayed on the outside of the shipping carton containing the Product. The Product is to be fully insured and packed in either its original carton or a similar package affording an equal degree of protection. InFocus or the service facility authorized by InFocus will return the repaired/replaced Product freight prepaid to the purchaser. Products returned for Warranty service must be accompanied by a written letter that: i.) explains the problem; ii) provides proof of date of purchase; iii) provides the dealer’s name; and iv.) provides the model and serial number of the Product. Upon request of InFocus Corporation or an authorized repair center for InFocus, proof of legal importation must accompany the warranty repair Product, otherwise the Product must be returned to the place of original purchase, to the manufacturer (Purchaser must bear all tax, duty and freight), or the Purchaser must bear charges for the warranty repair.

No repair or replacement of Product or part thereof shall extend the Warranty period as to the entire Product. Warranty on the repaired part and workmanship shall only be effective for a period of ninety (90) days following the repair or replacement of that part or the remaining period of the Product Warranty whichever is greater.

WARRANTY LIMITATION AND EXCLUSION

This Limited Warranty extends only to Products purchased from InFocus or an InFocus authorized reseller. InFocus shall have no further obligation under the foregoing Limited Warranty if the Product has been damaged due to abuse, misuse, neglect, accident, unusual physical or electrical stress, unauthorized modifications, tampering, alterations, or service other than by InFocus or its authorized agents, causes other than from ordinary use or failure to properly use the Product in the application for which said Product is intended.

Limited Warranty excludes Product or accessory cleaning, repair, or replacement of plastics due to cosmetic damage and damage as a result of normal wear. Product repair outside of the terms of the Limited Warranty will be on a time and materials basis. Prolonged Product "demonstration" causes unusual Product wear and is not considered normal use under the terms of this Limited Warranty.

Accessory Warranty covers the accessory item only and excludes normal wear. Lamp Product Warranty excludes expected lamp degradation.

Remanufactured Products and Software Products are exempt from the foregoing Limited Warranty. Please refer to the appropriate Remanufactured Product Limited Warranty or Software Product Limited Warranty for applicable Warranty information.

DISCLAIMER OF UNSTATED WARRANTIES

THE WARRANTY PRINTED ABOVE IS THE ONLY WARRANTY APPLICABLE TO THIS PURCHASE. ALL OTHER WARRANTIES, EXPRESS OR IMPLIED, INCLUDING, BUT NOT LIMITED TO, THE IMPLIED WARRANTIES OF MERCHANTABILITY AND FITNESS FOR A PARTICULAR PURPOSE ARE DISCLAIMED. THERE ARE NO WARRANTIES THAT EXTEND BEYOND THE FACE HEREOF AND THE FOREGOING WARRANTY SHALL NOT BE EXTENDED, ALTERED OR VARIED EXCEPT BY WRITTEN INSTRUMENT SIGNED BY INFOCUS. SOME JURISDICTIONS DO NOT ALLOW LIMITATIONS ON HOW LONG AN IMPLIED WARRANTY MAY LAST, SO SUCH LIMITATIONS MAY NOT APPLY TO YOU.

LIMITATION OF LIABILITY

IT IS UNDERSTOOD AND AGREED THAT INFOCUS' LIABILITY WHETHER IN CONTRACT, IN TORT, UNDER ANY WARRANTY, IN NEGLIGENCE OR OTHERWISE SHALL NOT EXCEED THE RETURN OF THE AMOUNT OF THE PURCHASE PRICE PAID BY PURCHASER AND UNDER NO CIRCUMSTANCES SHALL INFOCUS BE LIABLE FOR SPECIAL, INDIRECT, INCIDENTAL OR CONSEQUENTIAL DAMAGES OR LOST PROFITS, LOST REVENUES OR LOST SAVINGS. THE PRICE STATED FOR THE PRODUCT IS A CONSIDERATION IN LIMITING INFOCUS' LIABILITY. NO ACTION, REGARDLESS OF FORM, ARISING OUT OF THE AGREEMENT TO PURCHASE THE PRODUCT MAY BE BROUGHT BY PURCHASER MORE THAN ONE YEAR AFTER THE CAUSE OF ACTION HAS ACCRUED. SOME JURISDICTIONS DO NOT ALLOW THE EXCLUSION OR LIMITATION OF INCIDENTAL OR CONSEQUENTIAL DAMAGES SO THE ABOVE LIMITATION OR EXCLUSION MAY NOT APPLY TO YOU. THIS LIMITED WARRANTY GIVES YOU SPECIFIC LEGAL RIGHTS, AND YOU MAY ALSO HAVE OTHER RIGHTS, DEPENDING ON JURISDICTION.