

***myprojectorlamps.com***

**The most trusted, dependable name  
in projector lamp sales.**



<http://www.myprojectorlamps.com>



<http://www.myprojectorlamps.ca>



<http://www.myprojectorlamps.eu>

The following projector manual has not been modified or altered in any way.

**IN42**

..... **InFocus**

## User's Guide



English, Deutsch, Español, Français, Italiano, Svensk,  
Nederlands, Português, 日本語

## Declaration of Conformity

Manufacturer: InFocus Corporation, 27700B SW Parkway Ave. Wilsonville, Oregon 97070 USA

European Office: Strawinskylaan 585, 1077 XX Amsterdam, The Netherlands

We declare under our sole responsibility that this projector conform to the following directives and norms:

EMC Directive 89/336/EEC, Amended by 93/68/EEC

EMC: EN 55022

EN 55024

EN 61000-3-2

EN 61000-3-3

Low Voltage Directive 73/23/EEC, Amended by 93/68/EEC

Safety: IEC 60950-1: 1<sup>st</sup> Edition

October, 2003

## Trademarks

Apple, Macintosh, and PowerBook are trademarks or registered trademarks of Apple Computer, Inc. IBM is a trademark or registered trademark of International Business Machines, Inc. Microsoft, PowerPoint, and Windows are trademarks or registered trademarks of Microsoft Corporation. Adobe and Acrobat are trademarks or registered trademarks of Adobe Systems Incorporated. InFocus, In Focus, and INFOCUS (stylized) are either registered trademarks or trademarks of InFocus Corporation in the United States and other countries.

## FCC Warning

This equipment has been tested and found to comply with the limits for a Class A digital device, pursuant to part 15 of the FCC Rules. These limits are designed to provide reasonable protection against harmful interference when the equipment is operated in a commercial environment. This equipment generates, uses, and can radiate radio frequency energy and, if not installed and used in accordance with the instruction manual, may cause harmful interference to radio communications.

Operation of this equipment in a residential area is likely to cause harmful interference in which case the user will be required to correct the interference at his own expense.

## EN 55022 Warning

This is a Class A product. In a domestic environment it may cause radio interference, in which case the user may be required to take adequate measures. The typical use is in a conference room, meeting room or auditorium.

## Canada

This Class A digital apparatus complies with Canadian ICES-003.

Cet appareil numérique de la classe A est conforme à la norme NMB-003 du Canada.

## Agency Approvals

UL, CUL, DEMKO-GS

Other specific Country Approvals may apply, see please product certification label.

InFocus reserves the right to alter product offerings and specifications at any time without notice.

## Battery Safety Information

CAUTION: Risk of explosion if the battery in this projector is replaced with the incorrect type of battery. See page 33 for battery replacement instructions.

This user's guide applies to models IN42, C445, and W400.

## Table of Contents

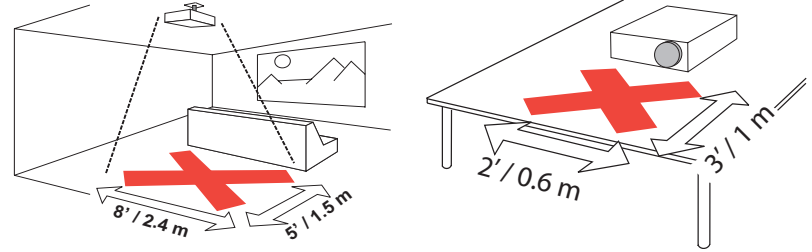
Introduction	4
Included Items	4
Positioning the projector	6
Connecting a computer	7
Required computer connections	7
Displaying a computer image	9
Adjusting the image	10
Connecting a video device	11
Displaying a video image	12
Shutting down the projector	14
Troubleshooting your setup	14
Using the keypad buttons	21
Using the remote control	21
Using the audio	22
Optimizing computer images	23
Presentation features	23
Optimizing video images	24
Customizing the projector	24
Using the menus	25
Picture menu	26
Settings menu	29
Maintenance	33
Cleaning the lens	33
Replacing the clock batteries	33
Replacing the projection lamp	34
Cleaning the dust filter	36
Using the security lock	36
Appendix	37
Projected image size	37
RS-232 commands	40

For complete details on connecting and operating the projector, refer to this User's Guide. Electronic versions of this User's Guide in multiple languages are available on our website.

The website also has technical specifications (an interactive image size calculator, laptop activation commands, connector pin outs, a glossary, the product data sheet), a web store to buy accessories, and a page for online registration. See the inside of the back cover for a list of all relevant web addresses.

## Important Operating Considerations for Safety

- Place the projector in a horizontal position no greater than 8 degrees off axis.
- Locate the projector in a well-ventilated area without any obstructions to intake or exhaust vents. Do not place the projector on a tablecloth or other soft covering that may block the vents.
- Locate the projector at least 4' (1.2 m) away from any heating or cooling vents.
- Use only approved ceiling mounts.
- Use only the power cord provided. A surge-protected power strip is recommended.
- Refer to this manual for proper startup and shutdown procedures.
- This product has a lamp which contains a very small amount of mercury. Wash hands after cleaning the area and handling the ruptured lamp. Dispose of it as required by local, state or federal ordinances and regulations. For more information see [www.eiae.org](http://www.eiae.org).
- In the unlikely event of a lamp rupture, particles may exit through the projector vents. When the projector is turned on, keep people, food, and drinks out of the "keep out" area under and around the projector, as indicated by the "X" areas below.



Follow these instructions to help ensure image quality and lamp life over the life of the projector. Failure to follow these instructions may affect the warranty. For complete details of the warranty, see the Warranty booklet.

# Introduction

Your new multimedia projector provides two computer, three video, and two audio inputs, one audio output, and RS-232 and Network control. It has XGA 1024x768 resolution. Optional user-changeable short, fixed short, long and ultra long throw lenses make this a flexible product suitable for many different uses. The projector is easy to connect, easy to use, and easy to maintain.

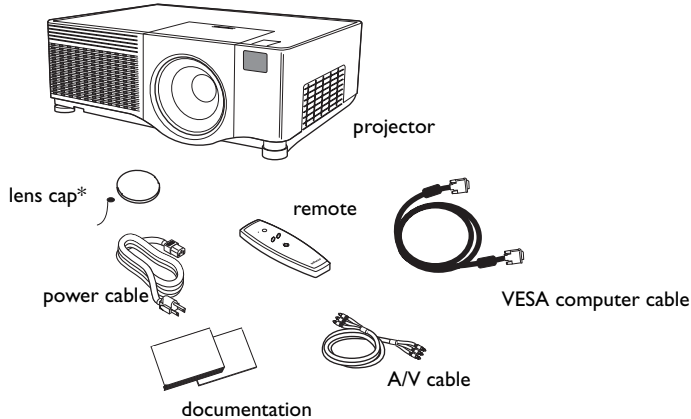
## Product specifications

To read the latest specifications on your multimedia projector, be sure to visit our website. Web address information is located on the back inside cover of this User's Guide.

## Online Registration

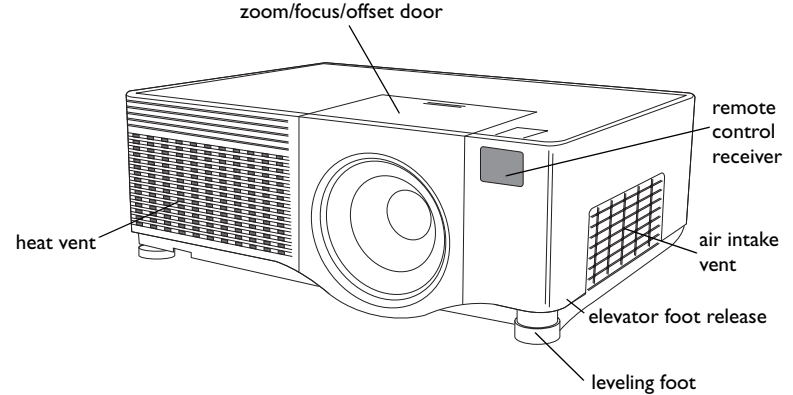
Register your projector on our website to receive product updates, announcements, and registration incentives. See the inside back cover for the web address.

## Included Items

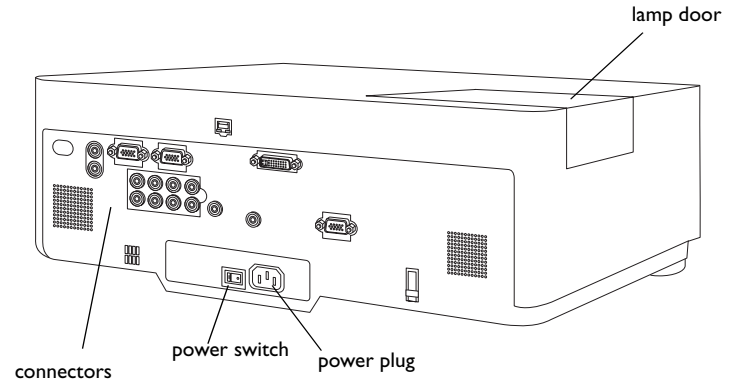


\*the lens cap tether can attach the lens cap to the projector if desired.

## Projector components and features: front



## Projector components and features: back



## Connector Panel

The projector provides three computer and three video connection options:

- one M1-DA (DVI with USB)
- one VESA computer
- one component RCA video (Pr, Pb, Y)
- one S-video
- one composite RCA video

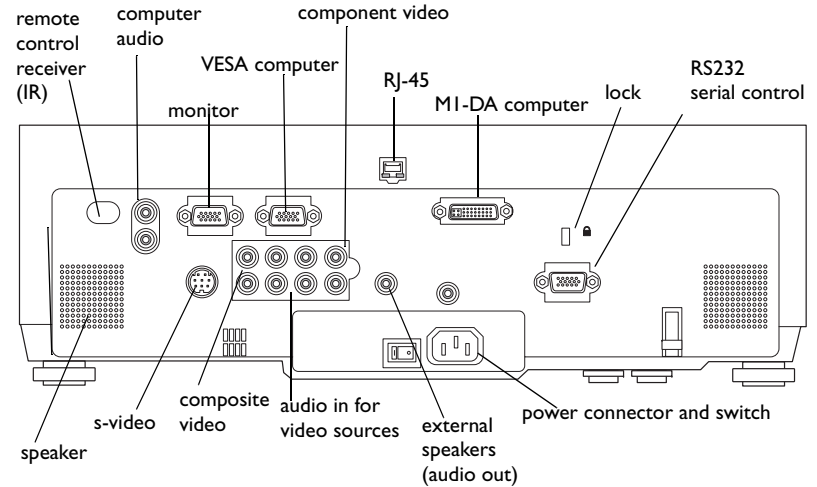
The projector provides computer and video connectors for audio support:

- two composite RCA stereo audio (L, R)
- one audio out
- two audio ins for computer

The projector also provides the following connectors:

- one wired remote
- one monitor out
- RS-232 serial connector (for serial control)
- RJ-45 connector (for networked control)

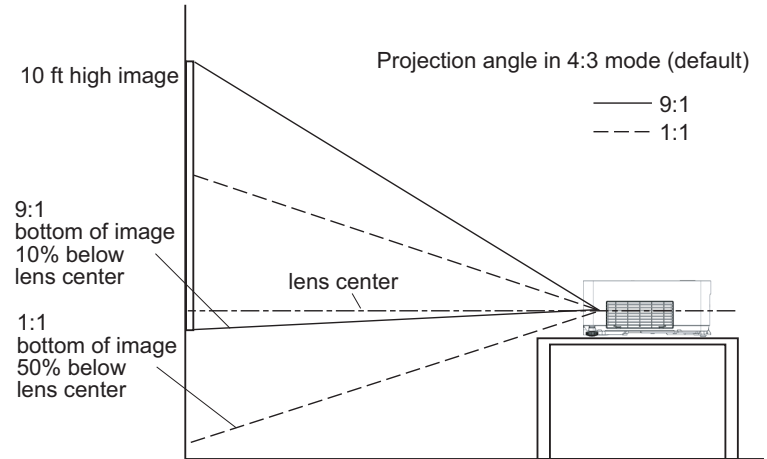
The RS-232 Command Line Interface (CLI) specifications and commands are available in the Appendix and on our website. See the back inside cover of this User's Guide for website information.



## Positioning the projector

To determine where to position the projector, consider the size and shape of your screen, the location of your power outlets, and the distance between the projector and the rest of your equipment. Here are some general guidelines:

- Position the projector on a flat surface at a right angle to the screen. The projector (with the standard lens) must be at least 3 feet (0.9m) from the projection screen.
- Position the projector within 10 feet (3m) of your power source and within 6 feet (1.8m) of your video device (unless you purchase extension cables). To ensure adequate cable access, do not place the projector within 6 inches (.15m) of a wall or other object.
- If you are installing the projector on the ceiling, refer to the installation guide that comes with the Ceiling Mount Kit for more information. To turn the image upside down, see “Ceiling” on page 29. We recommends using an authorized ceiling mount. The Ceiling Mount Kit is sold separately; visit our website for more information.
- Position the projector the desired distance from the screen. The distance from the lens of the projector to the screen, the zoom setting, and the video format determine the size of the projected image. For information about image sizes at different distances, see “Projected image size” on page 37.
- For the standard lens that comes with the projector, the image exits at a given angle. However, the lens shift feature makes the image offset variable. The image offset is 90% at a 9:1 ratio when the projector is in 4:3 mode (default mode). This means that if you have an image 10’ high, the bottom of the image will be 1’ below the center of the lens.
- The image offset is 50% when the lens shift is at a 1:1 ratio. This means that if you have an image 10’ high, the bottom of the image will be 5’ below the center of the lens.
- For information about the optional lenses image offsets, see “Projected image size” on page 37.





# Connecting a computer

## Required computer connections

Connect one end of the VESA computer cable to the **Computer 2** connector on the projector. Connect the other end to the video port on your computer. If you are using a desktop computer, you first need to disconnect the monitor cable from the computer's video port.

Connect the black power cable to the connector on the back of the projector and to your electrical outlet.

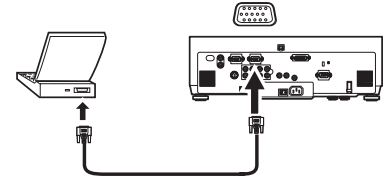
**NOTE:** Always use the power cable that shipped with the projector.

## Optional computer connections

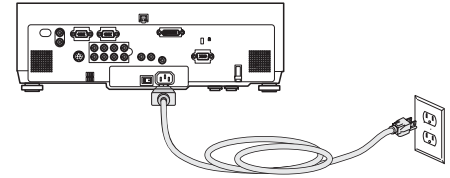
To control your computer's mouse using an optional remote control, connect the optional M1-DA cable to the USB and DVI ports on your computer, and connect the other end to the **Computer 1** (M1-DA) connector on the projector.

To have sound with your presentation, connect the audio cable to your computer and to the corresponding computer **Audio In** connector on the projector.

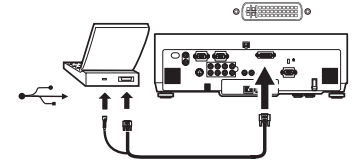
connect computer cable



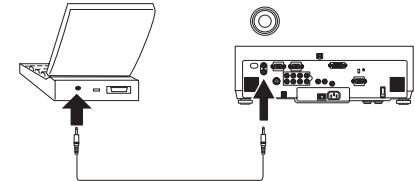
connect power cable



connect M1-DA cable

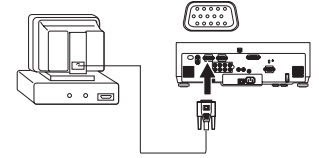


connect audio cable



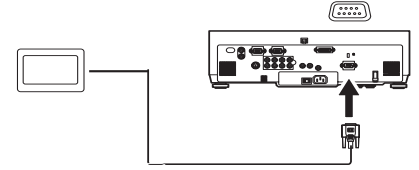
If you are using a desktop computer and want to see the image on your computer screen as well as on the projection screen, plug the monitor cable to the **Monitor out** connector on the projector.

connect monitor cable



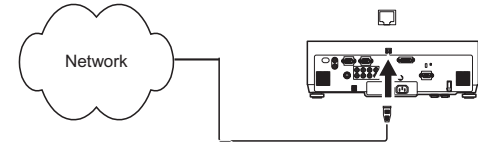
You can control the projector from an LCD control panel, touch screen, or other control device or computer by connecting an RS-232 cable to the projector's **Serial Control** connector. Specific RS-232 commands can be found in the Service and Support section of our website and in the Appendix.

connect RS-232 cable



The projector can be managed by networking software through its **Network** (RJ-45) connector. Detailed instructions on this feature can be found on our website.

connect CAT-5 cable



# Displaying a computer image

Remove the lens cap.

Press the power switch on the back of the projector to the on (I) position. The Power light on the Status Indicator Panel (page 14) lights green.

Press the **Power** button on the top of the projector or the remote.

The Power light blinks green and the fans start to run. When the lamp comes on, the startup screen is displayed and the light is steady green. It can take a minute for the image to achieve full brightness.

**? No startup screen?** Get help on page 15.

Turn on your computer.

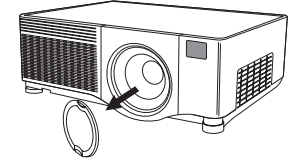
The computer's image should appear on the projection screen. If it doesn't, press the **Source** button on the keypad or remote.

Make sure your laptop's external video port is active.

Many laptops do not automatically turn on their external video port when a projector is connected. Usually a key combination like FN + F5 is used to turn the external display on and off. Refer to your computer's documentation to learn your computer's key combination.

**? No computer image?** Get help on page 15.

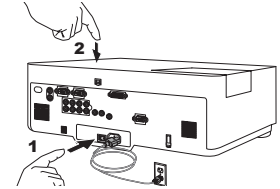
remove lens cap



press Power switch



press Power button



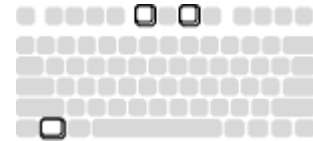
turn on computer



source



activate laptop's external port



## Adjusting the image

Adjust the height of the projector, if necessary, by pressing the release buttons on each side of the projector's front to extend the elevator feet.

Position the projector the desired distance from the screen at a 90 degree angle (perpendicular) to the screen.

See page 37 for a table listing screen sizes and distances.

Adjust the zoom or focus by rotating the **Zoom** or **Focus** rings inside the lens door until the desired image size and focus are produced.

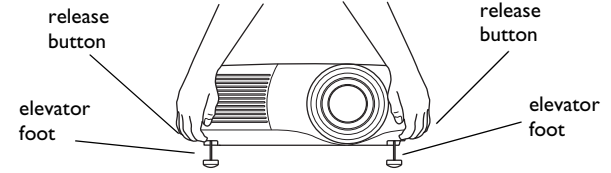
If the image is not on the screen or viewing area, adjust it by using the lens shift dials inside the lens door.

Use the right dial to shift the lens left or right. Use the left dial to shift the lens up or down.

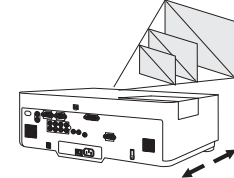
Adjust the Contrast or Brightness in the Picture menu.

See page 25 for help with the menus.

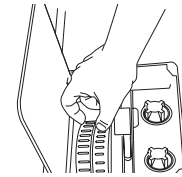
adjust height



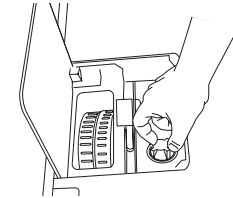
adjust distance



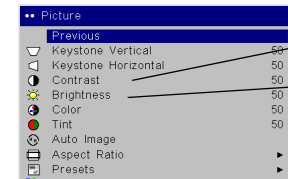
adjust zoom and focus



adjust lens shift



adjust Contrast or Brightness



contrast

brightness

# Connecting a video device

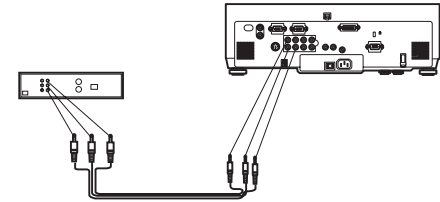
## Standard video connections

Plug the audio/video (A/V) cable's yellow connector into the video-out connector on the video device. Plug the other yellow connector into the yellow **Video 3** connector on the projector. Plug a white connector into the left audio out connector on the video device and plug a red connector into the right audio out connector on the video device. Plug the remaining white connector into the left **audio in** connector on the projector, and plug the red connector into the right **audio in** connector on the projector.

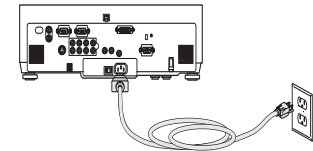
Connect the black power cable to the connector on the back of the projector and to your electrical outlet.

**NOTE:** Always use the power cable that shipped with the projector.

connect A/V cable



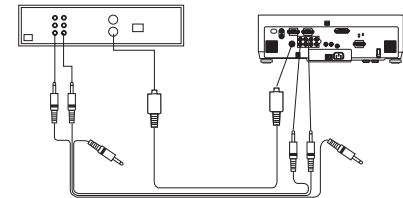
connect power cable



## Optional video connections

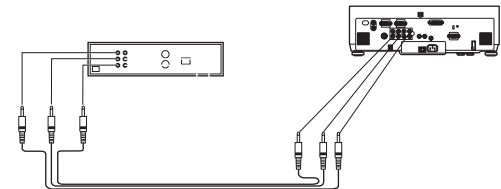
If the video device uses a round, four-prong S-video connector, plug an S-video cable (sold separately) into the S-video connector on the video device and into the **Video 2** connector on the projector. Use the A/V cable's audio connectors as described directly above (the yellow connectors on the A/V cable are not used).

connect S-video and video cables



If the video device uses component cable connectors (sold separately), plug the cable's green connectors into the green component-out connector on the video device and into the **Video 1** green component connector (labeled "Y") on the projector. Plug the component cable's blue connectors into the blue component-out connector on the video device and into the blue component connector (labeled "Cb/Pb") on the projector. Plug the component cable's red connectors into the red component-out connector on the video device and into the red component connector (labeled "Cr/Pr") on the projector. Use the A/V cable's audio connectors as described above (the yellow connectors on the A/V cable are not used). **NOTE:** The component connectors can be used for HDTV sources (480i, 480p, 720p, 576i and 1080i formats).

connect component cables and video cables



# Displaying a video image

Remove the lens cap.

Press the power switch on the back of the projector to the on (I) position. The Power light on the Status Indicator Panel (page 14) lights green.

Press the **Power** button on the top of the projector or the remote.

The Power light blinks green and the fans start to run. When the lamp comes on, the startup screen is displayed and the light is steady green. It can take a minute for the image to achieve full brightness.

**? No startup screen?** Get help on page 15.

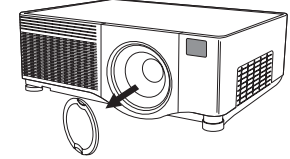
Plug in and turn on the video device.

The video device's image should appear on the projection screen. If it doesn't, press the **Source** button on the keypad or remote.

Adjust the height of the projector, if necessary, by pressing the release buttons on each side of the projector's front to extend the elevator feet. Rotate the feet, if necessary, to level the projector.

Position the projector the desired distance from the screen at a 90 degree angle to the screen. See page 37 for a table listing screen sizes and distances to the screen.

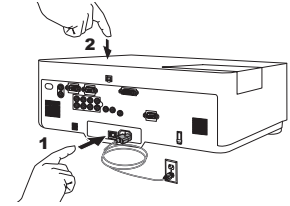
remove lens cap



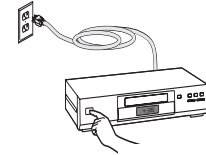
press Power switch



press Power button



turn on video device



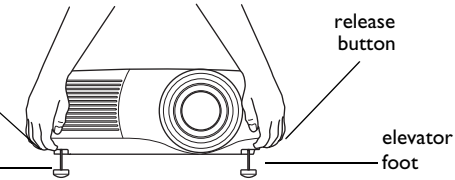
adjust height

release button

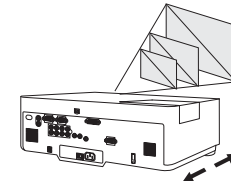
release button

elevator foot

elevator foot



adjust distance



Adjust the zoom or focus by rotating the **Zoom** or **Focus** rings inside the lens door until the desired image size and focus are produced.

If the image is not on the screen or viewing area, adjust it by using the lens shift dials inside the lens door.

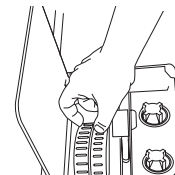
Use the right dial to shift the lens left or right. Use the left dial to shift the lens up or down.

Adjust the volume in the Audio menu.

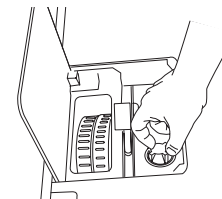
Adjust the **Contrast**, **Brightness**, **Color**, or **Tint** in the Picture menu.

See page 25 for help with the menus.

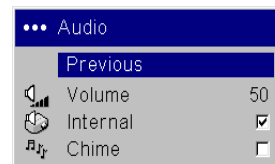
adjust Zoom and Focus



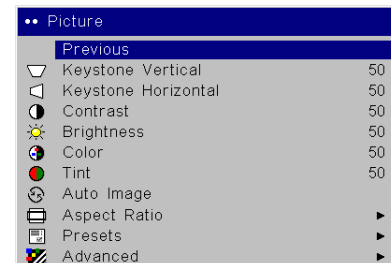
adjust Lens Shift



adjust volume



adjust Picture menu



## Shutting down the projector

The projector automatically blanks the screen after no active source is detected for 5 minutes. This blank screen helps preserve the life of the projector. The image returns when an active source is detected or a remote or keypad button is pressed.

### Screen Save

You can make the blank screen appear after five minutes by turning on Screen Save in the **Settings>System** menu. See page 30.

### Power Save

The projector also has a Power Save feature that automatically turns the lamp off after no signals are detected for 20 minutes. After 10 additional minutes with no signal, the projector powers down. If an active signal is received before the projector powers down, the image is displayed. You must press the Power button to display an image after 30 minutes have passed. When Power Save is enabled, Screen Save is disabled. See page 30.

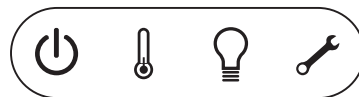
### Turning off the projector

To turn off the projector, press the **power** button and verify that you want to turn the projector off by pressing the power button again within 3 seconds. You can cancel the shutdown by not pressing the **power** button a second time. The lamp turns off and the Power light blinks green for over 1 minute while the fans continue to run to cool the lamp. When the lamp has cooled, the Power light is solid green and the fans stop. Press the power switch on the back of the projector and unplug the power cable to completely power off the projector.






## Troubleshooting your setup

If your image appears correctly on the screen, skip to the next section. If it does not, troubleshoot the setup.

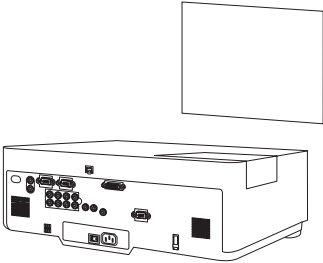
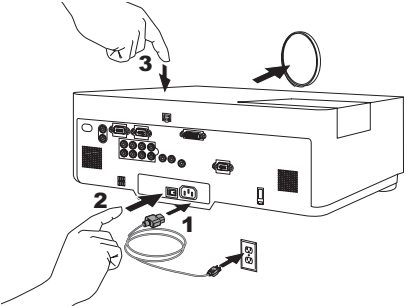
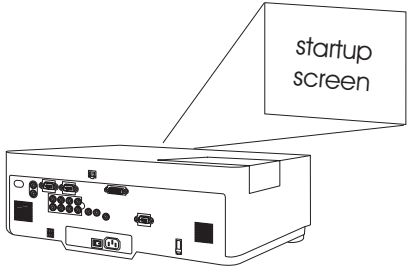
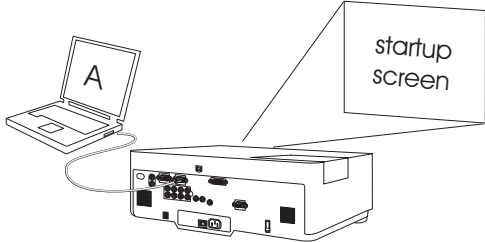
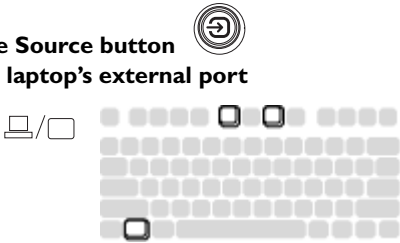
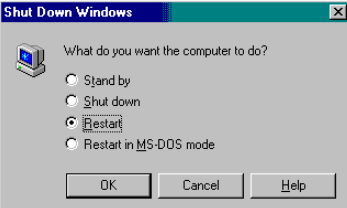
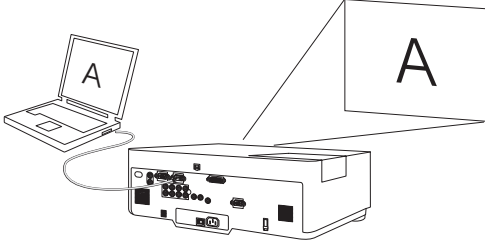
The Status Indicator Panel on top of the projector indicates the state of the projector and can help you troubleshoot.



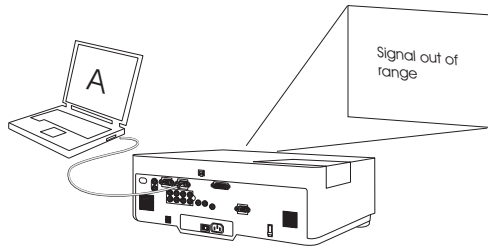
**Table I: Status indicator light behavior and meaning**

Status Indicator Panel icons	Meaning
Power, solid green 	The power button has been pressed and the software has initialized or the projector has been powered off.
Power, blinking green 	The power button has been pressed and the software is initializing, or the projector is powering down and the fans are running to cool the lamp.
Thermometer 	The projector is too hot. Make sure the vents aren't blocked (see page 19). Turn off the projector and wait one minute, then turn the projector on again. Contact Technical Support if the problem persists.
Lamp 	Turn off the projector and wait one minute, then turn the projector on again. If the lamp light turns on again, replace the lamp and reset the lamp timer.
Wrench/Service 	Turn off the projector and wait one minute, then turn the projector on again. If the service lamp turns on again, service is required. Visit our website to contact Service.

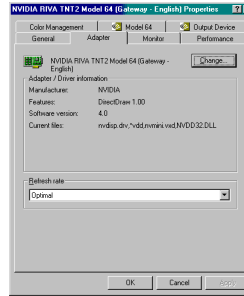


Problem	Solution	Result
<p data-bbox="53 192 256 215"><b>No startup screen</b></p> 	<p data-bbox="664 158 1154 212"><b>Plug power cable in, press power switch and power button. Remove lens cap.</b></p> 	<p data-bbox="1189 192 1354 215"><b>Correct image</b></p> 
<p data-bbox="53 551 373 574"><b>Only startup screen appears</b></p> 	<p data-bbox="664 591 1015 642"><b>Press the Source button</b> <b>Activate laptop's external port</b></p>  <p data-bbox="659 820 772 872"><b>or restart laptop</b></p> 	<p data-bbox="1189 551 1501 574"><b>Computer image projected</b></p> 

**No computer image, just the words “Signal out of range”**

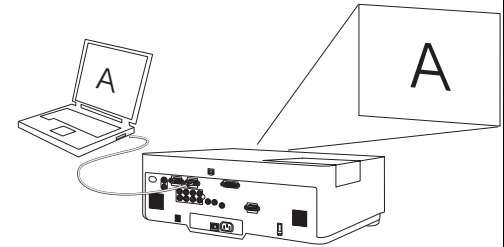


**Adjust computer refresh rate in Control Panel>Display>Settings>Advanced>Adapter (location varies by operating system)**

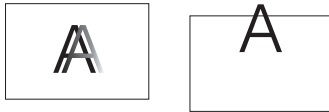


**You may also need to set a different resolution on your computer, as shown in the following problem, “Image fuzzy or cropped”**

**Computer image projected**

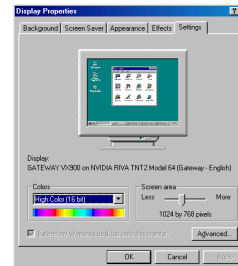


**Image fuzzy or cropped**



**Set your computer’s display resolution to the native resolution of the projector (Start>Settings>Control Panel>Display>Settings tab, select 1024x768)**

**For a laptop, disable laptop monitor or turn-on dual-display mode**



**Image clear and not cropped**



## Projector troubleshooting


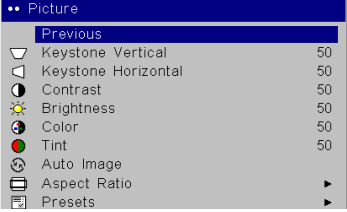


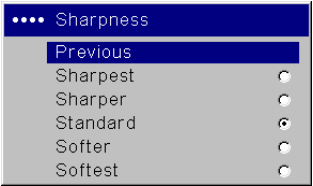

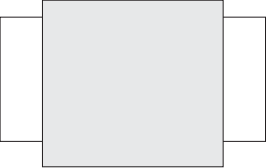
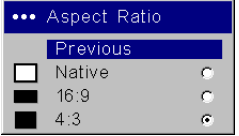

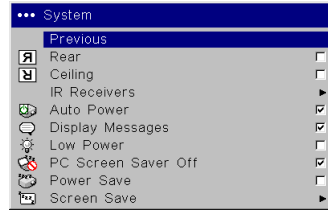
Problem	Solution	Result
<p><b>Image not square</b></p> 	<p><b>Adjust keystone the Picture menu</b></p> 	<p><b>Square image</b></p> 
<p><b>Image not sharp</b></p> 	<p><b>Adjust the focus ring or Sharpness in the Picture&gt;Advanced menu</b></p> 	<p><b>Correct image</b></p> 
<p><b>Image does not fit 16:9 screen</b></p> 	<p><b>Change aspect ratio to 16:9 in Picture&gt;Aspect ratio menu</b></p> 	<p><b>Correct image</b></p> 

Image upside down



Turn on/off Ceiling in Settings>System menu



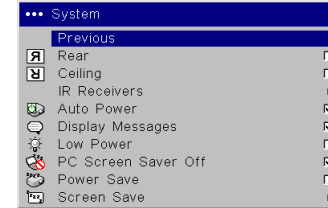
Correct image



Image reversed left to right



Turn on/off Rear in Settings>System menu



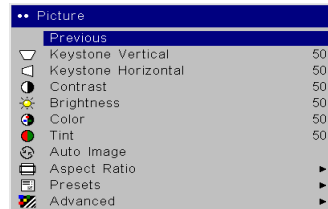
Correct image



Projected colors don't match source



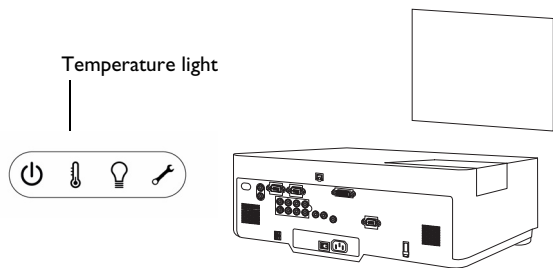
Adjust color, tint, color temperature, brightness, contrast in the menus



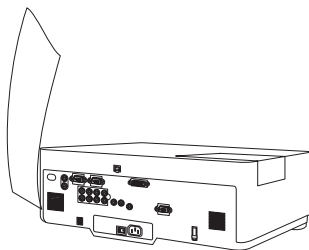
Correct image



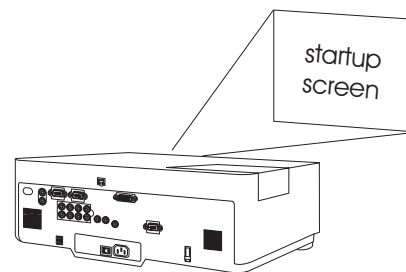
**Lamp won't turn on, Temp light is lit (page 14)**



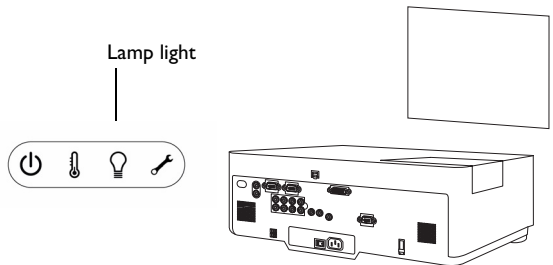
**Make sure vents aren't blocked; allow projector to cool for one minute**



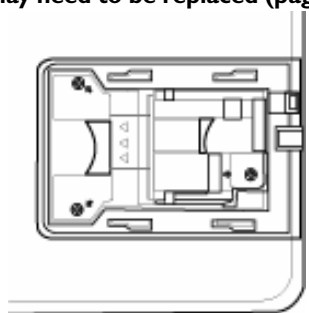
**Unplug projector; wait one minute; plug in projector and turn it on: lamp lights**



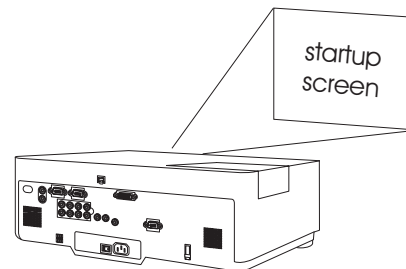
**Lamp won't turn on, Lamp light is lit (page 14)**



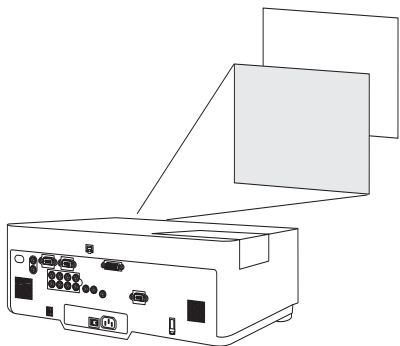
**Lamp may need to be replaced (page 34)**



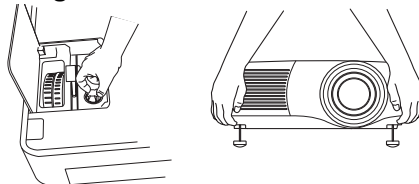
**Lamp turns on**



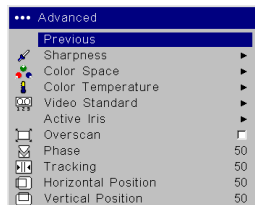
### Image not centered on screen



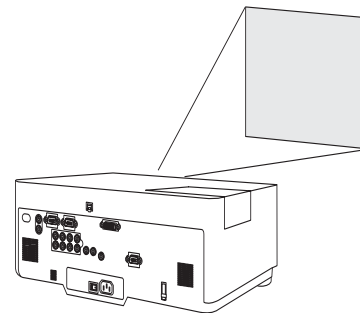
### Move projector, adjust zoom or lens shift, adjust height



### Adjust horizontal or vertical position in Picture>Advanced menu



### Correct image



### Still having problems?

If you need assistance, visit our website or call us. See the inside of the back cover for a list of all relevant web addresses.

This product is backed by a limited warranty. An extended warranty plan may be purchased from your dealer. When sending the projector in for repair, we recommend shipping the unit in its original packing material, or having a professional packaging company pack the unit. Please insure your shipment for its full value.

## Using the keypad buttons

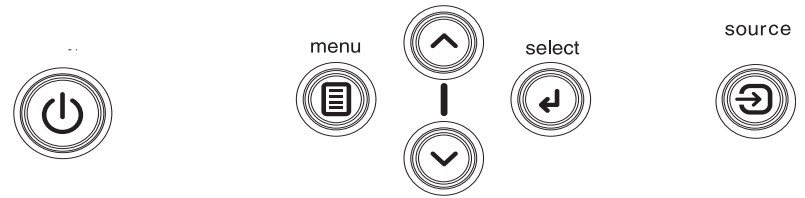
**power**—turns the projector on (page 9) and off (page 14).

**menu**—opens the on-screen menus (page 25).

**up/down arrows**—navigates to and adjusts settings in the menus (page 25).

**select**—confirms choices made in the menus (page 25).

**source**—switches among active sources



## Using the remote control

The remote uses two (2) AA batteries. They are easily installed by sliding the cover off the remote's back, aligning the + and - ends of the batteries, sliding them into place, and then replacing the cover.

To operate, point the remote at the projection screen or at the projector (not at the computer). The range of optimum operation is about 15 feet (4.5m). For best results, aim the remote directly at the projector.

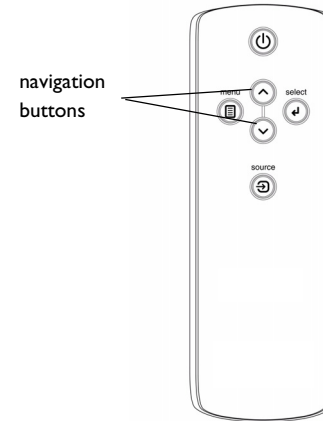
Press the remote's **Menu** button to open the projector's menu system. Use the arrow buttons to navigate, and the **Select** button to select features and adjust values in the menus.

Press the remote's **Power** button to turn the projector on and off.

The remote also has a **Source** button to switch between sources.

### Troubleshooting the remote

- Make sure the batteries are installed in the proper orientation and are not dead.
- Make sure you're pointing the remote at the projector, not the computer, and are within the remote range of 15 feet (4.5m).



## Using the audio

To play sound from the projector, connect your source to the Audio In connector on the projector.

To adjust the volume, mute, or loudness, use the Audio menu (see page 29).

### Troubleshooting audio

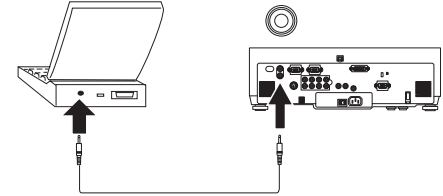
If there is no sound, check the following:

- Make sure the audio cable is connected.
- Make sure mute isn't active.
- Make sure the volume is turned up enough.
- Make sure you are connected to the corresponding **audio in** for your source. **Audio 1** corresponds to **Computer 1**, **Audio 2** corresponds to **Computer 2**, **Audio 3** corresponds to **Video 2** and **3**, and **Audio 4** corresponds to **Video 1**.
- Adjust the audio source.
- If playing a video, make sure the playback has not been paused.

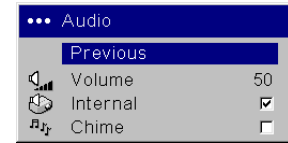
### Connecting external speakers

The projector can be attached to external speakers that have their own power source by plugging a speaker cable into the projector's **Audio Out** connector.

connect audio cable

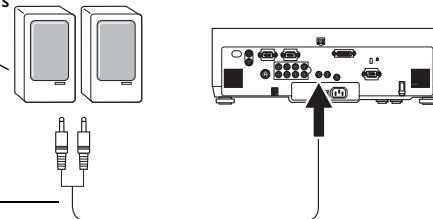


adjust volume



external speakers

speaker cable





## Optimizing computer images

After your computer is connected properly and the computer's image is on the screen, you can optimize the image using the onscreen menus. For general information on using the menus, see page 25.

- Adjust the Keystone, Contrast, or Brightness in the Picture menu.
- Change the Aspect Ratio. Aspect Ratio is the ratio of the image width to image height. TV screens are usually 1.33:1, also known as 4:3. HDTV and most DVDs are 1.78:1, or 16:9. Choose the option that best fits your input source. See page 26 for details.
- Adjust the Color Temperature in the Advanced menu.
- Adjust the Phase, Tracking, or Horizontal or Vertical position in the Advanced menu.
- Once you have optimized the image for a particular source, you can save the settings using Presets. This allows you to quickly recall these settings later. See page 27.

## Presentation features

Several features are provided to make giving presentation easier. The following is an overview, details are found in the menu section on page 25.

- The **Custom** key, available on several optional remotes only, allows you to assign various features to the key. The default effect is Source Info. You can select from Blank, Mute, Aspect Ratio, Source, Auto Image, Freeze, Magnify, Source Info, and Service Info. See page 31 for details.
- The Freeze effect allows you to freeze the displayed image. This is useful if you want to make changes on your computer without your audience seeing them.
- The Startup Logo menu option lets you change the default startup screen to a black, white, blue, or a custom logo screen via Capture New. See page 30.
- Two menu options, Power Save and Screen Save, are provided to automatically shut down the projector after several minutes of inactivity or display a blank screen. This helps preserve lamp life. See page 30.
- A Low Power menu option is also available to help lower the projector's fan sound volume. See page 29.

## Optimizing video images

After the video device is connected properly and the image is on the screen, you can optimize the image using the onscreen menus. For general information on using the menus, see page 25.

- Adjust the Keystone, Contrast, Brightness, Color, or Tint in the Picture menu. See page 26.
- Change the Aspect ratio. Aspect ratio is the ratio of the image width to image height. TV screens are usually 1.33:1, also known as 4:3. HDTV and most DVDs are 1.78:1, or 16:9. Choose the option that best fits your input source. See page 26.
- Select a Sharpness setting. See page 28.
- Adjust the Color Temperature. Select a listed value, or select User and individually adjust the intensity of the red, green, and blue color. See page 28.

## Customizing the projector

You can customize the projector for your specific setup and needs. See page 29 to page 33 for details on these features.

- For rear projection, turn Rear mode on in the **Settings>System** menu.
- For ceiling mounted projection, turn Ceiling mode on in the **Settings>System** menu.
- Specify which source the projector checks first for an active signal during power-up.
- Turn the projector's on-screen display messages on and off.
- Turn on power saving features.
- Specify blank screen colors and startup logos.
- Specify the menu language.
- Control your projector using RS232 commands. See page 8 and page 40.
- Customize the projector for your specific installation using optional long or short throw lenses. See the inside back cover of this User's Guide for ordering information.

# Using the menus

To open the menus, press the menu button on the keypad or remote. (The menus automatically close after 60 seconds if no buttons are pressed.) The Main menu appears. Use the arrow buttons to move up and down to highlight the desired submenu, then press the **Select** button.

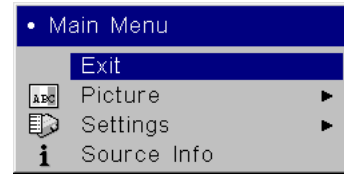
To change a menu setting, highlight it, press **Select**, then use the up and down arrow buttons to adjust the value, select an option using radio buttons, or turn the feature on or off using check boxes. Press **Select** to confirm your changes. Use the arrows to navigate to another setting. When your adjustments are complete, navigate to Previous, then press **Select** to go to the previous menu; press the **Menu** button at any time to close the menus.

Dots appear before the menu name. The number of dots indicate the menu's level, ranging from one (the Main menu) to four (the most nested menus).

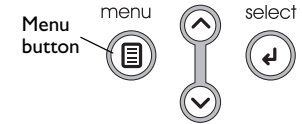
The menus are grouped by usage:

- The Picture menu provides image adjustments.
- The Settings menu provides set-up type adjustments that are not changed often.
- The Source Info menu provides a read-only display of information about the projector and source.

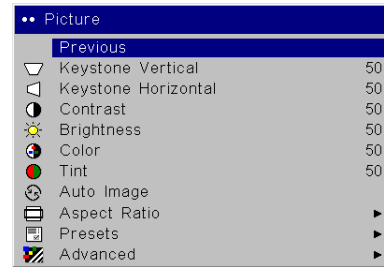
Certain menu items may be grayed out until a particular source is connected. For example, Tint is only available for video sources and will be hidden when a computer source is active. Other menu items may be grayed out when they are not available. For example, Brightness is grayed out until an image is active.



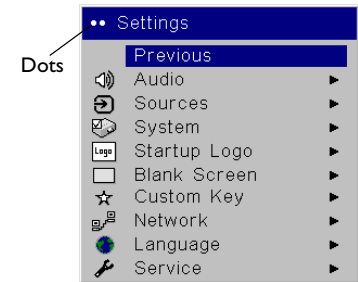
Main menu



Keypad navigation buttons



Picture menu



Settings menu



Source Info menu

## Picture menu

To adjust the following six settings, highlight the setting, press **Select**, use the up and down arrows to adjust the values, then press select to confirm the changes.

**Keystone Vertical:** adjusts the image vertically and makes a squarer image by using an adjustable scale band.

**Keystone Horizontal:** adjusts the image horizontally and makes a squarer image by using an adjustable scale band.

**Contrast:** controls the degree of difference between the lightest and darkest parts of the picture and changes the amount of black and white in the image.

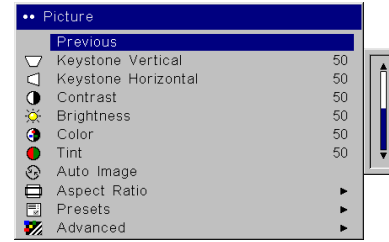
**Brightness:** changes the intensity of the image.

**Color:** (video sources only) adjusts a video image from black and white to fully saturated color.

**Tint:** (video sources only) adjusts the red-green color balance in the image.

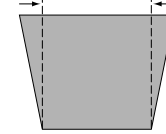
**Auto Image:** resynchs the projector to the source.

**Aspect Ratio:** Aspect ratio is the ratio of the image width to image height. TV screens are usually 1.33:1, also known as 4:3. HDTV and most DVDs are 1.78:1, or 16:9. The default is 4:3, which displays the input resized up or down to fill the display area.

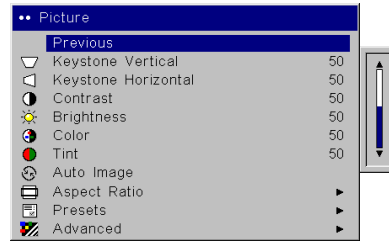
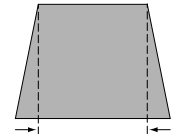


Keystone Vertical

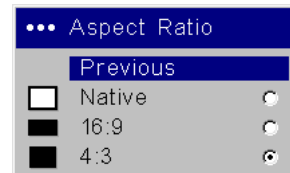
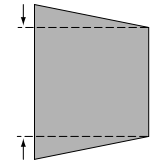
increasing keystone



decreasing keystone



Keystone Horizontal

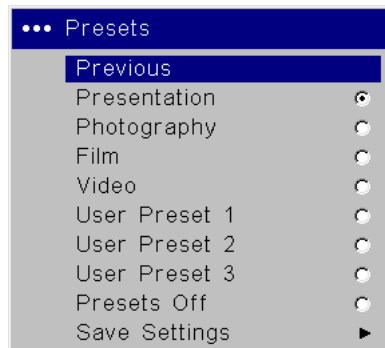


Aspect Ratio

**Presets:** The provided Presets optimize the projector for displaying computer presentations, photographs, film images, and video images. (Film input is material originally captured on a film camera, like a movie; video input is material originally captured on a video camera, like a TV show or sporting event.)

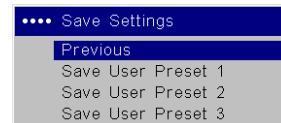
There are also user-definable presets. To set a preset for the current source, adjust the image, select Save Settings in the Presets menu, then select Save User Presets 1 (or 2 or 3). You can recall these settings in the future by selecting the User 1 preset. If you select User Presets then further adjust the image, Presets Off will automatically be selected in the Preset menu to indicate changes have been made.

To restore the factory default settings, choose Factory Reset in the **Settings>Service** menu.



Presets

#### Save Settings



## Advanced settings

**Sharpness:** changes the clarity of the edges of a video image. Select a sharpness setting.

**Color Space:** This option applies to computer and component video sources (except 480i/576i). It allows you to select a color space that has been specifically tuned for the input signal. When Auto is selected, the projector automatically determines the standard. To choose a different setting, turn off Auto, then choose RGB for computer sources, choose either SMPTE240, REC709 or REC601 for component video sources.

**Color Temperature:** changes the intensity of the colors. Select a listed value, or select User and individually adjust the intensity of the red, green, and blue colors.

**Video Standard:** when set to Auto, the projector attempts to automatically pick the video standard based on the input signal it receives. (The video standard options may vary depending on your region of the world.) If the projector is unable to detect the correct standard, the colors may not look right or the image may appear “torn.” If this happens, manually select a video standard by selecting NTSC, PAL, or SECAM from the Video Standard menu.

**Active Iris:** when on, the projector monitors the image brightness and modifies the light output if the image is dark, which improves black levels. In Presentation mode, it looks at peak brightness, in Theater mode it looks at average brightness.

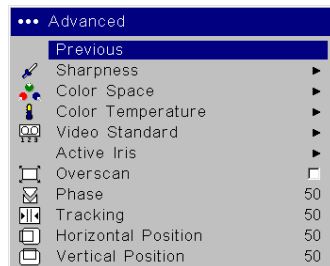
**Overscan:** (video sources only) removes noise around the video image.

The following 4 options are for computer sources only (except M1-D signal):

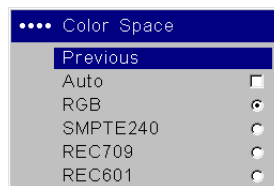
**Phase:** adjusts the horizontal phase of a computer source.

**Tracking:** adjusts the horizontal scan of a computer source.

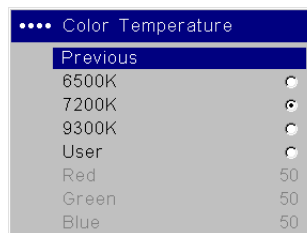
**Horizontal / Vertical Position:** adjusts the position of a computer source.



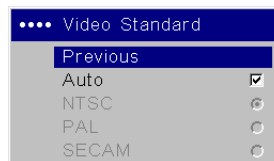
Sharpness



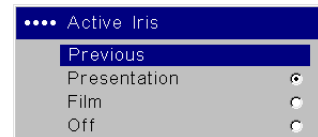
Color Space



Color Temperature



Video Standard



Active Iris

## Settings menu

**Audio:** allows adjustments to the Volume. Also allows you to turn on and off the Internal speakers, and projector startup Chime.

**Sources:** allows you to assign a particular input to a specific source key when using the Integrator remote. Also allows selection of a default Startup Source and enables or disables Autosource.

**Sources>Power-up Source:** this determines which source the projector checks first for active signal during power-up.

**Sources>Autosource:** When Autosource is not checked, the projector defaults to the source selected in Powerup Source. If no source is found, a blank screen displays. When Autosource is checked, Powerup Source determines which source the projector defaults to at power-up. If no signal is present, the projector checks the sources in order until a source is found or until power down.

**System>Rear:** reverses the image so you can project from behind a translucent screen.

**Ceiling:** turns the image upside down for ceiling-mounted projection.

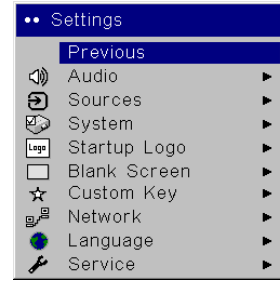
**IR Receivers:** turns individual IR receivers off or on to avoid environmental interference.

**Auto Power:** When Auto Power is checked, the projector automatically goes into the startup state after the projector is powered on. This allows control of ceiling mounted projectors with a wall power switch.

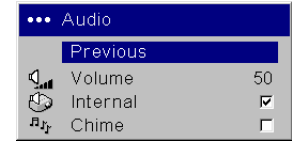
**Display Messages:** displays status messages (such as "Searching") in the lower-left corner of the screen.

**Low Power:** toggles between on and off. Turn it on to lower the light output of the lamp. This also lowers the fan speed, making the projector quieter.

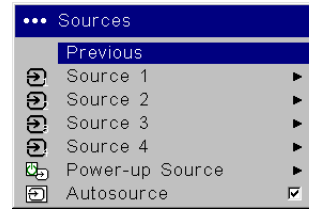
**PC Screen Saver Off:** prevents your notebook computer from going into Screen Save mode. The projector must be connected to the PC via a USB cable for this feature to work.



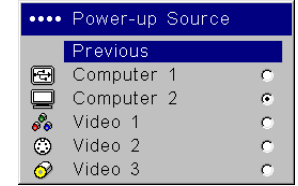
Settings menu



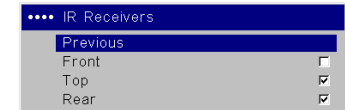
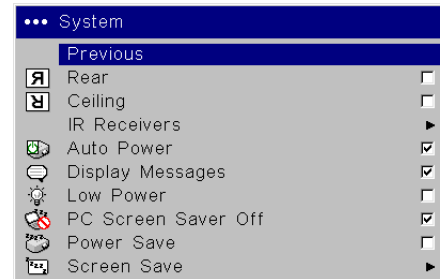
Audio



Sources



Powerup Source



IR Receivers

**Power Save:** automatically turns the lamp off after no signals are detected for 20 minutes. After 10 additional minutes with no signal, the projector powers down. If an active signal is received before the projector powers down, the image will be displayed.

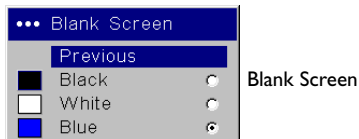
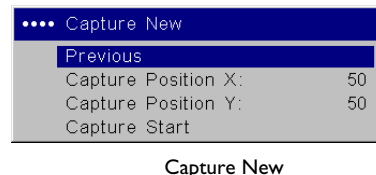
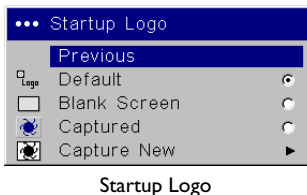
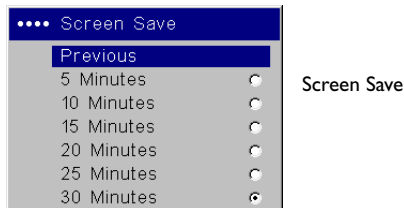
**Screen Save:** automatically blanks the screen after no signals are detected for five minutes. The image returns when an active source is detected or a remote or keypad button is pressed. Screen Save is disabled when Power Save is enabled.

**Startup Logo:** allows you to display a blank Black, White, or Blue screen instead of the default screen at startup and when no source is detected. It also allows you to capture and display a custom startup screen (except from an M1-D source).

To capture a custom logo, display the image you want to capture on your computer and select the Capture New option. From the **Capture New** menu, use the Capture Position X and Capture Position Y adjustments to frame the logo to be captured. Press Capture Start in the **Capture New** menu. The projector will let you know if the capture was a success or a failure.

The next time you start the projector, the custom logo you captured displays.

**Blank Screen:** determines what color is displayed when you press the **Blank** button on an optional remote.





**Custom Key** (for use with optional remote only): allows you to assign a different function to the **Custom** key on the optional remote to quickly and easily use the effect. Only one effect can be enabled at a time. The default is Source Info; highlight an effect and press **Select** to choose a different one.

**Blank:** shows an empty screen.

**Mute:** turns off all sound.

**Aspect Ratio:** sets the ratio of the image width to image height.

**Source:** cycles through the available sources.

**Auto Image:** causes computer sources to be reacquired.

**Freeze:** pauses the projected image.

**Magnify:** allows you to enlarge a section of the projected image.

**Source Info:** displays the Source Info menu.

**Service Info:** displays the Service Info menu.

**Network:** The projector has an RJ45 Ethernet connector that supports network connections and TCP/IP protocols. This will allow for the control and management of the projector over a corporate network. Visit our website for complete details on using the networking functionality. The following fields are accessible when DHCP is not checked and available for manual entry of data.

**IP Address:** Identifies the projector on the network.

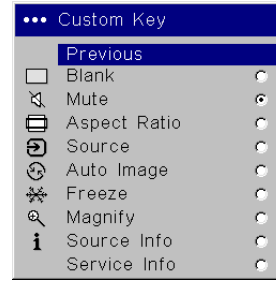
**Subnet Mask:** Separates the network address part of the IP address.

**Default Gateway:** The IP address of the local router.

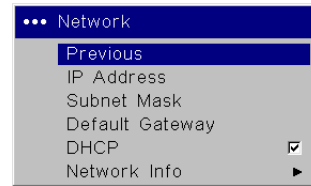
**DHCP:** Select this to automatically obtain an IP address, Subnet mask, and Default gateway.

**Network Info:** Provides information on the network configuration.

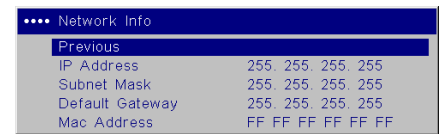
The **Network Info** menu is informational and cannot be edited. It displays the current IP Address, Subnet Mask, Default Gateway, and the projector's MAC Address.



Custom Key

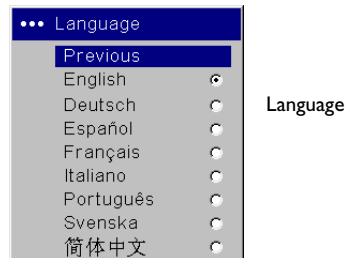


Network



Network Info

**Language:** allows you to select a language for the onscreen display of menus and messages.



**Service:** to use these features, highlight them and press **Select**.

**Factory Reset:** restores all settings (except Lamp and Filter Hours and Network settings) to their default after displaying a confirmation dialog box.

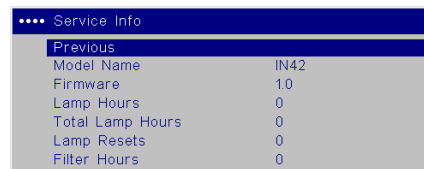
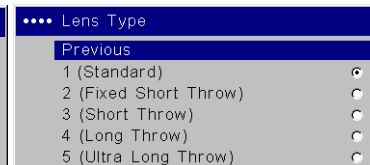
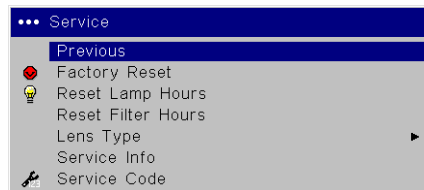
**Reset Lamp Hours:** resets the lamp hours counter in the Service Info menu to zero. Do this only after changing the lamp. It displays a confirmation dialog box.

**Reset Filter Hours:** resets the filter counter in the Service Info menu to zero. Do this only after cleaning the filter. It displays a confirmation dialog box.

**Lens Type:** change this setting only if you purchase an optional lens. The projector customizes its keystone settings based on the lens used. Select your optional lens from the menu. A sticker containing a number between 1 and 5 is attached to the lens to help you identify which type of lens you purchased.

**Service Info:** provides information for service.

**Service Code:** only used by authorized service personnel.

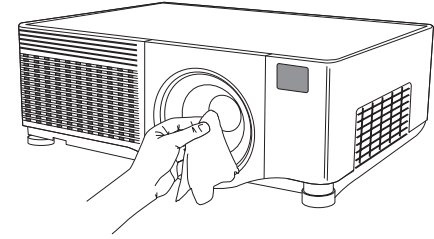


# Maintenance

## Cleaning the lens

- 1 Apply a non-abrasive camera lens cleaner to a soft, dry cloth.  
Avoid using an excessive amount of cleaner, and don't apply the cleaner directly to the lens. Abrasive cleaners, solvents or other harsh chemicals might scratch the lens.
- 2 Lightly wipe the cleaning cloth over the lens in a circular motion. If you don't intend to use the projector immediately, replace the lens cap.

clean the lens  
with a soft dry cloth  
and non-abrasive  
cleaner

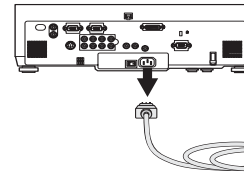


## Replacing the clock batteries

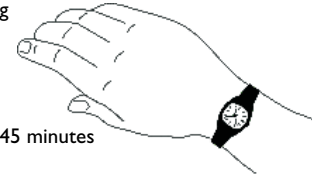
The projector has a lithium Hitachi Maxell battery (part number CR2032) on the bottom that is used to power the clock used for networking applications. Visit our website for complete details on using the networking functionality.

- 1 Turn off the projector and unplug the power cable.
- 2 Wait 45 minutes to allow the projector to cool thoroughly.
- 3 Turn the projector upside down and use a coin to turn the battery cover to the "Open" position.
- 4 Remove the battery and dispose of in an environmentally proper manner.
- 5 Install a new battery with the "+" side facing up.
- 6 Press the battery into place, then replace the battery cover.

turn off and unplug  
the projector



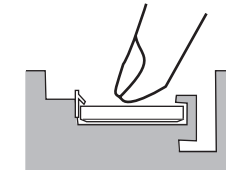
wait 45 minutes



open battery cover



install new battery,  
+ side up



press battery into position

CLOSE



close battery cover

**NOTE:** The clock time will need to be reset in the web browser application after replacing the battery.

## Replacing the projection lamp

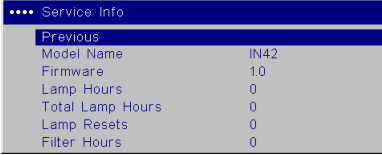
The lamp hour timer in the Service Info menu counts the number of hours the lamp has been in use. Twenty hours before the specified end of the lamp's life, the message "Change lamp" briefly appears on the projected screen.

**NOTE:** You can order new lamp housings from [www.infocus.com](http://www.infocus.com) (in select areas), your retailer or your dealer. Use only a replacement lamp with the same type and rating as the original lamp. The part number is SP-LAMP-027.

- 1 Turn off the projector and unplug the power cable.
- 2 Wait 45 minutes to allow the projector to cool thoroughly.
- 3 Loosen the lamp cover screw on the right side of the projector (marked by the arrow) then slide and lift the lamp cover off.

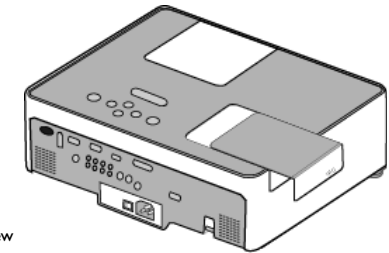
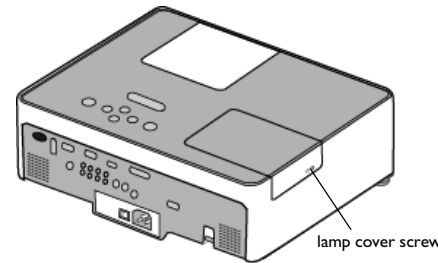
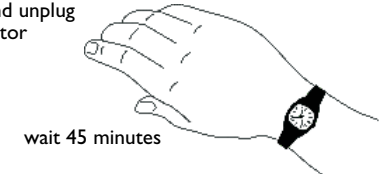
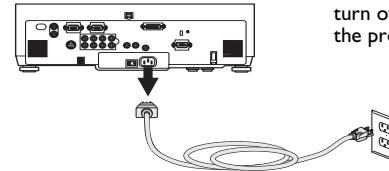
### WARNINGS:

- To avoid burns, allow the projector to cool for at least 45 minutes before you replace the lamp.
- Do not drop the lamp module. The glass may shatter and cause injury. Do not touch the glass lamp screen. Fingerprints can obscure projection sharpness.
- Be extremely careful when removing the lamp housing. In the unlikely event that the bulb ruptures, small glass fragments may be generated. The lamp housing is designed to contain these fragments, but use caution when removing the lamp housing. Before replacing the lamp, clean the lamp compartment and dispose of cleaning materials. Wash hands after lamp replacement. This product has a lamp which contains a very small amount of mercury. Dispose of it as required by local, state or federal ordinances and regulations. For more information see [www.eiae.org](http://www.eiae.org).



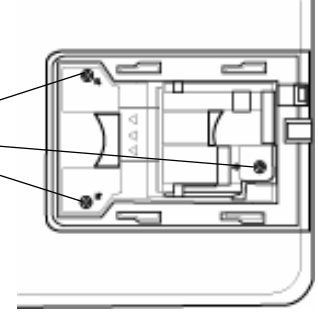
Service Info	
Previous	
Model Name	IN42
Firmware	1.0
Lamp Hours	0
Total Lamp Hours	0
Lamp Resets	0
Filter Hours	0

Service Info menu



4 Loosen the three captive screws (marked by the arrows) on the lamp module.

loosen the captive screws on lamp module



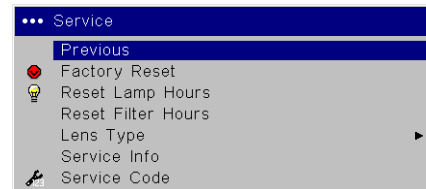
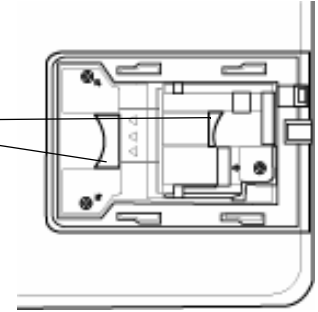
5 Carefully remove the lamp module by grasping and lifting the handle. Dispose of the lamp in an environmentally proper manner.

6 Install the new lamp module, making sure that it is properly seated, and tighten the three captive screws.

7 Replace the cover over the lamp module by sliding it back into place and tightening the screw.

8 Plug in the power cable, press the power switch then press the **Power** button to turn the projector back on. Reset the lamp hour timer by navigating to the **Settings>Service** menu and selecting **Reset Lamp Hours**.

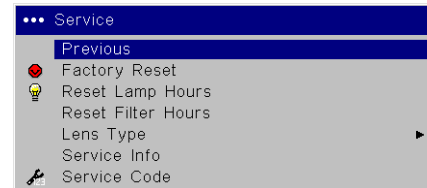
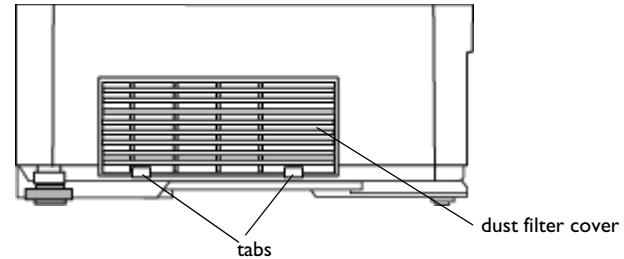
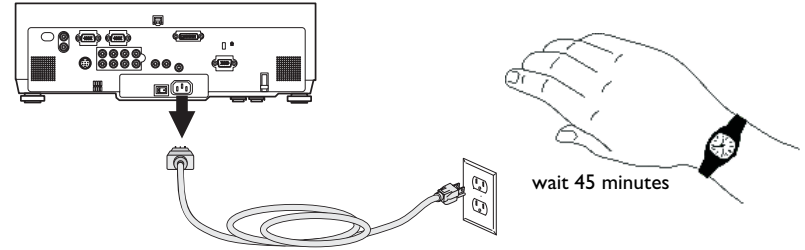
lamp module handle



reset lamp hours in Service menu

## Cleaning the dust filter

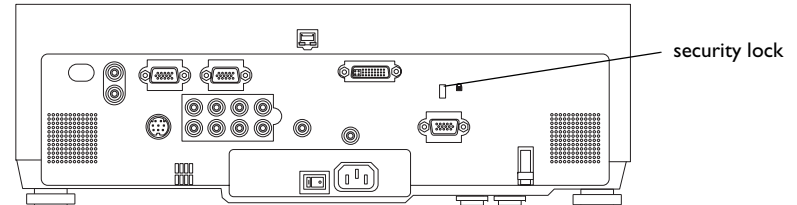
- 1 Turn off the projector and unplug the power cable.
- 2 Wait 45 minutes to allow the projector to cool thoroughly.  
**WARNING:** To avoid burns, allow the projector to cool for at least 45 minutes before you clean or replace the dust filter.
- 3 Remove the dust filter cover on the side of the projector by pressing up on the two tabs at the cover's bottom.
- 4 Pull the tab on the center of the black dust filter bracket and lift it off.
- 5 Clean the filter, cover, and vent using a vacuum set on low power. Replace the filter if it is damaged or too dirty to clean.
- 6 Replace the dust filter and the bracket on the cover, then replace the dust filter cover.
- 7 Reset the filter hour timer by navigating to the **Settings>Service** menu and selecting **Reset Filter Hours**.



reset filter hours in Service menu

## Using the security lock

The projector has a security lock for use with a cable lock system. See the Accessories catalog that came with the projector, or visit our website, for ordering information. Refer to the information that came with the lock for instructions on how to use it.



# Appendix

## Projected image size

**NOTE:** Visit the Service section of our website for interactive image size calculators for the standard and optional lenses.

**Table 2: Projection sizes: Standard lens (1.5 - 1.8:1 throw ratio)**

Distance (feet/m)	Minimum Image		Maximum Image	
	Diagonal Image (feet/m)	Image Width (feet/m)	Diagonal Image (feet/m)	Image Width (feet/m)
Min Distance 3/0.9	2.1/0.66	1.7/0.53	2.6/0.79	2.1/0.63
5/1.5	3.5/1.1	2.8/0.86	4.2/1.3	3.4/1.0
10/3.0	7.0/2.1	5.6	1.7	8.3/2.5
15/4.6	10.4/3.2	8.3/2.5	12.5/3.8	10/3
20/6.1	13.8/4.2	11/3.4	16.6/5.1	13.3/4
25/7.6	17.2/7.6	13.8/4.2	20.7/6.3	16.6/5
Max Distance 30/9.1	20.6/6.3	16.5/5	24.8/7.6	19.8/6.1

The image offset range for the standard lens is 9:1 (90%) to 1:1 (50%).

**Table 3: Projection sizes: Short Fixed lens (0.8:1 throw ratio)**

Screen Size (inch/m)	Projection Distance (inch/m)
	Minimum
40/1	24/0.6
60/1.5	35/0.9
70/1.8	43/1.1
100/2.5	63/1.6
120/3	75/1.9
150/3.8	94/2.4
200/5.1	130/3.3
250/6.4	161/4.1
300/7.6	193/4.9
350/8.9	224/5.7

**Table 4: Projection sizes: Short Zoom lens (1.2 -2.0:1 throw ratio range)**

Screen Size (inch/m)	Projection Distance (inch/m)	
	Minimum	Maximum
40/1	39/1.0	63/1.6
60/1.5	59/1.5	94/2.4
70/1.8	67/1.7	110/2.8
100/2.5	98/2.5	157/4.0
120/3	118/3.0	189/4.8
150/3.8	150/3.8	240/6.1
200/5.1	197/5.0	319/8.1
250/6.4	248/6.3	402/10.2
300/7.6	299/7.6	480/12.2
350/8.9	350/8.9	559/14.2

**Table 5: Projection sizes: Long Throw lens (1.9 - 3.9:1 throw ratio range)**

Screen Size (inch/m)	Projection Distance (inch/m)	
	Minimum	Maximum
40/1	59/1.5	122/3.1
60/1.5	94/2.4	185/4.7
70/1.8	110/2.8	217/5.5
100/2.5	157/4.0	311/7.9
120/3	189/4.8	374/9.5
150/3.8	236/6.0	467/11.9
200/5.1	319/8.1	630/16.0
250/6.4	402/12.2	787/23.9
300/7.6	480/16.3	945/23.0
400/10.2	642/20.4	1260/40.1
500/12.7	803/20.4	1579/40.1



**Table 6: Projection sizes: Ultra Long Throw lens (3.9 - 7.4:1 throw ratio range**

<b>Screen Size (inch/m)</b>	<b>Projection Distance (inch/m)</b>	
	<b>Minimum</b>	<b>Maximum</b>
40/1	122/3.1	236/6.0
60/1.5	189/4.8	354/9.0
70/1.8	220/5.6	513/10.5
100/2.5	315/8.0	594/15.1
120/3	382/9.7	717/18.2
150/3.8	476/12.1	898/22.8
200/5.1	638/16.2	1197/30.4
250/6.4	799/24.4	1496/45.6
300/7.6	961/28.5	1795/53.3
400/10.2	1283/32.6	2398/60.9
500/12.7	1602/40.7	3000/76.2

## RS-232 commands

### Communication Configuration

Visit our website for additional RS-232 settings and information.

To control this projector via RS-232, connect a null modem cable and set the control system serial port settings to match the following communication configuration:

RS-232 Port Settings	
Setting	Value
Bits per second	19,200
Data bits	8
Parity	None
Stop bits	1
Flow control	None
Emulation	VT100

### Command Format

All commands consist of 3 alpha characters followed by a request, all enclosed in parentheses. The request can be a read request (indicated by a "?") or a write request (indicated by 1 to 4 ASCII digits).

A read request example:

(AAA?) where

( starts the command

AAA denotes the command

? denotes the read request

) ends the command

A read command returns the range and the current setting, for example:

Read Command Examples		
Function	Command	Response
Brightness	(BRT?)	(96-160,128)
Volume	(VOL?)	(0-32, 0)
Lamp Hours	(LMP?)	(0-65534, 42)

A write request example:

(AAA#####) where

( starts the command

AAA denotes the command

##### denotes the value to be written

( leading zeros not necessary)

) ends the command

Some commands have ranges, while others are absolute. If a number greater than the maximum range is received, it is automatically set to the maximum number for that function. If a command is received that is not understood, a "?" is returned. With absolute settings, "0" is off, 1-9999 is on. The one exception is the Power command, where 0 is off and 1 is on.

To assure the projector can process a command, wait 3 seconds before entering the next command.

## Write Command Examples

Function	Command	Response
Brightness	(BRT140)	Sets the brightness to 140
Power	(PWRO)	Turns power off
Power	(PWR1)	Turns power on

### Error Conditions

Not all commands are supported for all projectors. If an unsupported command is issued, the command will be ignored. If a command is received that is not understood, a '?' character will be returned indicating the command was not understood.

### Limitations

The projector cannot respond to commands coming in at a high-rate. Therefore, a delay must occur between commands to ensure that the command gets properly executed. To assure the projector can process a command, wait 3 seconds before entering the next command.

The Step column refers to increasing or decreasing the menu bar position since the On-screen Display is not an exact match of values. For example, Step 2 changes the data by 2 through the CLI (Command Line Interface). The menu bar is up (or down) by 1.

Function	Command	Min	Max	De-fault	Step
About (Source Info) 0: n/a 1: enable	ABT at W	0	1	n/a	
Active Iris 0: Off 1: Presentation 2: Film	IRI at RW	0	2	1	
Aspect Ratio 0: Native 1: 16:9 2: 4:3	ARZ at RW	0	2	2	
Auto Image 0: n/a 1: enable	AIM at W	0	1	n/a	
Auto Power 0: disable 1: enable	APO at RW	0	1	0	
Auto Source 0: disable 1: enable	ASC at RW	0	1	1	
Blank 0: off 1: on	BLK at RW	0	1	0	

Blank Screen 0: black 1: blue 2: white	BSC at RW	0	2	1	
Blue Gain	BCG at RW	64	192	128	1
Brightness	BRT at RW	96	160	128	1
Ceiling 0: disable 1: enable	CEL at RW	0	1	0	
Chime 0: disable 1: enable	ACE at RW	0	1	1	
Color	CLR at RW	96	160	128	1
Color Space 0: RGB 1: SMPTE240 2: REC709 3: REC601 7: Auto	CSM at RW	0	7	7	
Color Temp 0: 9300K 1: 6500K 2: 7200K 3: User	TMP at RW	0	3	2 (computer) 1 (video)	
Contrast	CON at RW	96	160	128	1

Custom Key (Effect) 0: blank 1: mute 2: aspect ratio 3: source 4: auto image 5: freeze 6: zoom 7: Source Info 8: Service Info	EFK at RW	0	8	7	
Display Messages 0: disable 1: enable	DMG at RW	0	1	1	
Factory Reset 0: not reset 1: reset	RST at W	0	1	n/a	
Freeze 0: disable 1: enable	FRZ at RW	0	1	0	
Green Gain	GCG at RW	64	192	128	1
Horizontal Keystone	DKH at RW	38	218	128	1
Horizontal Position	HPS at RW	def:- 128	def:+1 28	auto	1
Internal Sound Enable 0: disable 1: enable	INT at RW	0	1	1	
IR Receiver front 0: disable 1: enable	IRF at RW	0	1	1	

IR Receiver rear 0: disable 1: enable	IRR at RW	0	1	1	
IR Receiver top 0: disable 1: enable	IRT at RW	0	1	0	
Language 0 = English 1 = French 2 = German 3 = Spanish 7 = Portuguese 10 = Simplified Chinese 11 = Italian 12 = Swedish	LAN at RW	0	11	0	
Lamp Hours	LMP at R	0	32766	0	1
Lamp Lit 0: not lit 1: lit	LML at R	0	1		
Reset Lamp Hours 0: not reset 1: reset	LRT at W	0	1	n/a	
Number of Lamp Resets	LMR at R	0	32766	0	
Lamp Total On Time (All Bulbs)	LMT at R	0	21474 83646	0	
Time In Hours Last Bulb1 Lasted	LBI at R	0	32766	0	

Time In Hours Last Bulb2 Lasted	LB2 at R	0	32766	0	
Time In Hours Last Bulb3 Lasted	LB3 at R	0	32766	0	
Low Power 0: disable 1: enable	LPE at RW	0	1	0	
Magnify	MAG at RW	0	48	0	1
Magnify Enable 0: disable 1: enable	MGE at RW	0	1	0	
Magnify Position Horizontal	MPH at RW	128	896	512	1
Magnify Position Vertical	MPV at RW	96	672	384	1
Menu 0: disable 1: enable	MNU at RW	0	1	0	
Menu Navigation 0: up 1: down 4: select	NAV at W	0	4	n/a	
Mute 0: disable 1: enable	MTE at RW	0	1	0	

NND (PC Screen Saver Off) 0: disable 1: enable	NND at RW	0	1	1	
Overscan 0: disable 1: enable	OVS at RW	0	1	0	
Phase	MSS at RW	0	26	0	1
Power 0: disable 1: enable	PWR at RW	0	1	0	
Power Save 0: disable 1: enable	PSV at RW	0	1	0	
Power-up Source 0: computer 1 1: computer 2 2: video 1 3: video 2 4: video 3	DSC at RW	0	4	0	
Presets 0: presentation 1: photography 2: film 3: video 9: Presets Off 10: user 1 11: user 2 12: user 3	PST at RW	0	12	c: 0 v: 2	

Rear 0: disable 1: enable	REA at RW	0	1	0	
Red Gain	RCG at RW	64	192	128	1
Reset Filter Hours 0: not reset 1: reset	FRT at W	0	1	n/a	
Save User Presets 1 0: not saved 1: saved	US1 at W	0	1	n/a	
Save User Presets 2 0: not saved 1: saved	US2 at W	0	1	n/a	
Save User Presets 3 0: not saved 1: saved	US3 at W	0	1	n/a	
Screen Save 0: 5 minutes 1: 10 minutes 2: 15 minutes 3: 20 minutes 4: 25 minutes 5: 30 minutes	SSV at RW	0	5	0	
Sharpness 5 = Sharpest 6 = Sharper 7 = Standard 8 = Softer 9 = Softest	SHP at RW	5	9	7 (computer and video 1) 6 (video 2 and 3)	

Source 0: computer 1 1: computer 2 2: video 1 3: video 2 4: video 3	SRC at RW	0	4	0	
Source 1 0: computer 1 1: computer 2 2: video 1 3: video 2 4: video 3	SR1 at RW	0	4	0	
Source 2 0: computer 1 1: computer 2 2: video 1 3: video 2 4: video 3	SR2 at RW	0	4	1	
Source 3 0: computer 1 1: computer 2 2: video 1 3: video 2 4: video 3	SR3 at RW	0	4	2	
Source 4 0: computer 1 1: computer 2 2: video 1 3: video 2 4: video 3	SR4 at RW	0	4	3	

Startup Logo 0: blank screen 1: default 2: captured	DSU at RW	0	2	1	
Tint	TNT at RW	96	160	128	1
Tracking	MTS at RW	def: -128	def: +128	auto	1
Unit Total Time On	ONL at R	0	21474 83646	0	
Vertical Keystone	DKC at RW	38	218	128	1
Vertical Position	VPS at RW	if def< 128: 0 else: def - 128	if def<1 28: def x2 else: d ef +128	auto	1
Video Standard 0: Auto 1: NTSC 2: PAL 3: SECAM	VSU at RW	0	3	0	
Volume	VOL at RW	0	32	16	1

## INDEX

### A

- Aspect Ratio 31
- audio 22
- Audio In connector 7, 11
- Auto Image 31
- Auto Power 29
- Autosource 29

### B

- Blank 31
- Brightness 10

### C

- Capture Position 30
- Capture Start 30
- cleaning the dust filter 36
- cleaning the lens 33
- clock batteries 33
- Color 13
- colors are incorrect 18
- component cable connector 11
- computer connections
  - optional 7
  - required 7
- computer image
  - displaying 9
  - optimize 23
- connector panel 5
- contacting service 20
- Contrast 10, 13
- custom logo startup screen 30
- customer service contact information 20

### D

- Default gateway 31
- DHCP 31
- Display Messages 29
- displaying
  - computer image 9
  - video images 12
- dust filter, cleaning 36

### E

- elevator foot 10, 12

### F

- Factory Reset 32
- filter, resetting hours 32
- focus 10, 13
- Freeze 31
- fuzzy image 16

### H

- HDTV sources 11

### I

- image
  - display computer 9
  - display video 12
  - size 6
- image does not fit screen 17
- image not centered 20
- image not sharp 17
- image not square 17
- image reversed 18
- image size matrix 37
- image upside down 18
- IP Address 31
- IR Receivers 29



## **L**

- lamp hours, resetting 35
- lamp replacement 34
- lamp won't turn on 19
- Language 32
- laptop
  - connecting 7
  - external video port 9
- lens, cleaning 33
- Low Power 29

## **M**

- Magnify 31
- Main menu 25
- menu system 25
- Monitor connector 8
- mouse, using your 7
- Mute 31

## **N**

- Network 31
- Network connector 8
- Network Info 31
- no computer image 16
- no startup screen 15

## **O**

- only startup screen appears 15
- Overscan 28

## **P**

- PC Screen Saver Off 29
- Picture menu 26
- power cable 7, 11
- Power Save 30
- Power-up Source 29
- presentation features 23
- projection distance 6
- projector
  - connector panel 5
  - customizing 24
  - height 10, 12
  - positioning 6, 10, 12
  - setting up 6
  - shutdown 14
  - troubleshooting problems 14

## **R**

- Rear 29
- remote control 21
- replacing the clock batteries 33
- replacing the lamp 34
- Reset Filter Hours 32
- resetting lamp hours 35
- RS-232
  - cable 8
  - connecting 5

## **S**

- screen saver, turning off 29
- security lock 36
- serial connection 5, 8
- Service 32
- Service Code 32
- Service Info 32
- Settings menu 29
- shutting down projector 14
- Source 31
- Source troubleshooting 15
- Sources 29
- Subnet mask 31
- S-video connector 11

## **T**

- Tint 13
- troubleshooting 14, 15

## **V**

- video connections
  - optional 11
  - standard 11
- Video connector 11
- video image
  - displaying 12
- video images
  - optimizing 24
- Video Standard 28
- volume adjustment 13

## **W**

- warranty 20

## **X**

- XGA 4

## **Z**

- zoom 10, 13