

myprojectorlamps.com

**The most trusted, dependable name
in projector lamp sales.**



<http://www.myprojectorlamps.com>



<http://www.myprojectorlamps.ca>



<http://www.myprojectorlamps.eu>

The following projector manual has not been modified or altered in any way.

IN3902LB, IN3904LB

IN3900 (SERIES)



InFocus



Regulatory models: W3902, W3904

InFocus

Bright Ideas Made Brilliant

010-0728-01

Declaration of Conformity

Manufacturer: InFocus Corporation, 13190 SW 68th Parkway, Portland, OR 97223-8368, USA

We declare under our sole responsibility that this projector conforms to the following directives and norms:

EMC Directive 2004/108/EC

R&TTE Directive: 1999/5/EC

EuP Directive: 2005/32/EC

Low Voltage Directive: 2006/95/EC

ETSI: EN 300 440, EN 301 489

EMC: EN 55022, EN 55024, EN 61000-3-2, EN 61000-3-3

Safety: IEC 60950-1:2005, MOD.

The receiver portion of this product is a Category III device, as specified in EN 300 440.

Trademarks

DisplayLink is a trademark of DisplayLink Corporation.

Apple, Macintosh, and PowerBook are trademarks or registered trademarks of Apple Computer, Inc. IBM is a trademark or registered trademark of International Business Machines, Inc. Microsoft, PowerPoint, and Windows are trademarks or registered trademarks of Microsoft Corporation. Adobe and Acrobat are trademarks or registered trademarks of Adobe Systems Incorporated. DLP® and the DLP logo are registered trademarks of Texas Instruments and BrilliantColor™ is a trademark of Texas Instruments. InFocus, In Focus, and INFOCUS (stylized) are either registered trademarks or trademarks of InFocus Corporation in the United States and other countries.



NOTE: This product is covered electrical and electronic equipment under the European Union's Waste from Electrical and Electronic Equipment ("WEEE") Directive (2002/96/EC).

The WEEE Directive requires that covered equipment be collected and managed separately from typical household waste in all EU member states. Please follow the guidance of your local environmental authority or ask the shop where you purchased the product for collection or recycling options.

FCC Warning

This device complies with part 15 of the FCC Rules. Operation is subject to the following two conditions: (1) This device may not cause harmful interference, and (2) this device must accept any interference received, including interference that may cause undesired operation.

Note: This equipment has been tested and found to comply with the limits for a Class B digital device, pursuant to part 15 of the FCC Rules. These limits are designed to provide reasonable protection against harmful interference in a residential installation. This equipment generates, uses and can radiate radio frequency energy and, if not installed and used in accordance with the instructions, may cause harmful interference to radio communications. However, there is no guarantee that interference will not occur in a particular installation. If this equipment does cause harmful interference to radio or television reception, which can be determined by turning the equipment off and on, the user is encouraged to try to correct the interference by one or more of the following measures:

--Reorient or relocate the receiving antenna.

--Increase the separation between the equipment and receiver.

--Connect the equipment into an outlet on a circuit different from that to which the receiver is connected.

--Consult the dealer or an experienced radio/TV technician for help.

Changes or modifications not expressly approved by InFocus Corporation may void authority to operate the equipment.

Canada

This Class B digital apparatus complies with Canadian ICES-003.

Cet appareil numérique de la classe B est conforme à la norme NMB-003 du Canada.

Agency Approvals

UL, cUL

Other specific Country Approvals may apply. Please see product certification label.

This document applies to regulatory models W3902 and W3904.

Input ratings: 100-240Vac, 3.3-1.2A, 50-60Hz

InFocus reserves the right to alter product offerings and specifications at any time without notice.

Table of Contents

Introduction	4
Positioning the projector	6
Connecting a computer source	7
DisplayLink or VGA	7
Optional computer connections	8
Displaying an image	9
Adjusting the image	10
Connecting a video device	12
Video device connections	12
Composite video connection	12
HDMI 1.3 connection	12
S-video connection	12
VGA connection	12
Component video connection	12
LiteBoard™ Wand	13
Charging the Wand's Battery	13
Wand Position and Avoiding Shadows	14
Using More than One Wand	14
Wand Features	14
Buttons and Wand Tip	15
LiteBoard Wand Menu	15
Troubleshooting LiteBoard	16
Shutting down the projector	18
Troubleshooting your setup	18
Using the remote control	26
Using the audio	27
Using the keypad buttons	28
Optimizing computer images	29
Presentation features	29
Optimizing video images	30
Customizing the projector	30
Dynamic Messaging	30
Using the menus	31
Basic Picture menu	32
Advanced Picture menu	33
Setup menu	34
Status and Service menu	37

Using Network Functions	38
Using LitePort	42
Maintenance	45
Cleaning the lens	45
Replacing the projection lamp	46
Using the security lock	47

Important Operating Considerations for Safety

- Refer to this guide for proper startup and shutdown procedures.
- Follow all warnings and cautions in this manual and on the projector.
- Place the projector in a horizontal position no greater than 15 degrees off axis.
- Locate the projector at least 4' (1.2m) away from any heating or cooling vents.
- Do not block ventilation openings. Locate the projector in a well-ventilated area without obstructions to intake or exhaust vents. Do not place the projector on a tablecloth or other soft covering that may block the vents.
- Do not place the projector in direct sunlight, humid, greasy or dusty places or in places where the projector may come into contact with smoke or steam.
- Do not look directly into the lens while the projector is being used.
- Do not drop the projector.
- Do not spill liquid on the projector. Spilled liquid may damage the projector.
- Use the power cord provided. Connect the power cord to a receptacle with a protective safety (earth) ground terminal. A surge-protected power strip is recommended.
- Do not overload wall outlets.
- When disconnecting the power cord, hold the plug, not the cord.
- Wash hands after handling the cables supplied with this product.
- The projector remote control uses batteries. Make sure the batteries' polarity (+/-) is aligned correctly. Dispose of used batteries in accordance with local disposal laws.
- Use an InFocus approved ceiling mount kit for proper fitting, ventilation and installation. The warranty does not cover any damage caused by use of non-approved ceiling mount kits or by installing in an improper location.
- When the projector is ceiling mounted, wear protective eyewear to prevent eye injury before opening lamp door.

- Refer all service to qualified service personnel. Servicing your own projector can be dangerous to you and will void the warranty.
- Only use replacement parts specified by InFocus. Unauthorized substitutions may result in fire, electrical shock, or injury, and may void the warranty.
- Only genuine InFocus lamps are tested for use in this projector. Use of non InFocus lamps may cause electrical shock and fire, and may void the projector warranty.
- Hg – Lamp contains mercury. Manage in accordance with local disposal laws. See www.lamprecycle.org.
- The projector uses a high-pressure mercury glass lamp. The lamp may fail prematurely, or it may rupture with a popping sound if jolted, scratched, or handled while hot. The risk of lamp failure or rupture also increases as the lamp age increases; please replace the lamp when you see the "Replace Lamp" message.
- In the unlikely event of a lamp rupture, particles may exit through the projector vents. Keep people, food, and drinks out of the "keep out" area under and around the projector, as indicated by the "X" areas below.

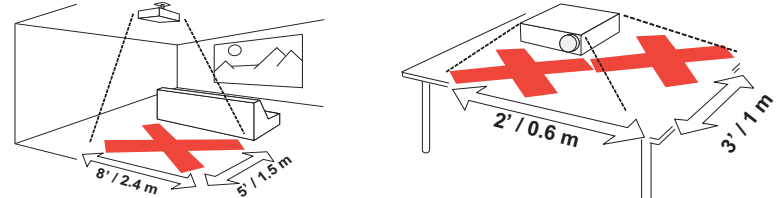

Follow these instructions to help ensure image quality and lamp life over the life of the projector. Failure to follow these instructions may affect the warranty. For complete details of the warranty, see the Warranty Booklet.

Introduction

Your new digital projector is simple to connect, easy to use, and straightforward to maintain. It is a versatile projector that is flexible enough for business presentations and home video viewing too. The IN3902LB has native XGA 1024x768 resolution, and the IN3904LB has WXGA 1280x800 resolution. This guide applies to all products. They are compatible with a wide variety of computers and video devices.

Product specifications

To read the latest specifications on your multimedia projector, be sure to visit our website at www.infocus.com, as specifications are subject to change.

Accessories

The standard accessories that came with your projector are listed in the included Quick Start Poster/Booklet. Optional accessories can be found on our website at www.infocus.com or at your retailer or dealer.

Online registration

Register your projector on our website at www.infocus.com/register to activate your warranty and receive product updates, announcements, and registration incentives.

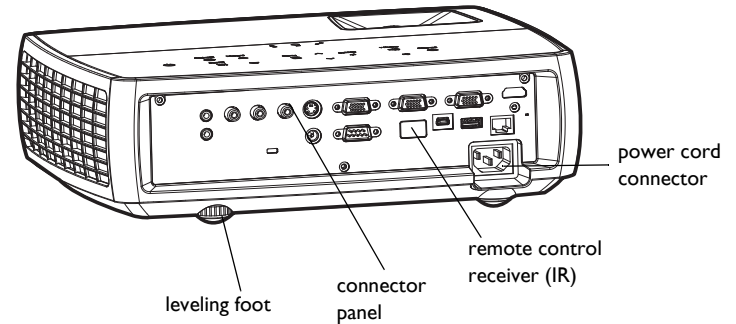
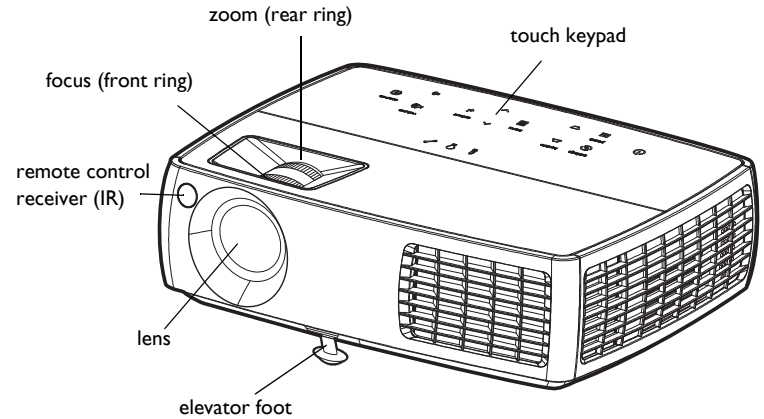

Connector panel

The projector provides both computer and video connection options, including:

- VGA computer (2)
- HDMI
- S-video
- Composite video
- Separate assignable audio inputs for video and computer
- USB DisplayLink connector, for computer audio/video input. This USB connection also provides slide advance (and mouse control when used with an optional remote control only)

The projector also provides the following connectors:

- Monitor out, to provide an image on your desktop computer as well as on the projection screen
- LAN port for network control and web server.
- LitePort, for connecting a USB flash drive containing images.
- Audio out, to provide sound for external speakers
- A 5 volt DC output (see below)
- RS-232 connector for serial control. The Command Line Interface (CLI) specifications and commands are on our website.

NOTE: DisplayLink video and audio is not sent to monitor out and audio out.

5 volt DC output

The coaxial 6.4mm x 2.2mm jack provides a constant 5 volt, 2 amp DC output when the projector is on, and will also provide power when the projector is in standby (powered off) if Network and DisplayLink items in the Always-On Functions submenu are set to Yes. It is designed to provide power for an InFocus LiteShow II wireless device, which allows wireless projection. More information can be found on our website at www.infocus.com or at your retailer or dealer.

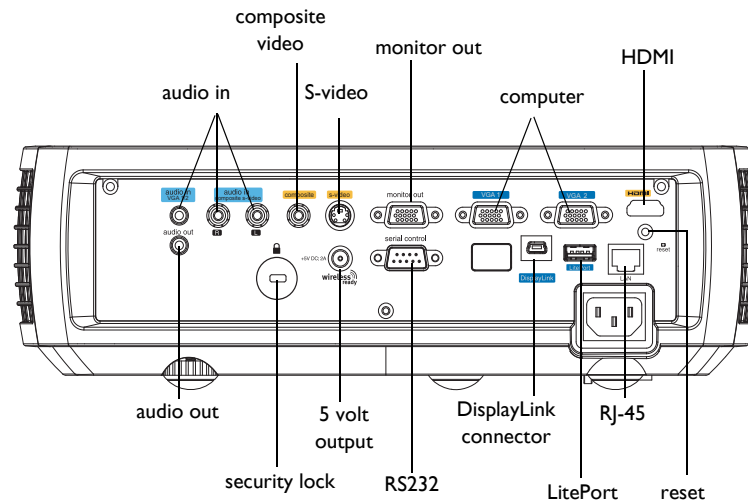

Positioning the projector

To determine where to position the projector, consider the size and shape of your screen, the location of your power outlets, and the distance between the projector and the rest of your equipment. Here are some general guidelines:

- Position the projector on a flat surface at a right angle to the screen. The projector must be at least 4.9 feet (1.5m) from the projection screen.
- Position the projector within 10 feet (3m) of your power source and within 6 feet (1.8m) of your video device (unless you purchase extension cables). To ensure adequate cable access, do not place the projector within 6 inches (.15m) of a wall or other object.
- If you are installing the projector on the ceiling, we strongly recommend using InFocus approved ceiling mounts for proper fitting, ventilation and installation. Refer to the installation guide that comes with the InFocus Ceiling Mount Kit (p/n SP-CEIL-UNIV) for more information. The warranty does not cover any damage caused by use of non-approved ceiling mount kits or by installing in an improper location.
- Position the projector the desired distance from the screen. The distance from the lens of the projector to the screen, the zoom setting, and the video format determine the size of the projected image.
- The image exits the projector at a given angle. IN3902LB image offset is 115%; IN3904LB image offset is 112.4%. This means that if you have an image 10' high, the bottom of the image will be 1.5' (IN3902LB) and 1.24' (IN3904LB) above the center of the lens.

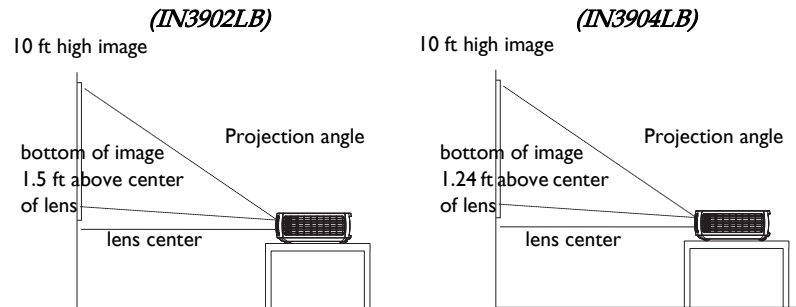

Table 1: (IN3902LB)

Range of distance to the screen for a given screen size

Diagonal Screen Size (inches/m)	Distance to screen	
	Maximum distance (feet/m)	Minimum Distance (feet/m)
60/1.5	8.6/2.6	7.8/2.4
80/2.0	11.5/3.5	10.4/3.2
90/2.3	12.9/3.9	11.7/3.6
150/3.8	21.5/6.6	19.5/5.9

Table 2: (IN3904LB)

Range of distance to the screen for a given screen size

Diagonal Screen Size (inches/m)	Distance to screen	
	Maximum distance (feet/m)	Minimum Distance (feet/m)
60/1.5	7.3/2.2	6.5/2.0
80/2.0	9.7/2.9	8.7/2.7
90/2.3	10.9/3.3	9.8/3.0
150/3.8	18.1/5.5	16.3/5.0

Connecting a computer source

DisplayLink or VGA

If you have a Windows or Macintosh computer, connect the USB cable between your computer's USB port and the projector's **DisplayLink** connector*. Then to begin installation of the DisplayLink software:

Windows: Follow the instructions on the screen.

Macintosh: A folder will open containing a file named DisplayLink Installer.pkg. Open that file and follow the instructions on the screen.

* For detailed DisplayLink instructions and troubleshooting, and to download the latest DisplayLink software, go to www.infocus.com/support/displaylink.

Or, connect one end of the provided computer cable to the **VGA 1** or **VGA 2** connector on the projector and the other to the VGA connector on your computer. If you are using a desktop computer, you will need to disconnect the monitor cable from the computer's video port first (you can connect this monitor cable to the **Monitor Out** connector on the projector, see below).

Connect the black power cord to the **Power** connector on the side of the projector and to your electrical outlet. The Power light on the Status Indicator Panel (on page 18) turns amber.

NOTE: Always use the power cord that shipped with the projector.

connect USB cable

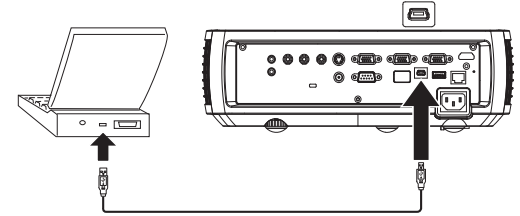

connect computer cable

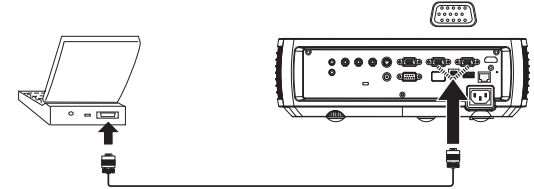

connect power cord

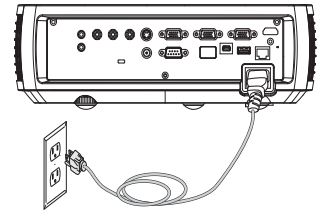

Optional computer connections

To get sound from the projector, connect an audio cable (optional cable, not included) to your computer and to the **Audio In Computer** connector on the projector. You may also need an adapter.

If you are using a desktop computer and want to see the image on your computer screen as well as on the projection screen, connect the computer's monitor cable to the **Monitor Out** connector on the projector.

NOTE: Only VGA video is sent to the Monitor out connector.

To display a presentation from a USB flash drive, see the Using LitePort section on page 42. This feature converts presentations to JPEG images and eliminates the need for a computer source and can be integrated with common wall plates and conference room input/output panels.

To advance slides in a PowerPoint presentation using the remote control, plug the USB cable between the projector's DisplayLink connector and your computer. Then press the up and down arrow buttons on the remote control to move through your slides.

You can control the projector from an LCD control panel, touch screen, or other control device or computer by connecting an RS-232 cable to the projector's **Serial Control** connector. Specific RS-232 commands can be found in the Service and Support section of our website.

The projector can be managed by networking software through its **Network** (RJ-45) connector. Detailed instructions on this feature can be found on our website.

connect audio cable

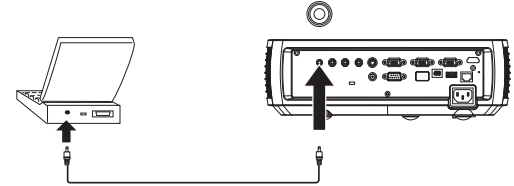

connect monitor cable

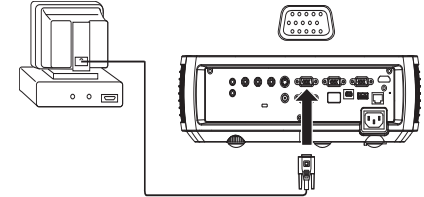

connect RS-232 cable

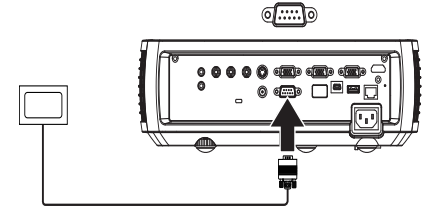
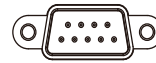

connect CAT-5 cable

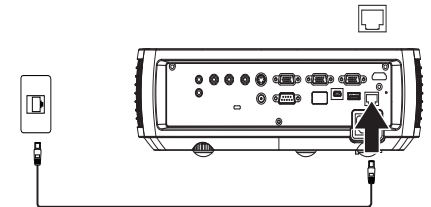

Displaying an image

Touch the **Power** button.

The Power button blinks green and the fans start to run. When the lamp comes on, the start up screen displays and the Power button is steady green. It can take a minute for the image to achieve full brightness.

? **No start up screen?** Get help on on page 19.

Turn on your computer or video device.

The image should appear on the projection screen. If it doesn't, press the **Source** button on the projector's keypad or remote.

If you are using a VGA cable to connect your computer to the projector (instead of DisplayLink):

If using a laptop, make sure its external video port is active.

Many laptops do not automatically turn on their external video port when a projector is connected. Usually a key combination like FN + F8 or CRT/LCD key turns the external display on and off. Locate a function key labeled CRT/LCD or a function key with a monitor symbol. Press FN and the labeled function key simultaneously. **Refer to your laptop's documentation for more information about your laptop's key combination or go to the InFocus website at: <http://www.infocus.com/Support/LaptopActivation.aspx>.**

? **No laptop image?** Try pressing the **Auto Image** button on the keypad. Get help on page 20.

? **Is your laptop connected to the projector's DisplayLink connector?** See the InFocus DisplayLink Software User's Guide (available on the InFocus website at www.infocus.com/displaylink) for troubleshooting information.

press Power button

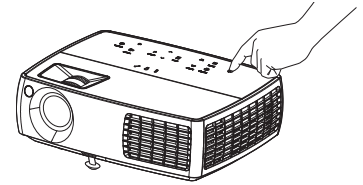

turn on computer or video device

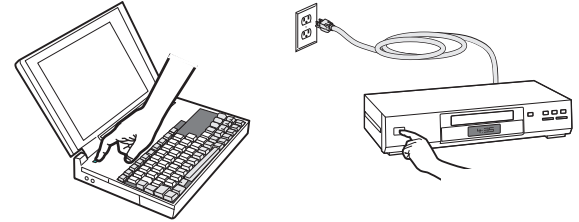

activate laptop's external port



monitor key or
LCD/CRT key

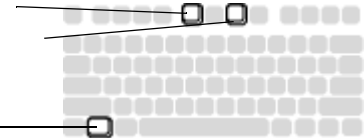

FN key

Adjusting the image

If necessary, adjust the height of the projector by pressing the elevator foot release button to extend the foot.

If necessary, rotate the leveling foot located at the rear of the projector.

Avoid placing your hands near the hot exhaust vent at the side of the projector.

Position the projector the desired distance from the screen at a 90 degree angle to the screen.

See the table listing screen sizes and distances on page 6.

Adjust the zoom or focus.

If the image is not square, first make sure that the projector is perpendicular to the screen. If the image is larger or smaller on the top or bottom edge of the screen, press the top **Keystone** button to reduce the upper part of the image, and press the bottom **Keystone** button to reduce the lower part.

If the left or right side of the screen is larger or smaller the other, you can turn the projector to the left or to the right a few degrees to square the image.

Adjust the Contrast or Brightness in the Basic Picture menu (on page 32).

For Aspect Ratio, keep in mind that DVD players must be configured for 16:9 in order to view the highest quality image (on page 11).

adjust height

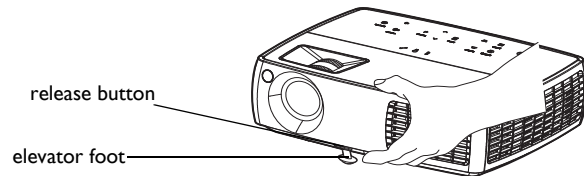

adjust distance

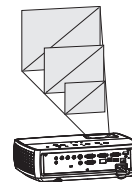

adjust zoom or focus

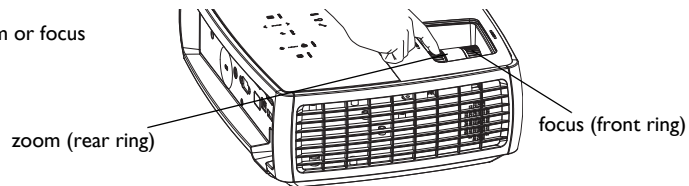

adjust keystone

keystone

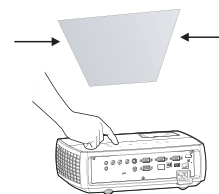

adjust Basic Picture menu
menu

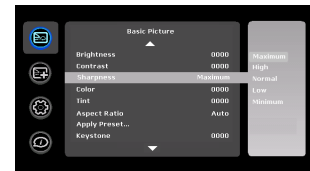

What is Aspect Ratio?

Aspect ratio is the ratio of the image width to image height. Standard TV screens and older laptops are 4:3; HDTV and most DVDs are 16:9; and widescreen computers are 16:10. If you are projecting onto a screen, the size/shape of the screen will influence the aspect ratio you decide to use. If you are projecting onto a blank wall, there are no screen size restrictions. What you plan to project will also help you choose between 4:3, 16:9 or 16:10. Many TV shows are 4:3, while most movies are 16:9.

If you have a 16:9 screen then you should select an aspect ratio of 16:9 for widescreen movies or HDTV, and Native for 4:3 content. If you have a 4:3 screen you should still use 16:9 for widescreen movies or HDTV, but you also have the option of using either 4:3 (to fill the screen) or Native (for direct pixel mapping) for 4:3 content. Force Wide can also be enabled to automatically resize less common aspect ratios to 16:10.

4:3 screen



16:9 screen



4:3
mode



16:9
mode

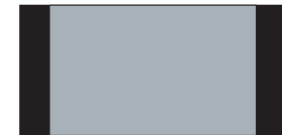

Native
mode
(NTSC
only)

Connecting a video device

You can connect video devices such as VCRs, DVD players, camcorders, digital cameras, video game consoles, HDTV receivers, and TV tuners to the projector. You can connect the audio directly to the projector to get sound from the built-in speaker, or you can bypass the projector's audio system and connect the audio directly from your source to a stereo or home theater system.

You can connect the projector to most video devices that can output video. You cannot directly connect the coaxial cable that enters your house from a cable or satellite company, the signal must pass through a tuner first. Examples of tuners are digital cable boxes, VCRs, digital video recorders, and satellite TV boxes. Basically, any device that can change channels is considered a tuner.

Before connecting your projector, you should decide which aspect ratio you want to use. The projector's Aspect Ratio setting is accessed through the Resize button on the remote or through the projector's Basic Picture Menu (on page 32).

Video device connections

No video cables are provided with the projector. You can order cables from InFocus or provide your own.

Composite video connection

Plug the composite video cable's yellow connector into the video-out connector on the video device. Plug the other yellow connector into the yellow **Video 3** connector on the projector.

Plug the white connector of a Mini-plug audio Y-cable into the left audio out connector on the video device and plug the red connector into the right audio out connector on the video device. Plug the other end of the cable into the **Audio In Video** connector on the projector.

Keep in mind that video output from composite connections is not as high quality as S-video.

HDMI 1.3 connection

HDMI is a standard, uncompressed, all-digital audio/video interface. HDMI provides an interface between sources, such as set-top boxes, DVD players, and receivers and your projector. Plug an HDMI cable into the video-out connector on the video device and into the HDMI connector on the projector.

To take advantage of HDMI 1.3 Deep Color (30 bit) you must have a 1.3-compatible source.

S-video connection

If your video device uses a round, four-prong S-video connector, plug an S-video cable into the S-video connector on your video device and into the **Video 2** connector on the projector. Use the audio cable as described above.

Keep in mind that S-video delivers higher quality video output than composite.

VGA connection

If your video device has a 15-pin VGA output, plug one end of the included computer cable into the VGA connector on your video source. This connector may be labeled "To Monitor" on the video source. Plug the computer cable into the **VGA 2** or **VGA 1** connector on the projector.

Component video connection

If your HD video device has component connectors, an optional Component to VGA adapter can be used. Plug the component cable into the video device. Plug the other end of the component cable into the adapter and plug the adapter into the **VGA 2** or **VGA 1** connector. Component offers the highest quality analog video output. (Digital HDMI provides the highest overall quality video output.)

LiteBoard™ Wand

The LiteBoard Wand works like a wireless mouse - but one that works in midair, not on your desktop. Just hold the wand in your hand, and point it at the projected image to point, click and drag. The wand works with all your software, just like a regular mouse.

Computer System Requirements and Connections

For the wand to work, a LiteBoard-compatible projector needs to be powered on and connected to your computer.

The LiteBoard Wand is compatible with any computer and operating system that supports a standard USB mouse (including Windows, Macintosh, and Linux). To set up your computer with the wand, make sure a USB cable is connected between your projector's DisplayLink connector and a USB computer.

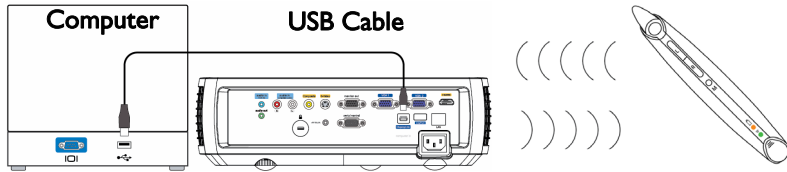

IMPORTANT: If you aren't using DisplayLink to project, you must also connect the computer's display output to the projector using a VGA or HDMI cable.

Charging the Wand's Battery

When the wand's amber battery light starts to blink, its internal battery is low (if the battery is fully discharged, you won't be able to turn the wand on by pressing its tip, L or R buttons).

To charge the battery, open the flap at the rear of the wand to expose the wand's USB connector. Then connect a USB cable between the wand and the USB power adapter, or a computer (if connecting to a computer, make

sure the computer is powered on). The battery light will stay on while the battery is charging, then it will turn off when the battery is fully charged.

When charging is finished, you can disconnect the USB cable (or keep the cable connected and use the wand while it's charging).

NOTE: 5-10 minutes of charging is enough for about an hour of wand use. A full charge will take 6-8 hours and will allow 20-40 hours of non-stop wand use.

Caution: The lithium battery is only rechargeable, and is not user serviceable or user replaceable.

Caution: Always use the included USB cable and power adapter (or your computer) to charge the wand.

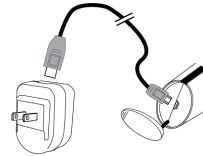

How to Use the Wand

Follow these steps to use the wand:

- 1 Connect the projector and your computer with a USB cable (see *Computer System Requirements and Connections* above).
- 2 Make sure the wand's battery is charged or charging (see *Charging the Wand's Battery* above).
- 3 Turn on the projector and make sure it's displaying the computer's screen - set the source to DisplayLink, VGA 1, VGA 2, or HDMI (press the source button on the projector or its remote if needed - you may need to press it several times).
- 4 Turn on the wand by pressing its tip, L, or R button - the wand's green Link light will start to blink.
- 5 Point the wand at the screen to point, click, and drag - just like a normal mouse.

NOTE: See LiteBoard Wand Menu below for settings that let you fine-tune wand motion and clicking behavior. When you're done, set the wand aside and make sure it isn't pointing at the screen; it will turn itself off automatically after 1 minute.

If you have problems, see Troubleshooting (below).

Wand Position and Avoiding Shadows

Your Location Distance from the Screen

You can use the LiteBoard Wand right up against the screen, or around the room. You might find that your pointing accuracy will improve if you get closer to the screen. Also, avoid standing too far off from either side of the screen.

Avoid Shadows!

The wand won't work if its tip is in a shadow or if it is pointing at a shadow:

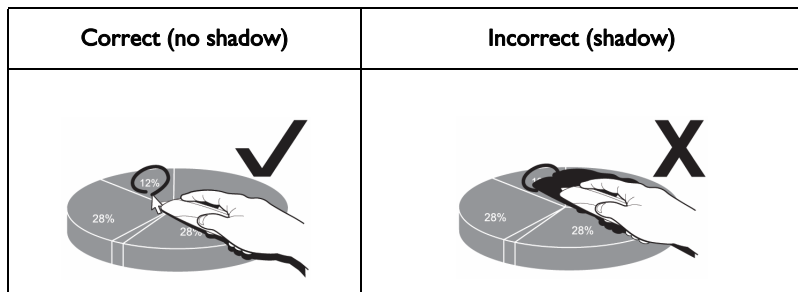

How to Hold the Wand

You can hold the wand the way you would hold a normal pencil or pen, or you can hold it like a remote control - use in whichever position is most comfortable. **NOTES:** If the wand is up close to the screen, you can press it against the projection surface to click and drag. Not recommended for use with fabric screens.

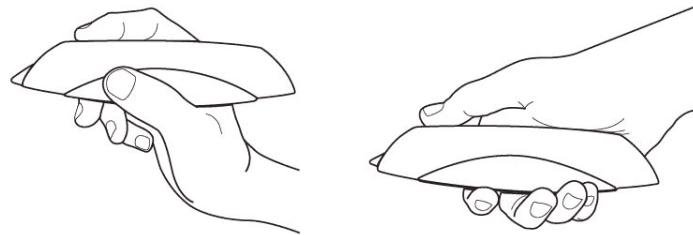

Using More than One Wand

The projector can work with more than one wand, but you can only use one wand at a time. When you want to switch to a different wand:

- 1 Point the current wand away from the projected image for at least 3 seconds.
- 2 Press the tip, L, or R button on the new wand to turn it on, and then start using the new wand.

NOTE: Settings in the projector's LiteBoard Wand menu (see below) apply to all wands used with that projector.

Wand Features

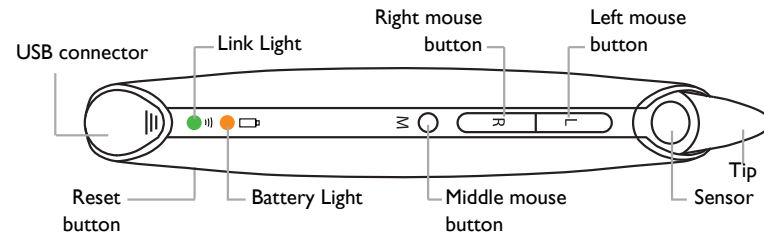

Buttons and Wand Tip

The wand's three top buttons are equivalent to the left (labeled 'L'), right (labeled 'R'), and middle (labeled 'M') buttons on a mouse. The wand's tip is also a button, and it's also equivalent to the left mouse button. **NOTE:** By default, the M button changes wand motion between Normal and Draw. Normal makes clicking easier, but Draw allows smoother motion. You can change the M button to perform other functions, including a standard middle button mouse click (see LiteBoard Wand Menu below).

Battery Light

The amber battery light shows the status of the wand's built-in battery (see below for battery information). The battery light will turn on while the wand is charging, and it will blink if the battery is low (2-4 hours of wand use left).

Link Light

The green link light shows the status of the wand's wireless connection to the projector. The link light will blink frequently (more than once per second) when the wand is attempting to link to the projector; then it will blink less frequently (about once every 4 seconds) after the wand has linked to the projector. **NOTE:** The link light will stay off when the wand is off.

USB Connector

The wand's USB connector is behind a flap on the back of the wand. The USB connector is only used for charging the wand's battery - using the included USB power adapter, or a computer. **NOTE:** You can use the wand while charging the battery, but after the battery is charged (battery light turns off), you can unplug the USB cable and continue to use the wand without a cable.

Sensor

The wand's optical sensor opening is located above the wand's tip. Don't block the sensor, and make sure it always has a clear view of the screen. **NOTE:** The sensor won't work if you point it at a shadow or away from the screen.

Reset Button

The wand has a reset button, behind a small hole on its underside. Under normal conditions, you should not need to reset the wand. See the Troubleshooting section below for more information.

Internal Radio

The wand has a built-in wireless transmitter/receiver which it uses to communicate with the projector.

Lithium Battery Information

Manufacturer: KAYO Battery (ShenZhen) Co., Ltd.

Model: ICR14430

Rating: 3.6VDC/650mAh

Caution: Lithium battery is only rechargeable, and not user replaceable. Not user serviceable.

LiteBoard Wand Menu

You can access the LiteBoard Wand menu from the projector's Setup menu. To change the settings in this menu, highlight a setting, then press Select (on the projector or its remote) one or more times - each press of Select will change to the next value for the setting.

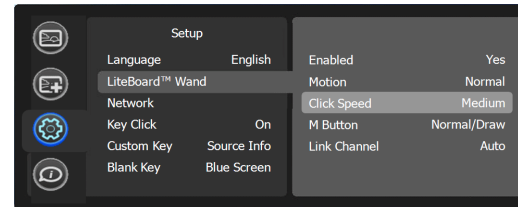

Enabled: controls whether the projector lets you use LiteBoard Wands. Set this to **Yes** to allow wand use. Set this to **No** to prevent wand use.

Motion: controls wand motion. When set to Normal, motion is set up to work best for normal computer use. When set to Draw, motion is set up to work best for on-screen drawing. When set to Stable, motion is filtered for maximum stability. When set to Press to Move, the mouse pointer only moves when you hold down the wand's tip or the L button on the wand (use the R button to click).

Click Speed: controls the motion pause when you click; only applies if Motion is Normal. Longer click speeds will make it easier to double-click, but will increase the delay before motion resumes after you click.

M Button: selects the function of the wand's M Button. You can use the M button to change wand motion, or perform keyboard or mouse button shortcuts. **NOTE:** The **PwrPnt Annotate** setting sets up the M button to control drawing (annotating) during Microsoft PowerPoint slide shows. The first press of the M button will turn on the drawing function, the next press will turn off the drawing function, the next press will turn it on again, etc.

Link Channel: selects the radio channel used for wand communication. This should be set to **Auto** unless you encounter interference (see Troubleshooting below for more information).

Troubleshooting LiteBoard

For the most up-to-date information, visit our support site at www.infocus.com/support

- If the wand doesn't work at all, or it works intermittently, try one of these solutions:
 - Press to Move may be enabled; try holding down one of the wand's buttons while moving the wand.
 - Press the tip, L, or R button on the wand to turn it on.
 - If the wand's green Link light never blinks, then the wand's battery is fully discharged; connect the wand to the USB power adapter or your computer.

- Make sure the wand is not pointing at a shadow and make sure its tip is not in a shadow.
- If the room is brightly lit, reduce the room illumination.
- If you're trying to use the computer's mouse at the same time as the wand, point the wand away from the screen while using the mouse.
- If someone else is using a different wand with the same projector, they must stop using it before you can use another wand.
- Change the Link Channel value in the LiteBoard Wand menu.
- Reset the wand: push the end of a paper clip into the reset opening on the underside of the wand.

- If accurate clicking is difficult, try one of these solutions:
 - Hold the wand steadier when clicking.
 - Use the wand right up against the screen so it's easier to avoid unexpected movements.
 - Change the Motion value in the LiteBoard Wand menu.
- If it is difficult to draw or move freely because the wand wants to move in straight lines or draw extra lines, try changing the Motion value in the LiteBoard Wand menu.
- If the mouse pointer is in the wrong place on the screen, or the mouse pointer's movement is restricted to only part of the screen, try one of these solutions:
 - Make sure your projector is displaying the computer's screen and not some other source (such as DVD, VCR, etc.). To change the source, press the Source button on the projector or its remote.
 - Make sure the projector is displaying the same image as the computer's main or built-in monitor (don't extend your desktop onto multiple monitors). To correct this:
 - On Windows XP:* Open the Display control panel, click Settings, click the display that represents the projector, then un-check "Extend my Windows desktop...".
 - On Windows Vista:* Right-click on the desktop, choose Personalize..., click Display Settings, click the display that represents the projector, then un-check "Extend the desktop..."

On Macintosh: Select System Preferences from the Apple Menu, then select Displays. Click Arrangement, and check “Mirror Displays.”

- If the battery light does not turn on when the wand is being charged, try one of the following:
 - Make sure a USB cable is connected between the wand and either the USB power adapter, or a USB port on your computer.
 - If the wand is connected to the USB power adapter, make sure the adapter is plugged in to a live electrical outlet. If the wand is connected to your computer, make sure the computer is powered on.
 - If the wand still won't charge, contact InFocus support at www.infocus.com/support.
- If DisplayLink Manager setup always starts when USB cable is connected, but you don't want to use DisplayLink projection, you can disable DisplayLink: Go into the projector's Setup menu and turn off the DisplayLink Source setting. **NOTE:** This does not disable the DisplayLink connector; it only disables being able to project over DisplayLink.

Shutting down the projector

The projector automatically displays a black screen after no active source is detected for 30 minutes. This black screen helps preserve the life of the projector. The image returns when an active source is detected or a remote or keypad button is pressed.

Screen Save Time

You can make the black screen appear after a preset number of minutes by turning on the Screen Save Time feature in the Setup menu (on page 34).

Auto Off Time

The projector also has an Auto Off Time feature that automatically turns the projector off after no active sources are detected and no user interaction with the projector is performed for 30 minutes. By default, this feature is off. You can also change the length of time (on page 34).

Turning off the projector

To turn the projector off, press the **Power** button on the remote or keypad. The lamp turns off and the LED blinks amber for 1 minute while the fans continue to run to cool the lamp. When the lamp has cooled, the LED lights amber and the fans stop. Unplug the power cable to completely power off the projector.

Troubleshooting your setup

If your image appears correctly on the screen, skip to the next section. If it does not, troubleshoot the setup.

The Status Indicator Panel on top of the projector indicates the state of the projector and can help you troubleshoot.

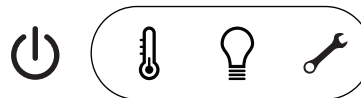



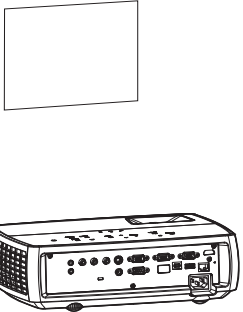
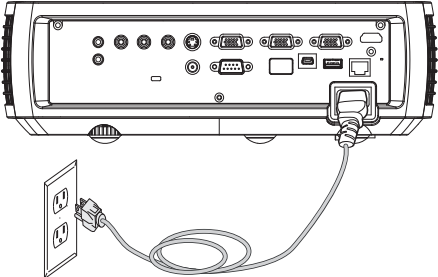
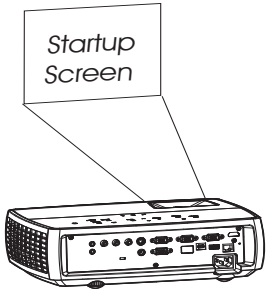
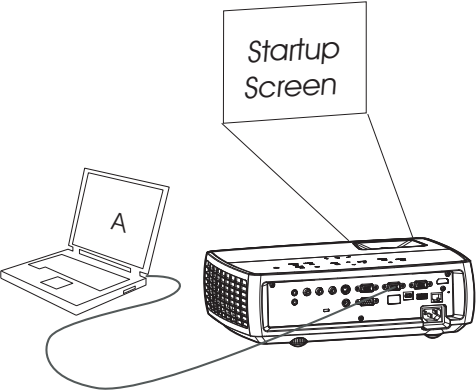

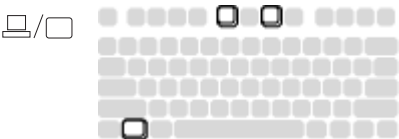
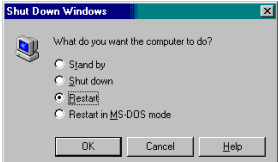
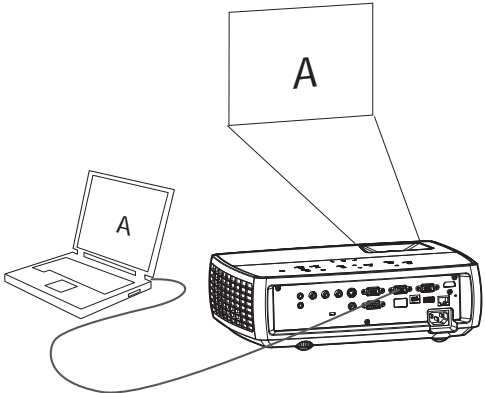

Table 3: Status indicator light behavior and meaning

Icon	Meaning
Power, solid amber 	The projector is plugged in.
Power, blinking green	The power button has been pressed and the software is initializing.
Power, solid green	The projector is on and initialized.
Power, blinking amber	The power button has been pressed to turn the projector off and the fans are running to cool the projector.
Temperature 	The projector is too hot. Make sure the vents aren't blocked (on page 24). Turn off the projector and wait one minute, then turn the projector on again. Contact Technical Support if the problem persists. Visit www.infocus.com/support to contact service.
Lamp 	Turn off the projector and wait one minute, then turn the projector on again. If the lamp light turns on again, replace the lamp and reset the lamp timer.
Wrench/Service 	Turn off the projector and wait one minute, then turn the projector on again. If the service lamp turns on again, service is required. Visit www.infocus.com/support to contact service.

Problem	Solution	Result
<p data-bbox="53 115 244 138">No start up screen</p> 	<p data-bbox="666 115 1117 167">Plug power cord into the projector and press power button.</p> 	<p data-bbox="1189 115 1334 138">Correct image</p> 
<p data-bbox="53 489 340 512">Only start up screen appears</p> 	<p data-bbox="666 477 1152 540">If your computer is using the projector's DisplayLink connector, see the DisplayLink Software's User's Guide for troubleshooting information.</p> <p data-bbox="666 569 944 615">Press the Source button  activate laptop's external port</p>  <p data-bbox="683 821 817 844">Restart laptop</p> 	<p data-bbox="1189 483 1459 506">Computer image projected</p> 

Problem

No computer image, just the words "Signal out of range"

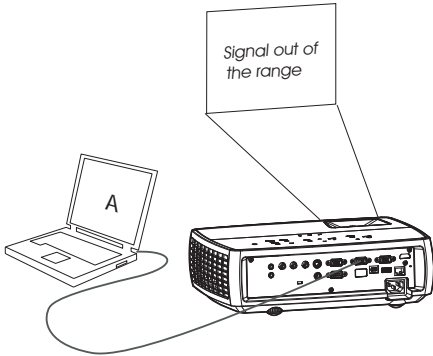

Solution

Press the Auto Image Button on keypad. Adjust computer refresh rate in Control Panel > Display > Settings > Advanced > Adapter (location varies by operating system)

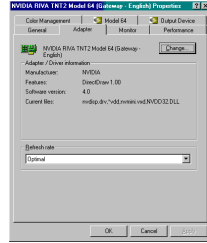

You may also need to set a different resolution on your computer, as shown in the following problem, "image fuzzy or cropped"

Result

Computer image projected

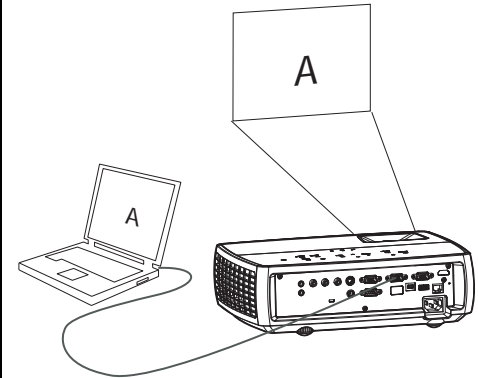

Only my laptop's background appears, not the Desktop icons

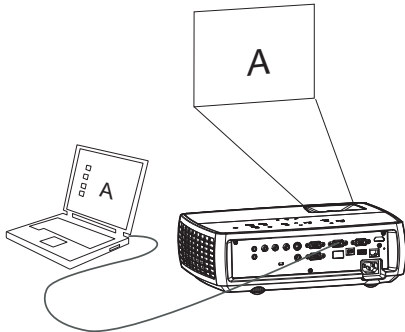



DisplayLink - Use DisplayLink software to change the display mode from Extended Desktop to Duplicated Desktop. Windows - Disable "Extend my Windows Desktop" in Control Panel > Display > Settings > Display 2 (location varies by operating system)

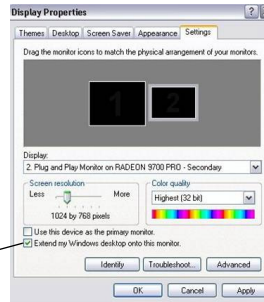

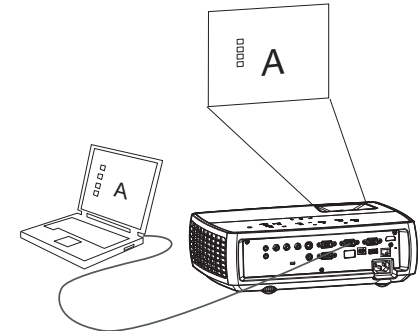

Uncheck this option, then click Apply

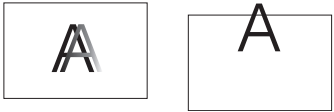
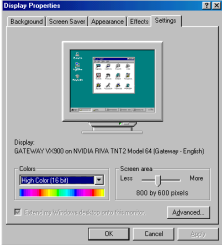

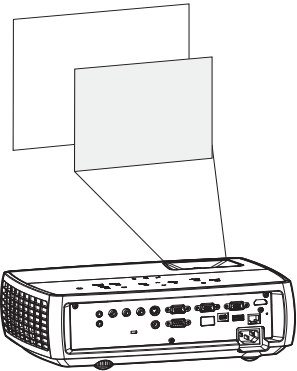
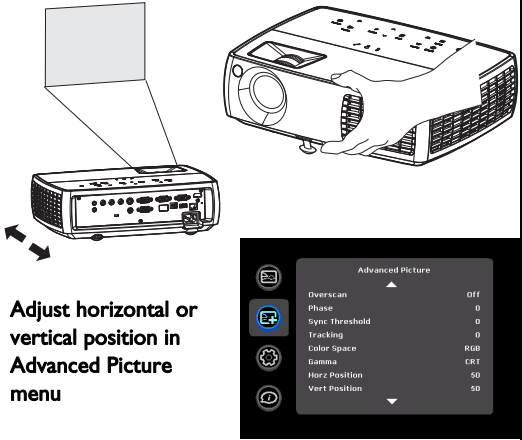
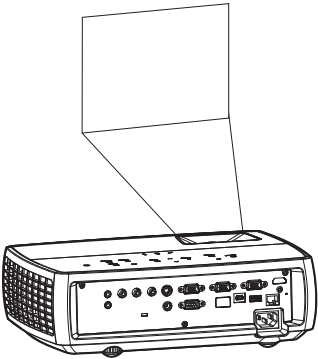

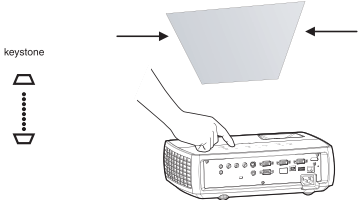

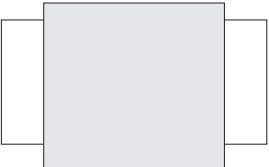
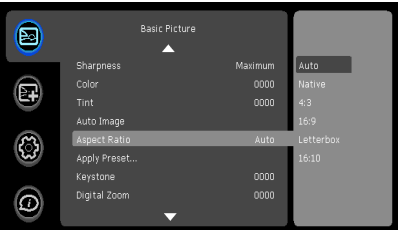
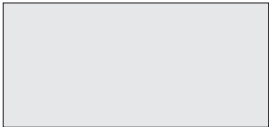

Background and Desktop projected

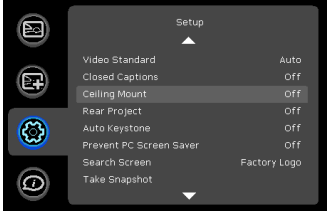

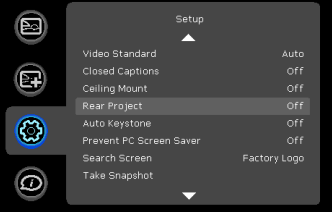
Problem	Solution	Result																											
<p data-bbox="48 89 284 115">Image fuzzy or cropped</p> 	<p data-bbox="604 89 1142 173">Set your computer's display resolution to the native resolution of the projector (Start > Settings > Control Panel > Display > Settings tab)</p> <p data-bbox="656 313 817 445">For a laptop, disable laptop monitor or turn-on dual-display mode</p> 	<p data-bbox="1182 89 1465 115">Image clear and not cropped</p> 																											
<p data-bbox="48 540 348 567">Image not centered on screen</p> 	<p data-bbox="604 540 1025 567">Move projector, adjust zoom, adjust height</p>  <p data-bbox="656 873 847 976">Adjust horizontal or vertical position in Advanced Picture menu</p> <table border="1" data-bbox="887 812 1142 1014"> <thead> <tr> <th colspan="3">Advanced Picture</th> </tr> </thead> <tbody> <tr> <td>OverScan</td> <td>▲</td> <td>Off</td> </tr> <tr> <td>Phase</td> <td></td> <td>0</td> </tr> <tr> <td>Sync Threshold</td> <td></td> <td>0</td> </tr> <tr> <td>Tracking</td> <td></td> <td>0</td> </tr> <tr> <td>Color Space</td> <td></td> <td>RGB</td> </tr> <tr> <td>Gamma</td> <td></td> <td>CRT</td> </tr> <tr> <td>Horz Position</td> <td></td> <td>50</td> </tr> <tr> <td>Vert Position</td> <td></td> <td>50</td> </tr> </tbody> </table>	Advanced Picture			OverScan	▲	Off	Phase		0	Sync Threshold		0	Tracking		0	Color Space		RGB	Gamma		CRT	Horz Position		50	Vert Position		50	<p data-bbox="1182 540 1326 567">Correct image</p> 
Advanced Picture																													
OverScan	▲	Off																											
Phase		0																											
Sync Threshold		0																											
Tracking		0																											
Color Space		RGB																											
Gamma		CRT																											
Horz Position		50																											
Vert Position		50																											

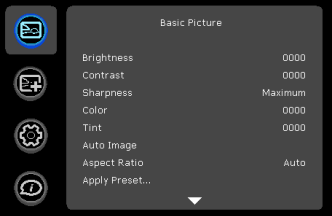
Problem	Solution	Result
<p data-bbox="48 89 225 114">Image not square</p> 	<p data-bbox="604 89 876 114">Adjust Keystone on keypad</p> 	<p data-bbox="1182 89 1315 114">Square image</p> 
<p data-bbox="48 339 211 365">Image not sharp</p> 	<p data-bbox="604 339 1032 365">Adjust Sharpness in the Basic Picture menu</p> 	<p data-bbox="1182 339 1328 365">Correct image</p> 
<p data-bbox="48 615 416 640">Image does not fit 4:3 or 16:9 screen</p> 	<p data-bbox="604 615 1024 665">Change aspect ratio to 4:3 or 16:9 in Basic Picture>Aspect ratio menu</p> 	<p data-bbox="1182 615 1328 640">Correct image</p> 

Problem	Solution	Result
<p>Image upside down</p> 	<p>Turn off Ceiling Mount in Setup menu</p> 	<p>Correct image</p> 
<p>Image reversed left to right</p> 	<p>Turn off Rear Project in Setup menu</p> 	<p>Correct image</p> 
<p>Projected colors don't match source</p> 	<p>Adjust color, tint, brightness, contrast in the Basic Picture menu</p> 	<p>Correct image</p> 

Problem

The video embedded in my PowerPoint presentation does not play on the screen

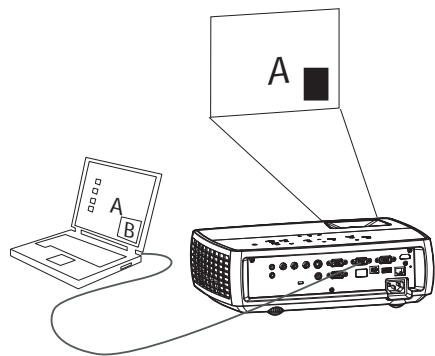

Solution

If your computer is using the projector's DisplayLink connector, see the DisplayLink User's Guide for video troubleshooting information.
Turn off the internal LCD display on your laptop

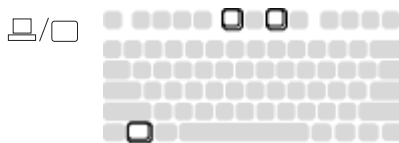

Result

Embedded video plays correctly

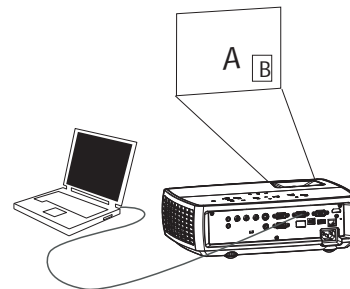

Lamp won't turn on, Temperature light is on



Temperature light

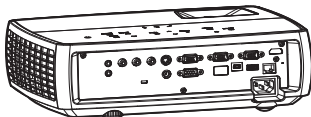
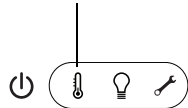

Make sure vents aren't blocked, turn off the projector and allow it to cool for one minute

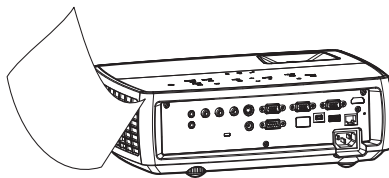

Lamp turns on

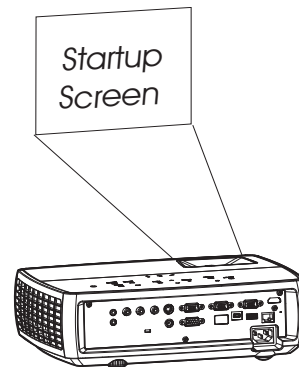

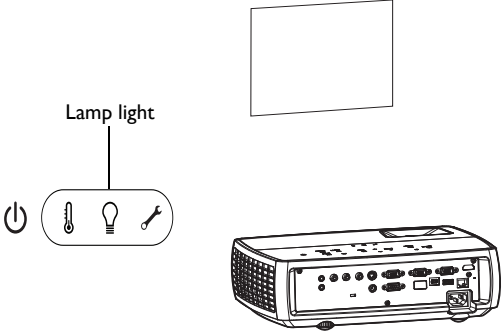
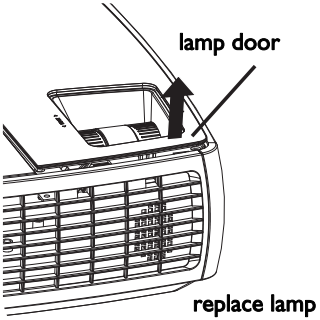
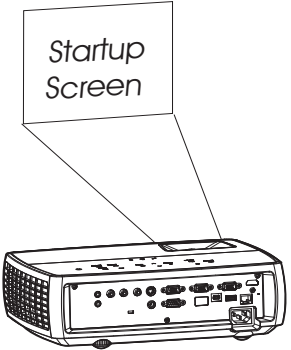
Problem	Solution	Result
<p data-bbox="48 101 531 156">“Replace lamp” message appears at startup, lamp won’t turn on, Lamp light is turned on</p> 	<p data-bbox="604 112 965 138">Lamp must be replaced (on page 46)</p> 	<p data-bbox="1182 92 1329 119">Lamp turns on</p> 

Still need assistance?

If you need assistance, visit our website at www.infocus.com/service or call us. Check out our HOW TO section there for additional information on using this projector for home theater or gaming applications. See the Quick Start Poster/Booklet for support contact information.

This product is backed by a limited warranty. An extended warranty plan may be purchased from your dealer. When sending the projector in for repair, we recommend shipping the unit in its original packing material, or having a professional packaging company pack the unit. Please insure your shipment for its full value.

Using the remote control

The remote uses two (2) provided AA batteries. They are easily installed by removing the cover from the remote's back, aligning the + and - ends of the batteries, sliding them into place, and then replacing the cover.

Caution:

- When replacing the batteries, be aware that using batteries other than the type provided with the projector may risk severe damage to the remote.
- When disposing of the batteries, be sure to do so in an environmentally proper manner.
- If the remote control gets wet, wipe it dry immediately.
- Avoid excessive heat and humidity.
- Ensure the batteries' polarity (+/-) is aligned correctly.
- Do not mix new and old batteries together, or mix different types of batteries together.
- Replace the batteries as soon as they run out.
- Remove batteries from the remote control when storing or not in use for a prolonged period.

The remote also has:

- **Volume** buttons to adjust the sound.
- **Custom** button that can be assigned to a special function, like Blank Screen or Freeze (on page 34).
- **Source** button to switch between sources.
- **Blank** button to blank the screen.
- **Presets** button to select stored settings (on page 32).
- **Mute** button to silence the audio.
- **Auto Image** button to resynch the projector to the source.
- **Resize** button to switch among aspect ratios (on page 32).

Troubleshooting the remote

- Make sure the batteries are installed in the proper orientation and are not dead.
- Make sure you're pointing the remote at the projector or the screen, not the computer, and are within the remote range of 15 feet (4.5m). For best results, point the remote at the projector.

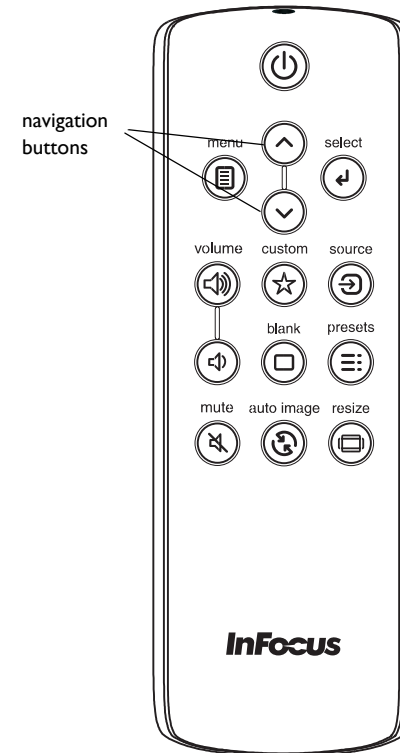

Using the audio

Using the projector's speakers

When the computer is using the DisplayLink or HDMI connector, both audio and video are sent over the cable to the projector and audio will play from the projector's speakers.

For inputs other than DisplayLink and HDMI, to use the projector's speakers, connect the audio source to the Audio In Computer or Video connectors.

To adjust the volume, press the **Volume** buttons on the keypad or remote.

Troubleshooting Audio

If you aren't hearing the audio, check the following:

- If your computer is using the projector's DisplayLink or HDMI connector, see the InFocus DisplayLink Software User's Guide on the website at www.infocus.com/displaylink for audio troubleshooting information.
- Make sure the audio cable is connected to the correct Audio In connector, Computer or Video.
- Make sure the volume is turned up enough. Press the **Volume** button on the keypad or remote.
- Make sure you are connected to the corresponding audio in for your source. By default, audio in VGA 1/2 corresponds to VGA 1, VGA 2 and LitePort, audio in composite s-video corresponds to S-video and Composite. You can change these assignments (on page 35).
- Make sure that you are connected to an audio out connector on the source as opposed to a line-in or microphone connector.
- Adjust the audio source.
- If playing a video, make sure the playback has not been paused.

Connecting external speakers

The projector can be attached to external amplified speakers by connecting a 3.5mm stereo audio cable from the **Audio Out** connector on the projector to the amplified speakers. Alternatively, you can bypass the projector's audio system and connect the audio directly from your source to a stereo or home theater system.

NOTE: DisplayLink and HDMI audio are passed to the Audio Out connector.

connect audio cable

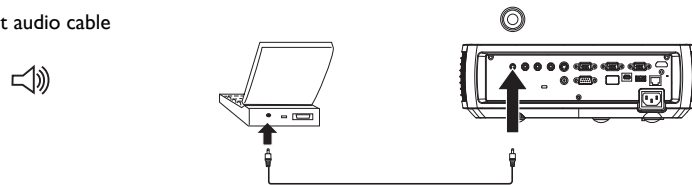

adjust volume

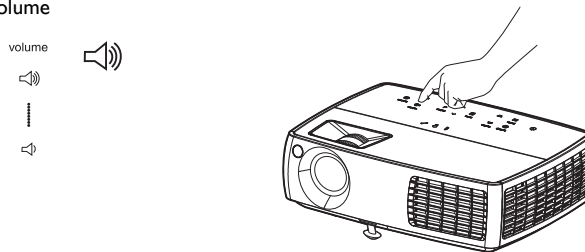

external speakers with own power source

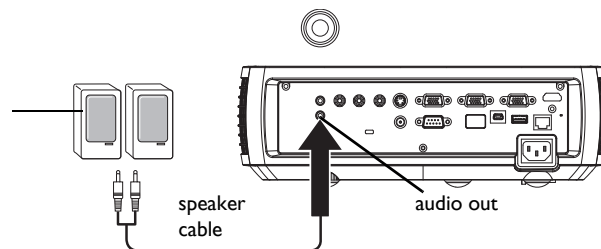

Using the keypad buttons

Most buttons are described in detail in other sections, but here is an overview of their functions:

Power—turns the projector on and off (on on page 9).

Auto Image—resets the projector to the source.

Presets—cycles through the available preset settings (on page 32).

Keystone—adjusts squareness of the image (on page 10).

Menu—opens the on-screen menus (on page 31).

Select—confirms choices made in the menus (on page 31).

Up/Down arrows—navigates to and adjusts settings in the menus (on page 31).

Volume—adjusts sound (on page 27).

Source—changes the active source.

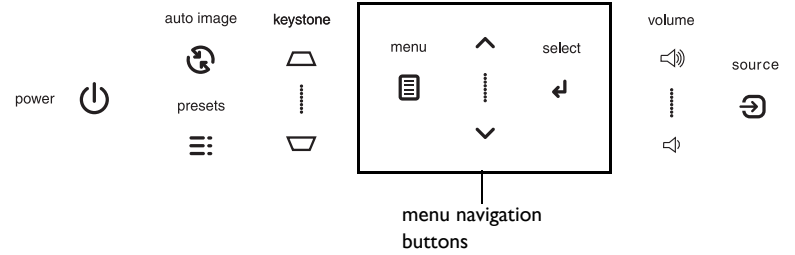

Optimizing computer images

After the projector is running and the image is on the screen, you can optimize the image using the onscreen menus. For general information on using the menus (on page 31).

- Adjust the Keystone, Contrast, or Brightness in the Basic Picture menu (on page 32).
- Change the Aspect Ratio. Choose the option that best fits your input source (on page 32).
- Adjust the Color Temperature in the Advanced Picture menu (on page 33).
- Adjust the Phase, Tracking, or Horizontal or Vertical position in the Advanced Picture menu (on page 33).
- Once you have optimized the image for a particular source, you can save the settings using Presets. This allows you to quickly recall these settings later (on page 32).
- If your computer is using the projector's DisplayLink connector, see the InFocus DisplayLink Software User's Guide for information about optimizing images.

NOTE: To achieve maximum contrast, you can disable LiteBoard Wand use. To do this, set Enabled to No in the LiteBoard Wand submenu in the Setup menu (on page 15).

Presentation features

Several features are provided to make giving presentations easier. Here is an overview, details are found in the menu section.

- The Custom key allows you to assign various features to the button. The default effect is Source Info, which displays information about the projector and current source (on page 34).
- The Search Screen option lets you change the appearance of the blank screen and start up screen (on page 35).
- Two options, Auto Off and Screen Save Time, are provided to automatically shut down the projector after several minutes of inactivity or display a black screen. This helps preserve lamp life (on page 34).

Optimizing video images

After your video device is connected properly and the image is on the screen, you can optimize the image using the onscreen menus. For general information on using the menus (on page 31).

- Adjust the Keystone, Contrast, Brightness, Color, or Tint in the Basic Picture menu (on page 32).
- Change the Aspect Ratio. Choose the option that best fits your input source (on page 32).
- Select a Sharpness setting (on page 32).
- Adjust the Color Temperature. Select a listed warmth value (on page 33).
- Turn on Overscan to remove noise on the edges of the image (on page 33).

NOTE: To achieve maximum contrast, you can disable LiteBoard Wand use. To do this, set Enabled to No in the LiteBoard Wand submenu in the Setup menu (on page 15).

Customizing the projector

You can customize the projector for your specific setup and needs (on page 34 and on page 35).

- For rear projection, turn Rear Project on in the **Setup** menu.
- For ceiling mounted projection, turn Ceiling Mount on in the **Setup** menu.
- Specify which source the projector checks first for active video during power-up.
- Specify the function of the Custom key on the remote.
- Turn the projector's display messages on and off.
- Turn on power saving features.
- Specify appearance of blank screen and startup screen.
- Specify the language viewed on the menus.
- Save settings for the active source as a preset.

Dynamic Messaging

Using command codes, text messages can be sent for display by the projector over a network or serial connection. Text is shown on top of whatever else is being displayed, and can be shown in ticker tape format or in a box, with optional beep tone alert. This is a great way to display urgent alert messages to employees, and simply requires a connection to the projector's RS-232 serial control or LAN connector. Command codes for executing Dynamic Messaging are available on our website at www.infocus.com/support.

Using the menus

To open the menus, press the **Menu** button on the keypad or remote. (The menus automatically close after 60 seconds if no buttons are pressed.) Use the arrow buttons to move up and down to highlight the desired menu, then press the **Select** button.

To change a menu setting, highlight it, press **Select**, then use the up and down arrow buttons to adjust the value or select an option or turn the feature on or off. Press **Select** to confirm your changes. Use the arrows to navigate to another setting. When your adjustments are complete, press **Menu** to access a different menu; press the **Menu** button at any time to navigate to the higher-level menu and ultimately close the menus.

The menus are grouped by usage:

- The Basic Picture menu provides common image adjustments.
- The Advanced Picture menu provides more complex image adjustments.
- The Setup menu provides set-up type adjustments that are not changed often.
- The Status and Service menu provides information about the projector and source.

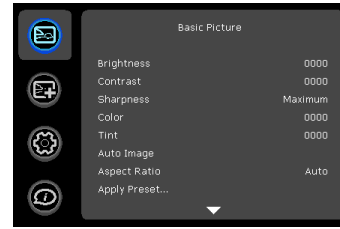
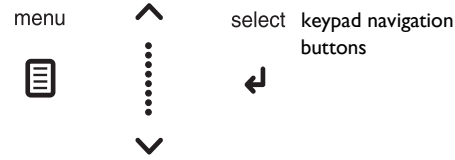

Basic Picture menu

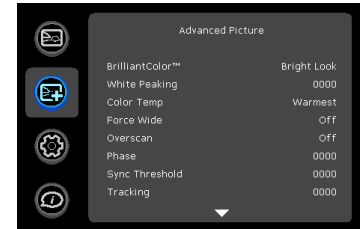

Advanced Picture menu

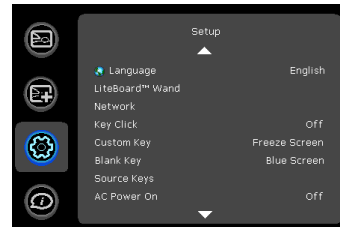

Setup menu

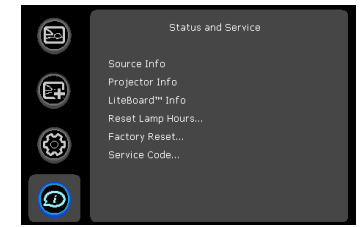

Status and Service menu

Basic Picture menu

To adjust the following settings, highlight the setting, press **Select**, use the up and down arrows to adjust the values, then press **Select** to confirm the changes.

Brightness: changes the intensity of the image.

Contrast: controls the degree of difference between the lightest and darkest parts of the picture and changes the amount of black and white in the image.

Sharpness: changes the clarity of the edges of a video image. Select a sharpness setting.

Color: adjusts a video image from black and white to fully saturated color. The color setting applies to video sources only.

Tint: adjusts the red-green color balance in the image of NTSC video images. The tint setting applies to NTSC video sources only.

Aspect Ratio: Aspect ratio is the ratio of the image width to image height. TV screens are usually 4:3. HDTV and most DVDs are 16:9.

Select Auto to have the projector choose the ratio. Choose Native to see the unmodified input with no resizing by the projector. Select 16:9 to watch enhanced widescreen DVDs.

More Aspect Ratio information is available on page 11.

Apply Preset...: Presets are provided that optimize the projector for displaying computer presentations and video images under certain conditions.

There is also a user-definable preset. To set this preset, adjust the image and select Save User in the Presets menu. You can recall these settings in the future by selecting the User preset.

Keystone: adjusts the image vertically and makes a squarer image. You can also adjust keystone from the keypad.

Digital Zoom: changes the size of projector's display area. If the display area has been resized by this setting, it can be moved by changing the **Horz Shift** and **Vert Shift** settings.

Horz Shift/Vert Shift: moves the display area horizontally or vertically if its size has been changed by the **Digital Zoom** setting.

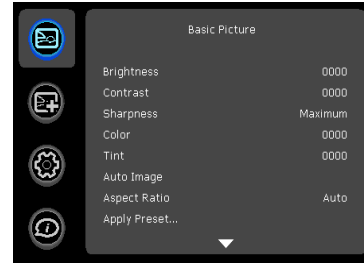

Basic Picture menu

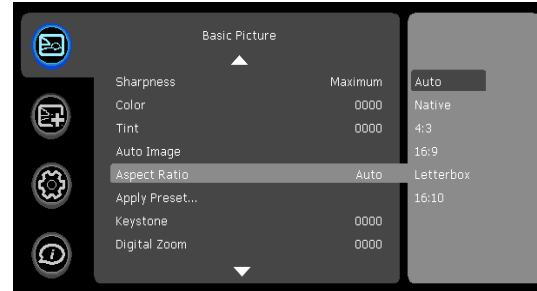

Aspect ratio

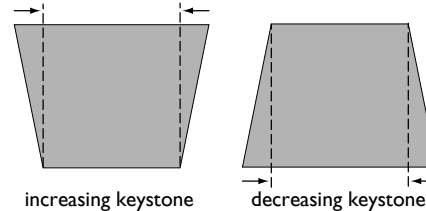

Advanced Picture menu

BrilliantColor™ : produces an expanded on-screen color spectrum that delivers enhanced color saturation for bright, true-to-life images. Choose Normal Look for most video sources and Bright Look for most computer sources.

White Peaking: increases the brightness of whites that are near 100%.

Color Temperature: changes the intensity of the colors. Select a listed relative warmth value.

Force wide: when this is off, the analog locking algorithms choose the standard mode resolution (4:3) as the preferred default resolution. When this is on, the analog locking algorithms choose wide mode resolution (16:10) as the preferred default resolution.

Overscan: removes noise around the video image.

Phase: adjusts the horizontal phase of a computer source.

Sync Threshold: (progressive signals only) If a hardware device, such as a DVD player, is not syncing properly with the projector, select this option to help it to sync when connected to the projector.

Tracking: adjusts the vertical scan of a computer source.

Color Space: applies to computer and component video sources. It allows you to select a color space that has been specifically tuned for the input signal. When Auto is selected, the projector automatically determines the standard. To choose a different setting, turn off Auto, then choose RGB for computer sources or choose either REC709 or REC601 for component video sources.

Gamma: select the appropriate gamma from among Video, Film, Bright, and CRT.

Color Gamut: sets the color gamut of the input signal.

Color Gain: adjusts the gain of the red, green or blue channel of the image.

Color Offset: adjusts the offset of the red, green or blue channel of the image.

Horizontal/Vertical Position: adjusts the position of a computer source.

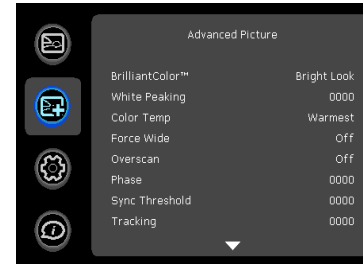

Advanced Picture menu

Setup menu

Language: allows you to select a language for the onscreen display.

LiteBoard Wand: allows you to control the operation of the LiteBoard Wand (on page 13).

Network: allows you to setup network settings. See page 38 for details on network configuration and operation.

- **DHCP:** turns the DHCP on or off.
- **IP Address:** assign Network IP Address.
- **Subnet Mask:** assign Network Subnet Mask.
- **Default Gateway:** assign Network Default Gateway.
- **WINS Host Name Lookup:** turns WINS Host Name Lookup on or off.
- **Host Name:** displays the host name.
- **MAC Address:** displays network MAC Address value.
- **Show Network Messages:** turns network messages on or off. Network messages display the projector's IP address (and host name if enabled) when the projector is also displaying source messages.
- **Restart Network...:** restarts the network.
- **Network Factory Reset...:** performs factory reset.

Key Click: turns the key click sound on or off. When this setting is on, pressing keys on the keypad causes the projector's speaker to play a "click" sound.

Custom Key: allows you to assign a different function to the Custom button, allowing you to quickly and easily use the effect. Highlight an effect and press **Select** to choose a different one.

- **Source Info:** the default action. Shows the Source Info menu.
- **Projector Info:** shows the Projector Info menu.
- **Aspect Ratio:** toggles among 4:3, 16:9, and Native (on page 11 and on page 32).
- **Auto Image:** resets the projector to the source (on page 28).
- **Overscan:** removes noise around the image.

- **Blank Screen:** displays an empty screen.
- **Freeze Screen:** pauses the projected image.
- **Mute:** turns off all sound.
- **AV Mute:** enables or disables AV Mute function.
- **Source:** cycles through available sources.
- **Closed Captions:** enables or disables Closed Captions.

Blank Key: select what to display when the blank key on the remote is pressed: your custom snapshot, a solid color screen (blue, black or white), the factory logo screen, a timer, or test patterns. The timer option is useful for classroom tests or break times during meetings.

Source Key Enable: enables or disables Source Keys on the optional Commander-2 remote.

AC Power On: when this feature is on, the projector automatically turns on when electrical power is connected. This allows control of ceiling mounted projectors with a wall power switch.

Auto Off Time: automatically turns the projector off after no signals are detected for a preset number of minutes. If an active signal is received before the projector powers down, the image will be displayed.

Screen Save Time: automatically blanks the screen with a black color after no signals are detected for a preset number of minutes. The image returns when an active source is detected or a remote or keypad button is pressed.

Always-On Functions: allows you to control which projector functions will work even when the projector is in standby (powered off but connected to AC Power). Press Up or Down to highlight the function you want to change, then press select or left and right to change the function to either Yes or No. Press menu when done. Note that some functions must always have the same value; in this case when you change one value, other values in the submenu may also change automatically.

Lamp Low Power: toggles between on and off. Turn it on to lower the light output of the lamp. This also lowers the fan speed, making the projector quieter.

Power Sounds: controls whether the projector makes a sound when powered on and off.

Audio Inputs: assign an audio input to a specific video/computer source input. Press up or down to highlight the source you want to change, then press Select or the left and right arrow keys to change the source's audio input. Press **Menu** when done changing audio inputs.

Auto Source: when this feature is On, the projector automatically finds the active source, checking the selected Power-up Source first. When this feature is Off, the projector defaults to the source selected in Power-up Source. To display another source, you must manually select one by pressing the **Source** button on the remote or keypad.

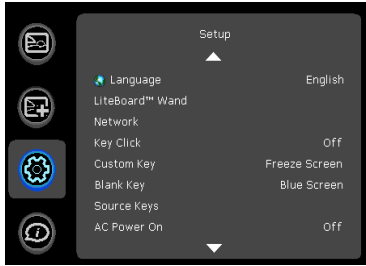

Setup menu

Power-up Source: determines which source the projector checks first for active video during power-up.

DisplayLink Source: allows you to disable DisplayLink (project over USB). When Off, you won't be prompted to install DisplayLink software when you connect the USB cable to your computer.

Video Standard: When this feature is set to Auto, the projector attempts to automatically pick the video standard based on the input signal it receives. (The video standard options may vary depending on your region of the world.) If the projector is unable to detect the correct standard, the colors may not look right or the image may appear "torn." If this happens, manually select a video standard by selecting NTSC, PAL, or SECAM from the Video Standard menu.

Closed Captions: controls closed caption display while audio is not muted. If this setting is not off, and audio is not muted, and the source is NTSC and

contains captions on the selected channel, then the projector must display caption text overlaid on the image.

Ceiling Mount: turns the image upside down for ceiling-mounted projection.

Rear Project: reverses the image so you can project from behind a translucent screen.

Auto Keystone: automatically adjusts vertical image.

Prevent PC Screen Saver: prevents your computer from going into Screen Save mode. The projector must be connected to the PC via a USB cable for this feature to work.

Search Screen: allows you to display a blank screen instead of the default screen at startup, and when no source is detected.

Take Snapshot...: captures the current image and allows it to be used as the search screen image.

Disable Snapshot: Allows the user to disable the snapshot capability.

Show Messages: displays status messages (such as "Searching") in the lower-left corner of the screen.

Menu Offset: allows you to change the position of the On Screen Display items.

Menu Transparency: allows you to change how much of the projected image behind the menu you can see. As the value increases, more of the image behind the menu is visible.

Magnify Controls: determines whether the select key can be used to change magnify settings when the OSD menu is not visible.

PIN Protect: The PIN (personal identification number) feature allows you to password protect your projector. Once you enable the PIN feature, you must enter the PIN before you can project an image. The default PIN on this projector is **Menu-Up-Down-Select-Source**. Use the navigation buttons on the remote or keypad to enter the correct 5-button press sequence. When all 5 numbers are entered correctly, press the **Select** button on the remote or keypad to select OK. If the message “Wrong PIN” appears, verify the code and re-enter it. If you mis-enter a number, you must enter 5 numbers and press the **Select** button in order to access the “Wrong PIN” message and re-enter the code.

To enter the PIN at projector startup:

Power up the projector. The “Enter PIN” dialog box appears after the startup screen. Enter the PIN. Use the navigation buttons on the remote or keypad to enter the correct button press sequence. See the description above for instructions.

To change the PIN:

Select “Change PIN...” in the Setup menu. Enter the existing PIN. Enter the new PIN. You can navigate between OK and Cancel by pressing the up and down buttons on the keypad. Select OK or Cancel by pressing the **Select** button. Verify the new PIN.

If you lose or forget your custom PIN:

Contact InFocus support. Go to www.infocus.com/support

VGA 2 SCART: selects SCART connection type between RGB and composite.

Serial Port, Baud Rate: selects the serial port and baud rate.

Serial Port Echo: controls whether the serial port echoes characters.

Status and Service menu

Source Info: a read-only display of current source settings.

Projector Info: a read-only display of current projector settings.

LiteBoard Info: a read-only display of current LiteBoard settings.

Reset Lamp Hours: resets the lamp hours used counter in the Projector Info menu to zero. Do this only after changing the lamp.

Factory Reset: restores all settings to their default.

Service Code: only used by authorized service personnel.



Status and Service menu

Using Network Functions

IMPORTANT: To enable network functions at all times (even when the projector is powered off), the Network item in the Always-On Functions submenu in the Setup menu must be set to Yes (not No).

Projector network functions include:

- Configuring and controlling the projector via a web browser.
- Failure and warning alerts via email.
- Projector Management via SNMP.
- Controlling the projector via Scheduling.

NOTE: Projector web pages and emails sent by the projector are always displayed in English language.

Before using the network functions

To use the network functions of the projector, the projector must be configured to suit your network. Consult with your network administrator before connecting the projector to your network; incorrect network configuration of the projector may cause problems on your network.

Connect the Network Cable

Properly connect projector to the network, then configure the following settings.

If Using a Network with DHCP Enabled:

- 3 Use the projector's remote control or keypad to select the Network item in the projector's Setup menu.
- 4 If DHCP is off, select it to turn it on.

If Using a Network that Does Not have DHCP Enabled:

- 1 Use the projector's remote control or keypad to select the Network item in the projector's Setup menu.
- 2 If DHCP is on, select it to turn it off.

NOTE: If you still do not see an IP address, go to the projector's Setup menu, select Network, then turn on Show Network Messages. After exiting the menu, press the Source button again.

- 3 Select IP Address. This will highlight the first of the four octets in the IP address. Press **Up** or **Down** to change the value, then press **Select** or Right when done to move to the next octet. Repeat until you have changed all four octets in the IP address.
- 4 Repeat the above for Subnet Mask, Default Gateway, and other settings that are in IP address format (to assign or change the Host Name, see **Network Settings Page** below).

Configuring and Controlling the Projector via a Web Browser

You can adjust or control the projector via a network from a web browser on a computer that is connected to the same network as the projector.

NOTES:

- To access the projector's web pages, the projector must be connected to the network and connected to AC power (and if you want to access the network even when the projector is powered off, make sure the Network item in the Always-On Functions submenu in the Setup menu is set to Yes).
- JavaScript must be enabled in your browser to use the projector web pages properly. If JavaScript is disabled, see the Help files for your web browser for details on how to enable it.
- If no operations are performed in the web browser for approximately ten minutes, the system will automatically log you off.

Logging in

To log into the projector web pages, follow these steps:

- 1 Make sure the projector is connected to the network and connected to AC power.
- 2 If you don't know the projector's IP address, turn on the projector. After the projector starts up, if its IP address is not shown, press the **Source** button to view the IP address.

IP Address: 192.168.1.10

- 3 Start a web browser on your computer.
- 4 Enter the projector's IP address or host name (preceded by http://) into the web browser's address bar. Example: If the IP address is 192.168.1.10, enter http://192.168.1.10 into the browser's address bar.
- 5 The Log In to Projector Control page will be shown in the browser.
- 6 Select Access type: **Basic User** or **Administrator**.
- 7 Click **Log In**.

Navigating Projector Web Pages

The left side of every page shows a navigation bar. Click the links in the navigation bar to go to different projector web pages.

NOTE: If a Basic User is logged in, no links are shown.

The top of the navigation bar shows the projector name, model, and serial number.

The web pages also include the following options:

- **Log Off:** Logs off and returns to the Log In page (see above).
- **Refresh:** Reloads the page with current status.
- **Defaults:** Displays default (factory settings) values (to save these values click Apply).
- **Apply:** Saves the values that are currently shown on the page.

Projector Controls Page (All users)

This page lets you control the same settings that are available via the projector's main menu and remote control. The Controls tab includes basic remote control functions; other tabs correspond to the projector's menus.

NOTE: If a Basic User is logged in, only the Controls, Basic Picture, and Advanced Picture tabs are shown.

In each tab, the current value of each setting is shown in blue color.

NOTE: Unlike other pages, changes you make to Projector Control settings are applied immediately.

- **To change an on/off setting** (e.g. Power): Click the corresponding **On** or **Off** button.
- **To change a multi-value setting** (e.g. Sharpness): Select a value from the drop-down menu.
- **To change a numeric setting** (e.g. Brightness): Click the corresponding + or - button, or select a value from the drop-down menu.
- **To perform a command** (e.g. Auto Image): Click the corresponding Execute button.

Network Settings Page (administrators only)

This page lets you view and change the projector's network settings. Consult with your network administrator before making any changes on this page; incorrect network configuration of the projector may cause problems on your network.

Projector Name: The name of the projector shown in the projector's web pages.

IP Address: These settings control the projector's network configuration. Enter the appropriate settings required for your specific network.

Advanced Network Settings: Click this link to show advanced settings:

802.1x Authentication: If your network requires 802.1x authentication, enter the user name and password that the projector should use, and select the authentication type.

SNMP: If your network uses SNMP, enter necessary SNMP information here.

Command and Control Pass-Through: This setting allows you to send and receive projector commands over the network. For command codes, see the Appendix or visit the InFocus website at: **www.infocus.com/support**.

Event Notifications Page (administrators only)

This page lets you configure the projector to automatically send email when specific events occur.

E-Mail Settings tab: In the Account Used... section, enter the information needed for your projector to connect to an email sending (SMTP) server. Then in the Recipient E-Mail Addresses section, enter the email addresses of people who will receive emails, and for each address, select whether that address receives reminders and/or warnings and errors (enter only one address per line). After you have completed this page, click Send Test to make sure that email is correctly set up.

Reminders tab: Select which types of reminders to send. For most reminders, you can adjust the frequency or date/duration associated with the reminder.

Warnings & Errors tab: Select which warnings and errors to send.

Date/Time Settings Page (administrators only)

This page lets you configure the projector to read the time and date from an SNTP server on your network. **NOTE:** The projector does not have a built-in clock. If the projector is unable to access the SNTP server, or no SNTP server is defined, functions that rely on the time and date may not work correctly.

Current Date and Time: Shows the current date and time read from the SNTP server.

Synchronize the system clock...: Select how often the projector should check the SNTP server to get the time and date. Between checks, the projector will keep track of the amount of time elapsed, allowing it to maintain the correct time and date.

SNTP Server: The address of the time and date server on your network.

Time Zone: The projector's time zone (if you are in a different time zone from the projector, make sure this is the time zone of the region where the projector is located).

Set Now: Click this to immediately set the time and date based on the above information.

Daylight Savings Settings: Click this link to show daylight savings settings:

Start: Select when daylight savings starts.

End: Select when daylight savings ends.

Automatically adjust...: Check this to have the projector automatically update time and date when daylight savings starts and ends.

Scheduled Tasks Page (administrators only)

This page lets you configure the projector to perform tasks automatically on specific days and times. You can set up a maximum of three different scheduled tasks; each tab corresponds to a task. Each scheduled task can perform different commands on different days and times. Each tab contains the following items:

On/Off: Select whether or not this scheduled task will run on the days and times shown.

Description: Explanation of what the task does.

Run Every: Select the days of the week when the scheduled task should run.

At Time(s): Select the times of day when the scheduled task should run (the task will run at the indicated times on every one of the days checked above).

Command Sequence and Available Commands: The Command Sequence list on the left shows commands currently performed by the scheduled task (each task can include up to 20 commands). The Available Commands list on the right shows all commands that can be added to a scheduled task.

<< Add: Adds the command selected in the Available Commands list to the Command Sequence list.

>> Remove: Removes the command selected in the Command Sequence list.

Move Up: Moves up the command selected in the Command Sequence list.

Move Down: Moves down the command selected in the Command Sequence box list.

Clear All: Erases all commands in the Command Sequence list.

Custom: Click this link to show custom command entry options. With custom commands, you can perform additional commands not shown in the Available Commands list. The RS-232 command codes are available in the Appendix and on our website at www.infocus.com/support. **NOTE:** Custom commands you enter here should be in write format (do not include '?'), and should use '<' and '>' instead of '(' and ')'. Example: to turn on the ceiling mount setting, use the custom command <CEL1>.

User Access and Security Page (administrators only)

This page lets you configure security options for the projector, including log in passwords and projector access restrictions.

Web Access - Administrator tab: Select whether or not Administrators must enter a password to log into the projector's web pages. If a password is required, click create or change password to update the administrator password.

Web Access - Basic User tab: Select whether or not Basic Users must enter a password to log into the projector's web pages. If a password is required, click create or change password to update the basic user password.

Projector PIN tab: Allows you to turn projector PIN protection on or off, or change the PIN. When PIN protection is on, the current PIN must be entered when the projector is powered on, otherwise the projector will not operate. **NOTE:** PIN protection only applies to projector operation via the projector's keypad and remote control; it does not affect the projector's web pages.

System Log Page (administrators only)

This page shows a log of the 100 most recent projector events.

Erase Log...: Click this to erase all events in the log.

Network Utilities Page (administrators only)

This page lets you perform various network-related projector tasks.

Save and Load Projector Configuration: These functions save and load all network-related projector settings into/from a file stored on your computer. This lets you quickly 'clone' network settings from one projector to other projectors.

Upgrade Projector Network Firmware: Upgrades the firmware for the projector's network and LitePort features (this firmware is separate from the regular projector firmware).

Restart Projector Network Subsystem: Restarts the projector network subsystem; does not change any projector settings.

Network Subsystem Factory Reset: Returns all network and LitePort settings to default values and then restarts the projector network subsystem.

Troubleshooting Network Functions

- If network status is shown as **Not Connected** in the projector's Network menu, or the projector does not display its IP address, check the cable or the network configuration.
- If your web browser displays **Page Not Found** or a similar error when you try to access the projector's web pages, verify that the projector is connected to the network (select the Network item in the projector's Setup menu and verify that Network Status shows as Connected); if there is no connection refer to the troubleshooting item above for more help.
- Make sure the Network item in the Always-On Functions submenu in the Setup menu is set to Yes (if it is set to No, the projector web pages will only be available when the projector is powered on).
- If scheduled tasks are not performed, check if the SNTP is set up correctly and is online. Also check if the Command sequence is correct.
- If automatic emails are not sent, check if SMTP is set up correctly and is online.

To manually restart the projector network subsystem: Use the projector's remote control or keypad to select the Network item in the projector's Setup menu. Then scroll down and select either Restart Network (to restart the network subsystem without changing any settings), or Network Factory Reset (to return all network settings back to default values, and then restart the network subsystem). **If the manual restart procedure does not work:** To force the network subsystem to restart, disconnect the projector from AC power, wait 10 seconds, then reconnect AC power.

Using LitePort

LitePort displays a slide show of JPEG images stored on a USB flash drive connected to the projector. This feature eliminates the need for a computer source and can be integrated with common wall plates and conference room input/output panels.

Image File Types

LitePort displays image files in JPEG format only (file extensions .JPEG and .JPG). Other file types including PDF, BMP, TIFF, PNG, GIF, etc. are ignored.

Viewing a Slide Show

To view your pictures as a slide show, follow these steps:

- 1 Connect a USB flash drive to your computer and copy JPEG files from your computer to the USB flash drive.
- 2 Turn on your projector if needed.
- 3 Remove the USB flash drive from your computer and plug it into the LitePort connector on the rear of the projector.
- 4 The projector will start a slide show of the images found (if you see image thumbnails instead, see To Start the Slide Show section below).
- 5 To go to the next image in the slide show, press the Down or Right arrow button on the projector keypad or remote. To go to the previous image, press the Up or Left arrow button.

Controlling LitePort

When you plug a USB flash drive into the projector's LitePort connector, the projector will scan the drive and then either start a slide show or show image thumbnails.

To stop the slide show and view thumbnails: Press the **Select** button during the slide show. In Thumbnails view, the name of the current folder, the current image number, and the total number of images in that folder are shown at the bottom of the screen. While viewing thumbnails, press the arrow

buttons to scroll through the thumbnails, or press **Select** when an image is highlighted to start the slide show, or press **Select** when a folder is highlighted to open that folder.

To start the slide show: While viewing thumbnails, press the arrow buttons to highlight a thumbnail, then press the **Select** button to start the slide show at the highlighted image.

To change the image during the slide show: Press the Down or Right button to go to the next image, or press the Up or Left arrow button to go to the previous image (the slide show may also advance automatically depending on the value of the Next Slide setting; see the LitePort Menu section below for details).

To change to a different folder: While viewing thumbnails, press the arrow buttons to highlight the desired folder icon, then press the **Select** button (to go to the higher-level folder, select the folder icon labeled "Up").

To change LitePort settings: Press the **Menu** button during the slide show, or while viewing thumbnails (see the LitePort Menu section below for details).

Using the LitePort Menu

To show the LitePort menu, press the **Menu** button on the keypad or remote during the slide show, or while viewing thumbnails. To highlight a menu item, press the arrow buttons. Then to do the action or change the setting, press **Select**. To remove the menu, press the **Menu** button again.

Rotate Picture: Rotates the current image by 90 degrees clockwise (rotation is temporary; the image returns to its original orientation when the USB flash drive is removed from the projector or when the projector is turned off).

Stop/Start Slideshow: Stops the slide show, or starts it at the selected thumbnail (when the menu is not visible, you can also stop or start the slide show by pressing the **Select** button).

Go to Projector Main Menu: Removes the LitePort menu and displays the projector's main menu, where you can adjust the picture or change other projector settings.

(For remaining items below, highlight the setting, then press Select one or more times to change the setting value.)

Auto Start: Select On to have the player start the slide show when the USB flash drive is first connected. Select Off to have the player display thumbnails when the USB flash drive is first connected.

Show All Folders: Select On to have the slide show display all images in all folders. Select Off to have the slide show display images only from the current folder.

Fill Screen: Select On to have the slide show expand small images to fill the screen. Select Off to have the slide show display small images at their original size.

Next Slide: Select Manual to disable automatic slide advance in the slide show. Select other values to make the slide show advance to the next image automatically (regardless of this setting, manual advance is always available by pressing the arrow buttons).

Effect: Select Off to have no transition effect when changing between images during the slideshow. Select Random to use a different random effect for each transition. Select other values to use a specific effect.

Show Info: Select On to show the name of the current file and folder, the current image number, and the total number of images in the slide show at the bottom of the screen. Select Off to hide this information.

Displaying PowerPoint Slides

Follow the steps below to display PowerPoint slides using LitePort (these instructions apply to PowerPoint 2007 in Windows; for other presentation programs refer to the program's instructions or help file for the steps needed to save a presentation as separate JPEG files):

- 1 Connect the USB flash drive to your computer.
- 2 Open your PowerPoint document.
- 3 This step is optional but improves image quality: Click the **Design** tab near the top of the PowerPoint document window, then click **Page Setup**.

Click the **Slides sized for** drop-down menu and select Custom. Change both Width and Height to double their previous values, then click **OK**.

- 4 Click the Office button in the upper left corner of the PowerPoint document window.
- 5 Point to **Save As**, then click **Other Formats**.
- 6 In the Save As dialog box, click the **Save as type** drop-down menu. Scroll through the menu and select JPEG File Interchange Format.
- 7 Make sure the contents of your USB flash drive are visible in the Save As dialog box before you continue - to view your USB flash drive in the Save As dialog box, first click My Computer, then double-click the USB flash drive's icon (make sure you do both of these in the Save As dialog box, not on your computer's desktop).
- 8 Click **Save**. PowerPoint will ask if you want to export every slide or only the current slide; click **Every Slide**. PowerPoint will save each slide in your presentation as a separate JPEG file. These files are saved in a new folder that has the same name as the original document.
- 9 Remove the USB flash drive from your computer and plug it into the projector's **LitePort** connector.
- 10 On the projector, navigate to the folder created in step 8 and then start the slide show (for instructions on navigating and controlling the slide show, see the Controlling LitePort section above).

NOTE: PowerPoint embedded videos, transition effects, and animations are not included when saving as JPEG. However, you can select a LitePort slideshow transition effect by changing the Effect in the LitePort menu.

Troubleshooting LitePort

- If images load slowly: Make sure you are using a newer USB 2.0-compatible (high speed) USB flash drive. Larger image file sizes may also slow down the player; to reduce file size, use an image editing program on your computer to resize images smaller; for the best balance between image quality and speed, resize images to be 1024 pixels wide.
- If no images are found, or some images are not shown, or you only see folder thumbnails but no images: Make sure that images are JPEG file type (file extensions .JPEG and .JPG); other file types are not supported and will be ignored.
- If you see a blank screen, or a logo, or the wrong input source (computer, video, etc.) instead of your images: Keep pressing the Source button on the keypad or remote until the LitePort message is displayed (if you still don't see any images, make sure the USB flash drive is correctly and completely plugged into the projector's LitePort connector).
- If nothing happens when you connect your USB flash drive, and you cannot select the LitePort input source as described above: Check the format of your USB storage device. LitePort only supports USB storage devices formatted as FAT32. Devices formatted as NTFS, and non-storage devices (such as cameras) are not supported.
- If images saved by PowerPoint are low quality: Make sure to do step 3 when following the steps in the Displaying PowerPoint Slides section above.

Maintenance

Cleaning the lens

- 1 Apply a non-abrasive camera lens cleaner to a soft, dry cloth.
 - Avoid using an excessive amount of cleaner, and don't apply the cleaner directly to the lens. Abrasive cleaners, solvents or other harsh chemicals might scratch the lens.
- 2 Lightly wipe the cleaning cloth over the lens in a circular motion.

WARNINGS:

- Turn the projector off and unplug power cord before cleaning any part of the projector.
- Do not open any cover on the projector, except the lamp cover.
- Do not attempt to service this product yourself as opening and removing covers may expose you to dangerous voltage and other hazards. Refer all servicing to qualified service personnel.

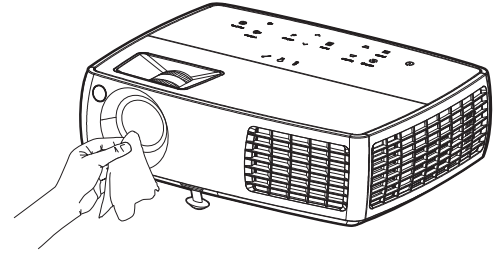

Replacing the projection lamp

The Lamp Hours timer in the Projector Info menu counts the number of hours the lamp has been in use. Twenty hours before the lamp life expires, the message “Replace lamp” appears on the screen at startup.

- **NOTE:** Be sure to use the InFocus lamp module designed for this projector. You can order new lamps from www.infocus.com (in select areas), your retailer or your dealer. **Only genuine InFocus lamps are tested for use in this projector.** Use of non InFocus lamps may cause electrical shock and fire, and may void the projector warranty. InFocus is not liable for the performance, safety or certification of any other lamps.

WARNINGS:

- The projector uses a high-pressure mercury glass lamp. The lamp may fail prematurely, or it may rupture with a popping sound if jolted, scratched, or handled while hot. The risk of lamp failure or rupture also increases as the lamp age increases; please replace the lamp when you see the “Replace Lamp” message.
- To avoid burns, allow the projector to cool for at least 60 minutes before you replace the lamp.
- Unplug the power cord before replacing the lamp.
- Do not drop the lamp module. The glass may shatter and cause injury.
- Do not touch the glass surface of the lamp module. Fingerprints can obscure projection sharpness and may cause the glass to shatter.
- Be extremely careful when removing the lamp housing. In the unlikely event that the lamp ruptures, small glass fragments may be generated. The lamp module is designed to contain most of these fragments, but use caution when removing it.
- Before replacing a ruptured lamp, clean the lamp compartment and dispose of cleaning materials. Wash hands after lamp replacement.
- When replacing the lamp while the projector is ceiling-mounted, wear protective eyewear to prevent eye injury.
- Hg – Lamp contains mercury. Manage in accordance with local disposal laws. See www.lamprecycle.org.

- 1 Turn off the projector and unplug the power cord.
- 2 Wait 60 minutes to allow the projector to cool thoroughly.
- 3 Remove the lamp door by: (a) removing the screw (labeled “1”) on the side of the lamp door, (b) turning the lamp cover knob (labeled “2”) counterclockwise to push up the lamp cover, and (c) lifting the door off.

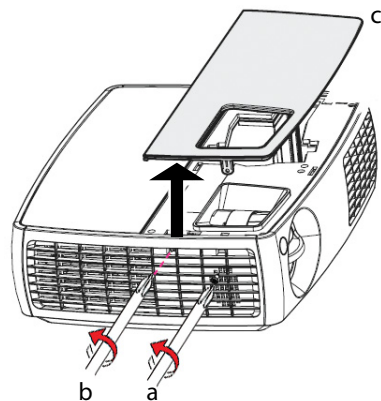
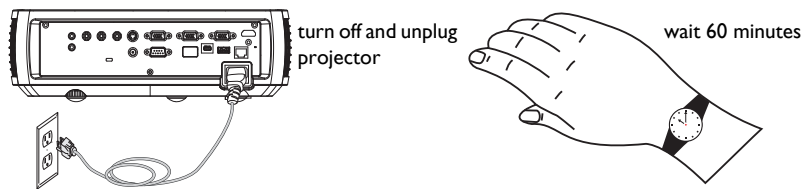

- 4 Loosen the captive screws that attach the lamp housing to the projector. Carefully remove the lamp housing. Dispose of the lamp in an environmentally proper manner.
- 5 Install the new lamp module and tighten the screws.
- 6 Replace the lamp door by sliding it into place.
- 7 Plug in the power cord and press the **Power** button to turn the projector back on.
- 8 To reset the lamp hour timer, navigate to the **Status and Service** menu and select **Reset Lamp Hours** (on page 37).

loosen screw

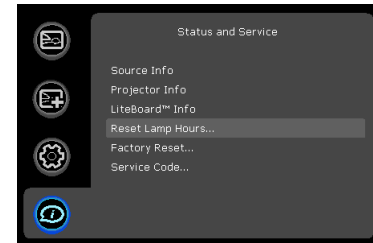
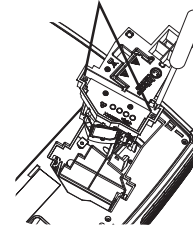

Using the security lock

The projector has a security lock for use with a Cable Lock System. Refer to the information that came with the lock for instructions on how to use it.

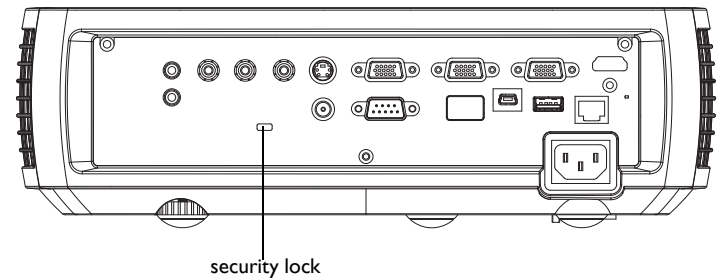

INDEX

Numerics

- 16x9 vs 4x3 11
- 5 volt DC output 5

A

- AC Power On 34
- Advanced menu 33
- Apply Preset 32
- Aspect Ratio 11, 32, 34
- Audio In Computer connector 8
- Audio In connector 12
- Audio Out connector 27
- Auto Image 34
- Auto Off Time 34
- Auto Source 35

B

- Blank Key 34
- Blank Screen 34
- Brightness 32
- BrilliantColor 33

C

- Cable box 12
- Ceiling Mount 35
- Cleaning the lens 45
- Closed Captions 35
- Color Space 33
- Color Temperature 33
- Computer In connector 7
- Connecting
 - Computer 7
 - External speakers 27
 - Video device 12
- Connector panel 5
- Contacting InFocus 25
- Contrast 32
- Custom Key 29, 34
- Customer Service contact information 25
- Customizing the projector 30

D

- DVDs 12

F

- Factory Reset 37
- Focus 10
- Force wide 33
- Freeze Screen 34

G

- Gamma 33

H

- HDMI 1.3 connection 12
- HDTV 12
- Horizontal 33

I

- Image
 - Optimization 29
 - Size 6

K

- Key Click 34
- Keypad buttons 28
- Keystone 32
- Keystone, adjusting 10

L

- Lamp hours, resetting 47
- Lamp Low Power 34
- Language 34
- Laptop video port activation 9
- LEDs 18
- Leveling foot 10
- LitePort 5, 8, 27, 41, 42, 43, 44

M

- Maintaining the projector 45
- Menu button 31
- Menu usage 31
- Monitor Out connector 8
- Mute 34

N

- Network 8

O

- Optimizing images 29

Optimizing video 30

Overscan 33, 34

P

Phase 33

Picture menu 32

Power connector 7

Power cord 7

Power Sounds 34

Power-up Source 35

Presentation features 29

Projection distance 6

Projector

 Connecting computers 7

 Connecting video devices 12

 Connector panel 5

 Customization 30

 Image Size 6

 Keypad buttons 28

 Maintenance 45

 Menus 31

 Offset 6

 Positioning 6

 Registering 4

 Setting up 6

 Shutting down 18

 Status indicator panel 18

 Troubleshooting problems 18

Projector Info 34

R

Rear 35

Registering your projector 4

Remote control 26

Reset 37

Resetting the projector 37

RS-232 5

S

Scheduled Tasks Page 40

Screen Aspect 11

Screen Save 18, 34

Search Screen 35

Security lock 47

Service 37

Service Code 37

Sharpness 32

Shutting down the projector 18

Source 34

Source Info 34

Speakers, Connecting external 27

Status indicator panel 18

S-video connector 12

Sync Threshold 33

T

Tint 32

Tracking 33

Troubleshooting 18

Troubleshooting Network Functions 41

TV tuner 12

U

USB 5, 8

User Access and Security Page 41

V

Vertical 33

Video optimizing 30

Video Standard 35

Viewing a Slide Show 42

Volume button 27

W

Warranty 25

White Peaking 33

Z

Zoom 10